



Level



Pressure



Flow



Temperature



Liquid
Analysis



Registration



Systems
Components



Services



Solutions

Description of Device Functions

Proline Promag 55 PROFIBUS DP/PA

Electromagnetic Flow Measuring System

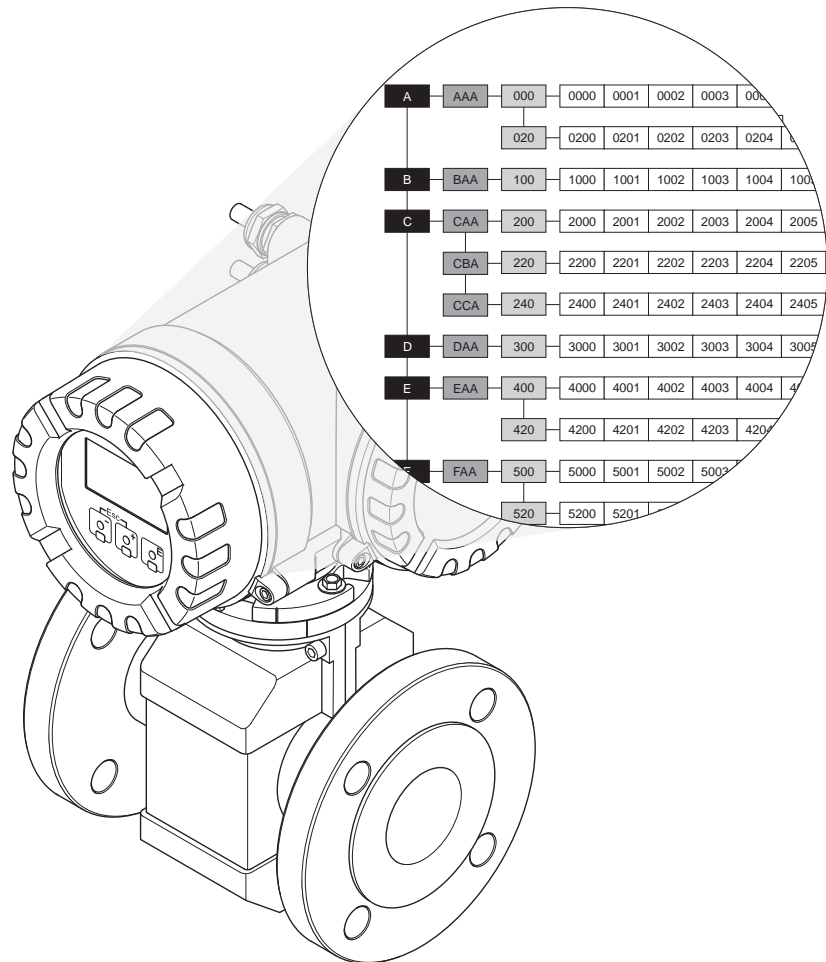

BA00125D/06/EN/13.11
71129655

Valid as of version:
PROFIBUS DP: V 3.06.XX (Device software)
PROFIBUS PA: V 3.06.XX (Device software)

Endress+Hauser

People for Process Automation

Table of contents

1	Using the manual	5
1.1	Using the table of contents to locate a function description	5
1.2	Using the graphic of the function matrix to locate a function description	5
1.3	Using the index of the function matrix to locate a function description	5
2	Function matrix	6
2.1	General layout of the function matrix	6
2.1.1	Blocks (A, B, C, etc.)	6
2.1.2	Groups (AAA, AEA, CAA, etc.)	6
2.1.3	Function groups (000, 020, 060, etc.)	6
2.1.4	Functions (0000, 0001, 0002, etc.)	6
2.1.5	Codes identifying cells	7
2.2	Max. number of writes	8
2.3	Display lines on the local display	8
2.4	Available blocks, groups, etc.	8
2.5	Function matrix	9
3	Block MEASURED VARIABLES	10
3.1	Group MEASURING VALUES	11
3.1.1	Function group MAIN VALUES	11
3.2	Group SYSTEM UNITS	12
3.2.1	Function group CONFIGURATION	12
3.2.2	Function group ADDITIONAL CONFIGURATION	14
3.3	Group SPECIAL UNITS	15
3.3.1	Function group DENSITY PARAMETER	15
4	Block QUICK SETUP	16
4.1	Quick Setup "Commissioning"	17
4.2	Quick Setup "Communication"	18
4.3	Data backup/transmission	19
5	Block USER INTERFACE	20
5.1	Group CONTROL	21
5.1.1	Function group BASIC CONFIGURATION	21
5.1.2	Function group UNLOCKING/LOCKING	23
5.1.3	Function group OPERATION	24
5.2	Group MAIN LINE	25
5.2.1	Function group CONFIGURATION	25
5.2.2	Function group MULTIPLEX	27
5.3	Group ADDITION LINE	29
5.3.1	Function group CONFIGURATION	29
5.3.2	Function group MULTIPLEX	31
5.4	Group INFORMATION LINE	33
5.4.1	Function group CONFIGURATION	33
5.4.2	Function group MULTIPLEX	35
6	Block OUTPUTS	37
6.1	Group CURRENT OUTPUT 1	38
6.1.1	Function group CONFIGURATION	38
6.1.2	Function group OPERATION	47
6.1.3	Function group INFORMATION	48
6.2	Group PULSE/FREQUENCY OUTPUT 1	49
6.2.1	Function group CONFIGURATION	49
6.2.2	Function group OPERATION	70
6.2.3	Function group INFORMATION	73
6.3	Group RELAY OUTPUT (1 to 2)	74
6.3.1	Function group CONFIGURATION	74
6.3.2	Function group OPERATION	78
6.3.3	Function group INFORMATION	80

6.3.4	Information on the response of the relay output	81
6.3.5	Switching response of the relay output	82
7	Block INPUTS	84
7.1	Group STATUS INPUT	85
7.1.1	Function group CONFIGURATION	85
7.1.2	Function group OPERATION	86
7.1.3	Function group INFORMATION	87
8	Block BASIC FUNCTION	88
8.1	Group PROFIBUS DP/PA	89
8.1.1	Function group CONFIGURATION	89
8.1.2	Function group FUNCTION BLOCKS	90
8.1.3	Function group TOTALIZER	92
8.1.4	Function group OPERATION	95
8.1.5	Function group INFORMATION	96
8.2	Group PROCESS PARAMETER	97
8.2.1	Function group CONFIGURATION	97
8.2.2	Function group EPD PARAMETER	100
8.2.3	Function group ECC PARAMETER	102
8.2.4	Function group ADJUSTMENT	104
8.3	Group SYSTEM PARAMETER	105
8.3.1	Function group CONFIGURATION	105
8.4	Group SENSOR DATA	107
8.4.1	Function group CONFIGURATION	107
8.4.2	Function group OPERATION	109
9	Block SPECIAL FUNCTION	111
9.1	Group ADVANCED DIAGNOSTICS	112
9.1.1	Function group CONFIGURATION	114
9.1.2	Function group ACQUISITION	115
9.1.3	Function group CONFIG. COATING	116
9.1.4	Function group COATING E1	117
9.1.5	Function group COATING E2	118
9.1.6	Function group ELECTRODE POT. 1	119
9.1.7	Function group ELECTRODE POT. 2	120
9.1.8	Function group VOLUME FLOW	121
9.1.9	Function group NOISE VALUE	122
9.2	Group SOLID CONTENT FLOW	124
9.2.1	Function group CONFIGURATION	124
10	Block SUPERVISION	125
10.1	Group SYSTEM	126
10.1.1	Function group CONFIGURATION	126
10.1.2	Function group OPERATION	127
10.2	Group VERSION INFO	129
10.2.1	Function group DEVICE	129
10.2.2	Function group SENSOR	129
10.2.3	Function group AMPLIFIER	129
10.2.4	Function group F-CHIP	130
10.2.5	Function group I/O MODULE	131
11	Factory settings	132
11.1	SI units (not for USA and Canada)	132
11.2	US units (only for USA and Canada)	133
12	Index function matrix	135
13	Index of key words	139

1 Using the manual

There are various ways of locating the description of a function of your choice in the manual:

1.1 Using the table of contents to locate a function description

The designations of all the cells in the function matrix are listed in the table of contents. You can use these unambiguous designations (such as USER INTERFACE, INPUTS, OUTPUTS, etc.) to choose whichever functions are applicable to a particular set of conditions. The page references show you exactly where to find the detailed descriptions of the functions in question. The table of contents can be found on Page 3.

1.2 Using the graphic of the function matrix to locate a function description

This step-by-step, top-down approach starts with the blocks, the highest level, and works down through the matrix to the description of the function you need:

1. All available blocks, and their corresponding groups, are illustrated on Page 9. Select the block (or the group within the block) which you need for your application and use the page reference to locate the information corresponding to the next level.
2. The page in question contains a graphic showing of the block with all its subordinate groups, function groups and functions. Select the function which you need for your application and use the page reference to locate the detailed function description.

1.3 Using the index of the function matrix to locate a function description

Each "cell" in the function matrix (blocks, groups, function groups, functions) has a unique identifier in the form of a code consisting of one or three letters or a three- or four-digit number. The code identifying a selected "cell" appears at the top right on the local display.

Example:

```
SUM                               3040
+366.0000 0 kg
```

```
USER INTERFACE  CAA
CONTROL
MAIN LINE
ADDITION LINE
```

A0004750-EN

The function matrix index lists the codes for all the available "cells" in alphabetic and consecutive order, complete with the page references for the corresponding functions. The index to the function matrix is on Page 135.

2 Function matrix

2.1 General layout of the function matrix

The function matrix consists of four levels:

Blocks -> Groups -> Function groups -> Functions

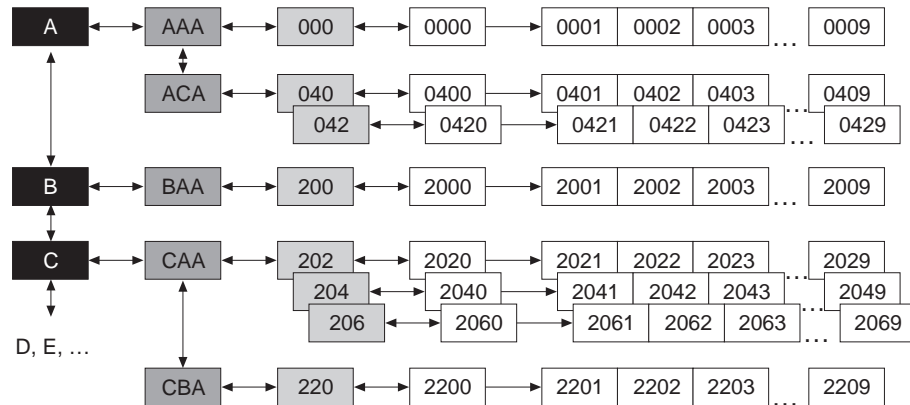

A0000961

2.1.1 Blocks (A, B, C, etc.)

The blocks are the highest-level grouping of the operation options for the device. The blocks include, for example: MEASURED VARIABLES, QUICK SETUP, USER INTERFACE, TOTALIZER, etc.

2.1.2 Groups (AAA, AEA, CAA, etc.)

A block consists of one or more groups. Each group represents a more detailed selection of the operation options in the higher-order block. The groups in the USER INTERFACE block, for example, include: CONTROL, MAIN LINE, ADDITION LINE, etc.

2.1.3 Function groups (000, 020, 060, etc.)

A group consists of one or more function groups. Each function group represents a more detailed selection of the operation options in the higher-order group. The function groups available in the CONTROL group are for example: BASIC CONFIGURATION, UNLOCKING/LOCKING, OPERATION, etc.

2.1.4 Functions (0000, 0001, 0002, etc.)

Each function group consists of one or more functions. The functions are used to operate and parameterize the device. Numerical values can be entered or parameters selected and saved. The functions in the BASIC CONFIGURATION function group include LANGUAGE, DISPLAY DAMPING, CONTRAST LCD, etc.

The procedure for changing the language of the user interface, for example, is as follows:

1. Select the block USER INTERFACE.
2. Select the group CONTROL.
3. Select the function group BASIC CONFIGURATION.
4. Select the function LANGUAGE
(here you can set the language required).

2.1.5 Codes identifying cells

Each cell (block, group, function group and function) in the function matrix has an individual, unique code.

Blocks:

The code is a letter (A, B, C, etc.)

Groups:

The code consists of three letters (AAA, ABA, BAA, etc.).

The first letter matches the block code (i.e. each group in block A has a code starting with an A _ _; the codes of the groups in block B start with a B _ _, etc.). The other two letters are for identifying the group within the respective block.

Function groups:

The code consists of three digits (000, 001, 100, etc.).

Functions:

The code consists of four digits (0000, 0001, 0201, etc.).

The first three digits are the same as the code for the function group.

The last digit in the code is a counter for the functions in the function group, incrementing from 0 to 9 (e.g. function 0005 is the sixth function in group 000).

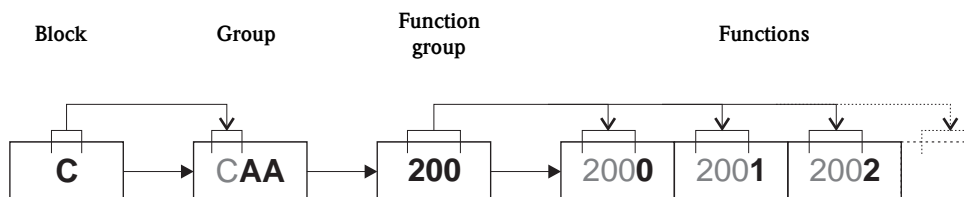

A0001251

2.2 Max. number of writes

If a nonvolatile device parameter is modified via the cyclic or acyclic data transmission, this change is saved in the EEPROM of the measuring device

The number of writes to the EEPROM is technically restricted to a maximum of 1 million. Attention must be paid to this limit since, if exceeded, it results in data loss and measuring device failure.

For this reason, avoid constantly writing nonvolatile device parameters via the PROFIBUS!

2.3 Display lines on the local display

The local display is split into various display lines.

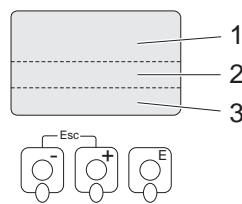

A0001253

Abb. 1: Local display

- 1 Main line
- 2 Additional line
- 3 Information line

The values are assigned to the individual lines in the USER INTERFACE block, see Page 25 ff.

2.4 Available blocks, groups, etc.

Type code of device	Available inputs and outputs							Available blocks, groups, etc.										
	PROFIBUS PA	PROFIBUS DP	Current output	Pulse/Frequency output	Relay output 1	Relay output 2	Status input	MEASURED VARIABLES	QUICK SETUP	USER INTERFACE			OUTPUTS			BASIC FUNCTION	SPECIAL FUNCTION	SUPERVISION
55***_*****H	X	-	-	-	-	-	-	X	X	X	-	-	-	-	-	X	-	X
55***_*****J	-	X	-	-	-	-	-	X	X	X	-	-	-	-	-	X	-	X
55***_*****P	-	X	X	X	-	-	X	X	X	X	X	-	-	X	X	X	-	X
55***_*****V	-	X	-	-	X	X	X	X	X	X	-	-	X	X	X	X	X	X

2.5 Function matrix

BLOCKS		GROUPS		FUNCTION GROUPS
MEASURED VARIABLES A (see P. 10)	→	MEASURING VALUES AAA	→	see P. 11
		SYSTEM UNITS ACA	→	see P. 12
		SPECIAL UNITS AEA	→	see P. 15
↓				
QUICK SETUP B (see P. 16)	→	Commissioning and application setups	→	see P. 16
↓				
USER INTERFACE C (see P. 20)	→	CONTROL CAA	→	see P. 21
		MAIN LINE CGA	→	see P. 25
		ADDITION LINE CEA	→	see P. 29
		INFORMATION LINE CGA	→	see P. 33
↓				
OUTPUTS E (see P. 37)	→	CURRENT OUTPUT 1 EAA	→	see P. 38
		PULSE/FREQ. OUTPUT 1 ECA	→	see P. 49
		RELAY OUTPUT 1 EGA	→	see P. 74
		RELAY OUTPUT 2 EGB	→	see P. 74
↓				
INPUTS F (see P. 84)	→	STATUS INPUT FAA	→	see P. 85
↓				
BASIC FUNCTION G (see P. 88)	→	PROFIBUS DP/PROFIBUS PA GBA/GCA	→	see P. 89
		PROCESS PARAMETER GIA	→	see P. 97
		SYSTEM PARAMETER GLA	→	see P. 105
		SENSOR DATA GNA	→	see P. 107
↓				
SPECIAL FUNCTION H (see P. 111)	→	ADVANCED DIAGNOSTICS HEA	→	see P. 112
		SOLID CONTENT FLOW HFA	→	see P. 124
↓				
SUPERVISION J (see P. 125)	→	SYSTEM JAA	→	see P. 126
		VERSION INFO JCA	→	see P. 129

3 Block MEASURED VARIABLES

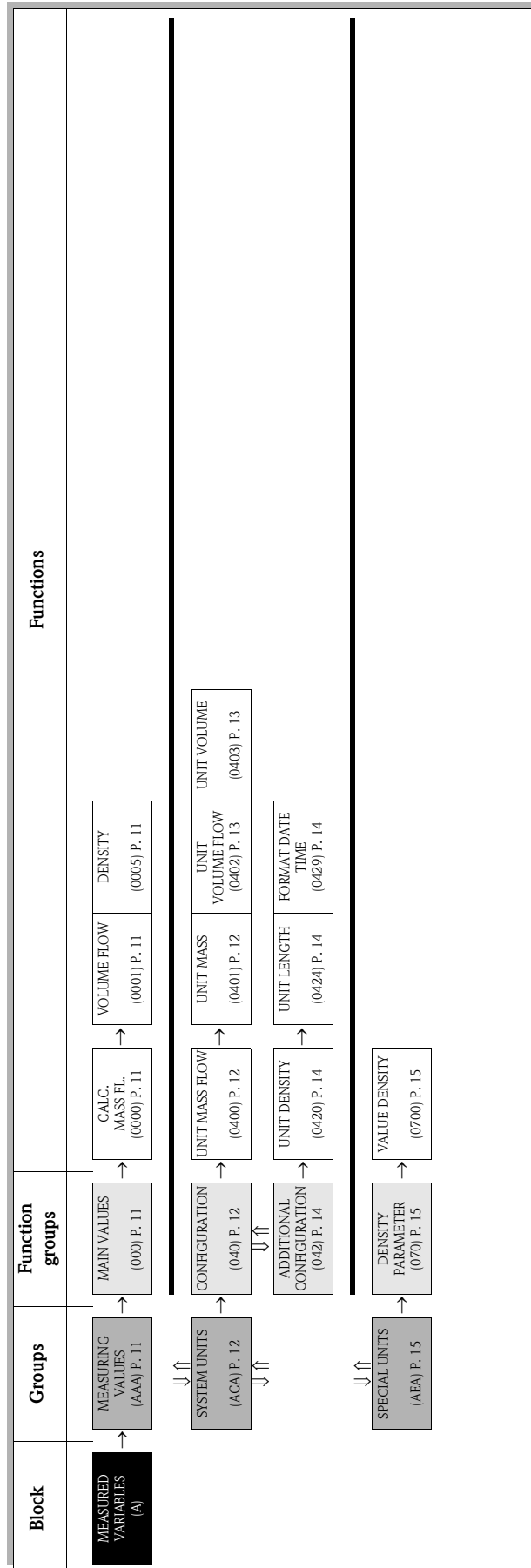

3.1 Group MEASURING VALUES

3.1.1 Function group MAIN VALUES



MEASURED VARIAB. A → MEASURING VALUES AAA → MAIN VALUES 000

Function description MEASURED VARIABLES → MEASURING VALUES → MAIN VALUES	
<p> Note!</p> <ul style="list-style-type: none"> ■ The engineering units of all the measured variables shown here can be set in the SYSTEM UNITS group. ■ If the fluid in the pipe flows backwards, a negative sign prefixes the flow reading on the display. 	
<p>CALCULATED MASS FLOW (0000)</p>	<p>Use this function to view the calculated mass flow. The mass flow is derived from the measured volume flow and the fixed (or temperature-compensated) density.</p> <p>User interface: 5-digit floating-point number, including unit and sign (e.g. 462.87 kg/h; -731.63 lb/min; etc.)</p>
<p>VOLUME FLOW (0001)</p>	<p>Use this function to view the actual measured volume flow.</p> <p>User interface: 5-digit floating-point number, including unit and sign (e.g. 5.5445 dm³/min; 1.4359 m³/h; -731.63 gal/d; etc.)</p>
<p>DENSITY (0005)</p>	<p>Use this function to view the fixed density, temperature-compensated density or density fed in via the current input.</p> <p>User interface: 5-digit floating-point number, including unit (corresponding to 0.10000 to 6.0000 kg/dm³) e.g. 1.2345 kg/dm³; 993.5 kg/m³; 1.0015 SG_20 °C; etc.</p>

3.2 Group SYSTEM UNITS

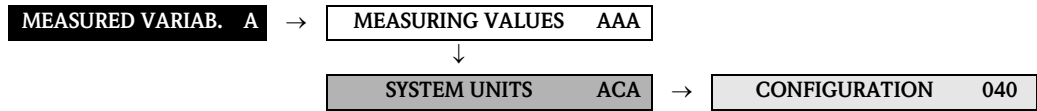
3.2.1 Function group CONFIGURATION



Function description MEASURED VARIABLES → SYSTEM UNITS → CONFIGURATION	
<p>You can select the units for measured variables in this function group.</p> <p> Note! The factory settings for the system units which are described here apply to the local display and may differ from the units which are used to transfer the measured variables to the automation system. However, the SET UNIT TO BUS (6141) function (see P. 95) can be used to set these units to the units currently selected for the local display.</p>	
UNIT MASS FLOW (0400)	<p>Use this function to select the unit for displaying the calculated mass flow (mass/time). The mass flow is derived from the preset (compensated) specific fluid density and the measured volume flow.</p> <p>The unit you select here is also valid for:</p> <ul style="list-style-type: none"> ■ Low flow cutoff <p>Options: Metric: Gram → g/s; g/min; g/h; g/day Kilogram → kg/s; kg/min; kg/h; kg/day Ton → t/s; t/min; t/h; t/day</p> <p>US: Ounce → oz/s; oz/min; oz/h; oz/day Pound → lb/s; lb/min; lb/h; lb/day Ton → ton/s; ton/min; ton/h; ton/day</p> <p>Factory setting: Depends on nominal diameter and country (s. Page 132 ff.).</p>
UNIT MASS (0401)	<p>Use this function to select the unit for displaying the calculated mass. The mass is derived from the preset (compensated) specific fluid density and the measured volume.</p> <p>Options: Metric → g; kg; t US → oz; lb; ton</p> <p>Factory setting: Depends on nominal diameter and country (s. Page 132 ff.).</p> <p> Note! The unit for the totalizers is independent of your choice here. The unit for each totalizer is selected separately for the totalizer in question.</p>

Function description MEASURED VARIABLES → SYSTEM UNITS → CONFIGURATION	
UNIT VOLUME FLOW (0402)	<p>Use this function to select the unit for displaying the volume flow (volume/time).</p> <p>The unit you select here is also valid for:</p> <ul style="list-style-type: none"> ■ Low flow cutoff <p>Options:</p> <p>Metric: Cubic centimeter → cm³/s; cm³/min; cm³/h; cm³/day Cubic decimeter → dm³/s; dm³/min; dm³/h; dm³/day Cubic meter → m³/s; m³/min; m³/h; m³/day Milliliter → ml/s; ml/min; ml/h; ml/day Liter → l/s; l/min; l/h; l/day Hectoliter → hl/s; hl/min; hl/h; hl/day Megaliter → Ml/s; Ml/min; Ml/h; Ml/day</p> <p>US: Cubic centimeter → cc/s; cc/min; cc/h; cc/day Acre foot → af/s; af/min; af/h; af/day Cubic foot → ft³/s; ft³/min; ft³/h; ft³/day Fluid ounce → oz f/s; oz f/min; oz f/h; oz f/day Gallon → gal/s; gal/min; gal/h; gal/day Kilo gallon → Kgal/s; Kgal/min; Kgal/h; Kgal/day Million gallon → Mgal/s; Mgal/min; Mgal/h; Mgal/day Barrel (normal fluids: 31.5 gal/bbl) → bbl/s; bbl/min; bbl/h; bbl/day Barrel (beer: 31.0 gal/bbl) → bbl/s; bbl/min; bbl/h; bbl/day Barrel (petrochemicals: 42.0 gal/bbl) → bbl/s; bbl/min; bbl/h; bbl/day Barrel (filling tanks: 55.0 gal/bbl) → bbl/s; bbl/min; bbl/h; bbl/day</p> <p>Imperial: Gallon → gal/s; gal/min; gal/h; gal/day Mega gallon → Mgal/s; Mgal/min; Mgal/h; Mgal/day Barrel (beer: 36.0 gal/bbl) → bbl/s; bbl/min; bbl/h; bbl/day Barrel (petrochemicals: 34.97 gal/bbl) → bbl/s; bbl/min; bbl/h; bbl/day</p> <p>Factory setting: Depends on nominal diameter and country (s. Page 132 ff.).</p>
UNIT VOLUME (0403)	<p>Use this function to select the unit for displaying the volume.</p> <p>Options:</p> <p>Metric → cm³; dm³; m³; ml; l; hl; Ml Mega</p> <p>US → cc; af; ft³; oz f; gal; Kgal; Mgal; bbl (normal fluids); bbl (beer); bbl (petrochemicals) → bbl (filling tanks)</p> <p>Imperial → gal; Mgal; bbl (beer); bbl (petrochemicals)</p> <p>Factory setting: Depends on nominal diameter and country (s. Page 132 ff.).</p> <p> Note! The unit of the totalizers is independent of your choice here. The unit for each totalizer is selected separately for the totalizer in question.</p>

3.2.2 Function group ADDITIONAL CONFIGURATION

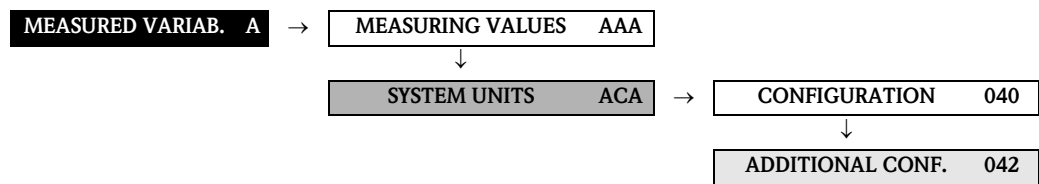



Function description	
MEASURED VARIABLES → SYSTEM UNITS → ADDITIONAL CONFIGURATION	
UNIT DENSITY (0420)	<p>Use this function to select the unit for displaying the fluid density.</p> <p>The unit you select here is also valid for: Fluid density entry</p> <p>Options: Metric → g/cm³; g/cc; kg/dm³; kg/l; kg/m³; SD 4 °C, SD 15 °C, SD 20 °C; SG 4 °C, SG 15 °C, SG 20 °C; g/l</p> <p>US → lb/ft³; lb/gal; lb/bbl (normal fluids); lb/bbl (beer); lb/bbl (petrochemicals); lb/bbl (filling tanks)</p> <p>Imperial → lb/gal; lb/bbl (beer); lb/bbl (petrochemicals)</p> <p>Factory setting: kg/l (SI units: not for USA and Canada) g/cc (US units: only for USA and Canada)</p> <p>SD = Specific Density, SG = Specific Gravity The specific density is the ratio of fluid density to water density (at water temperature = 4, 15, 20 °C).</p>
UNIT LENGTH (0424)	<p>Use this function to select the unit for displaying the length of the nominal diameter.</p> <p>The unit you select here is also valid for: Nominal diameter of sensor (function NOMINAL DIAMETER (6804) on Page 108)</p> <p>Options: MILLIMETER INCH</p> <p>Factory setting: MILLIMETER (SI units: not for USA and Canada) INCH (US units: only for USA and Canada)</p>
FORMAT DATE TIME 0429	<p>Use this function to select the format for the date and the time.</p> <p>The unit you select here is also valid for: Displaying the current calibration date (fct. CALIBRATION DATE (6800) on Page 107)</p> <p>Options: DD.MM.YY 24H MM/DD/YY 12H A/P DD.MM.YY 12H A/P MM/DD/YY 24H</p> <p>Factory setting: DD.MM.YY 24H (SI units) MM/DD/YY 12H A/P (US units)</p>

3.3 Group SPECIAL UNITS

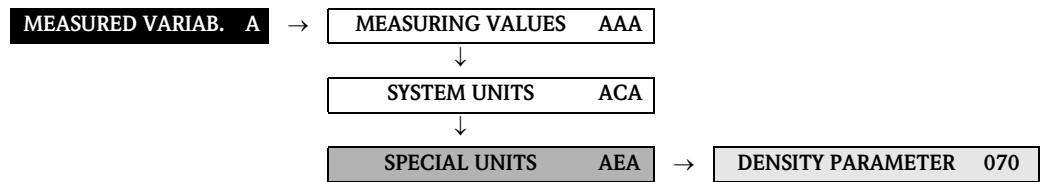

3.3.1 Function group DENSITY PARAMETER

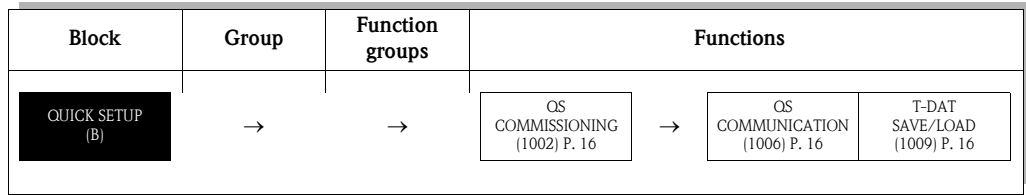

Function description	
MEASURED VARIABLES → SPECIAL UNITS → DENSITY PARAMETER	
<p>Use this function group to calculate a mass flow from a volume flow.</p> <p> Note! It is advisable to enter the density factor at process temperature for calculating the mass flow without compensating for thermal expansion.</p> <p>Example of calculated mass flow without compensation for thermal expansion of the fluid:</p> $\dot{m} = \dot{V} \cdot \rho = 1 \text{ [dm}^3/\text{h}] \cdot 0.900 \text{ [kg/l]} = 0.900 \text{ [kg/h]} \text{ (mass flow at } 20 \text{ }^\circ\text{C)}$ $\dot{m} = \dot{V} \cdot \rho = 1 \text{ [dm}^3/\text{h}] \cdot 0.783 \text{ [kg/l]} = 0.783 \text{ [kg/h]} \text{ (mass flow at } 150 \text{ }^\circ\text{C)}$ <p>\dot{m} = Mass flow [kg/h] \dot{V} = Volume flow = 1 [dm³/h] ρ = Density factor [kg/l], see VALUE DENSITY function (0700)</p>	
<p>VALUE DENSITY (0700)</p>	<p>Use this function to enter a density value preferably at process temperature (or at reference temperature). This density value is used to convert the volume flow to a mass flow.</p> <p>User input: 5-digit floating-point number</p> <p>Factory setting: 1 [unit]</p> <p> Note! The appropriate unit is taken from the function UNIT DENSITY (0420), (see Page 14).</p>

4 Block QUICK SETUP



Function description QUICK SETUP	
QUICK SETUP COMMISSIONING (1002)	<p>Use this function to start the Setup menu for commissioning.</p> <p>Options: YES NO</p> <p>Factory setting: NO</p> <p> Note! You will find a flowchart of the COMMISSIONING Setup menu on Page 17. For more detailed information on Setup menus, please refer to the Operating Instructions Promag 55 PROFIBUS DP/PA.</p>
QUICK SETUP COMMUNICATION (1006)	<p>Use this function to start the Setup menu for communication.</p> <p>Options: NO YES</p> <p>Factory setting: NO</p>
T-DAT SAVE/LOAD (1009)	<p>Use this function to save the parameter settings / configuration of the transmitter in a transmitter DAT (T-DAT), or to load the parameter settings from the T-DAT into the EEPROM (manual security function).</p> <p>Application examples:</p> <ul style="list-style-type: none"> ■ After commissioning, the current measuring point parameters can be saved to the T-DAT as a backup. ■ If the transmitter is replaced for some reason, the data from the T-DAT can be loaded into the new transmitter (EEPROM). <p>Options: CANCEL SAVE (from EEPROM to T-DAT) LOAD (from the T-DAT into EEPROM)</p> <p>Factory setting: CANCEL</p> <p> Note!</p> <ul style="list-style-type: none"> ■ If the target device has an older software version, the message "TRANSM. SW-DAT" is displayed during startup. Then only the SAVE option is available. ■ LOAD This option is only available if <ul style="list-style-type: none"> – the target device has the same software version as, or a more recent software version than, the source device or – if the T-DAT contains valid data that can be retrieved. ■ SAVE This option is always available.

4.1 Quick Setup "Commissioning"

The "Commissioning" Quick Setup menu guides you systematically through all the important device functions that have to be configured for standard operation.

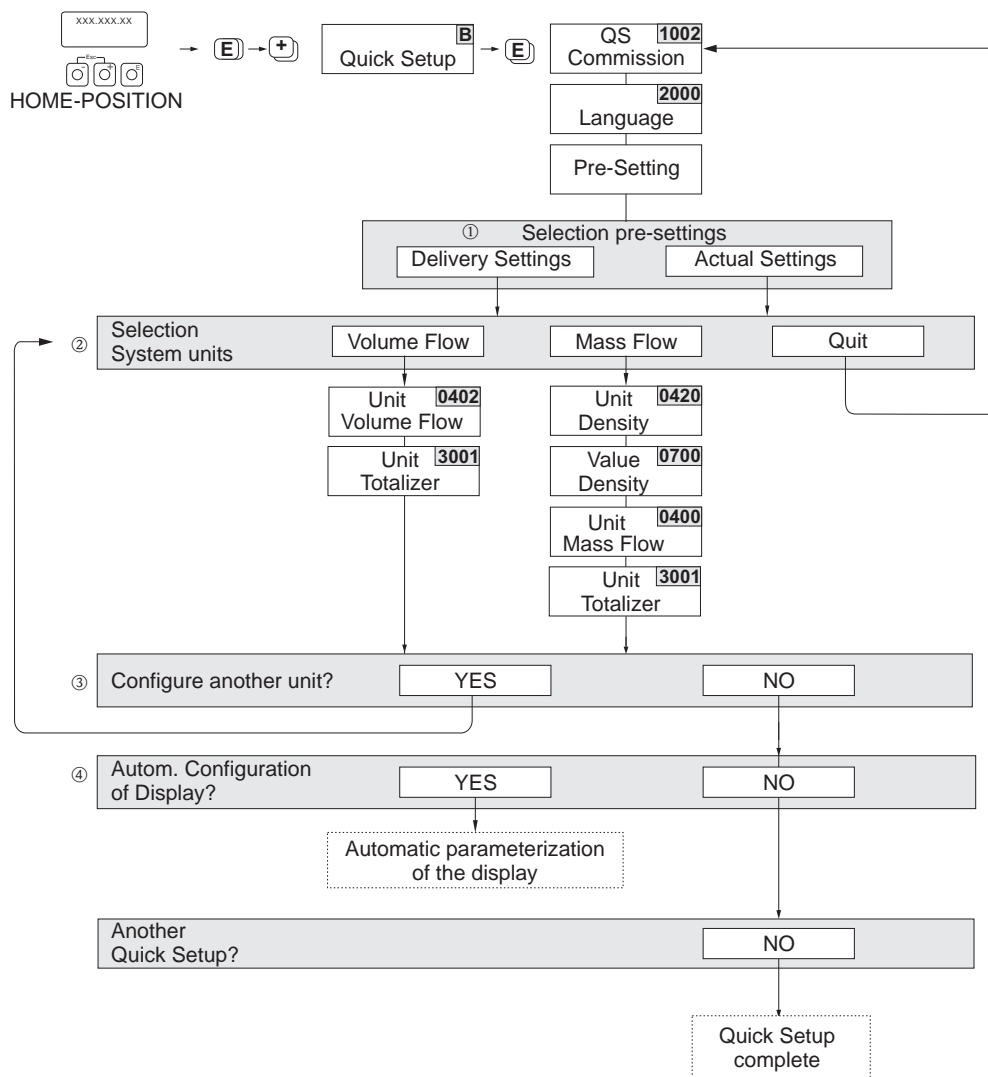

A0005958-en

Note!

- The display returns to the cell SETUP COMMISSIONING (1002) if you press the key combination during parameter interrogation. The stored parameters remain valid.
- The "Commissioning" Quick Setup must be carried out before one of the other Quick Setups explained in these Operating Instructions is run.
- The system units selected via the Quick Setup only apply for displaying on the local display. They do not affect the measured variables (volume flow, mass flow) that are transmitted via PROFIBUS.

- ① The "DELIVERY SETTINGS" option sets every selected unit to the factory setting. The "ACTUAL SETTINGS" accepts the units you configured beforehand.
- ② Only units not yet configured in the current Setup are offered for selection in each cycle. The unit for mass and volume is derived from the corresponding flow unit.
- ③ The "YES" option remains visible until all the units have been configured. "NO" is the only option displayed when no further units are available.
- ④ The "automatic parameterization of the display" option contains the following basic settings/factory settings:

YES	Main line = Volume flow
	Additional line = Totalizer 1
	Information line = Operating/system condition
NO	The existing (selected) settings remain.

4.2 Quick Setup "Communication"

To set up the cyclical data transfer, various arrangements must be made between the PROFIBUS master and the device (slave). These arrangements must be taken into account when configuring different functions. Using the Quick Setup "Communication", these functions can be configured quickly and easily. The different possible parameter settings are explained in greater detail in the following table.

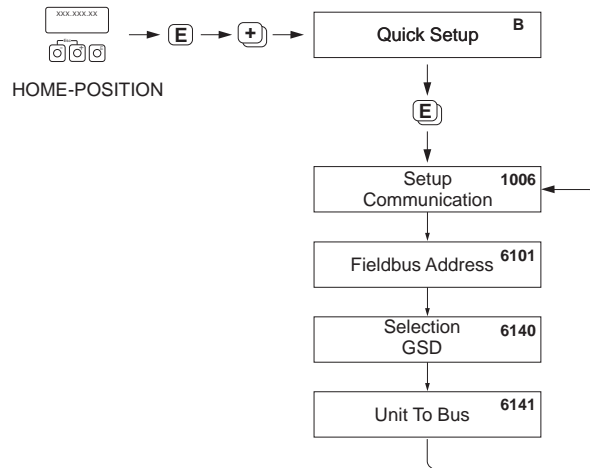

A0002600-EN

Settings for the Communication Setup menu:			
Fct. code	Function name	Suggested settings	Description
Call up through the function matrix:			
B	QUICK SETUP	QUICK SETUP COMMUNICATION	see P. 18
1006	QUICK SETUP COMMUNICATION	YES	see P. 18
Basic configuration:			
6101	FIELDBUS ADDRESS	For entering the device address.	see P. 89
6140	SELECTION GSD	MANUFACT. SPEC.	see P. 95
6141	SET UNIT TO BUS	SET UNITS	see P. 95

4.3 Data backup/transmission

Using the T-DAT SAVE/LOAD function, you can transfer data (device parameters and settings) between the T-DAT (exchangeable memory) and the EEPROM (device storage unit).

This is required in the following instances:

- Creating a backup: current data are transferred from an EEPROM to the T-DAT.
- Replacing a transmitter: current data are copied from an EEPROM to the T-DAT and then transferred to the EEPROM of the new transmitter.
- Duplicating data: current data are copied from an EEPROM to the T-DAT and then transferred to EEPROMs of identical measuring points.



Note!

For information on installing and removing the T-DAT see → Operation Instructions Proline Promag 55 PROFIBUS PA

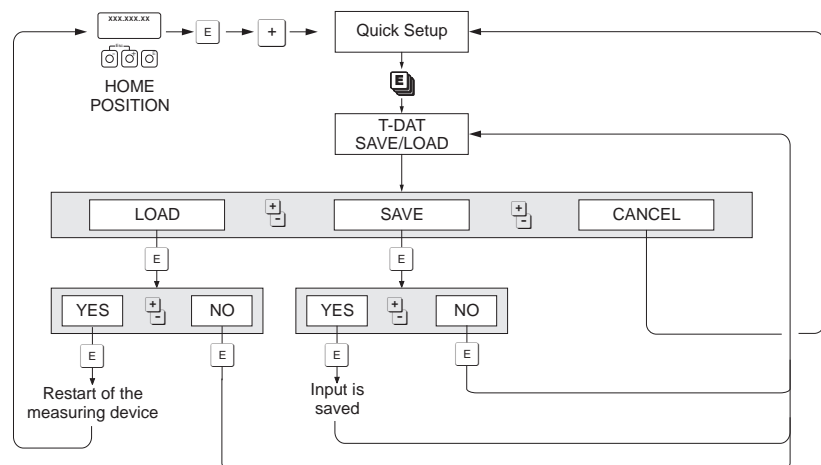

Data backup/transmission with T-DAT SAVE/LOAD function

A0001221-en

Information on the LOAD and SAVE options available:

LOAD:

Data are transferred from the T-DAT to the EEPROM.



Note!

- Any settings already saved on the EEPROM are deleted.
- This option is only available, if the T-DAT contains valid data.
- This selection can be made only if the software version of the T-DAT is the same or newer than that of the EEPROM. Otherwise, the error message "TRANSM. SW-DAT" appears after the restart and the LOAD function is subsequently no longer available.

SAVE:

Data are transferred from the EEPROM to the T-DAT

5 Block USER INTERFACE

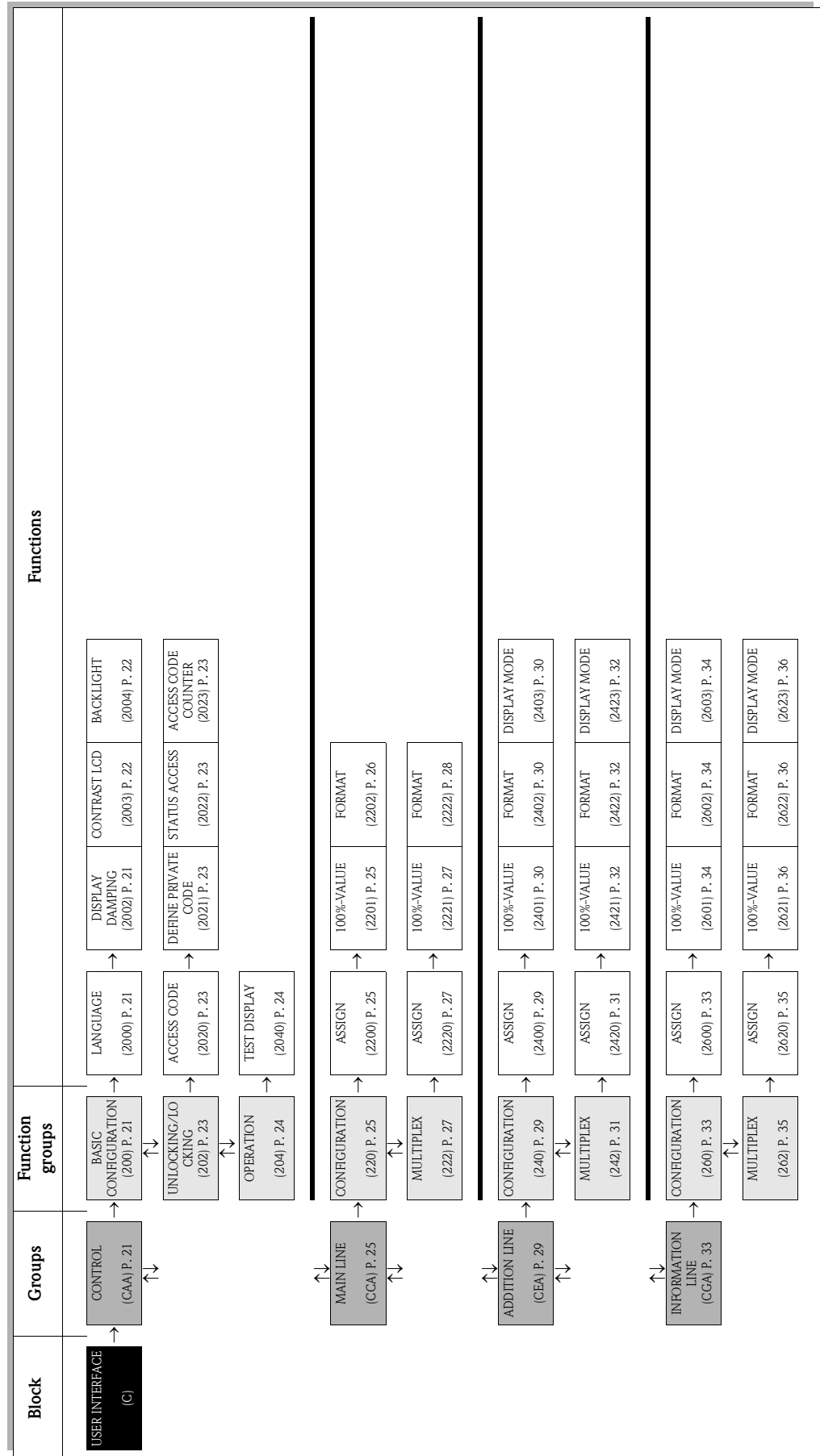

5.1 Group CONTROL





5.1.1 Function group BASIC CONFIGURATION

USER INTERFACE **C** →

CONTROL

CAA →

BASIC CONFIGURATION 200

Function description	
USER INTERFACE → CONTROL → BASIC CONFIGURATION	
LANGUAGE (2000)	<p>Use this function to select the language for all texts, parameters and messages shown on the local display.</p> <p> Note! The displayed options depend on the available language group shown in the LANGUAGE GROUP (8226) function.</p> <p>OPTIONS: Language group WEST EU / USA: ENGLISH DEUTSCH FRANCAIS ESPANOL ITALIANO NEDERLANDS PORTUGUESE</p> <p>Language group EAST EU / SCAND: ENGLISH NORSK SVENSKA SUOMI POLISH RUSSIAN CZECH</p> <p>Language group ASIA: ENGLISH BAHASA INDONESIA JAPANESE (syllabary)</p> <p>Language group CHINA: ENGLISH CHINESE</p> <p>Factory setting: Country-dependent (s. Page 132)</p> <p> Note!</p> <ul style="list-style-type: none"> ■ If you press the  keys at startup, the language defaults to ENGLISH. ■ You can change the language group via the configuration program FieldCare. Please do not hesitate to contact your Endress+Hauser sales office if you have any questions.
DISPLAY DAMPING (2002)	<p>Use this function to enter a time constant defining how the display reacts to severely fluctuating flow variables, either very quickly (enter a low time constant) or with damping (enter a high time constant).</p> <p>User input: 0 to 100 seconds</p> <p>Factory setting: 1 s</p> <p> Note! Setting the time constant to zero seconds switches off damping.</p>

Function description USER INTERFACE → CONTROL → BASIC CONFIGURATION	
CONTRAST LCD (2003)	Use this function to optimize display contrast to suit local operating conditions. User input: 10 to 100% Factory setting: 50%
BACKLIGHT (2004)	Use this function to optimize the backlight to suit local operating conditions. User input: 0 to 100%  Note! Entering the value "0" means that the backlight is switched off. The display then no longer emits any light, i.e. the display texts can no longer be read in the dark. Factory setting: 50%

5.1.2 Function group UNLOCKING/LOCKING

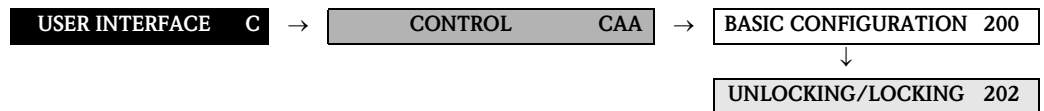

Function description USER INTERFACE → CONTROL → UNLOCKING/LOCKING	
ACCESS CODE (2020)	<p> Note! This function is only relevant for local operation and accessing via an operating program (e.g. FieldCare) and does not affect cyclic data transmission via the PROFIBUS master (Class 1).</p> <p>All data of the measuring system are protected against inadvertent change. Programming is disabled and the settings cannot be changed until a code is entered in this function. If you press the keys in any function, the measuring system automatically goes to this function and the prompt to enter the code appears on the display (when programming is disabled).</p> <p>You can enable programming by entering your personal code (factory setting = 55, see function 2021).</p> <p>User input: max. 4-digit number: 0 to 9999</p> <p> Note!</p> <ul style="list-style-type: none"> ■ Programming is disabled if you do not press a key within 60 seconds following automatic return to the HOME position. ■ You can also disable programming in this function by entering any number (other than the defined private code). ■ The Endress+Hauser service organization can be of assistance if you mislay your personal code.
DEFINE PRIVATE CODE (2021)	<p>Use this function to specify a personal code for enabling programming in the function ACCESS CODE.</p> <p>User input: 0 to 9999 (max. 4-digit number)</p> <p>Factory setting: 55</p> <p> Note!</p> <ul style="list-style-type: none"> ■ Programming is always enabled with the code "0". ■ Programming has to be enabled before this code can be changed. When programming is disabled this function is not available, thus preventing others from accessing your personal code.
STATUS ACCESS (2022)	<p>Use this function to check the access status for the function matrix.</p> <p>User interface: ACCESS CUSTOMER (parameterization possible) LOCKED (parameterization disabled)</p>
ACCESS CODE COUNTER (2023)	<p>Displays how often the customer code, service code or the digit "0" (code-free) has been entered to gain access to the function matrix.</p> <p>User interface: max. 7-digit number: 0 to 9999999</p> <p>Factory setting: 0</p>

5.1.3 Function group OPERATION

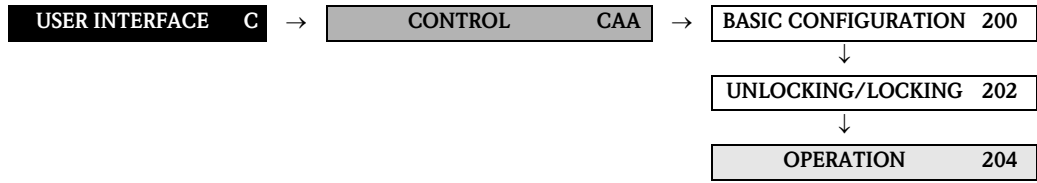



Function description USER INTERFACE → CONTROL → OPERATION	
TEST DISPLAY (2040)	<p>Use this function to test the operability of the local display and its pixels.</p> <p>Options: OFF ON</p> <p>Factory setting: OFF</p> <p>Test sequence:</p> <ol style="list-style-type: none"> 1. Start the test by selecting ON. 2. All pixels of the main line, additional line and information line are darkened for minimum 0.75 seconds. 3. Main line, additional line and information line show an "8" in each field for minimum 0.75 seconds. 4. Main line, additional line and information line show a "0" in each field for minimum 0.75 seconds. 5. Main line, additional line and information line show nothing (blank display) for minimum 0.75 seconds. <p>When the test completes the local display returns to its initial state and the setting changes to OFF.</p>

5.2 Group MAIN LINE

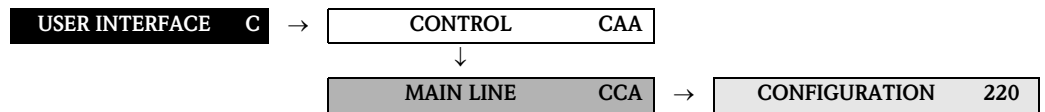
5.2.1 Function group CONFIGURATION



Function description	
USER INTERFACE → MAIN LINE → CONFIGURATION	
ASSIGN (2200)	<p>In this function, a value to be displayed is assigned to the main line (top line in the local display). This value is displayed during normal operation.</p> <p>Options: OFF VOLUME FLOW MASS FLOW VOLUME FLOW IN % MASS FLOW IN % ACTUAL CURRENT 1 ACTUAL FREQUENCY 1 AI1 - OUT VALUE AI2 - OUT VALUE AO - DISP. VALUE TOT. OUT VALUE 1 (totalizer 1) TOT. OUT VALUE 2 (totalizer 2) TOT. OUT VALUE 3 (totalizer 3) CONDUCTIVITY (only with enabled conductivity s. Page 99)</p> <p>Factory setting: VOLUME FLOW</p> <p>Advanced options with optional software package ADVANCED DIAGNOSTICS: DEVIATION COATING 1 (only with coating detection enabled s. Page 116) DEVIATION COATING 2 (only with coating detection enabled s. Page 116) DEVIATION ELECTRODE POTENTIAL 1 DEVIATION ELECTRODE POTENTIAL 2 DEVIATION VOLUME FLOW DEVIATION NOISE VALUE</p> <p>Advanced options with optional software package SOLID CONTENT FLOW: TARGET MASS FLOW % TARGET MASS FLOW TARGET VOLUME FLOW % TARGET VOLUME FLOW CARRIER MASS FLOW % CARRIER MASS FLOW CARRIER VOLUME FLOW % CARRIER VOLUME FLOW</p>
100%-VALUE (2201)	<p> Note! This function is only available if VOLUME FLOW IN % or MASS FLOW IN % was selected in the function ASSIGN (2200).</p> <p>Use this function to define the flow value to be shown on the display as the 100% value.</p> <p>User input: 5-digit floating-point number</p> <p>Factory setting: Depends on nominal diameter and country (s. Page 132 ff.).</p>

Function description	
USER INTERFACE → MAIN LINE → CONFIGURATION	
FORMAT (2202)	<p>Use this function to define the maximum number of places after the decimal point displayed for the reading in the main line.</p> <p>Options: XXXXX. – XXXX.X – XXX.XX – XX.XXX – X.XXXX</p> <p>Factory setting: X.XXXX</p> <p> Note!</p> <ul style="list-style-type: none"> ■ Note that this setting only affects the reading as it appears on the display, it has no influence on the accuracy of the system's calculations. ■ The places after the decimal point as computed by the measuring device cannot always be displayed, depending on this setting and the engineering unit. In such instances an arrow appears on the display between the measuring value and the engineering unit (e.g. 1.2 → kg/h), indicating that the measuring system is computing with more decimal places than can be shown on the display.

5.2.2 Function group MULTIPLEX

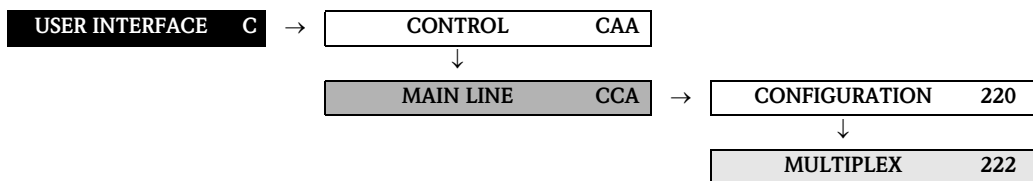

Function description	
USER INTERFACE → MAIN LINE → MULTIPLEX	
ASSIGN (2220)	<p>Use this function to define the second reading to be displayed in the main line alternately (every 10 seconds) with the value defined in the ASSIGN function (2200).</p> <p>Options: OFF VOLUME FLOW MASS FLOW VOLUME FLOW IN % MASS FLOW IN % ACTUAL CURRENT ACTUAL VALUE FREQUENCY AI1 - OUT VALUE AI2 - OUT VALUE AO - DISP. VALUE TOT. OUT VALUE 1 (totalizer 1) TOT. OUT VALUE 2 (totalizer 2) TOT. OUT VALUE 3 (totalizer 3) CONDUCTIVITY (only with enabled conductivity s. Page 99)</p> <p>Factory setting: OFF</p> <p>Advanced options with optional software package ADVANCED DIAGNOSTICS: DEVIATION COATING 1 (only with coating detection enabled s. Page 116) DEVIATION COATING 2 (only with coating detection enabled s. Page 116) DEVIATION ELECTRODE POTENTIAL 1 DEVIATION ELECTRODE POTENTIAL 2 DEVIATION VOLUME FLOW DEVIATION NOISE VALUE</p> <p>Advanced options with optional software package SOLID CONTENT FLOW: TARGET MASS FLOW % TARGET MASS FLOW TARGET VOLUME FLOW % TARGET VOLUME FLOW CARRIER MASS FLOW % CARRIER MASS FLOW CARRIER VOLUME FLOW % CARRIER VOLUME FLOW</p>
100%-VALUE (2221)	<p> Note! This function is only available if VOLUME FLOW IN % or MASS FLOW IN % was selected in the function ASSIGN (2220).</p> <p>Use this function to define the flow value to be shown on the display as the 100% value.</p> <p>User input: 5-digit floating-point number</p> <p>Factory setting: Depends on nominal diameter and country (s. Page 132 ff.).</p>





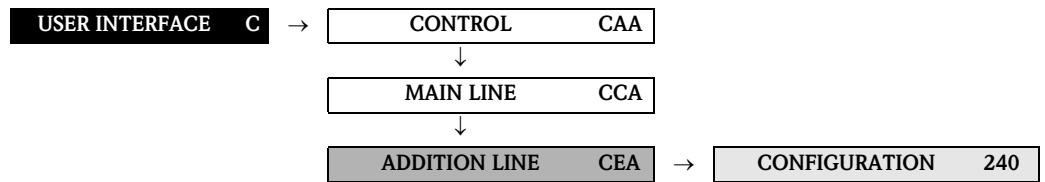

Function description USER INTERFACE → MAIN LINE → MULTIPLEX	
FORMAT (2222)	<p>Use this function to define the maximum number of places after the decimal point for the second value displayed in the main line.</p> <p>Options: XXXXX. – XXXX.X – XXX.XX – XX.XXX – X.XXXX</p> <p>Factory setting: X.XXXX</p> <p> Note!</p> <ul style="list-style-type: none"> ■ Note that this setting only affects the reading as it appears on the display, it has no influence on the accuracy of the system's calculations. ■ The places after the decimal point as computed by the measuring device cannot always be displayed, depending on this setting and the engineering unit. In such instances an arrow appears on the display between the measuring value and the engineering unit (e.g. 1.2 → kg/h), indicating that the measuring system is computing with more decimal places than can be shown on the display.

5.3 Group ADDITION LINE

5.3.1 Function group CONFIGURATION







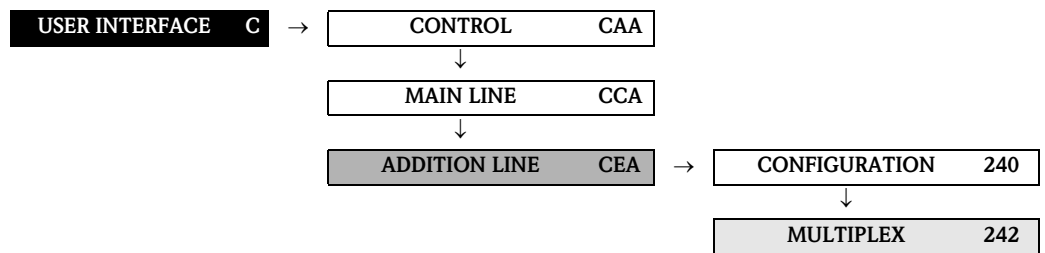

Function description	
USER INTERFACE → ADDITION LINE → CONFIGURATION	
ASSIGN (2400)	<p>In this function, a value to be displayed is assigned to the additional line (middle line in the local display). This value is displayed during normal operation.</p> <p>Options: OFF VOLUME FLOW MASS FLOW VOLUME FLOW IN % MASS FLOW IN % VOLUME FLOW BARGRAPH IN % MASS FLOW BARGRAPH IN % FLOW VELOCITY ACTUAL CURRENT ACTUAL VALUE FREQUENCY AI1 - OUT VALUE AI2 - OUT VALUE AO - DISP. VALUE TOT. OUT VALUE 1 (totalizer 1) TOT. OUT VALUE 2 (totalizer 2) TOT. OUT VALUE 3 (totalizer 3) TAG NAME TAG NAME CONDUCTIVITY (only with enabled conductivity → Page 99)</p> <p>Factory setting: TOTALIZER 1</p> <p>Advanced options with optional software package ADVANCED DIAGNOSTICS: DEVIATION COATING 1 (only with coating detection enabled → Page 116) DEVIATION COATING 2 (only with coating detection enabled → Page 116) DEVIATION ELECTRODE POTENTIAL 1 DEVIATION ELECTRODE POTENTIAL 2 DEVIATION VOLUME FLOW DEVIATION NOISE VALUE</p> <p>Advanced options with optional software package SOLID CONTENT FLOW: TARGET MASS FLOW % TARGET MASS FLOW TARGET MASS FLOW BARGRAPH IN % TARGET VOLUME FLOW % TARGET VOLUME FLOW TARGET VOLUME FLOW BARGRAPH % CARRIER MASS FLOW % CARRIER MASS FLOW CARRIER VOLUME FLOW % CARRIER VOLUME FLOW</p>

Function description	
USER INTERFACE → ADDITION LINE → CONFIGURATION	
100%-VALUE (2401)	<p> Note! This function is not available unless one of the following was selected in the function ASSIGN (2400):</p> <ul style="list-style-type: none"> ■ VOLUME FLOW IN % ■ MASS FLOW IN % ■ VOLUME FLOW BARGRAPH IN % ■ MASS FLOW BARGRAPH IN % <p>Use this function to define the flow value to be shown on the display as the 100% value.</p> <p>User input: 5-digit floating-point number</p> <p>Factory setting: Depends on nominal diameter and country (s. Page 132 ff.).</p>
FORMAT (2402)	<p> Note! This function is not available unless a number was selected in the ASSIGN function (2400).</p> <p>Use this function to define the maximum number of places after the decimal point displayed for the reading in the additional line.</p> <p>Options: XXXXX. – XXXX.X – XXX.XX – XX.XXX – X.XXXX</p> <p>Factory setting: X.XXXX</p> <p> Note!</p> <ul style="list-style-type: none"> ■ Note that this setting only affects the reading as it appears on the display, it has no influence on the accuracy of the system's calculations. ■ The places after the decimal point as computed by the measuring device cannot always be displayed, depending on this setting and the engineering unit. In such instances an arrow appears on the display between the measuring value and the engineering unit (e.g. 1.2 → kg/h), indicating that the measuring system is computing with more decimal places than can be shown on the display.
DISPLAY MODE (2403)	<p> Note! This function is only available if VOLUME FLOW BARGRAPH IN % or MASS FLOW BARGRAPH IN % was selected in the function ASSIGN (2400).</p> <p>Use this function to define the format of the bar graph.</p> <p>Options: STANDARD (Simple bar graph with 25 / 50 / 75% gradations and integrated sign).</p> <div style="text-align: center;">  </div> <p style="text-align: right; font-size: small;">A0001258</p> <p>SYMMETRY (Symmetrical bar graph for positive and negative directions of flow, with -50 / 0 / +50% gradations and integrated sign).</p> <div style="text-align: center;">  </div> <p style="text-align: right; font-size: small;">A0001259</p> <p>Factory setting: STANDARD</p>

5.3.2 Function group MULTIPLEX



Function description	
USER INTERFACE → ADDITION LINE → MULTIPLEX	
ASSIGN (2420)	<p>Use this function to define the second reading to be displayed in the additional line alternately (every 10 seconds) with the value defined in the function ASSIGN (2400).</p> <p>Options: OFF VOLUME FLOW MASS FLOW VOLUME FLOW IN % MASS FLOW IN % VOLUME FLOW BARGRAPH IN % MASS FLOW BARGRAPH IN % FLOW VELOCITY ACTUAL CURRENT ACTUAL VALUE FREQUENCY AI1 - OUT VALUE AI2 - OUT VALUE AO - DISP. VALUE TOT. OUT VALUE 1 (totalizer 1) TOT. OUT VALUE 2 (totalizer 2) TOT. OUT VALUE 3 (totalizer 3) TAG NAME TAG NAME CONDUCTIVITY (only with enabled conductivity → Page 99)</p> <p>Factory setting: OFF</p> <p>Advanced options with optional software package ADVANCED DIAGNOSTICS: DEVIATION COATING 1 (only with coating detection enabled → Page 116) DEVIATION COATING 2 (only with coating detection enabled → Page 116) DEVIATION ELECTRODE POTENTIAL 1 DEVIATION ELECTRODE POTENTIAL 2 DEVIATION VOLUME FLOW DEVIATION NOISE VALUE</p> <p>Advanced options with optional software package SOLID CONTENT FLOW: TARGET MASS FLOW % TARGET MASS FLOW TARGET MASS FLOW BARGRAPH IN % TARGET VOLUME FLOW % TARGET VOLUME FLOW TARGET VOLUME FLOW BARGRAPH % CARRIER MASS FLOW % CARRIER MASS FLOW CARRIER VOLUME FLOW % CARRIER VOLUME FLOW</p>





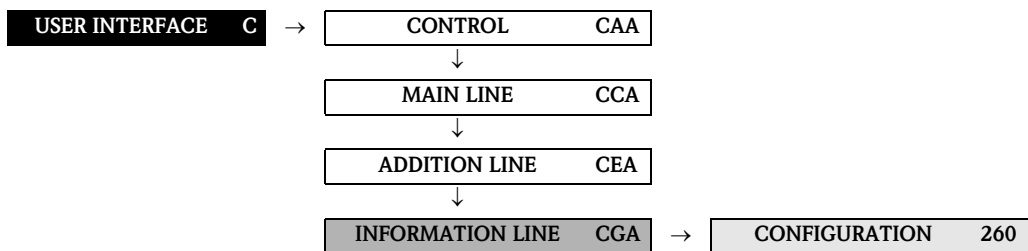

Function description USER INTERFACE → ADDITION LINE → MULTIPLEX	
100%-VALUE (2421)	<p> Note! This function is not available unless one of the following was selected in the function ASSIGN (2420):</p> <ul style="list-style-type: none"> ■ VOLUME FLOW IN % ■ MASS FLOW IN % ■ VOLUME FLOW BARGRAPH IN % ■ MASS FLOW BARGRAPH IN % <p>Use this function to define the flow value to be shown on the display as the 100% value.</p> <p>User input: 5-digit floating-point number</p> <p>Factory setting: Depends on nominal diameter and country (s. Page 132 ff.).</p>
FORMAT (2422)	<p> Note! This function is not available unless a number was selected in the ASSIGN function (2420).</p> <p>Use this function to define the maximum number of places after the decimal point for the second value displayed in the additional line.</p> <p>Options: XXXXX. – XXXX.X – XXX.XX – XX.XXX – X.XXXX</p> <p>Factory setting: X.XXXX</p> <p> Note!</p> <ul style="list-style-type: none"> ■ Note that this setting only affects the reading as it appears on the display, it has no influence on the accuracy of the system's calculations. ■ The places after the decimal point as computed by the measuring device cannot always be displayed, depending on this setting and the engineering unit. In such instances an arrow appears on the display between the measuring value and the engineering unit (e.g. 1.2 → kg/h), indicating that the measuring system is computing with more decimal places than can be shown on the display.
DISPLAY MODE (2423)	<p> Note! This function is only available if VOLUME FLOW BARGRAPH IN % or MASS FLOW BARGRAPH IN % was selected in the function ASSIGN (2420).</p> <p>Use this function to define the format of the bar graph.</p> <p>Options: STANDARD (Simple bar graph with 25 / 50 / 75% gradations and integrated sign).</p> <div style="text-align: center;">  </div> <p style="text-align: right; font-size: small;">A0001258</p> <p>SYMMETRY (Symmetrical bar graph for positive and negative directions of flow, with -50 / 0 / +50% gradations and integrated sign).</p> <div style="text-align: center;">  </div> <p style="text-align: right; font-size: small;">A0001259</p> <p>Factory setting: STANDARD</p>

5.4 Group INFORMATION LINE

5.4.1 Function group CONFIGURATION







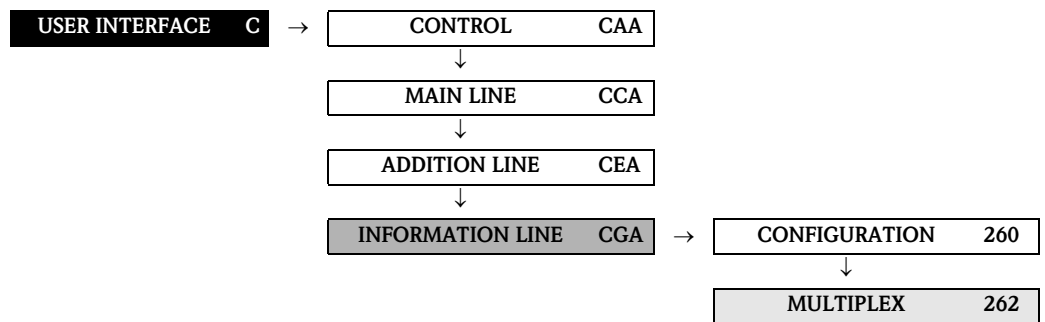

Function description	
USER INTERFACE → INFORMATION LINE → CONFIGURATION	
ASSIGN (2600)	<p>In this function, a value to be displayed is assigned to the information line (bottom line in the local display). This value is displayed during normal operation.</p> <p>Options: OFF VOLUME FLOW IN % MASS FLOW IN % VOLUME FLOW BARGRAPH IN % MASS FLOW BARGRAPH IN % FLOW VELOCITY ACTUAL CURRENT ACTUAL VALUE FREQUENCY AI1 - OUT VALUE AI2 - OUT VALUE AO - DISP. VALUE TOT. OUT VALUE 1 (totalizer 1) TOT. OUT VALUE 2 (totalizer 2) TOT. OUT VALUE 3 (totalizer 3) TAG NAME TAG NAME OPERATING/SYSTEM CONDITIONS FLOW DIRECTION READING CONDUCTIVITY (only with enabled conductivity → Page 99)</p> <p>Factory setting: OPERATING/SYSTEM CONDITIONS</p> <p>Advanced options with optional software package ADVANCED DIAGNOSTICS: DEVIATION COATING 1 (only with coating detection enabled → Page 116) DEVIATION COATING 2 (only with coating detection enabled → Page 116) DEVIATION ELECTRODE POTENTIAL 1 DEVIATION ELECTRODE POTENTIAL 2 DEVIATION VOLUME FLOW DEVIATION NOISE VALUE</p> <p>Advanced options with optional software package SOLID CONTENT FLOW: TARGET MASS FLOW % TARGET MASS FLOW TARGET MASS FLOW BARGRAPH IN % TARGET VOLUME FLOW % TARGET VOLUME FLOW TARGET VOLUME FLOW BARGRAPH % CARRIER MASS FLOW % CARRIER MASS FLOW CARRIER VOLUME FLOW % CARRIER VOLUME FLOW</p>

Function description USER INTERFACE → INFORMATION LINE → CONFIGURATION	
100%-VALUE (2601)	<p> Note! This function is not available unless one of the following was selected in the function ASSIGN (2600):</p> <ul style="list-style-type: none"> ■ VOLUME FLOW IN % ■ MASS FLOW IN % ■ VOLUME FLOW BARGRAPH IN % ■ MASS FLOW BARGRAPH IN % <p>Use this function to define the flow value to be shown on the display as the 100% value.</p> <p>User input: 5-digit floating-point number</p> <p>Factory setting: Depends on nominal diameter and country (s. Page 132 ff.).</p>
FORMAT (2602)	<p> Note! This function is not available unless a number was selected in the ASSIGN function (2600).</p> <p>Use this function to define the maximum number of places after the decimal point displayed for the reading in the information line.</p> <p>Options: XXXXX. – XXXX.X – XXX.XX – XX.XXX – X.XXXX</p> <p>Factory setting: X.XXXX</p> <p> Note!</p> <ul style="list-style-type: none"> ■ Note that this setting only affects the reading as it appears on the display, it has no influence on the accuracy of the system's calculations. ■ The places after the decimal point as computed by the measuring device cannot always be displayed, depending on this setting and the engineering unit. In such instances an arrow appears on the display between the measuring value and the engineering unit (e.g. 1.2 → kg/h), indicating that the measuring system is computing with more decimal places than can be shown on the display.
DISPLAY MODE (2603)	<p> Note! This function is only available if VOLUME FLOW BARGRAPH IN % or MASS FLOW BARGRAPH IN % was selected in the function ASSIGN (2600).</p> <p>Use this function to define the format of the bar graph.</p> <p>Options: STANDARD (Simple bar graph with 25 / 50 / 75% gradations and integrated sign).</p> <div style="text-align: center;">  </div> <p style="text-align: right; font-size: small;">A0001258</p> <p>SYMMETRY (Symmetrical bar graph for positive and negative directions of flow, with -50 / 0 / +50% gradations and integrated sign).</p> <div style="text-align: center;">  </div> <p style="text-align: right; font-size: small;">A0001259</p> <p>Factory setting: STANDARD</p>

5.4.2 Function group MULTIPLEX



Function description	
USER INTERFACE → INFORMATION LINE → MULTIPLEX	
ASSIGN (2620)	<p>Use this function to define the second reading to be displayed in the information line alternately (every 10 seconds) with the value defined in the function ASSIGN (2600).</p> <p>Options: OFF VOLUME FLOW IN % MASS FLOW IN % VOLUME FLOW BARGRAPH IN % MASS FLOW BARGRAPH IN % FLOW VELOCITY ACTUAL CURRENT ACTUAL VALUE FREQUENCY AI1 - OUT VALUE AI2 - OUT VALUE AO - DISP. VALUE TOT. OUT VALUE 1 (totalizer 1) TOT. OUT VALUE 2 (totalizer 2) TOT. OUT VALUE 3 (totalizer 3) TAG NAME TAG NAME OPERATING/SYSTEM CONDITIONS FLOW DIRECTION READING CONDUCTIVITY (only with enabled conductivity → Page 99)</p> <p>Factory setting: OFF</p> <p>Advanced options with optional software package ADVANCED DIAGNOSTICS: DEVIATION COATING 1 (only with coating detection enabled → Page 116) DEVIATION COATING 2 (only with coating detection enabled → Page 116) DEVIATION ELECTRODE POTENTIAL 1 DEVIATION ELECTRODE POTENTIAL 2 DEVIATION VOLUME FLOW DEVIATION NOISE VALUE</p> <p>Advanced options with optional software package SOLID CONTENT FLOW: TARGET MASS FLOW % TARGET MASS FLOW TARGET MASS FLOW BARGRAPH IN % TARGET VOLUME FLOW % TARGET VOLUME FLOW TARGET VOLUME FLOW BARGRAPH % CARRIER MASS FLOW % CARRIER MASS FLOW CARRIER VOLUME FLOW % CARRIER VOLUME FLOW</p>

Function description USER INTERFACE → INFORMATION LINE → MULTIPLEX	
100%-VALUE (2621)	<p> Note! This function is not available unless one of the following was selected in the function ASSIGN (2620):</p> <ul style="list-style-type: none"> ■ VOLUME FLOW IN % ■ MASS FLOW IN % ■ VOLUME FLOW BARGRAPH IN % ■ MASS FLOW BARGRAPH IN % <p>Use this function to define the flow value to be shown on the display as the 100% value.</p> <p>User input: 5-digit floating-point number</p> <p>Factory setting: Depends on nominal diameter and country (s. Page 132 ff.).</p>
FORMAT (2622)	<p> Note! This function is not available unless a number was selected in the ASSIGN function (2600).</p> <p>Use this function to define the maximum number of places after the decimal point for the second value displayed in the information line.</p> <p>Options: XXXXX. – XXXX.X – XXX.XX – XX.XXX – X.XXXX</p> <p>Factory setting: X.XXXX</p> <p> Note!</p> <ul style="list-style-type: none"> ■ Note that this setting only affects the reading as it appears on the display, it has no influence on the accuracy of the system's calculations. ■ The places after the decimal point as computed by the measuring device cannot always be displayed, depending on this setting and the engineering unit. In such instances an arrow appears on the display between the measuring value and the engineering unit (e.g. 1.2 → kg/h), indicating that the measuring system is computing with more decimal places than can be shown on the display.
DISPLAY MODE (2623)	<p> Note! This function is only available if VOLUME FLOW BARGRAPH IN % or MASS FLOW BARGRAPH IN % was selected in the function ASSIGN (2620).</p> <p>Use this function to define the format of the bar graph.</p> <p>Options: STANDARD (Simple bar graph with 25 / 50 / 75% gradations and integrated sign).</p> <div style="text-align: center;">  </div> <p style="text-align: right; font-size: small;">A0001258</p> <p>SYMMETRY (Symmetrical bar graph for positive and negative directions of flow, with -50 / 0 / +50% gradations and integrated sign).</p> <div style="text-align: center;">  </div> <p style="text-align: right; font-size: small;">A0001258</p> <p>Factory setting: STANDARD</p>

6 Block OUTPUTS



Note!

This block is not available for all devices → Page 8 (Available blocks, groups, etc.).

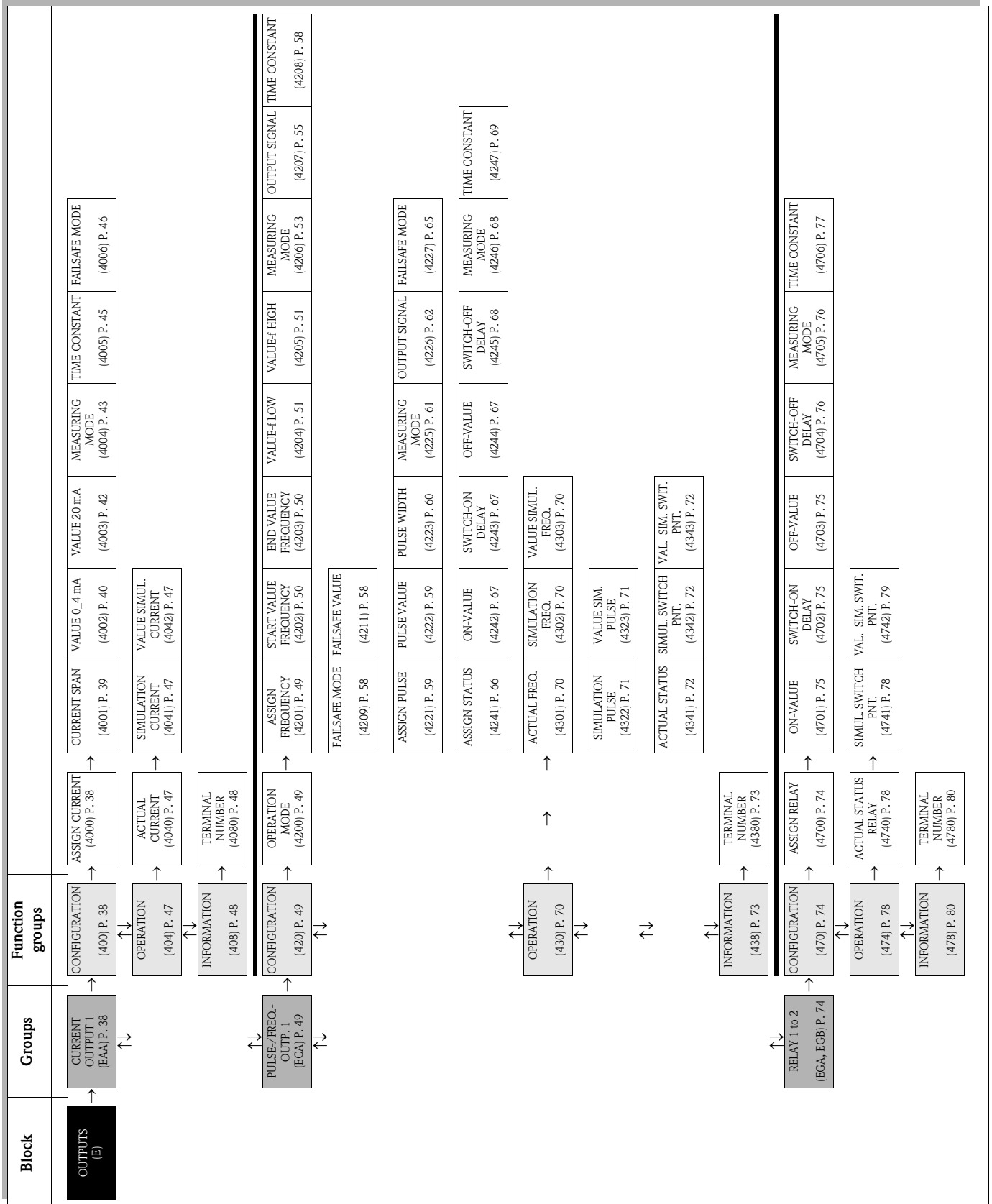



6.1 Group CURRENT OUTPUT 1

6.1.1 Function group CONFIGURATION

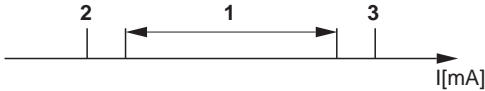

OUTPUTS	E	→	CURRENT OUTPUT 1	EAA	→	CONFIGURATION	400
---------	---	---	------------------	-----	---	---------------	-----

Function description	
OUTPUTS → CURRENT OUTPUT 1 → CONFIGURATION (only with PROFIBUS DP)	
ASSIGN CURRENT OUTPUT (4000)	<p>Use this function to assign a measured variable to the current output.</p> <p>Options: OFF VOLUME FLOW MASS FLOW CONDUCTIVITY (only with enabled conductivity → Page 99)</p> <p>Factory setting: VOLUME FLOW</p> <p>Advanced options with optional software package SOLID CONTENT FLOW: TARGET MASS FLOW % TARGET MASS FLOW TARGET VOLUME FLOW % TARGET VOLUME FLOW CARRIER MASS FLOW % CARRIER MASS FLOW CARRIER VOLUME FLOW % CARRIER VOLUME FLOW</p> <p>Advanced options with optional software package ADVANCED DIAGNOSTICS: DEVIATION COATING 1 (only with coating detection enabled → Page 116) DEVIATION COATING 2 (only with coating detection enabled → Page 116) DEVIATION ELECTRODE POTENTIAL 1 DEVIATION ELECTRODE POTENTIAL 2 DEVIATION VOLUME FLOW DEVIATION NOISE VALUE</p> <p> Note! If you select OFF, the only function shown in the CONFIGURATION function group is ASSIGN CURRENT OUTPUT 1 (4000).</p>

Function description																													
OUTPUTS → CURRENT OUTPUT 1 → CONFIGURATION (only with PROFIBUS DP)																													
CURRENT SPAN (4001)	<p>Use this function to define the current span. This selection defines the operational range and the upper and lower signal on alarm. For the current output 1 the option HART can be defined additionally.</p> <p>Select 0–20 mA (25 mA) 4–20 mA (25 mA) 0–20 mA 4–20 mA 4–20 mA NAMUR 4–20 mA US</p> <p>Factory setting: 4–20 mA NAMUR</p> <p> Note! When switching the hardware from an active (factory setting) to a passive output signal, select a current span of 4–20 mA (please refer to the Operating Instructions).</p> <p>Current span, operational range and signal on alarm level</p>  <table border="1" style="margin-top: 10px;"> <thead> <tr> <th style="text-align: center;">a</th> <th style="text-align: center;">1</th> <th style="text-align: center;">2</th> <th style="text-align: center;">3</th> </tr> </thead> <tbody> <tr> <td>0-20 mA (25 mA)</td> <td>0 - 24 mA</td> <td>0</td> <td>25</td> </tr> <tr> <td>4-20 mA (25 mA)</td> <td>4 - 24 mA</td> <td>2</td> <td>25</td> </tr> <tr> <td>0-20 mA</td> <td>0 - 20.5 mA</td> <td>0</td> <td>22</td> </tr> <tr> <td>4-20 mA</td> <td>4 - 20.5 mA</td> <td>2</td> <td>22</td> </tr> <tr> <td>4-20 mA NAMUR</td> <td>3.8 - 20.5 mA</td> <td>3.5</td> <td>22.6</td> </tr> <tr> <td>4-20 mA US</td> <td>3.9 - 20.8 mA</td> <td>3.75</td> <td>22.6</td> </tr> </tbody> </table> <p style="text-align: right; font-size: small;">A0002959</p> <p><i>a</i> Current span <i>1</i> Operational range (measuring information) <i>2</i> Lower signal on alarm level <i>3</i> Upper signal on alarm level</p> <p> Note!</p> <ul style="list-style-type: none"> ■ If the measured value exceeds the measuring range (as defined in the functions VALUE 0_4 mA (4002) and VALUE 20 mA (4003) a notice message is generated (#351–354, current range). ■ In case of a fault the behavior of the current output is according to the selected option in the function FAILSAFE MODE (4006). 	a	1	2	3	0-20 mA (25 mA)	0 - 24 mA	0	25	4-20 mA (25 mA)	4 - 24 mA	2	25	0-20 mA	0 - 20.5 mA	0	22	4-20 mA	4 - 20.5 mA	2	22	4-20 mA NAMUR	3.8 - 20.5 mA	3.5	22.6	4-20 mA US	3.9 - 20.8 mA	3.75	22.6
a	1	2	3																										
0-20 mA (25 mA)	0 - 24 mA	0	25																										
4-20 mA (25 mA)	4 - 24 mA	2	25																										
0-20 mA	0 - 20.5 mA	0	22																										
4-20 mA	4 - 20.5 mA	2	22																										
4-20 mA NAMUR	3.8 - 20.5 mA	3.5	22.6																										
4-20 mA US	3.9 - 20.8 mA	3.75	22.6																										

Function description	
OUTPUTS → CURRENT OUTPUT 1 → CONFIGURATION (only with PROFIBUS DP)	
VALUE 0_4 mA (4002)	<p>Use this function to assign the 0/4 mA current a value. The value can be higher or lower than the value assigned to 20 mA (function VALUE 20 mA (4003)). Positive and negative values are permissible, depending on the measured variable in question (e.g. volume flow).</p> <p>Example: 4 mA assigned value = -250 l/h 20 mA assigned value = +750 l/h Calculated current value = 8 mA (at zero flow)</p> <p>Note that values with different signs cannot be entered for 0/4 mA and 20 mA (function 4003) if SYMMETRY is the setting selected for the MEASURING MODE function (4004). In this case, the message "INPUT RANGE EXCEEDED" appears on the display.</p> <p>Example for STANDARD measuring mode:</p> <div style="text-align: center;"> </div> <p style="text-align: right;">A0001223</p> <p>① = Initial value (0 to 20 mA) ② = Lower signal on alarm level: depends on the setting in the function CURRENT SPAN ③ = Initial value (4 to 20 mA): depends on the setting in the function CURRENT SPAN ④ = Full scale value (0/4 to 20 mA): depends on the setting in the function CURRENT SPAN ⑤ = Maximum current value: depends on the setting in the function CURRENT SPAN ⑥ = Failsafe mode (upper signal on alarm level): depends on the setting in the functions CURRENT SPAN (s. Page 39) and FAILSAFE MODE, (s. Page 46)</p> <p><i>A = Measuring range (the minimum measuring range has to exceed the value that correlates with a flow velocity of 0.3 m/s)</i></p> <p>User input: 5-digit floating-point number, with sign</p> <p>Factory setting: 0 [unit]</p> <p> Note! ■ The appropriate unit is taken from the function UNIT VOLUME FLOW (0402) or UNIT MASS FLOW (0400), (see Page 13 or Page 12).</p> <p> Caution! The current output responds differently, depending on the parameters set in the various functions. Some examples of parameter settings and their effect on the current output are given in the following section.</p> <p>(continued on next page)</p>

Function description OUTPUTS → CURRENT OUTPUT 1 → CONFIGURATION (only with PROFIBUS DP)	
<p>VALUE 0_4 mA (continued)</p>	<p>Parameter setting example A:</p> <ol style="list-style-type: none"> 1. VALUE 0_4 mA (4002) = not equal to zero flow (e.g. $-5 \text{ m}^3/\text{h}$) VALUE 20 mA (4003) = not equal to zero flow (e.g. $10 \text{ m}^3/\text{h}$) or 2. VALUE 0_4 mA (4002) = not equal to zero flow (e.g. $100 \text{ m}^3/\text{h}$) VALUE 20 mA (4003) = not equal to zero flow (e.g. $-40 \text{ m}^3/\text{h}$) <p>and MEASURING MODE (4004) = STANDARD</p> <p>When you enter the values for 0/4 mA and 20 mA, the working range of the measuring device is defined. If the effective flow drops below or exceeds this working range (see ①), a fault/notice message is generated (#351-354, current range) and the current output responds in accordance with the parameter settings in the function FAILSAFE MODE (4006).</p> <div style="display: flex; justify-content: space-around; align-items: center;"> <div style="text-align: center;"> <p>1)</p> </div> <div style="text-align: center;"> <p>2)</p> </div> </div> <p style="text-align: right; font-size: small;">A0001262</p> <p>Parameter setting example B:</p> <ol style="list-style-type: none"> 1. VALUE 0_4 mA (4002) = equal to zero flow (e.g. $0 \text{ m}^3/\text{h}$) VALUE 20 mA (4003) = not equal to zero flow (e.g. $10 \text{ m}^3/\text{h}$) or 2. VALUE 0_4 mA (4002) = not equal to zero flow (e.g. $100 \text{ m}^3/\text{h}$) VALUE 20 mA (4003) = equal to zero flow (e.g. $0 \text{ m}^3/\text{h}$) <p>and MEASURING MODE (4004) = STANDARD</p> <p>When you enter the values for 0/4 mA and 20 mA, the working range of the measuring device is defined. One of the two values here is configured as zero flow (e.g. $0 \text{ m}^3/\text{h}$). If the effective flow drops below or exceeds the value configured as the zero flow, no fault/notice message is generated and the current output retains its value. If the effective flow drops below or exceeds the other value, a fault/notice message is generated (#351-354, current range) and the current output responds in accordance with the parameter settings in the function FAILSAFE MODE (4006).</p> <div style="display: flex; justify-content: space-around; align-items: center;"> <div style="text-align: center;"> <p>1)</p> </div> <div style="text-align: center;"> <p>2)</p> </div> </div> <p style="text-align: right; font-size: small;">A0001264</p> <p>Deliberately only one flow direction is output with this setting and flow values in the other flow direction are suppressed.</p> <p>Parameter setting example C: MEASURING MODE (4004) = SYMMETRY</p> <p>The current output signal is independent of the direction of flow (absolute amount of the measured variable). The 0_4 mA VALUE ① and the 20 mA VALUE ② must have the same sign (+ or -). The "20 mA VALUE" ③ (e.g. backflow) corresponds to the mirrored 20 mA VALUE ② (e.g. flow).</p> <div style="text-align: center;"> </div> <p style="text-align: right; font-size: small;">A0001249</p> <p>ASSIGN RELAY (4700) = FLOW DIRECTION</p> <p>With this setting e.g. the flow direction output via a switching contact can be made.</p> <p>Parameter setting example D: MEASURING MODE (4004) = PULSATING FLOWs. Page 43</p>

Function description	
OUTPUTS → CURRENT OUTPUT 1 → CONFIGURATION (only with PROFIBUS DP)	
VALUE 20 mA (4003)	<p>Use this function to assign the 20 mA current a value. The value can be higher or lower than the value assigned to 0/4 mA (function VALUE 0_4 mA (4002), see Page 40). Positive and negative values are permissible, depending on the measured variable in question (e.g. volume flow).</p> <p>Example: 4 mA assigned value = -250 l/h 20 mA assigned value = +750 l/h Calculated current value = 8 mA (at zero flow)</p> <p>Note that values with different signs cannot be entered for 0/4 mA (function 4002) and 20 mA, if SYMMETRY is the setting selected in the function MEASURING MODE (4004). In this case, the message "INPUT RANGE EXCEEDED" appears.</p> <p>Example for STANDARD measuring mode → Page 40</p> <p>User input: 5-digit floating-point number, with sign</p> <p>Factory setting: Depends on nominal diameter and country (s. Page 132 ff.).</p> <p> Note! <ul style="list-style-type: none"> ■ The appropriate unit is taken from the function UNIT VOLUME FLOW (0402) or UNIT MASS FLOW (0400). </p> <p> Caution! It is very important to read and comply with the information in the function VALUE 0_4 mA (under "⚠ Caution"; Examples of parameter settings) on Page 40.</p>

Function description OUTPUTS → CURRENT OUTPUT 1 → CONFIGURATION (only with PROFIBUS DP)	
<p>MEASURING MODE (4004)</p>	<p>Use this function to define the measuring mode for the current output.</p> <p>Options: STANDARD SYMMETRY PULSATING FLOW</p> <p>Factory setting: STANDARD</p> <p>Description of the individual options:</p> <ul style="list-style-type: none"> <p>■ STANDARD</p> <p>The current output signal is proportional to the measured variable. The flow components outside the scaled measuring range (defined by the 0_4 mA VALUE ① and the 20 mA VALUE ②) are taken into account as follows for signal output.</p> <ul style="list-style-type: none"> – If one of the values is defined as equal to the zero flow (e.g. VALUE 0_4 mA = 0 m³/h), no message is given if this value is exceeded or not achieved and the current output retains its value (4 mA in the example). If the other value is exceeded or not achieved, the message "CURRENT OUTPUT AT FULL SCALE VALUE" appears and the current output responds in accordance with the parameter setting in the function FAILSAFE MODE (4006). – If both values defined are not equal to the zero flow (for example VALUE 0_4 mA = -5 m³/h; VALUE 20 mA = 10m³/h), the message "CURRENT OUTPUT AT FULL SCALE VALUE" appears if the measuring range is exceeded or not achieved and the current output responds in accordance with the parameter setting in the function FAILSAFE MODE (4006). <div style="text-align: center;"> </div> <ul style="list-style-type: none"> <p>■ SYMMETRY</p> <p>The current output signal is independent of the direction of flow (absolute amount of the measured variable). The 0_4 mA VALUE ① and the 20 mA VALUE ② must have the same sign (+ or -). The "20 mA VALUE" ③ (e.g. backflow) corresponds to the mirrored 20 mA VALUE ② (e.g. flow).</p> <div style="text-align: center;"> </div> <p style="text-align: right; font-size: small;">A0001248</p>
	<div style="text-align: right; font-size: small;">A0001249</div> <p> Note!</p> <ul style="list-style-type: none"> ■ The direction of flow can be output via the configurable relay or status outputs. ■ SYMMETRY cannot be selected unless the values in the VALUE 0_4 mA (4002) and VALUE 20 mA (4003) functions have the same sign or one of the values is zero. If the values have different signs, SYMMETRY cannot be selected and an "ASSIGNMENT NOT POSSIBLE" message is displayed. <p>(continued on next page)</p>





Function description	
OUTPUTS → CURRENT OUTPUT 1 → CONFIGURATION (only with PROFIBUS DP)	
MEASURING MODE (continued)	<ul style="list-style-type: none"> PULSATING FLOW If flow is characterized by severe fluctuations as is the case, for example, with reciprocating pumps, flow components outside the measuring range are buffered, balanced and output after a maximum delay of 60 seconds. If the buffered data cannot be processed within approx. 60 seconds, a fault/notice message appears. Under certain plant conditions, flow values can aggregate in the buffer, for example in the case of prolonged and unwanted fluid backflow. However, this buffer is reset in all relevant programming adjustments which affect the current output.
Detailed explanations and information	<p>How the current output responds under the following postulated conditions:</p> <p>1. Defined measuring range (①–②): ① and ② have the same sign</p> <div style="text-align: center;"> </div> <p style="text-align: right;">A0001248</p> <p>and the following flow behavior:</p> <div style="text-align: center;"> </div> <ul style="list-style-type: none"> STANDARD The current output signal is proportional to the measured variable. The flow components outside the scaled measuring range are not taken into account for signal output. <div style="text-align: center;"> </div> <p style="text-align: right;">A0001265</p> SYMMETRY The current output signal is independent of the direction of flow. <div style="text-align: center;"> </div> <p style="text-align: right;">A0001267</p> PULSATING FLOW Flow components outside the measuring range are buffered, balanced and output after a maximum delay of 60 seconds. <div style="text-align: center;"> </div> <p style="text-align: right;">A0001268</p> <div style="text-align: center;"> </div> <p style="text-align: right;">A0001269</p> <p>(continued on next page)</p>

Function description OUTPUTS → CURRENT OUTPUT 1 → CONFIGURATION (only with PROFIBUS DP)	
<p>Detailed explanations and information (continued)</p>	<p>2. Defined measuring range (①–②): ① and ② do not have the same sign.</p> <div style="text-align: center;"> </div> <p>Flow a (—) outside, b (---) within the measuring range.</p> <div style="text-align: center;"> </div> <p>■ STANDARD</p> <p>a (—): The flow components outside the scaled measuring range cannot be taken into account for signal output. A fault message is generated (# 351 to 354, current range) and the current output responds in accordance with the parameter settings in the function FAILSAFE MODE (4006).</p> <p>b (---): The current output signal is proportional to the measured variable assigned.</p> <div style="text-align: center;"> </div> <p>■ SYMMETRY</p> <p>This option is not available under these circumstances because the 0_4 mA value and the 20 mA value have different signs.</p> <p>■ PULSATING FLOW</p> <p>Flow components outside the measuring range are buffered, balanced and output after a maximum delay of 60 seconds.</p> <div style="text-align: center;"> </div>
<p>TIME CONSTANT (4005)</p>	<p>Use this function to enter a time constant defining how the current output signal reacts to severely fluctuating measured variables, either very quickly (enter a low time constant) or with damping (enter a high time constant).</p> <p>User input: fixed-point number 0.01 to 100.00 s</p> <p>Factory setting: 3.00 s</p>

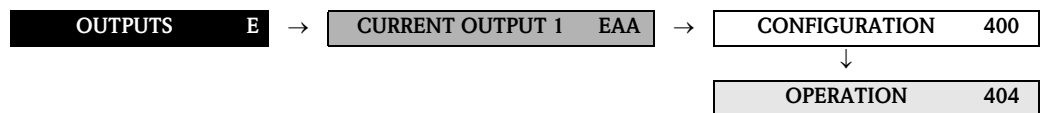
Function description	
OUTPUTS → CURRENT OUTPUT 1 → CONFIGURATION (only with PROFIBUS DP)	
FAILSAFE MODE (4006)	<p>For safety reasons it is advisable to ensure that the current output assumes a predefined state in the event of a fault. The setting you select here affects only the current output. It has no effect on other outputs and the display (e.g. totalizers).</p> <p>Options:</p> <p>MIN. CURRENT The current output adopts the value of the lower signal on alarm level (as defined in the function CURRENT SPAN (4001, Page 39).</p> <p>MAX. CURRENT The current output adopts the value of the upper signal on alarm level (as defined in the function CURRENT SPAN (4001, Page 39).</p> <p>HOLD VALUE (not recommended) Measuring value output is based on the last measuring value saved before the error occurred.</p> <p>ACTUAL VALUE Measuring value output is based on the current flow measurement. The fault is ignored.</p> <p>Factory setting: MIN. CURRENT</p>

6.1.2 Function group OPERATION



Function description OUTPUTS → CURRENT OUTPUT 1 → OPERATION (only with PROFIBUS DP)	
ACTUAL CURRENT (4040)	<p>Use this function to view the computed actual value of the output current.</p> <p>User interface: 0.00 to 25.00 mA</p>
SIMULATION CURRENT (4041)	<p>Use this function to activate simulation of the current output.</p> <p>Options: OFF ON</p> <p>Factory setting: OFF</p> <p> Note! <ul style="list-style-type: none"> ■ The "SIMULATION CURRENT OUTPUT" message indicates that simulation is active. ■ The measuring device continues to measure while simulation is in progress, i.e. the current measured values are output correctly via the other outputs. </p> <p> Caution! The setting is not saved if the power supply fails.</p>
VALUE SIMULATION CURRENT (4042)	<p> Note! The function is not visible unless the SIMULATION CURRENT function (4041) is active (= ON).</p> <p>Use this function to define a freely selectable value (e.g. 12 mA) to be output at the current output. This value is used to test downstream devices and the measuring device itself.</p> <p>User input: 0.00 to 25.00 mA</p> <p>Factory setting: 0.00 mA</p> <p> Caution! The setting is not saved if the power supply fails.</p>

6.1.3 Function group INFORMATION

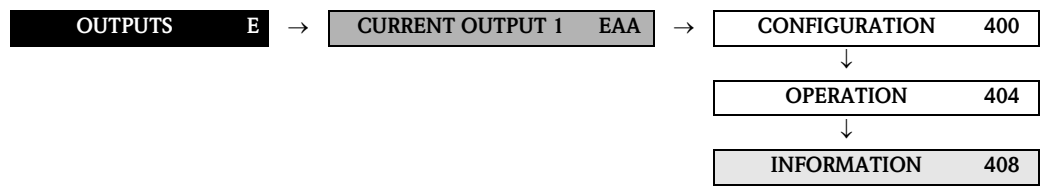





Function description	
OUTPUTS → CURRENT OUTPUT 1 → INFORMATION (only with PROFIBUS DP)	
TERMINAL NUMBER (4080)	<p>Use this function to display the numbers of the terminals (in the connection compartment) which are used by the current output.</p> <p>User interface: 20 (+) / 21 (-)</p>

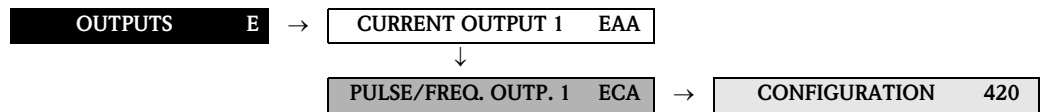



6.2 Group PULSE/FREQUENCY OUTPUT 1

6.2.1 Function group CONFIGURATION



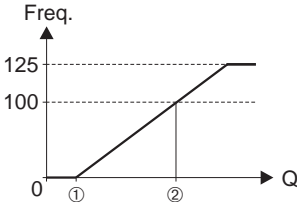

Function description	
OUTPUTS → PULSE/FREQUENCY OUTPUT 1 → CONFIGURATION, GENERAL/FREQ. (only with PROFIBUS DP)	
OPERATION MODE (4200)	<p>Use this function to configure the output as a pulse output, frequency output or status output. The functions available in this function group vary, depending on which option you select here.</p> <p>Options: PULSE FREQUENCY STATUS</p> <p>Factory setting: PULSE</p>
ASSIGN FREQUENCY (4201)	<p>Options: OFF VOLUME FLOW MASS FLOW CONDUCTIVITY (only with enabled conductivity → Page 99)</p> <p>Factory setting: VOLUME FLOW</p> <p>Advanced options with optional software package SOLID CONTENT FLOW: TARGET MASS FLOW % TARGET MASS FLOW TARGET VOLUME FLOW % TARGET VOLUME FLOW CARRIER MASS FLOW % CARRIER MASS FLOW CARRIER VOLUME FLOW % CARRIER VOLUME FLOW</p> <p>Advanced options with optional software package ADVANCED DIAGNOSTICS: DEVIATION COATING 1 (only with coating detection enabled → Page 116) DEVIATION COATING 2 (only with coating detection enabled → Page 116) DEVIATION ELECTRODE POTENTIAL 1 DEVIATION ELECTRODE POTENTIAL 2 DEVIATION VOLUME FLOW DEVIATION NOISE VALUE</p> <p> Note! If you select OFF, the only function shown in the CONFIGURATION function group is ASSIGN FREQUENCY (4201).</p>

Function description	
OUTPUTS → PULSE/FREQUENCY OUTPUT 1 → CONFIGURATION, FREQUENCY (only with PROFIBUS DP)	
START VALUE FREQUENCY (4202)	<p> Note! This function is not available unless the FREQUENCY setting was selected in the OPERATION MODE function (4200).</p> <p>Use this function to define an initial frequency for the frequency output. You define the associated measuring value of the measuring range in the VALUE-f LOW function (4204) described on Page 51.</p> <p>User input: 5-digit fixed-point number: 0 to 10000 Hz</p> <p>Factory setting: 0 Hz</p> <p>Example:</p> <ul style="list-style-type: none"> ■ VALUE-f LOW = 0 l/h, initial frequency = 0 Hz: i.e. a frequency of 0 Hz is output at a flow of 0 l/h. ■ VALUE-f LOW = 1 l/h, initial frequency = 10 Hz: i.e. a frequency of 10 Hz is output at a flow of 1 l/h.
END VALUE FREQUENCY (4203)	<p> Note! This function is not available unless the FREQUENCY setting was selected in the OPERATION MODE function (4200).</p> <p>Use this function to define a full scale frequency for the frequency output. You define the associated measuring value of the measuring range in the VALUE-f HIGH function (4205) described on Page 51.</p> <p>User input: 5-digit fixed-point number 2 to 10000 Hz</p> <p>Factory setting: 10000 Hz</p> <p>Example:</p> <ul style="list-style-type: none"> ■ VALUE-f HIGH = 1000 l/h, full scale value frequency = 1000 Hz: i.e. a frequency of 1000 Hz is output at a flow of 1000 l/h. ■ VALUE-f HIGH = 3600 l/h, full scale value frequency = 1000 Hz: i.e. a frequency of 1000 Hz is output at a flow of 3600 l/h. <p> Note! In the FREQUENCY operating mode the output signal is symmetrical (on/off ratio = 1:1). At low frequencies the pulse duration is limited to a maximum of 2 seconds, i.e. the on/off ratio is no longer symmetrical.</p>

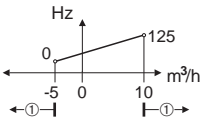
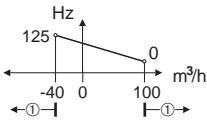
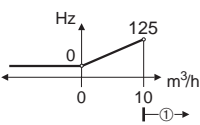
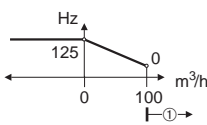
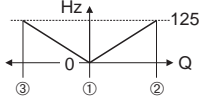
Function description	
OUTPUTS → PULSE/FREQUENCY OUTPUT 1 → CONFIGURATION, FREQUENCY (only with PROFIBUS DP)	
<p>VALUE-f LOW (4204)</p>	<p> Note! This function is not available unless the FREQUENCY setting was selected in the OPERATION MODE function (4200).</p> <p>Use this function to assign a variable to the start value frequency (4202). The value can be higher or lower than the value assigned to the VALUE-f HIGH. Positive and negative values are permissible, depending on the measured variable in question (e.g. volume flow). You define a measuring range by defining the VALUE-f LOW and VALUE-f HIGH values.</p> <p>User input: 5-digit floating-point number</p> <p>Factory setting: 0 [unit]</p> <p> Note!</p> <ul style="list-style-type: none"> ■ For graphic illustration of VALUE-f LOW see function VALUE-f HIGH. ■ The appropriate unit is taken from the function UNIT VOLUME FLOW (0402) or UNIT MASS FLOW (0400), (see Page 13 or Page 12).
<p>VALUE-f HIGH (4205)</p>	<p> Note! This function is not available unless the FREQUENCY setting was selected in the OPERATION MODE function (4200).</p> <p>Use this function to assign a variable to the end value frequency (4203). The value can be higher or lower than the value assigned to the VALUE-f LOW. Positive and negative values are permissible, depending on the measured variable in question (e.g. volume flow). You define a measuring range by defining the VALUE-f LOW and VALUE-f HIGH values.</p> <p>User input: 5-digit floating-point number</p> <p>Factory setting: Depends on nominal diameter and country (s. Page 132 ff.).</p> <p> Note! Note that values with different signs cannot be entered for VALUE-f LOW and VALUE-f HIGH, if SYMMETRY is the setting selected for the MEASURING MODE function (4206). In this case, the message "INPUT RANGE EXCEEDED" appears on the display.</p> <div style="text-align: center;">  </div> <p>① = Value-f low ② = Value-f high</p> <p style="text-align: right;">A0001279</p> <p>(continued on next page)</p>

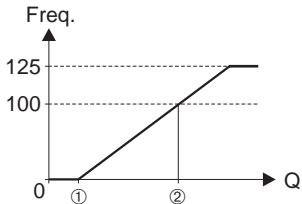
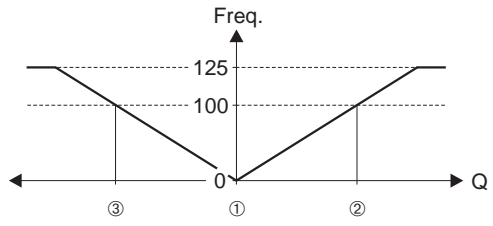
Function description	
OUTPUTS → PULSE/FREQUENCY OUTPUT 1 → CONFIGURATION, FREQUENCY (only with PROFIBUS DP)	
<p>VALUE-f HIGH (continued)</p>	<p>Parameter setting example 1:</p> <ol style="list-style-type: none"> VALUE-f LOW (4204) = not equal to zero flow (e.g. $-5 \text{ m}^3/\text{h}$) VALUE-f HIGH (4205) = not equal to zero flow (e.g. $10 \text{ m}^3/\text{h}$) VALUE-f LOW (4204) = not equal to zero flow (e.g. $100 \text{ m}^3/\text{h}$) VALUE-f HIGH (4205) = not equal to zero flow (e.g. $-40 \text{ m}^3/\text{h}$) and MEASURING MODE (4004) = STANDARD <p>When you enter the values for VALUE-f LOW and VALUE-f HIGH the working range of the measuring device is defined. If the effective flow drops below or exceeds this working range (see ①), a fault or notice message is generated (#355-358, frequency area) and the frequency output responds in accordance with the parameter settings in the function FAILSAFE MODE (4209).</p> <div style="display: flex; justify-content: space-around;">   </div> <p style="text-align: right; font-size: small;">A0001276</p> <p>Parameter setting example 2:</p> <ol style="list-style-type: none"> VALUE-f LOW (4204) = not equal to zero flow (e.g. $0 \text{ m}^3/\text{h}$) VALUE-f HIGH (4205) = not equal to zero flow (e.g. $10 \text{ m}^3/\text{h}$) VALUE-f LOW (4204) = not equal to zero flow (e.g. $100 \text{ m}^3/\text{h}$) VALUE-f HIGH (4205) = not equal to zero flow (e.g. $0 \text{ m}^3/\text{h}$) and MEASURING MODE (4004) = STANDARD <p>When you enter the values for VALUE-f LOW and VALUE-f HIGH the working range of the measuring device is defined. In doing so, one of the two values is parameterized as zero flow (e.g. $0 \text{ m}^3/\text{h}$).</p> <p>If the effective flow drops below or exceeds the value configured as the zero flow, no fault/notice message is generated and the frequency output retains its value.</p> <p>If the effective flow drops below or exceeds the other value, a fault/notice message is generated (#355-358, frequency area) and the frequency output responds in accordance with the parameters set in the function FAILSAFE MODE (4209).</p> <div style="display: flex; justify-content: space-around;">   </div> <p style="text-align: right; font-size: small;">A0001277</p> <p>Deliberately only one flow direction is output with this setting and flow values in the other flow direction are suppressed.</p> <p>Parameter setting example 3: MEASURING MODE (4206) = SYMMETRY</p> <p>The frequency output signal is independent of the direction of flow (absolute amount of the measured variable). The VALUE-f LOW ① and VALUE-f HIGH ② must have the same sign (+ or -). The "VALUE-f HIGH" ③ (e.g. backflow) corresponds to the mirrored VALUE-f HIGH ② (e.g. flow).</p> <div style="text-align: center;">  </div> <p style="text-align: right; font-size: small;">A0001278</p> <p>ASSIGN RELAY (4700) = FLOW DIRECTION With this setting e.g. the flow direction output via a switching contact can be made.</p> <p>Parameter setting example 4: MEASURING MODE (4004) = PULSATING FLOWS. Page 43</p>

Function description	
OUTPUTS → PULSE/FREQUENCY OUTPUT 1 → CONFIGURATION, FREQUENCY (only with PROFIBUS DP)	
<p>MEASURING MODE (4206)</p>	<p> Note! This function is not available unless the FREQUENCY setting was selected in the OPERATION MODE function (4200).</p> <p>Use this function to define the measuring mode for the frequency output.</p> <p>Options: STANDARD SYMMETRY PULSATING FLOW</p> <p>Factory setting STANDARD</p> <p>Description of the individual options:</p> <ul style="list-style-type: none"> ■ STANDARD The frequency output signal is proportional to the measured variable. The flow components outside the scaled measuring range (defined by the VALUE-f LOW. ① and VALUE-f HIGH. ②) are not taken into account for signal output. <ul style="list-style-type: none"> – If one of the values is defined as equal to the zero flow (e.g. VALUE-f LOW = 0 m³/h), no message is given if this value is exceeded or not achieved and the frequency output retains its value (0 Hz in the example). If the other value is exceeded or not achieved, the message "FREQUENCY OUTPUT AT FULL SCALE VALUE" appears and the frequency output responds in accordance with the parameter setting in the function FAILSAFE MODE (4209). – If both values defined are not equal to the zero flow (for example VALUE-f LOW = -5 m³/h; VALUE-f HIGH = 10m³/h), the message "FREQUENCY OUTPUT AT FULL SCALE VALUE" appears if the measuring range is exceeded or not achieved and the frequency output responds in accordance with the parameter setting in the function FAILSAFE MODE (4209). <div style="text-align: center;">  </div> <p style="text-align: right; font-size: small;">A0001279</p> <ul style="list-style-type: none"> ■ SYMMETRY The frequency output signal is independent of the direction of flow (absolute amount of the measured variable). The VALUE-f LOW ① VALUE-f HIGH②and must have the same sign (+ or -). The VALUE-f HIGH ③ (e.g. backflow) corresponds to the mirrored VALUE-f HIGH ② (e.g. forward flow). <div style="text-align: center;">  </div> <p style="text-align: right; font-size: small;">A0001280</p> <p> Note!</p> <ul style="list-style-type: none"> ■ The direction of flow can be output via the configurable relay or status outputs. ■ SYMMETRY cannot be selected unless the values in the VALUE-f LOW (4204) and VALUE-f HIGH (4205) functions have the same sign or one of the values is zero. If the values have different signs, SYMMETRY cannot be selected and an "ASSIGNMENT NOT POSSIBLE" message is displayed. <p style="text-align: center;">(continued on next page)</p>

Function description	
OUTPUTS → PULSE/FREQUENCY OUTPUT 1 → CONFIGURATION, FREQUENCY (only with PROFIBUS DP)	
MEASURING MODE (continued)	<ul style="list-style-type: none">■ PULSATING FLOW If flow is characterized by severe fluctuations as is the case, for example, with reciprocating pumps, flow components outside the measuring range are buffered, balanced and output after a maximum delay of 60 seconds. If the buffered data cannot be processed within approx. 60 seconds, a fault/notice message appears. Under certain plant conditions, flow values can aggregate in the buffer, for example in the case of prolonged and unwanted fluid backflow. However, this buffer is reset in all relevant programming adjustments which affect the frequency output.

Function description OUTPUTS → PULSE/FREQUENCY OUTPUT 1 → CONFIGURATION, FREQUENCY (only with PROFIBUS DP)	
OUTPUT SIGNAL (4207)	<p>Note! Function is not available unless the FREQUENCY setting was selected in the OPERATION MODE function (4200). For selecting the output configuration of the frequency output.</p> <p>Options: PASSIVE - POSITIVE PASSIVE - NEGATIVE ACTIVE - POSITIVE ACTIVE - NEGATIVE</p> <p>Factory setting: PASSIVE - POSITIVE</p> <p>Explanation</p> <ul style="list-style-type: none"> ■ PASSIVE = power is supplied to the frequency output by means of an external power supply. ■ ACTIVE = power is supplied to the frequency output by means of the device-internal power supply. <p>Configuring the output signal level (POSITIVE or NEGATIVE) determines the quiescent behavior (at zero flow) of the frequency output. The internal transistor is activated as follows:</p> <ul style="list-style-type: none"> ■ If POSITIVE is selected, the internal transistor is activated with a positive signal level. ■ If NEGATIVE is selected, the internal transistor is activated with a negative signal level (0 V). <p>Note! With the passive output configuration, the output signal levels of the frequency output depend on the external circuit (see examples).</p> <p>Example for passive output circuit (PASSIVE) If PASSIVE is selected, the frequency output is configured as an open collector.</p> <div style="text-align: center;"> </div> <p style="text-align: right; font-size: small;">A0001225</p> <p>① = Open Collector ② = External power supply</p> <p>Note! For continuous currents up to 25 mA ($I_{max} = 250 \text{ mA} / 20 \text{ ms}$).</p> <p>Example for output configuration PASSIVE-POSITIVE: Output configuration with an external pull-up resistance. In the quiescent state (at zero flow), the output signal level at the terminals is 0 V.</p> <div style="text-align: center;"> </div> <p style="text-align: right; font-size: small;">A0004687</p> <p>① = Open Collector ② = Pull-Up-Resistance ③ = Transistor activation in "POSITIVE" quiescent state (at zero flow) ④ = Output signal level in quiescent state (at zero flow)</p> <p>In the operating status (flow present), the output signal level changes from 0 V to a positive voltage level.</p> <div style="text-align: center;"> </div> <p style="text-align: right; font-size: small;">A0001975</p> <p>(continued on next page)</p>

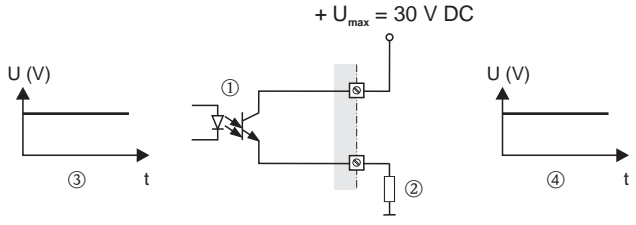
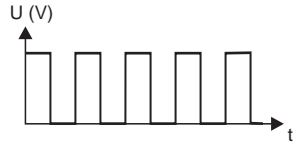
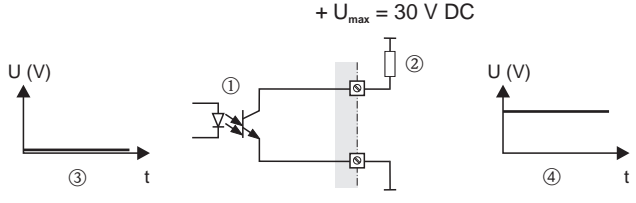
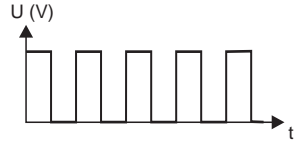
Function description	
OUTPUTS → PULSE/FREQUENCY OUTPUT 1 → CONFIGURATION, FREQUENCY (only with PROFIBUS DP)	
OUTPUT SIGNAL (continued)	<p>Example for output configuration PASSIVE-POSITIVE: Output configuration with an external pull-down resistance. In the quiescent state (at zero flow), a positive voltage level is measured via the pull-down resistance.</p>  <p>① = Open Collector ② = Pull-Down-Resistance ③ = Transistor activation in "POSITIVE" quiescent state (at zero flow) ④ = Output signal level in quiescent state (at zero flow)</p> <p>In the operating status (flow present), the output signal level changes from a positive voltage level to 0 V.</p>  <p style="text-align: right;">A0004689</p> <p>Example for output configuration PASSIVE-NEGATIVE: Output configuration with an external pull-up resistance. In the quiescent state (at zero flow), the output signal level at the terminals is at a positive voltage level.</p>  <p>① = Open Collector ② = Pull-Up-Resistance ③ = Transistor activation in "NEGATIVE" quiescent state (at zero flow) ④ = Output signal level in quiescent state (at zero flow)</p> <p>In the operating status (flow present), the output signal level changes from a positive voltage level to 0 V.</p>  <p style="text-align: right;">A0004690</p> <p style="text-align: right;">A0001981</p> <p style="text-align: right;">A0001981</p> <p>(continued on next page)</p>

Function description	
OUTPUTS → PULSE/FREQUENCY OUTPUT 1 → CONFIGURATION, FREQUENCY (only with PROFIBUS DP)	
<p>OUTPUT SIGNAL (continued)</p>	<p>Example for active output circuit (ACTIVE): With an active circuit, the internal power supply is 24 V. The frequency output is short-circuit proof.</p> <div style="text-align: center;"> </div> <p>① = 24 V DC internal power supply ② = Short-circuit proof output</p> <p>The signal levels are to be seen as analogous to the passive circuit.</p> <p>The following applies for the output configuration ACTIVE-POSITIVE: In the quiescent state (at zero flow), the output signal level at the terminals is 0 V.</p> <div style="text-align: center;"> </div> <p>In the operating status (flow present), the output signal level changes from 0 V to a positive voltage level.</p> <div style="text-align: center;"> </div> <p>The following applies for the output configuration ACTIVE-NEGATIVE: In the quiescent state (at zero flow), the output signal level at the terminals is at a positive voltage level.</p> <div style="text-align: center;"> </div> <p>In the operating status (flow present), the output signal level changes from a positive voltage level to 0 V.</p> <div style="text-align: center;"> </div>



A0004691





A0004694



A0004692



A0004493



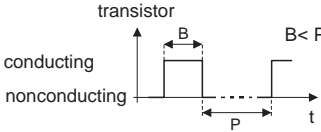
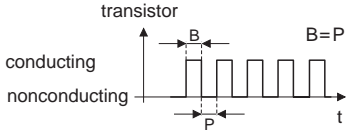

A0004710

Function description	
OUTPUTS → PULSE/FREQUENCY OUTPUT 1 → CONFIGURATION, FREQUENCY (only with PROFIBUS DP)	
TIME CONSTANT (4208)	<p> Note! This function is not available unless the FREQUENCY setting was selected in the OPERATION MODE function (4200).</p> <p>Use this function to enter a time constant defining how the frequency output signal reacts to severely fluctuating measured variables, either very quickly (enter a low time constant) or with damping (enter a high time constant).</p> <p>User input: fixed-point number 0.00 to 100.00 s</p> <p>Factory setting: 0.005 s</p>
FAILSAFE MODE (4209)	<p> Note! This function is not available unless the FREQUENCY setting was selected in the OPERATION MODE function (4200).</p> <p>For safety reasons it is advisable to ensure that the frequency output assumes a predefined state in the event of a fault. The setting you select here affects only the frequency output. It has no effect on other outputs and the display (e.g. totalizers).</p> <p>Options:</p> <p>FALL BACK VALUE Output is 0 Hz.</p> <p>FAILSAFE VALUE Output is the frequency specified in the FAILSAFE VALUE function (4211).</p> <p>HOLD VALUE Measuring value output is based on the last measuring value saved before the error occurred.</p> <p>ACTUAL VALUE Measuring value output is based on the current flow measurement. The fault is ignored.</p> <p>Factory setting: FALL BACK VALUE</p>
FAILSAFE VALUE (4211)	<p> Note! This function is not available unless FREQUENCY was selected in the OPERATION MODE function (4200) and FAILSAFE VALUE was selected in the FAILSAFE MODE function (4209).</p> <p>Use this function to define the frequency that the measuring device outputs in the event of an error.</p> <p>User input: max. 5-digit number: 0 to 12500 Hz</p> <p>Factory setting: 12500 Hz</p>

Function description	
OUTPUTS → PULSE/FREQUENCY OUTPUT 1 → CONFIGURATION, PULSE (only with PROFIBUS DP)	
ASSIGN PULSE (4221)	<p> Note! This function is not available unless the PULSE setting was selected in the OPERATION MODE function (4200).</p> <p>Use this function to assign a measured variable to the pulse output.</p> <p>Options: OFF VOLUME FLOW MASS FLOW</p> <p>Factory setting: VOLUME FLOW</p> <p>Advanced options with optional software package SOLID CONTENT FLOW: TARGET MASS FLOW TARGET VOLUME FLOW CARRIER MASS FLOW CARRIER VOLUME FLOW</p> <p> Note! If you select OFF, the only function shown in the CONFIGURATION function group is ASSIGN PULSE (4221).</p>
PULSE VALUE (4222)	<p> Note! This function is not available unless the PULSE setting was selected in the OPERATION MODE function (4200).</p> <p>Use this function to define the flow at which a pulse is triggered. These pulses can be totaled by an external totalizer, and the total flow quantity since measuring started can be registered in this way.</p> <p>User input: 5-digit floating-point number [unit]</p> <p>Factory setting: Depends on nominal diameter and country (s. Page 132 ff.).</p> <p> Note! The appropriate unit is taken from the function UNIT VOLUME (0403) or UNIT MASS (0401), (see Page 13 or Page 12).</p>

Function description	
OUTPUTS → PULSE/FREQUENCY OUTPUT 1 → CONFIGURATION, PULSE (only with PROFIBUS DP)	
PULSE WIDTH (4223)	<p> Note! This function is not available unless the PULSE setting was selected in the OPERATION MODE function (4200).</p> <p>Use this function to enter the pulse width of the output pulse.</p> <p>User input: 0.05 to 2000 ms</p> <p>Factory setting: 100 ms</p> <p>Pulse output is always with the pulse width (B) entered in this function. The pauses (P) between the individual pulses are automatically configured. However, they must at least correspond to the pulse width ($B = P$).</p> <div style="display: flex; justify-content: space-around;"> <div style="text-align: center;"> <p>transistor</p>  </div> <div style="text-align: center;"> <p>transistor</p>  </div> </div> <p style="text-align: right; font-size: small;">A0001233</p> <p>B = Pulse width entered (the illustration applies to positive pulses) P = Intervals between the individual pulses</p> <p> Note! When entering the pulse width, select a value that can still be processed by an external totalizer (e.g. mechanical totalizer, PLC, etc.).</p> <p> Caution! If the pulse number or frequency resulting from the pulse value entered, (see function PULSE VALUE (4222) on Page 59) and from the current flow is too large to maintain the pulse width selected (the interval P is smaller than the pulse width B entered), a system error message (# 359 to 362, pulse memory) is generated after buffering/balancing has occurred.</p>

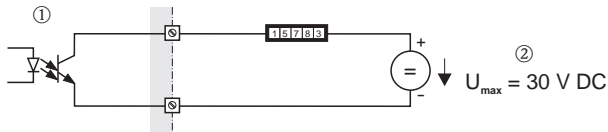
Function description	
OUTPUTS → PULSE/FREQUENCY OUTPUT 1 → CONFIGURATION, PULSE (only with PROFIBUS DP)	
MEASURING MODE (4225)	<p> Note! This function is not available unless the PULSE setting was selected in the OPERATION MODE function (4200).</p> <p>Use this function to define the measuring mode for the pulse output.</p> <p>Options: STANDARD Only positive flow components are totalled. Negative components are not taken into account.</p> <p>SYMMETRY Positive and negative flow components are taken into account.</p> <p> Note! The direction of flow can be output via the relay output.</p> <p>PULSATING FLOW If flow is characterized by severe fluctuations as is the case, for example, with reciprocating pumps, the positive and negative flow components are totalled, with the signs taken into account (e.g. -10 l and $+25\text{ l} = 15\text{ l}$). Flow components outside the maximum pulse number per second (value/width) are buffered, balanced and output after a maximum delay of 60 seconds. If the buffered data cannot be processed within approx. 60 seconds, a fault/notice message appears. Under certain plant conditions, flow values can aggregate in the buffer, for example in the case of prolonged and unwanted fluid backflow. However, this buffer is reset in all relevant programming adjustments which affect the pulse output.</p> <p>STANDARD REVERSE Only negative flow components are totalled. Positive components are not taken into account.</p> <p>Factory setting: STANDARD</p>

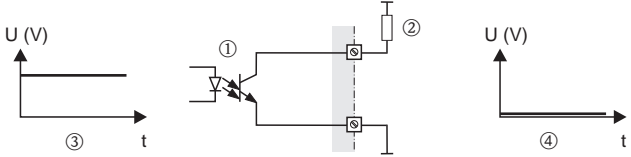
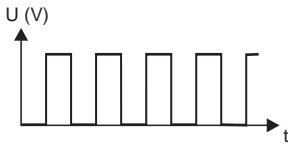
Function description	
OUTPUTS → PULSE/FREQUENCY OUTPUT 1 → CONFIGURATION, PULSE (only with PROFIBUS DP)	
<p>OUTPUT SIGNAL (4226)</p>	<p> Note! Function is not available unless the PULSE setting was selected in the OPERATION MODE (4200) function.</p> <p>For selecting the output configuration of the pulse output.</p> <p>Options: PASSIVE - POSITIVE PASSIVE - NEGATIVE ACTIVE - POSITIVE ACTIVE - NEGATIVE</p> <p>Factory setting: PASSIVE - POSITIVE</p> <p>Explanation</p> <ul style="list-style-type: none"> ■ PASSIVE = power is supplied to the pulse output by means of an external power supply. ■ ACTIVE = power is supplied to the pulse output by means of the device-internal power supply. <p>Configuring the output signal level (POSITIVE or NEGATIVE) determines the quiescent behavior (at zero flow) of the pulse output. The internal transistor is activated as follows:</p> <ul style="list-style-type: none"> ■ If POSITIVE is selected, the internal transistor is activated with a positive signal level. ■ If NEGATIVE is selected, the internal transistor is activated with a negative signal level (0 V). <p> Note! With the passive output configuration, the output signal levels of the pulse output depend on the external circuit (see examples).</p> <p>Example for passive output circuit (PASSIVE) If PASSIVE is selected, the pulse output is configured as an open collector.</p>  <p style="text-align: right;">A0001225</p> <p>① = Open Collector ② = External power supply</p> <p> Note! For continuous currents up to 25 mA ($I_{max} = 250 \text{ mA} / 20 \text{ ms}$).</p> <p>Example for output configuration PASSIVE-POSITIVE: Output configuration with an external pull-up resistance. In the quiescent state (at zero flow), the output signal level at the terminals is 0 V.</p> <p style="text-align: center;">+ $U_{max} = 30 \text{ V DC}$</p>  <p style="text-align: right;">A0004687</p> <p>① = Open Collector ② = Pull-Up-Resistance ③ = Transistor activation in "POSITIVE" quiescent state (at zero flow) ④ = Output signal level in quiescent state (at zero flow)</p> <p>In the operating status (flow present), the output signal level changes from 0 V to a positive voltage level.</p>  <p style="text-align: right;">A0001975</p> <p>(continued on next page)</p>

Function description	
OUTPUTS → PULSE/FREQUENCY OUTPUT 1 → CONFIGURATION, PULSE (only with PROFIBUS DP)	
<p>OUTPUT SIGNAL (continued)</p>	<p>Example for output configuration PASSIVE-POSITIVE: Output configuration with an external pull-down resistance. In the quiescent state (at zero flow), a positive voltage level is measured via the pull-down resistance.</p> <div style="text-align: center;"> </div> <p>① = Open Collector ② = Pull-Down-Resistance ③ = Transistor activation in "POSITIVE" quiescent state (at zero flow) ④ = Output signal level in quiescent state (at zero flow)</p> <p>In the operating status (flow present), the output signal level changes from a positive voltage level to 0 V.</p> <div style="text-align: center;"> </div> <p style="text-align: right;">A0004689</p> <p>Example for output configuration PASSIVE-NEGATIVE: Output configuration with an external pull-up resistance. In the quiescent state (at zero flow), the output signal level at the terminals is at a positive voltage level.</p> <div style="text-align: center;"> </div> <p>① = Open Collector ② = Pull-Up-Resistance ③ = Transistor activation in "NEGATIVE" quiescent state (at zero flow) ④ = Output signal level in quiescent state (at zero flow)</p> <p>In the operating status (flow present), the output signal level changes from a positive voltage level to 0 V.</p> <div style="text-align: center;"> </div> <p style="text-align: right;">A0004690</p> <p style="text-align: right;">A0001981</p> <p style="text-align: right;">A0001981</p> <p>(continued on next page)</p>

Function description	
OUTPUTS → PULSE/FREQUENCY OUTPUT 1 → CONFIGURATION, PULSE (only with PROFIBUS DP)	
<p>OUTPUT SIGNAL (continued)</p>	<p>Example for active output circuit (ACTIVE): With an active circuit, the internal power supply is 24 V. The pulse output is short-circuit proof.</p> <div style="text-align: center;"> </div> <p>① = 24 V DC internal power supply ② = Short-circuit proof output</p> <p>The signal levels are to be seen as analogous to the passive circuit.</p> <p>The following applies for the output configuration ACTIVE-POSITIVE: In the quiescent state (at zero flow), the output signal level at the terminals is 0 V.</p> <div style="text-align: center;"> </div> <p>In the operating status (flow present), the output signal level changes from 0 V to a positive voltage level.</p> <div style="text-align: center;"> </div> <p>The following applies for the output configuration ACTIVE-NEGATIVE: In the quiescent state (at zero flow), the output signal level at the terminals is at a positive voltage level.</p> <div style="text-align: center;"> </div> <p>In the operating status (flow present), the output signal level changes from a positive voltage level to 0 V.</p> <div style="text-align: center;"> </div>

A0004691



A0004694





A0004692





A0004693

A0004710

Function description	
OUTPUTS → PULSE/FREQUENCY OUTPUT 1 → CONFIGURATION, PULSE (only with PROFIBUS DP)	
FAILSAFE MODE (4227)	<p> Note! This function is not available unless the PULSE setting was selected in the OPERATION MODE function (4200).</p> <p>For safety reasons it is advisable to ensure that the pulse output assumes a predefined state in the event of a fault. The setting you select here affects only the pulse output. It has no effect on other outputs and the display (e.g. totalizers).</p> <p>Options: FALL BACK VALUE Output is 0 pulse.</p> <p>ACTUAL VALUE Measuring value output is based on the current flow measurement. The fault is ignored.</p> <p>Factory setting: FALL BACK VALUE</p>

Function description	
OUTPUTS → PULSE/FREQUENCY OUTPUT 1 → CONFIGURATION, STATUS (only with PROFIBUS DP)	
ASSIGN STATUS (4241)	<p> Note! This function is not available unless the STATUS setting was selected in the OPERATION MODE function (4200).</p> <p>Use this function to assign a switching function to the status output.</p> <p>Options: OFF ON (operation) FAULT MESSAGE NOTICE MESSAGE FAULT MESSAGE or NOTICE MESSAGE EPD (Empty pipe detection, if active) FLOW DIRECTION MASS FLOW LIMIT VALUE VOLUME FLOW LIMIT VALUE LIMIT VALUE TOTALIZER (1 to 3) LIMIT VALUE CONDUCTIVITY (only with enabled conductivity → Page 99)</p> <p>Advanced options with optional software package SOLID CONTENT FLOW: LIMIT VALUE TARGET MASS FLOW LIMIT VALUE % TARGET MASS FLOW LIMIT VALUE TARGET VOLUME FLOW LIMIT VALUE % TARGET VOLUME FLOW LIMIT VALUE CARRIER MASS FLOW LIMIT VALUE % CARRIER MASS FLOW LIMIT VALUE CARRIER VOLUME FLOW LIMIT VALUE % CARRIER VOLUME FLOW</p> <p>Advanced options with optional software package ADVANCED DIAGNOSTICS: LIMIT COATING DEVIATION E1* LIMIT COATING DEVIATION E2* LIMIT ELECTRODE POTENTIAL DEVIATION 1 LIMIT ELECTRODE POTENTIAL DEVIATION 2 LIMIT VOLUME FLOW DEVIATION LIMIT NOISE VALUE DEVIATION * only with coating detection enabled → Page 116</p> <p>Factory setting: FAULT MESSAGE</p> <p> Note!</p> <ul style="list-style-type: none"> ■ The behavior of the status output is a normally closed behavior, in other words the output is closed (transistor conductive) when normal, error-free measuring is in progress. <ul style="list-style-type: none"> – The following apply as "normal, error-free" measurements: Flow direction = forward; limit values = not exceeded; no empty or partially filled measuring tube (EPD/OED); no fault or notice message present. – For switching behavior such as relay output, s. Page 81 ■ If you select OFF, the only function shown in the CONFIGURATION function group is this function, in other words ASSIGN STATUS (4241).

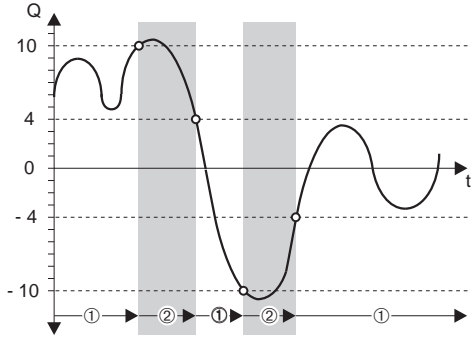





Function description	
OUTPUTS → PULSE/FREQUENCY OUTPUT 1 → CONFIGURATION, STATUS (only with PROFIBUS DP)	
ON-VALUE (4242)	<p> Note! This function is not available unless STATUS was selected in the OPERATION MODE function (4200) and LIMIT VALUE or FLOW DIRECTION was selected in the ASSIGN STATUS function (4241).</p> <p>Use this function to assign a value to the switch-on point (activation of the status output). The value can be equal to, higher than or lower than the switch-off point. Positive or negative values are permissible, depending on the measured variable in question (e.g. volume flow).</p> <p>User input: 5-digit floating-point number [unit]</p> <p>Factory setting: 0 [unit]</p> <p> Note!</p> <ul style="list-style-type: none"> ■ The appropriate unit is taken from the function UNIT VOLUME FLOW (0402) or UNIT MASS FLOW (0400). ■ Only the switch-on point is available for flow direction output (no switch-off point). If you enter a value not equal to the zero flow (e.g. 5), the difference between the zero flow and the value entered corresponds to half the switching hysteresis.
SWITCH-ON DELAY (4243)	<p> Note! This function is not available unless STATUS was selected in the OPERATION MODE function (4200) and LIMIT VALUE or FLOW DIRECTION was selected in the ASSIGN STATUS function (4241).</p> <p>Use this function to specify a delay (0 to 100 seconds) for switching on the status output (i.e. signal changes from 0 to 1). The delay starts when the limit value is reached. The status output does switch when the delay has timed out and the switch-on condition has been valid over the delay time.</p> <p>User input: fixed-point number: 0.0 to 100.0 s</p> <p>Factory setting: 0.0 s</p>
OFF-VALUE (4244)	<p> Note! This function is not available unless STATUS was selected in the OPERATION MODE function (4200) and a LIMIT VALUE was selected in the ASSIGN STATUS function (4241).</p> <p>Use this function to assign a value to the switch-off point (deactivation of the status output). The value can be equal to, higher than or lower than the switch-on point. Positive and negative values are permissible, depending on the measured variable in question (e.g. volume flow).</p> <p>User input: 5-digit floating-point number [unit]</p> <p>Factory setting: 0 [unit]</p> <p> Note!</p> <ul style="list-style-type: none"> ■ The appropriate unit is taken from the function UNIT VOLUME FLOW (0402) or UNIT MASS FLOW (0400). ■ If SYMMETRY is selected in the function MEASURING MODE (4246) and values with different signs are entered for the switch-on and switch-off points, the notice message "INPUT RANGE EXCEEDED" appears.

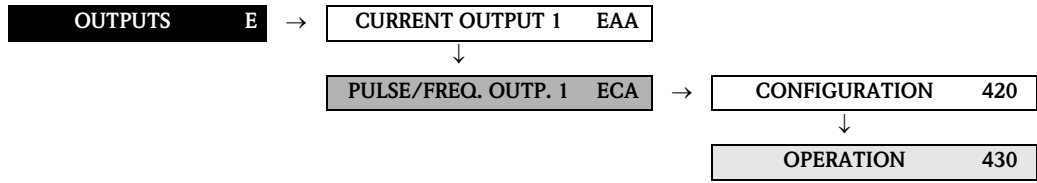









Function description	
OUTPUTS → PULSE/FREQUENCY OUTPUT 1 → CONFIGURATION, STATUS (only with PROFIBUS DP)	
SWITCH-OFF DELAY (4245)	<p> Note! This function is not available unless the STATUS setting was selected in the OPERATION MODE function (4200).</p> <p>Use this function to define a delay (0 to 100 seconds) for switching off the status output (i.e. signal changes from 1 to 0). The delay starts when the limit value is reached. The status output does switch when the delay has timed out and the switch condition has been valid over the delay time.</p> <p>User input: fixed-point number 0.0 to 100.0 s</p> <p>Factory setting: 0.0 s</p>
MEASURING MODE (4246)	<p> Note! This function is not available unless STATUS was selected in the OPERATION MODE function(4200) and the status output was assigned a limit value.</p> <p>Use this function to define the measuring mode for the status output.</p> <p>Options: STANDARD The status output signal switches at the defined switch points.</p> <p>SYMMETRY The status output signal switches at the defined switch points, irrespective of the sign. If you define a switch point with a positive sign, the status output signal switches as soon as the value is reached in the negative direction (negative sign), (see illustration).</p> <p>Factory setting: STANDARD</p> <p>Example for the SYMMETRY measuring mode: Switch-on point $Q = 4$, switch-off point: $Q = 10$ ① = Status output switched on (conductive) ② = Status output switched off (nonconductive)</p>  <p style="text-align: right;">A0001247</p> <p> Note!</p> <ul style="list-style-type: none"> ■ SYMMETRY cannot be selected unless the values in the ON-VALUE (4242) and OFF-VALUE (4244) functions have the same sign or one of the values is zero. ■ If the values have different signs, SYMMETRY cannot be selected and an "ASSIGNMENT NOT POSSIBLE" message is displayed.







Function description	
OUTPUTS → PULSE/FREQUENCY OUTPUT 1 → CONFIGURATION, STATUS (only with PROFIBUS DP)	
TIME CONSTANT (4247)	<p> Note! This function is not available unless the STATUS setting was selected in the OPERATION MODE function (4200).</p> <p>Use this function to enter a time constant defining how the measuring signal reacts to severely fluctuating measured variables, either very quickly (enter a low time constant) or with damping (enter a high time constant). Damping acts on the measuring signal before the switch status changes, and consequently before switch-on or switch-off delay is activated. The purpose of damping, therefore, is to prevent the status output changing state continuously in response to fluctuations in flow.</p> <p>User input: fixed-point number 0.00 to 100.00 s</p> <p>Factory setting: 0.00 s</p>

6.2.2 Function group OPERATION



Function description	
OUTPUTS → PULSE/FREQUENCY OUTPUT 1 → OPERATION, FREQUENCY (only with PROFIBUS DP)	
ACTUAL FREQUENCY (4301)	<p> Note! This function is not available unless the FREQUENCY setting was selected in the OPERATION MODE function (4200).</p> <p>Use this function to view the computed value of the output frequency.</p> <p>User interface: 0 to 12500 Hz</p>
SIMULATION FREQUENCY (4302)	<p> Note! This function is not available unless the FREQUENCY setting was selected in the OPERATION MODE function (4200).</p> <p>Use this function to activate simulation of the frequency output.</p> <p>Options: OFF ON</p> <p>Factory setting: OFF</p> <p> Note!</p> <ul style="list-style-type: none"> ■ The "SIMULATION FREQUENCY OUTPUT" message indicates that simulation is active. ■ The measuring device continues to measure while simulation is in progress, i.e. the current measured values are output correctly via the other outputs. <p> Caution! The setting is not saved if the power supply fails.</p>
VALUE SIMULATION FREQUENCY (4303)	<p> Note! This function is not available unless FREQUENCY was selected in the OPERATION MODE function (4200) and the SIMULATION FREQUENCY function (4302) is active (= ON).</p> <p>Use this function to define a selectable frequency value (e.g. 500 Hz) to be output at the frequency output. This value is used to test downstream devices and the measuring device itself.</p> <p>User input: 0 to 12500 Hz</p> <p>Factory setting: 0 Hz</p> <p> Caution! The setting is not saved if the power supply fails.</p>

Function description	
OUTPUTS → PULSE/FREQUENCY OUTPUT 1 → OPERATION, PULSE (only with PROFIBUS DP)	
SIMULATION PULSE (4322)	<p> Note! This function is not available unless the PULSE option was selected in the OPERATION MODE function.</p> <p>Use this function to activate simulation of the pulse output.</p> <p>Options: OFF COUNTDOWN The pulses specified in the VALUE SIMULATION PULSE function are output.</p> <p>CONTINUOUSLY Pulses are continuously output with the pulse width specified in the PULSE WIDTH function. Simulation is started once the CONTINUOUSLY option is confirmed with the  key.</p> <p> Note! Simulation is started by confirming the CONTINUOUSLY option with the  key. The simulation can be switched off again via the SIMULATION PULSE function.</p> <p>Factory setting: OFF</p> <p> Note!</p> <ul style="list-style-type: none"> ■ The notice message #631 "SIM. PULSE" indicates that simulation is active. ■ The on/off ratio is 1:1 for both types of simulation. ■ The measuring device continues to measure while simulation is in progress, i.e. the current measured values are output correctly via the other outputs. <p> Caution! The setting is not saved if the power supply fails.</p>
VALUE SIMULATION PULSE (4323)	<p> Note! This function is not available unless the COUNTDOWN option was selected in the SIMULATION PULSE function.</p> <p>Use this function to specify the number of pulses (e.g. 50) which are output during the simulation. This value is used to test downstream devices and the measuring device itself. The pulses are output with the pulse width specified in the PULSE WIDTH function. The on/off ratio is 1:1.</p> <p>Simulation is started once the specified value is confirmed with the  key. The display remains at 0 if the specified pulses have been output.</p> <p>User input: 0 to 10 000</p> <p>Factory setting: 0</p> <p> Note! Simulation is started by confirming the simulation value with the  key. The simulation can be switched off again via the SIMULATION PULSE function.</p> <p> Caution! The setting is not saved if the power supply fails.</p>

Function description	
OUTPUTS → PULSE/FREQUENCY OUTPUT 1 → OPERATION, PULSE (only with PROFIBUS DP)	
ACTUAL STATUS (4341)	<p> Note! This function is not available unless the STATUS setting was selected in the OPERATION MODE function (4200).</p> <p>Use this function to check the current status of the status output.</p> <p>User interface: NOT CONDUCTIVE CONDUCTIVE</p>
SIMULATION SWITCH POINT (4343)	<p> Note! This function is not available unless the STATUS setting was selected in the OPERATION MODE function (4200).</p> <p>Use this function to activate simulation of the status output.</p> <p>Options: OFF ON</p> <p>Factory setting: OFF</p> <p> Note!</p> <ul style="list-style-type: none"> ■ The "SIMULATION STATUS OUTPUT" message indicates that simulation is active. ■ The measuring device continues to measure while simulation is in progress, i.e. the current measured values are output correctly via the other outputs. <p> Caution! The setting is not saved if the power supply fails.</p>
VALUE SIMULATION SWITCH POINT (4343)	<p> Note! This function is not available unless STATUS was selected in the OPERATION MODE function (4200) and the SIMULATION SWITCH POINT function (4342) is active (= ON).</p> <p>Use this function to define the switching response of the status output during the simulation. This value is used to test downstream devices and the measuring device itself.</p> <p>Options: NOT CONDUCTIVE CONDUCTIVE</p> <p>Factory setting: NOT CONDUCTIVE</p> <p> Caution! The setting is not saved if the power supply fails.</p>

6.2.3 Function group INFORMATION

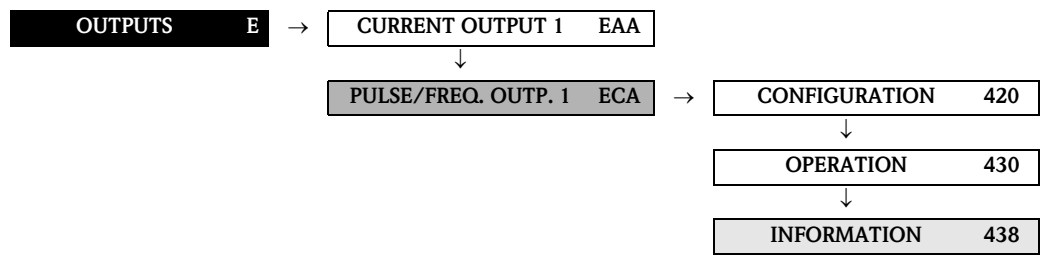





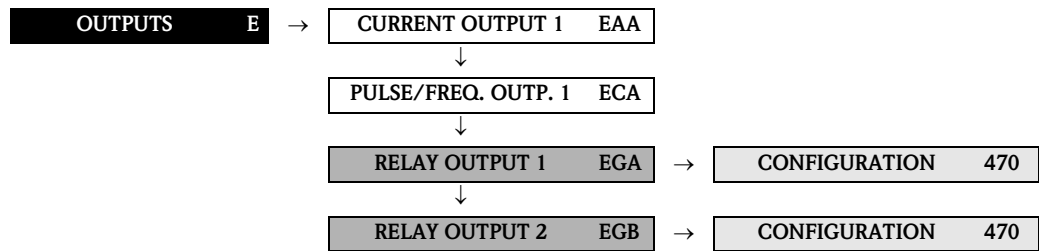

Function description	
OUTPUTS → PULSE/FREQUENCY OUTPUT 1 → INFORMATION (only with PROFIBUS DP)	
TERMINAL NUMBER (4380)	<p>Use this function to display the numbers of the terminals (in the connection compartment) which are used by the pulse/frequency output.</p> <p>User interface: 22 (+) / 23 (-)</p>





6.3 Group RELAY OUTPUT (1 to 2)

6.3.1 Function group CONFIGURATION



Function description	
OUTPUTS → RELAY OUTPUT (1 to 2) → CONFIGURATION (only with PROFIBUS DP)	
ASSIGN RELAY (4700)	<p>Use this function to assign a switching function to the relay output.</p> <p>Options: OFF ON (operation) FAULT MESSAGE NOTICE MESSAGE FAULT MESSAGE or NOTICE MESSAGE EPD (Empty pipe detection, if active) FLOW DIRECTION MASS FLOW LIMIT VALUE VOLUME FLOW LIMIT VALUE LIMIT VALUE TOTALIZER (1 to 3) LIMIT VALUE CONDUCTIVITY (only with enabled conductivity → Page 99)</p> <p>Factory setting: FAULT MESSAGE</p> <p>Advanced options with optional software package SOLID CONTENT FLOW: LIMIT VALUE TARGET MASS FLOW LIMIT VALUE % TARGET MASS FLOW LIMIT VALUE TARGET VOLUME FLOW LIMIT VALUE % TARGET VOLUME FLOW LIMIT VALUE CARRIER MASS FLOW LIMIT VALUE % CARRIER MASS FLOW LIMIT VALUE CARRIER VOLUME FLOW LIMIT VALUE % CARRIER VOLUME FLOW</p> <p>Advanced options with optional software package ADVANCED DIAGNOSTICS: LIMIT COATING DEVIATION E1* LIMIT COATING DEVIATION E2* LIMIT ELECTRODE POTENTIAL DEVIATION 1 LIMIT ELECTRODE POTENTIAL DEVIATION 2 LIMIT VOLUME FLOW DEVIATION LIMIT NOISE VALUE DEVIATION * only with coating detection enabled → Page 116</p> <p> Note!</p> <ul style="list-style-type: none"> ■ It is very important to read and comply with the information on the switching characteristics of the relay output (see Page 81). ■ It is advisable to configure at least one relay output as a fault output and define the outputs' response to error. ■ Relay output 1 is configured as a normally open (NO or make) contact and relay output 2 as a normally closed (NC or break) contact by default. It can be reconfigured by means of a jumper on the relay module (see Operating Instructions Promag 55 PROFIBUS DP/PA, BA124D). ■ If you select OFF, the only function shown in the CONFIGURATION function group is this function (4700).

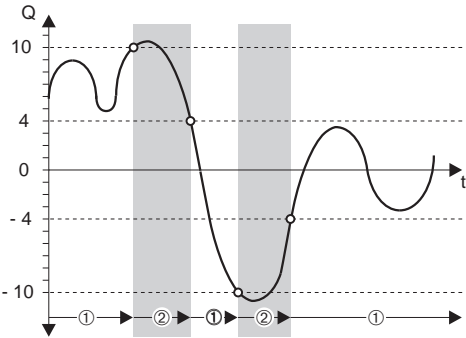

Function description	
OUTPUTS → RELAY OUTPUT (1 to 2) → CONFIGURATION (only with PROFIBUS DP)	
ON-VALUE (4701)	<p> Note! This function is not available unless LIMIT VALUE or FLOW DIRECTION was selected in the function ASSIGN RELAY (4700).</p> <p>Use this function to assign a value to the switch-on point (relay output pulls up). The value can be equal to, higher than or lower than the switch-off point. Positive or negative values are permissible, depending on the measured variable in question (e.g. volume flow).</p> <p>User input: 5-digit floating-point number [unit]</p> <p>Factory setting: 0 [unit]</p> <p> Note!</p> <ul style="list-style-type: none"> ■ The appropriate unit is taken from the function UNIT VOLUME FLOW (0402) or UNIT MASS FLOW (0400). ■ Only the switch-on point is available for flow direction output (no switch-off point). If you enter a value not equal to the zero flow (e.g. 5), the difference between the zero flow and the value entered corresponds to half the switching hysteresis.
SWITCH-ON DELAY (4702)	<p> Note! This function is not available unless LIMIT VALUE or FLOW DIRECTION was selected in the function ASSIGN RELAY (4700).</p> <p>Use this function to define a delay (0 to 100 seconds) for pull-up (i.e. signal changes from 0 to 1) of the relay output. The delay starts when the limit value is reached. The relay output does switch when the delay has timed out and the switch condition has been valid throughout the delay time.</p> <p>User input: fixed-point number 0.0 to 100.0 s</p> <p>Factory setting: 0.0 s</p>
OFF-VALUE (4703)	<p> Note! This function is not available unless LIMIT VALUE was selected in the ASSIGN RELAY function (4700).</p> <p>Use this function to assign a value to the switch-off point (relay drops out). The value can be equal to, higher than or lower than the switch-on point. Positive or negative values are permissible, depending on the measured variable in question (e.g. volume flow).</p> <p>User input: 5-digit floating-point number [unit]</p> <p>Factory setting: 0 [unit]</p> <p> Note!</p> <ul style="list-style-type: none"> ■ The appropriate unit is taken from the function UNIT VOLUME FLOW (0402) or UNIT MASS FLOW (0400). ■ If SYMMETRY is selected in the function MEASURING MODE (4705) and values with different signs are entered for the switch-on and switch-off points, the notice message "INPUT RANGE EXCEEDED" appears.

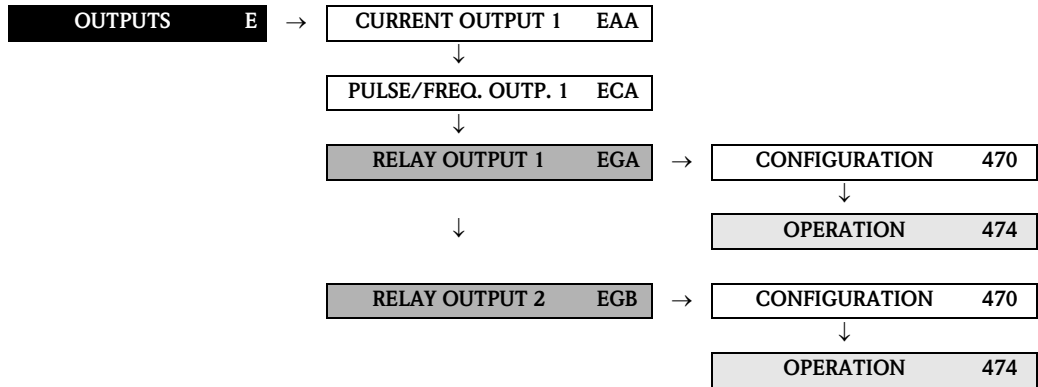

Function description OUTPUTS → RELAY OUTPUT (1 to 2) → CONFIGURATION (only with PROFIBUS DP)	
SWITCH-OFF DELAY (4704)	<p> Note! This function is not available unless LIMIT VALUE was selected in the ASSIGN RELAY function (4700).</p> <p>Use this function to define a delay (0 to 100 seconds) for dropout (i.e. signal changes from 1 to 0) of the relay output. The delay starts when the limit value is reached. The relay output does switch when the delay has timed out and the switch condition has been valid throughout the delay time.</p> <p>User input: fixed-point number 0.0 to 100.0 s</p> <p>Factory setting: 0.0 s</p>
MEASURING MODE (4705)	<p> Note! This function is not visible unless a limit value was assigned to the relay output.</p> <p>Use this function to define the measuring mode for the relay output.</p> <p>Options: STANDARD The relay output signal switches at the defined switch points.</p> <p>SYMMETRY The relay output signal switches at the defined switch points, irrespective of the sign. If you define a switch point with a positive sign, the relay output switches as soon as the value is reached in the negative direction (negative sign), (see illustration).</p> <p>Factory setting: STANDARD</p> <p>Example for the SYMMETRY measuring mode: Switch-on point Q = 4 Switch-off point Q = 10 ① = Relay energized ② = Relay de-energized</p>  <p style="text-align: right;">A0001247</p> <p> Note!</p> <ul style="list-style-type: none"> ■ SYMMETRY cannot be selected unless the values in the ON-VALUE (4701) and OFF-VALUE (4703) functions have the same sign or one of the values is zero. ■ If the values have different signs, SYMMETRY cannot be selected and an "ASSIGNMENT NOT POSSIBLE" message is displayed.

Function description	
OUTPUTS → RELAY OUTPUT (1 to 2) → CONFIGURATION (only with PROFIBUS DP)	
TIME CONSTANT (4706)	<p>Use this function to enter a time constant defining how the measuring signal reacts to severely fluctuating measured variables, either very quickly (enter a low time constant) or with damping (enter a high time constant). Damping acts on the measuring signal before the switch status changes, and consequently before switch-on or switch-off delay is activated. The purpose of damping, therefore, is to prevent the relay output changing state continuously in response to fluctuations in flow.</p> <p>User input: fixed-point number 0.00 to 100.00 s</p> <p>Factory setting: 0.00 s</p>

6.3.2 Function group OPERATION



Function description	
OUTPUTS → RELAY OUTPUT (1 to 2) → OPERATION (only with PROFIBUS DP)	
ACTUAL STATUS RELAY (4740)	<p>Use this function to check the current status of the relay output.</p> <p>A jumper on the contact side defines the relay output as a normally open (NO or make) or normally closed (NC or break) contact (see Operating Instructions Promag 55 PROFIBUS DP/PA, BA124D).</p> <p>User interface: BREAK CONTACT OPEN BREAK CONTACT CLOSED MAKE CONTACT OPEN MAKE CONTACT CLOSED</p>
SIMULATION SWITCH POINT (4741)	<p>Use this function to activate simulation of the relay output.</p> <p>Options: OFF ON</p> <p>Factory setting: OFF</p> <p> Note!</p> <ul style="list-style-type: none"> ■ The "SIMULATION RELAY" message indicates that simulation is active. ■ The measuring device continues to measure while simulation is in progress, i.e. the current measured values are output correctly via the other outputs. <p> Caution! The setting is not saved if the power supply fails.</p>

Function description	
OUTPUTS → RELAY OUTPUT (1 to 2) → OPERATION (only with PROFIBUS DP)	
VALUE SIMULATION SWITCH POINT (4742)	<p> Note! The function is not visible unless the SIMULATION SWITCH POINT function (4741) is active (= ON).</p> <p>Use this function to define the status of the relay output during the simulation. This value is used to test downstream devices and the measuring device itself. Depending on the relay configuration (as make or break contact) the following selections are available.</p> <p>Select Relay output configured as normally open (make) contact: BREAK CONTACT OPEN BREAK CONTACT CLOSED</p> <p>Relay output configured as normally closed (break) contact: MAKE CONTACT OPEN MAKE CONTACT CLOSED</p> <p> Caution! The setting is not saved if the power supply fails.</p>

6.3.3 Function group INFORMATION

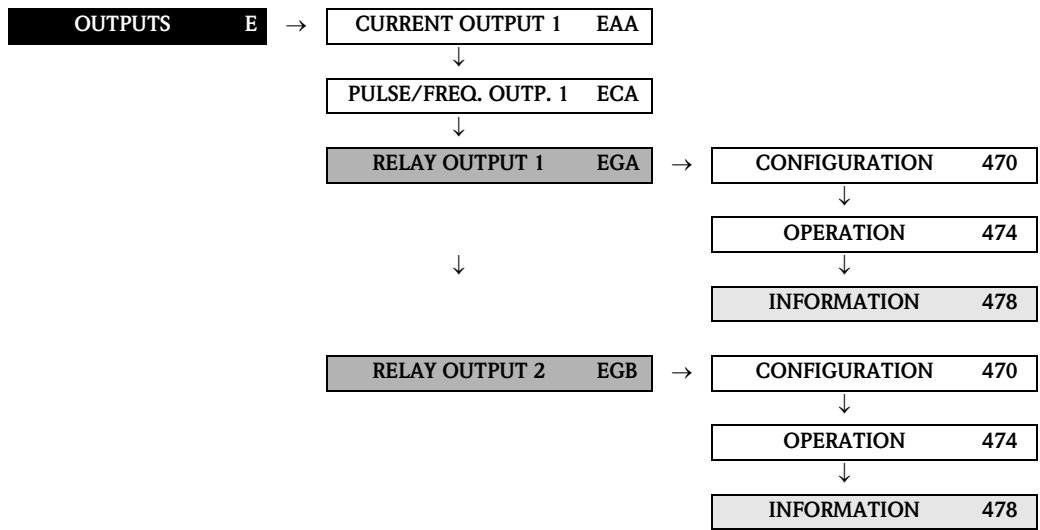

Function description	
OUTPUTS → RELAY OUTPUT (1 to 2) → INFORMATION (only with PROFIBUS DP)	
TERMINAL NUMBER (4780)	<p>Use this function to display the numbers of the terminals (in the connection compartment) which are used by the relay output.</p> <p>User interface: 22 (+) / 23 (-) → RELAY OUTPUT 1 20 (+) / 21 (-) → RELAY OUTPUT 2</p>

6.3.4 Information on the response of the relay output

General

If you have configured the relay output signal for "LIMIT VALUE" or "FLOW DIRECTION", you can define the requisite switch points in the ON-VALUE and OFF-VALUE functions. When the measured variable in question reaches one of these predefined values, the relay output switches as shown in the illustrations below.

Relay output configured for "limit value"

The relay output signal switches as soon as the measured variable undershoots or overshoots a defined switch point.

Application: Monitoring flow or process-related boundary conditions.

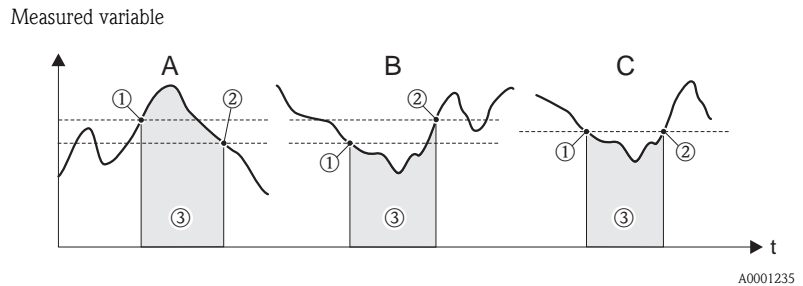

- A = Maximum safety → ① SWITCH-OFF POINT > ② SWITCH-ON POINT
- B = Minimum safety → ① SWITCH-OFF POINT < ② SWITCH-ON POINT
- C = Minimum safety → ① SWITCH-OFF POINT = ② SWITCH-ON POINT (this configuration is to avoid)
- ③ = Relay de-energized

Relay output configured for "flow direction"

The value you entered in the function ON-VALUE defines the switch point for the positive and negative directions of flow.



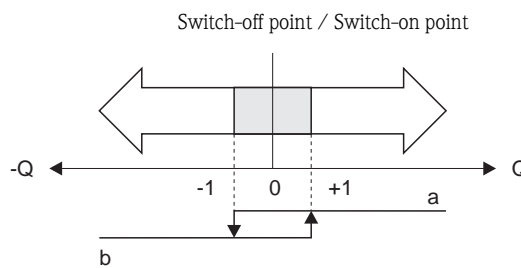







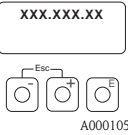
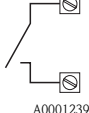
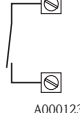

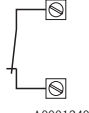
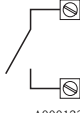
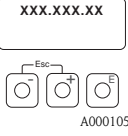
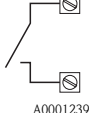
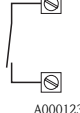

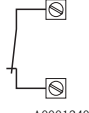

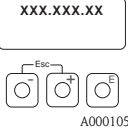
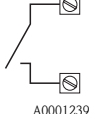
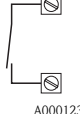

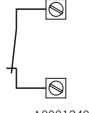
If, for example, the switch point you define is = 1 m³/h, the relay drops out at -1 m³/h and pulls up at +1 m³/h. Set the switch point to 0 if your process calls for direct switchover (no switching hysteresis). If low flow cut off is used, it is advisable to set hysteresis to a value higher than or equal to the low flow cut off rate.

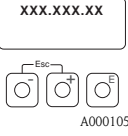
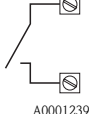
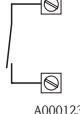

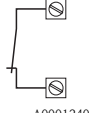

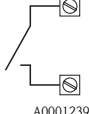
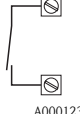

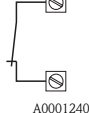





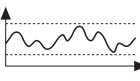

- a = Relay energized
- b = Relay de-energized

A0001236

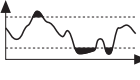
6.3.5 Switching response of the relay output

Function	State	Relay coil	Contact*	
			NC	NO
ON (operation)	System in measuring mode	 energized A0001052		
	System not in measuring mode (power supply failed)	 deenergized A0001291		
Fault message	System OK	 energized A0001052		
	(System or process error) Fault → Response to error Outputs /Inputs	 deenergized A0001291		
Notice message	System OK	 energized A0001052		
	(System or process error) Fault → Continuation of measuring	 deenergized A0001291		
Fault message or Notice message	System OK	 energized A0001052		
	(System or process error) Fault → Response to error or Note → Continuation of measuring	 de-energized A0001291		
Empty pipe detection (EPD) / Open electrode detection (OED)	Measuring tube full	 energized A0001292		
	Measuring tube partially filled /empty measuring tube	 deenergized A0001293		

Function	State	Relay coil	Contact*		
			NC	NO	
Flow direction	Forward	 A0001241	energized		
	Reverse	 A0001242	deenergized		
Limit value – Volume flow	Limit value not overshoot or undershot	 A0001243	energized		
	Limit value overshoot or undershot	 A0001244	deenergized		
<p>* Terminal numbers in accordance with the TERMINAL NUMBER function (4780) on Page 80.</p> <p> Note! If the measuring device has two relays, the factory setting is:</p> <ul style="list-style-type: none"> ■ Relay 1 → normally open contact (NO) ■ Relay 2 → normally closed contact (NC) <p> Caution! When using the optional software package BATCHING, it is advisable for the contacts (either normally open or normally closed contacts) to have the same switching response for all relay outputs used.</p>					

7 Block INPUTS



Note!

This block is not available for all devices → Page 8 (Available blocks, groups, etc.).

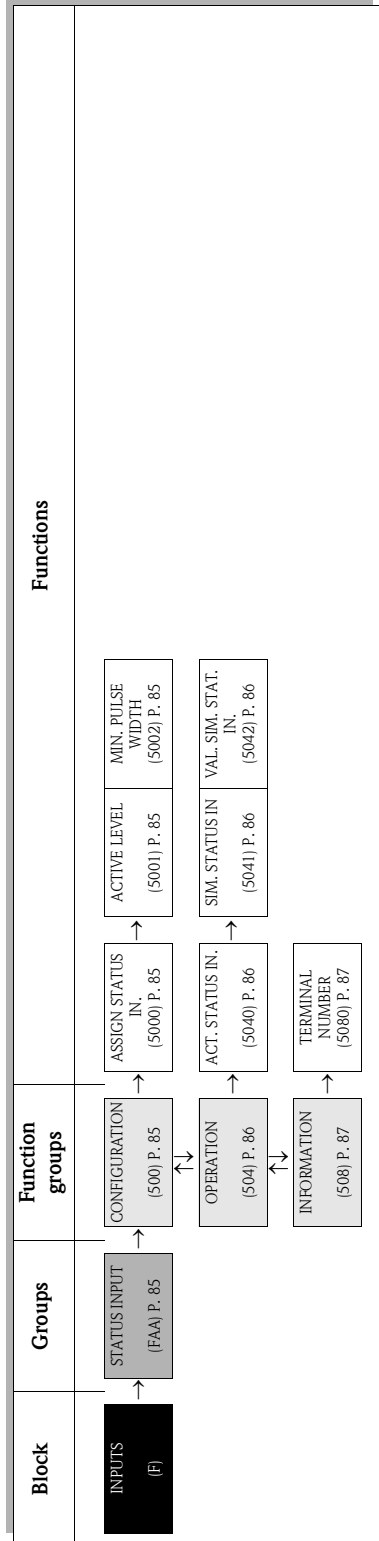

7.1 Group STATUS INPUT





7.1.1 Function group CONFIGURATION

INPUTS	F	→	STATUS INPUT	FAA	→	CONFIGURATION	500
--------	---	---	--------------	-----	---	---------------	-----

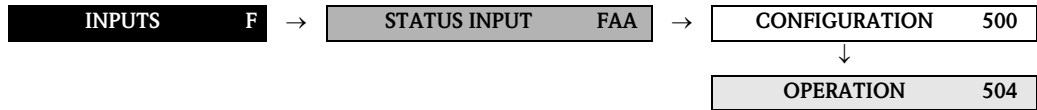
Function description	
INPUTS → STATUS INPUT → CONFIGURATION (only with PROFIBUS DP)	
ASSIGN STATUS INPUT (5000)	<p>Use this function to assign a switching function to the status input.</p> <p>Options: OFF RESET TOTALIZER (1 to 3) RESET ALL TOTALIZERS PRESSURE SHOCK SUPPRESSION RESET FAULT MESSAGE</p> <p>Factory setting: OFF</p> <p> Caution! Positive zero return is active as long as the level is available at the status input (continuous signal). All other assignments react to a change in level (pulse) at the status input.</p>
ACTIVE LEVEL (5001)	<p>Use this function to define whether the assigned switch function is released or sustained when the signal level is present (HIGH) or not present (LOW).</p> <p>Options: HIGH LOW</p> <p>Factory setting: HIGH</p>
MINIMUM PULSE WIDTH (5002)	<p>Use this function to define a minimum pulse width which the input pulse must achieve in order to trigger the selected switching function (see ASSIGN STATUS INPUT function (5000)).</p> <p>User input: 20 to 100 ms</p> <p>Factory setting: 50 ms</p>

7.1.2 Function group OPERATION



Function description INPUTS → STATUS INPUT → OPERATION (only with PROFIBUS DP)	
ACTUAL STATUS INPUT (5040)	<p>Use this function to view the current level of the status input.</p> <p>User interface: HIGH LOW</p>
SIMULATION STATUS INPUT (5041)	<p>Use this function to simulate the status input, i.e. to trigger the function (see function ASSIGN STATUS INPUT (5000) on page 85) assigned to the status input.</p> <p>Options: OFF ON</p> <p>Factory setting: OFF</p> <p> Note!</p> <ul style="list-style-type: none"> ■ The "SIMULATION STATUS OUTPUT" message indicates that simulation is active. ■ The measuring device continues to measure while simulation is in progress, i.e. the current measured values are output correctly via the other outputs. <p> Caution! The setting is not saved if the power supply fails.</p>
VALUE SIMULATION STATUS INPUT (5042)	<p> Note! The function is not visible unless the SIMULATION STATUS INPUT function (5041) is active (= ON).</p> <p>Use this function to define the level to be assumed at the status output during the simulation. This value is used to test downstream devices and the measuring device itself.</p> <p>Options: HIGH LOW</p> <p>Factory setting: LOW</p> <p> Caution! The setting is not saved if the power supply fails.</p>

7.1.3 Function group INFORMATION

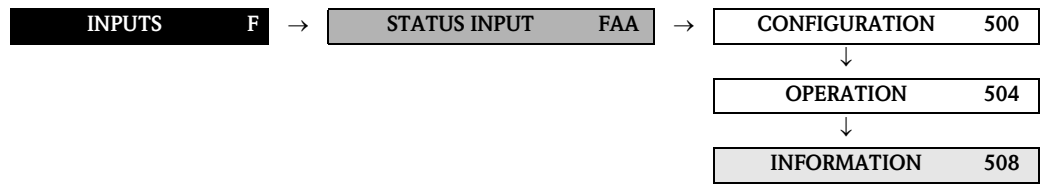

Function description	
INPUTS → STATUS INPUT → INFORMATION (only with PROFIBUS DP)	
TERMINAL NUMBER (5080)	<p>Use this function to display the numbers of the terminals (in the connection compartment) which are used by the status input.</p> <p>User interface: 24 (+) / 25 (-)</p>

8 Block BASIC FUNCTION

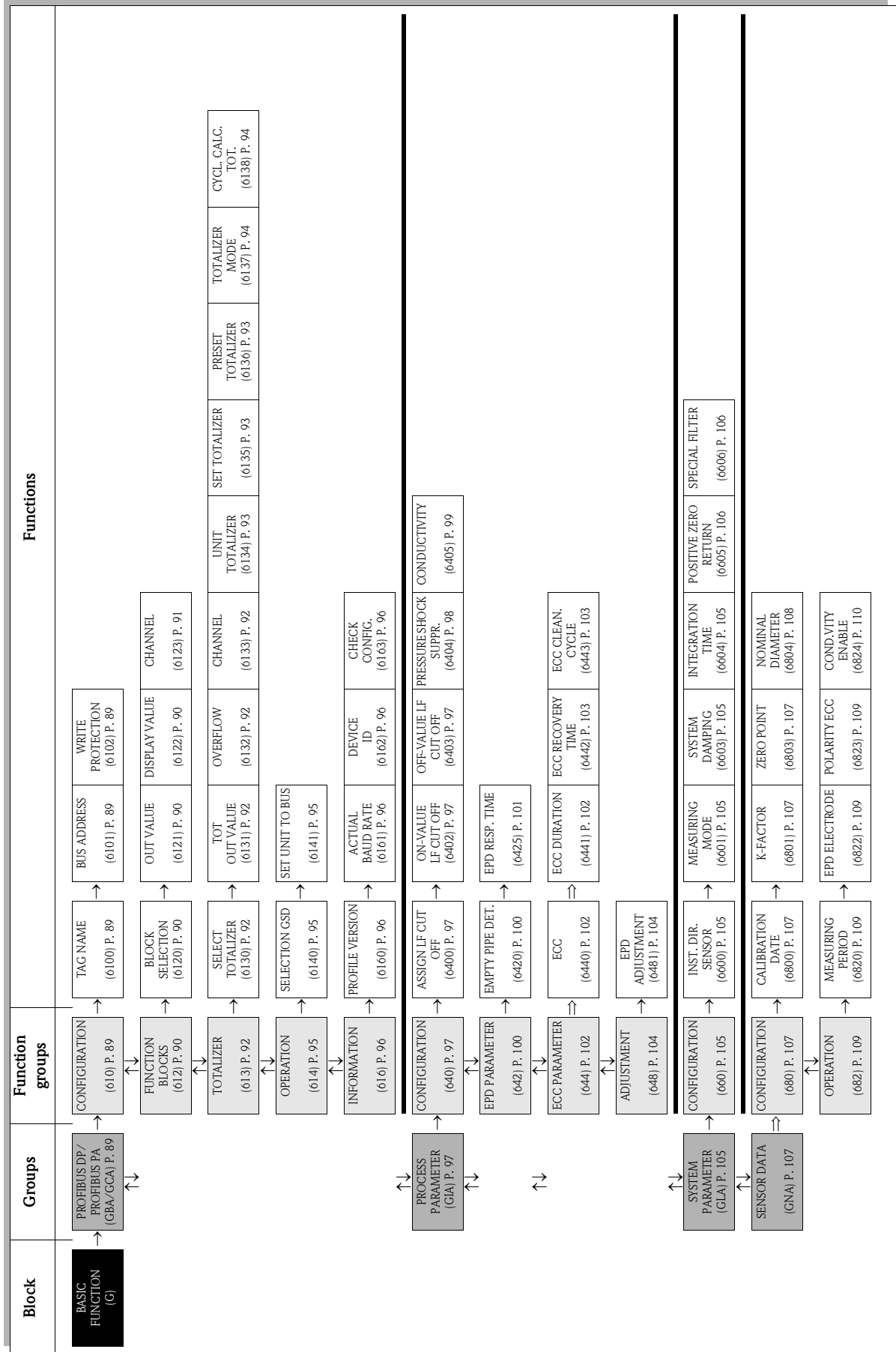

8.1 Group PROFIBUS DP/PA

8.1.1 Function group CONFIGURATION

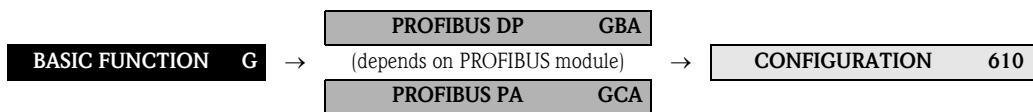

Function description BASIC FUNCTION → PROFIBUS DP/PROFIBUS PA → CONFIGURATION	
TAG NAME (6100)	<p>For entering a tag name for the measuring device. You can edit and read this tag name at the local display or by means of an operating program (e.g. FieldCare).</p> <p>User input: max. 16-character text, permissible: A-Z, 0-9, +,-, punctuation marks</p> <p>Factory setting: "-----" (no text)</p>
FIELD BUS ADDRESS (6101)	<p>For entering the device address.</p> <p>User input: 1 to 126</p> <p>Factory setting: 126</p>
WRITE PROTECT (6102)	<p>Indicates whether it is possible to write-access the device via PROFIBUS (acyclic data transmission, e.g. via FieldCare).</p> <p>User interface: OFF → Write access via PROFIBUS (acyclic data transmission) possible ON → Write access via PROFIBUS (acyclic data transmission) disabled</p> <p>Factory setting: OFF</p> <p> Note! Hardware write protection is activated and deactivated by means of a jumper on the I/O module (see Operating Instructions Promag 55 PROFIBUS PA).</p>

8.1.2 Function group FUNCTION BLOCKS

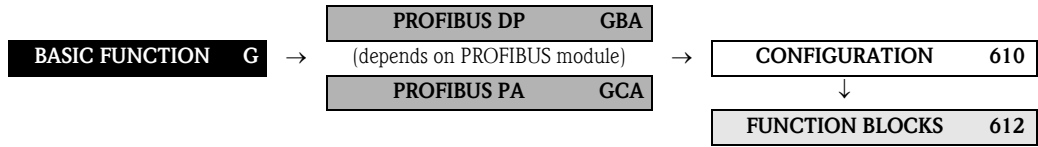

Function description	
BASIC FUNCTION → PROFIBUS DP/PROFIBUS PA → FUNCTION BLOCKS	
BLOCK SELECTION (6120)	<p>For selecting the PROFIBUS function block. If you select the Analog Input, the current measured value is displayed in the OUT VALUE (6121) function. If the analog output is selected, the current measured value is displayed in the DISPLAY VALUE function (6122).</p> <p>Options: ANALOG INPUT 1 ANALOG INPUT 2 ANALOG OUTPUT 1</p> <p>Factory setting: ANALOG INPUT 1</p> <p> Note! If PROFILE-GSD was selected in the SELECTION GSD (6140) function, only the selection appears in this function:</p> <ul style="list-style-type: none"> ■ ANALOG INPUT 1
OUT VALUE (6121)	<p> Note! This function is not available unless one of the following was selected in the BLOCK SELECTION (6120) function:</p> <ul style="list-style-type: none"> ■ ANALOG INPUT 1 ■ ANALOG INPUT 2 <p>This function shows the measured variable (AI module), incl. unit and status, cyclically transmitted to the PROFIBUS master (Class 1).</p>
DISPLAY VALUE (6122)	<p> Note! This function is not available unless the ANALOG OUTPUT 1 option was selected in the BLOCK SELECTION 6120 function.</p> <p>This function shows the measured variable (DISPLAY_VALUE module), incl. unit and status, cyclically transmitted from the PROFIBUS master (Class 1) to the measuring device.</p>

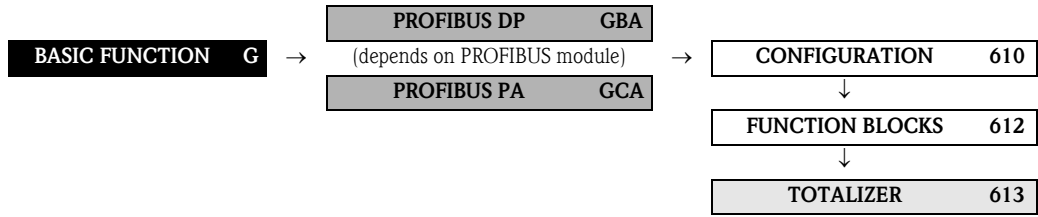

Function description	
BASIC FUNCTION → PROFIBUS DP/PROFIBUS PA → FUNCTION BLOCKS	
CHANNEL (6123)	<p> Note! This function is not available unless one of the following was selected in the BLOCK SELECTION (6120) function: – ANALOG INPUT 1 – ANALOG INPUT 2</p> <p>In this function, a measured variable is assigned to the respective analog input function block 1 to 2.</p> <p>Options: VOLUME FLOW MASS FLOW CONDUCTIVITY (only with enabled conductivity → Page 99)</p> <p>Factory setting: Dependent on the option selected in the BLOCK SELECTION (6120) function. For: ■ ANALOG INPUT 1 → Factory setting = VOLUME FLOW ■ ANALOG INPUT 2 → Factory setting = MASS FLOW</p> <p>Advanced options with optional software package SOLID CONTENT FLOW: TARGET MASS FLOW % TARGET MASS FLOW TARGET VOLUME FLOW % TARGET VOLUME FLOW CARRIER MASS FLOW % CARRIER MASS FLOW CARRIER VOLUME FLOW % CARRIER VOLUME FLOW</p> <p>Advanced options with optional software package ADVANCED DIAGNOSTICS: DEVIATION COATING 1 (only with coating detection enabled → Page 116) DEVIATION COATING 2 (only with coating detection enabled → Page 116) DEVIATION ELECTRODE POTENTIAL 1 DEVIATION ELECTRODE POTENTIAL 2 DEVIATION VOLUME FLOW DEVIATION NOISE VALUE</p>

8.1.3 Function group TOTALIZER







Function description BASIC FUNCTION → PROFIBUS DP / PROFIBUS PA → TOTALIZER	
SELECT TOTALIZER (6130)	<p>This function is used to select a totalizer.</p> <p>Options: TOTALIZER 1 TOTALIZER 2 TOTALIZER 3</p> <p>Factory setting: TOTALIZER 1</p> <p> Note! If the option PROFILE GSD was selected in the SELECTION GSD (6140) function the only option available in this function is TOTALIZER 1.</p>
<p> Note! The function descriptions below apply to totalizers 1 to 3; the totalizers are independently configurable.</p>	
TOTALIZER OUT VALUE (6131)	<p>Use this function to display the current totalizer value incl. unit and status.</p> <p>User interface: max. 7-digit floating-point number, including sign and unit (e.g. 15467.04 m³; -4925.631 kg)</p>
OVERFLOW (6132)	<p>Use this function to display the totalized overflow of the totalizer since measuring started.</p> <p>Total flow quantity is represented by a floating-point number consisting of max. 7 digits. In this function, larger numerical values (>9,999,999) can be read out as what are known as overflows. The effective quantity is thus the total of OVERFLOW plus the value returned by the TOTALIZER OUT VALUE (6131) function.</p> <p>Example: Reading for 2 overflows: 2 E7 (= 20000000). The value displayed in the TOTALIZER OUT VALUE (6131) function = 196845.7 m³ Effective total quantity = 20196845.7 m³</p> <p>User interface: integer with exponent, including sign and unit, e.g. 2 E7</p>
CHANNEL (6133)	<p>Use this function to assign a measured variable to the totalizer in question.</p> <p>Options: OFF MASS FLOW VOLUME FLOW</p> <p>Factory setting: VOLUME FLOW</p> <p>Advanced options with optional software package SOLID CONTENT FLOW: TARGET MASS FLOW TARGET VOLUME FLOW CARRIER MASS FLOW CARRIER VOLUME FLOW</p>

Function description	
BASIC FUNCTION → PROFIBUS DP/PROFIBUS PA → TOTALIZER	
UNIT TOTALIZER (6134)	<p>Use this function to define the unit for the totalizer. The selection is dependent on the measured variable selected in the CHANNEL (6133) function.</p> <p>Options: (for VOLUME FLOW assignment): Metric → cm³; dm³; m³; ml; l; hl; Ml Mega</p> <p>US → ccc; af; ft³; oz f; gal; Kgal; Mgal; bbl (normal fluids); bbl (beer); bbl (petrochemicals); bbl (filling tanks)</p> <p>Imperial → gal; Mgal; bbl (beer); bbl (petrochemicals)</p> <p>Factory setting: m³</p> <p>Options: (for MASS FLOW assignment): Metric → g; kg; t</p> <p>US → oz; lb; ton</p> <p>Factory setting: kg</p>
SET TOTALIZER (6135)	<p>Use this function to assign a status to the totalizer.</p> <p>Options: TOTALIZE The measured variable selected in the CHANNEL (6133) function is totalled.</p> <p>RESET Resets the totalizer to zero.</p> <p>PRESET The totalizer is set to the value defined in the function PRESET TOTALIZER (6136).</p> <p> Note! Note that selecting RESET or PRESET resets the totalizer to 0 or sets it to the preset value respectively, but does not stop the totalizer. This means that it immediately recommences totaling from the new setting. If you want to stop the totalizer you must select HOLD in the TOTALIZER MODE (6137) function.</p> <p>Factory setting: TOTALIZE</p>
PRESET TOTALIZER (6136)	<p>Use this function to define a start value for the totalizer.</p> <p>This value is not accepted by the totalizer unless the PRESET option has been selected in the SET TOTALIZER (6135) function.</p> <p>User input: -9999999 to 9999999</p> <p>Factory setting: 0</p>

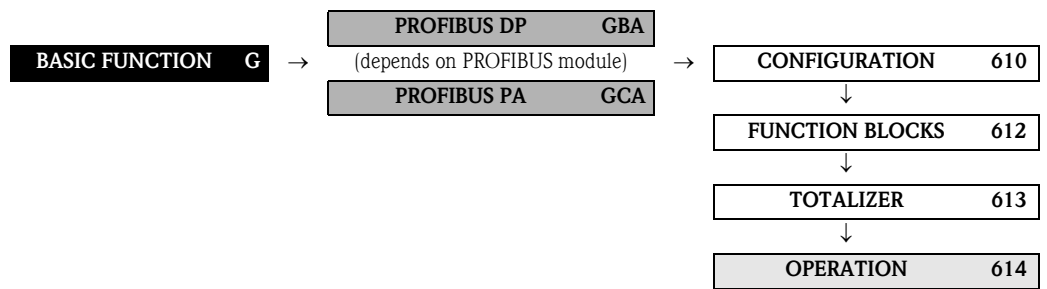
Function description BASIC FUNCTION → PROFIBUS DP/PROFIBUS PA → TOTALIZER	
TOTALIZER MODE (6137)	<p>Use this function to define how the flow components are to be totalled by the totalizer.</p> <p>Options: BALANCE Positive and negative flow components. The positive and negative flow components are balanced. In other words, net flow in the flow direction is registered.</p> <p>POSITIVE (forward) Positive flow components only</p> <p>NEGATIVE (backwards) Negative flow components only</p> <p>HOLD VALUE The totalizer stops at the last value. No further flow components are totaled.</p> <p>Factory setting: BALANCE</p> <p> Note! For the calculation of the positive and negative flow components (BALANCE) or the negative flow components only (NEGATIVE) to be carried out correctly, the BIDIRECTIONAL option must be selected in the MEASURING MODE function (6601) (s. Page 105).</p>
CYCL. CALC. TOT. (6138)	<p>Use this function to define whether the totalizers 1 to 3 are updated on the local display and in the operating program (e.g. FieldCare).</p> <p>Options: ON Totalizers are always updated.</p> <p>OFF Totalizers are only updated if the corresponding totalizer function block (TOTAL module or function) has been configured for cyclic data transmission.</p> <p>Factory setting: ON</p> <p> Note! Especially when conducting time-critical applications, optimization can be carried out for unnecessary totalizer function blocks. For this purpose, OFF must be selected in this function. When doing this, ensure that the totalizer is no longer updated on the local display and in the operating program (e.g. FieldCare) when selecting OFF.</p>

8.1.4 Function group OPERATION



Function description	
BASIC FUNCTION → PROFIBUS DP/PROFIBUS PA → OPERATION	
SELECTION GSD (6140)	<p>For selecting the operating mode (GSD file) which is used for the cyclic communication with the PROFIBUS master (Class 1).</p> <p>Options: MANUFACT. SPEC. → the device is operated with the complete range of device functionality. MANUFACT V2.0 → the device is used as a replacement device for the previous model Promag 35 (compatibility mode). PROFILE GSD → the device is operated in PROFIBUS Profile mode.</p> <p>Factory setting: MANUFACT. SPEC.</p> <p> Note! Ensure, when configuring the PROFIBUS network, that the dedicated Device Master File (GSD file) of the measuring device is used for the selected operating mode (see Operating Instructions Proline Promag 55 PROFIBUS PA).</p>
SET UNIT TO BUS (6141)	<p>If this function is executed, the cyclically transmitted measured variables (AI module) are transmitted to the PROFIBUS master (Class 1) with the system units set in the measuring device.</p> <p>Options: OFF SET UNITS (pressing the  button starts transmission)</p> <p> Caution! Activating this function may result in a sudden change in the measured variables (module AI) transferred to the PROFIBUS master (Class 1), which may in turn effect subsequent adjustments.</p>

8.1.5 Function group INFORMATION

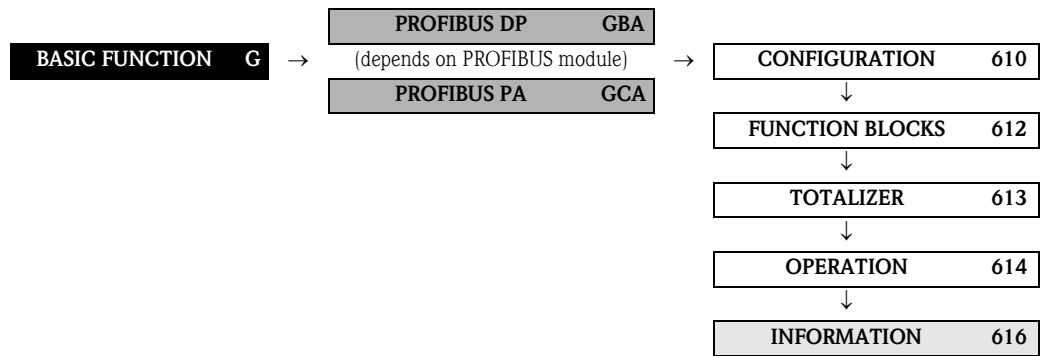



Function description BASIC FUNCTION → PROFIBUS DP/PROFIBUS PA → INFORMATION	
PROFILE VERSION (6160)	Use this function to view the PROFIBUS profile version.
ACTUAL BAUDRATE (6161)	Use this function to view the data transmission rate at which the device communicates.
DEVICE ID (6162)	<p>Use this function to view the PROFIBUS device ID.</p> <p>The display is dependent on the option selected in the SELECTION GSD (6140) function.</p> <p>User interface: If MANUFACT. SPEC. is selected: <ul style="list-style-type: none"> for a PROFIBUS PA communication output = 1527 Hex If the MANUFACT V2.0 option is selected: <ul style="list-style-type: none"> for a PROFIBUS PA communication output = 1505 Hex If PROFILE-GSD is selected: <ul style="list-style-type: none"> for a PROFIBUS PA communication output = 9741 Hex </p>
CHECK CONFIGURATION (6163)	<p>Use this function to display whether the configuration for cyclic data transmission of the PROFIBUS master (Class 1) was accepted by the measuring device.</p> <p>User interface: ACCEPTED (configuration accepted) NOT ACCEPTED (configuration not accepted)</p>

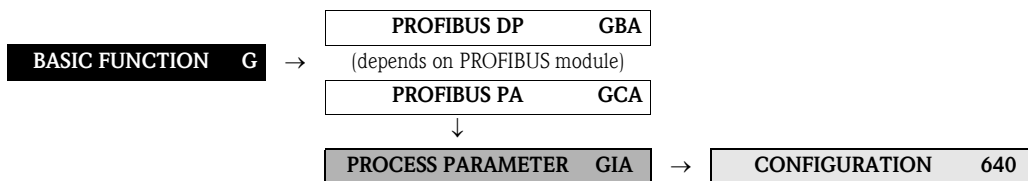

8.2 Group PROCESS PARAMETER

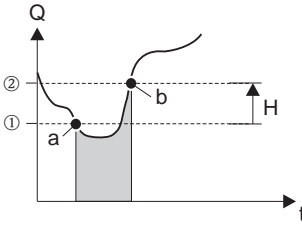

8.2.1 Function group CONFIGURATION

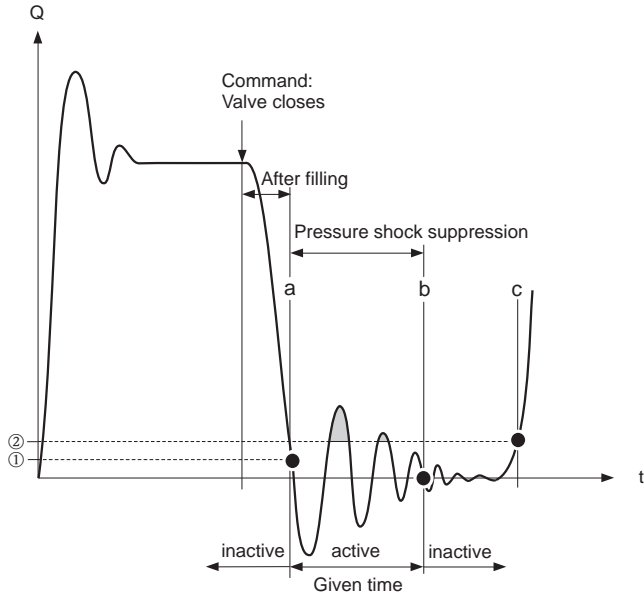

Function description	
BASIC FUNCTION → PROCESS PARAMETER → CONFIGURATION	
ASSIGN LOW FLOW CUT OFF OFF (6400)	Use this function to assign the switch point for the low flow cutoff. Options: OFF MASS FLOW VOLUME FLOW Factory setting: VOLUME FLOW
ON-VALUE LOW FLOW CUT OFF CUT OFF (6402)	Use this function to enter the switch-on point for low flow cutoff. Low flow cutoff is active if the value entered is not equal to 0. The sign of the flow value is highlighted on the display to indicate that low flow cutoff is active. User input: 5-digit floating-point number [unit] Factory setting: Depends on nominal diameter and country (s. Page 132 ff.).  Note! The appropriate unit is taken from the function UNIT VOLUME FLOW (0402) or UNIT MASS FLOW (0400), (see Page 13 or Page 12).
OFF-VALUE LOW FLOW CUT OFF CUT OFF (6403)	Use this function to enter the switch-off point (b) for low flow cutoff. Enter the switch-off point as a positive hysteresis (H) in % from the switch-on point (a). User input: Integer 0 to 100% Factory setting: 50%  ① = switch-on point, ② = switch-off point a low flow cutoff is switched on b low flow cutoff is switched off ($a + a \cdot H$) H Hysteresis value: 0 to 100%  low flow cutoff active Q Flow

A0003882

Function description BASIC FUNCTION → PROCESS PARAMETER → CONFIGURATION	
<p>PRESSURE SHOCK SUPPRESSION (6404)</p>	<p>The closure of a valve can cause brief but severe movements of the fluid in the piping system, movements which the measuring system registers. The pulses totalled in this way result in a totalizer reading error, particularly in the case of batching processes. For this reason, the measuring device is equipped with pressure shock suppression (= short-term signal suppression) which can eliminate system-related "disruptions".</p> <p> Note! Note that pressure shock suppression cannot be used unless the low flow cutoff is active (see ON-VALUE LOW FLOW CUT OFF function on Page 97).</p> <p>Use this function to define the time span for active pressure shock suppression.</p> <p>Activation of the pressure shock suppression Pressure shock suppression is activated once the flow falls below the switch-on point of the low flow (see point a in graphic).</p> <p>While pressure shock suppression is active, the following conditions apply:</p> <ul style="list-style-type: none"> ■ Flow reading on display → 0 ■ Totalizer reading → the totalizers are pegged at the last correct value. <p>Deactivation of the pressure shock suppression The pressure shock suppression is deactivated after the time interval, set in this function, has passed (see point b in graphic).</p> <p> Note! The actual flow value is displayed and output, when the time interval for the pressure shock suppression has passed and the flow exceeds the switch-off point of the low flow (see point c in graphic).</p> <div style="text-align: center;">  </div> <p style="text-align: right; font-size: small;">A0001285-EN</p> <p>① = switsch-off point (low flow), ② = switch-on point (low flow) a Activated if on-value of low flow is not reached b Deactivated once the predefined time period has elapsed c Flow values are taken into account when calculating the pulses ■ Suppressed values Q Flow</p> <p>User input: max. 4-digit number, incl. unit: 0.00 to 100.0 s</p> <p>Factory setting: 0.00 s</p>

Function description	
BASIC FUNCTION → PROCESS PARAMETER → CONFIGURATION	
CONDUCTIVITY (6405)	<p>Use this function to activate measurement of the conductivity.</p> <p>Options: OFF LONG INTERV. Measurement of conductivity after every 500 flow measurements (500 × measuring period → Page 109) SHORT INTERV. Measurement of conductivity after every 50 × flow measurements (50 × measuring period → Page 109)</p> <p>Factory setting: OFF</p> <p> Note!</p> <ul style="list-style-type: none"> ■ This function is available only if it has been enabled based on the design of the sensor. See function CONDUCTIVITY ENABLE → Page 110. ■ If conductivity is enabled, we recommend setting the system damping >3 → Page 105. <p> Caution!</p> <p>As conductivity is measured using the measurement and reference electrodes, for the duration of the conductivity measurement (duration = max. 8 × configured measuring period → Page 109) the last measured flow value is output. Therefore, it is possible that very transient flow changes will not be registered.</p>

8.2.2 Function group EPD PARAMETER

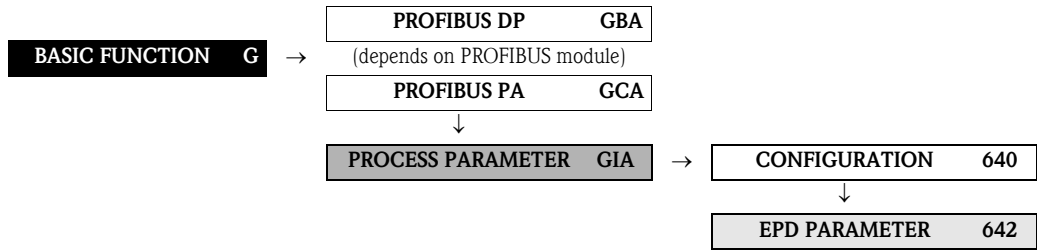



Function description	
BASIC FUNCTION → PROCESS PARAMETER → EPD PARAMETER	
<p>EMPTY PIPE DET. (6420)</p>	<p>Flow cannot be measured correctly unless the measuring tube is completely full. This status can be monitored at all times with the Empty Pipe Detection function. To do this, the empty pipe detection (EPD, empty pipe detection by means of EPD electrode) can be activated in this function:</p> <p>Options: OFF ON STANDARD</p> <p>Factory setting: OFF</p> <p> Note!</p> <ul style="list-style-type: none"> ■ The option ON STANDARD is not available unless the sensor is equipped with an EPD electrode. ■ The default setting for the EPD function when the device is delivered is OFF. The function must be activated as required. ■ The devices are calibrated at the factory with water (approx. 500 µS/cm). If the conductivity of certain fluids deviates from this reference, empty pipe/full pipe adjustment must be performed again on site (see function EPD ADJUSTMENT (6481) on page 104). ■ The adjustment coefficients must be valid before you can switch on the EPD function. If these coefficients are not available, the function EPD ADJUSTMENT is displayed (s. Page 104). ■ If there are problems with the adjustment, the following error messages appear on the screen: <ul style="list-style-type: none"> – ADJUSTMENT FULL = EMPTY: The adjustment values for empty pipe and full pipe are identical. In such instances, empty pipe adjustment/full pipe adjustment must be carried out again. – ADJUSTMENT NOT OK: Adjustment is not possible as the fluid conductivity values are outside the permitted range. <p>Notes on empty pipe detection (EPD)</p> <ul style="list-style-type: none"> ■ Flow cannot be measured correctly unless the measuring tube is completely full. This status can be monitored at all times with the EPD function. ■ An empty or partially filled pipe is a process error. A default factory setting defines that a fault message is issued and that this process error has an effect on the outputs. ■ A plausibility check of the adjustment values will only be executed by activating the empty pipe detection. If an empty or full pipe adjustment is performed when the empty pipe detection is active, the empty pipe detection has to be deactivated and activated again, after finishing the adjustment, to start the plausibility check. <p>Response to partially filled pipes</p> <p>If the EPD is switched on and responds to a partially filled or empty pipe, the notice message "EMPTY PIPE" appears on the display. If the pipe is partially empty and the EPD is not switched on, the response can vary in identically configured systems:</p> <ul style="list-style-type: none"> ■ Flow reading fluctuates ■ Zero flow ■ Excessively high flow values

Function description BASIC FUNCTION → PROCESS PARAMETER → EPD PARAMETER	
EPD RESPONSE TIME (6425)	<p> Note! The function is only available if the function EMPTY PIPE DET. (6420) has been switched on.</p> <p>Use this function to enter the time span for which the criteria for an "empty" pipe have to be satisfied without interruption before a notice message or fault message is generated.</p> <p>User input: fixed point number: 1.0 to 100 s</p> <p>Factory setting: 1.0 s</p>

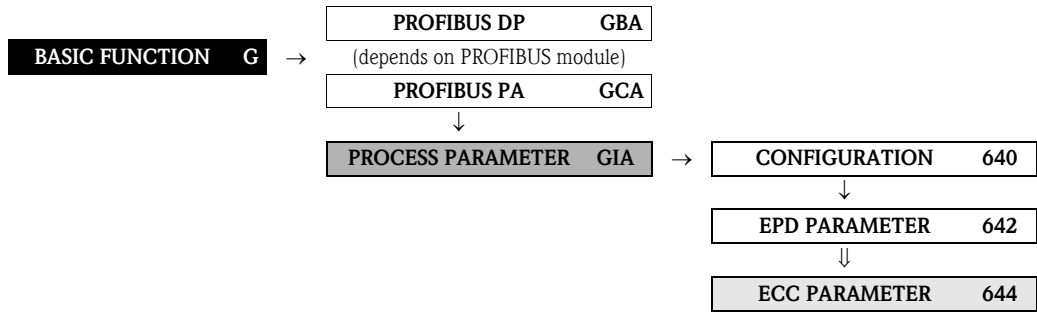
8.2.3 Function group ECC PARAMETER



Function description	
BASIC FUNCTION → PROCESS PARAMETER → ECC PARAMETER	
<p>ECC (6440)</p>	<p> Note! This function is not available unless the measuring device is equipped with an (optional) electrode cleaning function.</p> <p>Use this function to activate cyclical electrode cleaning (ECC).</p> <p>Options: ON (only with the optional electrode cleaning function ECC) OFF</p> <p>Factory setting: ON (only if the optional electrode cleaning function ECC is available)</p> <p>Notes on electrode cleaning (ECC) Conductive deposits on the electrodes and on the walls of the measuring tube (e.g. magnetite) can falsify measurement values. The Electrode Cleaning Circuitry (ECC) was developed to prevent such conductive deposits accreting in the vicinity of the electrodes. ECC functions as described above for all available electrode materials except tantalum. If tantalum is used as the electrode material, the ECC protects the electrode surface only against oxidation.</p> <p> Caution! If the ECC is switched off for a prolonged period in applications with conductive deposits, a layer forms inside the measuring tube and this can falsify measurement values. If the layer is allowed to accrete beyond a certain level, it might no longer be possible to remove it by switching on the ECC. If this happens the measuring tube must be cleaned and the layer removed.</p>
<p>ECC DURATION (6441)</p>	<p> Note! This function is not available unless the measuring device is equipped with the optional electrode cleaning function (ECC).</p> <p>Use this function to specify the electrode cleaning duration.</p> <p>User input: Fixed-point number: 0.01 to 30.0 s</p> <p>Factory setting: 2.0 s</p>

Function description	
BASIC FUNCTION → PROCESS PARAMETER → ECC PARAMETER	
ECC RECOVERY TIME (6442)	<p> Note! This function is not available unless the measuring device is equipped with the optional electrode cleaning function (ECC).</p> <p>Use this function to specify the recovery time for which the last flow value measured prior to cleaning is retained. A recovery time is necessary as the signal outputs can fluctuate after electrode cleaning on account of electrochemical interference voltages.</p> <p>User input: max. 3-digit number: 1 to 600 s</p> <p>Factory setting: 60 s</p> <p> Caution! The last value measured prior to cleaning is output for the duration of the recovery time (max. 600 s). This in turn means that the measuring system does not register changes in flow, e.g. stoppage, during this time span.</p>
ECC CLEANING CYCLE (6443)	<p> Note! This function is not available unless the measuring device is equipped with the optional electrode cleaning function (ECC).</p> <p>Use this function to specify the cleaning cycle for electrode cleaning.</p> <p>User input: Integer: 30 to 10080 min</p> <p>Factory setting: 40 min</p>

8.2.4 Function group ADJUSTMENT

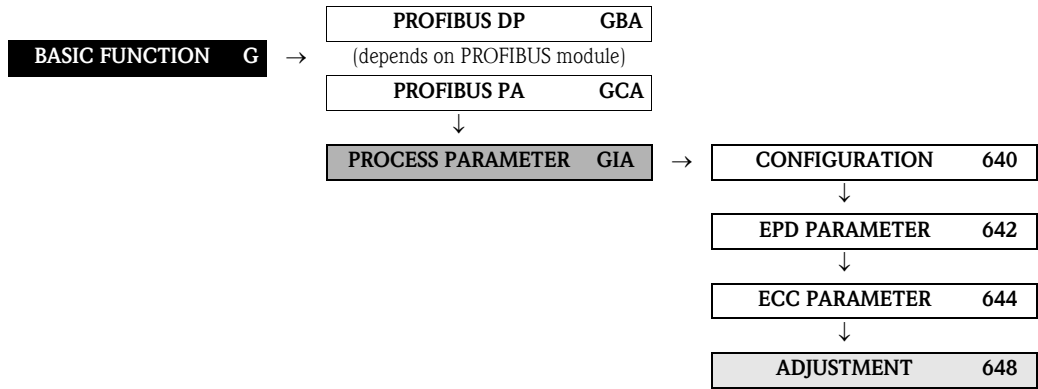

Function description	
BASIC FUNCTION → PROCESS PARAMETER → ADJUSTMENT	
<p>EPD ADJUSTMENT (6481)</p>	<p>Use this function to activate the EPD adjustment for an empty or full measuring tube.</p> <p> Note! A detailed description of the empty pipe detection function can be found on Page 100.</p> <p>Options: OFF FULL PIPE ADJUST EMPTY PIPE ADJUST</p> <p>Factory setting: OFF</p> <p>Procedure for EPD empty pipe / full pipe adjustment</p> <ol style="list-style-type: none"> 1. Empty the piping. In case of an EPD adjustment, the wall of the measuring tube should be wetted with fluid. 2. Start empty pipe adjustment: Select "EMPTY PIPE ADJUST" and press to confirm. 3. After empty pipe adjustment, fill the piping with fluid. 4. Start full pipe adjustment: Select "FULL PIPE ADJUST" and press to confirm. 5. Having completed the adjustment, select the setting "OFF" and exit the function by pressing . 6. Now select the EMPTY PIPE DET. function (s. Page 100). Switch on the empty pipe detection by selecting ON STANDARD and press to confirm. <p> Caution! The adjustment coefficients must be valid before you can activate the EPD function. If adjustment is incorrect the following messages might appear on the display:</p> <ul style="list-style-type: none"> - FULL = EMPTY The adjustment values for empty pipe and full pipe are identical. In such instances, empty pipe adjustment/full pipe adjustment must be carried out again. - ADJUSTMENT NOT OK Adjustment is not possible because the fluid's conductivity is out of range.

8.3 Group SYSTEM PARAMETER

8.3.1 Function group CONFIGURATION

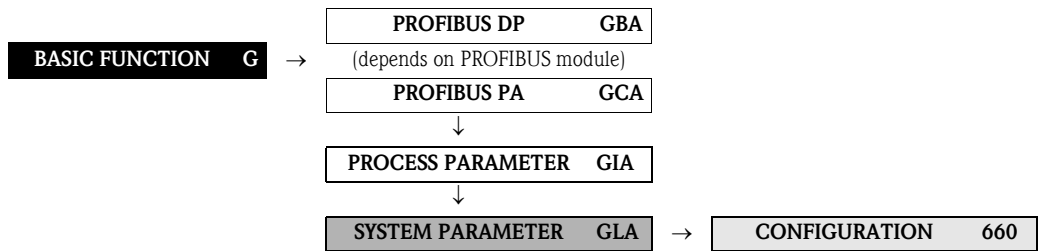





Function description	
BASIC FUNCTION → SYSTEM PARAMETER → CONFIGURATION	
INSTALLATION DIRECTION SENSOR (6600)	<p>Use this function to reverse the sign of the flow measured variable, if necessary.</p> <p>Options: NORMAL (flow as indicated by the arrow) INVERSE (flow opposite to direction indicated by the arrow)</p> <p>Factory setting: NORMAL</p> <p> Note! Ascertain the actual direction of fluid flow with reference to the direction indicated by the arrow on the sensor (nameplate).</p>
MEASURING MODE (6601)	<p>Select how flow components should be recorded by the measuring device.</p> <p>Options: UNIDIRECTIONAL (only the positive flow components) BIDIRECTIONAL (the positive and negative flow components)</p> <p>Factory setting: UNIDIRECTIONAL</p>
SYSTEM DAMPING (6603)	<p>Use this function to set the filter depth of the digital filter. This reduces the sensitivity of the measuring signal to interference peaks (e.g. high solids content, gas bubbles in the fluid, etc.). The system reaction time increases with an increasing filter setting.</p> <p>User input: 0 to 15</p> <p>Factory setting: 7</p> <p> Note! The system damping acts on all functions and outputs of the measuring device.</p>
INTEGRATION TIME (6604)	<p>Use this function to view the preset integration time.</p> <p>The integration time defines the duration of internal totaling of the induced voltage in the fluid (measured by the measuring electrode), i.e. the time in which the measuring device records the true flow (afterwards the magnetic field for the next integration is created from the opposite pole).</p> <p>User input: max. 2-digit number: 1 to 65 ms</p> <p>Factory setting: 5 ms</p>

Function description BASIC FUNCTION → SYSTEM PARAMETER → CONFIGURATION	
POSITIVE ZERO RETURN (6605)	<p>Use this function to interrupt evaluation of measured variables. This is necessary when a piping system is being cleaned, for example. This setting acts on all function and outputs of the measuring device.</p> <p>Options: OFF ON → Signal output is set to the "ZERO FLOW" value.</p> <p>Factory setting: OFF</p>
SPECIAL FILTER (6606)	<p>There is the option of activating two signal filters in this function. These filters make it possible to either suppress the signal caused by severely fluctuating flows (selection "STANDARD") or to reproduce it completely – both on the display and at the signal outputs (selection "DYNAMIC FLOW").</p> <p>Options: STANDARD For signal output with normal, stable flow.</p> <p>DYNAMIC FLOW For signal output with severely fluctuating or pulsating flow.</p> <p>Factory setting: STANDARD</p> <p> Caution!</p> <ul style="list-style-type: none"> ■ The signal behavior at the outputs also depends on the function SYSTEM DAMPING (6603). ■ Additional filter settings (e.g. STANDARD CIP or DYNAMIC FLOW CIP) can only be selected using a special service code. Such settings that are mostly made by a service technician are deleted again if the customer code is entered anew and can then no longer be activated.

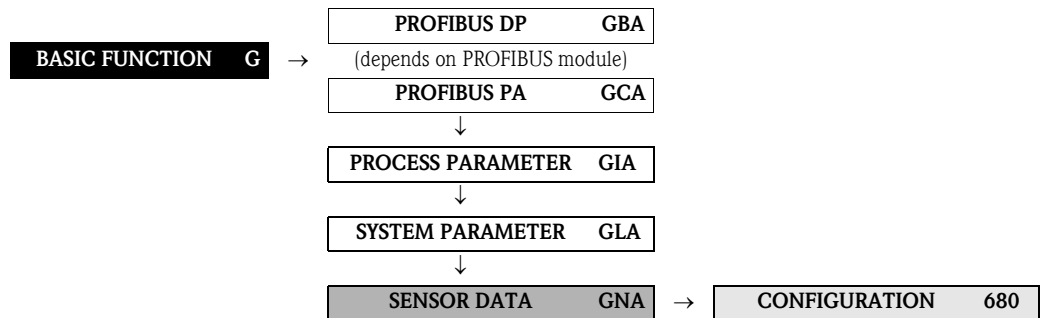
8.4 Group SENSOR DATA

8.4.1 Function group CONFIGURATION





Function description	
BASIC FUNCTION → SENSOR DATA → CONFIGURATION	
<p>All sensor data (calibration factors, zero (point) and nominal diameter) are set at the factory and saved on the S-DAT sensor memory chip.</p> <p> Note! The individual values of the functions are also provided on the sensor nameplate.</p> <p> Caution! Under normal circumstances you should not change the following parameter settings, because changes affect numerous functions of the entire measuring facility in general and the accuracy of the measuring system in particular. For this reason, the functions described below cannot be changed even when you enter your personal code.</p> <p>Contact the Endress+Hauser service organization if you have any questions about these functions.</p>	
CALIBRATION DATE (6800)	<p>Use this function to view the current calibration date and time for the sensor.</p> <p>User interface: Calibration date and time</p> <p>Factory setting: Calibration date and time of the current calibration.</p> <p> Note! The calibration date and time format is defined in the FORMAT DATE/TIME (0429) function, → Page 14.</p>
K-FACTOR (6801)	<p>Use this function to display the current calibration factor (positive flow direction) for the sensor. The calibration factor is determined and set at the factory.</p> <p>User interface: 5-digit fixed-point number: 0.5000 to 2.0000</p> <p>Factory setting: Depends on nominal diameter and calibration</p>
ZERO POINT (6803)	<p>Use this function to view the current zero-point correction value for the sensor. Zero-point correction is determined and set at the factory.</p> <p>User interface: max. 4-digit number: -1000 to +1000</p> <p>Factory setting: Depends on nominal diameter and calibration</p>

Function description BASIC FUNCTION → SENSOR DATA → CONFIGURATION	
NOMINAL DIAMETER (6804)	<p>Use this function to view the nominal diameter of the sensor. The nominal diameter depends on the size of the sensor and is set at the factory.</p> <p>User interface: 2 to 2000 mm or 1/12 to 78"</p> <p>Factory setting: Depends on the size of the sensor</p>

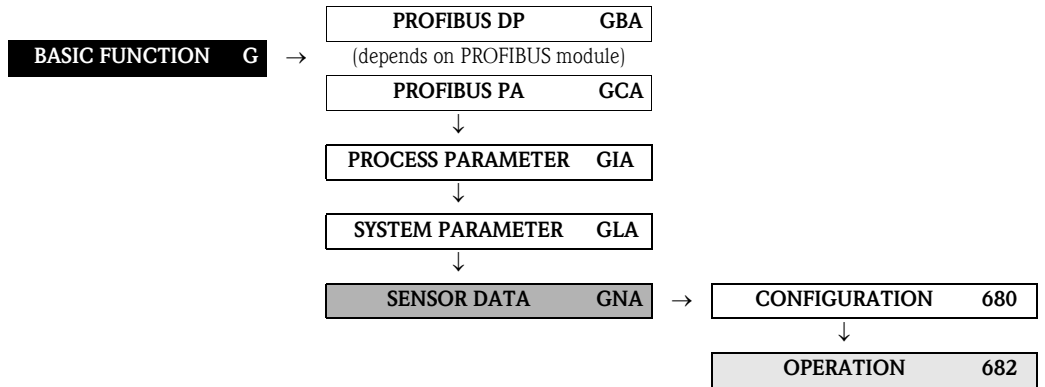
8.4.2 Function group OPERATION



Function description BASIC FUNCTION → SENSOR DATA → OPERATION	
<p>All sensor data (measuring period, overvoltage time, etc.) are set at the factory and saved on the S-DAT sensor memory chip.</p> <p> Caution! Under normal circumstances you should not change the following parameter settings, because changes affect numerous functions of the entire measuring facility in general and the accuracy of the measuring system in particular. For this reason, the functions described below cannot be changed even when you enter your personal code.</p> <p>Contact the Endress+Hauser service organization if you have any questions about these functions.</p>	
MEASURING PERIOD (6820)	<p>Use this function to view the time for a full measuring period. The duration of the measuring period is calculated from the rise time of the magnetic field, the brief recovery time, the integration time and the empty pipe detection time.</p> <p>User input: max. 4-digit number: 10 to 1000 ms</p> <p>Factory setting: Depends on nominal diameter</p>
EPD ELECTRODE (6822)	<p>Use this function to check whether the sensor is equipped with an EPD electrode.</p> <p>User interface: YES NO</p> <p>Factory setting: YES → Electrode fitted as standard</p>
POLARITY ECC (6823)	<p>Use this function to display the actual current polarity for optional electrode cleaning (ECC). Electrode cleaning uses either a positive or negative current, depending on the electrode material. The measuring device automatically selects the correct polarity on the basis of the electrode-material data stored in the S-DAT.</p> <p>User interface: POSITIVE → for electrodes made of: 1.4435/316L, Alloy C-22, platinum, titanium, tungsten carbide coating (for electrodes made of 1.4435), 1.4310/302 NEGATIVE → for electrodes made of: tantalum</p> <p> Caution! If the incorrect current is applied to the electrodes, the electrode material is destroyed.</p>

Function description	
BASIC FUNCTION → SENSOR DATA → OPERATION	
CONDUCTIVITY ENABLE (6824)	<p>Use this function to display whether the sensor is capable of measuring conductivity. The availability of the CONDUCTIVITY function depends on the design of the sensor.</p> <p>User interface:</p> <p>YES → Conductivity enabled: – Sensor S (without brush electrodes)</p> <p>NO → Conductivity not available: – Sensor S (with brush electrodes) – Sensor H</p>

9 Block SPECIAL FUNCTION

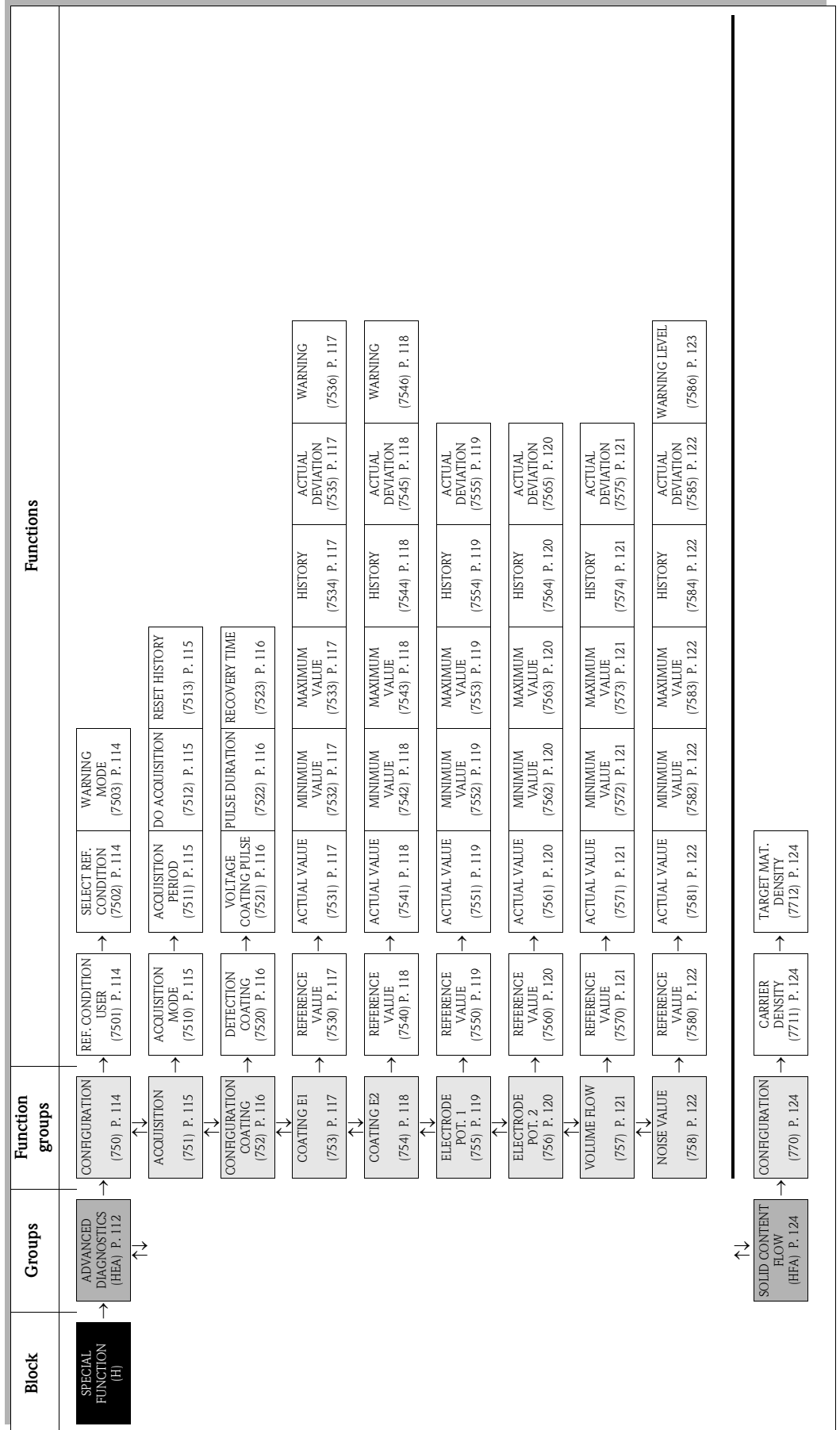

9.1 Group ADVANCED DIAGNOSTICS

Introduction

The optional software package "Advanced Diagnostics" (F-CHIP) can be used to detect changes to the measuring system at an early stage, e.g. as a result of build-up (coating), abrasion and corrosion at the measuring electrodes. Such factors cause a reduction in accuracy in normal cases or lead to system errors in extreme cases.

With the aid of diagnostic functions it is possible to record the following diagnostic parameters during operation:

- Decay times of test pulses at the measuring electrodes
- Electrode potentials at both measuring electrodes
- Volume flow value (before applying the test pulses)

By analysing general trends of these diagnostic parameters, deviations of the measuring system from a "reference condition" can be detected at an early stage, allowing for countermeasures to be taken.

Measurement of the decay time constant of test pulses (Fig. 2):

Monitoring both measuring electrodes makes it possible to detect the formation of build-up at an early stage. To do this, a defined voltage pulse (U_B) with a pulse width (t_p , typically 1 to 20 ms) is applied periodically at an electrode and its decay time constant (τ_R) is measured. The decay time constant is a function of the condition of the measuring electrode in question.

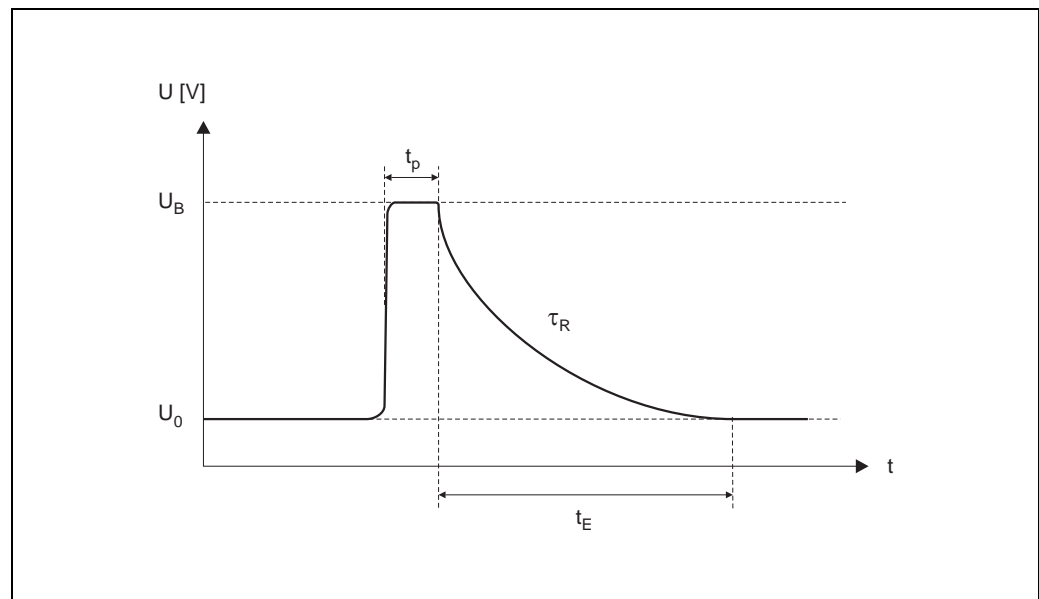

Fig. 2: Schematic curve of the decay time constant of a voltage pulse at a measuring electrode. U_0 = zero voltage, U_B = voltage of the test pulse for the coating detection, t_p = pulse duration, τ_R = decay time constant, t_E = recovery time

Measurement of electrode potentials:

The measuring electrode potential is influenced by various factors, for example by solids, air bubbles, inhomogeneities in the fluid, sudden pH changes, mechanical damage or corrosive changes. Therefore, monitoring the electrode potentials provides information about the specified disturbance factors.

Measurement of the volume flow (immediately before applying the test pulses):

What is meant here by "volume flow" is the volume flow value that is acquired immediately before the test pulses are applied to the measuring electrodes. This value serves as another basis for the interpretation of decay time constants or electrode potentials with regard to coating formation, abrasion or corrosion.

Activating coating detection (procedure)

1. Ascertain reference values for the diagnostic parameters → Function REFERENCE CONDITION USER (7501).
2. Select reference condition → Function SELECT REFERENCE CONDITION (7502)
3. Specify when and how the diagnostic parameter values are to be ascertained:
 - Time intervals → Function ACQUISITION PERIOD (7511)
 - Periodical or manual → Function ACQUISITION MODE (7510)
4. Switch on coating detection → Function DETECTION COATING (7520)
5. Activate warning mode (if desired):

 **Note!**

Activating the WARNING MODE (7503) function normally only makes sense if a trend analysis of the diagnostic parameter values in question has been performed beforehand! Only then, can process-specific limit values be entered (= max. permitted deviation from the reference status).

- Switch on warning mode → Function WARNING MODE (7503)
- Enter the maximum permitted deviation of the decay time constant from the reference condition → Function WARNING (7536, 7546)

Trend analysis of diagnostic parameters

By evaluating a sufficiently large number of measuring values, useful trend information can be acquired that provides information about possible coating formations or damage to the measuring electrodes - for example, as a result of corrosion or mechanical influences.

The following values of diagnostic parameters can be called up via the function matrix:

- Reference values
- Actual values of the decay time constant or of the electrode potential
- Minimum/maximum values since the last adjustment
- Data history of the last 10 measuring values (or 100 values when interrogating via the "FieldCare" software)
- Actual deviation between diagnostic parameter value and reference value

To assess possible build-up, the diagnostic parameters of the COATING 1 and COATING 2 function groups should only be interpreted and assessed in combination with those of ELECTRODE POTENTIAL 1/2 and VOLUME FLOW parameters. As build-up typically develops over a period of months, it is useful to present and analyze the relevant measured data and parameters using appropriate software, for example, the Endress+Hauser software package "FieldCare".

**Caution!**

Since the decay time and the electrode potential are dependent on the process conditions at the electrode and, therefore, on the fluid, a new reference measurement is required as the starting point for a trend analysis for each process and each fluid in a balanced state. The measuring values are then measured periodically and saved in the device storage unit (RAM).

**Note!**

More information about "trend analysis" can be found in the Operating Instructions for this measuring device.





9.1.1 Function group CONFIGURATION

SPECIAL FUNCTION H → ADV. DIAGNOSTICS HEA → CONFIGURATION 750

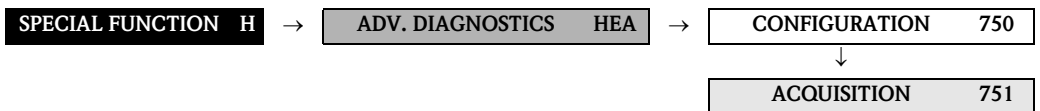
Function description SPECIAL FUNCTION → ADVANCED DIAGNOSTICS → CONFIGURATION	
REFERENCE STATUS USER (7501)	<p>This function enables the user to start an adjustment, in order to ascertain the reference values of various diagnostic parameters valid for his process. These reference values are authoritative as the "starting point" for later trend analyses (regarding abrasion, corrosion or coating formation) and should be ascertained for each process or fluid in a balanced state.</p> <p>When adjustment is performed, the reference values of the following diagnostic parameters are ascertained:</p> <ul style="list-style-type: none"> ■ Decay time constant of test pulses (at measuring electrodes 1 and 2) ■ Electrode potentials (of measuring electrodes 1 and 2) ■ Volume flow (flow value immediately before applying the test pulses) <p>Options: CANCEL START</p> <p>Factory setting: CANCEL</p>
SELECTION REFERENCE STATUS (7502)	<p>In this function, the reference condition is selected (at the factory or by the user), which the affected diagnostic parameters are to be compared to later.</p> <p>Options: FACTORY (reference values determined at the factory) USER (reference values ascertained by the user → Function 7501)</p> <p>Factory setting: FACTORY</p>
WARNING MODE (7503)	<p>In this function, you can determine whether a warning is generated if a deviation occurs between the reference condition (see Function SELECTION REFERENCE STATUS) and the actual measured diagnostic parameters.</p> <p>When doing so, the following diagnostic parameters are compared to the reference condition:</p> <ul style="list-style-type: none"> ■ Decay time constant of test pulses → Function group COATING E1 or E2 ■ Electrode potentials → Function group ELECTRODE POT. 1 or 2 ■ Volume flow → Function group VOLUME FLOW <p>Options: OFF ON</p> <p>Factory setting: OFF</p>

9.1.2 Function group ACQUISITION



Function description	
SPECIAL FUNCTION → ADVANCED DIAGNOSTICS → ACQUISITION	
ACQUISITION MODE (7510)	<p>In this function, you define whether the diagnostic parameters are acquired periodically by the measuring device or manually by the user.</p> <p>Options: OFF PERIODICAL SINGLE SHOT</p> <p>Factory setting: OFF</p>
ACQUISITION PERIOD (7511)	<p> Note! This function is not available unless the "PERIODICAL" setting was selected in the ACQUISITION MODE function (7510).</p> <p>In this function, a time interval is specified that is used to acquire and record the affected diagnostic parameters periodically. This function is active as soon as the input is confirmed with the  key.</p> <p>User input: 10 to 10 080 min</p> <p>Factory setting: 60 min</p> <p> Note! A defined reference condition must be present before the diagnostic parameters are measured → see Function SELECTION REFERENCE STATUS (7502).</p>
DO ACQUISITION (7512)	<p> Note! This function is not available unless the "SINGLE SHOT" setting was selected in the ACQUISITION MODE function (7510).</p> <p>This function can be used to start the test measurements of diagnostic parameters manually, e.g. sporadically depending on the process conditions.</p> <p>Options: CANCEL START</p> <p>Factory setting: CANCEL</p> <p> Note! A defined reference condition must be present before the diagnostic parameters are measured → see Function SELECTION REFERENCE STATUS (7502).</p>
RESET HISTORY (7513)	<p>All previously saved diagnostic parameter values can be deleted with this function (= parameters of the COATING E1, COATING E2, ELECTRODE POTENTIAL 1, ELECTRODE POTENTIAL 2 and VOLUME FLOW function groups).</p> <p>Options: NO YES</p> <p>Factory setting: NO</p>

9.1.3 Function group CONFIG. COATING

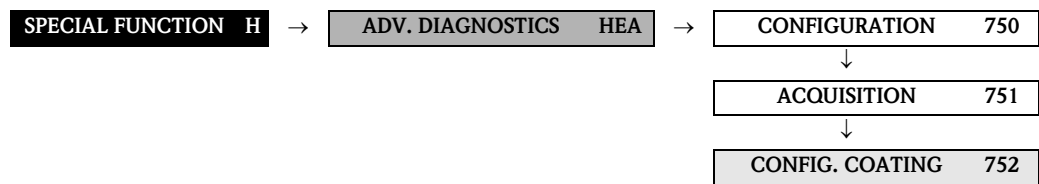

Function description	
SPECIAL FUNCTION → ADVANCED DIAGNOSTICS → CONFIGURATION COATING	
DETECTION COATING (7520)	<p>The coating detection (= detecting build-up on the measuring electrodes) can be switched on in this function.</p> <p>Options: OFF ON</p> <p>Factory setting: OFF</p>
VOLTAGE COATING PULSE (7521)	<p>The extent of the voltage pulse required for the coating detection (U_B, Fig. 2) is entered in this function.</p> <p>User input: 0.1 to 6 V(olt)</p> <p>Factory setting: 3 V</p>
PULSE DURATION (7522)	<p>The pulse width (t_p, Fig. 2) for measuring the decay time constant is entered in this function.</p> <p>User input: 0.1 to 10 ms</p> <p>Factory setting: 1 ms</p>
RECOVERY TIME (7523)	<p>In this function, a recovery time (t_E, Fig. 2) for the decay of the test pulse is specified, while the last – before coating detection – measured flow rate value is retained. It is necessary to enter a recovery time because the pulse (for coating detection) can cause the signal outputs to fluctuate due to electrochemical interference voltages.</p> <p>User input: 0.1 to 100 s</p> <p>Factory setting: 10 s</p> <p> Caution!</p> <ul style="list-style-type: none"> ■ During the recovery time, the measuring device outputs the last flow rate value measured before coating detection. This in turn means that the measuring system does not register changes in flow, e.g. zero flow, during this time span. ■ If the value entered for the recovery time is too small, then the measuring device generates the error message "COATING FAILED" (# 845).

9.1.4 Function group COATING E1

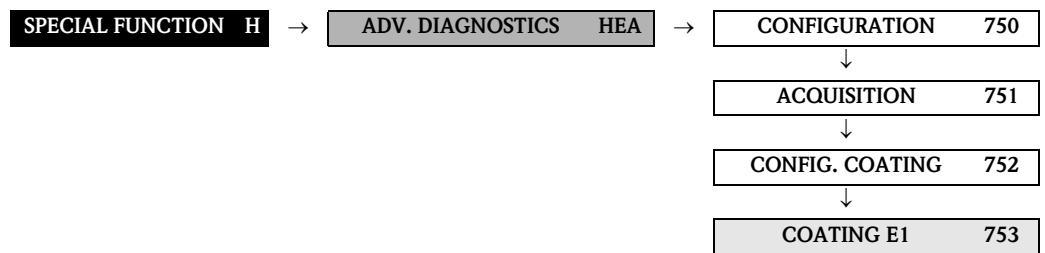

Function description	
SPECIAL FUNCTION → ADVANCED DIAGNOSTICS → COATING E1	
REFERENCE VALUE (7530)	<p>Use this function to view the reference value for the decay time constant at measuring electrode 1.</p> <p>User interface: 5-digit floating-point number, including unit in milliseconds</p>
ACTUAL VALUE (7531)	<p>Use this function to view the actual measured decay time constant at measuring electrode 1.</p> <p>User interface: 5-digit floating-point number, including unit in milliseconds</p>
MINIMUM VALUE (7532)	<p>Use this function to view the lowest measured value for the decay time constant at measuring electrode 1, since the last reset or deletion of the stored values.</p> <p>User interface: 5-digit floating-point number, including unit in milliseconds</p>
MAXIMUM VALUE (7533)	<p>Use this function to view the highest measured value for the decay time constant at measuring electrode 1, since the last reset or deletion of the stored values.</p> <p>User interface: 5-digit floating-point number, including unit in milliseconds</p>
HISTORY (7534)	<p>Use this function to view the last 10 measuring values for the decay time constant at measuring electrode 1, since the last reset or deletion of the stored values.</p> <p>User interface: 5-digit floating-point number, including unit in milliseconds</p>
ACTUAL DEVIATION (7535)	<p>Use this function to view the deviation between the actual (last measured) value for the decay time constant at measuring electrode 1 and the reference values selected in the SELECTION REFERENCE STATUS function (7502).</p> <p>User interface: 5-digit floating-point number, including unit in milliseconds</p>
WARNING (7536)	<p> Note! This function is not available unless the ON setting was selected in the WARNING MODE function (7503).</p> <p>In this function, the user can specify a maximum permitted deviation (limit value) from the reference status for the decay time constant. If this limit value is overshoot or undershot, a system error message (categorized as a notice message) is output. To do this, the measuring system compares the actual deviation (see Function ACTUAL DEVIATION, 7535) to the value entered here.</p> <p>User input: 1 to 10000 ms</p> <p>Factory setting: 100 ms</p>

9.1.5 Function group COATING E2

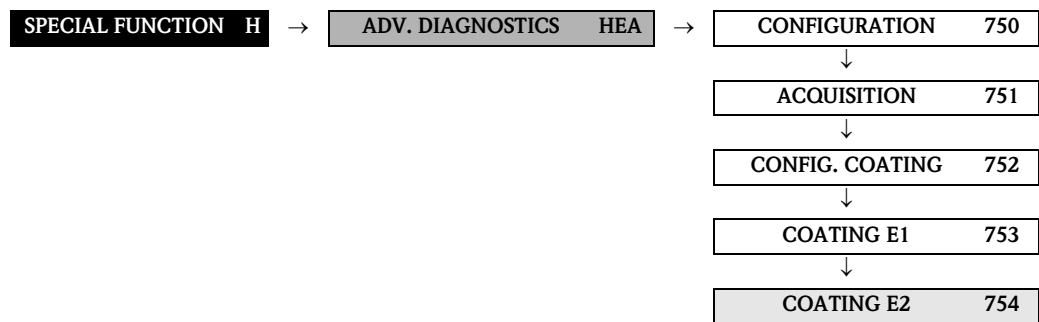

Function description	
SPECIAL FUNCTION → ADVANCED DIAGNOSTICS → COATING E2	
REFERENCE VALUE (7540)	Use this function to view the reference value for the decay time constant at measuring electrode 2. User interface: 5-digit floating-point number, including unit in milliseconds
ACTUAL VALUE (7541)	Use this function to view the actual measured decay time constant at measuring electrode 2. User interface: 5-digit floating-point number, including unit in milliseconds
MINIMUM VALUE (7542)	Use this function to view the lowest measured value for the decay time constant at measuring electrode 2, since the last reset or deletion of the stored values. User interface: 5-digit floating-point number, including unit in milliseconds
MAXIMUM VALUE (7543)	Use this function to view the highest measured value for the decay time constant at measuring electrode 2, since the last reset or deletion of the stored values. User interface: 5-digit floating-point number, including unit in milliseconds
HISTORY (7544)	Use this function to view the last 10 measuring values for the decay time constant at measuring electrode 2, since the last reset or deletion of the stored values. User interface: 5-digit floating-point number, including unit in milliseconds
ACTUAL DEVIATION (7545)	Use this function to view the deviation between the actual (last measured) value for the decay time constant at measuring electrode 2 and the reference values selected in the SELECTION REFERENCE STATUS function (7502). User interface: 5-digit floating-point number, including unit in milliseconds
WARNING (7546)	<p> Note! This function is not available unless the ON setting was selected in the WARNING MODE function (7503).</p> <p>In this function, the user can enter a maximum permitted deviation (limit value) from the reference status for the decay time constant. If this limit value is overshoot or undershot, a system error message (categorized as a notice message) is output. To do this, the measuring system compares the actual deviation (see Function ACTUAL DEVIATION, 7535) to the value entered here.</p> <p>User input: 1 to 10000 ms</p> <p>Factory setting: 100 ms</p>

9.1.6 Function group ELECTRODE POT. 1

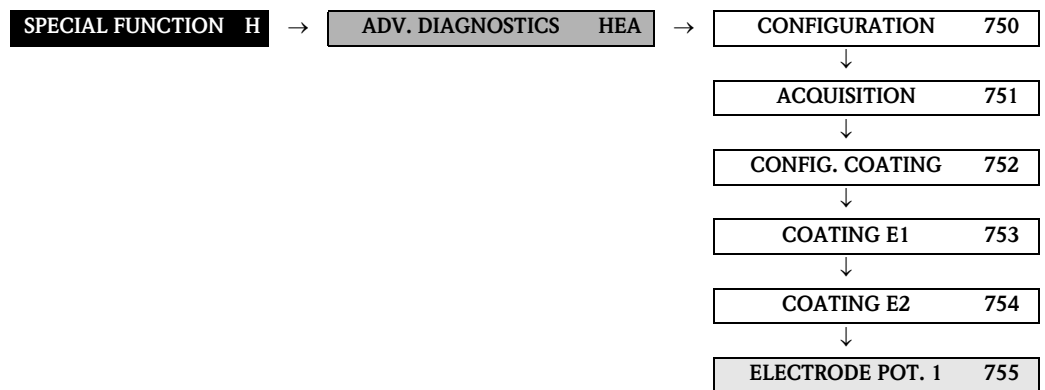

Function description	
SPECIAL FUNCTION → ADVANCED DIAGNOSTICS → ELECTRODE POT. 1	
REFERENCE VALUE (7550)	Use this function to view the reference value for the electrode potential at measuring electrode 1. User interface: 5-digit floating-point number, including unit in millivolts
ACTUAL VALUE (7551)	Use this function to view the actual measured electrode potential at measuring electrode 1. User interface: 5-digit floating-point number, including unit in millivolts
MINIMUM VALUE (7552)	Use this function to view the lowest measured value for the electrode potential at measuring electrode 1, since the last reset or deletion of the stored values. User interface: 5-digit floating-point number, including unit in millivolts
MAXIMUM VALUE (7553)	Use this function to view the highest measured value for the electrode potential at measuring electrode 1, since the last reset or deletion of the stored values. User interface: 5-digit floating-point number, including unit in millivolts
HISTORY (7554)	Use this function to view the last 10 measured values for the electrode potential at measuring electrode 1, since the last reset or deletion of the stored values. User interface: 5-digit floating-point number, including unit in millivolts
ACTUAL DEVIATION (7555)	Use this function to view the deviation between the actual (last measured) value for the electrode potential at measuring electrode 1 and the reference values selected in the SELECTION REFERENCE STATUS function (7502). User interface: 5-digit floating-point number, including unit in millivolts

9.1.7 Function group ELECTRODE POT. 2

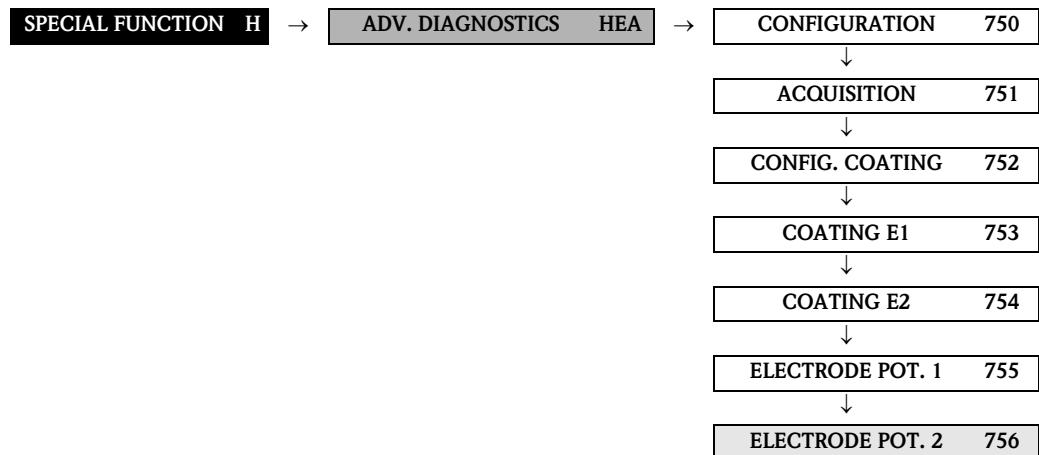

Function description	
SPECIAL FUNCTION → ADVANCED DIAGNOSTICS → ELECTRODE POT. 2	
REFERENCE VALUE (7560)	Use this function to view the reference value for the electrode potential at measuring electrode 2. User interface: 5-digit floating-point number, including unit in millivolts
ACTUAL VALUE (7561)	Use this function to view the actual measured electrode potential at measuring electrode 2. User interface: 5-digit floating-point number, including unit in millivolts
MINIMUM VALUE (7562)	Use this function to view the lowest measured value for the electrode potential at measuring electrode 2, since the last reset or deletion of the stored values. User interface: 5-digit floating-point number, including unit in millivolts
MAXIMUM VALUE (7563)	Use this function to view the highest measured value for the electrode potential at measuring electrode 2, since the last reset or deletion of the stored values. User interface: 5-digit floating-point number, including unit in millivolts
HISTORY (7564)	Use this function to view the last 10 measured values for the electrode potential at measuring electrode 2, since the last reset or deletion of the stored values. User interface: 5-digit floating-point number, including unit in millivolts
ACTUAL DEVIATION (7565)	Use this function to view the deviation between the actual (last measured) value for the electrode potential at measuring electrode 2 and the reference values selected in the SELECTION REFERENCE STATUS function (7502). User interface: 5-digit floating-point number, including unit in millivolts

9.1.8 Function group VOLUME FLOW

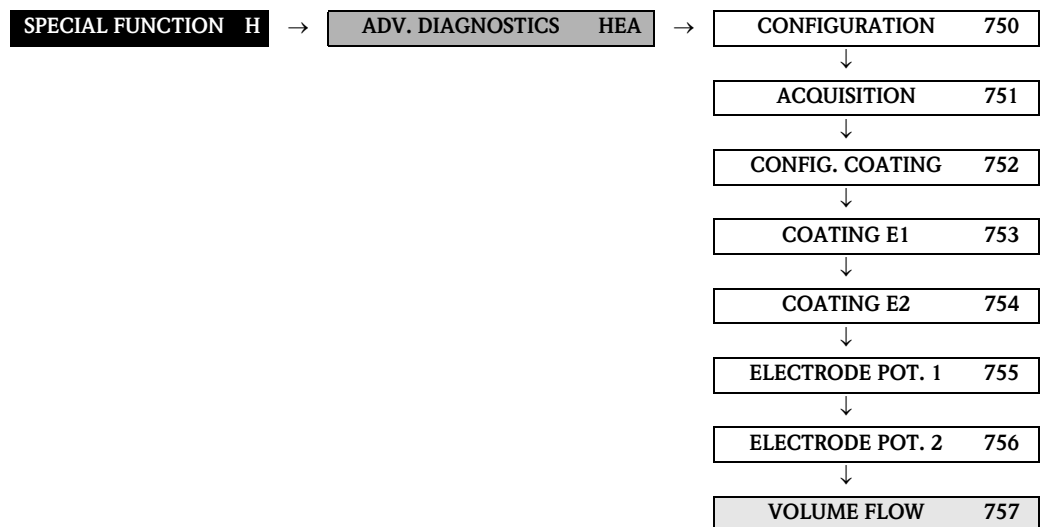

Function description	
SPECIAL FUNCTION → ADVANCED DIAGNOSTICS → VOLUME FLOW	
<p>What is meant here by "volume flow" is the volume flow value that was acquired immediately before the test pulses were applied to the measuring electrodes. This value serves as another basis for the interpretation of decay time constants or electrode potentials with regard to coating formation, abrasion or corrosion.</p>	
REFERENCE VALUE (7570)	<p>Use this function to view the reference value for the volume flow.</p> <p>User interface: 5-digit floating-point number, including unit</p>
ACTUAL VALUE (7571)	<p>Use this function to view the actual measured volume flow.</p> <p>User interface: 5-digit floating-point number, including unit</p>
MINIMUM VALUE (7572)	<p>Use this function to view the lowest measured value for the volume flow, since the last reset or deletion of the stored values.</p> <p>User interface: 5-digit floating-point number, including unit</p>
MAXIMUM VALUE (7573)	<p>Use this function to view the highest measured value for the volume flow, since the last reset or deletion of the stored values.</p> <p>User interface: 5-digit floating-point number, including unit</p>
HISTORY (7574)	<p>Use this function to view the last 10 measured values for the volume flow, since the last reset or deletion of the stored values.</p> <p>User interface: 5-digit floating-point number, including unit</p>
ACTUAL DEVIATION (7575)	<p>Use this function to view the deviation between the actual (last measured) value for the volume flow and the reference values selected in the SELECTION REFERENCE STATUS function (7502).</p> <p>User interface: 5-digit floating-point number, including unit</p>

9.1.9 Function group NOISE VALUE

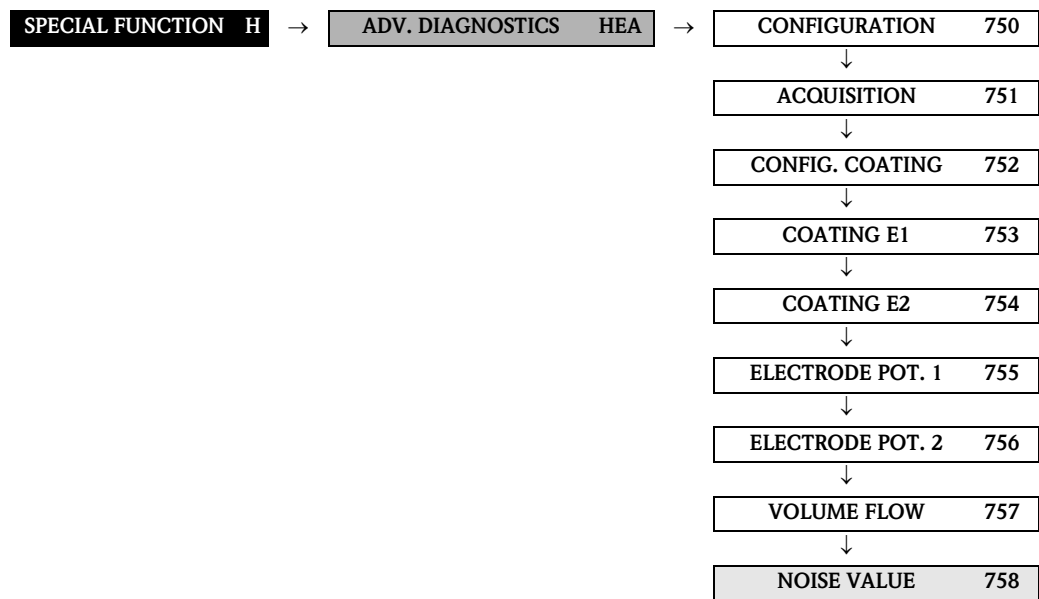

Function description	
SPECIAL FUNCTION → ADVANCED DIAGNOSTICS → NOISE VALUE	
<p>NOISE VALUE ist the standard deviation of differential signal of both measuring electrodes. It is an additional indicator for the quality of the measuring signal.</p>	
<p>REFERENCE VALUE (7580)</p>	<p>Use this function to view the reference value for the noise value.</p> <p>User interface: 5-digit floating-point number, including unit in mV</p>
<p>ACTUAL VALUE (7581)</p>	<p>Use this function to view the actual measured noise value.</p> <p>User interface: 5-digit floating-point number, including unit in mV</p>
<p>MINIMUM VALUE (7582)</p>	<p>Use this function to view the lowest measured value for the noise value, since the last reset or deletion of the stored values.</p> <p>User interface: 5-digit floating-point number, including unit in mV</p>
<p>MAXIMUM VALUE (7583)</p>	<p>Use this function to view the highest measured value for the noise value, since the last reset or deletion of the stored values.</p> <p>User interface: 5-digit floating-point number, including unit in mV</p>
<p>HISTORY (7584)</p>	<p>Use this function to view the last 10 measured values for the noise value, since the last reset or deletion of the stored values.</p> <p>User interface: 5-digit floating-point number, including unit in mV</p>
<p>ACTUAL DEVIATION (7585)</p>	<p>Use this function to view the deviation between the actual (last measured) value for the noise value and the reference values selected in the SELECTION REFERENCE STATUS function (7502).</p> <p>User interface: 5-digit floating-point number, including unit in mV</p>

Function description SPECIAL FUNCTION → ADVANCED DIAGNOSTICS → NOISE VALUE	
WARNING LEVEL (7586)	<p> Note! This function is available only if the ON setting was selected in the WARNING MODE (7503) function.</p> <p>In this function, the user can enter a maximum permitted deviation (limit value) from the reference status for the decay time constant. If this limit value is overshoot or undershot, a system error message (categorized as a notice message) is output. To do this, the measuring system compares the actual deviation to the default value entered here (see ACTUAL DEVIATION function, 7585).</p> <p>User input: positive value in mV</p> <p>Factory setting: 0.1 mV</p>

9.2 Group SOLID CONTENT FLOW



Note!

A brief introduction of the calculation of solid content flow with Promag 55 and the requirements needed for this can be found in the Operating Instructions.

Observe the following points when commissioning the solid content flow function:

1. Be aware that the settings in the following functions are identical both for the flowmeter and for the external density meter:
UNIT DENSITY (0420)
2. Enter the following density values:
SPECIAL FUNCTIONS > SOLID CONTENT FLOW > CONFIGURATION >
CARRIER DENSITY (7711) and TARGET MAT. DENSITY (7712)
3. Enter the desired density unit:
MEASURED VARIABLES > SYSTEM UNITS > ADDITIONAL CONFIGURATION >
UNIT DENSITY (0420)
4. The "ASSIGN ..." functions can also be used to assign the calculated solid content flow measured variables to a display line or to the outputs (current, frequency, relay).

9.2.1 Function group CONFIGURATION

SPECIAL FUNCTION H → **SOLID CONTENT FLOW HFA** → **CONFIGURATION 770**

Function description SPECIAL FUNCTION → SOLID CONTENT FLOW → CONFIGURATION	
CARRIER DENSITY (7711)	<p> Note! This function is only available if the measuring device has an F-CHIP for calculating solid content flows (order option).</p> <p>In this function, the density of the transporting liquid (e.g. water) can be entered, in order to calculate the flow rate of solids. This density value can, for example, be determined from reference tables or by means of corresponding laboratory tests.</p> <p>User input: 5-digit floating-point number (0 to 99999), including unit</p> <p>Factory setting: 1.0 kg/l</p>
TARGET MAT. DENSITY (7712)	<p> Note! This function is only available if the measuring device has an F-CHIP for calculating solid content flows (order option).</p> <p>In this function, the density of the target medium (e.g. transported solids) can be entered, in order to calculate the flow rate of solids. This density value can, for example, be determined from reference tables or by means of corresponding laboratory tests.</p> <p>User input: 5-digit floating-point number (0 to 99999), including unit</p> <p>Factory setting: 2.5 kg/l</p>

10 Block SUPERVISION

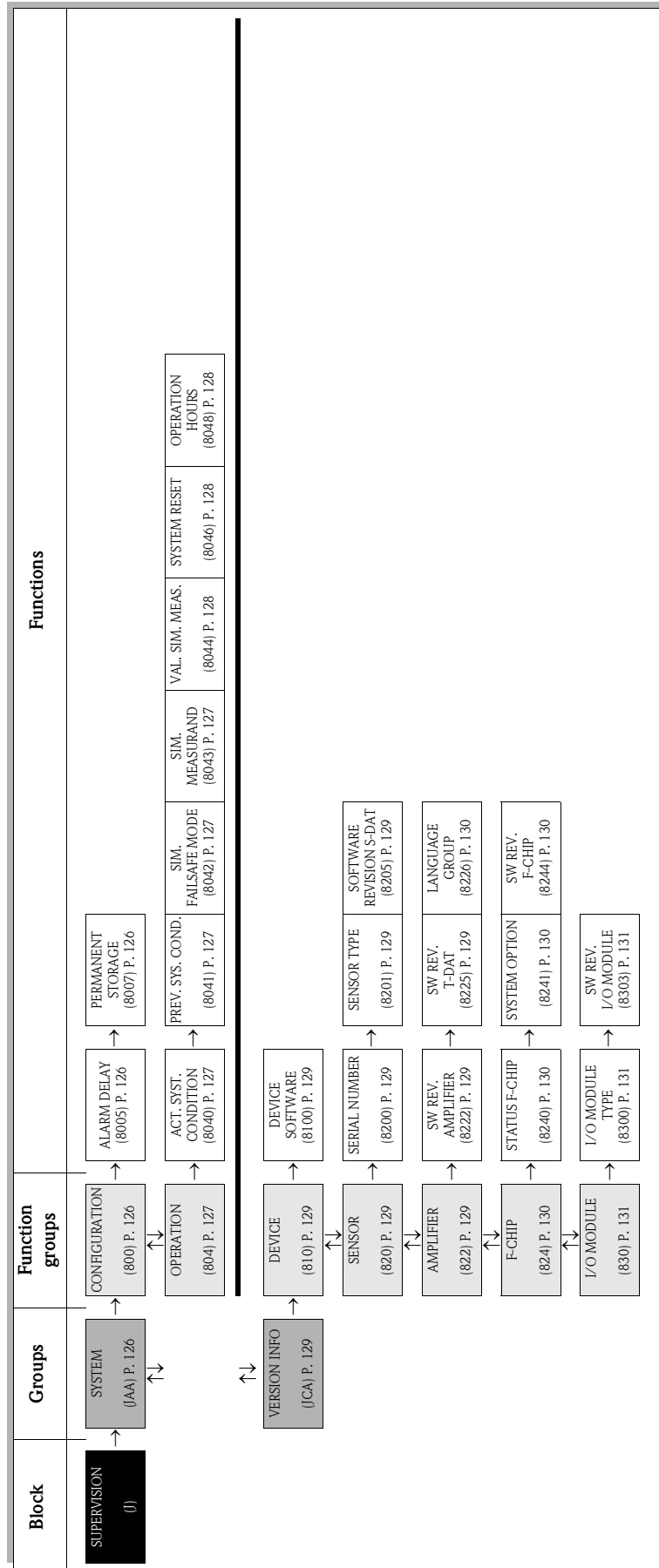



10.1 Group SYSTEM

10.1.1 Function group CONFIGURATION

SUPERVISION	J	→	SYSTEM	JAA	→	CONFIGURATION	800
-------------	---	---	--------	-----	---	---------------	-----

Function description	
SUPERVISION → SYSTEM → CONFIGURATION	
ALARM DELAY (8005)	<p>Use this function to define a time span in which the criteria for a fault have to be satisfied without interruption before a fault or notice message is generated.</p> <p>Depending on the setting and the type of fault, this suppression acts on:</p> <ul style="list-style-type: none"> ■ Display ■ PROFIBUS DP ■ PROFIBUS PA <p>User input: 0 to 100 s (in steps of one second)</p> <p>Factory setting: 0 s</p> <p> Caution! If this function is activated, fault and notice messages are delayed by the time corresponding to the setting before being transmitted to the higher-order controller (process controller, etc.). It is therefore imperative to check in advance in order to make sure whether a delay of this nature could affect the safety requirements of the process. If fault and notice messages may not be suppressed, a value of 0 seconds must be entered here.</p>
STORAGE (8007)	<p>This function displays whether permanent saving of all parameters in the EEPROM is switched on or off.</p> <p>User interface: OFF or ON</p> <p>Factory setting: ON</p>

Function description SUPERVISION → SYSTEM → OPERATION	
VALUE SIMULATION MEASURAND (8044)	<p> Note! The function is not visible unless the SIMULATION MEASURAND function (8043) is active.</p> <p>Use this function to specify a selectable value (e.g. 12 m³/s). This is used to test the associated functions in the device itself and downstream signal loops.</p> <p>User input: 5-digit floating-point number [unit]</p> <p>Factory setting: 0 [unit]</p> <p> Caution!</p> <ul style="list-style-type: none"> ■ The setting is not saved if the power supply fails. ■ The appropriate unit is taken from the function group SYSTEM UNITS (ACA), (see Page 12).
SYSTEM RESET (8046)	<p>Use this function to perform a reset of the measuring system.</p> <p>Options: NO RESTART SYSTEM (restart without interrupting power supply)</p> <p>Factory setting: NO</p>
OPERATION HOURS (8048)	<p>Use this function to view the hours of operation of the device.</p> <p>User interface: Depends on the number of hours of operation elapsed: Hours of operation <10 hours → display format = 0:00:00 (hr:min:sec) Hours of operation 10 to 10,000 hours → display format = 0000:00 (hr:min) Hours of operation >10,000 hours → display format = 000000 (hr)</p>

10.2 Group VERSION INFO

10.2.1 Function group DEVICE

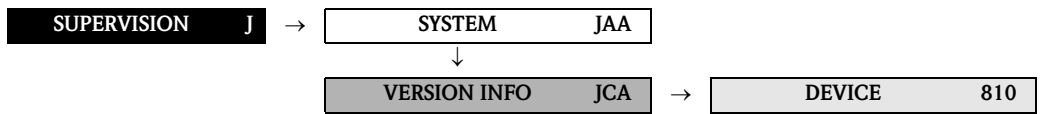

Function description	
SUPERVISION → VERSION INFO → DEVICE	
DEVICE SOFTWARE (8100)	Use this function to view the current device software version.

10.2.2 Function group SENSOR

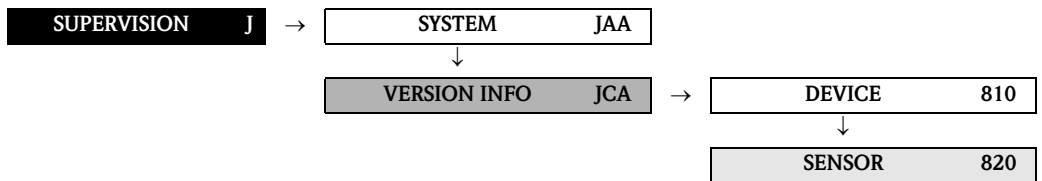

Function description	
SUPERVISION → VERSION INFO → SENSOR	
SERIAL NUMBER (8200)	Use this function to view the serial number of the sensor.
SENSOR TYPE (8201)	Use this function to view the sensor type.
SOFTWARE REVISION NUMBER S-DAT (8205)	Use this function to view the software revision number of the software used to create the content of the S-DAT.

10.2.3 Function group AMPLIFIER

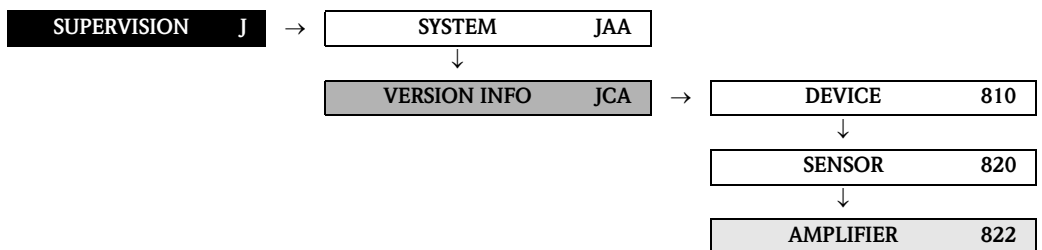



Function description	
SUPERVISION → VERSION INFO → AMPLIFIER	
SOFTWARE REVISION NUMBER AMPLIFIER (8222)	Use this function to view the software revision number of the amplifier.
SOFTWARE REVISION NUMBER T-DAT (8225)	Use this function to view the software revision number of the software used to create the content of the T-DAT.

Function description SUPERVISION → VERSION INFO → AMPLIFIER	
LANGUAGE GROUP (8226)	<p>Use this function to view the language group.</p> <p>The following language groups can be ordered: WEST EU / USA, EAST EU / SCAND., ASIA, CHINA.</p> <p>User interface: available language group</p> <p> Note!</p> <ul style="list-style-type: none"> ■ The language options of the available language group are displayed in the LANGUAGE (2000) function. ■ You can change the language group via the configuration program FieldCare. Please do not hesitate to contact your Endress+Hauser sales office if you have any questions.

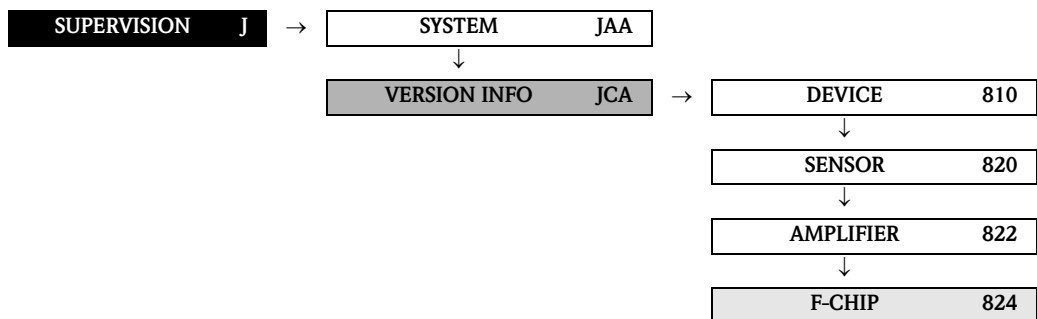
10.2.4 Function group F-CHIP



Function description SUPERVISION → VERSION INFO → F-CHIP	
STATUS F-CHIP (8240)	<p>Use this function to check whether an F-CHIP is installed and which software options are available.</p>
SYSTEM OPTION (8241)	<p> Note! Function is not available unless the measuring device is equipped with an F-CHIP.</p> <p>The software options available in the measuring device appear on the display.</p> <p>User interface: NO ENTRY (= no SW-Options available) ECC ADVANCED DIAGNOSTICS SOLID CONTENT FLOW</p>
SOFTWARE REVISION F-CHIP (8244)	<p> Note! The F-CHIP must be available in order to access this function.</p> <p>Use this function to view the software revision number of the F-CHIP.</p>

10.2.5 Function group I/O MODULE

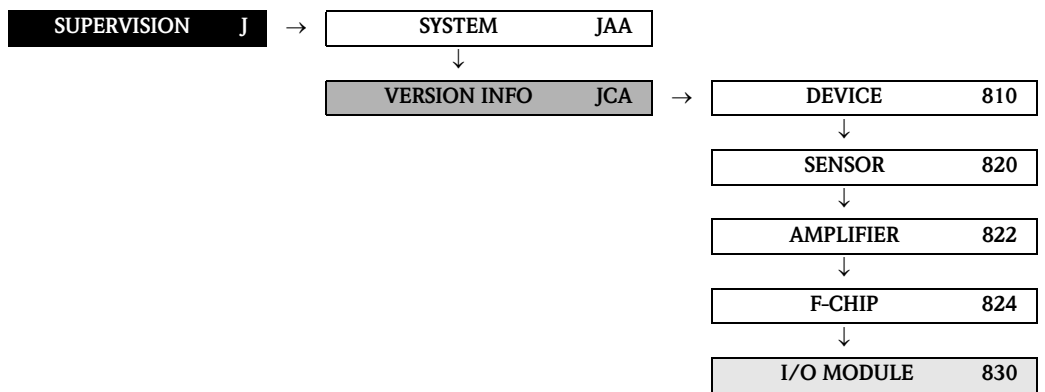

Function description SUPERVISION → VERSION INFO → I/O MODULE	
I/O MODULE TYPE (8300)	Use this function to view the configuration of the I/O module complete with terminal numbers.
SOFTWARE REVISION NUMBER I/O MODULE (8303)	Use this function to view the software revision number of the I/O module.

11 Factory settings

11.1 SI units (not for USA and Canada)

Low flow, full scale value

Nominal diameter [mm]	Low flow cutoff (approx. $v = 0.04$ m/s)		Full scale value (approx. $v = 2.5$ m/s)			
		Volume	Mass	Volume	Mass	
15	0.5	dm ³ /min	kg/min	25	dm ³ /min	kg/min
25	1	dm ³ /min	kg/min	75	dm ³ /min	kg/min
32	2	dm ³ /min	kg/min	125	dm ³ /min	kg/min
40	3	dm ³ /min	kg/min	200	dm ³ /min	kg/min
50	5	dm ³ /min	kg/min	300	dm ³ /min	kg/min
65	8	dm ³ /min	kg/min	500	dm ³ /min	kg/min
80	12	dm ³ /min	kg/min	750	dm ³ /min	kg/min
100	20	dm ³ /min	kg/min	1200	dm ³ /min	kg/min
125	30	dm ³ /min	kg/min	1850	dm ³ /min	kg/min
150	2.5	m ³ /h	t/h	150	m ³ /h	t/h
200	5.0	m ³ /h	t/h	300	m ³ /h	t/h
250	7.5	m ³ /h	t/h	500	m ³ /h	t/h
300	10	m ³ /h	t/h	750	m ³ /h	t/h
350	15	m ³ /h	t/h	1000	m ³ /h	t/h
400	20	m ³ /h	t/h	1200	m ³ /h	t/h
450	25	m ³ /h	t/h	1500	m ³ /h	t/h
500	30	m ³ /h	t/h	2000	m ³ /h	t/h
600	40	m ³ /h	t/h	2500	m ³ /h	t/h

Language

Country	Language
Australia	English
Austria	Deutsch
Belgium	English
China	Chinese
Czech Republic	Czech
Denmark	English
England	English
Finland	Suomi
France	Francais
Germany	Deutsch
Hong Kong	English
Hungary	English
India	English
Indonesia	Bahasa Indonesia
Instruments International	English
Italy	Italiano
Japan	Japanese
Malaysia	English
Netherlands	Nederlands
Norway	Norsk

Country	Language
Poland	Polish
Portugal	Portuguese
Russia	Russian
Singapore	English
South Africa	English
Spain	Espanol
Sweden	Svenska
Switzerland	Deutsch
Thailand	English

Density, length, temperature

	Unit
Density	kg/l
Length	mm
Temperature	° C

11.2 US units (only for USA and Canada)

Low flow, full scale value

Nominal diameter [inch]	Low flow cutoff (approx. v = 0.13 ft/s)			Full scale value (approx. v = 8.2 ft/s)		
		Volume	Mass		Volume	Mass
1/2"	0.10	gal/min	lb/min	6	gal/min	lb/min
1"	0.25	gal/min	lb/min	18	gal/min	lb/min
1 1/4"	0.50	gal/min	lb/min	30	gal/min	lb/min
1 1/2"	0.75	gal/min	lb/min	50	gal/min	lb/min
2"	1.25	gal/min	lb/min	75	gal/min	lb/min
2 1/2"	2.0	gal/min	lb/min	130	gal/min	lb/min
3"	2.5	gal/min	lb/min	200	gal/min	lb/min
4"	4.0	gal/min	lb/min	300	gal/min	lb/min
5"	7.0	gal/min	lb/min	450	gal/min	lb/min
6"	12	gal/min	lb/min	600	gal/min	lb/min
8"	15	gal/min	lb/min	1200	gal/min	lb/min
10"	30	gal/min	lb/min	1500	gal/min	lb/min
12"	45	gal/min	lb/min	2400	gal/min	lb/min
14"	60	gal/min	lb/min	3600	gal/min	lb/min
16"	60	gal/min	lb/min	4800	gal/min	lb/min
18"	90	gal/min	lb/min	6000	gal/min	lb/min
20"	120	gal/min	lb/min	7500	gal/min	lb/min
24"	180	gal/min	lb/min	10500	gal/min	lb/min

Language, density, length, temperature

	Unit
Language	English
Density	g/cc
Length	inch
Temperature	°F

12 Index function matrix

Blocks

A = MEASURED VARIABLES	10
B = QUICK SETUP	16
C = USER INTERFACE	20
E = OUTPUT	37
F = INPUT	84
G = BASIC FUNCTION	88
H = SPECIAL FUNCTION	111
J = SUPERVISION	125

Groups

AAA = MEASURING VALUES	11
ACA = SYSTEM UNITS	12
AEA = SPECIAL UNITS	15
CAA = CONTROL	21
CCA = MAIN LINE	25
CEA = ADDITIONAL LINE	29
CGA = INFORMATION LINE	33
EAA = CURRENT OUTPUT 1	38
EAB = CURRENT OUTPUT 2	38
ECA = PULSE/FREQUENCY OUTPUT 1	49
ECB = PULSE/FREQUENCY OUTPUT 2	49
EGA = RELAY OUTPUT 1	74
EGB = RELAY OUTPUT 2	74
FAA = STATUS INPUT	85
GBA = PROFIBUS DP	89
GCA = PROFIBUS PA	89
GIA = PROCESS PARAMETER	97
GLA = SYSTEM PARAMETER	105
GNA = SENSOR DATA	107
HEA = ADVANCED DIAGNOSTICS	112
HEA = SOLID CONTENT FLOW	124
JAA = SYSTEM	126
JCA = VERSION INFO	129

Function groups

000 = MAIN VALUES	11
040 = CONFIGURATION	12
042 = ADDITIONAL CONFIGURATION	14
070 = DENSITY PARAMETER	15
200 = BASIC CONFIGURATION	21
202 = UNLOCKING/LOCKING	23
204 = OPERATION	24
220 = CONFIGURATION	25
222 = MULTIPLEX	27
240 = CONFIGURATION	29
242 = MULTIPLEX	31
260 = CONFIGURATION	33
262 = MULTIPLEX	35
400 = CONFIGURATION	38
404 = OPERATION	47
408 = INFORMATION	48
420 = CONFIGURATION	49
430 = OPERATION	70
438 = INFORMATION	73
470 = CONFIGURATION	74
474 = OPERATION	78

478 = INFORMATION	80
500 = CONFIGURATION	85
504 = OPERATION	86
508 = INFORMATION	87
610 = CONFIGURATION	89
612 = FUNCTION BLOCKS	90
613 = TOTALIZER	92
614 = OPERATION	95
616 = INFORMATION	96
640 = CONFIGURATION	97
642 = EPD PARAMETER	100
644 = ECC PARAMETER	102
648 = ADJUSTMENT	104
660 = CONFIGURATION	105
680 = CONFIGURATION	107
682 = OPERATION	109
750 = CONFIGURATION	114
751 = ACQUISITION	115
752 = CONFIGURATION COATING	116
753 = COATING E1	117
754 = COATING E2	118
755 = ELECTRODE POTENTIAL 1	119
756 = ELECTRODE POTENTIAL 2	120
757 = VOLUME FLOW	121
758 = NOISE VALUE	122
770 = CONFIGURATION	124
800 = CONFIGURATION	126
804 = OPERATION	127
810 = DEVICE	129
820 = SENSOR	129
822 = AMPLIFIER	129
824 = F-CHIP	130
830 = I/O MODULE	131

Functions 0...

0000 = CALCULATED MASS FLOW	11
0001 = VOLUME FLOW	11
0005 = DENSITY	11
0400 = UNIT MASS FLOW	12
0401 = UNIT MASS	12
0402 = UNIT VOLUME FLOW	13
0403 = UNIT VOLUME	13
0420 = UNIT DENSITY	14
0424 = UNIT LENGTH	14
0429 = FORMAT DATE TIME	14
0700 = DENSITY VALUE	15

Functions 1...

1002 = QUICK SETUP COMMISSION	16
1006 = QUICK SETUP COMMUNICATION	16
1009 = T DAT SAVE/LOAD	16

Functions 2...

2000 = LANGUAGE	21
2002 = DISPLAY DAMPING	21
2003 = CONTRAST LCD	22
2004 = BACKLIGHT	22

2020 = ACCESS CODE	23
2021 = DEFINE PRIVATE CODE	23
2022 = STATUS ACCESS	23
2023 = ACCESS CODE COUNTER	23
2040 = TEST DISPLAY	24
2200 = ASSIGN	25
2201 = 100% VALUE	25
2202 = FORMAT	26
2220 = ASSIGN	27
2221 = 100% VALUE	27
2222 = FORMAT	28
2400 = ASSIGN	29
2401 = 100% VALUE	30
2402 = FORMAT	30
2403 = DISPLAY MODE	30
2420 = ASSIGN	31
2421 = 100% VALUE	32
2422 = FORMAT	32
2423 = DISPLAY MODE	32
2600 = ASSIGN	33
2601 = 100% VALUE	34
2602 = FORMAT	34
2603 = DISPLAY MODE	34
2620 = ASSIGN	35
2621 = 100% VALUE	36
2622 = FORMAT	36
2623 = DISPLAY MODE	36

Functions 4...

4000 = ASSIGN CURRENT OUTPUT	38
4001 = CURRENT SPAN	39
4002 = VALUE 0_4 mA	40, 41
4003 = VALUE 20 mA	42
4004 = MEASURING MODE	43, 44
4005 = TIME CONSTANT	45
4006 = FAILSAFE MODE	46
4040 = ACTUAL CURRENT	47
4041 = SIMULATION CURRENT	47
4042 = VALUE SIMULATION CURRENT	47
4080 = TERMINAL NUMBER	48
4200 = OPERATION MODE	49
4201 = ASSIGN FREQUENCY	49
4202 = START VALUE FREQUENCY	50
4203 = END VALUE FREQUENCY	50
4204 = VALUE F LOW	51
4205 = VALUE-F HIGH	51
4206 = MEASURING MODE	53
4207 = OUTPUT SIGNAL	55
4208 = TIME CONSTANT	58
4209 = FAILSAFE MODE	58
4211 = FAILSAFE VALUE	58
4221 = ASSIGN PULSE	59
4222 = PULSE VALUE	59
4223 = PULSE WIDTH	60
4225 = MEASURING MODE	61
4226 = OUTPUT SIGNAL	62
4227 = FAILSAFE MODE	65
4241 = ASSIGN STATUS	66
4242 = ON VALUE	67
4243 = SWITCH-ON DELAY	67

4244 = OFF-VALUE	67
4245 = SWITCH-OFF DELAY	68
4246 = MEASURING MODE	68
4247 = TIME CONSTANT	69
4301 = ACTUAL FREQUENCY	70
4302 = SIMULATION FREQUENCY	70
4303 = VALUE SIMULATION FREQUENCY	70
4322 = SIMULATION PULSE	71
4323 = VALUE SIMULATION PULSE	71
4341 = ACTUAL STATUS	72
4342 = SIMULATION SWITCH POINT	72
4343 = VALUE SIMULATION SWITCH POINT	72
4380 = TERMINAL NUMBER	73
4700 = ASSIGN RELAY	74
4701 = ON-VALUE	75
4702 = SWITCH-ON DELAY	75
4703 = OFF-VALUE	75
4704 = SWITCH-OFF DELAY	76
4705 = MEASURING MODE	76
4706 = TIME CONSTANT	77
4740 = ACTUAL STATUS RELAY	78
4741 = SIMULATION SWITCH POINT	78
4742 = VALUE SIMULATION SWITCH POINT	79
4780 = TERMINAL NUMBER	80

Functions 5...

5000 = ASSIGN STATUS INPUT	85
5001 = ACTIVE LEVEL	85
5002 = MINIMUM PULSE WIDTH	85
5040 = ACTUAL STATUS INPUT	86
5041 = SIMULATION STATUS INPUT	86
5042 = VALUE SIMULATION STATUS INPUT	86
5080 = TERMINAL NUMBER	87

Functions 6...

6100 = TAG NAME	89
6101 = FIELD BUS ADDRESS	89
6102 = WRITE PROTECT	89
6120 = BLOCK SELECTION	90
6121 = OUT VALUE	90
6122 = DISPLAY VALUE	90
6123 = CHANNEL	91
6130 = SELECT TOTALIZER	92
6131 = TOTALIZER OUT VALUE	92
6132 = OVERFLOW	92
6133 = CHANNEL	92
6134 = UNIT TOTALIZER	93
6135 = SET TOTALIZER	93
6136 = PRESET TOTALIZER	93
6137 = TOTALIZER MODE	94
6138 = CYCL. CALC. TOT.	94
6140 = SELECTION GSD	95
6141 = SET UNIT TO BUS	95
6160 = PROFILE VERSION	96
6161 = ACTUAL BAUD RATE	96
6162 = DEVICE ID	96
6163 = CHECK CONFIGURATION	96
6400 = ASSIGN LOW FLOW CUTOFF	97
6402 = ON-VALUE LOW FLOW CUTOFF	97
6403 = OFF-VALUE LOW FLOW CUTOFF	97

6404 = PRESSURE SHOCK SUPPRESSION	98
6405 = CONDUCTIVITY	99
6420 = EMPTY PIPE DETECTION (EPD)	100
6425 = EPD RESPONSE TIME	101
6440 = ECC	102
6441 = ECC DURATION	102
6442 = ECC RECOVERY TIME	103
6443 = ECC CLEANING CYCLE	103
6481 = EPD ADJUSTMENT	104
6600 = INSTALLATION DIRECTION SENSOR	105
6601 = MEASURING MODE	105
6603 = SYSTEM DAMPING	105
6604 = INTEGRATION TIME	105
6605 = POSITIVE ZERO RETURN	106
6800 = CALIBRATION DATE	107
6801 = K-FACTOR	107
6803 = ZERO POINT	107
6804 = NOMINAL DIAMETER	108
6820 = MEASURING PERIOD	109
6822 = EPD ELECTRODE	109
6823 = POLARITY ECC	109
6824 = CONDUCTIVITY ENABLE	110

Functions 7...

7501 = REFERENCE STATUS USER	114
7502 = SELECTION REFERENCE STATUS	114
7503 = WARNING MODE	114
7510 = ACQUISITION MODE	115
7511 = ACQUISITION PERIOD	115
7512 = ACQUISITION MANUAL	115
7513 = RESET HISTORY	115
7520 = DETECTION COATING	116
7521 = VOLTAGE COATING PULSE	116
7522 = PULSE DURATION	116
7523 = RECOVERY TIME	116
7530 = REFERENCE VALUE COATING E1	117
7531 = ACTUAL VALUE COATING E1	117
7532 = MINIMUM VALUE COATING E1	117
7533 = MAXIMUM VALUE COATING E1	117
7534 = MAXIMUM VALUE COATING E1	117
7535 = ACT. DEVIATION COATING E1	117
7536 = WARNING COATING E1	117
7540 = REFERENCE VALUE COATING E2	118
7541 = ACTUAL VALUE COATING E2	118
7542 = MINIMUM VALUE COATING E2	118
7543 = MAXIMUM VALUE COATING E2	118
7544 = HISTORY COATING E2	118
7545 = ACT. DEVIATION COATING E2	118
7546 = WARNING COATING E2	118
7550 = REFERENCE VALUE ELECTR. POT. 1	119
7551 = ACTUAL VALUE ELECTR. POT. 1	119
7552 = MINIMUM VALUE ELECTR. POT. 1	119
7553 = MAXIMUM VALUE ELECTR. POT.1	119
7554 = HISTORY ELECTR. POT.1	119
7555 = ACT. DEVIATION ELECTR. POT.1	119
7560 = REFERENCE VALUE ELECTR. POT. 2	120
7561 = ACTUAL VALUE ELECTR. POT. 2	120
7562 = MINIMUM VALUE ELECTR. POT. 2	120
7563 = MAXIMUM VALUE ELECTR. POT.2	120
7564 = HISTORY ELECTR. POT.2	120

7565 = ACT. DEVIATION ELECTR. POT.2	120
7570 = REFERENCE VALUE VOLUME FLOW	121
7571 = ACTUAL VALUE VOLUME FLOW	121
7572 = MINIMUM VALUE VOLUME FLOW	121
7573 = MAXIMUM VALUE VOLUME FLOW	121
7574 = HISTORY VOLUME FLOW	121
7575 = ACT. DEVIATION VOLUME FLOW	121
7580 = REFERENCE VALUE	122
7581 = ACTUAL VALUE NOISE VALUE	122
7582 = MINIMUM VALUE NOISE VALUE	122
7583 = MAXIMUM VALUE NOISE VALUE	122
7584 = HISTORY NOISE VALUE	122
7585 = ACTUAL DEVIATION NOISE VALUE	122
7586 = WARNING NOISE VALUE	123
7711 = CARRIER DENSITY	124
7712 = TARGET MAT. DENSITY	124

Functions 8...

8005 = ALARM DELAY	126
8007 = PERMANENT SAVING	126
8040 = ACTUAL SYSTEM CONDITION	127
8041 = PREVIOUS SYSTEM CONDITIONS	127
8042 = SIMULATION FAILSAFE MODE	127
8043 = SIMULATION MEASURAND	127
8044 = VALUE SIMULATION MEASURAND	128
8046 = SYSTEM RESET	128
8048 = OPERATION HOURS	128
8100 = DEVICE SOFTWARE	129
8200 = SERIAL NUMBER	129
8201 = SENSOR TYPE	129
8205 = SOFTWARE REV. NO. S-DAT	129
8222 = SOFTWARE REV. NO. AMPLIFIER	129
8225 = SOFTWARE REV. NO. T-DAT	129
8226 = LANGUAGE GROUP	130
8240 = STATUS F-CHIP	130
8300 = I/O MODULE TYPE	131
8303 = SOFTWARE REV. NO. I/O MODULE	131

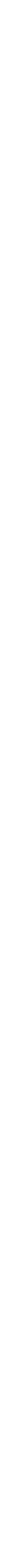

13 Index of key words

A

Abrasion (measuring electrodes)	112
Active level (status input)	85
Actual	
Current (current output)	47
Frequency	70
Relay output	78
Status input	86
Status (pulse/frequency output)	72
Actual baud rate	96
Actual system condition	127
Additional configuration (system units)	14
Additional line	
Configuration	29
Multiplex	31
Adjustment EPD	104
Advanced diagnostics	112
Alarm delay	126
Amplifier (version info)	129
Assign	
Additional line	29
Additional line (Multiplex)	31
Current output	38
Frequency (pulse/frequency output)	49
Information line	33
Information line (Multiplex)	35
Low flow cutoff	97
Main line	25
Main line (Multiplex)	27
Pulse output	59
Relay (relay output)	74
Status input	85
Status (pulse/frequency output)	66
Available functions	8

B

Basic configuration (user interface)	21
Basic function	88
Block	
Basic function	88
Display	20
Inputs	84
Measured variables	10
Outputs	37
Quick Setup	16
Special function	111
Supervision	125
Block selection	90
Block Supervision	125

C

Calibration Date	107
Channel	
Function blocks	91
Totalizer	92
Check configuration	96
Coating detection (detection of build-up)	112

Coating detection, activating (procedure)	113
Code	
Access	23
Define private code	23
Commissioning	16
Communication (Quick Setup)	16
Conductivity	99
Conductivity enable	110
Configuration	
Additional line	29
Current output	38
Information line	33
Main line	25
Process parameter	97
PROFIBUS PA	89
Pulse/frequency output	49
Relay output	74
Sensor data	107
Status input	85
System	126
System parameter	105
System units	12
Contrast LCD	22
Control	
Basic configuration	21
Operation	24
Unlocking/locking	23
Corrosion (measuring electrodes)	112
Current output	
Configuration	38
Current span	39
Information	48
Operation	47
Cycl. Calc. Totalizer	94

D

Damping	
Display	21
Relay, time constants	77
Status output, time constants	69
System, reaction time	105
Define private code	23
Density	
Density parameter (introduction)	15
Density value (display)	11
Density value (input)	15
Device ID	96
Device software	129
Device (version info)	129
Diagnostics, advanced	112
Display	20
Contrast LCD	22
Display test	24
Language selection	21
Lighting (back lighting)	22
See User interface	
Display lines of local operation	8

Display mode		Relay output	74
Additional line	30	Sensor data	107
Additional line (Multiplex)	32	Solid content flow	124
Information line	34	Status input	85
Information line (Multiplex)	36	System	126
Display value	90	System parameter	105
E		System units	12
ECC (Electrode Cleaning Circuitry)	102	Density parameter	15
Cleaning cycle	103	Device	129
Duration	102	ECC parameter	102
Parameter	102	Electrode potential 1	119
Polarity	109	Electrode potential 2	120
Recovery time	103	EPD parameter	100
Electrode potentials	112	F-CHIP	130
Empty pipe detection (EPD)		Function blocks	90
Empty/Full pipe adjustment	104	Information	96
EPD electrode	109	Current output	48
General information	100	Pulse/Frequency output	73
Response time	101	Relay output	80
Switching on/off	100	Status input	87
End value frequency	50	I/O module	131
EPD		Main values	11
See Empty Pipe Detection		Multiplex	
F		Additional line	31
Factory settings	132	Information line	35
Failsafe mode		Main line	27
Current output	46	Noise value (diagnostics)	122
Frequency output	58	Operation	95
Pulse output	65	Current output	47
Failsafe value	58	Display	24
F-CHIP (version info)	130	Pulse/frequency output	70
Fieldbus address	89	Relay output	78
Format		Status input	86
Additional line	30	System	127
Additional line (Multiplex)	32	Sensor	129
Information line	34	Totalizer (PROFIBUS PA)	92
Information line (Multiplex)	36	Unlocking/locking (display)	23
Main line	26	Volume flow (diagnostics)	121
Main line (Multiplex)	28	Function matrix	
Function group		General layout	6
Acquisition (diagnostic parameters)	115	Identification code	7
Additional configuration (system units)	14	Overview	9
Adjustment	104	G	
Amplifier	129	Group	
Basic configuration (user interface)	21	Additional line	29
Coating electrode 1	116	Advanced diagnostics	112
Coating electrode 2	118	Control (user interface)	21
Configuration		Current output	38
Additional line	29	Information line	33
Advanced diagnostics	114	Main line	25
Coating	116	Measuring values	11
Current output	38	Process parameter	90, 97
Information line	33	PROFIBUS PA	89
Main line	25	Pulse/frequency output	49
Operation	109	Relay output	74
Process parameter	97	Sensor data	107
PROFIBUS PA	89	Solid content flow	124
Pulse/Frequency output	49	Special units	15
		Status input	85

System	126	On value	
System parameter	105	Low flow cutoff	97
System units	12	Relay output	75
Version info	129	Status (pulse/frequency output)	67
I		Operation	
Information		Current output	47
Current output	48	Display	24
Pulse/frequency output	73	Pulse/frequency output	70
Relay output	80	Relay output	78
Status input	87	Sensor data	109
Information line		Status input	86
Configuration	33	System	127
Multiplex	35	Operation hours	128
Inputs	84	Operation mode	
Installation direction sensor	105	Pulse/frequency output	49
Integration time	105	OUT Value	90
I/O module type	131	Output signal	
K		Frequency output	55
K-Factor	107	Pulse output	62
L		Outputs	37
Language		Overflow	92
Factory settings (country)	132	P	
Language group (display)	130	Polarity ECC	109
Select	21	Positive zero return	106
LCD contrast	22	Preset Totalizer	93
Local operation (display lines)	8	Pressure shock suppression	98
Low flow cutoff	97	Previous system conditions	127
M		Process parameter	
Main line		Adjustment	104
Configuration	25	Configuration	97
Multiplex	27	ECC parameter	102
Main values	11	EPD parameter	100
Mass flow (calculated)	11	PROFIBUS PA	89
Measured variables (block A)	10	Profile version	96
Measuring mode	105	Pulse value	59
Current output	43, 44	Pulse Width	60
Frequency (pulse/frequency output)	53, 54	Pulse/frequency output	
Pulse output	61	Configuration	49
Relay output	76	Information	73
Status (pulse/frequency output)	68	Operation	70
Measuring period, sensor	109	Q	
Measuring values	11	Quick Setup	
Main values	11	Commissioning	16
Minimum Pulse width	85	Communication	16
Multiplex		Quick Setup (Block B)	16
Additional line	31	R	
Information line	35	Reference condition	
Main line	27	Deviation - coating electrode 1	117
N		Deviation - coating electrode 2	118
Nominal diameter	108	Deviation (of the diagnostic parameters)	113
O		Relay output	
Off value		Configuration	74
Low flow cutoff	97	General	81
Relay output	75	Information	80
Status (pulse/frequency output)	67	Operation	78
		Switching response	82

Reset	
System	128
S	
Select	
Totalizer	92
Selection GSD	95
Sensor	
Configuration	107
Installation direction	105
K-Factor	107
Measuring mode	105
Measuring period	109
Operating data	109
see sensor	
Version info	129
Zero point	107
Serial number sensor	129
Set Totalizer	93
Set unit to bus	95
Simulation	
Current (current output)	47
Failsafe mode	127
Frequency	70
Measured variable	127
Pulse	71
Relay output switch point	78
Status input	86
Switch point status (pulse/frequency output)	72
Software revision number	
Amplifier	129
I/O module	131
S-DAT	129
T-DAT	129
Solid flow measurement	124
Special units	
Arbitrary unit	15
Density parameter	15
Start value frequency	50
Status access	23
Status F-CHIP	130
Status input	
Configuration	85
Information	87
Operation	86
Storage	126
Switching response of the relay output	82
Switch-off delay	
Relay output	76
Status (pulse/frequency output)	68
Switch-on delay	
Relay output	75
Status (pulse/frequency output)	67
System	
Configuration	126
Damping	105
Operation	127
Operation hours	128
Reset	128

System condition	
Actual	127
Previous	127
System parameters, configuration	105
System units	
Additional configuration	14
Configuration	12
T	
Tag name	89
T-DAT save/load	16
Terminal number	
Current output	48
Pulse/frequency output	73
Relay output	80
Status input	87
Test display	24
Test pulses (coating detection)	112
Time constant	
Current output	45
Frequency output	58
Relay output	77
Status (pulse/frequency output)	69
Totalizer mode	94
Totalizer out value	92
Totalizer unit	93
Trend analysis (diagnostics)	113
Type I/O Module	
See I/O module type	
U	
Unit	
Density	14
Length	14
Mass	12
Mass flow	12
Volume	13
Volume flow	13
Unlocking/locking (display)	23
V	
Value F High	51
Value F Low	51
Value simulation	
Current (current output)	47
Frequency	70
Measured variable	128
Pulse	71
Relay output switch point	79
Status input	86
Switch point status (pulse/frequency output)	72
Value 0_4 mA	
Current output	40
Value 20 mA	
Current output	42

Version info	
Amplifier	129
F-CHIP	130
I/O module	131
Sensor	129
Volume flow (display)	11
W	
Write protect	89
Z	
Zero point	107
Numbers	
100% value flow	
Additional line	30
Additional line (Multiplex)	32
Information line	34
Information line (Multiplex)	36
Main line	25
Main line (Multiplex)	27

www.endress.com/worldwide

Endress+Hauser 
People for Process Automation