

Safety Instructions

Liquiphant M, Liquiphant S FTL50(H), FTL51(H), FTL51C, FTL70/71

ATEX, IECEx: Ex ia IIC Ga/Gb
Ex db ia IIC Ga/Gb
Ex ia IIC Da/Db



Liquiphant M, Liquiphant S FTL50(H), FTL51(H), FTL51C, FTL70/71

Table of contents

About this document	4
Associated documentation	4
Supplementary documentation	4
General notes: Combined approval	4
Manufacturer's certificates	5
Manufacturer address	5
Other standards	6
Extended order code	6
Safety instructions: General	11
Safety instructions: Special conditions	11
Safety instructions: Installation	12
Explosion protection with heat insulation	16
Temperature tables	16
Connection data	30

About this document

 This document has been translated into several languages. Legally determined is solely the English source text.

The document translated into EU languages is available:

- In the download area of the Endress+Hauser website:
www.endress.com -> Downloads -> Manuals and Datasheets -> Type: Ex Safety Instruction (XA) -> Text Search: ...
- In the Device Viewer: www.endress.com -> Product tools -> Access device specific information -> Check device features

 If not yet available, the document can be ordered.

Associated documentation

This document is an integral part of the following Operating Instructions:

- KA00143F/00, KA00163F/00 (FTL50, FTL51)
- KA00144F/00, KA00164F/00 (FTL50H, FTL51H)
- KA00162F/00, KA00165F/00 (FTL51C)
- KA00172F/00, KA00173F/00 (FTL70, FTL71)

Supplementary documentation

Explosion-protection brochure: CP00021Z/11

The Explosion-protection brochure is available:

- In the download area of the Endress+Hauser website:
www.endress.com -> Downloads -> Brochures and Catalogs -> Text Search: CP00021Z
- On the CD for devices with CD-based documentation

**General notes:
Combined approval**

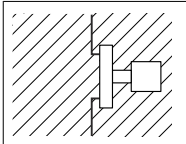
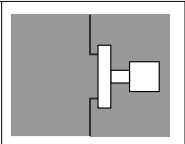
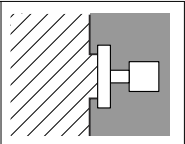
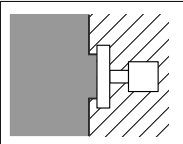
							
Ex ia IIC		Ex ia IIIC		Ex ia IIC	Ex ia IIIC	Ex ia IIIC	Ex ia IIC
Zone 0 or Zone 1	Zone 1	Zone 20 or Zone 21	Zone 21	Zone 0 or Zone 1	Zone 21	Zone 20 or Zone 21	Zone 1

The device is designed for operation in explosive gas or explosive dust atmosphere as shown in the sketch above. In the event of potentially

explosive gas-air and dust-air mixtures occurring simultaneously:
Suitability requires further assessment.



A sequential change between gas and dust explosion protection is only possible if:

- A period with non-explosive atmosphere is realized during the transition or
- Special examinations are done which are not covered by the certificate

Manufacturer's certificates

EU Declaration of Conformity

Declaration Number:
EG99021

The EU Declaration of Conformity is available:
In the download area of the Endress+Hauser website:
www.endress.com -> Downloads -> Declaration ->
Type: EU Declaration -> Product Code: ...

EU type-examination certificate

Certificate number:
KEMA 99 ATEX 0523 X

List of applied standards: See EU Declaration of Conformity.

IEC Declaration of Conformity

Certificate number:
IECEX DEK 15.0028X

Affixing the certificate number certifies conformity with the following standards (depending on the device version):

- IEC 60079-0 : 2017
- IEC 60079-1 : 2014
- IEC 60079-11 : 2011
- IEC 60079-26 : 2021

Manufacturer address

Endress+Hauser SE+Co. KG
Hauptstraße 1
79689 Maulburg, Germany

Address of the manufacturing plant: See nameplate.

- Other standards** Among other things, the following standards shall be observed in their current version for proper installation:
- IEC/EN 60079-14: "Explosive atmospheres - Part 14: Electrical installations design, selection and erection"
 - EN 1127-1: "Explosive atmospheres - Explosion prevention and protection - Part 1: Basic concepts and methodology"

Extended order code The extended order code is indicated on the nameplate, which is affixed to the device in such a way that it is clearly visible. Additional information about the nameplate is provided in the associated Operating Instructions.

Structure of the extended order code

FTL5x(x), FTL7x	-	*****	+	A*B*C*D*E*F*G*..
<i>(Device type)</i>		<i>(Basic specifications)</i>		<i>(Optional specifications)</i>

* = Placeholder

At this position, an option (number or letter) selected from the specification is displayed instead of the placeholders.

Basic specifications

The features that are absolutely essential for the device (mandatory features) are specified in the basic specifications. The number of positions depends on the number of features available. The selected option of a feature can consist of several positions.

Optional specifications

The optional specifications describe additional features for the device (optional features). The number of positions depends on the number of features available. The features have a 2-digit structure to aid identification (e.g. JA). The first digit (ID) stands for the feature group and consists of a number or a letter (e.g. J = Test, Certificate). The second digit constitutes the value that stands for the feature within the group (e.g. A = 3.1 material (wetted parts), inspection certificate).

More detailed information about the device is provided in the following tables. These tables describe the individual positions and IDs in the extended order code which are relevant to hazardous locations.

Extended order code: Liquiphant M



The following specifications reproduce an extract from the product structure and are used to assign:

- This documentation to the device (using the extended order code on the nameplate).
- The device options cited in the document.

Device type

FTL50, FTL50H, FTL51, FTL51H, FTL51C

Basic specifications

Position 1 (Approval)		
Selected option		Description
FTL50(H) FTL51(H)	F, G	ATEX II 1/2 G Ex ia IIC T6...T1 Ga/Gb ATEX II 1/2 D Ex ia IIIC Txx°C Da/Db IECEX Ex ia IIC T6...T1 Ga/Gb IECEX Ex ia IIIC Txx°C Da/Db
FTL51C	F ¹⁾	ATEX II 1/2 G Ex ia IIC T6...T1 Ga/Gb ATEX II 1/2 D Ex ia IIIC Txx°C Da/Db IECEX Ex ia IIC T6...T1 Ga/Gb IECEX Ex ia IIIC Txx°C Da/Db
	1 ²⁾	ATEX II 1/2 G Ex ia IIB T6...T1 Ga/Gb IECEX Ex ia IIB T6...T1 Ga/Gb

1) Only in connection with Position 5, 6 = xN, xS

2) Only in connection with Position 5, 6 = xL, xM, xK

Position 5, 6 (Probe Length, Type)		
Selected option		Description
FTL50	Ax	Compact
	Ix	Compact; temp. separator
	Qx	Compact; press.tight feed through
FTL50H	Ax	Compact
	Ix	Compact; temp. separator
	Qx	Compact; press.tight feed through
	xD	Compact; Ra<0,3um/12uin

Position 5, 6 (Probe Length, Type)		
Selected option		Description
FTL51	BB, CB, DB mm/in; 316L
	BE, CE, DE mm/in; Alloy
	JB, KB, LB mm/in; 316L + temp. separator
	JE, KE, LE mm/in; Alloy + temp. separator
	RB, SB, TB mm/in; 316L + press.tight feed through
	RE, SE, TE mm/in; Alloy + press.tight feed through
	FTL51H	Bx, Cx, Dx
Jx, Kx, Lx	 mm/in; temp. separator
Rx, Sx, Tx	 mm/in; press.tight feed through
xD		Compact; Ra<0,3um/12uin
FTL51C	xK	ECTFE ¹⁾
	xL	PFA (Edlon) ¹⁾
	xM	PFA (RubyRed) ¹⁾
	xN	PFA (conductive)
	xS	Enamel

1) Only for Ex ia IIB Ga/Gb

Position 7 (Electronics, Output)		
Selected option		Description
FTL50(H)	A	FEL50A; PROFIBUS PA
FTL51(H) FTL51C	D	FEL50D; Density/Concentration, density electronics w/o WHG approval
	5	FEL55; SIL 8/16 mA, 11-36 VDC
	6	FEL56; SIL NAMUR (L-H signal)
	7	FEL57; SIL 2-wire PFM
	8	FEL58; SIL NAMUR+test button (H-L signal)

Position 8, 9 (Housing, Cable Entry)		
Selected option		Description
FTL50 FTL51 FTL51C	x1	F27; 316L
FTL50(H) FTL51(H)	x3	Compact, 316L hygiene
FTL50(H) FTL51(H)	x5	F13; Alu
FTL51C	x6	F15, 316L hygiene
	x7	T13; Alu, coated.; separate conn. compartment

Position 11 (Additional Option 2)		
Selected option		Description
FTL51C	A	Not selected
	B	Temp. separator
	C	2nd line of defence (press.tight feed through)

Optional specifications

No options specific to hazardous locations are available.

Extended order code: Liquiphant S



The following specifications reproduce an extract from the product structure and are used to assign:

- This documentation to the device (using the extended order code on the nameplate).
- The device options cited in the document.

Device type

FTL70, FTL71

Basic specifications

Position 1 (Approval)		
Selected option		Description
FTL7x	F	ATEX II 1/2 G Ex db ia IIC T6...T1 Ga/Gb ATEX II 1/2 D Ex ia IIIC Txx°C Da/Db IECEX Ex db ia IIC T6...T1 Ga/Gb IECEX Ex ia IIIC Txx°C Da/Db

Position 5, 6 (Probe Length, Type)		
Selected option		Description
FTL70	AB	Compact; 316L
	AE	Compact; Alloy
FTL71	xB mm/in; 316L
	xE mm/in; Alloy

Position 7 (Electronics, Output)		
Selected option		Description
FTL7x	A	FEL50A; PROFIBUS PA
	5	FEL55; SIL 8/16 mA, 11-36 VDC
	6	FEL56; SIL NAMUR (L-H signal)
	7	FEL57; SIL 2-wire PFM
	8	FEL58; SIL NAMUR+test button (H-L signal)
	9	Special version: FEL50D

Position 8, 9 (Housing, Cable Entry)		
Selected option		Description
FTL7x	x1	F27; 316L
	x5	F17; Alu
	x6	F15, 316L hygiene
	x7	T13; Alu, coated.; separate conn. compartment
	x8	F13, Alu

Position 11 (Application)		
Selected option		Description
FTL7x	L	230 °C, gas-tight feed through
	N	280 °C, gas-tight feed through
	Y	Special version: 300 °C

Optional specifications

No options specific to hazardous locations are available.

Safety instructions:
General

- The device is intended to be used in explosive atmospheres as defined in the scope of IEC 60079-0 or equivalent national standards. If no potentially explosive atmospheres are present or if additional protective measures have been taken: The device may be operated according to the manufacturer's specifications.
- Staff must meet the following conditions for mounting, electrical installation, commissioning and maintenance of the device:
 - Be suitably qualified for their role and the tasks they perform
 - Be trained in explosion protection
 - Be familiar with national regulations
- Install the device according to the manufacturer's instructions and national regulations.
- Do not operate the device outside the specified electrical, thermal and mechanical parameters.
- Only use the device in media to which the wetted materials have sufficient durability.
- Avoid electrostatic charging:
 - Of plastic surfaces (e.g. enclosure, sensor element, special varnishing, attached additional plates, ..)
 - Of isolated capacities (e.g. isolated metallic plates)
- Refer to the temperature tables for the relationship between the permitted ambient temperature for the sensor and/or transmitter, depending on the range of application and the temperature class.
- Modifications to the device can affect the explosion protection and must be carried out by staff authorized to perform such work by Endress+Hauser.

All versions except Device type FTL50H, FTL51H, Basic specification, Position 5, 6 = xD

The probe is made of stainless steel or high corrosion-resistant alloy of thickness ≥ 1 mm.

Device type FTL50H, FTL51H, Basic specification, Position 5, 6 = xD

The probe is made of stainless steel or high corrosion-resistant alloy of thickness within 0.2 to 1 mm.

Safety instructions:
Special conditions

- Limitations of the maximum ambient temperature at the electronics enclosure may be required dependent on device configuration, process temperatures and temperature classification.
- Details of limitations: →  16, "Temperature tables".
- To avoid electrostatic charging: Do not rub surfaces with a dry cloth.
- In the event of additional or alternative special varnishing on the enclosure or other metal parts or for adhesive plates:
 - Observe the danger of electrostatic charging and discharge.
 - Do not install in the vicinity of processes (≤ 0.5 m) generating strong electrostatic charges.

Basic specification, Position 8, 9 = x5, x7, x8
 Avoid sparks caused by impact and friction.

Device type FTL50H, FTL51H, Basic specification, Position 5, 6 = xD
 The probe must not be subjected to abrasive or corrosive medium that may adversely affect the partition for the zone separation.

Device type FTL51C

In the case of process connections made of polymeric material or with polymeric coatings, avoid electrostatic charging of the plastic surfaces.

Type of protection Ex db

The high-temperature part of the device (fork/pipe/process connection/temperature spacer) is designed in type of protection Ex db and has an Ex ia connection to the electronics insert.

The installation on the terminals of the device must always be carried out in type of protection Ex i.

Safety instructions: Installation

Basic specification, Position 7 = D, 5, 6, 7, 8, 9

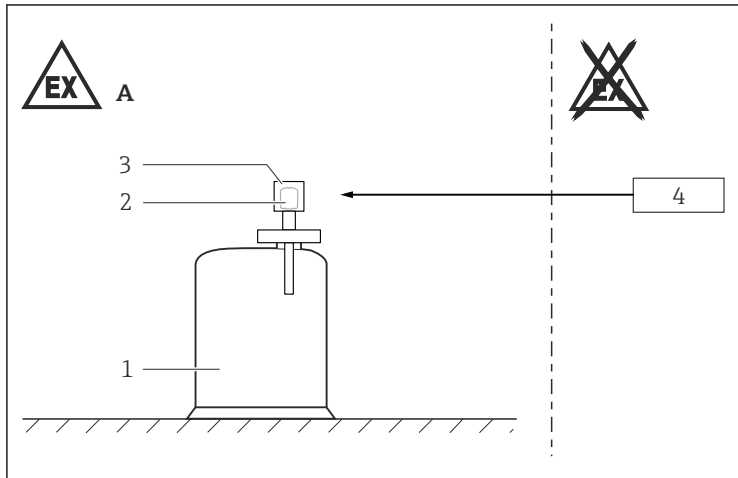

A0034474



- 1 Zone 1, Zone 21
 1 Tank; Zone 0, Zone 20
 2 Electronic insert
 3 Enclosure
 4 *Basic specification, Position 7 = 5, 6, 7, 8:*
 Associated intrinsically safe power supply units
Basic specification, Position 7 = D, 9:
 Only associated intrinsically safe power supply unit FML621 from
 Endress+Hauser

Basic specification, Position 7 = A

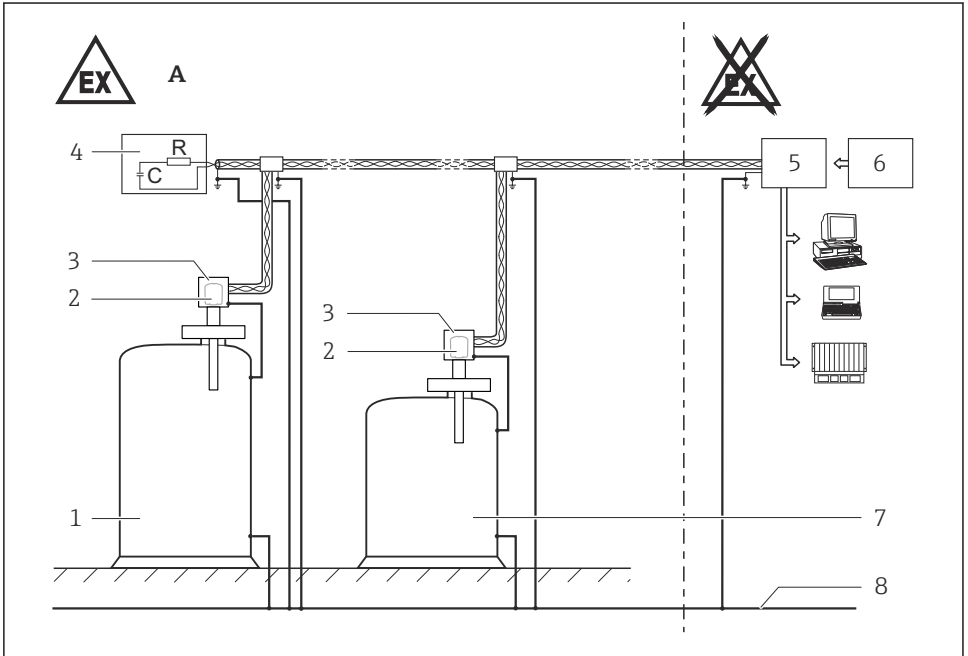

A0034491

 2

- A Zone 1, Zone 21
 1 Tank; Zone 0, Zone 20
 2 Electronic insert
 3 Enclosure
 4 Permitted terminating resistor Ex ia IIC
 5 Certified associated apparatus
 6 Power supply
 7 Tank; Zone 1, Zone 21
 8 Potential equalization

- Connect the device using suitable cable and wire entries of protection type "Intrinsic safety (Ex i)". An ingress protection of at least IP54 must be achieved.
- When the device is connected to certified intrinsically safe circuits of Category Ex ib for Equipment Groups IIC and IIB, the type of protection changes to Ex ib IIC and Ex ib IIB.
- Continuous service temperature of the connecting cable: $\geq T_a + 5 \text{ K}$.
- Perform the following to achieve the degree of protection IP66/67:
 - Screw the cover tight.
 - Mount the cable entry correctly.

- Seal unused entry glands with approved sealing plugs that correspond to the type of protection.
- Observe the pertinent guidelines when interconnecting intrinsically safe circuits.
- Connection of intrinsically safe PROFIBUS devices: 10 devices.
- Observe the maximum process conditions according to the manufacturer's Operating Instructions.
- At high medium temperatures, note flange pressure load capacity as a factor of temperature.
- Install the device to exclude any mechanical damage or friction during the application. Pay particular attention to flow conditions and tank fittings.
- Support extension tube of the device if a dynamic load is expected.

Accessory high pressure sliding sleeve

The high pressure sliding sleeve can be used for a continuous setting of the switch point and is suited for zone separation if mounted properly (see Operating Instructions).

Device group III, Application in dust

- To ensure the ingress protection IP54: Only use the unit-mounted cable entries, sealing plugs and O-rings.
- Supplied cable glands and metallic sealing plugs comply with the requirements of type of protection marked on the nameplate.

Permitted ambient conditions

Ex ia IIIC Da/Db

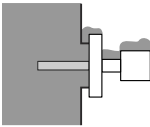
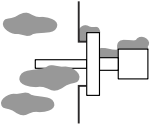
Process Zone 20		Housing Zone 21
Continuous dust submersion		Dust accumulation or temporary explosive dust atmosphere
Continuous explosive dust atmosphere and deposits		Dust accumulation or temporary explosive dust atmosphere

Intrinsic safety

- The device is only suitable for connection to certified, intrinsically safe equipment with explosion protection Ex ia / Ex ib.
- The intrinsically safe input power circuit of the device is isolated from ground. The dielectric strength is at least $500 V_{\text{rms}}$.

Potential equalization

- Integrate the device into the local potential equalization.
- Grounding the screen, see the following figure.

Basic specification, Position 7 = A

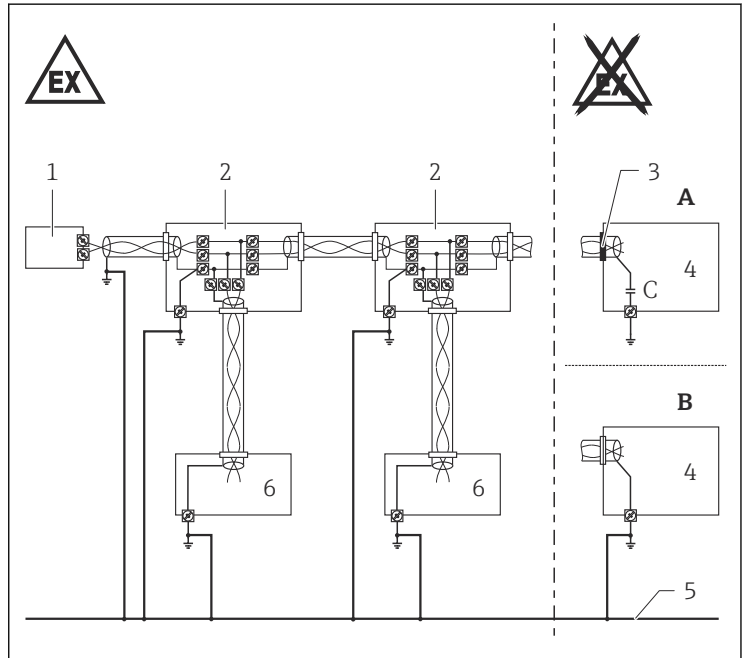

A0022352

3

- A Version 1: Use small capacitors (e.g. 1 nF, 1500 V dielectric strength, ceramic). Total capacitance connected to the screen may not exceed 10 nF.
- B Version 2
- 1 Terminating resistor
- 2 Distributor/T box
- 3 Screen insulated
- 4 Supply unit/Segment coupler
- 5 Potential equalization (secured in high degree)
- 6 Field device

Explosion protection with heat insulation

Device type FTL70, FTL71, Basic specification, Position 11 = L, N, Y

- While observing the "temperature derating", the device is suitable for process temperatures up to 300 °C.
- When operating, ensure that you rule out contact between hot component surfaces and potentially explosive atmospheres beyond the limits of the corresponding temperature class. Suitable measures: e.g. thermal insulation at container and/or pipes.
- The temperature of 85 °C specified at the reference point may not be exceeded.
- To protect the electronics, observe the specified ambient temperature at the electronics enclosure.

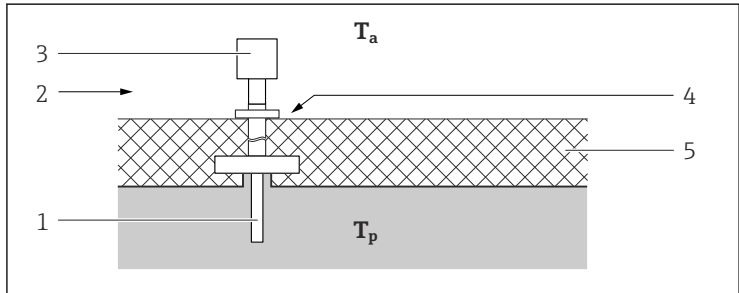

4

T_a Ambient temperature

T_p Process temperature

1 Sensor

2 Temperature class, e.g. T6

3 Enclosure

4 Reference point: max. +85 °C

5 E.g. thermal insulation

Temperature tables

Description notes



Unless otherwise indicated, the positions always refer to the basic specification.

Zone 0, Zone 1

Device Type FTL50, FTL50H, FTL51, FTL51H

1st column: Position 5, 6 = Ax, Bx, ...

Device Type FTL51C, FTL70, FTL71

1st column: Position 11 = A, B, ...

2nd column: Temperature classes T6 (85 °C) to T1 (450 °C)

Column P1 to P5: Position (temperature value) on the axes of the derating

- T_a : Ambient temperature in °C
- T_p : Process temperature in °C

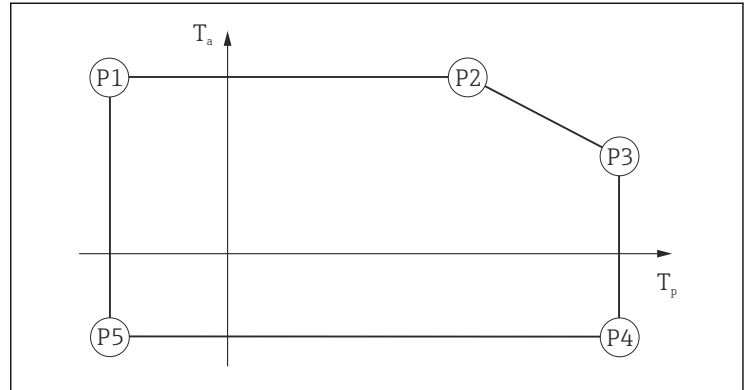

A0033052

Zone 20, Zone 21

Device Type FTL50, FTL50H, FTL51, FTL51H

1st column: Position 5, 6 = Ax, Bx, ...

Device Type FTL51C, FTL70, FTL71

1st column: Position 11 = A, B, ...

2nd column: Process temperature range in °C

3rd column: Ambient temperature range in °C

4th column: Maximum surface temperature in °C

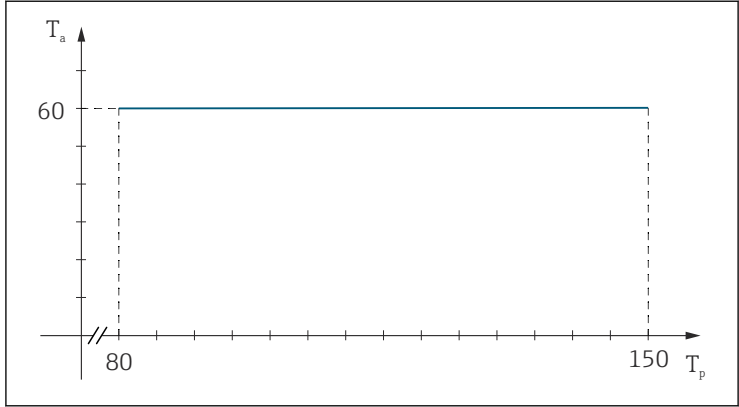

A0039764

T_a Ambient temperature in °C

T_p Process temperature in °C

Zone 0, Zone 1

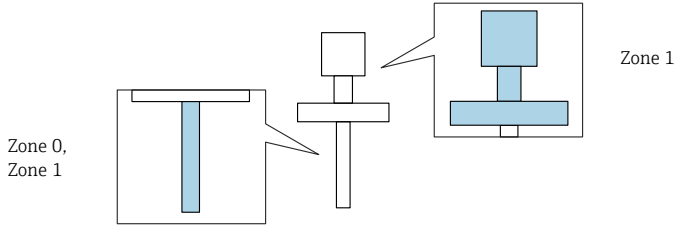

Device Type FTL50, FTL50H, FTL51, FTL51H
Position 7 = A, D, 5, 7

		P1		P2		P3		P4		P5	
		T _p	T _a	T _p	T _a	T _p	T _a	T _p	T _a	T _p	T _a
FTL50, FTL50H: Ax FTL51, FTL51H: Bx, Cx, Dx											
	T6	-50	55	55	55	75	45	75	-50 -40 ¹⁾	-50	-50 -40 ¹⁾
	T5...T1	-50	55	55	55	90	40	90	-50 -40 ¹⁾	-50	-50 -40 ¹⁾
FTL50, FTL50H: Ix, Qx FTL51, FTL51H: Jx, Kx, Lx, Rx, Sx, Tx											
	T6	-50	55	65	55	75	50	75	-50 -40 ¹⁾	-50	-50 -40 ¹⁾
	T5	-50	55	65	55	90	50	90	-50 -40 ¹⁾	-50	-50 -40 ¹⁾
	T4	-50	55	65	55	125	50	125	-50 -40 ¹⁾	-50	-50 -40 ¹⁾
	T3...T1	-50	55	65	55	150	45	150	-50 -40 ¹⁾	-50	-50 -40 ¹⁾

1) Only in connection with Position 8, 9 = x6

Position 7 = 6, 8

		P1		P2		P3		P4		P5	
		T _p	T _a	T _p	T _a	T _p	T _a	T _p	T _a	T _p	T _a
FTL50, FTL50H: Ax FTL51, FTL51H: Bx, Cx, Dx											
	T6	-50	55	67	55	75	55	75	-50 -40 ¹⁾	-50	-50 -40 ¹⁾
	T5	-50	65	70	65	90	55	90	-50 -40 ¹⁾	-50	-50 -40 ¹⁾
	T4...T1	-50	65	70	65	130	40	130	-50 -40 ¹⁾	-50	-50 -40 ¹⁾
FTL50, FTL50H: Ix, Qx FTL51, FTL51H: Jx, Kx, Lx, Rx, Sx, Tx											
	T6	-50	55	70	55	75	55	75	-50 -40 ¹⁾	-50	-50 -40 ¹⁾
	T5	-50	65	95	65	90	65	90	-50 -40 ¹⁾	-50	-50 -40 ¹⁾
	T4	-50	65	95	65	125	60	125	-50 -40 ¹⁾	-50	-50 -40 ¹⁾
	T3...T1	-50	65	95	65	150	60	150	-50 -40 ¹⁾	-50	-50 -40 ¹⁾

1) Only in connection with Position 8, 9 = x6

Device Type FTL51C
Position 7 = A, D, 5, 7

		P1		P2		P3		P4		P5	
		T _p	T _a	T _p	T _a	T _p	T _a	T _p	T _a	T _p	T _a
<i>A</i>											
	T6	-50	55	55	55	75	45	75	-50 -40 ¹⁾	-50	-50 -40 ¹⁾
	T5...T1	-50	55	55	55	90	40	90	-50 -40 ¹⁾	-50	-50 -40 ¹⁾
<i>B, C</i>											
	T6	-50	55	65	55	75	50	75	-50 -40 ¹⁾	-50	-50 -40 ¹⁾
	T5	-50	55	65	55	90	50	90	-50 -40 ¹⁾	-50	-50 -40 ¹⁾
	T4	-50	55	65	55	125 120 ²⁾	50	125 120 ²⁾	-50 -40 ¹⁾	-50	-50 -40 ¹⁾
	T3...T1	-50	55	65	55	150 120 ²⁾	45	150 120 ²⁾	-50 -40 ¹⁾	-50	-50 -40 ¹⁾

1) Only in connection with Position 8, 9 = x6

2) Only in connection with Position 5, 6 = xK

Position 7 = 6, 8

		P1		P2		P3		P4		P5	
		T _p	T _a	T _p	T _a	T _p	T _a	T _p	T _a	T _p	T _a
A											
	T6	-50	55	67	55	75	55	75	-50 -40 ¹⁾	-50	-50 -40 ¹⁾
	T5	-50	65	70	65	90	55	90	-50 -40 ¹⁾	-50	-50 -40 ¹⁾
	T4...T1	-50	65	70	65	130	40	130	-50 -40 ¹⁾	-50	-50 -40 ¹⁾
B, C											
	T6	-50	55	70	55	75	55	75	-50 -40 ¹⁾	-50	-50 -40 ¹⁾
	T5	-50	65	95	65	90	65	90	-50 -40 ¹⁾	-50	-50 -40 ¹⁾
	T4	-50	65	95	65	125 120 ²⁾	60	125 120 ²⁾	-50 -40 ¹⁾	-50	-50 -40 ¹⁾
	T3...T1	-50	65	95	65	150 120 ²⁾	60	150 120 ²⁾	-50 -40 ¹⁾	-50	-50 -40 ¹⁾

1) Only in connection with Position 8, 9 = x6

2) Only in connection with Position 5, 6 = xK

*Device Type FTL70, FTL71**Position 7 = A, 5, 7, 9*

		P1		P2		P3		P4		P5	
		T _p	T _a	T _p	T _a	T _p	T _a	T _p	T _a	T _p	T _a
<i>L</i>											
	T6	-60	50	80	50	80	50	80	-50 -40 ¹⁾	-60	-50 -40 ¹⁾
	T5	-60	55	70	55	95	50	95	-50 -40 ¹⁾	-60	-50 -40 ¹⁾
	T4	-60	55	70	55	130	50	130	-50 -40 ¹⁾	-60	-50 -40 ¹⁾
	T3	-60	55	70	55	195	45	195	-50 -40 ¹⁾	-60	-50 -40 ¹⁾
	T2...T1	-60	55	70	55	230	45	230	-50 -40 ¹⁾	-60	-50 -40 ¹⁾
<i>N, Y</i>											
	T6	-60	55	80	55	80	50	80	-50 -40 ¹⁾	-60	-50 -40 ¹⁾
	T5	-60	55	75	55	95	50	95	-50 -40 ¹⁾	-60	-50 -40 ¹⁾
	T4	-60	55	75	55	130	50	130	-50 -40 ¹⁾	-60	-50 -40 ¹⁾
	T3	-60	55	75	55	195	50	195	-50 -40 ¹⁾	-60	-50 -40 ¹⁾
	T2	-60	55	75	55	280 290 ²⁾	45	280 290 ²⁾	-50 -40 ¹⁾	-60	-50 -40 ¹⁾
	T1	-60	55	75	55	280 300 ²⁾	45	280 300 ²⁾	-50 -40 ¹⁾	-60	-50 -40 ¹⁾

1) Only in connection with Position 8, 9 = x5, x6

2) Only in connection with Position 11 = Y

Position 7 = 6, 8

		P1		P2		P3		P4		P5	
		T _p	T _a	T _p	T _a	T _p	T _a	T _p	T _a	T _p	T _a
<i>L</i>											
	T6	-60	55	80	55	80	55	80	-50 -40 ¹⁾	-60	-50 -40 ¹⁾
	T5	-60	65	80	65	95	65	95	-50 -40 ¹⁾	-60	-50 -40 ¹⁾
	T4	-60	65	95	65	130	65	130	-50 -40 ¹⁾	-60	-50 -40 ¹⁾
	T3	-60	65	115	65	195	60	195	-50 -40 ¹⁾	-60	-50 -40 ¹⁾
	T2...T1	-60	65	115	65	230	55	230	-50 -40 ¹⁾	-60	-50 -40 ¹⁾
<i>N, Y</i>											
	T6	-60	55	80	55	80	55	80	-50 -40 ¹⁾	-60	-50 -40 ¹⁾
	T5	-60	65	95	65	95	65	95	-50 -40 ¹⁾	-60	-50 -40 ¹⁾
	T4	-60	65	130	65	130	65	130	-50 -40 ¹⁾	-60	-50 -40 ¹⁾
	T3	-60	65	140	65	195	60	195	-50 -40 ¹⁾	-60	-50 -40 ¹⁾
	T2	-60	65	140	65	280 290 ²⁾	55	280 290 ²⁾	-50 -40 ¹⁾	-60	-50 -40 ¹⁾
	T1	-60	65	140	65	280 300 ²⁾	55	280 300 ²⁾	-50 -40 ¹⁾	-60	-50 -40 ¹⁾

1) Only in connection with Position 8, 9 = x5, x6

2) Only in connection with Position 11 = Y

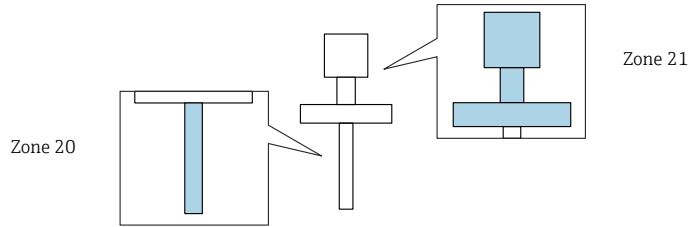
Zone 20, Zone 21

Device Type *FTL50, FTL50H, FTL51, FTL51H*

Position 7 = A, D, 5, 7

FTL50, FTL50H: Ax FTL51, FTL51H: Bx, Cx, Dx			
	$-50 \leq T_p \leq +65$	$-50 \leq T_a \leq +50$ $-40 \leq T_a \leq +50$ ¹⁾	Sensor $T_{p, \max} + 15 \text{ K}^{2)}$ Enclosure $T_{a, \max} + 20 \text{ K}^{3)}$
	$-50 \leq T_p \leq +90$	$-50 \leq T_a \leq +40$ $-40 \leq T_a \leq +40$ ¹⁾	Sensor $T_{p, \max} + 15 \text{ K}^{2)}$ Enclosure $T_{a, \max} + 30 \text{ K}^{3)}$
FTL50, FTL50H: Ix, Qx FTL51, FTL51H: Jx, Kx, Lx, Rx, Sx, Tx			
	$-50 \leq T_p \leq +150$	$-50 \leq T_a \leq +45$ $-40 \leq T_a \leq +45$ ¹⁾	Sensor $T_{p, \max} + 15 \text{ K}^{2)}$ Enclosure $T_{a, \max} + 25 \text{ K}^{3)}$

- 1) Only in connection with Position 8, 9 = x6
- 2) With 200 mm dust deposit
- 3) With dust accumulation T_l

Position 7 = 6, 8

FTL50, FTL50H: Ax FTL51, FTL51H: Bx, Cx, Dx			
	$-50 \leq T_p \leq +95$	$-50 \leq T_a \leq +55$ $-40 \leq T_a \leq +55$ ¹⁾	Sensor $T_{p, \max} +15 \text{ K}$ ²⁾ Enclosure $T_{a, \max} +15 \text{ K}$ ³⁾
	$-50 \leq T_p \leq +130$	$-50 \leq T_a \leq +40$ $-40 \leq T_a \leq +40$ ¹⁾	Sensor $T_{p, \max} +15 \text{ K}$ ²⁾ Enclosure $T_{a, \max} +30 \text{ K}$ ³⁾
FTL50, FTL50H: Ix, Qx FTL51, FTL51H: Jx, Kx, Lx, Rx, Sx, Tx			
	$-50 \leq T_p \leq +150$	$-50 \leq T_a \leq +60$ $-40 \leq T_a \leq +60$ ¹⁾	Sensor $T_{p, \max} +15 \text{ K}$ ²⁾ Enclosure $T_{a, \max} +10 \text{ K}$ ³⁾

- 1) Only in connection with Position 8, 9 = x6
- 2) With 200 mm dust deposit
- 3) With dust accumulation T_L

*Device Type FTL51C**Position 7 = A, D, 5, 7*

A			
	$-50 \leq T_p \leq +65$	$-50 \leq T_a \leq +50$ $-40 \leq T_a \leq +50$ ¹⁾	Sensor $T_{p, \max} +15 \text{ K}$ ²⁾ Enclosure $T_{a, \max} +20 \text{ K}$ ³⁾
	$-50 \leq T_p \leq +90$	$-50 \leq T_a \leq +40$ $-40 \leq T_a \leq +40$ ¹⁾	Sensor $T_{p, \max} +15 \text{ K}$ ²⁾ Enclosure $T_{a, \max} +30 \text{ K}$ ³⁾
B, C			
	$-50 \leq T_p \leq +150$ $-50 \leq T_p \leq +120$ ⁴⁾	$-50 \leq T_a \leq +45$ $-40 \leq T_a \leq +45$ ¹⁾	Sensor $T_{p, \max} +15 \text{ K}$ ²⁾ Enclosure $T_{a, \max} +25 \text{ K}$ ³⁾

- 1) Only in connection with Position 8, 9 = x6
- 2) With 200 mm dust deposit
- 3) With dust accumulation T_L
- 4) Only in connection with Position 5, 6 = xK

Position 7 = 6, 8

A			
	$-50 \leq T_p \leq +95$	$-50 \leq T_a \leq +55$ $-40 \leq T_a \leq +55$ ¹⁾	Sensor $T_{p, \max} +15 \text{ K}^{2)}$ Enclosure $T_{a, \max} +15 \text{ K}^{3)}$
	$-50 \leq T_p \leq +130$	$-50 \leq T_a \leq +40$ $-40 \leq T_a \leq +40$ ¹⁾	Sensor $T_{p, \max} +15 \text{ K}^{2)}$ Enclosure $T_{a, \max} +30 \text{ K}^{3)}$
	$-50 \leq T_p \leq +120$ ⁵⁾	$-50 \leq T_a \leq +45$ $-40 \leq T_a \leq +45$ ¹⁾	Sensor $T_{p, \max} +15 \text{ K}^{2)}$ Enclosure $T_{a, \max} +25 \text{ K}^{4)}$
B, C			
	$-50 \leq T_p \leq +150$ $-50 \leq T_p \leq +120$ ⁵⁾	$-50 \leq T_a \leq +60$ $-40 \leq T_a \leq +60$ ¹⁾	Sensor $T_{p, \max} +15 \text{ K}^{2)}$ Enclosure $T_{a, \max} +10 \text{ K}^{3)}$

- 1) Only in connection with Position 8, 9 = x6
- 2) With 200 mm dust deposit
- 3) With dust accumulation T_L
- 4) Only in connection with Position 5, 6 = xK and dust accumulation T_L
- 5) Only in connection with Position 5, 6 = xK

*Device Type FTL70, FTL71**Position 7 = A, 5, 7, 9*

<i>L</i>			
	$-50 \leq T_p \leq +230$	$-50 \leq T_a \leq +40$ $-40 \leq T_a \leq +40$ ¹⁾	Sensor $T_{p, \max} +15 \text{ K}$ ²⁾ Enclosure $T_{a, \max} +30 \text{ K}$ ³⁾
<i>N, Y</i>			
	$-50 \leq T_p \leq +280$ $-50 \leq T_p \leq +300$ ⁴⁾	$-50 \leq T_a \leq +45$ $-40 \leq T_a \leq +45$ ¹⁾	Sensor $T_{p, \max} +15 \text{ K}$ ²⁾ Enclosure $T_{a, \max} +25 \text{ K}$ ³⁾

- 1) Only in connection with Position 8, 9 = x5, x6
- 2) With 200 mm dust deposit
- 3) With dust accumulation T_L
- 4) Only in connection with Position 11 = Y

Position 7 = 6, 8

<i>L</i>			
	$-50 \leq T_p \leq +230$	$-50 \leq T_a \leq +55$ $-40 \leq T_a \leq +55$ ¹⁾	Sensor $T_{p, \max} +15 \text{ K}$ ²⁾ Enclosure $T_{a, \max} +15 \text{ K}$ ³⁾
<i>N, Y</i>			
	$-50 \leq T_p \leq +280$ $-50 \leq T_p \leq +300$ ⁴⁾	$-50 \leq T_a \leq +55$ $-40 \leq T_a \leq +55$ ¹⁾	Sensor $T_{p, \max} +15 \text{ K}$ ²⁾ Enclosure $T_{a, \max} +15 \text{ K}$ ³⁾

- 1) Only in connection with Position 8, 9 = x5, x6
- 2) With 200 mm dust deposit
- 3) With dust accumulation T_L
- 4) Only in connection with Position 11 = Y

Connection data*Basic specification, Position 7 = D, 5, 6, 7, 8, 9*

Associated intrinsically safe power supply unit with max. electrical specifications below the characteristic values of the electronic inserts

<i>Basic specification, Position 7</i>	Power supply
5	$U_i = 36 \text{ V}$ $I_i = 100 \text{ mA}$ $P_i = 1 \text{ W}$ $L_i = 0$ $C_i = 0$
6	$U_i = 16 \text{ V}$ $I_i = 52 \text{ mA}$ $P_i = 170 \text{ mW}$ $L_i = 0$ $C_i = 30 \text{ nF}$
7	$U_i = 16.7 \text{ V}$ $I_i = 150 \text{ mA}$ $P_i = 1 \text{ W}$ $L_i = 0$ $C_i = 0$
8	$U_i = 16 \text{ V}$ $I_i = 52 \text{ mA}$ $P_i = 170 \text{ mW}$ $L_i = 0$ $C_i = 30 \text{ nF}$

Only associated intrinsically safe power supply unit FML621 from Endress+Hauser

<i>Basic specification, Position 7</i>	Power supply
<i>D (FTL5x(H), FTL51C)</i> <i>9 (FTL7x)</i>	$U_i = 27.6 \text{ V}$ $I_i = 93 \text{ mA}$ $P_i = 640 \text{ mW}$ $L_i = 0.133 \text{ mH}$ $C_i = 2 \text{ nF}$

Basic specification, Position 7 = A

Certified intrinsically safe fieldbus (PROFIBUS PA), in accordance with the FISCO Modell, with the following maximum values

Basic specification, Position 7	Power supply
A	$U_i = 17.5 \text{ V}$ $I_i = 500 \text{ mA}$ $P_i = 5.5 \text{ W}$ $L_i \leq 10 \text{ } \mu\text{H}$ $C_i = 2.7 \text{ nF}$

Certified intrinsically safe circuit with the following maximum values

Basic specification, Position 7	Power supply
A	$U_i = 24 \text{ V}$ $I_i = 250 \text{ mA}$ $P_i = 1.2 \text{ W}$ $L_i \leq 10 \text{ } \mu\text{H}$ $C_i = 2.7 \text{ nF}$

Cable entry: Connection compartment**Ex ia IIC**

Not relevant.

Ex ia IIIC

Cable gland: *Basic specification, Position 8, 9 = x1, x3, x5, x6, x7, x8*

preferably for Basic specification, Position 8, 9 = x5, x7, x8

Thread	Clamping range	Material	Sealing insert	O-ring
M20x1,5	$\varnothing 7$ to 12 mm	1.4404	NBR	EPDM ($\varnothing 17 \times 2$)

preferably for Basic specification, Position 8, 9 = x1, x3, x6

Thread	Clamping range	Material	Sealing insert	O-ring
M20x1,5	$\varnothing 8$ to 10.5 mm ¹⁾ ($\varnothing 6.5$ to 13 mm) ²⁾	Ms, nickel-plated	Silicone	EPDM ($\varnothing 17 \times 2$)

- 1) Standard
- 2) Separate clamping inserts available

-  The tightening torque refers to cable glands installed by the manufacturer:
 - Recommended: 3.5 Nm
 - Maximum: 10 Nm
- This value may be different depending on the type of cable. However, the maximum value must not be exceeded.
- Only suitable for fixed installation. The operator must pay attention to a suitable strain relief of the cable.
- The cable glands are suitable for a low risk of mechanical danger (4 Joule) and must be mounted in a protected position if larger impact energy levels are expected.
- To maintain the ingress protection of the enclosure: Install the enclosure cover, cable glands and blind plugs correctly.



71540479

www.addresses.endress.com
