

# Operating Instructions

## Dosimass

Coriolis flowmeter

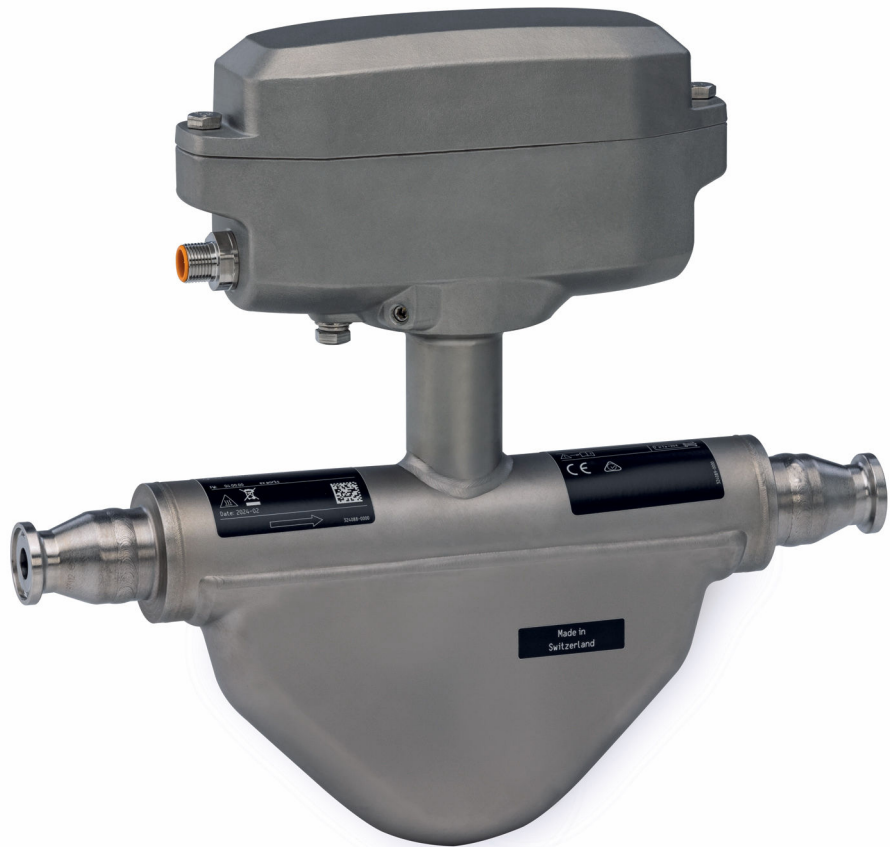

- Make sure the document is stored in a safe place such that it is always available when working on or with the device.
- To avoid danger to individuals or the facility, read the "Basic safety instructions" section carefully, as well as all other safety instructions in the document that are specific to working procedures.
- The manufacturer reserves the right to modify technical data without prior notice. Your Endress+Hauser sales organization will supply you with current information and updates to this manual.

# Table of contents

<b>1</b>	<b>About this document</b> . . . . .	<b>5</b>		
1.1	Document function . . . . .	5		
1.2	Symbols . . . . .	5		
1.2.1	Safety symbols . . . . .	5		
1.2.2	Electrical symbols . . . . .	5		
1.2.3	Symbols for certain types of information . . . . .	5		
1.2.4	Symbols in graphics . . . . .	6		
1.3	Documentation . . . . .	6		
1.4	Registered trademarks . . . . .	7		
<b>2</b>	<b>Safety instructions</b> . . . . .	<b>8</b>		
2.1	Requirements for the personnel . . . . .	8		
2.2	Intended use . . . . .	8		
2.3	Workplace safety . . . . .	9		
2.4	Operational safety . . . . .	9		
2.5	Product safety . . . . .	9		
2.6	IT security . . . . .	9		
<b>3</b>	<b>Product description</b> . . . . .	<b>10</b>		
3.1	Product design . . . . .	10		
<b>4</b>	<b>Incoming acceptance and product identification</b> . . . . .	<b>11</b>		
4.1	Incoming acceptance . . . . .	11		
4.2	Product identification . . . . .	11		
4.2.1	Measuring instrument nameplate . . . . .	12		
4.2.2	Symbols on the device . . . . .	14		
<b>5</b>	<b>Storage and transport</b> . . . . .	<b>15</b>		
5.1	Storage conditions . . . . .	15		
5.2	Transporting the product . . . . .	15		
5.3	Packaging disposal . . . . .	15		
<b>6</b>	<b>Installation</b> . . . . .	<b>16</b>		
6.1	Mounting requirements . . . . .	16		
6.1.1	Mounting position . . . . .	16		
6.1.2	Environmental and process requirements . . . . .	19		
6.1.3	Special mounting instructions . . . . .	21		
6.2	Installing the device . . . . .	24		
6.2.1	Required tools . . . . .	24		
6.2.2	Preparing the measuring instrument . . . . .	24		
6.2.3	Mounting the measuring device . . . . .	24		
6.3	Post-installation check . . . . .	25		
<b>7</b>	<b>Electrical connection</b> . . . . .	<b>26</b>		
7.1	Electrical safety . . . . .	26		
7.2	Connecting requirements . . . . .	26		
7.2.1	Requirements for connection cable . . . . .	26		
7.2.2	Terminal assignment . . . . .	26		
7.2.3	Available device plugs . . . . .	26		
7.2.4	Requirements for the supply unit . . . . .	27		
7.3	Connecting the device . . . . .	28		
7.3.1	Connection via device plug . . . . .	28		
7.3.2	Grounding . . . . .	28		
7.4	Ensuring potential equalization . . . . .	28		
7.5	Ensuring the degree of protection . . . . .	28		
7.6	Post-connection check . . . . .	29		
<b>8</b>	<b>Operation options</b> . . . . .	<b>30</b>		
8.1	Overview of operation options . . . . .	30		
8.2	Access to the operating menu via the operating tool . . . . .	30		
8.2.1	Connecting the operating tool . . . . .	30		
8.2.2	FieldCare . . . . .	31		
8.2.3	DeviceCare . . . . .	32		
<b>9</b>	<b>System integration</b> . . . . .	<b>33</b>		
9.1	Overview of device description files . . . . .	33		
9.1.1	Current version data for the device . . . . .	33		
9.1.2	Operating tools . . . . .	33		
<b>10</b>	<b>Commissioning</b> . . . . .	<b>34</b>		
10.1	Post-mounting and post-connection check . . . . .	34		
10.2	Switching on the measuring device . . . . .	34		
10.3	Connecting via FieldCare . . . . .	34		
10.4	Configuring the measuring instrument . . . . .	34		
<b>11</b>	<b>Operation</b> . . . . .	<b>35</b>		
11.1	Reading the device locking status . . . . .	35		
11.2	Reading access authorization status on operating software . . . . .	35		
11.3	Reading measured values . . . . .	35		
11.4	Adapting the measuring instrument to the process conditions . . . . .	36		
11.5	Performing a totalizer reset . . . . .	36		
<b>12</b>	<b>Diagnostics and troubleshooting</b> . . . . .	<b>37</b>		
12.1	General troubleshooting . . . . .	37		
12.2	Diagnostic information in FieldCare or DeviceCare . . . . .	37		
12.2.1	Diagnostic options . . . . .	37		
12.2.2	Calling up remedy information . . . . .	38		
12.3	Adapting the diagnostic information . . . . .	38		
12.3.1	Adapting the diagnostic behavior . . . . .	38		
12.4	Overview of diagnostic information . . . . .	39		
12.5	Pending diagnostic events . . . . .	41		
12.6	Actual diagnostics . . . . .	42		
12.7	Event logbook . . . . .	42		
12.7.1	Event history . . . . .	42		
12.7.2	Overview of information events . . . . .	42		
12.8	Device reset . . . . .	43		

---

12.9	Device .....	43
12.10	Firmware history .....	45
<b>13</b>	<b>Maintenance .....</b>	<b>46</b>
13.1	Maintenance work .....	46
13.1.1	Exterior cleaning .....	46
13.1.2	Internal cleaning .....	46
13.2	Measuring and test equipment .....	46
13.3	Endress+Hauser services .....	46
<b>14</b>	<b>Repair .....</b>	<b>47</b>
14.1	General information .....	47
14.1.1	Repair and conversion concept .....	47
14.2	Endress+Hauser services .....	47
14.3	Return .....	47
14.4	Disposal .....	47
14.4.1	Removing the measuring device .....	47
14.4.2	Disposing of the measuring device ...	48
<b>15</b>	<b>Accessories .....</b>	<b>49</b>
15.1	Device-specific accessories .....	49
15.2	Communication-specific accessories .....	49
15.3	Service-specific accessories .....	49
<b>16</b>	<b>Technical data .....</b>	<b>50</b>
16.1	Application .....	50
16.2	Function and system design .....	50
16.3	Input .....	50
16.4	Output .....	51
16.5	Power supply .....	53
16.6	Performance characteristics .....	53
16.7	Mounting .....	56
16.8	Environment .....	56
16.9	Process .....	57
16.10	Mechanical construction .....	59
16.11	Operability .....	61
16.12	Certificates and approvals .....	61
16.13	Accessories .....	63
16.14	Documentation .....	63
<b>Index</b> .....	<b>65</b>	

# 1 About this document

## 1.1 Document function

These Operating Instructions contain all the information required in the various life cycle phases of the device: from product identification, incoming acceptance and storage, to installation, connection, operation and commissioning, through to troubleshooting, maintenance and disposal.

## 1.2 Symbols

### 1.2.1 Safety symbols

** DANGER**

This symbol alerts you to a dangerous situation. Failure to avoid this situation will result in serious or fatal injury.

** WARNING**

This symbol alerts you to a potentially dangerous situation. Failure to avoid this situation can result in serious or fatal injury.





** CAUTION**

This symbol alerts you to a potentially dangerous situation. Failure to avoid this situation can result in minor or medium injury.



**NOTICE**











This symbol alerts you to a potentially harmful situation. Failure to avoid this situation can result in damage to the product or something in its vicinity.

### 1.2.2 Electrical symbols







Symbol	Meaning
	Direct current
	Alternating current
	Direct current and alternating current
	<b>Ground connection</b> A grounded terminal which, as far as the operator is concerned, is grounded via a grounding system.
	<b>Protective earth (PE)</b> Ground terminals that must be connected to ground prior to establishing any other connections.  The ground terminals are located on the interior and exterior of the device: <ul style="list-style-type: none"> <li>▪ Interior ground terminal: protective earth is connected to the mains supply.</li> <li>▪ Exterior ground terminal: device is connected to the plant grounding system.</li> </ul>

### 1.2.3 Symbols for certain types of information

Symbol	Meaning
	<b>Permitted</b> Procedures, processes or actions that are permitted.
	<b>Preferred</b> Procedures, processes or actions that are preferred.

Symbol	Meaning
	<b>Forbidden</b> Procedures, processes or actions that are forbidden.
	<b>Tip</b> Indicates additional information.
	Reference to documentation
	Reference to page
	Reference to graphic
	Notice or individual step to be observed
	Series of steps
	Result of a step
	Help in the event of a problem
	Visual inspection

### 1.2.4 Symbols in graphics

Symbol	Meaning
	Item numbers
	Series of steps
	Views
	Sections
	Hazardous area
	Safe area (non-hazardous area)
	Flow direction

## 1.3 Documentation

 For an overview of the scope of the associated Technical Documentation, refer to the following:

- *Device Viewer* ([www.endress.com/deviceviewer](http://www.endress.com/deviceviewer)): Enter the serial number from the nameplate
- *Endress+Hauser Operations app*: Enter serial number from nameplate or scan matrix code on nameplate.

The following document types are available in the Downloads area of the Endress+Hauser website ([www.endress.com/downloads](http://www.endress.com/downloads)), depending on the product configuration:

Document type	Purpose and content of the document
Technical Information (TI)	<b>Planning aid</b> This document contains all the technical data on the product and provides an overview of everything that can be ordered with the product.
Brief Operating Instructions (KA)	<b>Quick guide to obtaining the first measured value</b> The Operating Instructions contain all the essential information about the product from incoming acceptance to initial commissioning.

Document type	Purpose and content of the document
Operating Instructions (BA)	<p><b>Reference</b>                      The Operating Instructions contain the information that is required in the various phases of the life cycle of the product: From product identification, incoming acceptance and storage, to mounting, connection, operation and commissioning through to troubleshooting, maintenance and disposal.</p>
Description of Device Parameters (GP)	<p><b>Reference for parameters</b>                      The document contains detailed explanations of readable or configurable parameters in the product. The description is aimed at those who work with the product over its entire life cycle and perform specific configurations.</p>
Safety Instructions (XA)	<p>Safety Instructions for electrical equipment in hazardous areas are supplied with the product depending on the approval. These are an integral part of the Operating Instructions.</p> <p> The nameplate indicates the Safety Instructions (XA) that are relevant to the product.</p>
Supplementary device-dependent documentation (SD/FY)	<p>Always comply strictly with the instructions in the relevant supplementary documentation. The supplementary documentation is an integral part of the product documentation.</p>

## 1.4 Registered trademarks

### TRI-CLAMP®

Registered trademark of Ladish & Co., Inc., Kenosha, USA

## 2 Safety instructions

### 2.1 Requirements for the personnel

The personnel for installation, commissioning, diagnostics and maintenance must fulfill the following requirements:

- ▶ Trained, qualified specialists must have a relevant qualification for this specific function and task.
- ▶ Are authorized by the plant owner/operator.
- ▶ Are familiar with federal/national regulations.
- ▶ Before starting work, read and understand the instructions in the manual and supplementary documentation as well as the certificates (depending on the application).
- ▶ Follow instructions and comply with basic conditions.

The operating personnel must fulfill the following requirements:

- ▶ Are instructed and authorized according to the requirements of the task by the facility's owner-operator.
- ▶ Follow the instructions in this manual.

### 2.2 Intended use

#### Application and media

The measuring instrument described in this manual is intended only for the flow measurement of liquids and gases.

Depending on the version ordered, the measuring instrument can also measure potentially explosive, flammable, poisonous and oxidizing media.

Measuring instruments for use in hazardous areas, in hygienic applications, or where there is an increased risk due to pressure, are specially labeled on the nameplate.

To ensure that the measuring instrument remains in proper condition during the operating time:

- ▶ Only use the measuring instrument in full compliance with the data on the nameplate and the general conditions listed in the manual and supplementary documentation.
- ▶ Using the nameplate, check whether the ordered device is permitted for the intended use in the hazardous area (e.g. explosion protection, pressure vessel safety).
- ▶ Use the measuring instrument only for media to which the process-wetted materials are sufficiently resistant.
- ▶ Keep within the specified pressure and temperature range.
- ▶ Keep within the specified ambient temperature range.
- ▶ Protect the measuring instrument permanently against corrosion from environmental influences.

#### Incorrect use

Non-designated use can compromise safety. The manufacturer is not liable for damage caused by improper or non-designated use.

#### **WARNING**

#### **Danger of breakage due to corrosive or abrasive fluids and ambient conditions!**

- ▶ Verify the compatibility of the process fluid with the sensor material.
- ▶ Ensure the resistance of all wetted materials during the process.
- ▶ Keep within the specified pressure and temperature range.

**NOTICE****Verification for borderline cases:**

- ▶ For special fluids and fluids for cleaning, Endress+Hauser is glad to provide assistance in verifying the corrosion resistance of fluid-wetted materials, but does not accept any warranty or liability as minute changes in the temperature, concentration or level of contamination in the process can alter the corrosion resistance properties.

**Residual risks****⚠ WARNING**

**Risk of hot or cold burns! Hot or cold surfaces on the device may occur due to the process medium, electronics or ambient temperature.**

- ▶ Mount suitable touch protection.

## 2.3 Workplace safety

For work on and with the device:

- ▶ Wear the required personal protective equipment according to federal/national regulations.

## 2.4 Operational safety

Damage to the device!

- ▶ Operate the device in proper technical condition and fail-safe condition only.
- ▶ The operator is responsible for the interference-free operation of the device.

**Modifications to the device**

Unauthorized modifications to the device are not permitted and can lead to unforeseeable dangers!

- ▶ If modifications are nevertheless required, consult with the manufacturer.

**Repair**

To ensure continued operational safety and reliability:

- ▶ Carry out repairs on the device only if they are expressly permitted.
- ▶ Observe federal/national regulations pertaining to the repair of an electrical device.
- ▶ Use only original spare parts and accessories.

## 2.5 Product safety

This state-of-the-art device is designed and tested in accordance with good engineering practice to meet operational safety standards. It left the factory in a condition in which it is safe to operate.

It meets general safety standards and legal requirements. It also complies with the EU directives listed in the device-specific EU declaration of conformity. The manufacturer confirms this by affixing the CE mark.

## 2.6 IT security

The manufacturer warranty is valid only if the product is installed and used as described in the Operating Instructions. The product is equipped with security mechanisms to protect it against any inadvertent changes to the settings.

IT security measures, which provide additional protection for the product and associated data transfer, must be implemented by the operators themselves in line with their security standards.

### 3 Product description

The device consists of a transmitter and a sensor.

#### 3.1 Product design

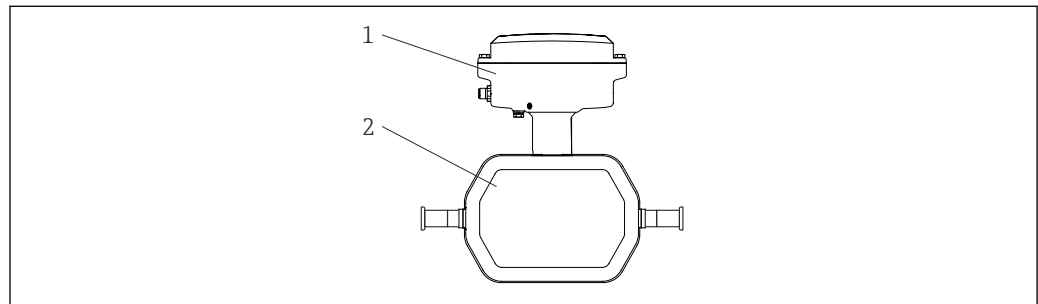

A0055042

1 Important measuring instrument components DN 1 to 4 ( $1/24$  to  $1/8$ " )

- 1 Transmitter
- 2 Sensor

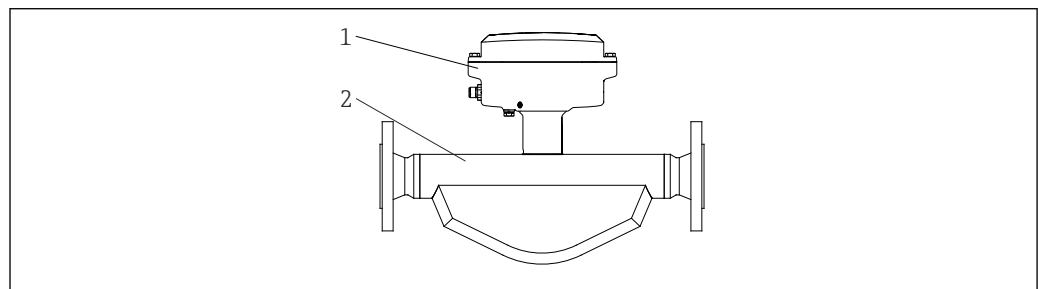

A0055044

2 Important measuring instrument components DN 8 to 40 ( $3/8$  to  $1 1/2$ " )

- 1 Transmitter
- 2 Sensor

## 4 Incoming acceptance and product identification

### 4.1 Incoming acceptance

On receipt of the delivery:

1. Check the packaging for damage.
  - ↳ Report all damage immediately to the manufacturer.  
Do not install damaged components.
2. Check the scope of delivery using the delivery note.
3. Compare the data on the nameplate with the order specifications on the delivery note.
4. Check the technical documentation and all other necessary documents, e.g. certificates, to ensure they are complete.



If one of the conditions is not satisfied, contact the manufacturer.

### 4.2 Product identification

The device can be identified in the following ways:

- Nameplate
- Order code with details of the device features on the delivery note
- Enter the serial numbers from the nameplates in the *Device Viewer* ([www.endress.com/deviceviewer](http://www.endress.com/deviceviewer)): all the information about the device is displayed.
- Enter the serial numbers from the nameplates into the *Endress+Hauser Operations app* or scan the DataMatrix code on the nameplate with the *Endress+Hauser Operations app*: all the information about the device is displayed.

For an overview of the scope of the associated Technical Documentation, refer to the following:

- The "Additional standard device documentation" and "Supplementary device-dependent documentation" sections
- The *Device Viewer*: Enter the serial number from the nameplate ([www.endress.com/deviceviewer](http://www.endress.com/deviceviewer))
- The *Endress+Hauser Operations app*: Enter the serial number from the nameplate or scan the DataMatrix code on the nameplate.

### 4.2.1 Measuring instrument nameplate

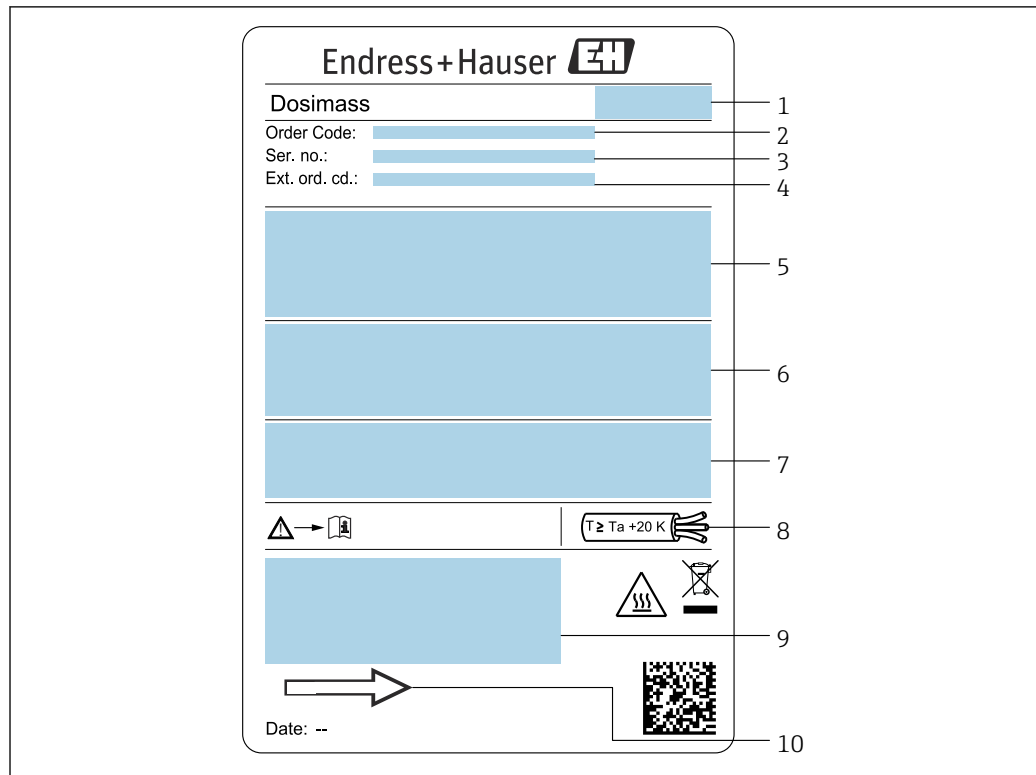

A0054878

3 Example of a measuring instrument nameplate DN 1 to 4 ( $\frac{1}{24}$  to  $\frac{1}{8}$ " )

- 1 Manufacturer address/certificate holder
- 2 Order code
- 3 Serial number (Ser. no.)
- 4 Extended order code (Ext. ord. cd.): See the specifications on the order confirmation for the meanings of the individual letters and digits
- 5 Supply voltage; power consumption; process connection
- 6 Nominal diameter of sensor; max. flow ( $Q_{max}$ ); pressure rating ( $PN = PS$ ); materials in contact with medium; permitted medium temperature ( $T_m$ ); permitted ambient temperature ( $T_a$ )
- 7 Degree of protection
- 8 Cable temperature
- 9 Space reserved for additional information on the device version (approvals, certificates, etc.)
- 10 Flow direction

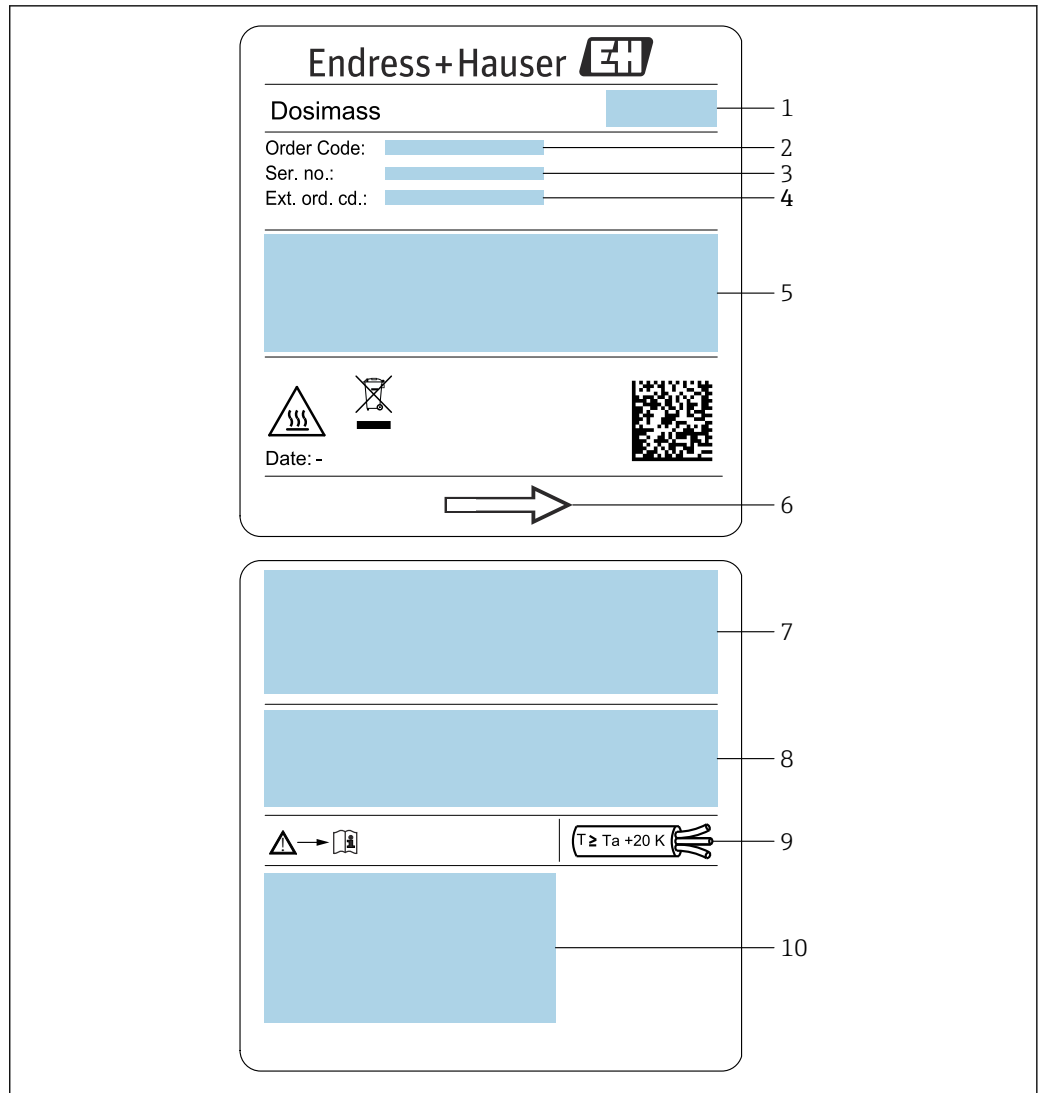

A0054877

4 Example of a measuring instrument nameplate DN 8 to 40 (3/8 to 1 1/2")

- 1 Manufacturer address/certificate holder
- 2 Order code
- 3 Serial number (Ser. no.)
- 4 Extended order code (Ext. ord. cd.): See the specifications on the order confirmation for the meanings of the individual letters and digits
- 5 Supply voltage; power consumption; process connection
- 6 Flow direction
- 7 Nominal diameter of sensor; max. flow (Qmax); pressure rating (PN = PS); materials in contact with medium; permitted medium temperature (Tm); permitted ambient temperature (Ta)
- 8 Degree of protection
- 9 Cable temperature
- 10 Space reserved for additional information on the device version (approvals, certificates, etc.)



**i Order code**

The measuring device is reordered using the order code.

**Extended order code**

- The device type (product root) and basic specifications (mandatory features) are always listed.
- Of the optional specifications (optional features), only the safety and approval-related specifications are listed (e.g. LA). If other optional specifications are also ordered, these are indicated collectively using the # placeholder symbol (e.g. #LA#).
- If the ordered optional specifications do not include any safety and approval-related specifications, they are indicated by the + placeholder symbol (e.g. XXXXXX-ABCDE+).

## 4.2.2 Symbols on the device

Symbol	Meaning
	<b>WARNING!</b> This symbol alerts you to a dangerous situation. Failure to avoid this situation can result in serious or fatal injury. Please consult the documentation for the measuring instrument to discover the type of potential danger and measures to avoid it.
	<b>Reference to documentation</b> Refers to the corresponding device documentation.
	<b>Ground connection</b> A grounded terminal which, as far as the operator is concerned, is grounded via a grounding system.

## 5 Storage and transport

### 5.1 Storage conditions

Observe the following notes for storage:

- ▶ Store in the original packaging to ensure protection from shock.
- ▶ Do not remove protective covers or protective caps installed on process connections. They prevent mechanical damage to the sealing surfaces and contamination in the measuring tube.
- ▶ Protect from direct sunlight. Avoid unacceptably high surface temperatures.
- ▶ Store in a dry and dust-free place.
- ▶ Do not store outdoors.

Storage temperature →  57

### 5.2 Transporting the product

Transport the measuring instrument to the measuring point in the original packaging.

-  Do not remove protective covers or caps installed on process connections. They prevent mechanical damage to the sealing surfaces and contamination in the measuring tube.

### 5.3 Packaging disposal

All packaging materials are environmentally friendly and 100% recyclable:

- Outer packaging of device
  - Stretch wrap made of polymer in accordance with EU Directive 2002/95/EC (RoHS)
- Packaging
  - Wood crate treated in accordance with ISPM 15 standard, confirmed by IPPC logo
  - Cardboard box in accordance with European packaging guideline 94/62/EC, recyclability confirmed by Resy symbol
- Transport material and fastening fixtures
  - Disposable plastic pallet
  - Plastic straps
  - Plastic adhesive strips
- Filler material
  - Paper pads

## 6 Installation

### 6.1 Mounting requirements

#### 6.1.1 Mounting position

##### Installation point

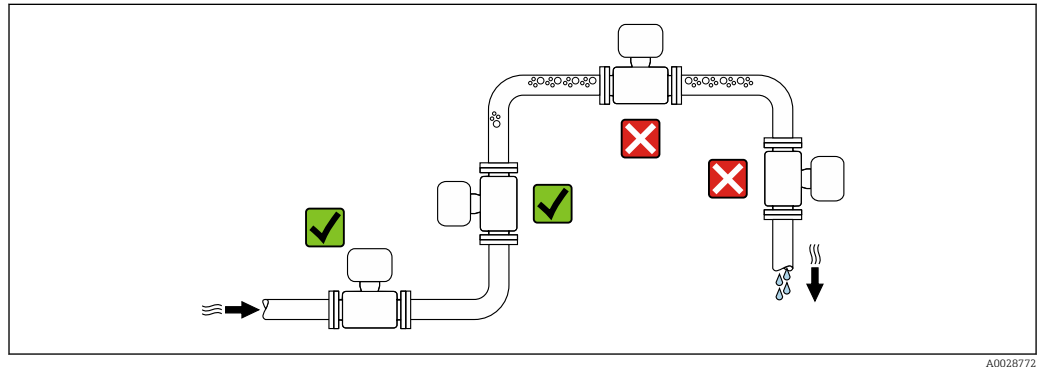

A0028772

To prevent measuring errors arising from accumulation of gas bubbles in the measuring pipe, avoid the following mounting locations in the piping:

- Highest point of a pipeline.
- Directly upstream of a free pipe outlet in a down pipe.

##### Installation in down pipes

However, the following installation suggestion allows for installation in an open vertical pipeline. Pipe restrictions or the use of an orifice with a smaller cross-section than the nominal diameter prevent the sensor running empty while measurement is in progress.

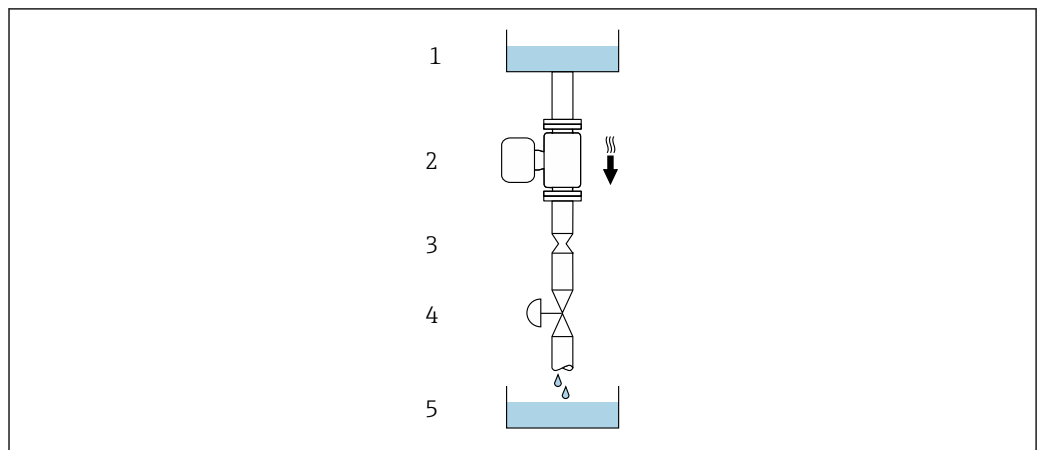

A0028773

5 Installation in a down pipe (e.g. for batching applications)



- 1 Supply tank
- 2 Sensor
- 3 Orifice plate, pipe restriction
- 4 Valve
- 5 Filling vessel

DN		Ø orifice plate, pipe restriction	
[mm]	[in]	[mm]	[in]
1	1/24	0.8	0.03
2	1/12	1.5	0.06
4	1/8	3.0	0.12
8	3/8	6	0.24
15	1/2	10	0.40
25	1	14	0.55
40	1 1/2	22	0.87

**Orientation**

The direction of the arrow on the sensor nameplate helps you to install the sensor according to the flow direction (direction of medium flow through the piping).

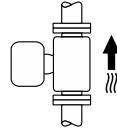
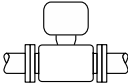
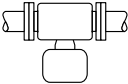

*Recommended orientation for DN 1 to 4 (1/24 to 1/8 ")*

Orientation		Recommendation
<b>A</b>	Vertical orientation	 A0015591 ✓✓ <sup>1)</sup>
<b>B</b>	Horizontal orientation, transmitter at top	 A0015589 ✓ <sup>2)</sup>
<b>C</b>	Horizontal orientation, transmitter at bottom	 A0015590 ✓ <sup>3)</sup>
<b>D</b>	Horizontal orientation, transmitter at side	 A0015592 ✓

- 1) This orientation is recommended to ensure self-draining.
- 2) Applications with low process temperatures may reduce the ambient temperature. To maintain the minimum ambient temperature for the transmitter, this orientation is recommended.
- 3) Applications with high process temperatures may increase the ambient temperature. To maintain the maximum ambient temperature for the transmitter, this orientation is recommended.

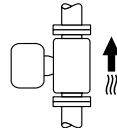
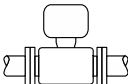
*Recommended orientation for DN 8 to 40 (3/8 to 1 1/2")*

Orientation		Recommendation
<b>A</b>	Vertical orientation	 A0015591 ✓✓ <sup>1)</sup>
<b>B</b>	Horizontal orientation, transmitter at top	 A0015589 ✓✓ <sup>2)</sup>

Orientation		Recommendation
C	Horizontal orientation, transmitter at bottom	 <sup>3)</sup>
D	Horizontal orientation, transmitter at side	

- 1) This orientation is recommended to ensure self-draining.
- 2) Applications with low process temperatures may reduce the ambient temperature. To maintain the minimum ambient temperature for the transmitter, this orientation is recommended.
- 3) Applications with high process temperatures may increase the ambient temperature. To maintain the maximum ambient temperature for the transmitter, this orientation is recommended.

**Horizontal orientation for DN 8 to 40 (3/8 to 1 1/2")**

If a sensor is installed horizontally with a curved measuring tube, match the position of the sensor to the fluid properties.

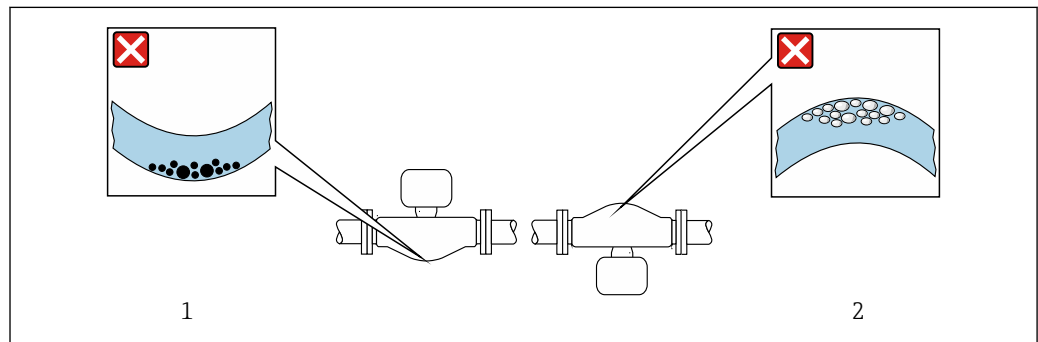

 6 Orientation of sensor with curved measuring tube

- 1 Avoid this orientation for fluids with entrained solids: Risk of solids accumulating
- 2 Avoid this orientation for outgassing fluids: Risk of gas accumulating

**Valves**

Never install the sensor downstream from a filling valve. If the sensor is completely empty this corrupts the measured value.

 Correct measurement is possible only if the piping is completely filled. Perform sample fillings before commencing filling in production.

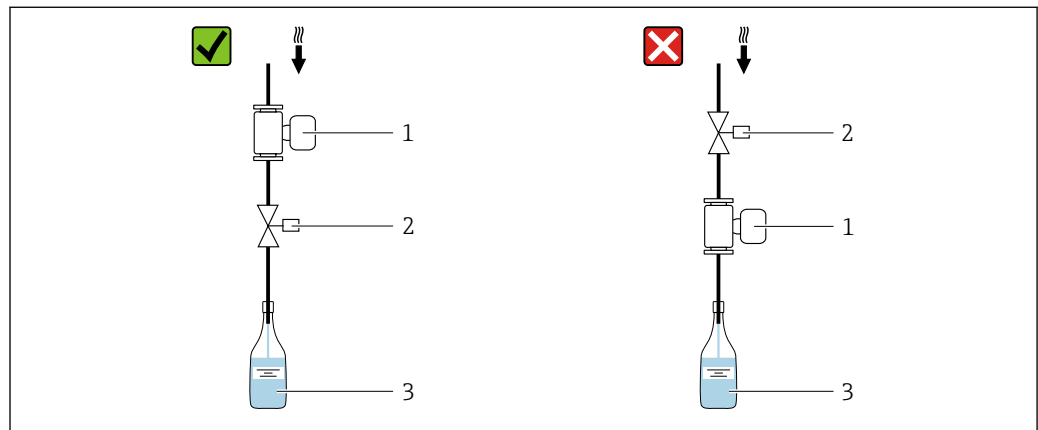

- 1 Measuring device
- 2 Filling valve
- 3 Vessel

*Filling systems*

The pipe system must be completely full to ensure optimum measurement.

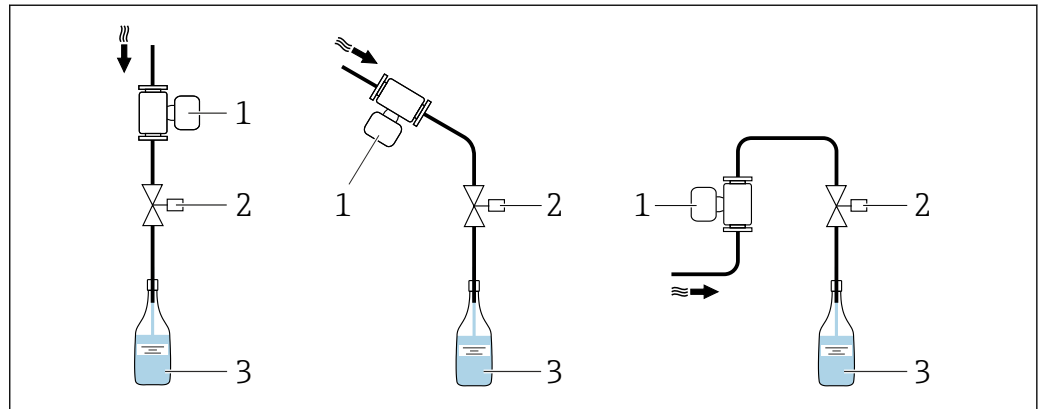

7 Filling system

- 1 Measuring device
- 2 Filling valve
- 3 Vessel

**Inlet and outlet runs**

No special precautions need to be taken for fittings that create turbulence, such as valves, elbows or T-pieces, as long as no cavitation occurs → 19.

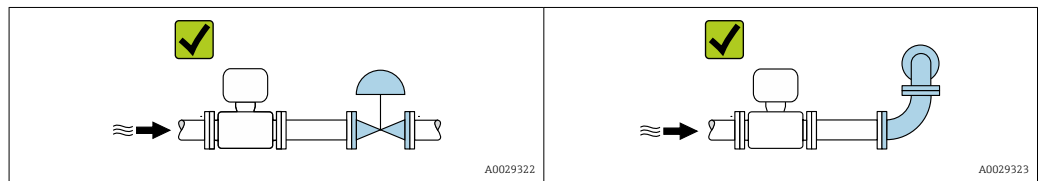

*Installation dimensions*

For the dimensions and installation lengths of the device, see the "Technical Information" document, "Mechanical construction" section

**6.1.2 Environmental and process requirements**

**Ambient temperature range**

<b>Measuring instrument</b>	-40 to +60 °C (-40 to +140 °F) (Sensor, transmitter) Install the measuring instrument in a shady location. Avoid direct sunlight, particularly in warm climatic regions.
-----------------------------	--

**Static pressure**

It is important that cavitation does not occur, or that gases entrained in the liquids do not outgas.

Cavitation is caused if the pressure drops below the vapor pressure:

- In liquids that have a low boiling point (e.g. hydrocarbons, solvents, liquefied gases)
- In suction lines
- ▶ Ensure the static pressure is sufficiently high to prevent cavitation and outgassing.

For this reason, the following mounting locations are recommended:

- At the lowest point in a vertical pipe
- Downstream from pumps (no danger of vacuum)

### Thermal insulation

In the case of some fluids, it is important to keep the heat radiated from the sensor to the transmitter to a low level. A wide range of materials can be used for the required insulation.

#### NOTICE

#### Electronics overheating on account of thermal insulation!

- ▶ Recommended orientation: horizontal orientation, transmitter housing pointing downwards.
- ▶ Do not insulate the transmitter housing .
- ▶ Maximum permissible temperature at the lower end of the transmitter housing: 80 °C (176 °F)
- ▶ Regarding thermal insulation with an exposed extended neck: We advise against insulating the extended neck to ensure optimal heat dissipation.

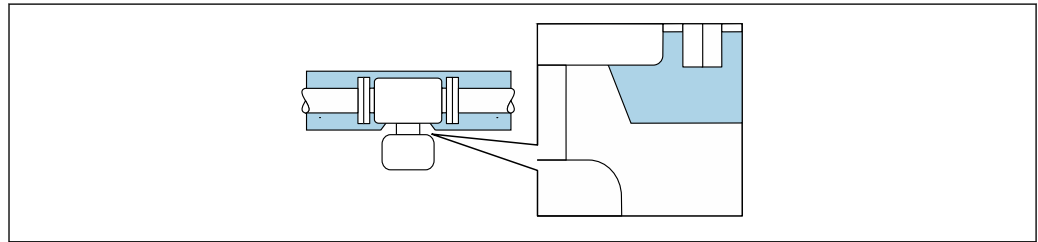

A0034391

8 Thermal insulation with exposed extended neck

### Heating

#### NOTICE

#### Electronics can overheat due to elevated ambient temperature!

- ▶ Observe maximum permitted ambient temperature for the transmitter.
- ▶ Depending on the medium temperature, take the device orientation requirements into account.

#### NOTICE

#### Danger of overheating when heating

- ▶ Ensure that the temperature at the lower end of the transmitter housing does not exceed 80 °C (176 °F).
- ▶ Ensure that sufficient convection takes place at the transmitter neck.
- ▶ Ensure that a sufficiently large area of the transmitter neck remains exposed. The uncovered part serves as a radiator and protects the electronics from overheating and excessive cooling.

#### Heating options

If a fluid requires that no heat loss should occur at the sensor, users can avail of the following heating options:

- Electrical heating, e.g. with electric band heaters <sup>1)</sup>
- Via pipes carrying hot water or steam
- Via heating jackets

1) The use of parallel electric band heaters is generally recommended (bidirectional electricity flow). Particular considerations must be made if a single-wire heating cable is to be used. For additional information, refer to EA01339D "Installation Instructions for Electrical Trace Heating Systems".

**Vibrations**

The high oscillation frequency of the measuring tubes ensures that the correct operation of the measuring system is not influenced by plant vibrations.

**6.1.3 Special mounting instructions**

**Information for filling systems**

Correct measurement is only possible if the pipe is completely full. We therefore recommend that some test batches be carried out prior to production batching.

*Circular filling system*

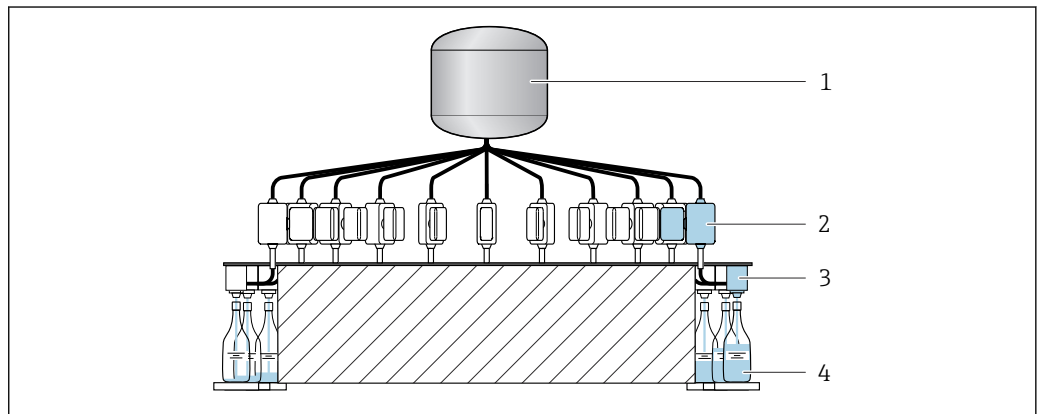

A0003761

- 1 Tank
- 2 Measuring instrument
- 3 Filling valve
- 4 Vessel

*Linear filling system*

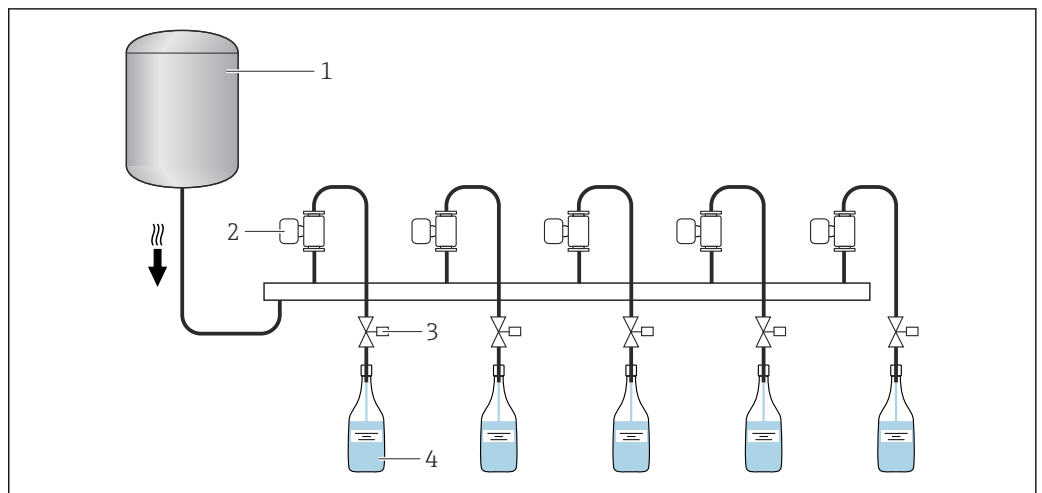

A0003762

- 1 Tank
- 2 Measuring instrument
- 3 Filling valve
- 4 Vessel

**Hygienic compatibility**

**i** When installing in hygienic applications, please refer to the information in the "Certificates and approvals/hygienic compatibility" section → 62

### Sensor holder DN 1 to 4 ( $\frac{1}{2}$ " to $\frac{1}{8}$ "

- The appropriate sensor holder must be used for all applications with increased safety or load requirements and for sensors with clamp process connections.
- The Endress+Hauser sensor holder is generally recommended for mounting for all applications → 49.

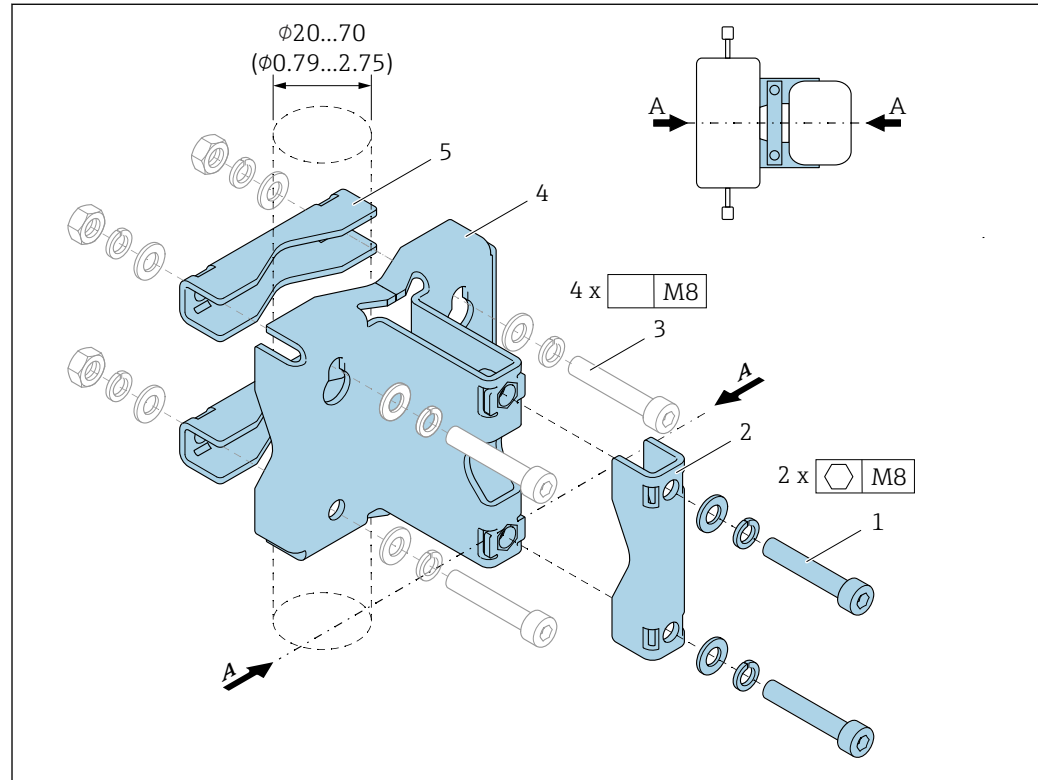

A0036471

- 1 2 x Allen screw M8 x 50, washer and spring washer A4  
 2 1 x clamp (measuring instrument neck)  
 3 4 x securing screw for wall, tabletop or pipe mounting (not supplied)  
 4 1 x base profile  
 5 2 x clamp (pipe mounting)  
 A Measuring instrument central line

### **WARNING**

#### Strain on pipes!

Excessive strain on an unsupported pipe can cause the pipe to break.

- Install the sensor in a sufficiently supported pipe. In addition to the use of the sensor holder, for maximum mechanical stability the sensor can also be supported on the inlet and outlet sides onsite at the installation location with the use of pipe clamps, for example.

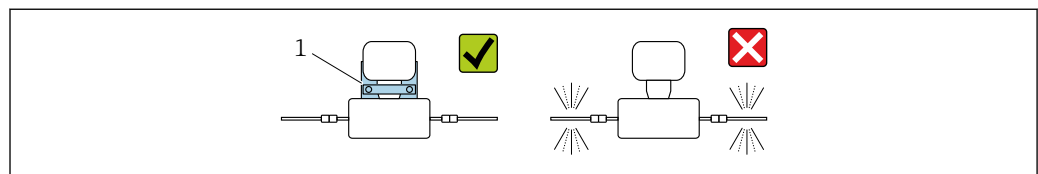

A0036492

- 1 Sensor holder Order number: 71392563

**The following mounting versions are recommended for the installation:**

-  Lubricate all threaded joints prior to mounting. The screws for wall, tabletop or pipe mounting are not supplied with the device and must be chosen to suit the individual installation position.

*Wall mounting*

Screw the sensor holder to the wall with four screws. Two of the four holes to secure the holder are designed to hook into the screws.

*Mounting on a table*

Screw the sensor holder onto the tabletop with four screws.

*Pipe mounting*

Secure the sensor holder to the pipe with two clamps.



**⚠ WARNING**

**Failure to comply with the specifications for vibration and shock resistance can damage the measuring instrument!**

- ▶ During operation, transportation and storage, ensure compliance with the specifications for maximum vibration and shock resistance →  57.

**Zero adjustment**

The **Sensor adjustment** submenu contains parameters required for zero adjustment.

-  Detailed information on the "**Sensor adjustment** submenu": Device parameters →  63

**NOTICE**

**All Dosimass measuring instruments are calibrated in accordance with state-of-the-art technology. Calibration takes place under reference conditions .**

Zero adjustment is therefore not required for the Dosimass as a general rule.

- ▶ Experience shows that a zero adjustment is advisable only in special cases.
- ▶ When maximum measurement accuracy is required and flow rates are very low.
- ▶ Under extreme process or operating conditions (e.g. very high process temperatures or very high-viscosity fluids).

-  Detailed information on reference operating conditions →  53

*Prerequisites for zero adjustment*

Note the following points before performing the adjustment:

- A zero adjustment can be performed only with fluids that contain no gas or solid contents.
- Zero adjustment is performed with the measuring tubes completely filled and at zero flow ( $v = 0 \text{ m/s}$  ( $0 \text{ ft/s}$ )). Shutoff valves, for example, may be provided for this purpose or existing valves and sliders can be used.
  - Normal operation → Valve 1 open
  - Zero adjustment → Valve 1 closed

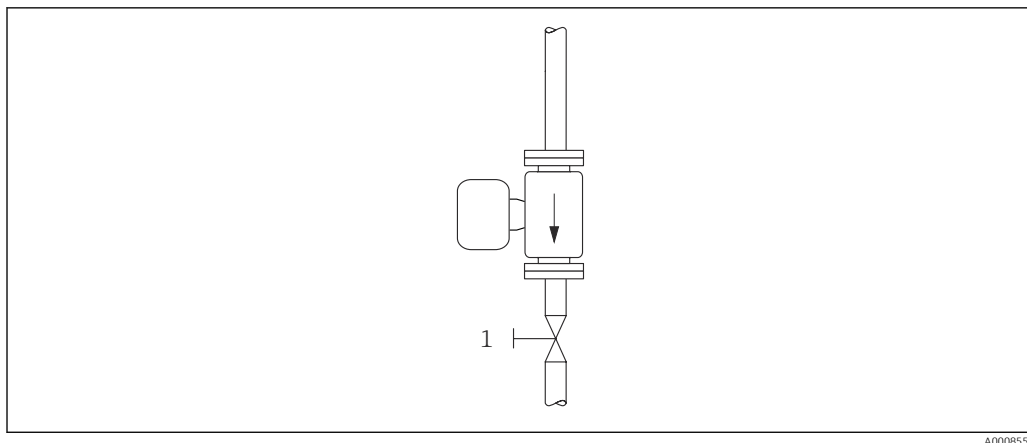

9

### Performing the zero adjustment

1. Let the system run until normal operating conditions are present.
2. Stop the flow ( $v = 0$  m/s (0 ft/s)).
3. Check the shutoff valves for leaks.
4. Perform adjustment using the **Zero point adjustment control** function.

## 6.2 Installing the device

### 6.2.1 Required tools

For process connections, use the appropriate installation tool

### 6.2.2 Preparing the measuring instrument

1. Remove all remaining transport packaging.
2. Remove any protective covers or protective caps present from the sensor.
3. Remove the transport label on the transmitter housing.

### 6.2.3 Mounting the measuring device

#### **⚠ WARNING**

#### **Danger due to improper process sealing!**

- ▶ Ensure that the inside diameters of the gaskets are greater than or equal to that of the process connections and piping.
- ▶ Ensure that the seals are clean and undamaged.
- ▶ Secure the seals correctly.
  
- ▶ Ensure that the direction of the arrow on the nameplate of the sensor matches the flow direction of the medium.

### 6.3 Post-installation check

Is the device undamaged (visual inspection)?	<input type="checkbox"/>
Does the measuring instrument correspond to the measuring point specifications? For example: <ul style="list-style-type: none"> <li>▪ Process temperature → 57</li> <li>▪ Pressure (refer to the "Pressure-temperature ratings" section of the "Technical Information" document).</li> <li>▪ Ambient temperature → 56</li> <li>▪ Measuring range → 50</li> </ul>	<input type="checkbox"/>
Has the correct orientation for the sensor been selected → 17? <ul style="list-style-type: none"> <li>▪ According to sensor type</li> <li>▪ According to medium temperature</li> <li>▪ According to medium properties (outgassing, with entrained solids)</li> </ul>	<input type="checkbox"/>
Does the arrow on the sensor match the direction of flow of the medium? → 12?	<input type="checkbox"/>
Is the tag name and labeling correct (visual inspection)?	<input type="checkbox"/>
Is the device sufficiently protected from precipitation and direct sunlight?	<input type="checkbox"/>

## 7 Electrical connection

### WARNING

**Live parts! Incorrect work performed on the electrical connections can result in an electric shock.**

- ▶ Set up a disconnecting device (switch or power-circuit breaker) to easily disconnect the device from the supply voltage.
- ▶ In addition to the device fuse, include an overcurrent protection unit with max. 16 A in the plant installation.

### 7.1 Electrical safety

In accordance with applicable national regulations.

### 7.2 Connecting requirements

#### 7.2.1 Requirements for connection cable

The connecting cables provided by the customer must fulfill the following requirements.

##### Permitted temperature range

- The installation guidelines that apply in the country of installation must be observed.
- The cables must be suitable for the minimum and maximum temperatures to be expected.

##### Signal cable

 Cables are not included in the scope of delivery.

 Please note the following with regard to cable loading:  
Voltage drop due to the cable length and cable type.

*Pulse/frequency/switch output*

Standard installation cable is sufficient.

#### 7.2.2 Terminal assignment

Connection is solely by means of device plug →  26.

#### 7.2.3 Available device plugs

##### Device version: 2 pulse/frequency/switch outputs

Order code for "Output, input": option AA:  
2 pulse/frequency/switch outputs

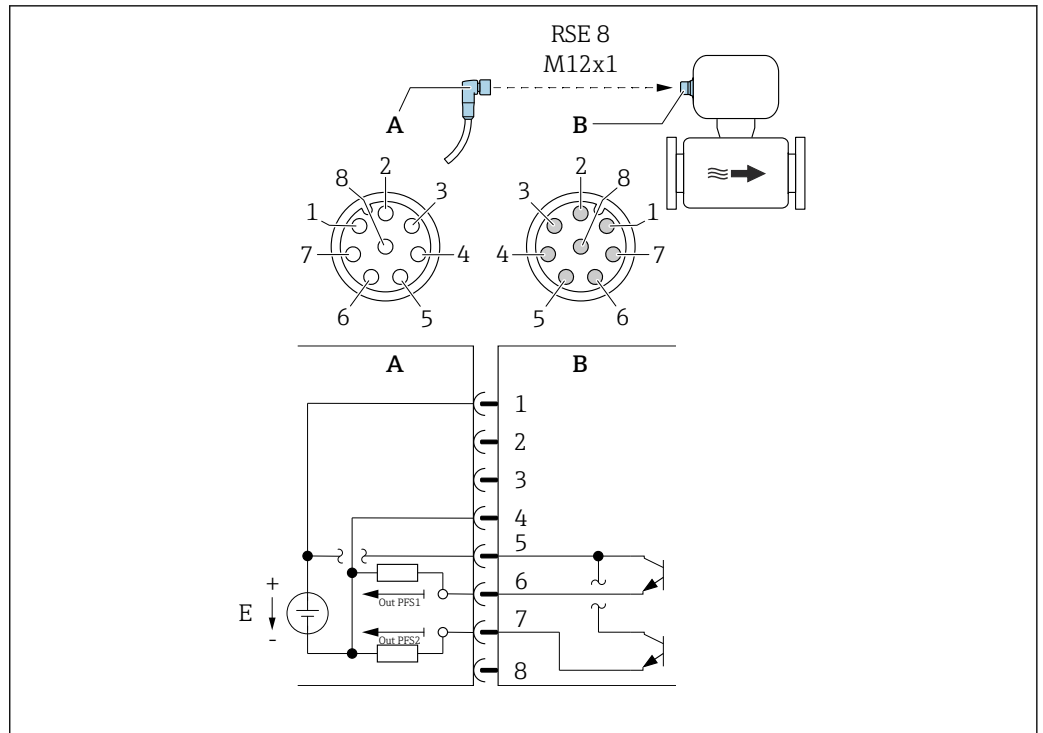

A0054873

10 Connection to device

- A Coupling: Supply voltage, pulse/freq./switch output
- B Connector: Supply voltage, pulse/freq./switch output
- E PELV or SELV power supply
- 1 to Pin assignment
- 8

Pin assignment

Connection: Coupling (A) – Connector (B)		
Pin	Assignment	
1	L+	Supply voltage
2	+	Service interface RX
3	+	Service interface TX
4	L-	Supply voltage
5	+	Pulse/frequency/switch output 1 and 2
6	-	Pulse/frequency/switch output 1
7	-	Pulse/frequency/switch output 2
8	-	Service interface GND

7.2.4 Requirements for the supply unit

Supply voltage

DC 24 V (nominal voltage: DC 18 to 30 V)

- i** The power unit must be tested to ensure that it meets safety requirements (e.g. PELV/SELV Class II limited energy).
  - The equipment is classified as Class III.

## 7.3 Connecting the device

### NOTICE

**An incorrect connection compromises electrical safety!**

- ▶ Only properly trained specialist staff may perform electrical connection work.
- ▶ Observe applicable federal/national installation codes and regulations.
- ▶ Comply with local workplace safety regulations.
- ▶ When using in potentially explosive atmospheres, observe the information in the device-specific Ex documentation.

### 7.3.1 Connection via device plug

Connection is solely by means of device plug.

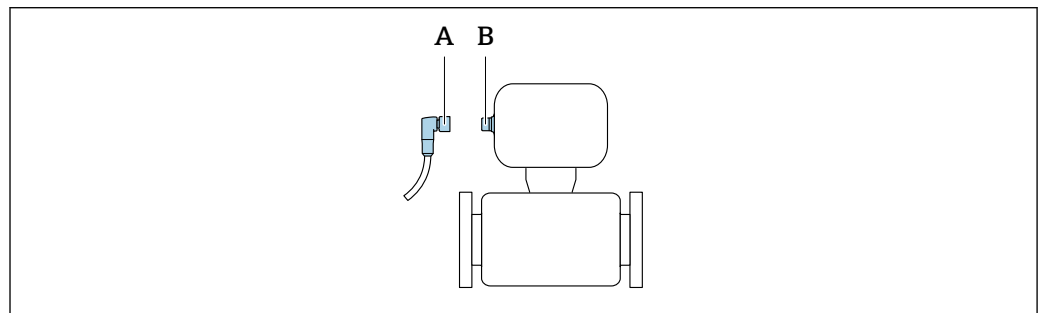

A0032652

- A Coupling
- B Plug

### 7.3.2 Grounding

Grounding is by means of a cable socket.

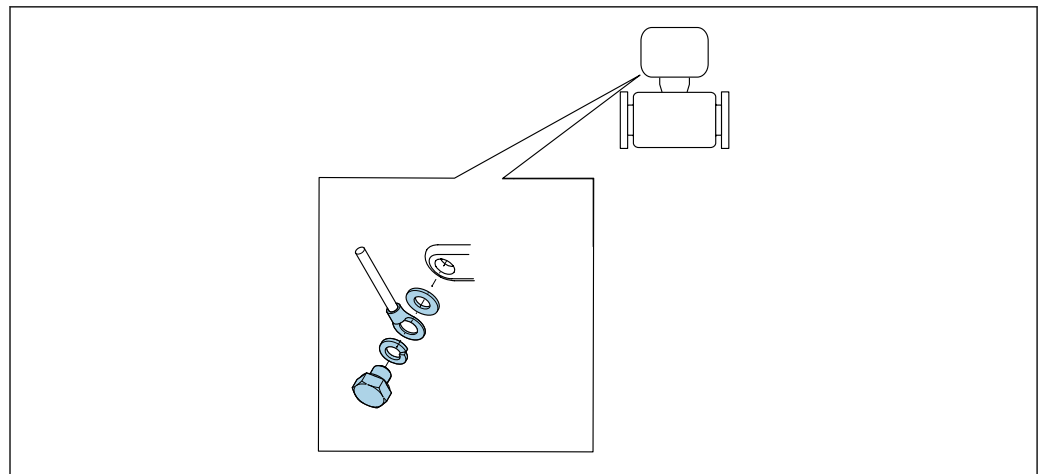

A0053306

## 7.4 Ensuring potential equalization

No special measures for potential equalization are required.





## 7.5 Ensuring the degree of protection

The measuring device fulfills all the requirements for IP67 degree of protection, Type 4X enclosure.

To guarantee IP67 degree of protection, Type 4X enclosure, carry out the following steps after the electrical connection:

- ▶ Tighten all device plugs.

## 7.6 Post-connection check

Is the device undamaged (visual inspection)?	<input type="checkbox"/>
Does the supply voltage match the specifications on the transmitter nameplate →  12?	<input type="checkbox"/>
Do the cables used meet the requirements →  26?	<input type="checkbox"/>
Are the mounted cables strain relieved?	<input type="checkbox"/>
Is the terminal assignment correct →  26?	<input type="checkbox"/>
Is the protective earthing established correctly →  28?	<input type="checkbox"/>
Are the maximum values for voltage and current observed at the pulse/frequency/switch outputs →  51?	<input type="checkbox"/>

## 8 Operation options

### 8.1 Overview of operation options

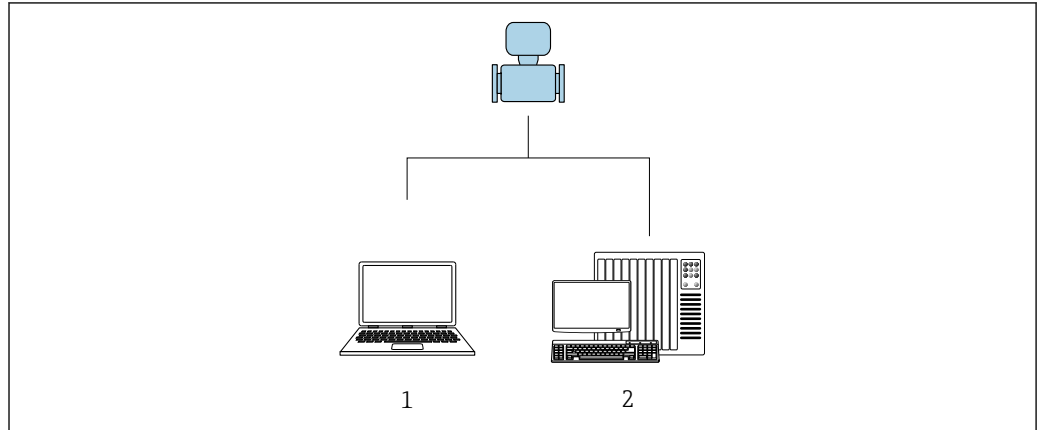

A0017760

- 1 Computer with "FieldCare" or "DeviceCare" operating tool
- 2 Control system (e.g. PLC)

### 8.2 Access to the operating menu via the operating tool

#### 8.2.1 Connecting the operating tool

##### Using service adapter and Commubox FXA291

Operation and configuration can be performed using the Endress+Hauser FieldCare or DeviceCare service and configuration software.

The device is connected to the USB port of the computer via the service adapter and Commubox FXA291.

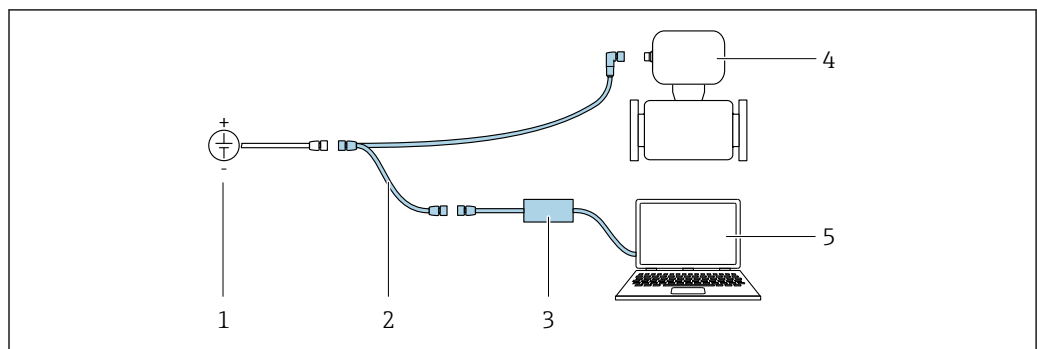

A0032567

- 1 Supply voltage 24 V DC
- 2 Service adapter
- 3 Commubox FXA291
- 4 Dosimass
- 5 Computer with "FieldCare" or "DeviceCare" operating tool

**i** The service adapter, cable and Commubox FXA291 are not included in the delivery. These components can be ordered as accessories → 49.

## 8.2.2 FieldCare

### Function range

FDT-based (Field Device Technology) plant asset management tool from Endress+Hauser. It can configure all smart field units in a system and helps you manage them. By using the status information, it is also a simple but effective way of checking their status and condition.

Access is via:

Service adapter and Commubox FXA291

Typical functions:

- Transmitter parameter configuration
- Loading and saving of device data (upload/download)
- Documentation of the measuring point
- Visualization of the measured value memory (line recorder) and event logbook



- Operating Instructions BA00027S
- Operating Instructions BA00059S



Source for device description files →  33

### Establishing a connection

Service adapter, Commubox FXA291 and "FieldCare" operating tool

1. Start FieldCare and launch the project.
2. In the network: Add a device.
  - ↳ The **Add device** window opens.
3. Select the **CDI Communication FXA291** option from the list and press **OK** to confirm.
4. Right-click **CDI Communication FXA291** and select the **Add device** option in the context menu that opens.
5. Select the desired device from the list and press **OK** to confirm.
6. Establish the online connection to the device.



- Operating Instructions BA00027S
- Operating Instructions BA00059S

## User interface

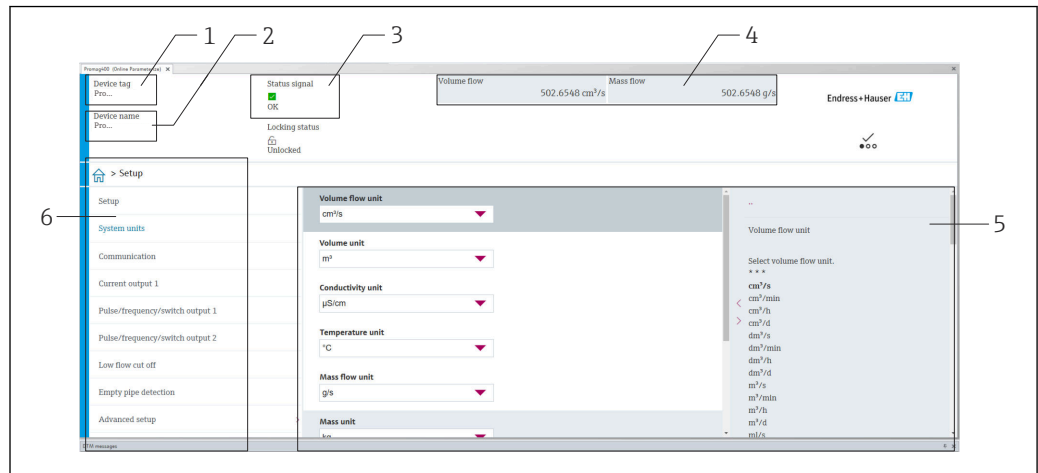

A0008200

- 1 Device name
- 2 Device tag
- 3 Status area with status signal → 37
- 4 Display area for current measured values
- 5 Editing toolbar with other functions
- 6 Navigation area with operating menu structure

### 8.2.3 DeviceCare

#### Function range

Tool for connecting and configuring Endress+Hauser field devices.

The fastest way to configure Endress+Hauser field devices is with the dedicated "DeviceCare" tool. Together with the device type managers (DTMs) it presents a convenient, comprehensive solution.



Innovation brochure IN01047S





Source for device description files → 33

## 9 System integration

### 9.1 Overview of device description files

#### 9.1.1 Current version data for the device

Firmware version	04.00.zz	<ul style="list-style-type: none"> <li>▪ On the title page of the manual</li> <li>▪ On the transmitter nameplate →  12</li> <li>▪ Firmware version System → Information → Device → Firmware version</li> </ul>
Release date of firmware version	07.2024	---

 For an overview of the various firmware versions for the device →  45

#### 9.1.2 Operating tools



The suitable device description file for the individual operating tools is listed in the table below, along with information on where the file can be acquired.

Operating tool	Sources for obtaining device descriptions
FieldCare	<ul style="list-style-type: none"> <li>▪ <a href="http://www.endress.com">www.endress.com</a> → Downloads area</li> <li>▪ USB stick (contact Endress+Hauser)</li> <li>▪ DVD (contact Endress+Hauser)</li> </ul>
DeviceCare	<ul style="list-style-type: none"> <li>▪ <a href="http://www.endress.com">www.endress.com</a> → Downloads area</li> <li>▪ CD-ROM (contact Endress+Hauser)</li> <li>▪ DVD (contact Endress+Hauser)</li> </ul>

## 10 Commissioning

### 10.1 Post-mounting and post-connection check

Before commissioning the device:

- ▶ Make sure that the post-installation and post-connection checks have been performed successfully.
- Checklist for "Post-installation" check →  25
- Checklist for "Post-connection" check →  29



### 10.2 Switching on the measuring device

- ▶ The function check has been completed successfully.  
Switch on the supply voltage.
  - ↳ The measuring device runs through internal test functions.

The device is operational and operation commences.

 If the device does not start up successfully, depending on the cause, a diagnostic message is displayed in the system asset management tool "FieldCare".

### 10.3 Connecting via FieldCare

- For connecting FieldCare →  30
- For connecting via FieldCare →  31
- For user interface of FieldCare →  32

### 10.4 Configuring the measuring instrument

 The device-specific parameters are configured via the "**Commissioning** wizard".

 For detailed information on the "**Commissioning** wizard": Separate "Description of Device Parameters "(GP) document

# 11 Operation

## 11.1 Reading the device locking status

### Navigation

"System" menu → Device management → Locking status

#### Parameter overview with brief description

Parameter	Description	User interface
Locking status	Indicates the write protection with the highest priority that is currently active.	Temporarily locked

## 11.2 Reading access authorization status on operating software

### Navigation

"System" menu → User management → User role

#### Parameter overview with brief description

Parameter	Description	User interface
User role	Displays the role the user is currently logged on in. The role determines the user's access rights for the parameters. The access rights can be changed via the "Enter access code" parameter.	<ul style="list-style-type: none"> <li>▪ Operator</li> <li>▪ Maintenance</li> <li>▪ Service</li> <li>▪ Production</li> <li>▪ Development</li> </ul>

## 11.3 Reading measured values

### Navigation

"Application" menu → Measured values



#### Parameter overview with brief description

Parameter	Description	User interface
Mass flow	Shows the mass flow currently measured.	Signed floating-point number
Volume flow	Shows the volume flow currently measured.	Signed floating-point number
Density	Shows the density currently measured.	Positive floating-point number
Temperature	Shows the medium temperature currently measured.	Positive floating-point number

## 11.4 Adapting the measuring instrument to the process conditions

The following menus are available for this purpose:

- Guidance
- Application

 Detailed information on "**Guidance** menu" and "**Application** menu": Device parameters  
→  63

## 11.5 Performing a totalizer reset

### Navigation

"Application" menu → Totalizers → Totalizer handling → Reset all totalizers

### Parameter overview with brief description

Parameter	Description	Selection
Reset all totalizers	Reset all totalizers to "0" and restart the totalizers. The counter readings are not logged prior to the reset.	<ul style="list-style-type: none"> <li>▪ Cancel</li> <li>▪ Reset + totalize</li> </ul>

## 12 Diagnostics and troubleshooting

### 12.1 General troubleshooting

For access

Fault	Possible causes	Remedial action
Write access to parameters is not possible.	Current user role has limited access authorization.	Check the access authorization status →  35.
Connection via service interface is not possible.	<ul style="list-style-type: none"> <li>The USB port on the PC is incorrectly configured.</li> <li>The driver is not installed correctly.</li> </ul>	Refer to the documentation on Commubox FXA291: Technical Information TI00405C

### 12.2 Diagnostic information in FieldCare or DeviceCare

#### 12.2.1 Diagnostic options

Any faults detected by the measuring device are displayed on the home page of the operating tool once the connection has been established.

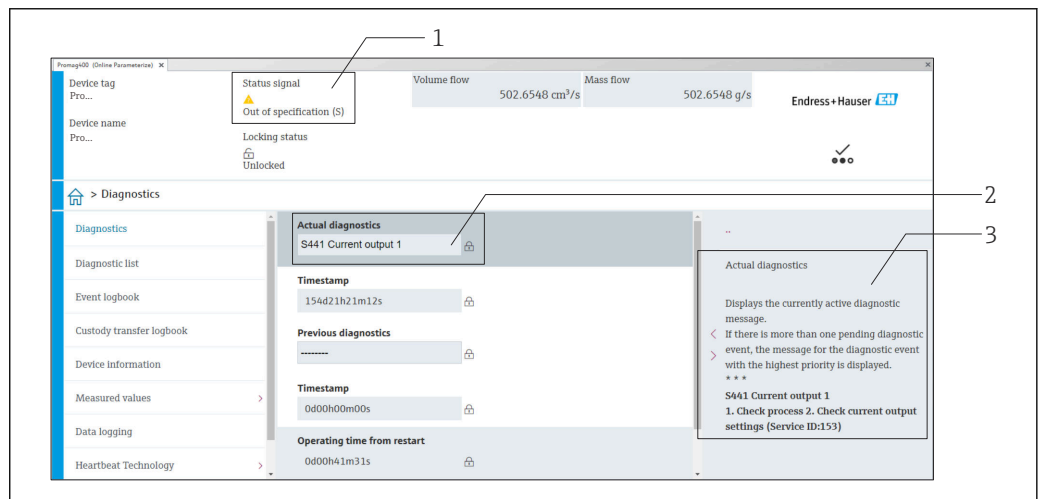

A0008199

- 1 Status area with status signal
- 2 Diagnostic information → 38
- 3 Remedial measures with service ID

In addition, diagnostic events which have occurred can be shown in the **Diagnostics** menu:

- Via parameter
- Via submenu

#### Status signals

The status signals provide information on the state and reliability of the device by categorizing the cause of the diagnostic information (diagnostic event).

Symbol	Meaning
	<b>Failure</b> A device error has occurred. The measured value is no longer valid.
	<b>Function check</b> The device is in service mode (e.g. during a simulation).
	<b>Out of specification</b> The device is being operated: Outside its technical specification limits (e.g. outside the process temperature range)
	<b>Maintenance required</b> Maintenance is required. The measured value remains valid.

The status signals are categorized in accordance with VDI/VDE 2650 and NAMUR Recommendation NE 107.

### Diagnostic information

The fault can be identified using the diagnostic information. The short text helps you by providing information about the fault.

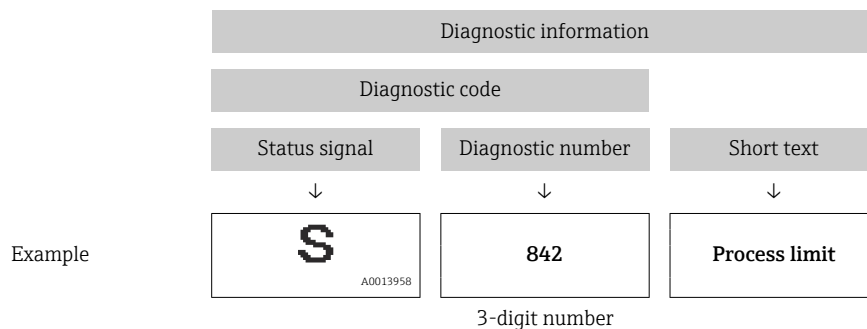

### 12.2.2 Calling up remedy information

Remedy information is provided for every diagnostic event to ensure that problems can be rectified quickly:

- On the home page  
Remedy information is displayed in a separate field below the diagnostics information.
- In the **Diagnostics** menu  
Remedy information can be called up in the working area of the user interface.

The user is in the **Diagnostics** menu.

1. Call up the desired parameter.
2. On the right in the working area, mouse over the parameter.
  - ↳ A tool tip with remedy information for the diagnostic event appears.

## 12.3 Adapting the diagnostic information

### 12.3.1 Adapting the diagnostic behavior



Each item of diagnostic information is assigned a specific diagnostic behavior at the factory. The user can change this assignment for specific diagnostic information in the **Diagnostic settings** submenu.

Diagnostics → Diagnostic settings

You can assign the following options to the diagnostic number as the diagnostic behavior:

Options	Description
Alarm	The device stops measurement. The signal outputs and totalizers assume the defined alarm condition. A diagnostic message is generated.
Warning	The device continues to measure. The signal outputs and totalizers are not affected. A diagnostic message is generated.
Logbook entry only	The device continues to measure. The diagnostic message is entered only in the <b>Event logbook</b> submenu.
Off	The diagnostic event is ignored, and no diagnostic message is generated or entered.

## 12.4 Overview of diagnostic information

 In the case of some items of diagnostic information, the diagnostic behavior can be changed. Adapting the diagnostic information →  38

Diagnostic number	Short text	Remedy instructions	Status signal [from the factory]	Diagnostic behavior [from the factory]
<b>Diagnostic of sensor</b>				
022	Temperature sensor defective	Replace device	F	Alarm
046	Sensor limit exceeded	1. Check process conditions 2. Check sensor	S	Warning <sup>1)</sup>
062	Sensor connection faulty	Replace device	F	Alarm
082	Data storage inconsistent	1. Restart device 2. Replace device	F	Alarm
083	Memory content inconsistent	1. Restart device 2. Restore S-DAT	F	Alarm
140	Sensor signal asymmetrical	Replace device	S	Warning
<b>Diagnostic of electronic</b>				
201	Electronics faulty	1. Restart device 2. Replace device	F	Alarm
242	Firmware incompatible	1. Check firmware version 2. Flash device	F	Alarm
252	Module incompatible	Replace device	F	Alarm
270	Main electronics defective	1. Restart device 2. Replace device	F	Alarm
271	Main electronics faulty	1. Restart device 2. Replace device	F	Alarm
272	Electronic module faulty	Restart device	F	Alarm
273	Main electronics defective	1. Restart device 2. Replace device	F	Alarm
283	Memory content inconsistent	Restart device	F	Alarm
311	Electronic module faulty	Maintenance required! Do not reset device	M	Warning
331	Firmware update failed in module 1 to n	1. Update firmware of device 2. Restart device	F	Warning

Diagnostic number	Short text	Remedy instructions	Status signal [from the factory]	Diagnostic behavior [from the factory]
372	Electronic module faulty	1. Restart device 2. Check if failure recurs 3. Replace device	F	Alarm
374	Electronic module faulty	Restart device	S	Warning <sup>1)</sup>
<b>Diagnostic of configuration</b>				
410	Data transfer failed	1. Retry data transfer 2. Check connection	F	Alarm
412	Processing download	Download active, please wait	C	Warning
437	Configuration incompatible	1. Update firmware 2. Execute factory reset	F	Alarm
438	Dataset different	1. Check dataset file 2. Check device parameterization 3. Download new device parameterization	M	Warning
442	Frequency output 1 to n saturated	1. Check frequency output settings 2. Check process	S	Warning <sup>1)</sup>
443	Pulse output 1 to n saturated	1. Check pulse output settings 2. Check process	S	Warning <sup>1)</sup>
453	Flow override active	Deactivate flow override	C	Warning
484	Failure mode simulation active	Deactivate simulation	C	Alarm
485	Process variable simulation active	Deactivate simulation	C	Warning
492	Frequency output 1 to n simulation active	Deactivate simulation frequency output	C	Warning
493	Pulse output 1 to n simulation active	Deactivate simulation pulse output	C	Warning
494	Switch output 1 to n simulation active	Deactivate simulation switch output	C	Warning
495	Diagnostic event simulation active	Deactivate simulation	C	Warning
496	Status input 1 simulation active	Deactivate status input simulation	C	Warning
<b>Diagnostic of process</b>				
834	Process temperature too high	Reduce process temperature	S	Warning <sup>1)</sup>
835	Process temperature too low	Increase process temperature	S	Warning <sup>1)</sup>
842	Process value below limit	Low flow cut off active! Check low flow cut off configuration	S	Warning <sup>1)</sup>
862	Partly filled pipe	1. Check for gas in process 2. Adjust detection limits	S	Warning <sup>1)</sup>
880	Output overloaded	Reduce load at the outputs	S	Warning
910	Tubes not oscillating	1. Check electronic module 2. Check sensor	F	Alarm
912	Medium inhomogeneous	1. Check process cond. 2. Increase system pressure	S	Warning <sup>1)</sup>



Diagnostic number	Short text	Remedy instructions	Status signal [from the factory]	Diagnostic behavior [from the factory]
913	Medium unsuitable	1. Check process conditions 2. Check electronic modules or sensor	S	Warning <sup>1)</sup>
948	Oscillation damping too high	Check process conditions	S	Warning <sup>1)</sup>
991	Batch process aborted	Check process conditions	F	Alarm <sup>1)</sup>
992	Batch start failed	1. Check fill quantity 2. Check device status 3. Complete last batch 4. Check switch output configuration	F	Warning <sup>1)</sup>

1) Diagnostic behavior can be changed.

## 12.5 Pending diagnostic events







The **Diagnostics** menu allows the user to view the current diagnostic event and the previous diagnostic event separately.

 To call up the measures to rectify a diagnostic event:

- Via "FieldCare" operating tool →  38
- Via "DeviceCare" operating tool →  38

### Navigation

"Diagnostics" menu → Active diagnostics

<b>▶ Active diagnostics</b>	
Actual diagnostics	→  41
Timestamp	→  41
Previous diagnostics	→  42
Timestamp	→  42
Operating time from restart	→  42
Operating time	→  42

### Parameter overview with brief description

Parameter	Description	User interface
Actual diagnostics	Displays the currently active diagnostic message. If there is more than one pending diagnostic event, the message for the diagnostic event with the highest priority is displayed.	Positive integer
Timestamp	Displays the timestamp for the currently active diagnostic message.	Days (d), hours (h), minutes (m), seconds (s)

Parameter	Description	User interface
Previous diagnostics	Displays the diagnostic message for the last diagnostic event that has ended.	Positive integer
Timestamp	Displays the timestamp of the diagnostic message generated for the last diagnostic event that has ended.	Days (d), hours (h), minutes (m), seconds (s)
Operating time from restart	Indicates how long the device has been in operation since the last time the device was restarted.	Days (d), hours (h), minutes (m), seconds (s)
Operating time	Indicates how long the device has been in operation.	Days (d), hours (h), minutes (m), seconds (s)



## 12.6 Actual diagnostics

The current diagnostic message is displayed under Actual diagnostics. If several diagnostic events are pending at the same time, only the diagnostic message with the highest priority is displayed.

### Navigation path

Diagnostics → Active diagnostics → Actual diagnostics



 To call up the measures to rectify a diagnostic event:

- Via "FieldCare" operating tool →  38
- Via "DeviceCare" operating tool →  38

## 12.7 Event logbook

### 12.7.1 Event history

 To call up the measures to rectify a diagnostic event:

- Via "FieldCare" operating tool →  38
- Via "DeviceCare" operating tool →  38

### 12.7.2 Overview of information events

Unlike a diagnostic event, an information event is displayed in the event logbook only and not in the diagnostic list.

Info number	Info name
I1000	----- (Device ok)
I1089	Power on
I1090	Configuration reset
I1091	Configuration changed
I1111	Density adjust failure
I1151	History reset
I1157	Memory error event list
I1209	Density adjustment ok
I1221	Zero point adjust failure
I1222	Zero point adjustment ok
I1335	Firmware changed
I1397	Fieldbus: access status changed
I1398	CDI: access status changed
I1512	Download started
I1513	Download finished

Info number	Info name
I1514	Upload started
I1515	Upload finished
I1622	Calibration changed
I1624	All totalizers reset
I1629	CDI: login successful
I1635	Reset to delivery settings

## 12.8 Device reset

The entire device configuration or some of the configuration can be reset to a defined state with the **Device reset** parameter (→  43).

### Navigation

"System" menu → Device management → Device reset

### Parameter overview with brief description

Parameter	Description	Selection
Device reset	Reset the device configuration - either entirely or in part - to a defined state.	<ul style="list-style-type: none"> <li>■ Cancel</li> <li>■ To delivery settings</li> <li>■ Restart device</li> <li>■ Restore S-DAT backup *</li> <li>■ Create T-DAT backup</li> <li>■ Restore T-DAT backup *</li> </ul>

\* Visibility depends on order options or device settings







## 12.9 Device





The **Device** submenu contains all the parameters that display different information for identifying the device.

### Navigation

"System" menu → Information → Device

▶ Device

Device name	→  44
Device tag	→  44
Serial number	→  44
Order code	→  44
Firmware version	→  44
Extended order code 1	→  44

Extended order code 2	→  44
Extended order code 3	→  44
ENP version	→  44
Manufacturer	→  44

### Parameter overview with brief description

Parameter	Description	User interface / User entry
Device name	Displays the name of the transmitter. The transmitter name is also provided on the nameplate of the transmitter.	Character string comprising numbers, letters and special characters
Device tag	Enter a unique designation for the measuring point to be able to easily identify it within the plant.	Character string comprising numbers, letters and special characters (32)
Serial number	Displays the serial number of the measuring device. The serial number is also provided on the nameplate of the sensor and of the transmitter.  The serial number can also be used to retrieve further device-related information and documentation via the Operations app or the Device Viewer on the Endress+Hauser website.	Character string comprising numbers, letters and special characters
Order code	Displays the device order code.  The order code is used for instance to order a replacement or spare device or to verify that the device features specified on the order form match the shipping note.	Character string comprising numbers, letters and special characters
Firmware version	Displays the device firmware version installed.	Character string comprising numbers, letters and special characters
Extended order code 1	Displays the first, second and/or third part of the extended order code.  Due to character length restrictions, the extended order code is split into a maximum of 3 parameters. The extended order code indicates for each feature in the product structure the selected option, thereby uniquely identifying the device model.  The extended order code can also be found on the nameplate.	Character string comprising numbers, letters and special characters
Extended order code 2	Displays the first, second and/or third part of the extended order code.  Due to character length restrictions, the extended order code is split into a maximum of 3 parameters. The extended order code indicates for each feature in the product structure the selected option, thereby uniquely identifying the device model.  The extended order code can also be found on the nameplate.	Character string comprising numbers, letters and special characters
Extended order code 3	Displays the first, second and/or third part of the extended order code.  Due to character length restrictions, the extended order code is split into a maximum of 3 parameters. The extended order code indicates for each feature in the product structure the selected option, thereby uniquely identifying the device model.  The extended order code can also be found on the nameplate.	Character string comprising numbers, letters and special characters
ENP version	Displays the version of the electronic nameplate (ENP).	Character string comprising numbers, letters and special characters
Manufacturer	Displays the manufacturer.	Character string comprising numbers, letters and special characters

## 12.10 Firmware history

Release date	Firmware version	Order code for "Firmware version"	Firmware Changes	Documentation type	Documentation
07.2024	04.00.zz	Option 76	<ul style="list-style-type: none"> <li>▪ New original firmware</li> <li>▪ Can be operated via FieldCare and DeviceCare</li> </ul>	Operating Instructions	BA02346D/06/EN/01.24-00
09.2015	03.00.zz	Option A	No change in firmware	Operating Instructions	BA00097D/06/EN/16.15
08.2014	03.00.zz	Option A	<ul style="list-style-type: none"> <li>▪ New original firmware</li> <li>▪ Can be operated via FieldCare and DeviceCare</li> </ul>	Operating Instructions	BA00097D/06/EN/15.14
08.2012	01.01.zz	-	No change in firmware	Operating Instructions	BA00097D/06/EN/14.12
01.2011	01.01.zz	-	No change in firmware	Operating Instructions	BA00097D/06/EN/13.11
04.2007	01.01.zz	-	New functionality: <ul style="list-style-type: none"> <li>▪ Selection of measuring mode for pulse output.</li> <li>▪ New limit switch for status output with the possibility of determining the switch-on and switch-off values individually.</li> <li>▪ Choice of mode for pressure shock suppression.</li> <li>▪ New option to delete error memory.</li> </ul>	Operating Instructions	BA097D/06/EN/04.07
12.2003	01.00.zz	-	<ul style="list-style-type: none"> <li>▪ Original firmware</li> <li>▪ Can be operated via FieldCare</li> </ul>	Operating Instructions	BA097D/06/EN/01.14

 For the compatibility of the firmware version with the previous version, the installed device description files and operating tools, observe the information about the device in the "Manufacturer's information" document.

 The manufacturer's information is available:

- In the Download Area of the Endress+Hauser web site: [www.endress.com](http://www.endress.com) → Downloads
- Specify the following details:
  - Product root: e.g. D8AB  
The product root is the first part of the order code: see the nameplate on the device.
  - Text search: Manufacturer's information
  - Media type: Documentation – Technical Documentation

## 13 Maintenance

### 13.1 Maintenance work

No special maintenance work is required.

#### 13.1.1 Exterior cleaning

When cleaning the exterior of measuring devices, always use cleaning agents that do not attack the surface of the housing or the seals.

#### 13.1.2 Internal cleaning

Observe the following points for CIP and SIP cleaning:

- Use only cleaning agents to which the process-wetted materials are adequately resistant.
- Observe the maximum permitted medium temperature for the measuring device  
→  57.

### 13.2 Measuring and test equipment

Endress+Hauser offers a variety of measuring and testing equipment, such as Netilion or device tests.

 Your Endress+Hauser Sales Center can provide detailed information on the services.

List of some of the measuring and testing equipment: →  49

### 13.3 Endress+Hauser services

Endress+Hauser offers a wide variety of services for maintenance such as recalibration, maintenance service or device tests.

 Your Endress+Hauser Sales Center can provide detailed information on the services.

## 14 Repair

### 14.1 General information

#### 14.1.1 Repair and conversion concept

The Endress+Hauser repair and conversion concept provides for the following:

- The measuring device cannot be converted.
- If the measuring device is defective, the entire device is replaced.
- It is possible to replace seals.

### 14.2 Endress+Hauser services

Endress+Hauser offers a wide range of services.

 Your Endress+Hauser Sales Center can provide detailed information on the services.

### 14.3 Return

The requirements for safe device return can vary depending on the device type and national legislation.

1. Refer to the web page for information:  
<https://www.endress.com/support/return-material>  
↳ Select the region.
2. If returning the device, pack the device in such a way that it is reliably protected against impact and external influences. The original packaging offers the best protection.

### 14.4 Disposal

 If required by the Directive 2012/19/EU on waste electrical and electronic equipment (WEEE), the product is marked with the depicted symbol in order to minimize the disposal of WEEE as unsorted municipal waste. Do not dispose of products bearing this marking as unsorted municipal waste. Instead, return them to the manufacturer for disposal under the applicable conditions.

#### 14.4.1 Removing the measuring device

1. Switch off the device.

#### WARNING

**Danger to persons from process conditions!**

- ▶ Beware of hazardous process conditions such as pressure in the measuring device, high temperatures or aggressive media.
2. Carry out the mounting and connection steps from the "Mounting the measuring device" and "Connecting the measuring device" sections in reverse order. Observe the safety instructions.

### 14.4.2 Disposing of the measuring device

**⚠ WARNING**

**Danger to personnel and environment from fluids that are hazardous to health.**

- ▶ Ensure that the measuring device and all cavities are free of fluid residues that are hazardous to health or the environment, e.g. substances that have permeated into crevices or diffused through plastic.



Observe the following notes during disposal:

- ▶ Observe valid federal/national regulations.
- ▶ Ensure proper separation and reuse of the device components.



## 15 Accessories

Various accessories, which can be ordered with the device or subsequently from Endress+Hauser, are available for the device. Detailed information on the order code in question is available from your local Endress+Hauser sales center or on the product page of the Endress+Hauser website: [www.endress.com](http://www.endress.com).

### 15.1 Device-specific accessories

Accessories	Description
Sensor holder	<p>For wall, tabletop and pipe mounting.</p> <p> Order number: 71392563</p> <p> Installation Instructions EA01195D</p>

### 15.2 Communication-specific accessories

Accessory	Description
FieldCare	<p>FDT-based plant asset management tool from Endress+Hauser. It can configure all smart field units in your system and helps you manage them. By using the status information, it is also a simple but effective way of checking their status and condition.</p> <p> Operating Instructions BA00027S and BA00059S</p>
DeviceCare	<p>Tool to connect and configure Endress+Hauser field devices.</p> <p> Innovation brochure IN01047S</p>
Commubox FXA291	<p>Connects Endress+Hauser field devices with a CDI interface (= Endress+Hauser Common Data Interface) and the USB port of a computer or laptop.</p> <p> Technical Information TI00405C</p>
Adapter connection	<p>Adapter connections for installation on other electrical connections: Adapter FXA291 (order number: 71035809)</p>

### 15.3 Service-specific accessories

Accessories	Description
Applicator	<p>Software for selecting and sizing Endress+Hauser measuring instruments:</p> <ul style="list-style-type: none"> <li>▪ Choice of measuring instruments for industrial requirements</li> <li>▪ Calculation of all the necessary data for identifying the optimum flowmeter: e.g. nominal diameter, pressure loss, flow velocity and measurement accuracy.</li> <li>▪ Graphic display of the calculation results</li> <li>▪ Determination of the partial order code, administration, documentation and access to all project-related data and parameters over the entire life cycle of a project.</li> </ul> <p>Applicator is available: Via the Internet: <a href="https://portal.endress.com/webapp/applicator">https://portal.endress.com/webapp/applicator</a></p>
Commubox FXA291	<p>Connects Endress+Hauser field devices with a CDI interface (= Endress+Hauser Common Data Interface) and the USB port of a computer or laptop.</p> <p> Technical Information TI00405C</p>

## 16 Technical data

### 16.1 Application

The measuring device is intended only for the flow measurement of liquids and gases.

Depending on the version ordered, the measuring device can also measure potentially explosive, flammable, poisonous and oxidizing media.

To ensure that the device remains in proper operating condition for its service life, use the measuring device only for media against which the process-wetted materials are sufficiently resistant.

### 16.2 Function and system design

---

Measuring principle      Mass flow measurement based on the Coriolis measuring principle

---

Measuring system      The device consists of a transmitter and a sensor.  
 For information on the structure of the measuring instrument →  10

### 16.3 Input

---

Measured variable      **Direct measured variables**

- Mass flow
- Density
- Temperature

**Calculated measured variables**

Volume flow



---

Measuring range      *Flow values in SI units*



DN [mm]	Measuring range full scale values $\dot{m}_{\min(F)}$ to $\dot{m}_{\max(F)}$ [kg/h]
1	0 to 20
2	0 to 100
4	0 to 450
8	0 to 2 000
15	0 to 6 500
25	0 to 18 000
40	0 to 45 000

Flow values in US units

DN [in]	Measuring range full scale values $\dot{m}_{\min(F)}$ to $\dot{m}_{\max(F)}$ [lb/min]
1/24	0 to 0.735
1/12	0 to 3.675
1/8	0 to 16.54
3/8	0 to 73.50
1/2	0 to 238.9
1	0 to 661.5
1 1/2	0 to 1 654

 To calculate the measuring range, use the *Applicator* →  49 sizing tool

**Recommended measuring range**

 Flow limit →  58

Operable flow range

Over 1000 : 1.

Flow rates above the preset full scale value do not override the electronics unit, with the result that the totalizer values are registered correctly.

## 16.4 Output

Output signal

**Pulse/frequency/switch output**

<b>Function</b>	Can be set to: <ul style="list-style-type: none"> <li>▪ Pulse Quantity-proportional pulse with pulse width to be configured.</li> <li>▪ Automatic pulse Quantity-proportional pulse with on/off ratio of 1:1</li> <li>▪ Frequency Flow-proportional frequency output with 1:1 on/off ratio</li> <li>▪ Switch Contact for displaying a status</li> </ul>
<b>Version</b>	Option AA: 2 pulse/frequency/switch outputs Passive, high-side
<b>Maximum output values</b>	Option AA: 2 pulse/frequency/switch outputs <ul style="list-style-type: none"> <li>▪ DC 30 V</li> <li>▪ 30 mA</li> </ul>
<b>Voltage drop</b>	Option AA: 2 pulse/frequency/switch outputs At 25 mA: ≤ DC 3 V
<b>Pulse output</b>	
<b>Pulse width</b>	Configurable: 0.05 to 2 000 ms
<b>Maximum pulse rate</b>	10 000 Impulse/s
<b>Pulse value</b>	Configurable
<b>Assignable measured variables</b>	<ul style="list-style-type: none"> <li>▪ Mass flow</li> <li>▪ Volume flow</li> </ul>
<b>Frequency output</b>	
<b>Output frequency</b>	Configurable: 0 to 10 000 Hz

<b>Damping</b>	Configurable: 0 to 999.9 s
<b>Pulse/pause ratio</b>	1:1
<b>Assignable measured variables</b>	<ul style="list-style-type: none"> <li>▪ Mass flow</li> <li>▪ Volume flow</li> <li>▪ Density</li> <li>▪ Temperature</li> <li>▪ Exciter current</li> <li>▪ Oscillation frequency</li> <li>▪ Oscillation amplitude</li> <li>▪ Frequency fluctuation</li> <li>▪ Oscillation damping</li> <li>▪ Fluctuation</li> <li>▪ Signal asymmetry</li> </ul>
<b>Switch output</b>	
<b>Switching behavior</b>	Binary, conductive or non-conductive
<b>Number of switching cycles</b>	Unlimited
<b>Assignable functions</b>	<ul style="list-style-type: none"> <li>▪ Off</li> <li>▪ On</li> <li>▪ Diagnostic behavior                             <ul style="list-style-type: none"> <li>▪ Alarm</li> <li>▪ Alarm and warning</li> <li>▪ Warning</li> </ul> </li> <li>▪ Limit value                             <ul style="list-style-type: none"> <li>▪ Mass flow</li> <li>▪ Volume flow</li> <li>▪ Density</li> <li>▪ Temperature</li> <li>▪ Totalizer 1-3</li> <li>▪ Oscillation damper</li> </ul> </li> <li>▪ Flow direction monitoring</li> <li>▪ Status                             <ul style="list-style-type: none"> <li>▪ Partially filled pipe detection</li> <li>▪ Low flow cut off</li> </ul> </li> </ul>

Signal on alarm

Depending on the interface, failure information is displayed as follows.

**Pulse/frequency/switch output**

<b>Pulse output</b>	
<b>Failure mode</b>	Choose from: <ul style="list-style-type: none"> <li>▪ Actual value</li> <li>▪ No pulses</li> </ul>
<b>Frequency output</b>	
<b>Failure mode</b>	Choose from: <ul style="list-style-type: none"> <li>▪ Actual value</li> <li>▪ 0 Hz</li> <li>▪ Definable value between: 0 to 10 000 Hz</li> </ul>
<b>Switch output</b>	
<b>Failure mode</b>	Choose from: <ul style="list-style-type: none"> <li>▪ Current status</li> <li>▪ Open</li> <li>▪ Closed</li> </ul>

Low flow cut off

The switch points for low flow cut off are user-selectable.

Galvanic isolation      Device version: 2 pulse/frequency/switch outputs  
 (Order code for "Output, input": option AA)  
 ■ Pulse/frequency/switch outputs galvanically isolated from supply potential.  
 ■ Pulse/frequency/switch outputs not galvanically isolated from each other.

## 16.5 Power supply

Terminal assignment      →  26

Supply voltage      DC 24 V (nominal voltage: DC 18 to 30 V)  
 ■ The power unit must be tested to ensure that it meets safety requirements (e.g. PELV/SELV Class II limited energy).  
 ■ The equipment is classified as Class III.

Power consumption      2.5 W (no outputs)

Order code for "Output, input"	Maximum Current consumption
Option AA: 2 pulse/frequency/switch outputs	100 mA

**Switch-on current**  
 Option AA: 2 pulse/frequency/switch outputs  
 Max. 1.2 A (< 15 ms)

Power supply failure      ■ Totalizers stop at the last value measured.  
 ■ Configuration is retained in the device memory.  
 ■ Error messages (incl. total operated hours) are stored.

Electrical connection      →  28



Potential equalization      →  28

Cable specification      →  26

## 16.6 Performance characteristics

Reference operating conditions      ■ Error limits based on ISO 11631  
 ■ Water  
     ■ +15 to +45 °C (+59 to +113 °F)  
     ■ 2 to 6 bar (29 to 87 psi)  
 ■ Data as indicated in the calibration protocol  
 ■ Accuracy based on accredited calibration rigs according to ISO 17025

**Installation**  
 ■ Measuring device is grounded.  
 ■ The sensor is centered in the pipe.

 To obtain measured errors, use the *Applicator* sizing tool →  49

Maximum measurement error o.r. = of reading; 1 g/cm<sup>3</sup> = 1 kg/l; T = medium temperature

**Base accuracy**

Bases for calculation → 56

*Mass flow and volume flow (liquids)*

±0.15 %

*Density (liquids)*

Under reference conditions [g/cm <sup>3</sup> ]	Field density adjustment [g/cm <sup>3</sup> ]	Standard density calibration [g/cm <sup>3</sup> ]
±0.0005 g/cm <sup>3</sup>	±0.0005 g/cm <sup>3</sup>	±0.0025 g/cm <sup>3</sup>

*Temperature*

±0.5 °C ± 0.005 · T °C (±0.9 °F ± 0.003 · (T - 32) °F)

**Zero point stability**

DN		Zero point stability	
[mm]	[in]	[kg/h]	[lb/min]
1	1/24	0.0005	0.000018
2	1/12	0.0025	0.00009
4	1/8	0.0100	0.00036
8	3/8	0.20	0.007
15	1/2	0.65	0.024
25	1	1.80	0.066
40	1 1/2	4.50	0.165

**Flow values**

Flow values as turndown parameters depending on nominal diameter.

*SI units*

DN [mm]	1:1	1:10	1:20	1:50	1:100	1:500
	[kg/h]	[kg/h]	[kg/h]	[kg/h]	[kg/h]	[kg/h]
1	20	2	1	0.4	0.2	0.04
2	100	10	5	2	1	0.2
4	450	45	22.5	9	4.5	0.9
8	2000	200	100	40	20	4
15	6500	650	325	130	65	13
25	18000	1800	900	360	180	36
40	45000	4500	2250	900	450	90

*US units*

DN	1:1	1:10	1:20	1:50	1:100	1:500
[in]	[lb/min]	[lb/min]	[lb/min]	[lb/min]	[lb/min]	[lb/min]
1/24	0.735	0.074	0.037	0.015	0.007	0.001
1/12	3.675	0.368	0.184	0.074	0.037	0.007
1/8	16.54	1.654	0.827	0.331	0.165	0.033
3/8	73.50	7.350	3.675	1.470	0.735	0.147
1/2	238.9	23.89	11.95	4.778	2.389	0.478
1	661.5	66.15	33.08	13.23	6.615	1.323
1 1/2	1654	165.4	82.70	33.08	16.54	3.308

**Accuracy of outputs**

The outputs have the following base accuracy specifications.

*Pulse/frequency output*

o.r. = of reading

<b>Temperature accuracy</b>	Max. ±50 ppm o.r. (over the entire ambient temperature range)
-----------------------------	---

Repeatability

**Base repeatability**

Dosing time [s]	Standard deviation [%]
0.75 s < t <sub>a</sub> < 1.5 s	0.2
1.5 s < t <sub>a</sub> < 3 s	0.1
3 s < t <sub>a</sub>	0.05

**Density (liquids)**

±0.00025 g/cm<sup>3</sup>

**Temperature**

±0.25 °C ± 0.0025 · T °C (±0.45 °F ± 0.0015 · (T-32) °F)

Response time

The response time depends on the configuration (damping).

Influence of ambient temperature

**Pulse/frequency output**

<b>Temperature coefficient</b>	No additional effect. Included in accuracy.
--------------------------------	---

Influence of medium temperature

**Mass flow**

If there is a differential between the temperature during zero adjustment and the process temperature, the typical measurement error of the sensor is ±0.0002 % of the full scale value/°C (±0.0001 % of the full scale value/°F).

**Temperature**

±0.005 · T °C (± 0.005 · (T - 32) °F)

Influence of medium pressure

A difference between the calibration pressure and process pressure does not affect accuracy.

Design fundamentals

o.r. = of reading, o.f.s. = of full scale value

BaseAccu = base accuracy in % o.r., BaseRepeat = base repeatability in % o.r.

MeasValue = measured value; ZeroPoint = zero point stability

Calculation of the maximum measured error as a function of the flow rate

Flow rate	Maximum measured error in % o.r.
$\geq \frac{\text{ZeroPoint}}{\text{BaseAccu}} \cdot 100$ <small>A0021332</small>	$\pm \text{BaseAccu}$ <small>A0021339</small>
$< \frac{\text{ZeroPoint}}{\text{BaseAccu}} \cdot 100$ <small>A0021333</small>	$\pm \frac{\text{ZeroPoint}}{\text{MeasValue}} \cdot 100$ <small>A0021334</small>

Calculation of the maximum repeatability as a function of the flow rate

Flow rate	Maximum repeatability in % o.r.
$\geq \frac{1/2 \cdot \text{ZeroPoint}}{\text{BaseRepeat}} \cdot 100$ <small>A0021335</small>	$\pm \text{BaseRepeat}$ <small>A0021340</small>
$< \frac{1/2 \cdot \text{ZeroPoint}}{\text{BaseRepeat}} \cdot 100$ <small>A0021336</small>	$\pm 1/2 \cdot \frac{\text{ZeroPoint}}{\text{MeasValue}} \cdot 100$ <small>A0021337</small>

Example of maximum measurement error

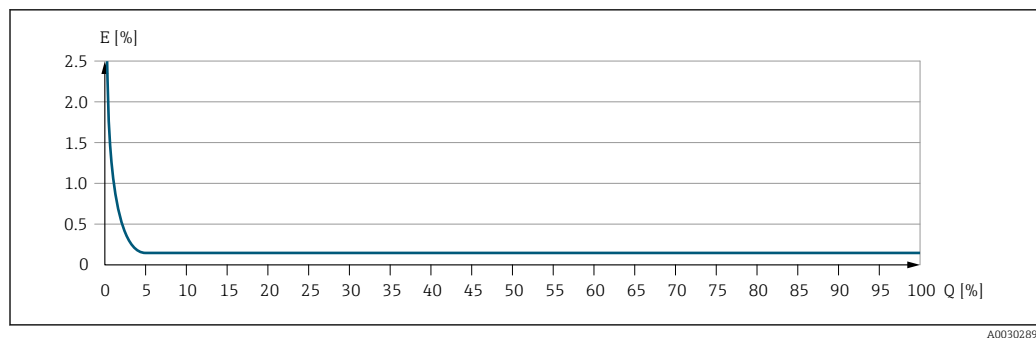

E Maximum measurement error in % o.r. (example)

Q Flow rate in % of maximum full scale value

## 16.7 Mounting

Mounting requirements → 16

## 16.8 Environment

Ambient temperature range → 19

**Temperature tables**

 Observe the interdependencies between the permitted ambient and fluid temperatures when operating the device in hazardous areas.

 For detailed information on the temperature tables, see the separate document entitled "Safety Instructions" (XA) for the device.

---

Storage temperature                    -40 to +80 °C (-40 to +176 °F), preferably at +20 °C (+68 °F)

---

Degree of protection                    Standard: IP67, Type 4X enclosure, suitable for pollution degree 4

---

Relative humidity                        The device is suitable for use in outdoor and indoor areas (damp and wet areas) with a relative humidity of up to 95%.

---

Operating altitude                        According to EN 61010-1  
 ≤ 2 000 m (6 562 ft)

---

Vibration-resistance and shock-resistance                    **Vibration sinusoidal, in accordance with IEC 60068-2-6**

- 2 to 8.4 Hz, 3.5 mm peak
- 8.4 to 2 000 Hz, 1 g peak

**Vibration broad-band random, according to IEC 60068-2-64**

- 10 to 200 Hz, 0.003 g<sup>2</sup>/Hz
- 200 to 2 000 Hz, 0.001 g<sup>2</sup>/Hz
- Total: 1.54 g rms

**Shock half-sine, according to IEC 60068-2-27**

6 ms 30 g

**Rough handling shocks according to IEC 60068-2-31**

---

Electromagnetic compatibility (EMC)                    As per IEC/EN 61326

 Details are provided in the Declaration of Conformity.

 This unit is not intended for use in residential environments and cannot guarantee adequate protection of the radio reception in such environments.

---

Overvoltage protection                    **Overvoltage category**  
 Overvoltage category II, no connection to the mains supply

**16.9 Process**

---

Medium temperature range                    **Sensor**  
 -40 to +130 °C (-40 to +266 °F)

**Cleaning**  
 +150 °C (+302 °F) for a maximum of 60 min for CIP and SIP processes

**Seals**  
 No internal seals

Medium pressure range      Max. 40 bar (580 psi), depending on the process connection

Medium density	DN		P <sub>max</sub> [kg/m <sup>3</sup> ]
	[mm]	[in]	
	1	1/24	3 150
	2	1/12	3 100
	4	1/8	3 100
	8	3/8	4 548
	15	1/2	4 900
	25	1	4 270
	40	1 1/2	4 700



Pressure-temperature ratings       For an overview of the pressure-temperature ratings for the process connections, see the Technical Information

Sensor housing      The sensor housing is filled with dry nitrogen gas and protects the electronics and mechanics inside.



- The housing does not have a pressure rating classification.
- Reference value for the pressure loading capacity of the sensor housing: 16 bar (232 psi)



 For the dimensions and installation lengths of the device, see the "Technical Information" document, "Mechanical construction" section

Flow limit      Select the nominal diameter by optimizing between the required flow range and permissible pressure loss.

 For an overview of the full scale values for the measuring range, see the "Measuring range" section →  50

- The minimum recommended full scale value is approx. 1/20 of the maximum full scale value
- In most applications, 20 to 50 % of the maximum full scale value can be considered ideal
- A low full scale value must be selected for abrasive media (such as liquids with entrained solids): flow velocity < 1 m/s (< 3 ft/s).

 To calculate the flow limit, use the *Applicator* sizing tool →  49

Pressure loss       To calculate the pressure loss, use the *Applicator* sizing tool →  49

Heating      →  20

Vibrations      →  21

## 16.10 Mechanical construction

Design, dimensions



For the dimensions and installation lengths of the device, see the "Technical Information" document, "Mechanical construction" section

Weight

### Weight in SI units

DN [mm]	Weight [kg]
1	3.7
2	5.3
4	7.1
8	3.6
15	3.9
25	4.4
40	6.6

### Weight in US units

DN [in]	Weight [lbs]
1/24	8.2
1/12	11.7
1/8	15.7
3/8	7.9
1/2	8.6
1	9.7
1 1/2	14.6

Materials

### Transmitter housing

- Acid and alkali-resistant outer surface
- Stainless steel, 1.4409 (CF3M)

### Device plug

Electrical connection	Material
M12x1 plug	<ul style="list-style-type: none"> <li>▪ Socket: Polyamide contact support</li> <li>▪ Connector: Contact support made of thermoplastic polyurethane (TPU-GF)</li> <li>▪ Contacts: Gold-plated brass</li> </ul>

### Sensor housing

Acid and alkali-resistant outer surface

**DN 1 to 4 mm (1/24 to 1/8")**

Stainless steel, 1.4404 (316/316L)

**DN 8 to 40 mm (3/8 to 1 1/2")**

Stainless steel 1.4301 (304)

**Measuring tubes**

**DN 1 to 4 mm (1/24 to 1/8")**

Stainless steel, 1.4435 (316/316L)

**DN 8 to 40 mm (3/8 to 1 1/2")**

Stainless steel, 1.4539 (904L)

**Process connections**

**DN 1 to 4 mm (1/24 to 1/8")**



1/2" Tri-Clamp:

Stainless steel, 1.4435 (316L)

**DN 8 to 40 mm (3/8 to 1 1/2")**

All process connections:

Stainless steel, 1.4404 (316/316L)

 Available process connections →  60

**Seals**

Welded process connections without internal seals

**Accessories**

*Sensor holder*

Stainless steel, 1.4404 (316L)

Process connections

**Fixed flange**

- EN 1092-1 (DIN 2501 / DIN 2512N)
- EN 1092-1 (DIN 2501)

**Clamp connections**

1" clamp according to DIN 32676

**Tri-Clamp**

- 1/2" Tri-Clamp
- 1/2" Tri-Clamp BS4825-3
- 3/4" Tri-Clamp
- 1" Tri-Clamp

**Threaded adapter**

- DIN 11864-1 Form A
- DIN 11851
- ISO 2853

 Process connection materials →  60

Surface roughness

All data refer to parts in contact with the medium.

*The following surface roughness categories can be ordered:*

Category	Method	Option(s) order code "Measuring tube mat., wetted surface"
Not polished	–	SA
Ra ≤ 0.76 µm (30 µin) <sup>1)</sup>	Mechanically polished <sup>2)</sup>	BB
Ra ≤ 0.76 µm (30 µin) <sup>1)</sup>	Mechanically polished, welds in as welded condition	SJ

Category	Method	Option(s) order code "Measuring tube mat., wetted surface"
Ra ≤ 0.38 µm (15 µin) <sup>1)</sup>	Mechanically polished <sup>2)</sup>	BF
Ra ≤ 0.38 µm (15 µin) <sup>1)</sup>	Mechanically polished, welds in as welded condition	SK

1) Ra according to ISO 21920

2) Excludes inaccessible weld seams between pipe and manifold

## 16.11 Operability

**Languages** Can be operated in the following languages:  
Via "FieldCare", "DeviceCare" operating tool: English, German, French, Spanish, Italian, Chinese, Japanese

**Local operation** This device cannot be operated locally using a display or operating elements.

**Remote operation** →  30

## 16.12 Certificates and approvals

Current certificates and approvals for the product are available at [www.endress.com](http://www.endress.com) on the relevant product page:



1. Select the product using the filters and search field.
2. Open the product page.
3. Select **Downloads**.

**CE mark** The device meets the legal requirements of the applicable EU Directives. These are listed in the corresponding EU Declaration of Conformity along with the standards applied.  
Endress+Hauser confirms successful testing of the device by affixing to it the CE mark.

**UKCA marking** The device meets the legal requirements of the applicable UK regulations (Statutory Instruments). These are listed in the UKCA Declaration of Conformity along with the designated standards. By selecting the order option for UKCA marking, Endress+Hauser confirms a successful evaluation and testing of the device by affixing the UKCA mark.  
  
Contact address Endress+Hauser UK:  
Endress+Hauser Ltd.  
Floats Road  
Manchester M23 9NF  
United Kingdom  
[www.uk.endress.com](http://www.uk.endress.com)

**RCM marking** The measuring system meets the EMC requirements of the "Australian Communications and Media Authority (ACMA)".

**cULus listed** The device is UL-listed in the product category "Process Control Equipment, Electrical".

Ex-approval	<ul style="list-style-type: none"> <li>■ Only measuring instruments with the order code for "Approval", option "BT", "FC" and "US" have an Ex approval.</li> <li>■ The devices are certified for use in hazardous areas and the relevant safety instructions are provided in the separate "Safety Instructions" (XA) document. Reference is made to this document on the nameplate.</li> </ul>
Hygienic compatibility	<ul style="list-style-type: none"> <li>■ 3-A approval <ul style="list-style-type: none"> <li>■ Only measuring instruments with the order code for "Additional approval", option LP "3A" have 3-A approval.</li> <li>■ The 3-A approval refers to the measuring instrument.</li> <li>■ When installing the measuring instrument, ensure that no liquid can accumulate on the outside of the measuring instrument.</li> <li>■ Accessories (e.g. sensor retainer) must be installed in accordance with the 3-A Standard. Each accessory can be cleaned. Disassembly may be necessary under certain circumstances.</li> </ul> </li> <li>■ EHEDG-tested <sup>2)</sup> Only devices with the order code for "Additional approval", option LT "EHEDG" have been tested and meet the requirements of the EHEDG. To meet the requirements for EHEDG certification, the device must be used with process connections in accordance with the EHEDG position paper entitled "Easy cleanable Pipe couplings and Process connections" (<a href="http://www.ehedg.org">www.ehedg.org</a>). To meet the requirements for EHEDG certification, the device must be installed in a position that ensures drainability.</li> <li>■ Food Contact Materials Regulation (EC) 1935/2004</li> </ul> <p> Observe the special installation instructions →  21</p>
Pharmaceutical compatibility	<ul style="list-style-type: none"> <li>■ FDA 21 CFR 177</li> <li>■ USP &lt;87&gt;</li> <li>■ USP &lt;88&gt; Class VI 121 °C</li> <li>■ TSE/BSE Certificate of Suitability</li> <li>■ cGMP Devices with the order code for "Test, certificate", option JG "Conformity with cGMP-derived requirements, declaration" comply with the requirements of cGMP with regard to the surfaces of parts in contact with the medium, design, FDA 21 CFR material conformity, USP Class VI tests and TSE/BSE conformity. A serial number-specific declaration is generated.</li> </ul>
Pressure Equipment Directive	<ul style="list-style-type: none"> <li>■ With the marking <ol style="list-style-type: none"> <li>a) PED/G1/x (x = category) or</li> <li>b) PESR/G1/x (x = category)</li> </ol> on the sensor nameplate, Endress+Hauser confirms compliance with the "Essential Safety Requirements" <ol style="list-style-type: none"> <li>a) specified in Annex I of the Pressure Equipment Directive 2014/68/EU or</li> <li>b) Schedule 2 of Statutory Instruments 2016 No. 1105.</li> </ol> </li> <li>■ Devices not bearing this marking (without PED or PESR) are designed and manufactured according to sound engineering practice. They meet the requirements of <ol style="list-style-type: none"> <li>a) Art. 4 Para. 3 of the Pressure Equipment Directive 2014/68/EU or</li> <li>b) Part 1, Para. 8 of Statutory Instruments 2016 No. 1105.</li> </ol> The scope of application is indicated <ol style="list-style-type: none"> <li>a) in diagrams 6 to 9 in Annex II of the Pressure Equipment Directive 2014/68/EU or</li> <li>b) Schedule 3, Para. 2 of Statutory Instruments 2016 No. 1105.</li> </ol> </li> </ul>

2) DN 8 to 40 (3/8 to 1 1/2")

External standards and guidelines



- EN 60529  
Degrees of protection provided by enclosure (IP code)
- EN 61010-1  
Safety Requirements for Electrical Equipment for Measurement, Control and Laboratory Use
- GB 30439.5  
Safety requirements for industrial automation products - Part 5: Flowmeter safety requirements
- EN 61326-1/-2-3  
EMC requirements for electrical equipment for measurement, control and laboratory use
- CAN/CSA C22.2 No. 61010-1-12  
Safety Requirements for Electrical Equipment for Measurement, Control and Laboratory Use, Part 1: General Requirements
- ANSI/ISA-61010-1 (82.02.01)  
Safety Requirements for Electrical Equipment for Measurement, Control and Laboratory Use – Part 1: General Requirements

Additional certification

**CRN approval**

Some device versions have CRN approval. A CRN-approved process connection with a CSA approval must be ordered for a CRN-approved device.

### 16.13 Accessories

 Overview of accessories available to order →  49

### 16.14 Documentation

-  For an overview of the scope of the associated Technical Documentation, refer to the following:
  - *Device Viewer* ([www.endress.com/deviceviewer](http://www.endress.com/deviceviewer)): Enter the serial number from the nameplate
  - *Endress+Hauser Operations app*: Enter serial number from nameplate or scan matrix code on nameplate.

Standard documentation

**Brief Operating Instructions**

Measuring instrument	Documentation code
Dosimass	KA01688D

**Description of Device Parameters**

Measuring instrument	Documentation code
Dosimass	GP01219D

**Technical Information**

Measuring instrument	Documentation code
Dosimass	TI01785D

Supplementary device-  
dependent documentation

**Safety instructions**

Contents	Documentation code
ATEX Ex ec	XA03257D
UL Class I, Division 2	XA03263D
UKEX Ex ec	XA03264D

**Installation instructions**

Contents	Note
Installation instructions for spare part sets and accessories	<ul style="list-style-type: none"> <li>▪ Access the overview of all the available spare part sets via <i>Device Viewer</i></li> <li>▪ Accessories available for order with Installation Instructions →  49</li> </ul>

# Index

## 0 ... 9

3-A approval . . . . . 62

## A

Adapting the diagnostic behavior . . . . . 38

Ambient conditions

    Vibration resistance and shock resistance . . . . . 57

Ambient temperature

    Influence . . . . . 55

Ambient temperature range . . . . . 19, 57

Application . . . . . 50

    Resetting the totalizer . . . . . 36

    Totalizer reset . . . . . 36

Approvals . . . . . 61

## C

CE mark . . . . . 9, 61

Certificates . . . . . 61

cGMP . . . . . 62

Checklist

    Post-connection check . . . . . 29

    Post-installation check . . . . . 25

Cleaning

    CIP cleaning . . . . . 46

    Exterior cleaning . . . . . 46

    Internal cleaning . . . . . 46

    SIP cleaning . . . . . 46

Commissioning . . . . . 34

    Configuring the measuring instrument . . . . . 34

Connecting requirements . . . . . 26

Connecting the device

    Device plug . . . . . 28

Connecting the measuring instrument

    Grounding . . . . . 28

Connection

    see Electrical connection

Connection cable . . . . . 26

Current consumption . . . . . 53

## D

Date of manufacture . . . . . 12

Declaration of Conformity . . . . . 9

Degree of protection . . . . . 28, 57

Design

    Measuring instrument . . . . . 10

Design fundamentals

    Measurement error . . . . . 56

    Repeatability . . . . . 56

Device components . . . . . 10

Device description files . . . . . 33

Device locking, status . . . . . 35

Device name

    Sensor . . . . . 12

Device Viewer . . . . . 11

DeviceCare . . . . . 32

    Device description file . . . . . 33

Diagnostic information

    Design, description . . . . . 38

    DeviceCare . . . . . 37

    FieldCare . . . . . 37

    Overview . . . . . 39

    Remedial measures . . . . . 39

Diagnostic list . . . . . 42

Display

    Current diagnostic event . . . . . 41

    Previous diagnostic event . . . . . 41

Display values

    For locking status . . . . . 35

Disposal . . . . . 47

Document

    Function . . . . . 5

    Symbols . . . . . 5

Document function . . . . . 5

Documentation . . . . . 63

Down pipe . . . . . 16

## E

EHEDG-tested . . . . . 62

Electrical connection

    Degree of protection . . . . . 28

    Measuring instrument . . . . . 26

Electromagnetic compatibility . . . . . 57

Endress+Hauser services

    Maintenance . . . . . 46

    Repair . . . . . 47

Environment

    Storage temperature . . . . . 57

Environmental conditions

    Operating altitude . . . . . 57

    Relative humidity . . . . . 57

Error messages

    see Diagnostic messages

Event history . . . . . 42

Event list . . . . . 42

Ex-approval . . . . . 62

Extended order code

    Sensor . . . . . 12

Exterior cleaning . . . . . 46

## F

FDA . . . . . 62

Field of application

    Residual risks . . . . . 9

FieldCare . . . . . 31

    Device description file . . . . . 33

    Establishing a connection . . . . . 31

    Function . . . . . 31

    User interface . . . . . 32

Firmware

    Release date . . . . . 33

    Version . . . . . 33

Firmware history . . . . . 45

- Flow direction . . . . . 17, 24
- Flow limit . . . . . 58
- Food Contact Materials Regulation . . . . . 62
- Functions
  - see Parameters
- G**
- Galvanic isolation . . . . . 53
- H**
- Hygienic compatibility . . . . . 62
- I**
- Identifying the measuring instrument . . . . . 11
- Incoming acceptance . . . . . 11
- Influence
  - Ambient temperature . . . . . 55
  - Medium pressure . . . . . 55
  - Medium temperature . . . . . 55
- Information about this document . . . . . 5
- Inlet runs . . . . . 19
- Input . . . . . 50
- Inspection
  - Connection . . . . . 29
  - Installation . . . . . 25
  - Received goods . . . . . 11
- Installation . . . . . 16
- Installation dimensions . . . . . 19
- Installation point . . . . . 16
- Intended use . . . . . 8
- Internal cleaning . . . . . 46
- L**
- Languages, operation options . . . . . 61
- Local operation . . . . . 61
- Low flow cut off . . . . . 52
- M**
- Maintenance work . . . . . 46
- Materials . . . . . 59
- Maximum measurement error . . . . . 54
- Measured variables
  - see Process variables
- Measurement accuracy . . . . . 53
- Measuring and test equipment . . . . . 46
- Measuring device
  - Conversion . . . . . 47
  - Disposal . . . . . 48
  - Mounting the sensor . . . . . 24
  - Removing . . . . . 47
  - Repair . . . . . 47
  - Switching on . . . . . 34
- Measuring instrument . . . . . 33
  - Configuring . . . . . 34
  - Design . . . . . 10
  - Preparing for mounting . . . . . 24
- Measuring principle . . . . . 50
- Measuring range, recommended . . . . . 58
- Measuring system . . . . . 50
- Medium density . . . . . 58
- Medium pressure
  - Influence . . . . . 55
- Medium temperature
  - Influence . . . . . 55
- Menus
  - For measuring instrument configuration . . . . . 34
- Mounting dimensions
  - see Installation dimensions
- Mounting preparations . . . . . 24
- Mounting requirements
  - Down pipe . . . . . 16
  - Inlet and outlet runs . . . . . 19
  - Installation dimensions . . . . . 19
  - Installation point . . . . . 16
  - Orientation . . . . . 17
  - Sensor heating . . . . . 20
  - Static pressure . . . . . 19
  - Thermal insulation . . . . . 20
  - Vibrations . . . . . 21
- Mounting tool . . . . . 24
- N**
- Nameplate
  - Sensor . . . . . 12
- Netilion . . . . . 46
- O**
- Operable flow range . . . . . 51
- Operating altitude . . . . . 57
- Operation . . . . . 35
- Operation options . . . . . 30
- Operational safety . . . . . 9
- Order code . . . . . 12
- Orientation
  - Filling systems . . . . . 19
- Orientation (vertical, horizontal) . . . . . 17
- Outlet runs . . . . . 19
- Output signal . . . . . 51
- Output variables . . . . . 51
- P**
- Packaging disposal . . . . . 15
- Parameter settings
  - Active diagnostics (Submenu) . . . . . 41
  - Device (Submenu) . . . . . 43
  - Device management (Submenu) . . . . . 35, 43
  - Measured values (Submenu) . . . . . 35
  - Totalizer handling (Submenu) . . . . . 36
  - User management (Submenu) . . . . . 35
- Performance characteristics . . . . . 53
- Pharmaceutical compatibility . . . . . 62
- Pin assignment, device plug . . . . . 26
- Post-connection check . . . . . 34
- Post-connection check (checklist) . . . . . 29
- Post-installation check . . . . . 34
- Post-installation check (checklist) . . . . . 25
- Potential equalization . . . . . 28
- Power consumption . . . . . 53
- Power supply failure . . . . . 53

Pressure Equipment Directive . . . . .	62	Supply voltage . . . . .	27, 53
Pressure loss . . . . .	58	Surface roughness . . . . .	60
Pressure range		System design	
Medium pressure . . . . .	58	Measuring system . . . . .	50
Pressure-temperature ratings . . . . .	58	see Measuring instrument design	
Process connections . . . . .	60	System integration . . . . .	33
Process variables		<b>T</b>	
Calculated . . . . .	50	Technical data, overview . . . . .	50
Measured . . . . .	50	Temperature range	
Product safety . . . . .	9	Medium temperature . . . . .	57
<b>R</b>		Storage temperature . . . . .	15
RCM marking . . . . .	61	Terminal assignment . . . . .	26
Reading measured values . . . . .	35	Thermal insulation . . . . .	20
Recalibration . . . . .	46	Tool	
Reference operating conditions . . . . .	53	Mounting . . . . .	24
Registered trademarks . . . . .	7	Transporting . . . . .	15
Remote operation . . . . .	61	Transporting the measuring instrument . . . . .	15
Repair . . . . .	47	Troubleshooting	
Repeatability . . . . .	55	General . . . . .	37
Replacement		TSE/BSE Certificate of Suitability . . . . .	62
Device components . . . . .	47	<b>U</b>	
Requirements for personnel . . . . .	8	UKCA marking . . . . .	61
Response time . . . . .	55	Use of the measuring instrument	
Return . . . . .	47	Borderline cases . . . . .	8
<b>S</b>		Incorrect use . . . . .	8
Safety . . . . .	8	see Intended use	
Seals		USP Class VI . . . . .	62
Medium temperature range . . . . .	57	<b>V</b>	
Sensor		Vibration resistance and shock resistance . . . . .	57
Installing . . . . .	24	Vibrations . . . . .	21
Medium temperature range . . . . .	57	<b>W</b>	
Sensor heating . . . . .	20	Weight	
Sensor housing . . . . .	58	SI units . . . . .	59
Serial number . . . . .	12	Transport (notes) . . . . .	15
Settings		US units . . . . .	59
Adapting the measuring instrument to the process		Workplace safety . . . . .	9
conditions . . . . .	36		
Device reset . . . . .	43		
Signal on alarm . . . . .	52		
Special mounting instructions			
Hygienic compatibility . . . . .	21		
Standards and guidelines . . . . .	63		
Static pressure . . . . .	19		
Status signals . . . . .	37		
Storage conditions . . . . .	15		
Storage temperature . . . . .	15		
Storage temperature range . . . . .	57		
Submenu			
Active diagnostics . . . . .	41		
Device . . . . .	43		
Device management . . . . .	35, 43		
Event list . . . . .	42		
Measured values . . . . .	35		
Totalizer handling . . . . .	36		
User management . . . . .	35		
Supply unit			
Requirements . . . . .	27		



71770399

[www.addresses.endress.com](http://www.addresses.endress.com)

---