

Operating Instructions

Proline Promag H 10

Electromagnetic flowmeter
HART



Table of contents

1	About this document	6	8	Commissioning	66
	Document function	6		Post-installation check and post-connection check	66
	Related documentation	6		IT security	66
	Symbols	7		Device-specific IT security	66
	Registered trademarks	9		Switching on the device	67
				Commissioning the device	68
2	Safety Instructions	12	9	Operation	72
	Requirements for specialist personnel	12		Reading off the device locking status	72
	Requirements for operating personnel	12		HistoROM data management	72
	Incoming acceptance and transport	12	10	Diagnostics and troubleshooting	74
	Adhesive labels, tags and engravings	12		General troubleshooting	74
	Environment and process	12		Diagnostic information via LED	75
	Occupational safety	12		Diagnostic information on local display	77
	Installation procedure	12		Diagnostic information in FieldCare or DeviceCare	78
	Electrical connection	12		Changing the diagnostic information	79
	Surface temperature	13		Overview of diagnostic information	80
	Commissioning	13		Pending diagnostic events	83
	Modifications to the device	13		Diagnostic list	83
				Event logbook	83
3	Product information	16		Resetting the device	85
	Measuring principle	16	11	Maintenance	88
	Intended use	16		Maintenance tasks	88
	Incoming acceptance	16		Services	88
	Product identification	17	12	Disposal	90
	Transport	19		Removing the device	90
	Checking the storage conditions	21		Disposing of the device	90
	Recycling of packaging materials	21	13	Technical data	92
	Product design	22		Input	92
	Firmware history	24		Output	94
	Device history and compatibility	24		Power supply	98
				Cable specifications	100
4	Installation procedure	26		Performance characteristics	101
	Installation conditions	26		Environment	104
	Installing the device	32		Process	106
	Post-mounting check	37		Mechanical construction	111
				Local display	114
5	Electrical connection	40		Certificates and approvals	115
	Connecting requirements	40		Application packages	118
	Connecting cable connection	41	14	Dimensions in SI units	122
	Transmitter connection	46		Compact version	122
	Removing a cable	49		Remote version	124
	Ensuring potential equalization	49		Sensor flange connection	126
	Hardware settings	51		Flange connections	128
	Post-connection check	52		Clamp connections	131
				Welding nipple	132
6	User operation	54		Couplings	135
	Overview of the operating options	54			
	Local operation	54			
	Operation via SmartBlue app	59			
7	System integration	62			
	Device description files	62			
	Measured variables via HART protocol	62			

Mounting kit	138
Accessories	139
15 Dimensions in US units	144
Compact version	144
Remote version	146
Sensor flange connection	148
Flange connections	150
Clamp connections	150
Welding nipple	151
Couplings	153
Mounting kits	154
Accessories	155
16 Accessories	160
Device-specific accessories	160
Communication-specific accessories	161
Service-specific accessory	161
System components	162
17 Appendix	164
Examples of electric terminals	164

Index

1 About this document

Document function	6
Related documentation	6
Symbols	7
Registered trademarks	9

Document function



These Operating Instructions provide all of the information that is required in various phases of the life cycle of the device:

- Incoming acceptance and product identification
- Storage and transport
- Installation and connection
- Commissioning and operation
- Diagnostics and troubleshooting
- Maintenance and disposal

Related documentation

Technical information	Overview of the device with the most important technical data.
Operating instructions	All the information that is required in the various phases of the life cycle of the device: from product identification, incoming acceptance and storage, to mounting, connection, operation and commissioning through to troubleshooting, maintenance and disposal as well as the technical data and dimensions.
Sensor Brief Operating Instructions	Incoming acceptance, transport, storage and mounting of the device.
Transmitter Brief Operating Instructions	Electrical connection and commissioning of the device.
Description of Parameters	Detailed explanation of the menus and parameters.
Safety Instructions	Documents for the use of the device in hazardous areas.
Special Documentation	Documents with more detailed information on specific topics.
Installation Instructions	Installation of spare parts and accessories.

The related documentation is available online:

Device Viewer	On the www.endress.com/deviceviewer website, enter the serial number of the device: nameplate → <i>Product identification</i> ,  17
Endress+Hauser Operations App	<ul style="list-style-type: none"> ▶ Scan the Data Matrix code: nameplate → <i>Product identification</i>,  17 ▶ Enter the serial number of the device: nameplate → <i>Product identification</i>,  17

Symbols

Warnings

DANGER

This symbol alerts you to an immediate dangerous situation. Failure to avoid the situation will result in a fatal or serious injury.

WARNING

This symbol alerts you to a potentially dangerous situation. Failure to avoid the situation may result in a fatal or serious injury.





CAUTION

This symbol alerts you to a potentially dangerous situation. Failure to avoid the situation may result in a minor or mild injury.





NOTICE

This symbol alerts you to a potentially harmful situation. Failure to avoid the situation may result in damage to the facility or to something in the facility's vicinity.



Electronics

-  Direct current
-  Alternating current
-  Direct current and alternating current
-  Terminal connection for potential equalization







Device communication







-  Communication via a wireless, local area network.
-  Bluetooth is enabled.
-  LED is off.
-  LED flashing.
-  LED lit.

Tools



-  Flat-blade screwdriver
-  Hexagon wrench
-  Wrench

Types of information

-  Preferred procedures, processes or actions
-  Permitted procedures, processes or actions
-  Forbidden procedures, processes or actions
-  Additional information
-  Reference to documentation
-  Reference to page
-  Reference to graphic

-  Measure or individual action to be observed
-  Series of steps
-  Result of an individual step
-  Help in the event of a problem
-  Visual inspection
-  Write-protected parameter

Explosion protection

-  Hazardous area
-  Non-hazardous area

Registered trademarks

HART®

Registered trademark of the FieldComm Group, Austin, Texas USA

Bluetooth®

The Bluetooth word mark and Bluetooth logos are registered trademarks of Bluetooth SIG. Inc. and any use of such marks by Endress+Hauser is under license. Other trademarks and trade names are those of their respective owners.

Apple®

Apple, the Apple logo, iPhone, and iPod touch are trademarks of Apple Inc., registered in the U.S. and other countries. App Store is a service mark of Apple Inc.

Android®

Android, Google Play and the Google Play logo are trademarks of Google Inc.

2 Safety Instructions

Requirements for specialist personnel	12
Requirements for operating personnel	12
Incoming acceptance and transport	12
Adhesive labels, tags and engravings	12
Environment and process	12
Occupational safety	12
Installation procedure	12
Electrical connection	12
Surface temperature	13
Commissioning	13
Modifications to the device	13

Requirements for specialist personnel

- ▶ Installation, electrical connection, commissioning, diagnostics and maintenance of the device must only be carried out by trained, specialist personnel authorized by the facility's owner-operator.
- ▶ Before commencing work, the trained, specialist personnel must carefully read, understand and adhere to the Operating Instructions, additional documentation and certificates.
- ▶ Comply with national regulations.

Requirements for operating personnel

- ▶ Operating personnel are authorized by the facility's owner-operator and are instructed according to the requirements of the task.
- ▶ Before commencing work, the operating personnel must carefully read, understand and adhere to the instructions provided in the Operating Instructions and additional documentation.

Incoming acceptance and transport

- ▶ Transport the device in a correct and appropriate manner.
- ▶ Do not remove protective covers or protective caps on the process connections.

Adhesive labels, tags and engravings

- ▶ Pay attention to all the safety instructions and symbols on the device.

Environment and process

- ▶ Only use the device for the measurement of appropriate media.
- ▶ Keep within the device-specific pressure range and temperature range.
- ▶ Protect the device from corrosion and the influence of environmental factors.

Occupational safety

- ▶ Wear the required protective equipment according to national regulations.
- ▶ Do not ground the welding unit via the device.
- ▶ Wear protective gloves if working on and with the device with wet hands.

Installation procedure

- ▶ Do not remove protective covers or protective caps on the process connections until just before you install the sensor.
- ▶ Do not damage or remove the liner on the flange.
- ▶ Observe tightening torques.

Electrical connection

- ▶ Comply with national installation regulations and guidelines.
- ▶ Observe cable specifications and device specifications.
- ▶ Check the cable for damage.

- ▶ If using the device in hazardous areas, observe the "Safety Instructions" documentation.
- ▶ Provide (establish) potential equalization.
- ▶ Provide (establish) grounding.

Surface temperature

Media with elevated temperatures can cause the surfaces of the device to become hot. For this reason, note the following:

- ▶ Mount suitable touch protection.
- ▶ Wear suitable protective gloves.

Commissioning

- ▶ Install the device only if it is in proper technical condition, free from errors and faults.
- ▶ Only put the device into operation once you have performed the post-installation check and post-connection check.

Modifications to the device

Modifications or repairs are not permitted and can pose a danger. For this reason, note the following:

- ▶ Only carry out modifications or repairs after consulting beforehand with an Endress+Hauser service organization.
- ▶ Only use original spare parts and original accessories from Endress+Hauser.
- ▶ Install original spare parts and original accessories according to the Installation Instructions.

3 Product information

Measuring principle	16
Intended use	16
Incoming acceptance	16
Product identification	17
Transport	19
Checking the storage conditions	21
Recycling of packaging materials	21
Product design	22
Firmware history	24
Device history and compatibility	24

Measuring principle

Electromagnetic flow measurement on the basis of *Faraday's law of magnetic induction*.

Intended use

The device is only suitable for flow measurement of liquids with a minimum conductivity of 5 $\mu\text{S}/\text{cm}$.

Depending on the version ordered, the device measures potentially explosive, flammable, poisonous and oxidizing media.

Devices for use in a hazardous area, in hygienic applications, or where there is an increased risk due to pressure, are labeled accordingly on the nameplate.

Non-designated use can compromise safety. The manufacturer is not liable for damage caused by improper or non-intended use.

Incoming acceptance

Is technical documentation provided with the device?	<input type="checkbox"/>
Does the scope of supply match the specifications on the delivery note?	<input type="checkbox"/>
Is the order code on the delivery note and nameplate identical?	<input type="checkbox"/>
Does the device bear any signs of damage from transportation?	<input type="checkbox"/>
Has an incorrect device been ordered or delivered or has the device been damaged in transit? Complaints or returns: https://www.endress.com/support/return-material	<input type="checkbox"/>

Product identification

Device designation

The device comprises the following parts:

- Proline 10 transmitter
- Promag H sensor

Transmitter nameplate

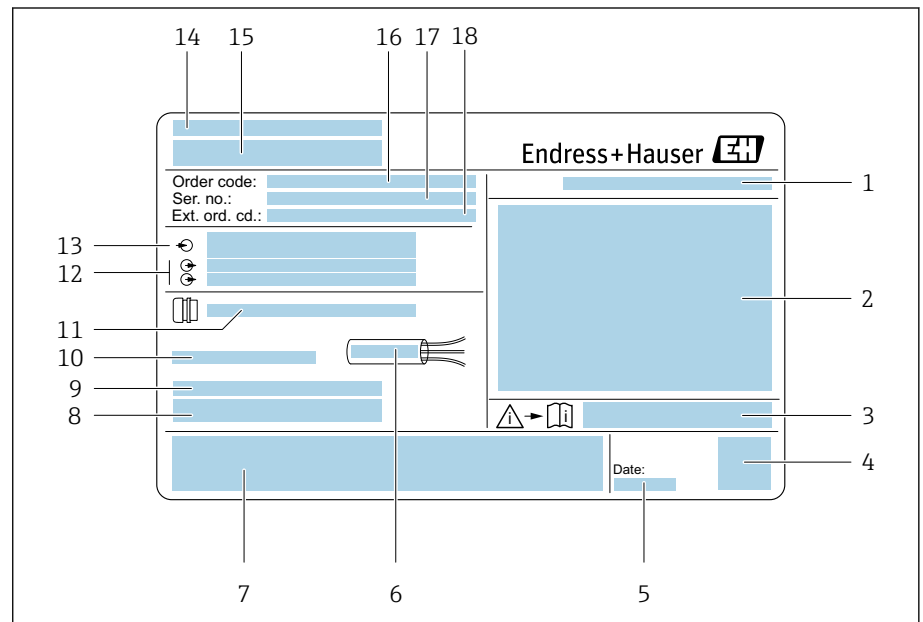

A0042943

1 Example of a transmitter nameplate

- 1 Degree of protection
- 2 Approvals for hazardous area, electrical connection data
- 3 Document number of safety-related supplementary documentation
- 4 Data Matrix code
- 5 Date of manufacture: year-month
- 6 Permitted temperature range for cable
- 7 CE mark and other approval marks
- 8 Firmware version (FW), device revision (Dev.Rev.) from the factory
- 9 Additional information in the case of special products
- 10 Permitted ambient temperature (T_a)
- 11 Information on the cable entry
- 12 Available inputs and outputs: supply voltage
- 13 Electrical connection data: supply voltage and supply power
- 14 Place of manufacture
- 15 Transmitter name
- 16 Order code
- 17 Serial number
- 18 Extended order code

Sensor nameplate

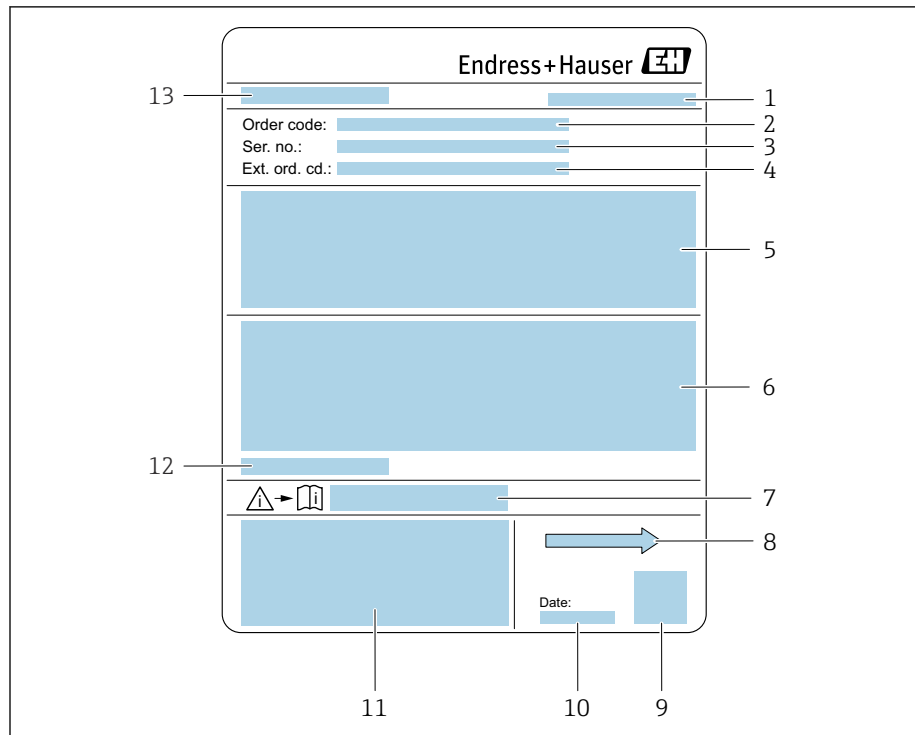

A0043041

2 Example of sensor nameplate

- 1 Place of manufacture
- 2 Order code
- 3 Serial number
- 4 Extended order code
- 5 Approvals, certificates and degree of protection
- 6 Technical data
- 7 Document number of safety-related supplementary documentation
- 8 Flow direction
- 9 Data Matrix code
- 10 Date of manufacture: year-month
- 11 CE mark, C-Tick
- 12 Permitted ambient temperature (T_a)
- 13 Sensor name

Transport

Protective packaging

Protective covers or protective caps are fitted on the process connections to protect against damage and dirt.

Transporting in the original packaging

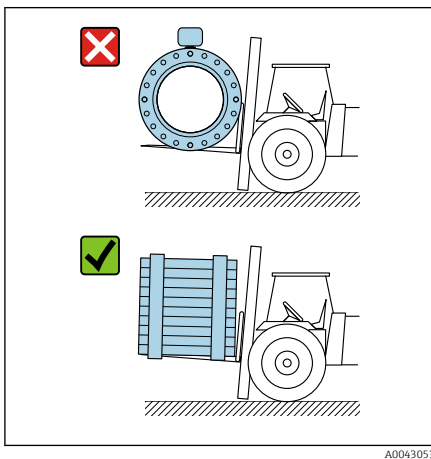

A0043053

NOTICE

Original packaging is missing!

Damage to the magnetic coil.

- ▶ Only lift and transport the device in the original packaging.

Transporting with lifting lugs

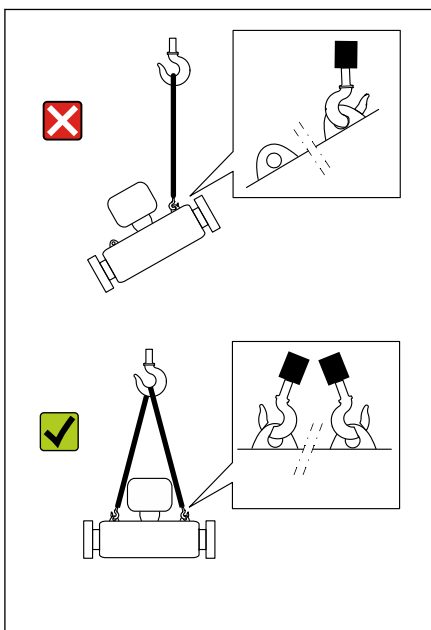

A0043058

⚠ DANGER

Potentially life-threatening hazard from suspended loads!

The device could fall.

- ▶ Secure the device against slipping and turning.
- ▶ Do not move suspended loads over people.
- ▶ Do not move suspended loads over unprotected areas.

NOTICE

Lifting equipment incorrectly attached!

Lifting equipment attached on one side only can damage the device.

- ▶ Attach lifting equipment to both lifting lugs.

Transporting without lifting lugs

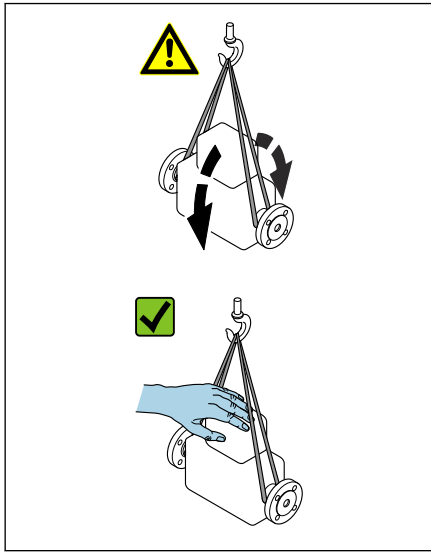

A0043054

⚠ DANGER

Potentially life-threatening hazard from suspended loads!

The device could fall.

- ▶ Secure the device against slipping and turning.
- ▶ Do not move suspended loads over people.
- ▶ Do not move suspended loads over unprotected areas.

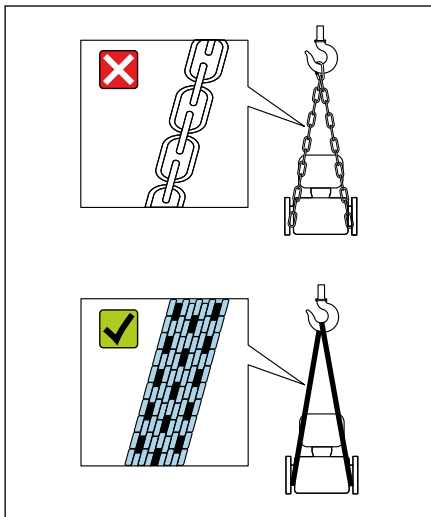

A0043055

NOTICE

Incorrect lifting equipment can damage the device!

The use of chains as hoists can damage the device.

- ▶ Use textile hoists.

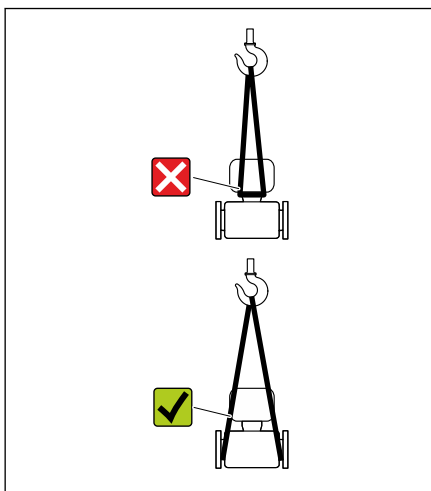

A0043056

NOTICE

Lifting equipment incorrectly attached!

Lifting equipment attached to unsuitable points can damage the device.

- ▶ Attach lifting equipment to both process connections of the device.

Checking the storage conditions

Are the protective covers or protection caps on the process connections?	<input type="checkbox"/>
Is the device in the original packaging?	<input type="checkbox"/>
Is the device protected against sunlight?	<input type="checkbox"/>
Is it guaranteed that the device is not stored outdoors?	<input type="checkbox"/>
Is the device stored in a dry and dust-free place?	<input type="checkbox"/>
Does the storage temperature match the device ambient temperature specified on the nameplate?	<input type="checkbox"/>
Is the possibility of moisture/condensation collecting on the device and original packaging as a result of variations in temperature ruled out?	<input type="checkbox"/>

Recycling of packaging materials

All packaging materials and packaging aids must be recycled as specified by national regulations.

- Stretch wrap: polymer in accordance with EU Directive 2002/95/EC (RoHS)
- Crate: wood in accordance with ISPM 15 standard, confirmed by IPPC logo
- Cardboard box: in accordance with European Packaging Directive 94/62/EC, confirmed by Resy symbol
- Disposable pallet: plastic or wood
- Packaging straps: plastic
- Adhesive strips: plastic
- Padding: paper

Product design

Compact version

The transmitter and sensor form a mechanical unit.

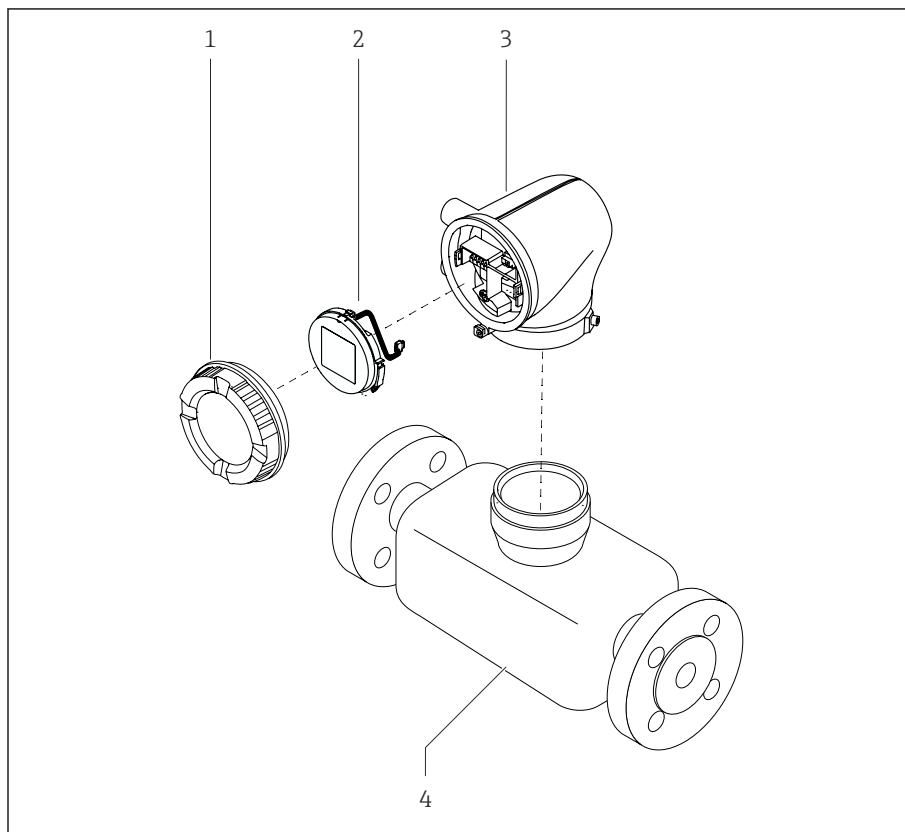

3 Main device components

- 1 Housing cover
- 2 Display module
- 3 Transmitter housing
- 4 Sensor

Remote version

The transmitter and sensor are installed in physically separate locations.

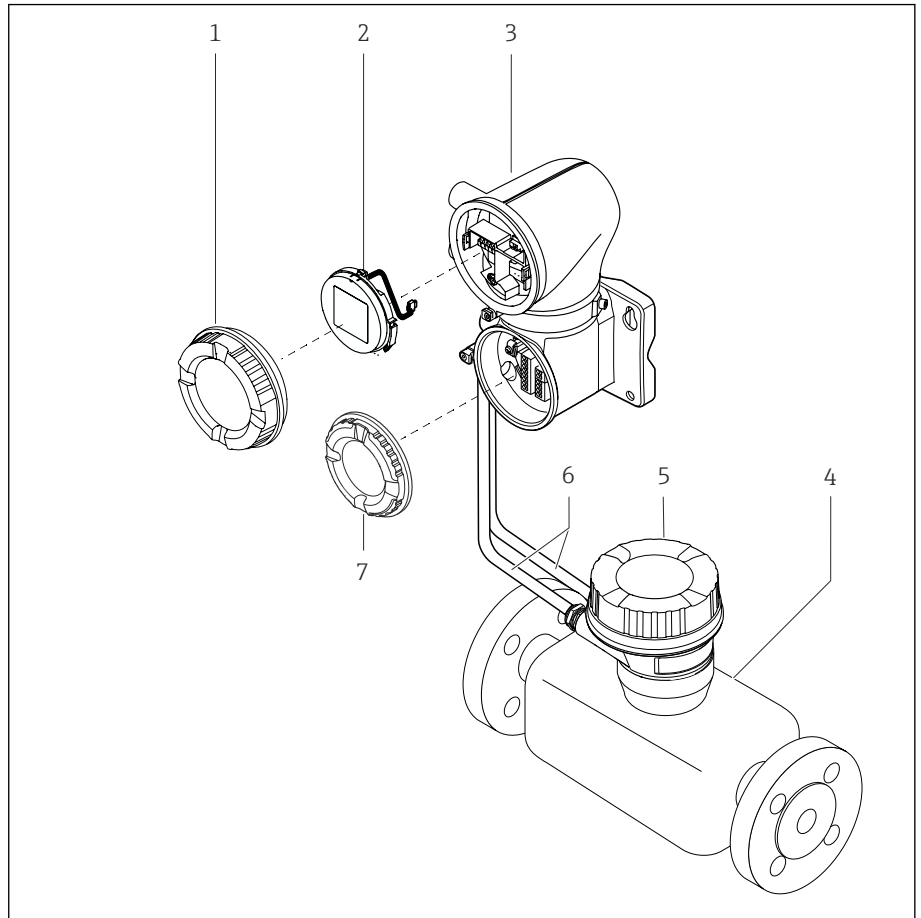

A0043524

4 Main device components

- 1 Housing cover
- 2 Display module
- 3 Transmitter housing
- 4 Sensor
- 5 Sensor connection housing
- 6 Connecting cable consisting of coil current cable and electrode cable
- 7 Connection compartment cover

Firmware history

List of firmware versions and changes since previous version

Firmware version 01.00.zz

Release date	2021-07-01	Original firmware
Version of the Operating Instructions	01.21	
Order code for "Firmware version"	Option 78	

Device history and compatibility

List of device models and changes since previous model

Device model A1

Release	2021-07-01	-
Version of the Operating Instructions	01.21	
Compatibility with previous model	-	

4 Installation procedure

Installation conditions	26
Installing the device	32
Post-mounting check	37

Installation conditions

Flow direction

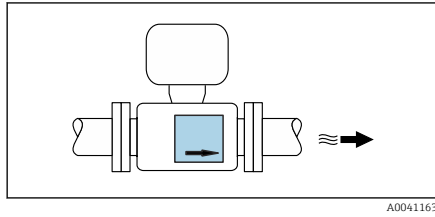

Install the device in the direction of flow.

i Note the direction of arrow on the nameplate.

Installation with inlet runs and outlet runs

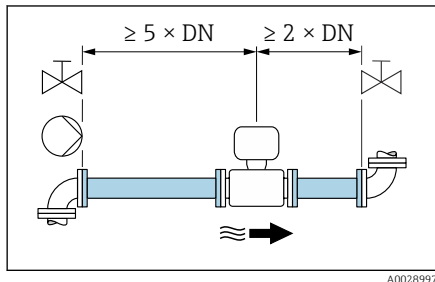

Ensure straight, undisturbed inlet and outlet runs.

i To avoid negative pressure and to comply with accuracy specifications, install the sensor upstream from assemblies that produce turbulence (e.g. valves, T-sections) and downstream from pumps → *Installation near pumps*, 30.

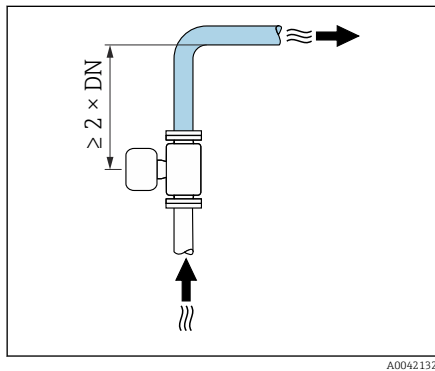

Keep a sufficient distance to the next pipe elbow.

Installation without inlet runs and outlet runs

Depending on the device design and installation location, the inlet and outlet runs can be reduced or omitted entirely.

i **Maximum measurement error**
When the device is installed with the inlet and outlet runs described, a maximum measurement error of $\pm 0.5\%$ of the reading ± 1 mm/s (0.04 in/s) can be guaranteed.

Devices and possible order options

Order code for "Electrodes"		
Option	Description	Design
J	1.4435/316L, pointed for 0 x DN inlet/outlet runs	0 x DN full-bore design ¹⁾
L	1.4435/316L for 0 x DN inlet/outlet runs	
M	Alloy C22 for 0 x DN inlet/outlet runs	

1) "Full-bore" indicates a measuring tube cross-section corresponding to the nominal diameter without constriction. This means there is no pressure loss.

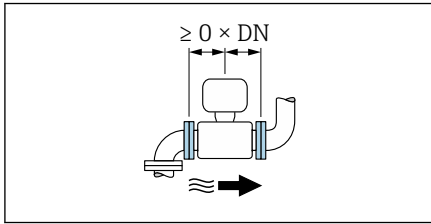

Installation before or after bends
Installation without inlet and outlet runs is possible.

A0032859

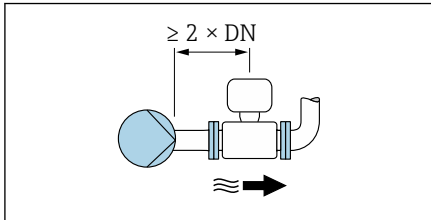

Installation downstream of pumps
Installation without inlet and outlet runs is possible.

i An inlet run of $\geq 2 \times DN$ is recommended.

A0045530

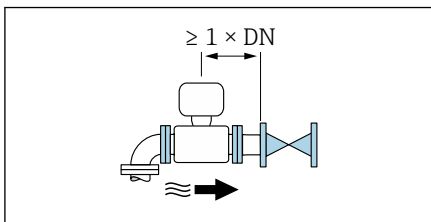

Installation upstream of valves
Installation without inlet and outlet runs is possible.

i An outlet run of $\geq 1 \times DN$ is recommended.

A0045531

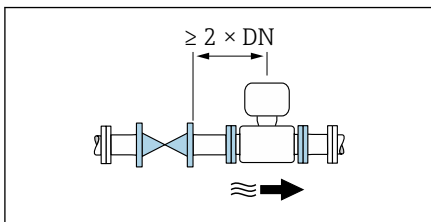

Installation downstream of valves
The device can be installed without inlet and outlet runs if the valve is 100% open during operation.

i An inlet run of $\geq 2 \times DN$ is recommended if the valve is 100% open during operation.

A0045786

Orientations

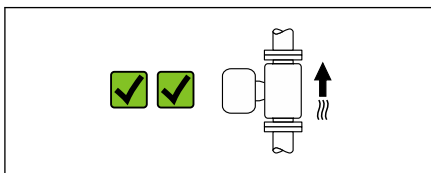

Vertical orientation, upward direction of flow
For all applications.

A0041159

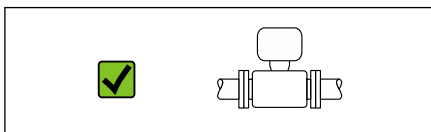

Horizontal orientation, transmitter at top

This orientation is suitable for the following applications:

- For medium and low process temperatures, in order to maintain the minimum ambient temperature for the transmitter.
- For empty pipe detection, even in the case of empty or partially filled measuring pipes.

A0041160

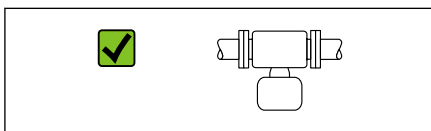

Horizontal orientation, transmitter at bottom

This orientation is suitable for the following applications:

- For medium and high process temperatures, in order to maintain the maximum ambient temperature for the transmitter.
- To prevent the electronics module from overheating in the case of a sharp rise in temperature, install the measuring instrument with the transmitter component pointing downwards.

A0041161

This orientation is not suitable for the following applications:
If empty pipe detection is to be used.

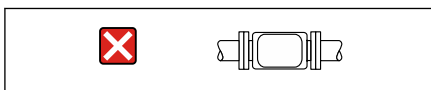

Horizontal orientation, transmitter at side

This orientation is not suitable

A0041162

Vertical

Optimum for self-emptying pipe systems and for use in conjunction with empty pipe detection.

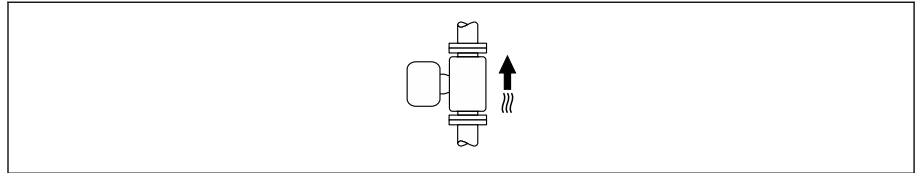

A0015591

Horizontal

- Ideally, the measuring electrode plane should be horizontal. This prevents brief insulation of the measuring electrodes by entrained air bubbles.
- Empty pipe detection only works if the transmitter housing is pointing upwards as otherwise there is no guarantee that the empty pipe detection function will actually respond to a partially filled or empty measuring tube.

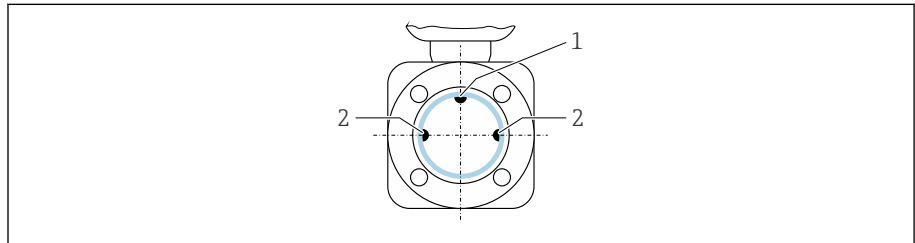

A0028998

- 1 EPD electrode for empty pipe detection, available from \geq DN 15 ($\frac{1}{2}$ ")
- 2 Measuring electrodes for signal detection

i Measuring instruments with a nominal diameter $<$ DN 15 ($\frac{1}{2}$ ") do not have an EPD electrode. In this case, empty pipe detection is performed via the measuring electrodes.

Mounting locations

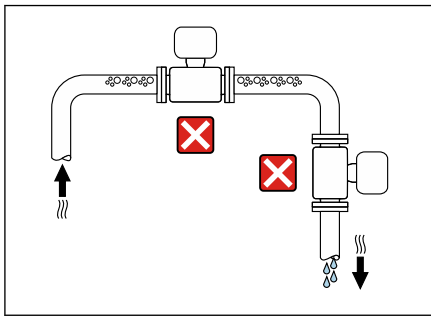

- Do not install the device at the highest point of the pipe.
- Do not install the device upstream from a free pipe outlet in a down pipe.

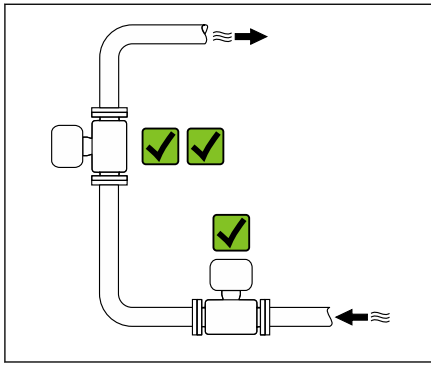

The device should ideally be installed in an ascending pipe.

Installation near control valves

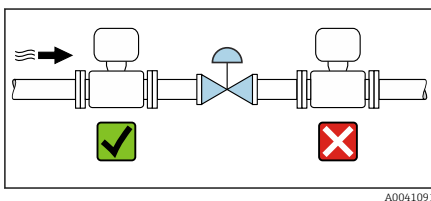

Install the device in the direction of flow upstream from the control valve.

Installation upstream from a down pipe

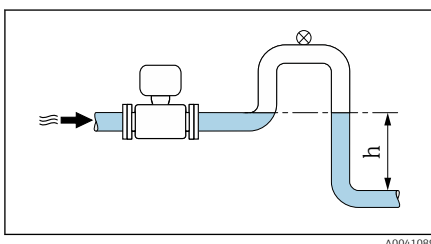

NOTICE

Negative pressure in the measuring pipe can damage the liner!

- ▶ If installing upstream from down pipes with a length $h \geq 5 \text{ m}$ (16.4 ft): install a siphon with a vent valve downstream from the device.

i This arrangement prevents the flow of liquid stopping in the pipe and air entrainment.

Installation with partially filled pipes

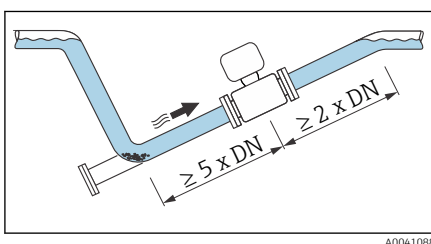

- Partially filled pipes with a gradient require a drain-type configuration.
- The installation of a cleaning valve is recommended.

Installation near pumps

NOTICE

A vacuum in the measuring tube can damage the liner!

- ▶ Install the device in the direction of flow downstream from the pump.
- ▶ Install pulsation dampers if reciprocating, diaphragm or peristaltic pumps are used.

i Information on the measuring system's resistance to vibration and shock
→ *Vibration resistance and shock resistance*, 104

Pipe vibrations

A remote version is recommended in the event of strong pipe vibrations.

NOTICE

Pipe vibrations can damage the device!

- ▶ Do not expose the device to strong vibrations.
- ▶ Support the pipe and fix it in place.
- ▶ Support the device and fix it in place.
- ▶ Mount the sensor and transmitter separately.

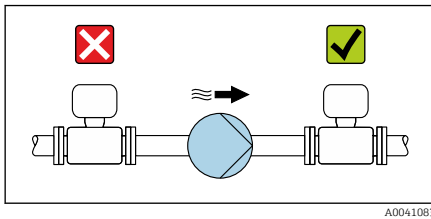

A0041083

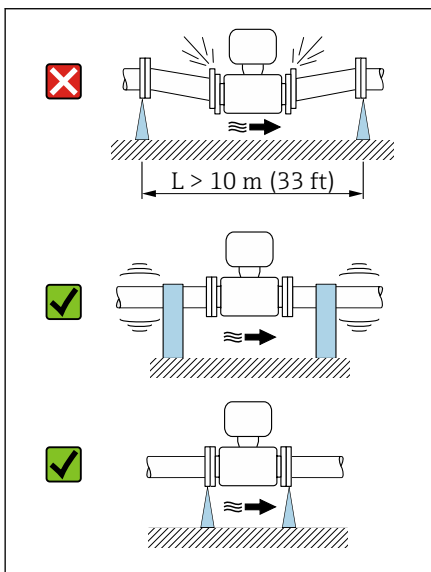

A0041092

Adapters

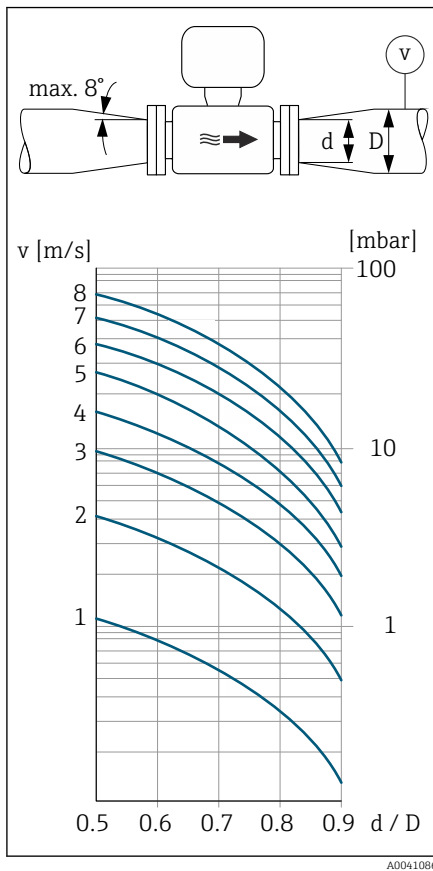

Suitable adapters (double-flange reducers) can be used to install the sensor in larger-diameter pipes. The resulting higher rate of flow improves measuring accuracy with very slow-moving media.

- i** The nomogram shown here can be used to calculate the pressure loss caused by reducers and expanders. It only applies to liquids with a viscosity similar to that of water.
- If the medium has a high viscosity, a larger measuring tube diameter can be considered in order to reduce pressure loss.

1. Calculate the ratio of the diameters d/D .
2. Determine the flow velocity after the reduction.
3. From the chart, determine the pressure loss as a function of the flow velocity v and the d/D ratio.

Seals

Note the following when installing seals:
For plastic flanges: seals are **always** required.

Magnetism and static electricity

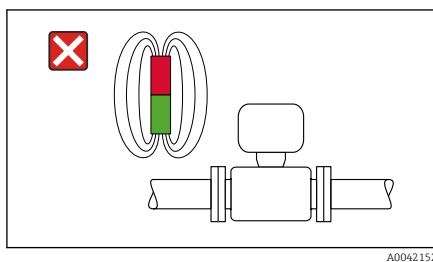

Do not install the device near magnetic fields, e.g. Engines, transformers.

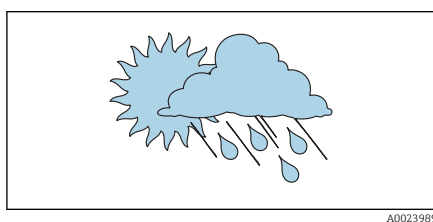

Outdoor use

- Avoid exposure to direct sunlight.
- Install in a location protected from sunlight.
- Avoid direct exposure to weather conditions.
- Use a weather protection cover → *Transmitter*, 160.

Installing the device

Preparing the device

1. Remove the entire transportation packaging.
2. Remove protective covers or protective caps on the device.

Installing seals

⚠ WARNING

Improper process sealing can put staff at risk!

- ▶ Check whether the seals are clean and undamaged.

NOTICE

Incorrect installation can lead to incorrect measurement results!

- ▶ The internal diameter of the seal must be greater than or equal to that of the process connection and pipe.
- ▶ Fit the seals and measuring pipe centrally.
- ▶ Make sure that the seals do not protrude into the pipe cross-section.

In the case of metal process connections, tighten the screws. The process connection forms a metal connection with the sensor, which ensures a defined compression of the seal.

Installing the grounding rings

- In the case of plastic pipes or pipes with an insulating liner, grounding is via grounding rings.
- Observe the information for the use of grounding rings → *Ensuring potential equalization*, ☰ 49.
- Grounding rings can be ordered separately from Endress+Hauser → *Device-specific accessories*, ☰ 160.

Installing the sensor

1. Install the sensor between the pipe flanges.
2. In the case of plastic process connections, observe the maximum screw tightening torque for lubricated threads: 7 Nm (5.2 lbf ft).
3. Install the device or turn the transmitter housing in such a way that the cable entries point down or to the side.

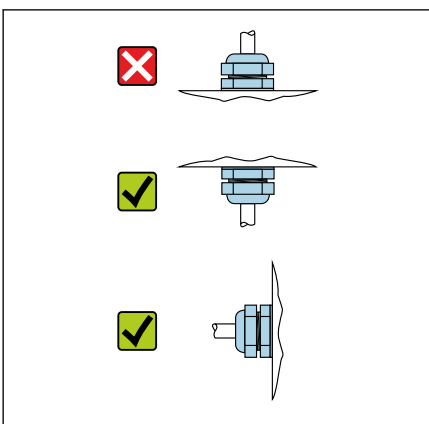

A0044192

Welding in the sensor

⚠ WARNING

Incorrect grounding of the welding device damages the electronics!

- ▶ Do not ground the welding unit via the device.

1. Tack-weld the sensor to secure it in the pipe. A suitable welding jig can be ordered separately as an accessory → *Sensor*, ☰ 160.
2. Loosen the hexagonal-headed bolts.
3. Open the pipe at least 8 mm (0.31 in) to remove the sensor and seal.
4. Remove the process connection from the sensor, along with the seal, from the pipe.
5. If thin-walled pipes carrying food are welded correctly:
Remove the sensor and seal.
6. Weld the process connection into the pipe.

⚠ WARNING

Improper process sealing can put staff at risk!

- ▶ Check whether the seals are clean and undamaged.
- ▶ Install the sensor between the two pipe flanges.

Mounting the transmitter on a post

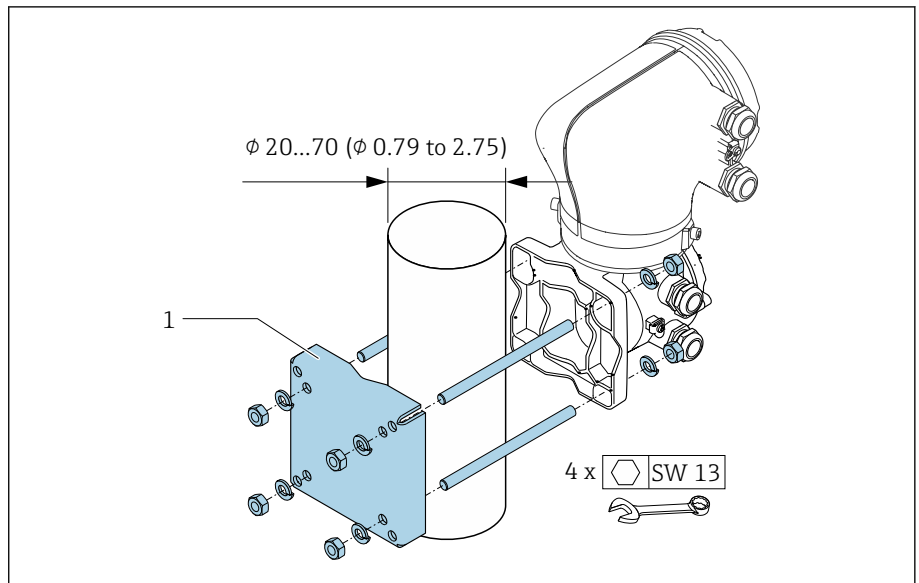

6 Unit mm (in)

A0043471

NOTICE

Ambient temperature too high!

If the electronics overheat this can damage the transmitter housing.

- ▶ Do not exceed the permissible temperature range for the ambient temperature.
- ▶ Use a weather protection cover → *Transmitter*, 160.
- ▶ Mount the device correctly.

Turning the transmitter housing

Order code for "Housing", option
"Aluminum"

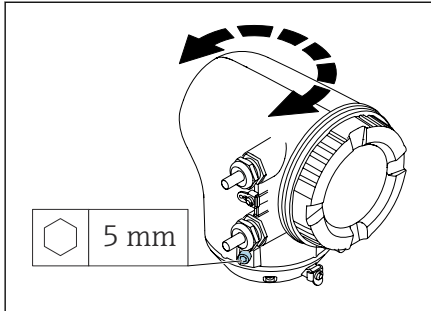

Order code for "Housing", option
"Polycarbonate"

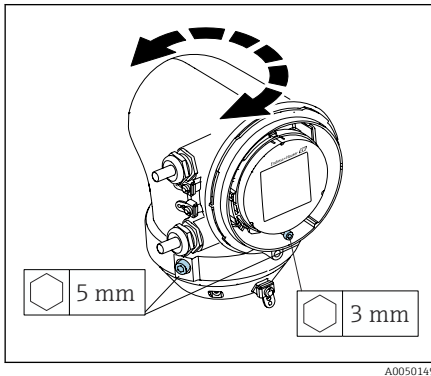

1. Loosen the fixing screws on both sides of the transmitter housing.

2. **NOTICE**

Overrotation of the transmitter housing!

Interior cables are damaged.

- ▶ Turn the transmitter housing a maximum of 180° in each direction.

Turn the transmitter housing to the desired position.

3. Tighten the screws in the logically reverse sequence.

1. Loosen the screw on the housing cover.

2. Open the housing cover.

3. Loosen the grounding screw (below the display).

4. Loosen the fixing screws on both sides of the transmitter housing.

5. **NOTICE**

Overrotation of the transmitter housing!

Interior cables are damaged.

- ▶ Turn the transmitter housing a maximum of 180° in each direction.

Turn the transmitter housing to the desired position.

6. Tighten the screws in the logically reverse sequence.

Post-mounting check

Is the device undamaged (visual check)?	<input type="checkbox"/>
Does the device conform to the measuring point specifications? For example:	
<ul style="list-style-type: none"> ▪ Process temperature ▪ Process pressure ▪ Ambient temperature ▪ Measuring range 	<input type="checkbox"/>
Has the correct orientation been selected for the device?	<input type="checkbox"/>
Does the direction of the arrow on the device match the flow direction of the medium?	<input type="checkbox"/>
Is the device protected against precipitation and sunlight?	<input type="checkbox"/>
Are the screws tightened with the correct tightening torque?	<input type="checkbox"/>
Was cleaning performed in accordance with the specified cleaning specifications prior to commissioning? → <i>Cleaning</i> ,  88?	<input type="checkbox"/>

5 Electrical connection

Connecting requirements	40
Connecting cable connection	41
Transmitter connection	46
Removing a cable	49
Ensuring potential equalization	49
Hardware settings	51
Post-connection check	52

Connecting requirements

Notes on the electrical connection

WARNING

Live parts!

Incorrect work performed on the electrical connections can result in an electric shock.

- ▶ Have electrical connection work carried out by appropriately trained specialists only.
- ▶ Comply with applicable federal/national installation codes and regulations.
- ▶ Comply with national and local workplace safety regulations.
- ▶ Establish the connections in the correct order: always make sure to first connect the protective earth (PE) to the inner ground terminal.
- ▶ When using in hazardous areas, observe the "Safety Instructions" document.
- ▶ Ground the device carefully and provide potential equalization.
- ▶ Connect protective earthing to all outer ground terminals.

Additional protective measures

The following protective measures are required:

- Set up a disconnecting device (switch or power-circuit breaker) to easily disconnect the device from the supply voltage.
- In addition to the device fuse, include an overcurrent protection unit, with max. 10 A, in the facility installation.
- Plastic sealing plugs act as safeguards during transportation and must be replaced by suitable, individually approved installation material.
- Connection examples: → *Examples of electric terminals*,  164

Connecting cable connection

Preparing the connecting cable

Transmitter

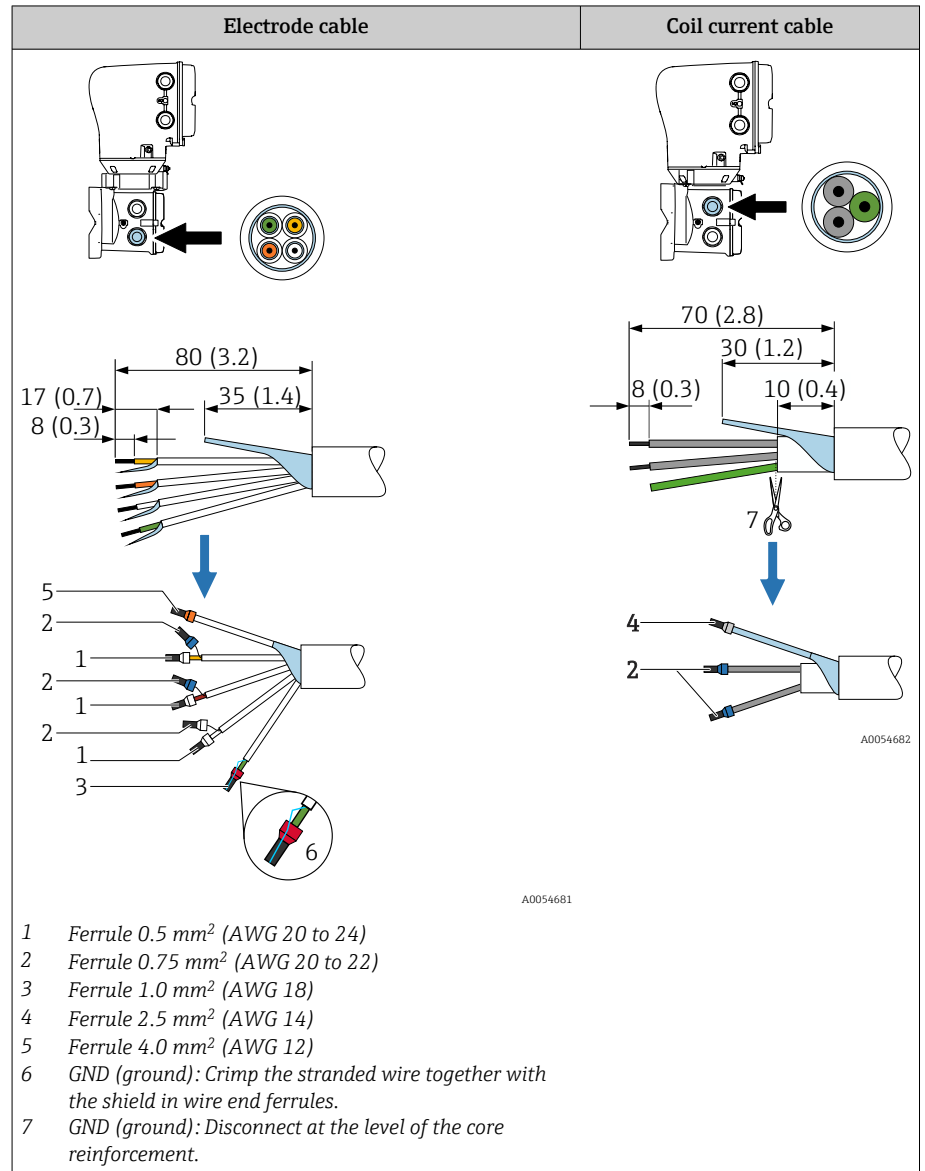

Sensor

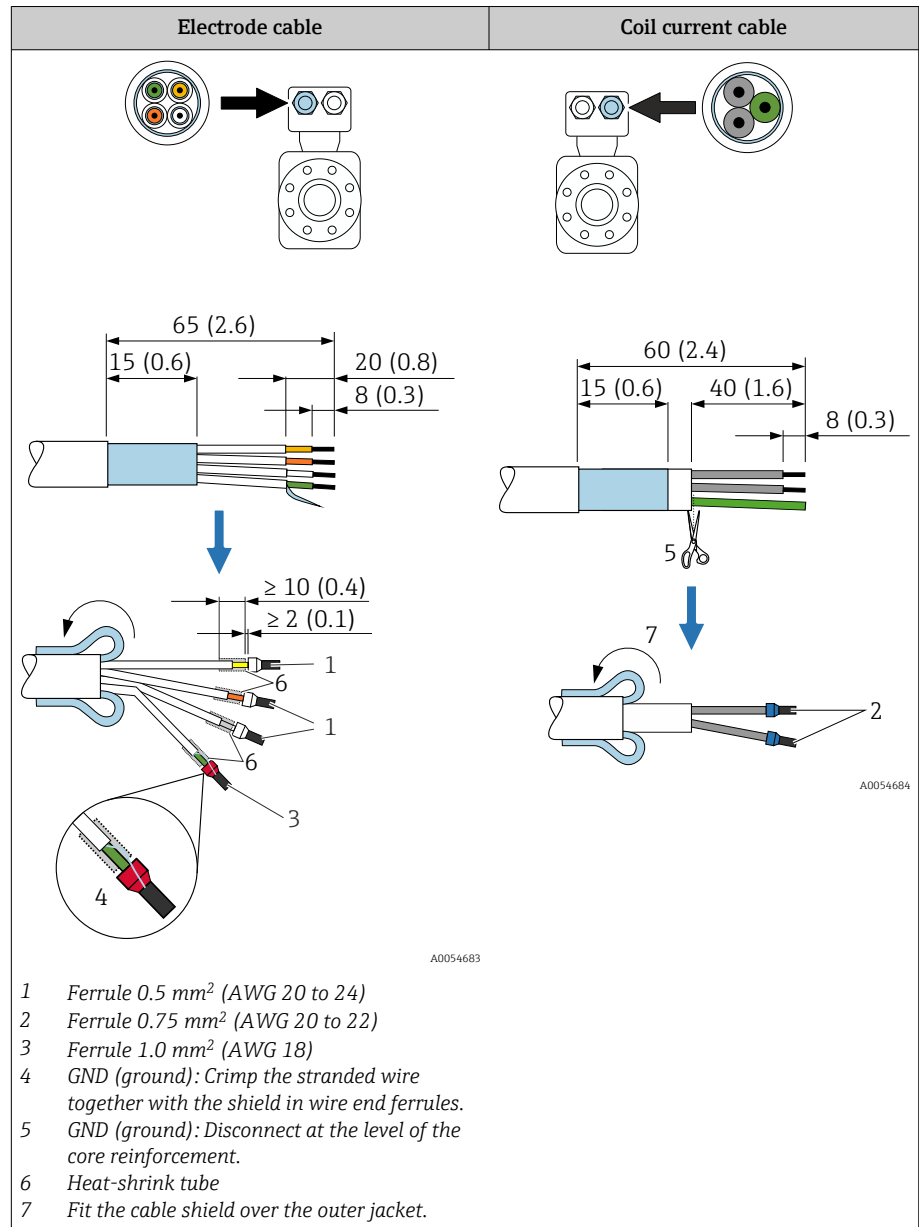

1. Make sure that the ferrules do not touch the cable shields on the sensor side. Minimum distance = 1 mm (exception: green "GND" cable)
2. A: Terminate the electrode cable.
3. B: Fit ferrules over the strands and press in place.
4. Fit the cable shield on the sensor side over the outer jacket.
5. Insulate the cable shield on the transmitter side, e.g. heat shrink tube.

Connecting the connecting cable

Connecting cable terminal assignment

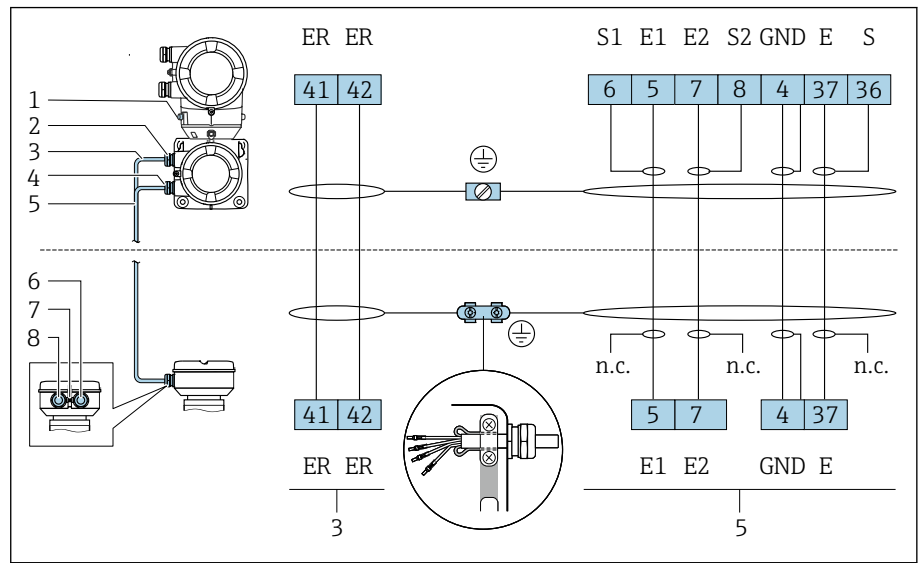

A0044619

- 1 Outer ground terminal
- 2 Transmitter housing: cable entry for coil current cable
- 3 Coil current cable
- 4 Transmitter housing: cable entry for electrode cable
- 5 Electrode cable
- 6 Sensor connection housing: cable entry for electrode cable
- 7 Outer ground terminal
- 8 Sensor connection housing: cable entry for coil current cable

Wiring the sensor connection housing

NOTICE

Incorrect wiring can damage the electronic components!

- ▶ Only connect sensors and transmitters with identical serial numbers.
- ▶ Connect the sensor connection housing and the transmitter housing to the potential equalization of the facility via the outer ground terminal.
- ▶ Connect the sensor and transmitter to the same potential.

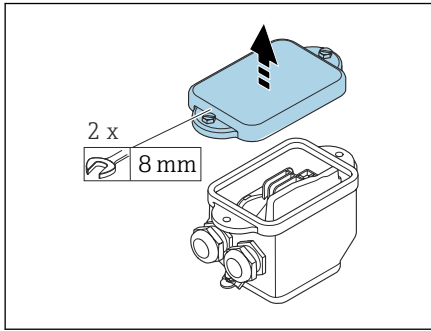

A0044737

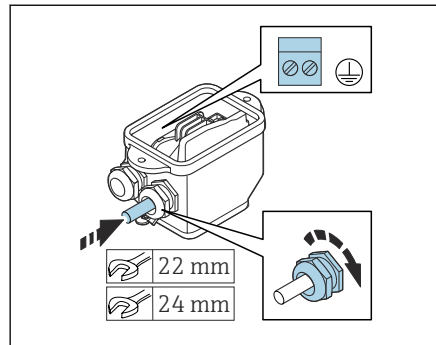

A0044738

1. Loosen the hexagonal-headed bolt of the connection compartment cover.
2. Remove the connection compartment cover.

NOTICE

If the sealing ring is missing, the housing is not sealed tight!

Damage to the device.

- ▶ Do not remove the sealing ring from the cable entry.

3. Feed the coil current cable and electrode cable through the corresponding cable entry.
4. Adjust the cable lengths.
5. Connect the cable shield to the strain relief clamp.
6. Strip the cable and cable ends.
7. Fit ferrules over the strands and press in place.
8. Connect the coil current cable and the electrode cable as per the terminal assignment.
9. Tighten the cable glands.
10. Close the connection compartment cover.

Wiring the transmitter housing**NOTICE**

Incorrect wiring can damage the electronic components!

- ▶ Only connect sensors and transmitters with identical serial numbers.
- ▶ Connect the sensor connection housing and the transmitter housing to the potential equalization of the facility via the outer ground terminal.
- ▶ Connect the sensor and transmitter to the same potential.

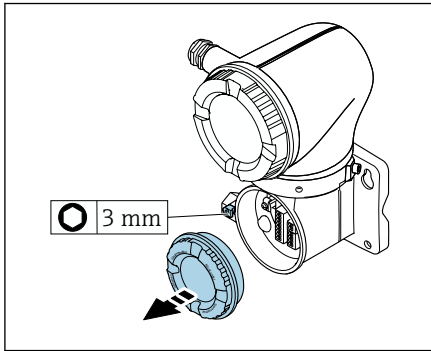

1. Loosen the Allen key of the securing clamp.
2. Open the connection compartment cover counterclockwise.

NOTICE

If the sealing ring is missing, the housing is not sealed tight!

Damage to the device.

- ▶ Do not remove the sealing ring from the cable entry.

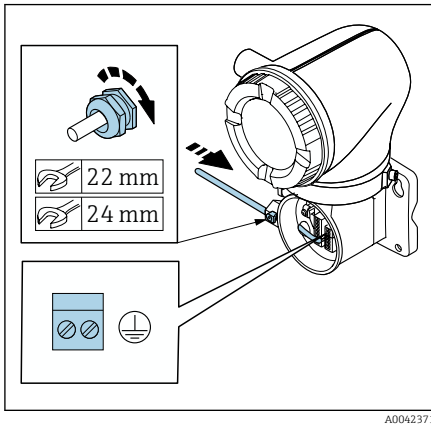

3. Feed the coil current cable and electrode cable through the corresponding cable entry.
4. Adjust the cable lengths.
5. Connect the cable shields to the inner ground terminal.
6. Strip the cable and cable ends.
7. Fit ferrules over the strands and press in place.
8. Connect the coil current cable and the electrode cable as per the terminal assignment.
9. Tighten the cable glands.
10. Close the connection compartment cover.
11. Fasten the securing clamp.

Transmitter connection

Transmitter terminal connections

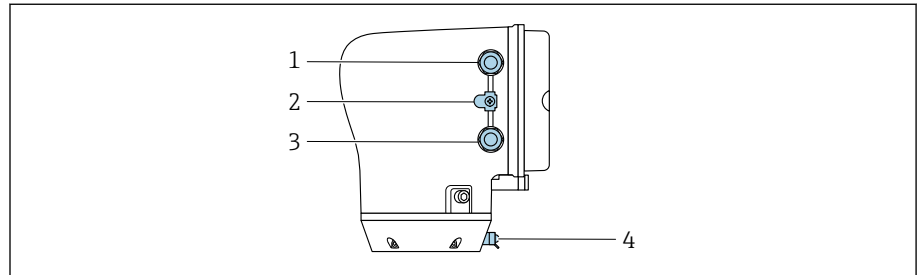

A0043283

- 1 Cable entry for power supply cable: supply voltage
- 2 Outer ground terminal: on transmitters made of polycarbonate with a metal pipe adapter
- 3 Cable entry for signal cable
- 4 Outer ground terminal

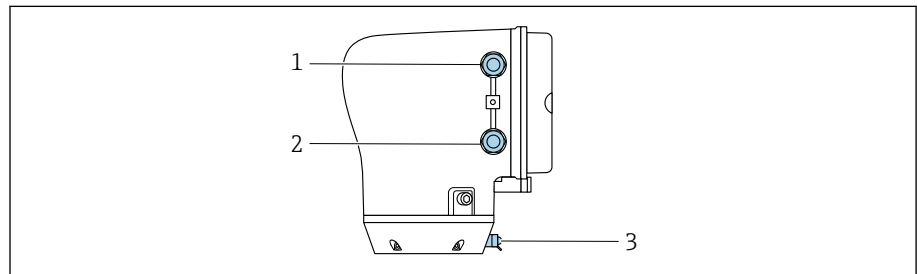

A0045438

- 1 Cable entry for power supply cable: supply voltage
- 2 Cable entry for signal cable
- 3 Outer ground terminal

Terminal assignment

i The terminal assignment is documented on an adhesive label.

The following terminal assignment is available:

Current output 4 to 20 mA HART (active) and pulse/frequency/switch output

Supply voltage		Output 1				Output 2	
1 (+)	2 (-)	26 (+)	27 (-)	24 (+)	25 (-)	22 (+)	23 (-)
L/+	N/-	Current output 4 to 20 mA HART (active)		-		Pulse/frequency/switch output (passive)	

Current output 4 to 20 mA HART (passive) and pulse/frequency/switch output

Supply voltage		Output 1				Output 2	
1 (+)	2 (-)	26 (+)	27 (-)	24 (+)	25 (-)	22 (+)	23 (-)
L/+	N/-	-		Current output 4 to 20 mA HART (passive)		Pulse/frequency/switch output (passive)	

Wiring the transmitter

- i** Use a suitable cable gland for the power supply cable and signal cable.
- Pay attention to the requirements for the power supply cable and signal cable → *Requirements for connecting cable*, ☰ 100.
- Use shielded cables for digital communication.

NOTICE

If the cable gland is incorrect, this compromises the sealing of the housing!
Damage to the device.

- ▶ Use a suitable cable gland corresponding to the degree of protection.

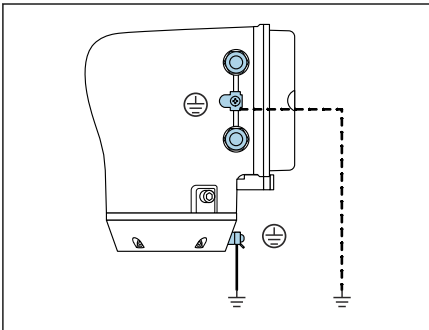

A0044720

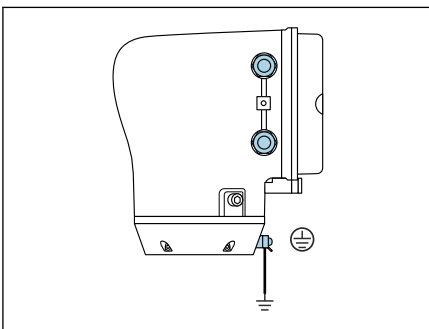

A0045442

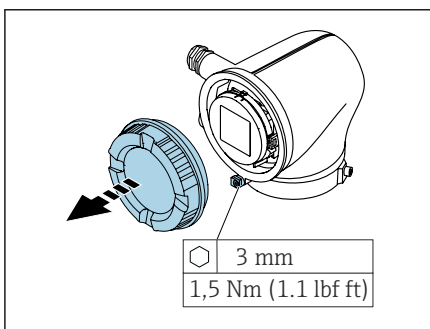

A0041094

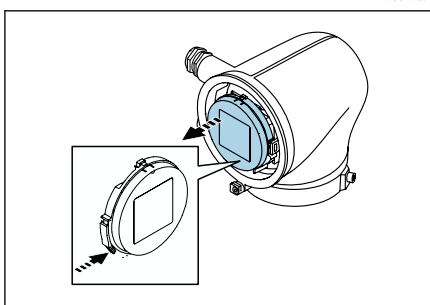

A0041330

1. Ground the device carefully and provide potential equalization.
2. Connect protective earthing to the outer ground terminals.

3. Loosen the Allen key of the securing clamp.
4. Open the housing cover counterclockwise.

5. Press the tab of the display module holder.
6. Remove the display module from the display module holder.

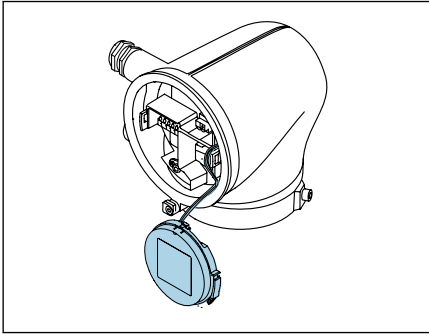

A0041354

i The cable must be in the tab for strain relief.

7. Let the display module hang down.

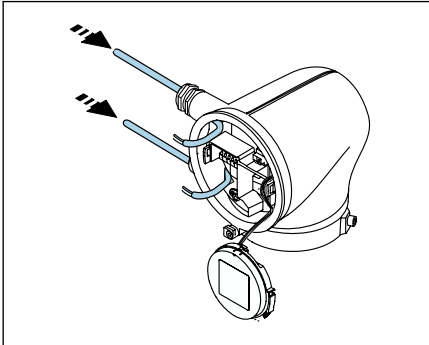

A0041356

8. Remove dummy plug if present.

NOTICE

If the sealing ring is missing, the housing is not sealed tight!

Damage to the device.

▶ Do not remove the sealing ring from the cable entry.

9. Feed the power supply cable and signal cable through the corresponding cable entry.

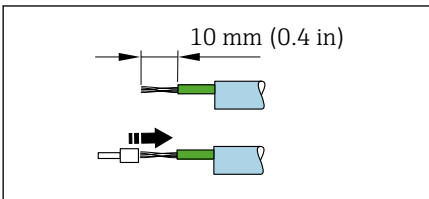

A0041357

10. Strip the cable and cable ends.

11. Fit ferrules over the strands and press in place.

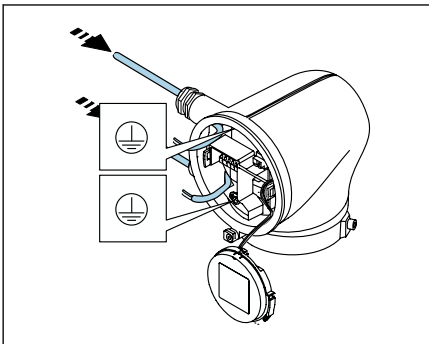

A0041358

i The terminal assignment is documented on an adhesive label.

12. Connect the protective ground (PE) to the inner ground terminal.

13. Connect the power supply cable and signal cable as per the terminal assignment.

14. Connect the cable shields to the inner ground terminal.

15. Tighten the cable glands.

16. Follow the sequence in the reverse order to reassemble.

Removing a cable

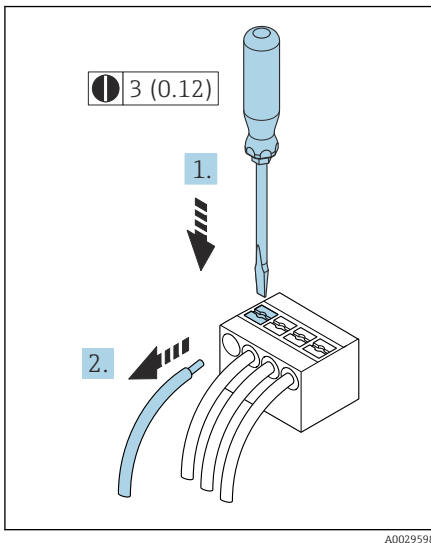

7 Engineering unit mm (in)

1. Use a flat-blade screwdriver to press down on the slot between the two terminal holes and hold.
2. Remove the cable end from the terminal.

Ensuring potential equalization

Metal process connections

Potential equalization is via the metal process connections that are in contact with the medium and mounted directly on the sensor.

Plastic process connections

Note the following when using grounding rings:

- Depending on the option ordered, plastic disks are used instead of grounding rings on some process connections. The plastic disks act as "spacers" and do not have any potential equalization function. They perform a significant sealing function at the sensor and process connection interfaces. In the case of process connections without metal grounding rings, the plastic disks and seals must never be removed. Plastic disks and seals must always be installed.
- Grounding rings can be ordered separately as accessory DK5HR* from Endress+Hauser (does not contain any seals). When ordering make sure that the grounding rings are compatible with the material used for the electrodes, as otherwise there is the danger that the electrodes could be destroyed by electrochemical corrosion!
- If seals are required, they can be additionally ordered with seal set DK5G*.
- Grounding rings including seals are mounted inside the process connections. This does not affect the installed length.

Connection example for potential equalization with additional grounding ring

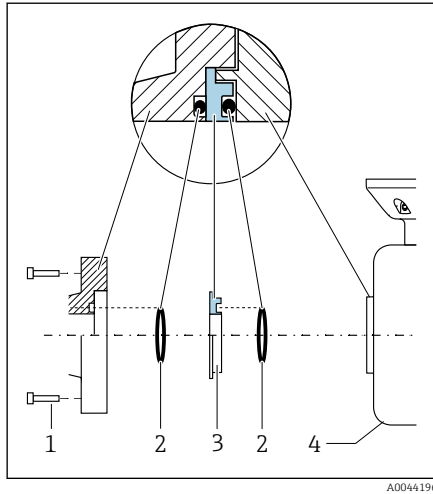

NOTICE

If potential equalization is not provided, this can lead to the electrochemical degradation of the electrodes or affect measurement accuracy!

Damage to the device.

- ▶ Install grounding rings.
- ▶ Provide (establish) potential equalization.

1. Loosen the hexagonal-headed bolts (1).
2. Remove the process connection from the sensor (4).
3. Remove the plastic disk (3), along with the seals (2), from the process connection.
4. Place the first seal (2) into the groove of the process connection.
5. Place the metal grounding ring (3) into the process connection.
6. Place the second seal (2) into the groove of the grounding ring.
7. Observe the maximum screw tightening torques for lubricated threads: 7 Nm (5.2 lbf ft)
8. Mount the process connection on the sensor (4).

Connection example for potential equalization with grounding electrodes

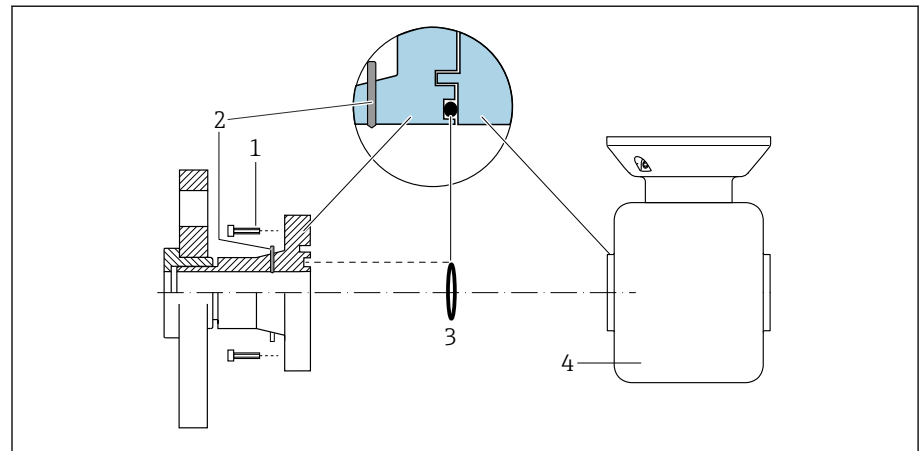

- 1 Hexagonal-headed bolts of process connection
- 2 Integrated grounding electrodes
- 3 Seal
- 4 Sensor

Hardware settings

Enabling write protection

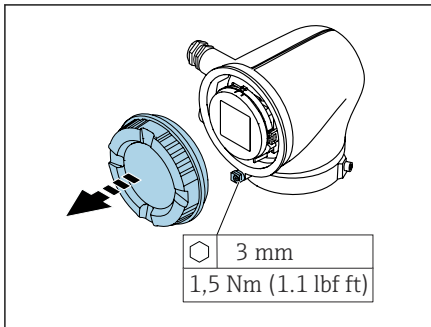

A0041094

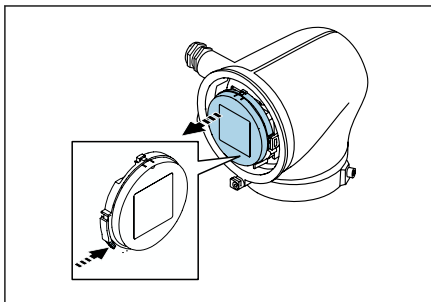

A0041330

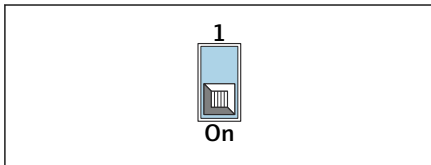

A0044412

1. Loosen the Allen key of the securing clamp.
2. Open the housing cover counterclockwise.
3. Press the tab of the display module holder.
4. Remove the display module from the display module holder.
5. Set the write protection switch on the back of the display module to the **On** position.
 - ↳ Write protection is enabled.
6. Follow the sequence in the reverse order to reassemble.

Post-connection check

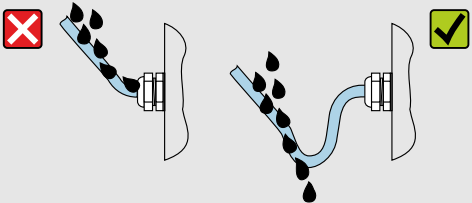
Only for remote version: Is the serial number on the nameplates of the connected sensor and transmitter identical?	<input type="checkbox"/>
Is the potential equalization established correctly?	<input type="checkbox"/>
Is the protective earthing established correctly?	<input type="checkbox"/>
Are the device and cable undamaged (visual check)?	<input type="checkbox"/>
Do the cables meet the requirements?	<input type="checkbox"/>
Is the terminal assignment correct?	<input type="checkbox"/>
Have old and damaged seals been replaced?	<input type="checkbox"/>
Are the seals dry, clean and installed correctly?	<input type="checkbox"/>
Are all the cable glands installed, firmly tightened and leak-tight?	<input type="checkbox"/>
Are dummy plugs inserted in unused cable entries?	<input type="checkbox"/>
Are transportation plugs replaced by dummy plugs?	<input type="checkbox"/>
Are the housing screws and housing cover tightened?	<input type="checkbox"/>
Do the cables loop down before the cable gland ("water trap")?	<input type="checkbox"/>
	<input type="checkbox"/>
Does the supply voltage match the specifications on the transmitter nameplate?	<input type="checkbox"/>

6 User operation

Overview of the operating options	54
Local operation	54
Operation via SmartBlue app	59

Overview of the operating options

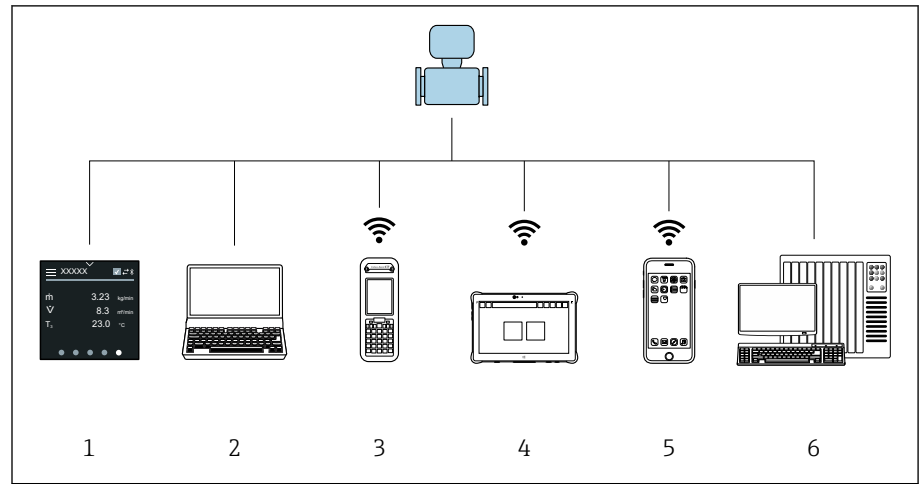

- 1 Local operation via touch screen
- 2 Computer with operating tool, e.g. FieldCare, DeviceCare, AMS Device Manager, SIMATIC PDM
- 3 Field Xpert SFX350 or SFX370 via Bluetooth, e.g. SmartBlue App
- 4 Field Xpert SMT70 via Bluetooth, e.g. SmartBlue App
- 5 Tablet or smartphone via Bluetooth, e.g. SmartBlue App
- 6 Automation system, e.g. PLC

Local operation

Unlocking local operation

Local operation must first be unlocked before the device can be operated via the touch screen. To unlock, draw the pattern "L" on the touch screen.

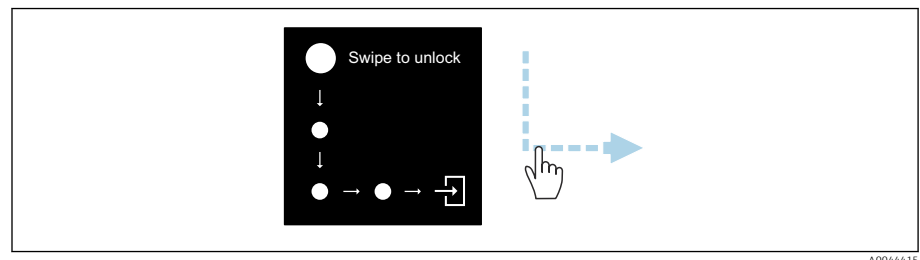

Navigation

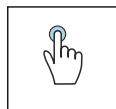

Tap

- Open menus.
- Select items in a list.
- Acknowledge buttons.
- Enter characters.

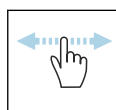

Swipe horizontally

Display next or previous page.

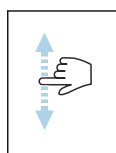

Swipe vertically

Display additional points in a list.

Operational display

During routine operation, the local display shows the operational display screen. The operational display comprises several windows that the user can toggle between.

i The operational display can be customized: see the description of parameters → *Main menu*, 56.

Operational display and navigation

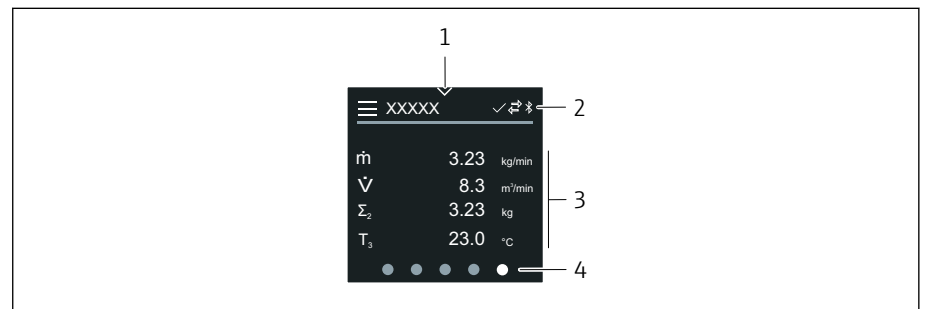

A0042992

- 1 Quick access
- 2 Status symbols, communication symbols and diagnostic symbols
- 3 Measured values
- 4 Rotating page display

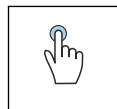

Tap

- Open the main menu.
- Open quick access.

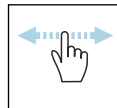

Swipe horizontally

Display next or previous page.

Symbols

- ☰ Open the main menu.
- ✓ Quick access
- 🔒 Locking status
- 📶 Bluetooth is active.
- ↔ Device communication is enabled.
- ▽ Status signal: function check
- ⬢ Status signal: maintenance required
- ⚠ Status signal: out of specification
- ⊗ Status signal: failure
- ☑ Status signal: diagnostics active.

Quick access

The Quick access menu contains a selection of specific device functions.

i Quick access is indicated by a triangle at the top of the local display in the middle.

Quick access and navigation

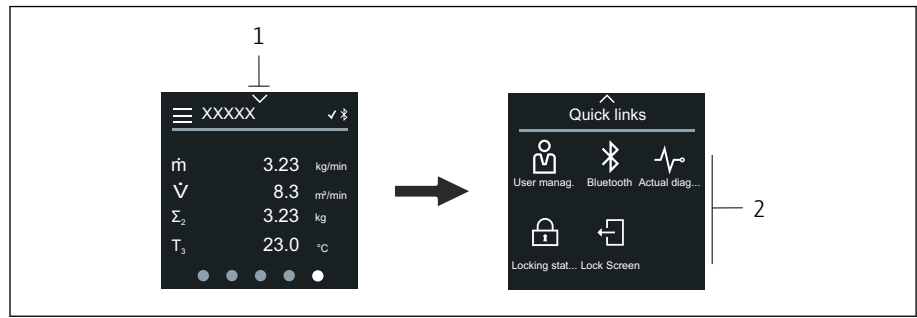

A0044208

- 1 Quick access
- 2 Quick access with specific device functions

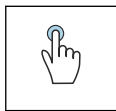

Tap

- Back to operational display.
- Open specific device functions.

Symbols

When a symbol is tapped, the local display shows the menu with the corresponding specific device functions.

- ⌘ Enable or disable Bluetooth.
- 🔑 Enter access code.
- 🔒 Write protection is enabled.
- ✕ Back to operational display.

Main menu

The main menu contains all the menus required for the commissioning, configuration and operation of the device.

Main menu and navigation

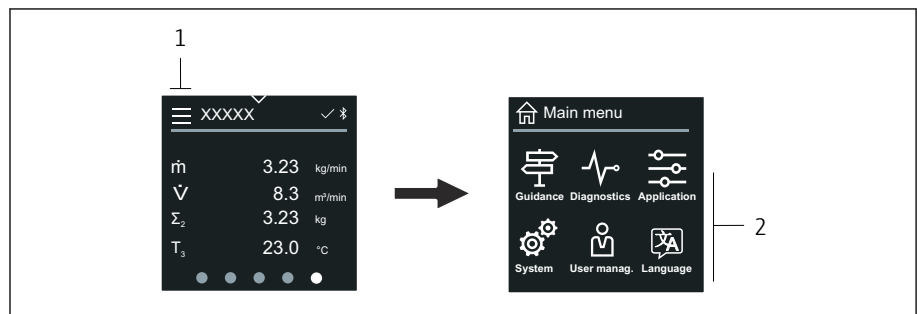

A0044213



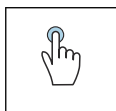



- 1 Open the main menu.
- 2 Open menus for the specific device functions.



Tap

- Back to operational display.
- Open menus.

Symbols

-  Back to operational display.
-  **Guidance** menu
Configuration of the device
-  **Diagnostics** menu
Troubleshooting and control of device behavior
-  **Application** menu
Application-specific adjustments
-  **System** menu
Device management and user administration
-  Set display language.

Submenus and navigation



A0044219

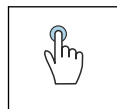

Tap

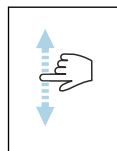

- Open the main menu.
- Open submenus or parameters.
- Select options.
- Skip items in list.



Swipe vertically

Select items in a list on a step-by-step basis.

Symbols

-  Return to previous menu.
-  Skip to bottom of list.
-  Skip to top of list.

Diagnostic information

Diagnostic information displays additional instructions or background information for diagnostic events.

Opening the diagnostic message

-  The diagnostic behavior is indicated on the top right of the local display by a diagnostics symbol. Tap the symbol or the "Help" button to open the diagnostic message.

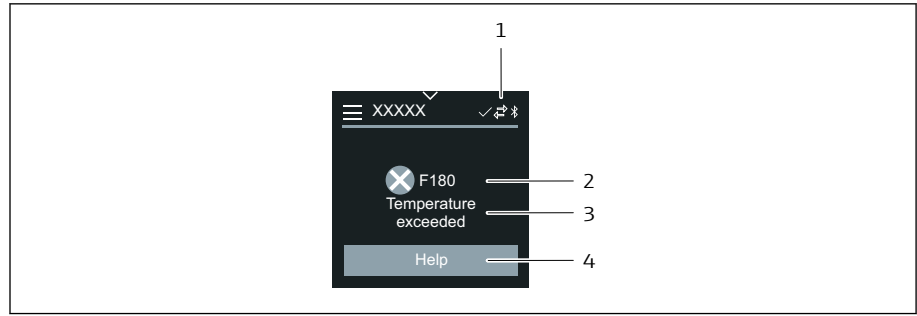

A0043008

- 1 Device status
- 2 Diagnostic behavior with diagnostic code
- 3 Short text
- 4 Open the troubleshooting measures.

Editing view

Editor and navigation

The text editor is used to enter characters.

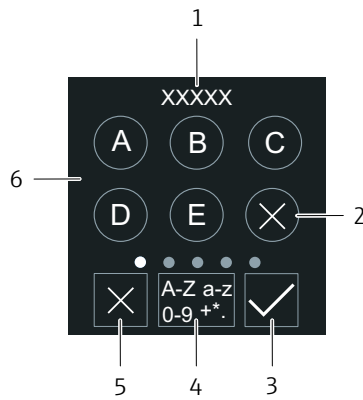

A0043020

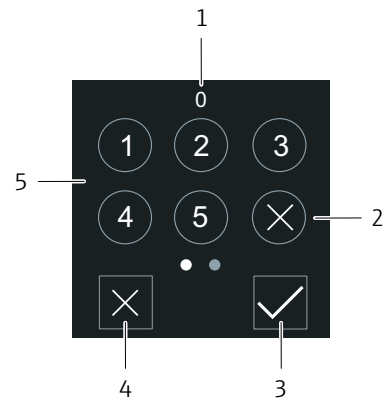

A0043023

- 1 Entry display area
- 2 Delete character.
- 3 Confirm your entry.
- 4 Switch input field.
- 5 Cancel editor.
- 6 Input field

- 1 Entry display area
- 2 Delete character.
- 3 Confirm your entry.
- 4 Cancel editor.
- 5 Input field

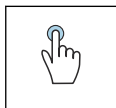

Tap

- Enter characters.
- Select next character set.

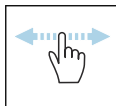

Swipe horizontally

Display next or previous page.

Input field

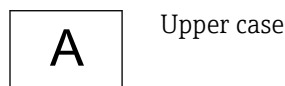



Numbers

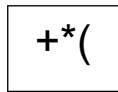

Special characters

Date

The device has a real-time clock for all log functions. The time can be configured here.

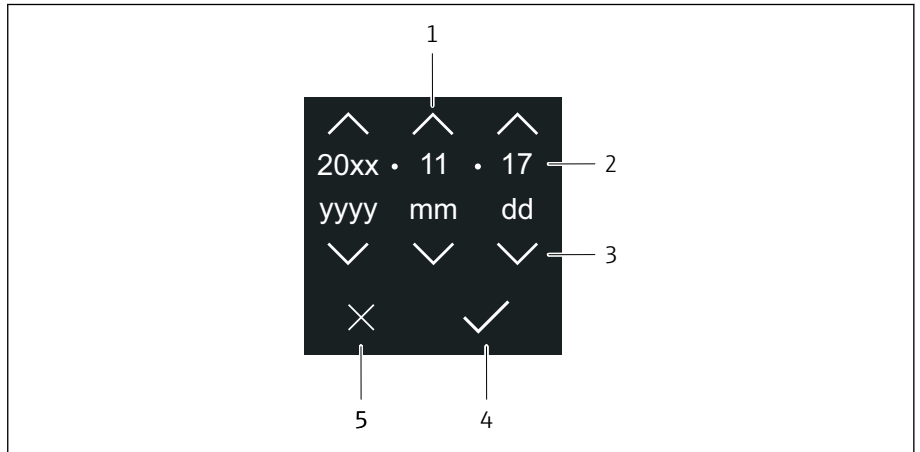

- 1 Increase date by 1.
- 2 Actual value
- 3 Decrease date by 1.
- 4 Confirm settings.
- 5 Cancel editor.

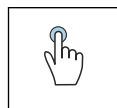

Tap

- Make settings.
- Confirm settings.
- Cancel editor.

Operation via SmartBlue app

The device can be operated and configured with the SmartBlue App.

- The SmartBlue app must be downloaded onto a mobile device for this purpose
- For information on the compatibility of the SmartBlue app with mobile devices, see **Apple App Store (iOS devices)** or **Google Play Store (Android devices)**
- Incorrect operation by unauthorized persons is prevented by means of encrypted communication and password encryption.
- The Bluetooth® function can be deactivated after initial device setup.

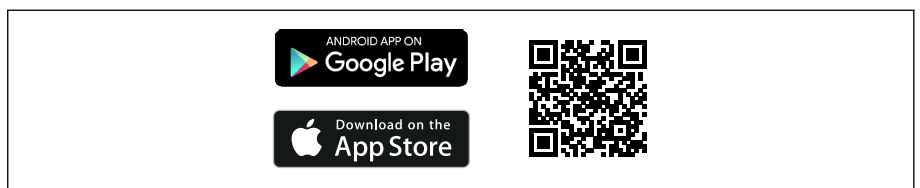

8 QR code for free Endress+Hauser SmartBlue App

Download and installation:

1. Scan the QR code or enter **SmartBlue** in the search field of the Apple App Store (iOS) or Google Play Store (Android).
2. Install and start the SmartBlue app.
3. For Android devices: enable location tracking (GPS) (not required for iOS devices).
4. Select a device that is ready to receive from the device list displayed.

Login:

1. Enter the user name: admin
2. Enter the initial password: serial number of the device
3. Change the password after logging in for the first time



Information on password and reset code

For devices that meet the requirements of IEC 62443-4-1 "Secure product development lifecycle management" ("ProtectBlue"):

- If the user-defined password is lost: refer to the user management instructions and the reset button in the operating manual.
- Refer to the associated Security Manual (SD).

For all other devices (without "ProtectBlue"):



- If the user-defined password is lost, access can be restored via a reset code. The reset code is the serial number of the device in reverse. The original password is once again valid after the reset code has been entered.
- The reset code can also be changed in addition to the password.
- If the user-defined reset code is lost, the password can no longer be reset via the SmartBlue app. Contact Endress+Hauser Service in this case.

7 System integration

Device description files	62
Measured variables via HART protocol	62

Device description files

Version data

Firmware version	01.00.zz	<ul style="list-style-type: none"> On the title page of the Operating instructions On the transmitter nameplate → <i>Transmitter nameplate</i>,  17 System → Information → Device → Firmware version
Release date of firmware version	04.2021	-
Manufacturer ID	0x11	Application → Communication → Information → Manufacturer ID
Device type code	0x71	Application → Communication → Information → Device ID
HART protocol revision	7	Application → Communication → Information → HART revision
Device revision	1	<ul style="list-style-type: none"> On the transmitter nameplate → <i>Transmitter nameplate</i>,  17 Diagnostics → Device information → Device revision

Operating tools

The suitable device description file for the individual operating tools is listed in the table below, along with information on where the file can be obtained.

Operating tool via HART protocol	Sources for obtaining device descriptions
FieldCare	<ul style="list-style-type: none"> www.endress.com → Downloads USB stick (contact Endress+Hauser)
DeviceCare	<ul style="list-style-type: none"> www.endress.com → Downloads USB stick (contact Endress+Hauser)
<ul style="list-style-type: none"> Field Xpert SFX350 Field Xpert SFX370 	Update function via handheld terminal
AMS Device Manager (Emerson Process Management)	www.endress.com → Downloads
SIMATIC PDM (Siemens)	www.endress.com → Downloads
Field Communicator 475 (Emerson Process Management)	Update function via handheld terminal

Measured variables via HART protocol

 Technical data → *Protocol-specific data*,  97

Dynamic variables

The following measured variables (HART device variables) are assigned to the dynamic variables at the factory:

Primary dynamic variable (PV)	Volume flow
Secondary dynamic variable (SV)	Totalizer 1
Tertiary dynamic variable (TV)	Totalizer 2
Quaternary dynamic variable (QV)	Totalizer 3

The assignment can be configured in the **Output** submenu.

Navigation

Application → Communication → Output

- Assign PV
- Assign SV
- Assign TV
- Assign QV



Assignment and available measured variables: Description of Device
Parameters → 6

Device variables

The device variables are permanently assigned. A maximum of 8 device variables can be transmitted.



- | | |
|---|------------------------|
| 0 | Volume flow |
| 1 | Mass flow |
| 2 | Conductivity |
| 3 | Corrected conductivity |
| 4 | Temperature |
| 6 | Electronic temperature |
| 7 | Totalizer 1 |
| 8 | Totalizer 2 |
| 9 | Totalizer 3 |

8 Commissioning

Post-installation check and post-connection check	66
IT security	66
Device-specific IT security	66
Switching on the device	67
Commissioning the device	68

Post-installation check and post-connection check

Before commissioning the device, make sure that the post-installation and post-connection checks have been performed:

- Post-installation check → *Post-mounting check*,  37
- Post-connection check → *Post-connection check*,  52

IT security

We only provide a warranty if the device is installed and used as described in the Operating Instructions. The device is equipped with security mechanisms to protect it against any inadvertent changes to the device settings.

IT security measures in line with operators' security standards and designed to provide additional protection for the device and device data transfer must be implemented by the operators themselves.

Device-specific IT security

Access via Bluetooth

Secure signal transmission via Bluetooth uses an encryption method tested by the Fraunhofer Institute.

- Without the SmartBlue App, the device is not visible via Bluetooth.
- Only one point-to-point connection is established between the device and a smartphone or tablet.

Access via the SmartBlue App

Two access levels (user roles) are defined for the device: the **Operator** user role and the **Maintenance** user role. The **Maintenance** user role is configured when the device leaves the factory.

If a user-specific access code is not defined (in the Enter access code parameter), the default setting **0000** continues to apply and the **Maintenance** user role is automatically enabled. The device's configuration data are not write-protected and can be edited at all times.

If a user-specific access code has been defined (in the Enter access code parameter), all the parameters are write-protected. The device is accessed with the **Operator** user role. When the user-specific access code is entered a second time, the **Maintenance** user role is enabled. All parameters can be written to.



For detailed information, see the "Description of Device Parameters" document pertaining to the device.

Protecting access via a password

There are a variety of ways to protect against write access to the device parameters:

- User-specific access code:
Protect write access to the device parameters via all the interfaces.
- Bluetooth key:
The password protects access and the connection between an operating unit, e.g. a smartphone or tablet, and the device via the Bluetooth interface.

General notes on the use of passwords

- The access code and Bluetooth key that are valid when the device is delivered must be redefined during commissioning.
- Follow the general rules for generating a secure password when defining and managing the access code and Bluetooth key.
- The user is responsible for the management and careful handling of the access code and Bluetooth key.

Write protection switch

The entire operating menu can be locked via the write protection switch. The values of the parameters cannot be changed. Write protection is disabled when the device leaves the factory.

Access authorization with write protection:

- Disabled: write access to the parameters
- Enabled: read-only access to the parameters

Write protection is enabled with the write protection switch on the back of the display module → *Hardware settings*, 51.

i The local display indicates that write protection is enabled on the top right of the display: .

Switching on the device

- ▶ Switch on the supply voltage for the device.
 - ↳ The local display switches from the start screen to the operational display.

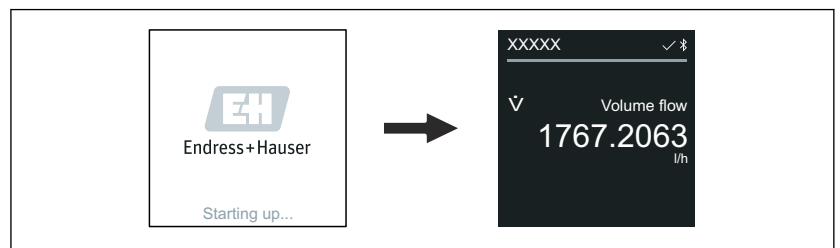



A0042938

i If device startup is not successful, the device displays an error message to this effect → *Diagnostics and troubleshooting*, 74.

Commissioning the device

Local operation

 Detailed information on local operation: → *User operation*,  54

1. Via the "Menu" symbol, open the main menu.

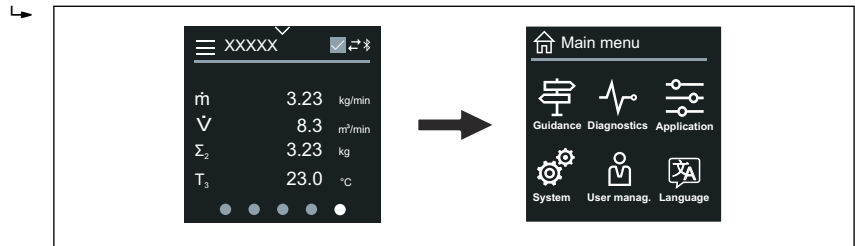

A0042939

2. Via the "Language" symbol, select the desired language.

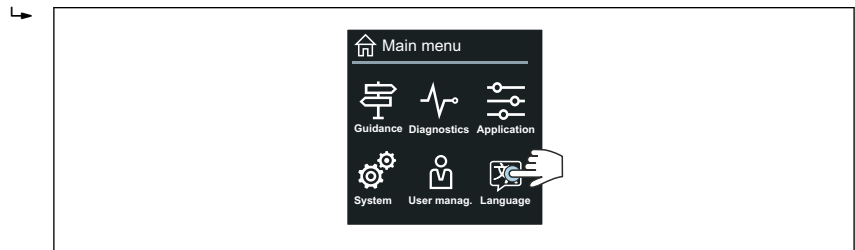

A0042940

3. Via the "Guidance" symbol, open the **Commissioning** wizard.

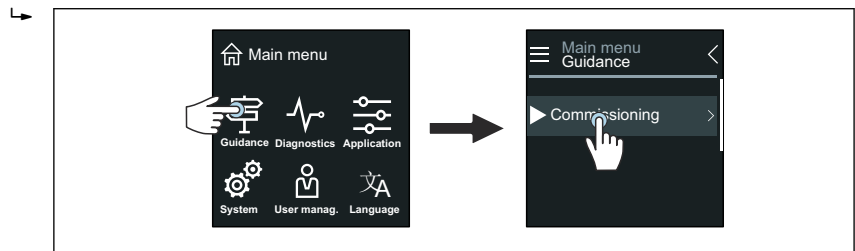

A0042941

4. Start the **Commissioning** wizard.

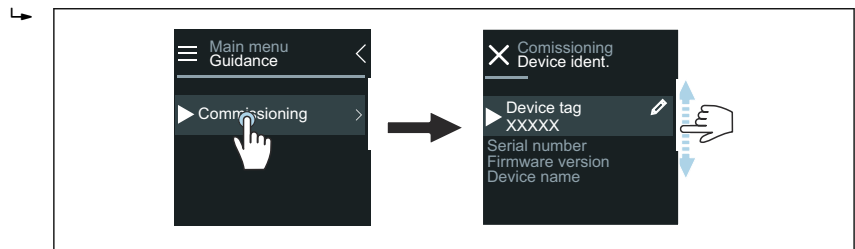

A0043018

5. Follow the instructions on the local display.
 - ↳ The **Commissioning** wizard goes through all the device parameters that are necessary to commission the device.

 For detailed information, see the "Description of Device Parameters" document pertaining to the device.

SmartBlue App

 Information on the SmartBlue App .

Connecting the SmartBlue App to the device

1. Enable Bluetooth on the mobile handheld terminal, tablet or smartphone.
2. Start the SmartBlue App.
 - ↳ A Live List shows all the devices available.
3. Select the desired device.
 - ↳ The SmartBlue App shows the device login.
4. Under user name, enter **admin**.
5. Under password, enter the device's serial number. Serial number:
→ *Transmitter nameplate*, ⓘ 17.
6. Confirm your entries.
 - ↳ The SmartBlue App connects to the device and displays the main menu.

Opening "Commissioning" wizard

1. Via the **Guidance** menu, open the **Commissioning** wizard.
2. Follow the instructions on the local display.
 - ↳ The **Commissioning** wizard goes through all the device parameters that are necessary to commission the device.

9 Operation

Reading off the device locking status	72
HistoROM data management	72

Reading off the device locking status

Indicates the write protection with the highest priority that is currently active.

Navigation

"System" menu → Device management → Locking status

Parameter overview with brief description

Parameter	Description	User interface
Locking status	Indicates the write protection with the highest priority that is currently active.	<ul style="list-style-type: none"> ▪ Hardware locked ▪ Temporarily locked

HistoROM data management

The device features HistoROM data management. Device data and process data can be saved, imported and exported with the HistoROM data management function, making operation and servicing far more reliable, secure and efficient.

Data backup

Automatically

The most important device data, e.g. sensor and transmitter, are automatically saved in the S+T-DAT.

Following replacement of the sensor, the customer-specific sensor data are transferred to the device. The device goes into operation immediately without any problems.

Manual

The transmitter data (customer settings) must be manually saved.

Storage concept

	HistoROM backup	S+T-DAT
Available data	<ul style="list-style-type: none"> ▪ Event logbook, e.g. Diagnostic events ▪ Parameter data record backup 	<ul style="list-style-type: none"> ▪ Sensor data, e.g. Nominal diameter ▪ Serial number ▪ Calibration data ▪ Configuration of the device, e.g. software options
Storage location	On the sensor electronics module (ISEM)	In the sensor connector in the sensor neck

Data transmission

A parameter configuration can be transferred to another device using the export function of the operating tool. The parameter configuration can be duplicated or saved in an archive.

10 Diagnostics and troubleshooting

General troubleshooting	74
Diagnostic information via LED	75
Diagnostic information on local display	77
Diagnostic information in FieldCare or DeviceCare	78
Changing the diagnostic information	79
Overview of diagnostic information	80
Pending diagnostic events	83
Diagnostic list	83
Event logbook	83
Resetting the device	85

General troubleshooting

Local display

Fault	Possible causes	Remedy
Local display dark, no output signals	Supply voltage does not match the voltage specified on the nameplate. Supply voltage has incorrect polarity. No contact between cables and terminals. Terminals are not plugged into the electronics module correctly. Electronics module is defective.	Apply the correct supply voltage. Reverse polarity of supply voltage. <ul style="list-style-type: none"> ■ Check contact of cables. ■ Connect the cables to the terminals again. ■ Check the terminals. ■ Plug the terminals into the electronics module again. Order the appropriate spare part.
Local display is dark, but signal output is within the valid range.	Incorrect contrast setting of local display. Cable connector for the local display is not correctly connected. Local display is defective.	Adjust the contrast of the local display to ambient conditions. Plug in the cable connector correctly. Order the appropriate spare part.
Display alternates between error message and operational display	Diagnostic event has occurred.	Carry out appropriate troubleshooting measures.
Local display shows text in a foreign, incomprehensible language.	A foreign language is set.	Set the language of the local display.





Only for remote version

Fault	Possible causes	Remedy
Local display displays a fault, no output signals	Cable connectors between the electronics module and local display are not plugged in correctly. Electrode cable and coil current cable are not plugged in correctly.	Plug in the cable connector correctly. Plug in the electrode cable and coil current cable correctly.

Output signal

Fault	Possible causes	Remedy
Signal output is outside the valid current range (< 3.5 mA or > 23 mA).	Electronics module is defective.	Order the appropriate spare part.
Local display shows the correct value, but signal output is incorrect, though in the valid range.	Parameter configuration error	<ul style="list-style-type: none"> ■ Check parameter configuration. ■ Correct parameter configuration.
Device is measuring incorrectly.	<ul style="list-style-type: none"> ■ Parameter configuration error ■ The device is being operated outside the application range. 	<ul style="list-style-type: none"> ■ Check parameter configuration. ■ Correct parameter configuration. ■ Observe limit values indicated.
No signal at frequency output	Device uses passive frequency output.	Wire the device correctly as described in the Operating Instructions → <i>Electrical connection</i> , 40.

Access and communication

Fault	Possible causes	Remedy
Not possible to write-access the parameter.	Write protection is enabled.	Set the write protection switch on the local display to the Off position.
	Current user role has limited access authorization.	<ol style="list-style-type: none"> 1. Check user role. 2. Enter correct customer-specific access code.
HART communication is not possible.	Load resistor missing or size is incorrect	<ul style="list-style-type: none"> ■ Load resistor must be at least 250 Ω. ■ Observe the maximum load → <i>Output signal</i>,  94. ■ → <i>Examples of electric terminals</i>,  164
	<ul style="list-style-type: none"> ■ Commubox is not properly connected. ■ Commubox is configured incorrectly. ■ Commubox driver is not installed correctly. ■ Wrong USB interface is configured on PC. 	Observe the documentation for the Commubox.  FXA195 HART: Document "Technical Information" TI00404F
Device communication is not possible.	Data transfer is active.	Wait until the data transfer or the current action is finished.
SmartBlue App does not show the device in the live list.	<ul style="list-style-type: none"> ■ Bluetooth is disabled on the device. ■ Bluetooth is disabled on the smartphone or tablet. 	<ol style="list-style-type: none"> 1. Check whether the Bluetooth symbol appears on the local display. 2. Enable Bluetooth on the device. 3. Enable Bluetooth on the smartphone or tablet.
Device cannot be operated with the SmartBlue App.	<ul style="list-style-type: none"> ■ Bluetooth connection is not available. ■ The device is already connected to another smartphone or tablet. ■ Incorrect password entered. ■ Password forgotten. 	<ol style="list-style-type: none"> 1. Check whether other devices are connected to the SmartBlue App. 2. Disconnect any other device connected to the SmartBlue App. 1. Enter correct password. 2. Contact Endress+Hauser service organization.
Login with user data is not possible with the SmartBlue App.	Device in operation for the first time.	<ol style="list-style-type: none"> 1. Enter the initial password (serial number of the device). 2. Change the initial password.
No connection via service interface	<ul style="list-style-type: none"> ■ Commubox driver is not installed correctly. ■ Wrong USB interface is configured on PC. 	Observe the documentation for the Commubox.  FXA291 HART: Document "Technical Information" TI00405C

Diagnostic information via LED

Only for devices with the order code for "Display; operation", option H

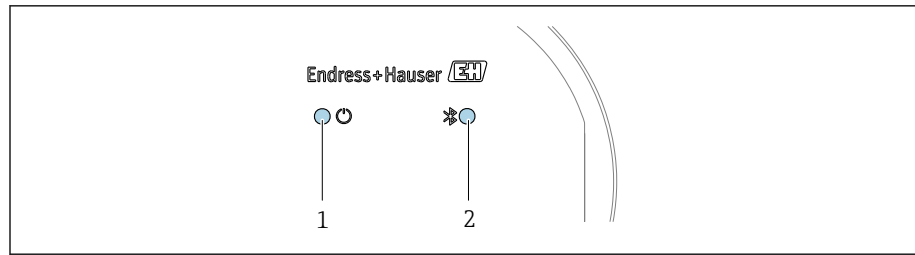

A0044231

- 1 Device status
2 Bluetooth

LED	Status	Meaning
1 Device status (normal operation)	Off	No power supply
	Permanently green	Device status is OK. No warning / failure / alarm
	Flashing red	Warning is active.
	Permanently red	Alarm is active.
2 Bluetooth	Off	Bluetooth is disabled.
	Permanently blue	Bluetooth is enabled.
	Flashing blue	Data transfer in progress.

Diagnostic information on local display

Diagnostic message

The local display alternates between displaying faults as a diagnostic message and displaying the operational display screen.

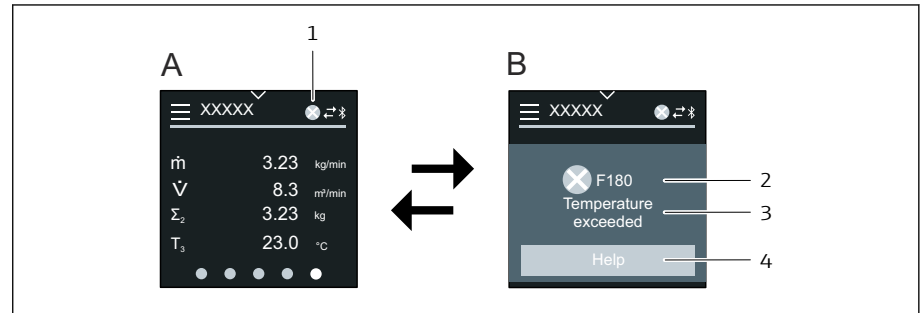

- A Operational display in alarm condition
 B Diagnostic message
 1 Diagnostic behavior
 2 Diagnostic behavior with diagnostic code
 3 Short text
 4 Open information on remedial measures (HART and Modbus RS485 only)

If two or more diagnostic events are pending simultaneously, the local display only shows the diagnostic message with the highest priority.

- i** Other diagnostic events that have occurred can be opened in the **Diagnostics** menu as follows:
- Via parameters
 - Via submenus

Status signals

The status signals provide information on the state and reliability of the device by categorizing the cause of the diagnostic information (diagnostic event).

- i** The status signals are categorized according to NAMUR Recommendation NE 107: F = Failure, C = Function Check, S = Out of Specification, M = Maintenance Required, N = No Effect



A0013956

Failure

- A device error has occurred.
- Measured value is no longer valid.

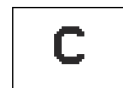

A0013959

Function check

Device is in the service mode, e.g. during a simulation.

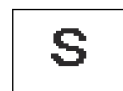

A0013958

Out of specification

- Device is being operated outside the technical specification limits, e.g. outside the process temperature range.
- Device is being operated outside the configuration carried out by the user, e.g. max. flow in the 20 mA value parameter.



A0013957

Maintenance required

- Maintenance is required.
- Measured value is still valid.

Diagnostic information

The fault can be identified using the diagnostic information. The short text displays a tip about the fault.

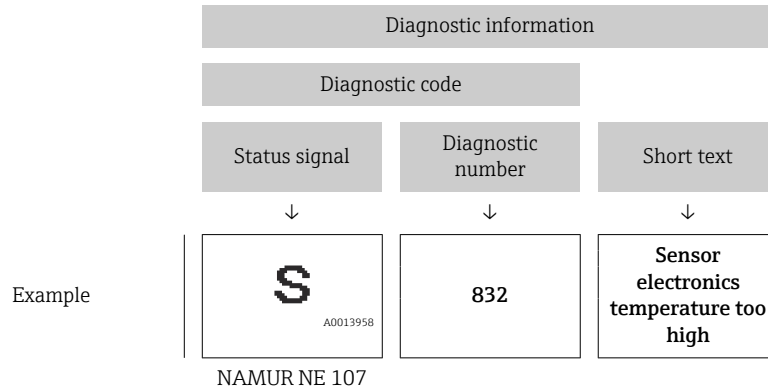

Diagnostic information in FieldCare or DeviceCare

Diagnostic options

After the connection has been established, the device shows faults on the home page.

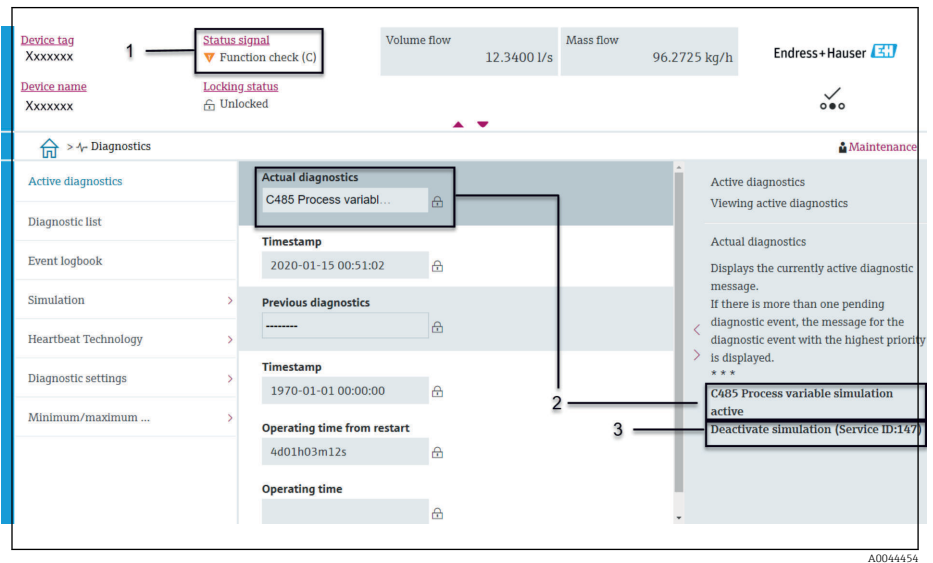

- 1 Status area with diagnostic behavior and status signal
- 2 Diagnostic code and short message
- 3 Troubleshooting measures with service ID

- i** Other diagnostic events that have occurred can be opened in the **Diagnostics** menu as follows:
- Via parameter
 - Via submenus

Diagnostic information

The fault can be identified using the diagnostic information. The short text displays a tip about the fault. The corresponding symbol for the diagnostic behavior appears at the start.

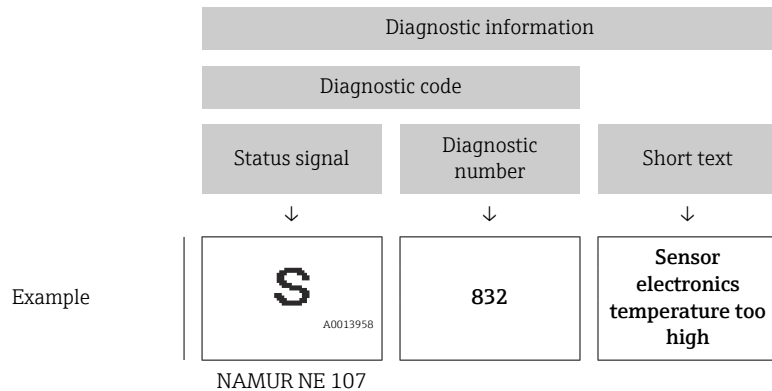

Changing the diagnostic information

Adapting the status signal

Each item of diagnostic information is assigned a specific status signal at the factory. The user can change the assignment for specific diagnostic information in the **"Diagnostic settings" submenu**.

Navigation path

Diagnostics → Diagnostic settings

Configuration of the device as per HART 7 Specification (Condensed Status), in accordance with NAMUR NE107.



Failure

- A device error has occurred.
- Measured value is no longer valid.



Function check

Device is in the service mode, e.g. during a simulation.

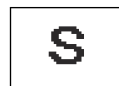

Out of specification

- Device is being operated outside the technical specification limits, e.g. outside the process temperature range.
- Device is being operated outside the configuration carried out by the user, e.g. max. flow in the 20 mA value parameter.



Maintenance required

- Maintenance is required.
- Measured value is still valid.

Adapting the diagnostic behavior

Each item of diagnostic information is assigned a specific diagnostic behavior at the factory. The user can change the assignment for specific diagnostic information in the **Diagnostic settings** submenu.

Navigation path

Diagnostics → Diagnostic settings

You can assign the following options to the diagnostic number as the diagnostic behavior:

Options	Description
Alarm	<ul style="list-style-type: none"> ▪ Device stops measurement. ▪ Signal outputs and totalizers assume a defined alarm condition. ▪ Diagnostic message is generated.
Warning	<ul style="list-style-type: none"> ▪ Device continues measuring. ▪ Signal outputs and totalizers are not affected. ▪ Diagnostic message is generated.
Logbook entry only	<ul style="list-style-type: none"> ▪ Device continues measuring. ▪ The local display shows the diagnostic message in the Event logbook submenu (Event list submenu) and does not alternate with the operational display.
Off	<ul style="list-style-type: none"> ▪ Diagnostic event is ignored. ▪ Diagnostic message is not generated and not entered.

Overview of diagnostic information



The amount of diagnostic information and the number of measured variables affected increase if the device has one or more application packages.

Diagnostic number	Short text	Remedy instructions	Status signal [from the factory]	Diagnostic behavior [from the factory]
Diagnostic of sensor				
043	Sensor 1 short circuit detected	<ol style="list-style-type: none"> 1. Check sensor cable and sensor 2. Execute Heartbeat Verification 3. Replace sensor cable or sensor 	S	Warning ¹⁾
082	Data storage inconsistent	<ol style="list-style-type: none"> 1. Check module connections 2. Contact service 	F	Alarm
083	Memory content inconsistent	<ol style="list-style-type: none"> 1. Restart device 2. Restore HistoROM S-DAT backup ('Device reset' parameter) 3. Replace HistoROM S-DAT 	F	Alarm
168	Build-up detected	Clean measuring tube	M	Warning
169	Conductivity measurement failed	<ol style="list-style-type: none"> 1. Check grounding conditions 2. Deactivate conductivity measurement 	M	Warning
170	Coil resistance faulty	Check ambient and process temperature	F	Alarm
180	Temperature sensor defective	<ol style="list-style-type: none"> 1. Check sensor connections 2. Replace sensor cable or sensor 3. Turn off temperature measurement 	F	Warning

Diagnostic number	Short text	Remedy instructions	Status signal [from the factory]	Diagnostic behavior [from the factory]
181	Sensor connection faulty	1. Check sensor cable and sensor 2. Execute Heartbeat Verification 3. Replace sensor cable or sensor	F	Alarm
Diagnostic of electronic				
201	Electronics faulty	1. Restart device 2. Contact service	F	Alarm
230	Date/time incorrect	1. Replace RTC buffer battery 2. Set date and time	M	Warning ¹⁾
231	Date/time not available	1. Replace display module or its cable 2. Set date and time	M	Warning ¹⁾
242	Firmware incompatible	1. Check firmware version 2. Flash or replace electronic module	F	Alarm
252	Module incompatible	1. Check electronic modules 2. Check if correct modules are available (e.g. NEx, Ex) 3. Replace electronic modules	F	Alarm
278	Display module defective	Replace display module	F	Alarm
283	Memory content inconsistent	1. Reset device 2. Contact service	F	Alarm
302	Device verification active	Device verification active, please wait.	C	Warning ¹⁾
311	Sensor electronics (ISEM) faulty	1. Do not reset device 2. Contact service	M	Warning
331	Firmware update failed in module 1 to n	1. Update firmware of device 2. Restart device	F	Warning
372	Sensor electronics (ISEM) faulty	1. Restart device 2. Check if failure recurs 3. Replace sensor electronic module (ISEM)	F	Alarm
373	Sensor electronics (ISEM) faulty	Contact service	F	Alarm
376	Electronic module faulty	1. Replace electronic module 2. Turn off diagnostic message	S	Warning ¹⁾
377	Electronic module faulty	1. Activate empty pipe detection 2. Check partial filled pipe and installation direction 3. Check sensor cabling 4. Deactivate diagnostics 377	S	Warning ¹⁾
378	Electronic module supply voltage faulty	Check supply voltage to the ISEM	F	Alarm
383	Memory content	1. Restart device 2. Delete T-DAT via 'Reset device' parameter 3. Replace T-DAT	F	Alarm
387	HistoROM data faulty	Contact service organization	F	Alarm

Diagnostic number	Short text	Remedy instructions	Status signal [from the factory]	Diagnostic behavior [from the factory]
Diagnostic of configuration				
410	Data transfer failed	1. Check connection 2. Retry data transfer	F	Alarm
412	Processing download	Download active, please wait	C	Warning
431	Trim 1 required	Carry out trim	C	Warning
437	Configuration incompatible	1. Restart device 2. Contact service	F	Alarm
438	Dataset different	1. Check data set file 2. Check device configuration 3. Up- and download new configuration	M	Warning
441	Current output faulty	1. Check process 2. Check current output settings	S	Warning ¹⁾
442	Frequency output faulty	1. Check process 2. Check frequency output settings	S	Warning ¹⁾
443	Pulse output 1 faulty	1. Check process 2. Check pulse output settings	S	Warning ¹⁾
453	Flow override active	Deactivate flow override	C	Warning
484	Failure mode simulation active	Deactivate simulation	C	Alarm
485	Process variable simulation active	Deactivate simulation	C	Warning
491	Current output 1 simulation active	Deactivate simulation	C	Warning
492	Frequency output simulation active	Deactivate simulation frequency output	C	Warning
493	Pulse output simulation active	Deactivate simulation pulse output	C	Warning
494	Switch output simulation active	Deactivate simulation switch output	C	Warning
495	Diagnostic event simulation active	Deactivate simulation	C	Warning
511	Electronic module settings faulty	1. Check measuring period and integration time 2. Check sensor properties	C	Alarm
Diagnostic of process				
832	Sensor electronics temperature too high	Reduce ambient temperature	S	Warning ¹⁾
833	Sensor electronics temperature too low	Increase ambient temperature	S	Warning ¹⁾
834	Process temperature too high	Reduce process temperature	S	Warning ¹⁾
835	Process temperature too low	Increase process temperature	S	Warning ¹⁾
842	Process value above limit	1. Decrease process value 2. Check application 3. Check sensor	S	Warning ¹⁾

Diagnostic number	Short text	Remedy instructions	Status signal [from the factory]	Diagnostic behavior [from the factory]
937	Sensor symmetry	1. Eliminate external magnetic field near sensor 2. Turn off diagnostic message	S	Warning ¹⁾
938	EMC interference	1. Check ambient conditions regarding EMC influence 2. Turn off diagnostic message	F	Alarm ¹⁾
944	Monitoring failed	Check process conditions for Heartbeat Monitoring	S	Warning
961	Electrode potential out of specification	1. Check process conditions 2. Check ambient conditions	S	Warning ¹⁾
962	Pipe empty	1. Perform full pipe adjustment 2. Perform empty pipe adjustment 3. Turn off empty pipe detection	S	Warning ¹⁾

1) Diagnostic behavior can be changed.

Pending diagnostic events

The **Active diagnostics** submenu displays the current diagnostic event and the last diagnostic event to occur.

Diagnostics → Active diagnostics

 The **Diagnostic list** submenu shows other diagnostic events that are pending.

Diagnostic list

The **Diagnostic list** submenu shows up to 5 currently pending diagnostic events with the related diagnostic information. If more than 5 diagnostic events are pending, the local display shows the diagnostic information with the highest priority.

Navigation path

Diagnostics → Diagnostic list

Event logbook

Reading out the event logbook

 The event logbook is only available via FieldCare, DeviceCare or SmartBlue App (Bluetooth).



The **Event logbook** submenu shows a chronological overview of the event messages that have occurred.

Navigation path



Diagnostics menu → **Event logbook** submenu

Chronological display with a maximum of 20 event messages.

The event history includes the following entries:

- Diagnostic event → *Overview of diagnostic information*,  80
- Information event → *Overview of information events*,  84

In addition to the operation time of the event occurrence, each event is also assigned a symbol that indicates whether the event has occurred or has ended:

- Diagnostic event
 - : Occurrence of the event
 - : End of the event
- Information event
 - : Occurrence of the event

 Filter event messages:

Filtering the event logbook

The **Event logbook** submenu displays the category of event messages that were configured with the **Filter options** parameter.

Navigation path

Diagnostics → Event logbook → Filter options

Filter categories

- All
- Failure (F)
- Function check (C)
- Out of specification (S)
- Maintenance required (M)
- Information (I)

Overview of information events

The information event is only displayed in the event logbook.

Info number	Info name
I1000	----- (Device ok)
I1079	Sensor changed
I1089	Power on
I1090	Configuration reset
I1091	Configuration changed
I11036	Date/time set successfully
I11167	Date/time resynchronized
I1137	Display module replaced
I1151	History reset
I1155	Sensor electronics temperature reset
I1157	Memory error event list
I1256	Display: access status changed
I1335	Firmware changed
I1351	Empty pipe detection adjustment failure
I1353	Empty pipe detection adjustment ok
I1397	Fieldbus: access status changed
I1398	CDI: access status changed
I1443	Build-up thickness not determined
I1444	Device verification passed

Info number	Info name
I1445	Device verification failed
I1459	I/O module verification failed
I1461	Sensor verification failed
I1462	Sensor electronic module verific. failed
I1512	Download started
I1513	Download finished
I1514	Upload started
I1515	Upload finished
I1622	Calibration changed
I1624	All totalizers reset
I1625	Write protection activated
I1626	Write protection deactivated
I1629	CDI: login successful
I1632	Display: login failed
I1633	CDI: login failed
I1634	Reset to factory settings
I1635	Reset to delivery settings
I1649	Hardware write protection activated
I1650	Hardware write protection deactivated
I1712	New flash file received
I1725	Sensor electronic module (ISEM) changed

Resetting the device

The entire configuration, or a part of the configuration, can be reset to a defined state here.

Navigation path

System → Device management → Device reset

Options	Description
To delivery settings	Every parameter for which a customer-specific default setting was ordered is reset to the customer-specific value. All other parameters are reset to the factory setting.
Restart device	The restart resets every parameter with data stored in volatile memory (RAM) to the factory setting (e.g. measured value data). The device configuration remains unchanged.
Restore S-DAT backup	Restore the data that is saved on the S-DAT. The data record is restored from the electronics memory to the S-DAT. Visibility depends on order options or device settings  The local display only displays this option in an alarm condition.
Create T-DAT backup	Create T-DAT backup.
Restore T-DAT backup	Restores the data saved on the T-DAT. This function can be used to resolve the memory issue "283 Memory content inconsistent" or to restore the T-DAT data when a new T-DAT has been installed. Visibility depends on order options or device settings

11 Maintenance

Maintenance tasks	88
Services	88

Maintenance tasks

The device is maintenance-free. Modifications or repairs may only be carried out following consultation with an Endress+Hauser service organization. It is recommended to examine the device regularly for corrosion, mechanical wear and damage.

Cleaning

Cleaning of surfaces not in contact with the medium

1. Recommendation: Use a lint-free cloth that is either dry or slightly dampened using water.
2. Do not use sharp objects or aggressive cleaning agents that could damage surfaces (e.g. displays, housing) and seals.
3. Do not use high-pressure steam.
4. Ensure compliance with the protection class of the device.

NOTICE

Cleaning agents can damage the surfaces!

Incorrect cleaning agents can damage the surfaces!

- ▶ Do not use cleaning agents containing concentrated mineral acids, alkalis or organic solvents e.g. benzyl alcohol, methylene chloride, xylene, concentrated glycerol cleaners or acetone.

Cleaning of surfaces in contact with the medium

Note the following for cleaning and sterilization in place (CIP/SIP):

- Use only cleaning agents to which the materials in contact with the medium are sufficiently resistant.
- Observe the permitted maximum medium temperature.

Replacement seals

The sensor's seals (particularly aseptic gasket seals) must be replaced periodically.

The replacement interval depends on:

- The frequency of the cleaning cycles
- The medium temperature
- The cleaning temperature

Replacement seals (accessory part)

Services

Endress+Hauser offers a wide range of services for device maintenance, e.g. recalibration, maintenance service or device tests.

Endress+Hauser sales organizations can provide information about the services available.

12 Disposal

Removing the device	90
Disposing of the device	90

Removing the device

1. Disconnect the device from the supply voltage.
2. Remove all connecting cables.

⚠ WARNING

Process conditions can put staff at risk!

- ▶ Wear suitable protective equipment.
- ▶ Allow the device and pipe to cool.
- ▶ Empty the device and pipe so that they are unpressurized.
- ▶ Rinse the device and pipe if necessary.

3. Remove the device correctly.

Disposing of the device

⚠ WARNING

Dangerous media can endanger staff and the environment!

- ▶ Ensure that the device and all cavities are free of medium residues that are hazardous to health or the environment, e.g. substances that have permeated into crevices or diffused through plastic.



A0042336

If required by the Directive 2012/19/EU of the European Parliament and the Council of 4 July 2012 on waste electrical and electronic equipment (WEEE), the device is marked with the depicted symbol in order to minimize the disposal of WEEE as unsorted municipal waste.

- Do not dispose of devices bearing this marking as unsorted municipal waste. Instead, return them to Endress+Hauser for disposal under the applicable conditions.
- Observe applicable federal/national regulations.
- Ensure proper separation and reuse of the device components.
- Overview of installed materials: → *Materials*, 📄 112

13 Technical data

Input	92
Output	94
Power supply	98
Cable specifications	100
Performance characteristics	101
Environment	104
Process	106
Mechanical construction	111
Local display	114
Certificates and approvals	115
Application packages	118

Input

Measured variable

Direct measured variables	<ul style="list-style-type: none"> ■ Volume flow (proportional to induced voltage) ■ Conductivity (order code for "Sensor option", option CX) ■ Temperature (DN 15 to 150 (½" to 6") with order code for "Sensor option", option CI "Medium temperature measurement")
Calculated measured variables	<p>Mass flow Corrected conductivity (DN 15 to 150 (½" to 6") with order code for "Sensor option", option CI "Medium temperature measurement" and order code for "Functionality", option D)</p>

Operable flow range

Over 1000 : 1

Measuring range

Typically $v = 0.01$ to 10 m/s (0.03 to 33 ft/s) with specified measuring accuracy

Electrical conductivity:

- ≥ 5 $\mu\text{S/cm}$ for liquids in general
- ≥ 20 $\mu\text{S/cm}$ for demineralized water

Flow characteristic values in SI units: DN 2 to 150 (½" to 6")

Nominal diameter		Recommended Flow rate min./max. full scale value ($v \sim 0.3/10$ m/s)	Full scale value current output ($v \sim 2.5$ m/s)	Factory settings	
[mm]	[in]			Pulse value (~ 2 pulse/s)	Low flow cut off ($v \sim 0.04$ m/s)
		[dm ³ /min]	[dm ³ /min]	[dm ³]	[dm ³ /min]
2	½ ₁₂	0.06 to 1.8	0.5	0.005	0.01
4	⅝ ₃₂	0.25 to 7	2	0.025	0.05
8	⅝ ₁₆	1 to 30	8	0.1	0.1
15	½	4 to 100	25	0.2	0.5
25	1	9 to 300	75	0.5	1
40	1 ½	25 to 700	200	1.5	3
50	2	35 to 1100	300	2.5	5
65	–	60 to 2000	500	5	8
80	3	90 to 3000	750	5	12
100	4	145 to 4700	1200	10	20
125	5	220 to 7500	1850	15	30
150	6	330 to 10000	2500	30	42

Flow characteristic values in US units: 1/12 - 6" (DN 2 - 150)

Nominal diameter		Recommended Flow rate min./max. full scale value (v ~ 0.3/10 m/s)	Full scale value current output (v ~ 2.5 m/s)	Factory settings	
[in]	[mm]			Pulse value (~ 2 pulse/s)	Low flow cut off (v ~ 0.04 m/s)
		[gal/min]	[gal/min]	[gal]	[gal/min]
1/12	2	0.015 to 0.5	0.1	0.001	0.002
1/32	4	0.07 to 2	0.5	0.005	0.008
5/16	8	0.25 to 8	2	0.02	0.025
1/2	15	1 to 27	6	0.05	0.1
1	25	2.5 to 80	18	0.2	0.25
1 1/2	40	7 to 190	50	0.5	0.75
2	50	10 to 300	75	0.5	1.25
3	80	24 to 800	200	2	2.5
4	100	40 to 1250	300	2	4
5	125	60 to 1950	450	5	7
6	150	90 to 2 650	600	5	12

Output

Output signal

Output versions

Order code 020: output; input	Output version
Option B	<ul style="list-style-type: none"> ■ Current output 4 to 20 mA HART ■ Pulse/frequency/switch output

Current output 4 to 20 mA ¹⁾

Signal mode	Choose via terminal assignment: <ul style="list-style-type: none"> ■ Active ■ Passive
Current range	Can be set to: <ul style="list-style-type: none"> ■ 4 to 20 mA NAMUR ■ 4 to 20 mA US ■ 4 to 20 mA ■ Fixed current
Max. output current	21.5 mA
Open-circuit voltage	DC < 28.8 V (active)
Max. input voltage	DC 30 V (passive)
Max. load	400 Ω
Resolution	1 µA
Damping	Configurable: 0 to 999.9 s
Assignable measured variables	<ul style="list-style-type: none"> ■ Off ■ Volume flow ■ Mass flow ■ Temperature* ■ Conductivity* ■ Corrected conductivity* ■ Noise* ■ Coil current shot time* <p>* Visibility depends on order options or device settings</p>

Pulse/frequency/switch output ²⁾

Function	Can be set to: <ul style="list-style-type: none"> ■ Pulse output ■ Frequency output ■ Switching output
Version	Open collector: Passive

1) Only available with Modbus RS485

2) Only available with 4 to 20 mA HART

Input values	<ul style="list-style-type: none"> ▪ DC 10.4 to 30 V ▪ Max. 140 mA
Voltage drop	<ul style="list-style-type: none"> ▪ ≤ DC 2 V @ 100 mA ▪ ≤ DC 2.5 V @ max. input current
Pulse output	
Pulse width	Configurable: 0.05 to 2 000 ms
Max. pulse rate	10 000 Impulse/s
Pulse value	Configurable
Assignable measured variables	<ul style="list-style-type: none"> ▪ Volume flow ▪ Mass flow
Frequency output	
Output frequency	Configurable: end value frequency 2 to 10 000 Hz ($f_{\max} = 12\,500$ Hz)
Damping	Configurable: 0 to 999.9 s
Pulse/pause ratio	1:1
Assignable measured variables	<ul style="list-style-type: none"> ▪ Off ▪ Volume flow ▪ Mass flow ▪ Temperature* ▪ Conductivity* ▪ Corrected conductivity* ▪ Noise* ▪ Coil current shot time* ▪ Reference electrode potential against PE* <p>* Visibility depends on order options or device settings</p>
Switch output	
Switching behavior	Binary, conductive or non-conductive
Switching delay	Configurable: 0 to 100 s

Number of switching cycles	Unlimited
Assignable functions	<ul style="list-style-type: none">■ Off■ On■ Diagnostic behavior:<ul style="list-style-type: none">■ Alarm■ Warning■ Warning and alarm■ Limit value:<ul style="list-style-type: none">■ Off■ Volume flow■ Mass flow■ Temperature*■ Flow velocity■ Conductivity*■ Corrected conductivity*■ Totalizer 1...3■ Flow direction monitoring■ Status<ul style="list-style-type: none">■ Empty pipe detection■ Low flow cut off <p>* Visibility depends on order options or device settings</p>

Signal on alarm

Output behavior in the event of a device alarm (failure mode)

HART

Device diagnostics	Device condition can be read out via HART Command 48
---------------------------	--

Current output 4 to 20 mA

4 to 20 mA	Selectable: <ul style="list-style-type: none"> ▪ Min. value: 3.59 mA ▪ Max. value: 21.5 mA ▪ Freely definable value between: 3.59 to 21.5 mA ▪ Actual value ▪ Last valid value
-------------------	---

Pulse/frequency/switch output

Pulse output	Selectable: <ul style="list-style-type: none"> ▪ Actual value ▪ No pulses
Frequency output	Selectable: <ul style="list-style-type: none"> ▪ Actual value ▪ 0 Hz ▪ Defined value: 0 to 12 500 Hz
Switch output	Selectable: <ul style="list-style-type: none"> ▪ Current status ▪ Open ▪ Closed

Low flow cut off

The switch points for low flow cut off are user-selectable.

Galvanic isolation

The outputs are galvanically isolated from one another and from earth.

Protocol-specific data

Bus structure	The HART signal is superimposed on the 4 to 20 mA current output.
Manufacturer ID	0x11
Device type ID	0x71
HART protocol revision	7
Device description files (DTM, DD)	Information and files under: www.endress.com
HART load	At least 250 Ω
System integration	Measured variables via HART protocol

Power supply

Terminal assignment

 The terminal assignment is documented on an adhesive label.

The following terminal assignment is available:

Current output 4 to 20 mA HART (active) and pulse/frequency/switch output

Supply voltage		Output 1				Output 2	
1 (+)	2 (-)	26 (+)	27 (-)	24 (+)	25 (-)	22 (+)	23 (-)
L/+	N/-	Current output 4 to 20 mA HART (active)		-		Pulse/frequency/switch output (passive)	

Current output 4 to 20 mA HART (passive) and pulse/frequency/switch output

Supply voltage		Output 1				Output 2	
1 (+)	2 (-)	26 (+)	27 (-)	24 (+)	25 (-)	22 (+)	23 (-)
L/+	N/-	-		Current output 4 to 20 mA HART (passive)		Pulse/frequency/switch output (passive)	

Supply voltage

Order code for "Power supply"	Terminal voltage		Frequency range
Option D	DC 24 V	-20 to +30 %	-
Option E	AC 100 to 240 V	-15 to +10 %	50/60 Hz, ±5 Hz
Option I	DC 24 V	-20 to +30 %	-
	AC 100 to 240 V	-15 to +10 %	50/60 Hz, ±5 Hz
Option M non-hazardous area	DC 24 V	-20 to +30 %	-
	AC 100 to 240 V	-15 to +10 %	50/60 Hz, ±5 Hz

Power consumption

- Transmitter:
HART, Modbus RS485: Max. 10 W (active power)
- Switch-on current:
HART, Modbus RS485: Max. 36 A (< 5 ms) as per NAMUR Recommendation NE 21

Current consumption

- Max. 400 mA (24 V)
- Max. 200 mA (110 V, 50/60 Hz; 230 V, 50/60 Hz)

Power supply failure

- Totalizers stop at the last value measured.
- Device configuration remains unchanged.
- Error messages (incl. total operated hours) are stored.

Terminals

Spring terminals

- Suitable for strands and strands with ferrules.
- Conductor cross-section 0.2 to 2.5 mm² (24 to 12 AWG).

Cable entries

- Cable gland: M20 × 1.5 for cable Ø6 to 12 mm (0.24 to 0.47 in)
- Thread for cable entry:
 - NPT ½"
 - G ½", G ½" Ex d
 - M20

Overvoltage protection

Mains voltage fluctuations	→ <i>Supply voltage</i> , 98
Overvoltage category	Overvoltage category II
Short-term, temporary overvoltage	Between cable and neutral conductor up to 1200 V for max. 5s
Long-term, temporary overvoltage	Up to 500 V between cable and ground

Cable specifications

Requirements for connecting cable

Electrical safety

As per applicable national regulations.

Permitted temperature range

- Observe the installation guidelines that apply in the country of installation.
- The cables must be suitable for the minimum temperatures and maximum temperatures to be expected.

Power supply cable (incl. conductor for the inner ground terminal)

- A standard installation cable is sufficient.
- Provide grounding according to applicable national codes and regulations.

Signal cable

- Current output 4 to 20 mA HART:
A shielded cable is recommended, observe the grounding concept of the facility.
- Pulse/frequency/switch output:
Standard installation cable

Ground cable requirements

Copper wire: at least 6 mm² (0.0093 in²)

Connecting cable requirements

 Connecting cable only necessary for remote version.

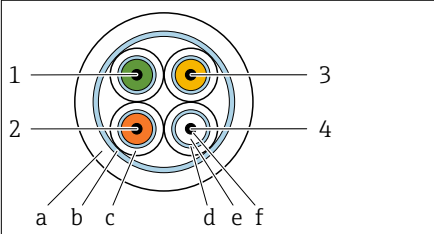
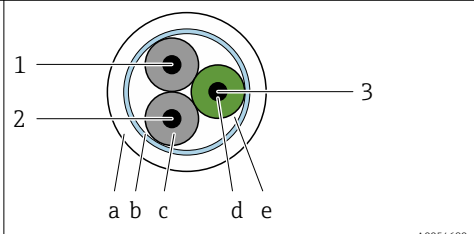
Electrode cable	Coil current cable
 <p style="text-align: right; font-size: small;">A0054679</p> <p>1 GND (green): Ground-wire 0.38 mm²(AWG 21)</p> <p>2 E1 (brown): "Electrode E1" - core 0.38 mm²(AWG 21)</p> <p>3 E (yellow): grounding 0.38 mm² (AWG 21)</p> <p>4 E2 (white): "Electrode E2"- core 0.38 mm² (AWG 21)</p> <p>a Outer jacket</p> <p>b Cable shield</p> <p>c Core jacket</p> <p>d Core shield</p> <p>e Core insulation</p> <p>f Core</p>	 <p style="text-align: right; font-size: small;">A0054680</p> <p>1 ER+ (black): coil current core 0.75 mm² (AWG 18)</p> <p>2 ER- (black): coil current core 0.75 mm² (AWG 18)</p> <p>3 NC (yellow-green): not connected 0.75 mm² (AWG 18)</p> <p>a Outer jacket</p> <p>b Cable shield</p> <p>c Core insulation</p> <p>d Core</p> <p>e Core reinforcement</p>

Electrode cable

Design	3×0.38 mm ² (21 AWG) with common, braided copper shield (∅ ~ 9.5 mm (0.37 in)) and individual shielded cores If using the empty pipe detection (EPD) function: 4×0.38 mm ² (21 AWG) with common, braided copper shield (∅ ~ 9.5 mm (0.37 in)) and individual shielded cores
Conductor resistance	≤ 50 Ω/km (0.015 Ω/ft)
Capacitance: core/shield	≤ 420 pF/m (128 pF/ft)
Cable length	Depends on the medium conductivity: maximum 200 m (656 ft)
Cable lengths (available for order)	5 m (15 ft), 10 m (30 ft), 20 m (60 ft) or variable length: maximum 200 m (656 ft)
Operating temperature	-20 to +80 °C (-4 to +176 °F)

Coil current cable

Design	3×0.75 mm ² (18 AWG) with common, braided copper shield (∅ ~ 9.5 mm (0.37 in)) and individual shielded cores
Conductor resistance	≤ 37 Ω/km (0.011 Ω/ft)
Capacitance: core/shield	≤ 120 pF/m (37 pF/ft)
Cable length	Depends on the medium conductivity, max. 200 m (656 ft)
Cable lengths (available for order)	5 m (15 ft), 10 m (30 ft), 20 m (60 ft) or variable length up to max. 200 m (656 ft)
Operating temperature	-20 to +80 °C (-4 to +176 °F)
Test voltage for cable insulation	≤ AC 1 433 V rms 50/60 Hz or ≥ DC 2 026 V

Performance characteristics

Reference operating conditions

- Error limits based on ISO 20456:2017
- Water, typically: +15 to +45 °C (+59 to +113 °F); 0.5 to 7 bar (73 to 101 psi)
- Data as indicated in the calibration protocol
- Accuracy based on accredited calibration rigs according to ISO 17025
- Reference temperature for conductivity measurement: 25 °C (77 °F)

 To obtain measured errors, use the *Applicator* sizing tool → *Service-specific accessory*, 161

Maximum measurement error

o. r. = of reading

Maximum permissible error under reference operating conditions

Volume flow

- ±0.5 % o. r. ±1 mm/s (±0.04 in/s)
- Optional: ±0.2 % o. r. ± 2 mm/s (0.08 in/s)

 Fluctuations in the supply voltage have no effect within the specified range.

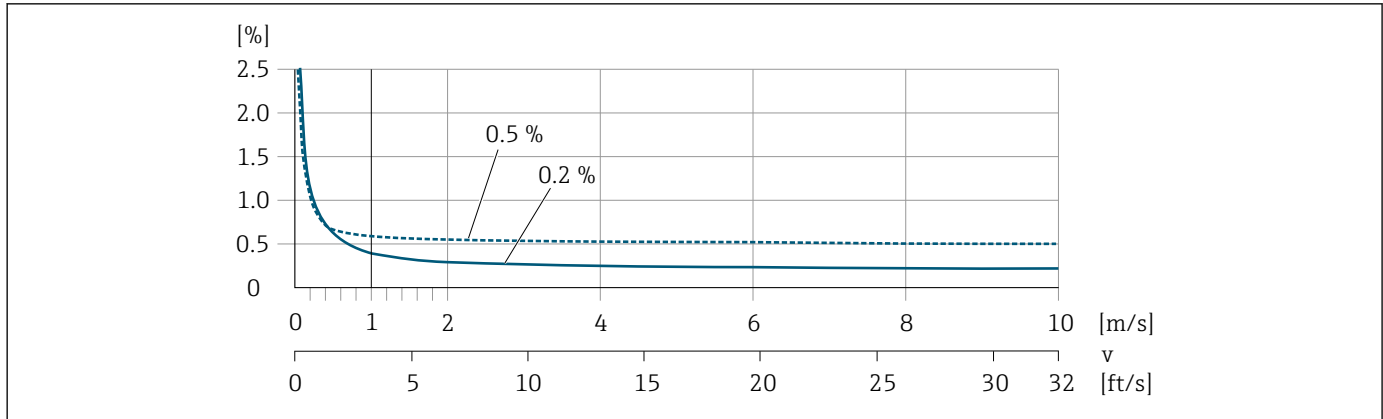

A0028974

9 Maximum measurement error in % o.r.

Temperature

±3 °C (±5.4 °F)

Electrical conductivity

Order code for "Conductivity measurement", option CX

The values apply for:

- Measurements at a reference temperature of +25 °C (+77 °F).
If the temperature differs, the temperature coefficient of the medium must be taken into account (typically 2.1%/K).
- Device version: compact (transmitter and sensor form a mechanical unit)
- Devices in a metal pipe or in a non-metal pipe with installed ground disks.
- Devices whose potential equalization has been established according to the specifications in the related Operating Instructions.

Conductivity [μS/cm]	Measurement error [%] o. r.
5 to 20	± 20%
20 to 20000	± 10%
20 000 to 100 000	± 20%

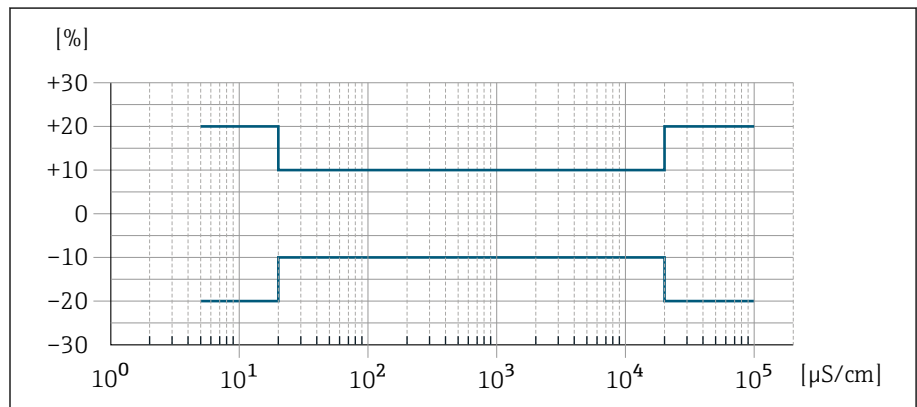

A0042279

10 Measurement error for order code "Conductivity measurement", option CX

Accuracy of outputs

Current output	$\pm 5 \mu\text{A}$
Pulse/frequency output	Max. ± 100 ppm o. r. (across the entire ambient temperature range)

Repeatability

Volume flow	Max. ± 0.1 % o. r. ± 0.5 mm/s (0.02 in/s)
Electrical conductivity	<ul style="list-style-type: none"> ■ Max. ± 5 % o. r. (5 to 100 000 $\mu\text{S}/\text{cm}$) ■ Max. ± 1 % o. r. for DN 15 to 150 in conjunction with stainless steel process connections, 1.4404 (F316L)
Temperature	± 0.5 °C (± 0.9 °F)

Temperature measurement response time

$T_{90} < 15$ s



Influence of ambient temperature

Current output	Temperature coefficient max. $1 \mu\text{A}/^\circ\text{C}$
Pulse/frequency output	No additional effect. Is included in the accuracy.

Environment

Ambient temperature range

Transmitter	-40 to +60 °C (-40 to +140 °F)
Local display	-20 to +60 °C (-4 to +140 °F) The readability of the display may be impaired at temperatures outside the temperature range.
Sensor	-40 to +60 °C (-40 to +140 °F)
Liner	Do not exceed or fall below the permitted temperature range of the liner → <i>Medium temperature range</i> ,  106.

 Dependency of ambient temperature on medium temperature → *Medium temperature range*,  106

Storage temperature

The storage temperature corresponds to the ambient temperature range of the transmitter and sensor.

Relative humidity

The device is suitable for use in outdoor and indoor areas with a relative humidity of 5 to 95%.

Operating height

According to EN 61010-1

- Without overvoltage protection: ≤ 2 000 m
- With overvoltage protection: > 2 000 m (e.g. Endress+Hauser HAW series)

Degree of protection

Transmitter	<ul style="list-style-type: none"> ▪ IP66/67, Type 4X enclosure, suitable for pollution degree 4 ▪ Open housing: IP20, Type 1 enclosure, suitable for pollution degree 2
Sensor	IP66/67, Type 4X enclosure, suitable for pollution degree 4

Vibration resistance and shock resistance

Compact version

Vibration, sinusoidal Following IEC 60068-2-6	2 to 8.4 Hz	3.5 mm peak
	8.4 to 2 000 Hz	1 g peak
Vibration, broad-band random Following IEC 60068-2-64	10 to 200 Hz	0.003 g ² /Hz
	200 to 2 000 Hz	0.001 g ² /Hz (1.54 g rms)
Shocks, half-sine Following IEC 60068-2-27	6 ms 30 g	

Shock

Due to rough handling similar to IEC 60068-2-31.

Remote version (sensor)

Vibration, sinusoidal Following IEC 60068-2-6	2 to 8.4 Hz	7.5 mm peak
	8.4 to 2 000 Hz	2 g peak
Vibration, broad-band random Following IEC 60068-2-6	10 to 200 Hz	0.01 g ² /Hz
	200 to 2 000 Hz	0.003 g ² /Hz (2.7 g rms)
Shocks, half-sine Following IEC 60068-2-6	6 ms 50 g	

Shock

Due to rough handling similar to IEC 60068-2-31.

Electromagnetic compatibility (EMC)

As per IEC/EN 61326 and
NAMUR Recommendation NE 21



For more information: Declaration of Conformity

Process

Medium temperature range

-20 to +150 °C (-4 to +302 °F)

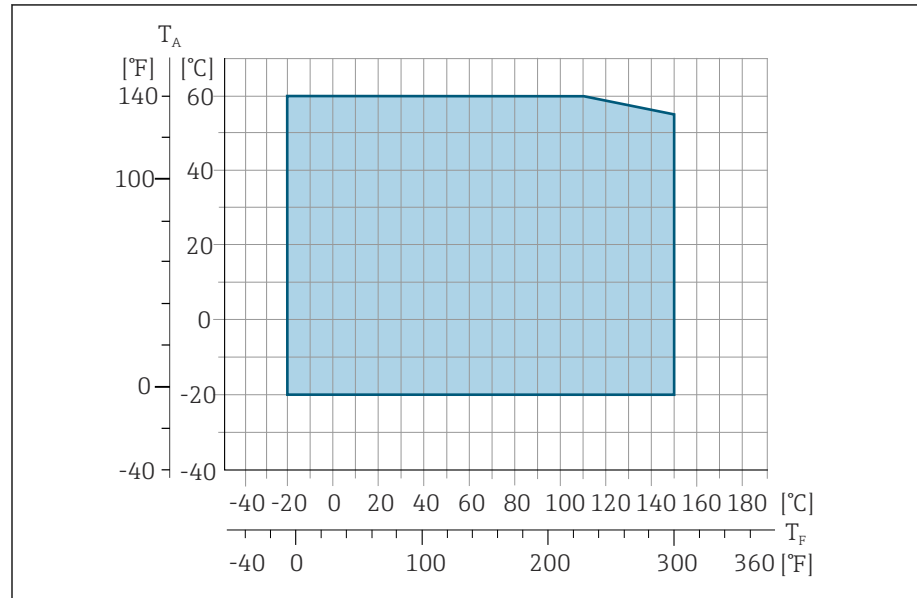

A0027450

T_A Ambient temperature

T_F Medium temperature

Conductivity

The minimum conductivity is:

- 5 $\mu\text{S}/\text{cm}$ for liquids in general
- 20 $\mu\text{S}/\text{cm}$ for demineralized water

The following basic conditions must be observed for < 20 $\mu\text{S}/\text{cm}$:

- Order code 013 for "Functionality", option D "Extended transmitter" and higher output signal damping is recommended for values under 20 $\mu\text{S}/\text{cm}$.
- Observe the maximum permitted cable length L_{max} . This length is determined by the conductivity of the medium.
- With order code 013 "Functionality", option A "Standard transmitter" and empty pipe detection (EPD) switched on, the minimum conductivity is 20 $\mu\text{S}/\text{cm}$.
- With order code 013 "Functionality", option A "Standard transmitter" - remote version, empty pipe detection may not be activated if $L_{\text{max}} > 20$ m.



Note that in the case of the remote version, the minimum conductivity depends on the cable length.

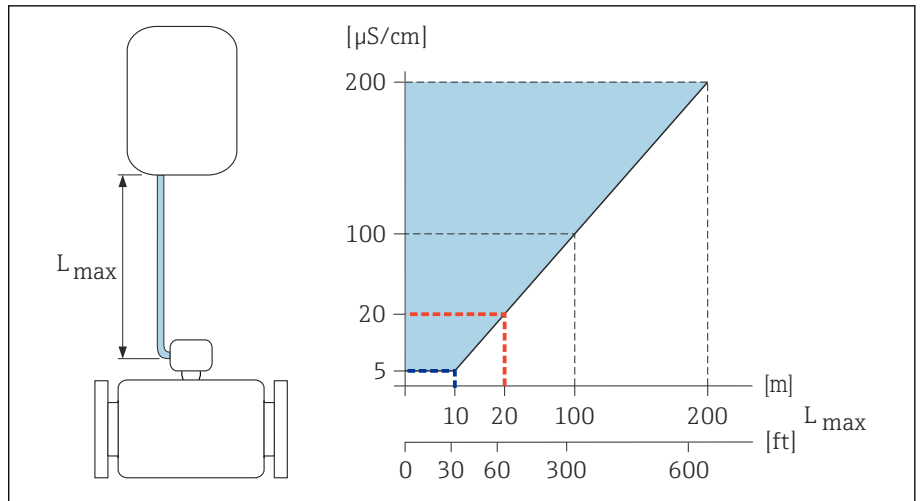

A0047485

11 Permitted length of connecting cable

Colored area = permitted range
 L_{max} = length of connecting cable in [m] ([ft])
 [μS/cm] = medium conductivity
 Red line = order code 013 "Functionality", option A "Standard transmitter"
 Blue line = order code 013 "Functionality", option D "Extended transmitter"

Flow limit

Pipe diameter and flow rate determine the nominal diameter of the sensor.

- i** The flow velocity is increased by reducing the sensor nominal diameter.
- In the case of media with a high solids content, a sensor with a nominal diameter > DN 8 (3/8") can improve the signal stability and cleanability due to the larger electrodes.

2 to 3 m/s (6.56 to 9.84 ft/s)	Optimum flow velocity
$v < 2$ m/s (6.56 ft/s)	For low conductivity values
$v > 2$ m/s (6.56 ft/s)	For media producing buildup, e.g. high-fat milk

Pressure/temperature ratings

Maximum permitted medium pressure as a function of the medium temperature.

The data relate to all pressure-bearing parts of the device.

Process connections with O-ring seal, DN 2 to 25 (1/12 to 1")

Maximum permitted medium pressure as a function of the medium temperature.

The data relate to all pressure-bearing parts of the device.

Fixed flange similar to EN 1092-1

Stainless steel

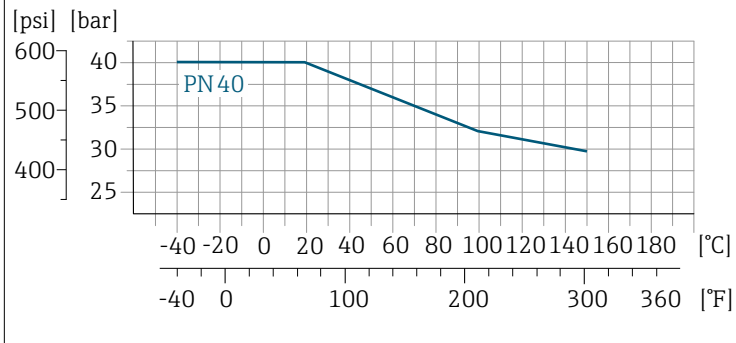

A0028928-EN

Fixed flange similar to ASME B16.5

Stainless steel

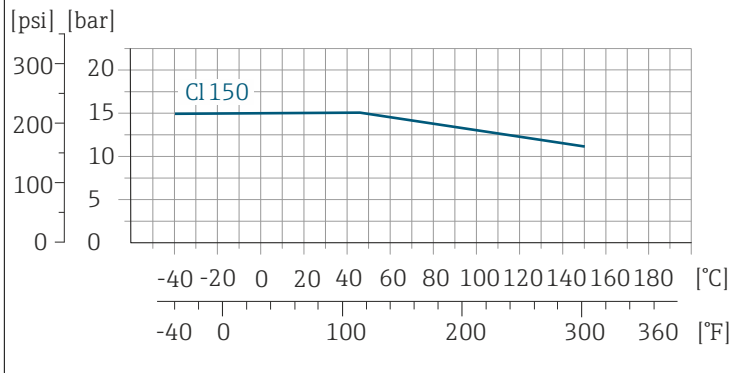

A0028936-EN

Fixed flange similar to JIS B2220

Stainless steel

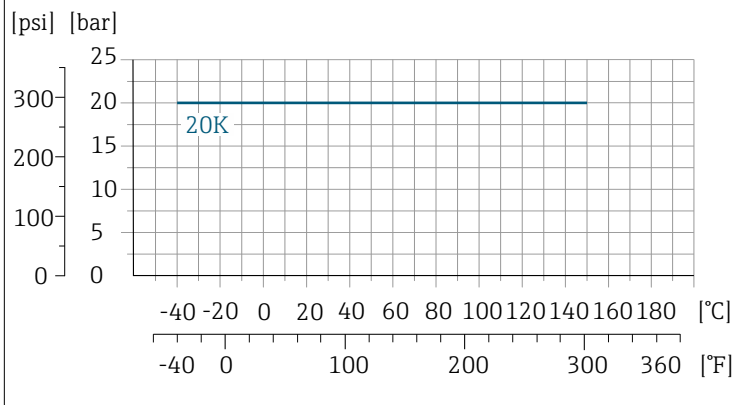

A0028938-EN

Coupling similar to ISO 288/DIN 2999, NPT
Welding socket similar to DIN EN ISO 1127, ISO 2037

Stainless steel

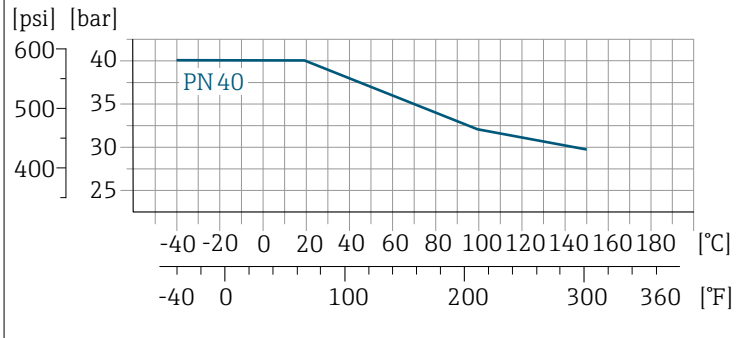

A0028928-EN

Process connections with aseptic gasket seal, DN 2 to 25 (1/12 to 1")

Welding socket similar to EN 10357 (DIN 11850)
Thread similar to DIN 11851
Thread similar to DIN 11864-1
Flange DIN 11864-2 Form

Stainless steel

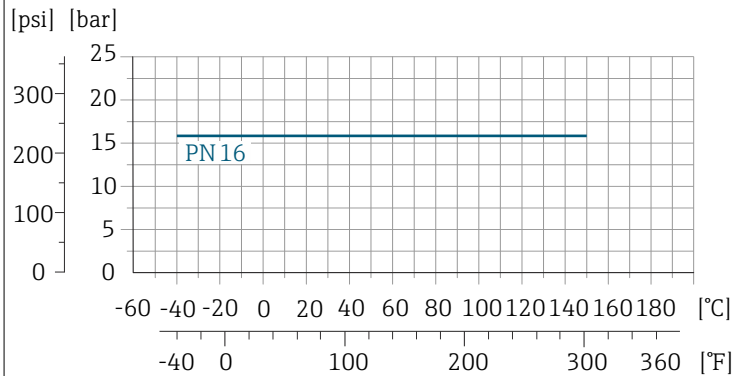

A0028940-EN

Process connections with aseptic gasket seal, DN 40 to 150 (1 1/2 to 6")

Welding socket similar to ASME BPE
Welding socket similar to EN 10357 (DIN 11850)
Welding socket similar to ISO 2037
Thread similar to DIN 11851

Stainless steel

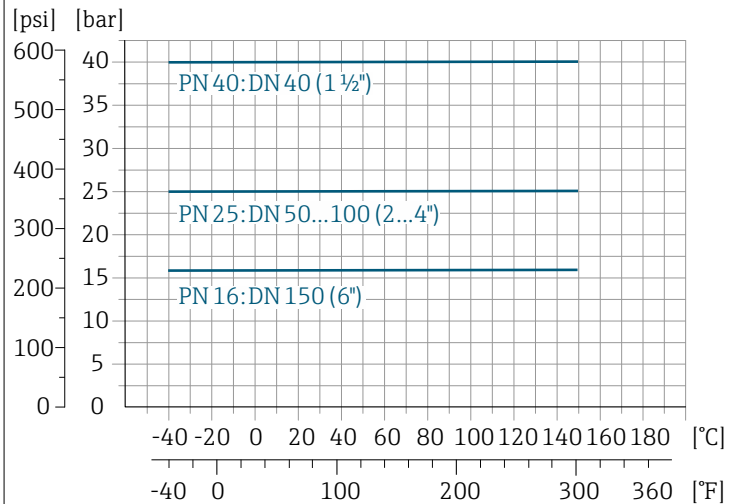

A0028942-EN

**Flange DIN 11864-2 Form A, flange with notch
Thread similar to DIN 11864-1**

Stainless steel

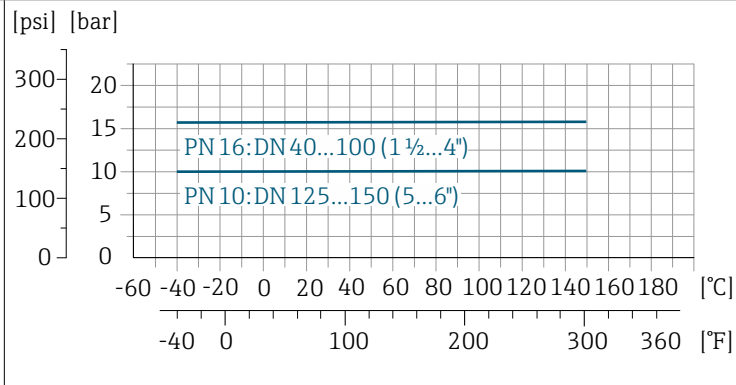

A0028943-EN

Tri-Clamp

Stainless steel

The clamp connections are suitable up to a maximum pressure of 16 bar (232 psi). Please observe the operating limits of the clamp and seal used as they can be over 16 bar (232 psi). The clamp and seal are not included in the scope of supply.

Pressure tightness

Limit values for the absolute pressure depending on the liner and medium temperature

PFA	Nominal diameter		Absolute pressure in [mbar] ([psi])				
	[mm]	[in]	+25 °C (+77 °F)	+80 °C (+176 °F)	+100 °C (+212 °F)	+130 °C (+266 °F)	+150 °C (+302 °F)
	2 to 150	1/12 to 6	0 (0)	0 (0)	0 (0)	0 (0)	0 (0)

Pressure loss

- No pressure loss: as of DN 8 (5/16"), with transmitter installed in a pipe with the same nominal diameter.
- Pressure loss information when adapters are used → *Adapters*, 31

Mechanical construction

Weight

All values refer to devices with flanges with a standard pressure rating. Weight data are guideline values. The weight may be lower than indicated depending on the pressure rating and design.

Transmitter remote version

- Polycarbonate: 1.4 kg (3.1 lbs)
- Aluminum: 2.4 kg (5.3 lbs)

Sensor remote version

Aluminum sensor connection housing: see the information in the following table.

Nominal diameter		Weight	
[mm]	[in]	[kg]	[lbs]
2	1/12	4.7	10.4
4	5/32	4.7	10.4
8	5/16	4.7	10.4
15	½	4.6	10.1
25	1	5.5	12.1
40	1 ½	6.8	15.0
50	2	7.3	16.1
65	–	8.1	17.9
80	3	8.7	19.2
100	4	10.0	22.1
125	5	15.4	34.0
150	6	17.8	39.3

Measuring tube specification

Nominal diameter		Pressure rating ¹⁾ EN (DIN) [bar]	Process connection internal diameter	
[mm]	[in]		PFA [mm]	[in]
2	1/12	PN 16/40	2.25	0.09
4	5/32	PN 16/40	4.5	0.18
8	5/16	PN 16/40	9.0	0.35
15	½	PN 16/40	16.0	0.63
–	1	PN 16/40	22.6	0.89
25	–	PN 16/40	26.0	1.02
40	1 ½	PN 16/25/40	34.8	1.37
50	2	PN 16/25	47.5	1.87
65	–	PN 16/25	60.2	2.37
80	3	PN 16/25	72.9	2.87
100	4	PN 16/25	97.4	3.83

Nominal diameter		Pressure rating ¹⁾ EN (DIN) [bar]	Process connection internal diameter	
[mm]	[in]		PFA	
			[mm]	[in]
125	5	PN 10/16	120.0	4.72
150	6	PN 10/16	146.9	5.78

1) Depending on process connection and seals used

Materials

Transmitter housing

Order code for "Housing"	<ul style="list-style-type: none"> ■ Option A: Compact, coated aluminum ■ Option B: Compact, coated aluminum + polycarbonate inspection window ■ Option M: Compact, polycarbonate ■ Option N: Remote, polycarbonate ■ Option P: Remote, aluminum, coated ■ Option T: Remote, aluminum, coated + polycarbonate inspection window
Window material	<ul style="list-style-type: none"> ■ Order code for "Housing", option A: glass ■ Order code for "Housing", option G: polycarbonate ■ Order code for "Housing", option M: polycarbonate ■ Order code for "Housing", option N: polycarbonate ■ Order code for "Housing", option P: glass ■ Order code for "Housing", option T: polycarbonate
Neck adapter	Order code for "Housing", option A, G and M: Aluminum, coated

Sensor connection housing

Stainless steel 1.4301 (304)

Cable glands and entries

Cable gland M20×1.5	Plastic
Adapter for cable entry with internal thread G ½" or NPT ½"	Nickel-plated brass
M12 plug-in connector	Stainless steel 1.4301 (304)

Connecting cable for remote version

Electrode and coil current cable:
PVC cable with copper shield

Sensor housing

Stainless steel: 1.4301 (304)

Measuring tubes

Stainless steel: 1.4301 (304)

Liner

PFA

Electrodes	
	<ul style="list-style-type: none"> ▪ Stainless steel: 1.4435 (316L) ▪ Alloy C22: 2.4602 (UNS N06022)
Seals	
	<ul style="list-style-type: none"> ▪ O-ring seal, DN 2 to 25 (1/12 to 1"): EPDM, FKM, Kalrez ▪ Aseptic (hygienic design) gasket seal, DN 2 to 150 (1/12 to 6"): EPDM, FKM, VMQ (silicone)
Process connections	
	Stainless steel, 1.4404 (F316L)
Centering star	
	Stainless steel 1.4435 (316L)
Accessories	
Weather protection cover	Stainless steel, 1.4404 (316L)
Pipe mounting kit (welding jig)	Stainless steel 1.4301 (304)
Wall mounting kit	Stainless steel, 1.4404 (316L) Does not meet the hygienic design installation guidelines.

Fitted electrodes

Standard electrodes:

- Measuring electrodes
- Empty pipe detection electrode (only DN 15 to 150 (½ to 6"))

Surface roughness

Data relates to surfaces in contact with the medium.

Stainless steel electrodes, 1.4435 (316L); Alloy C22, 2.4602 (UNS N06022):
 ≤ 0.3 to $0.5 \mu\text{m}$ (11.8 to 19.7 μin)

Liner with PFA:

$\leq 0.4 \mu\text{m}$ (15.7 μin)

Stainless steel process connections:

- With O-ring seal: $R_a \leq 1.6 \mu\text{m}$ (63 μin)
- With aseptic seal: $R_{a\text{max}} = 0.76 \mu\text{m}$ (30 μin),

Local display

Operation concept

Operation method	Operation via local display with touchscreen ¹⁾ Operation via: <ul style="list-style-type: none"> ▪ SmartBlue app ²⁾ ▪ Commubox FXA291
Reliable operation	<ul style="list-style-type: none"> ▪ Operation in local language ▪ Uniform operating philosophy in device and in the SmartBlue App ▪ Write protection ▪ When electronics modules are replaced: configurations are transferred using the T-DAT Backup device memory. The device memory contains process data, device data and the event logbook. No reconfiguration is necessary.
Diagnostic behavior	Efficient diagnostic behavior increases measurement availability: <ul style="list-style-type: none"> ▪ Open remedial actions via local display and SmartBlue app ▪ Diverse simulation options ▪ Logbook of events that have occurred

1) Only for HART and Modbus RS485 communication protocols

2) Optional via order code "Display; operation", options H, J or K

Operation options

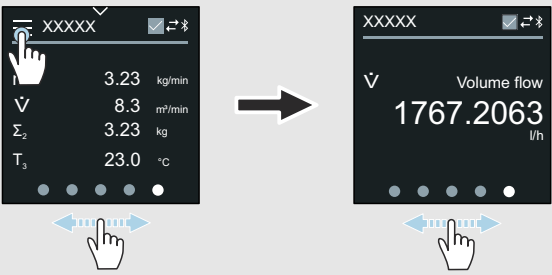
Local display	 <p>12 Only for HART and Modbus RS485 communication protocols</p> <p>Display elements:</p> <ul style="list-style-type: none"> ▪ LCD touch screen ¹⁾ ▪ Depends on the orientation, automatic alignment of the local display ▪ Configuration of display format for measured variables and status variables <p>Operating elements:</p> <ul style="list-style-type: none"> ▪ Touch screen ¹⁾ ▪ Local display can also be accessed in the hazardous area
SmartBlue app	<ul style="list-style-type: none"> ▪ The SmartBlue app allows the user to put devices into operation and operate them. ▪ Based on Bluetooth ▪ No separate driver required ▪ Available for mobile handheld terminals, tablets and smartphones ▪ Suitable for convenient and secure access to devices in hard-to-reach locations or in hazardous areas ▪ Can be used within a 20 m (65.6 ft) radius of the device ▪ Encrypted and secure data transmission ▪ No data loss during commissioning and maintenance ▪ Diagnostic information and process information in real time

1) Only for HART and Modbus RS485 communication protocols

Operating tools

Operating tools	Operating unit	Interface	Additional information
DeviceCare SFE100	<ul style="list-style-type: none"> ▪ Notebook ▪ PC ▪ Tablet with Microsoft Windows system 	<ul style="list-style-type: none"> ▪ CDI service interface ▪ Fieldbus protocol 	Innovation brochure IN01047S
FieldCare SFE500	<ul style="list-style-type: none"> ▪ Notebook ▪ PC ▪ Tablet with Microsoft Windows system 	<ul style="list-style-type: none"> ▪ CDI service interface ▪ Fieldbus protocol 	Operating Instructions BA00027S and BA00059S
SmartBlue app	<ul style="list-style-type: none"> ▪ Devices with iOS: iOS9.0 or higher ▪ Devices with Android: Android 4.4 KitKat or higher 	Bluetooth	Endress+HauserSmartBlue App: <ul style="list-style-type: none"> ▪ Google Playstore (Android) ▪ iTunes Apple Shop (iOS devices)
Device Xpert	Field Xpert SFX 100/350/370	HART fieldbus protocol	Operating Instructions BA01202S

Certificates and approvals

Non-Ex approval

- cCSAus
- EAC
- UKCA

Pressure Equipment Directive

- CRN
- PED Cat. II/III
- PESR Cat. II/III

Sanitary compatibility

- 3-A approval
 - Confirmation by affixing the 3-A symbol for measuring instruments with the order code for "Additional approval", option LP "3-A".
 - When installing the measuring instrument, ensure that no liquid can accumulate on the outside of the measuring instrument. Remote transmitters must be installed in accordance with the 3-A Standard.
 - Accessories (e.g. weather protection cover, pipe mounting kit) must be installed in accordance with the 3-A Standard. Each accessory can be cleaned. Disassembly may be necessary under certain circumstances.
- EHEDG-certified (Type EL Class I)
 - Confirmation by affixing the EHEDG symbol for measuring instruments with the order code for "Additional approval", option LT "EHEDG".
 - EPDM is not a suitable seal material for media with a fat content > 8%.
 - To meet the requirements for EHEDG certification, the device must be used with process connections in accordance with the EHEDG position paper entitled "Easy cleanable Pipe couplings and Process connections" (www.ehedg.org).
 - To meet the requirements for EHEDG certification, the orientation of the device must ensure drainability.
 - The EHEDG cleanability test requires a flow velocity of 1.5 m/s in the process line. This velocity must be ensured for EHEDG-compliant cleaning.
- Food Contact Materials Regulation (EC) 1935/2004
A declaration for a specific serial number that confirms compliance with the requirements of (EC) 1935/2004 is only generated for measuring instruments with the order code for "Test, certificate", option J1 "EU Food Contact Materials (EC) 1935/2004".
- FDA 21 CFR 177.1550
A declaration for a specific serial number that confirms compliance with FDA requirements is only generated for measuring instruments with the order code for "Test, certificate", option J2 "US Food Contact Materials FDA CFR 21".
- Food Contact Materials Regulation GB 4806
A declaration for a specific serial number that confirms compliance with the requirements of GB 4806 is only generated for measuring instruments with the order code for "Test, certificate", option J3 "CN Food Contact Materials GB 4806".
- The requirements of the Food Contact Material regulations must be observed when selecting the material versions.
- Seals
FDA-compliant (except Kalrez seals)

 Please refer to the applicable Declaration of Conformity for binding information regarding the applicable conformities.

Pharmaceutical compatibility

- USP <87>
- USP <88> Class VI 121 °C
- TSE/BSE Certificate of Suitability
- cGMP
Devices with the order code for "Test, certificate", option JG "Conformity with cGMP-derived requirements, declaration" comply with the requirements of cGMP with regard to the surfaces of parts in contact with the medium, design, material conformity, USP Class VI tests and TSE/BSE conformity.
A serial number-specific declaration is generated.

 Please refer to the applicable Declaration of Conformity for binding information regarding the applicable conformities.

HART certification

The device is certified and registered by the FieldComm Group. The measuring system meets all the requirements of the following specifications:

- Certified according to HART 7
- The device can also be operated with certified devices of other manufacturers (interoperability).

Radio approval

The device has radio approvals.

Additional certification

- CRN approval
Some device versions have a CRN approval. A CRN-approved process connection with a CSA approval must be ordered for a CRN-approved device.
- EN10204-3.1 material certificate, wetted parts and sensor housing (order code for "Test, certificate", option JA)
- Pressure test, internal process, test report (order code for "Test, certificate", option JB)
- Surface roughness test ISO4287/Ra, (wetted parts), test report (option JE)
- Compliance with requirements derived from cGMP, Declaration (option JG)

External standards and guidelines

- IEC/EN 60529
Degrees of protection provided by enclosure (IP code)
- IEC/EN 60068-2-6
Environmental influences: Test procedure - Test Fc: vibration (sinusoidal)
- IEC/EN 60068-2-31
Environmental influences: Test procedure - Test Ec: shocks due to rough handling, primarily for devices.
- IEC/EN 61010-1
Safety requirements for electrical equipment for measurement, control and laboratory use - general requirements.
- GB 30439.5
Safety requirements for industrial automation products - Part 5: Flowmeter safety requirements
- CAN/CSA-C22.2 No. 61010-1-12
Safety Requirements for Electrical Equipment for Measurement, Control and Laboratory Use - Part 1 General Requirements.
- IEC/EN 61326
Emission in accordance with Class A requirements; Electromagnetic compatibility (EMC requirements)
- ANSI/ISA-61010-1 (82.02.01)
Safety Requirements for Electrical Equipment for Measurement, Control and Laboratory Use - Part 1 General Requirements.
- NAMUR NE 21
Electromagnetic compatibility (EMC) of industrial process and laboratory control equipment.
- NAMUR NE 32
Data retention in the event of a power failure in field and control instruments with microprocessors.
- NAMUR NE 43
Standardization of the signal level for the breakdown information of digital transmitters with analog output signal.

- NAMUR NE 53
Software of field devices and signal-processing devices with digital electronics.
- NAMUR NE 105
Specifications for integrating fieldbus devices in engineering tools for field devices.
- NAMUR NE 107
Self-monitoring and diagnosis of field devices.
- NAMUR NE 131
Requirements for field devices for standard applications.
- ETSI EN 300 328
Guidelines for 2.4 GHz radio components
- EN 301489
Electromagnetic compatibility and radio spectrum matters (ERM).

Application packages

Use

Many different application packages are available to enhance the functionality of the device. Such packages might be needed to address safety aspects or specific application requirements.

The application packages can be ordered with the device or subsequently from Endress+Hauser. Detailed information on the relevant order code is available from your local Endress+Hauser sales organization or on the product page of the Endress+Hauser website: www.endress.com.

Heartbeat Verification + Monitoring

Heartbeat Verification

Availability depends on the product structure.

Meets the requirement for traceable verification according to DIN ISO 9001:2015 Clause 7.6 a) "Control of monitoring and measuring equipment":

- Functional testing in the installed state without interrupting the process.
- Traceable verification results on request, including report.
- Simple testing process with local operation or other operating interfaces.
- Clear measuring point assessment (pass/fail) with high total test coverage within the framework of manufacturer specifications.
- Extension of calibration intervals according to operator's risk evaluation.

Heartbeat Monitoring

Availability depends on the product structure.

Heartbeat Monitoring continuously provides data characteristic of the measuring principle to an external condition monitoring system, facilitating preventive maintenance or process analysis. This data enables the operator to:

- Draw conclusions - using this data and other information - about the measuring performance over time.
- Schedule servicing in time.
- Monitor the process quality or product quality .

High-speed filling <5s

Availability depends on the selected product structure.

The "High-speed filling <5s" option is for customers with fast filling/dosing applications with a start/stop time (batch) of less than 5 seconds.

With this option, the following parameters are automatically set during production:

- Measuring period: 20 ms (factory setting: 60 ms)
- Integration time: 5 ms (factory setting: 20 ms)
- Filter setting: binominal filter (factory setting: dynamic flow)
- Pulse settings: Pulse width 0.1 ms, Value per pulse 1 ml (0.0338 fl oz)
- Median: 0
- Damping: 0

A minimum conductivity of $\geq 50 \mu\text{S}/\text{cm}$ is required for high-speed filling applications.

Application examples include:

High-speed dosing applications (batches) with high repeatability requirements (e.g.: sack filling, other filling applications)

14 Dimensions in SI units

Compact version	122
Order code for "Housing", option A and G "Aluminum, coated"	122
Order code for "Housing", option M "Compact, polycarbonate"	123
Remote version	124
Transmitter remote version	124
Sensor remote version	125
Sensor flange connection	126
Flange connections	128
Flange DIN 11864-2 Form A, flange with groove	128
Flange DIN 11864-2 Form A, flange with notch	128
Flange similar to EN 1092-1 (DIN 2501/DIN 2512N): PN 40	129
Flange similar to ASME B16.5, Class 150	130
Flange according to JIS B2220, 20K	130
Clamp connections	131
Tri-Clamp	131
Welding nipple	132
Welding socket similar to EN 10357	132
Welding nipple similar to ISO 1127	132
Welding nipple similar to ISO 2037	132
Welding nipple similar to ASME BPE	134
Couplings	135
Threaded coupling similar to DIN 11851	135
Threaded hygienic connection similar to DIN 11864-1, Form A	136
Thread similar to SMS 1145	136
External thread similar to ISO 228/DIN 2999	137
Mounting kit	138
Wall mounting kit	138
Accessories	139
Grounding rings	139
Spacer	139
Male thread with O-ring seal	140
Female thread with O-ring seal	140
Tri-Clamp	141
Weather protection cover	141

Compact version

Order code for "Housing", option A and G "Aluminum, coated"

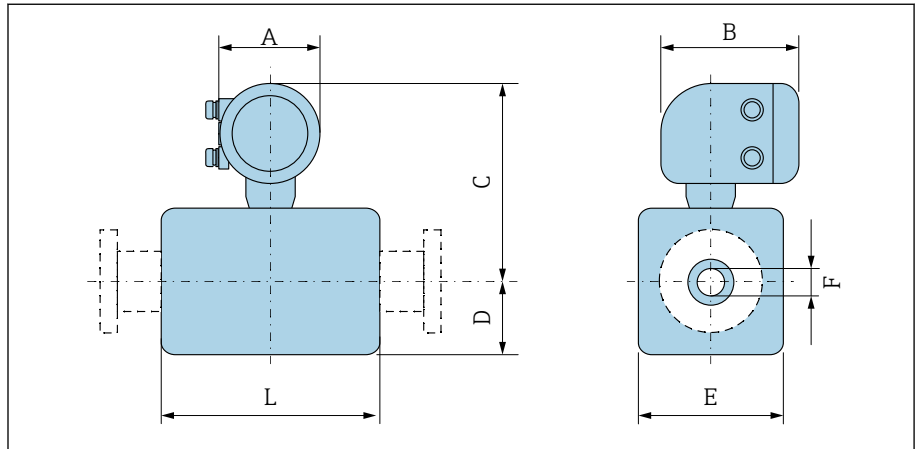

A0043172

DN		A ¹⁾	B	C	D	E	F	L ²⁾
[mm]	[in]	[mm]	[mm]	[mm]	[mm]	[mm]	[mm]	[mm]
2	1/12	139	178	235	48	43	2.25	86
4	1/32	139	178	235	48	43	4.5	86
8	5/16	139	178	235	48	43	9	86
15	1/2	139	178	235	48	43	16	86
-	1	139	178	239	52	56	22.6	86
25	-	139	178	239	52	56	26.0	86
40	1 1/2	139	178	242	54	107	34.8	140
50	2	139	178	249	60	120	47.5	140
65	-	139	178	256	68	135	60.2	140
80	3	139	178	263	74	148	72.9	140
100	4	139	178	276	87	174	97.4	140
125	-	139	178	292	103	206	120.0	200
150	6	139	178	306	117	234	146.9	200

- 1) Depending on the cable gland used; values up to + 30 mm
- 2) Total length depends on the process connections.

Order code for "Housing", option M "Compact, polycarbonate"

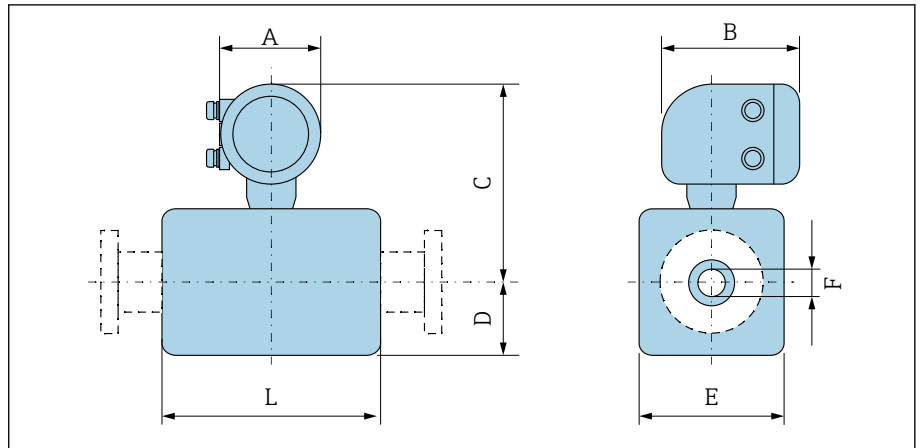

A0043172

DN		A ¹⁾	B	C	D	E	F	L ²⁾
[mm]	[in]	[mm]	[mm]	[mm]	[mm]	[mm]	[mm]	[mm]
2	1/12	132	172	232	55	43	2.25	86
4	1/32	132	172	232	55	43	4.5	86
8	5/16	132	172	232	55	43	9	86
15	1/2	132	172	232	55	43	16	86
-	1	132	172	237	55	56	22.6	86
25	-	132	172	237	55	56	26.0	86
40	1 1/2	132	172	240	54	107	34.8	140
50	2	132	172	247	60	120	47.5	140
65	-	132	172	254	67	135	60.2	140
80	3	132	172	260	74	148	72.9	140
100	4	132	172	273	87	174	97.4	140
125	-	132	172	289	103	206	120.0	200
150	6	132	172	303	117	234	146.9	200

- 1) Depending on the cable gland used: values up to + 30 mm
- 2) Total length depends on the process connections.

Remote version

Transmitter remote version

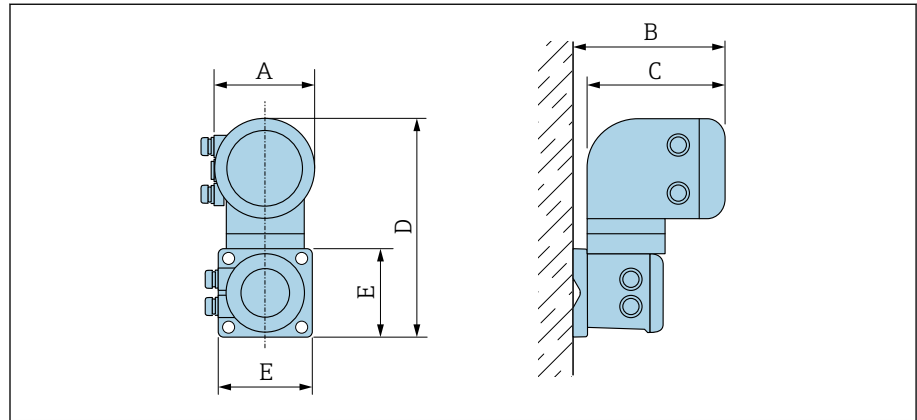

A0042715

Order code for "Housing"	A ¹⁾ [mm]	B [mm]	C [mm]	D [mm]	E [mm]
Option N "Remote, polycarbonate"	132	187	172	307	130
Option P and T "Remote, coated aluminum"	139	185	178	309	130

1) Depending on the cable entry used: values up to + 30 mm

Sensor remote version

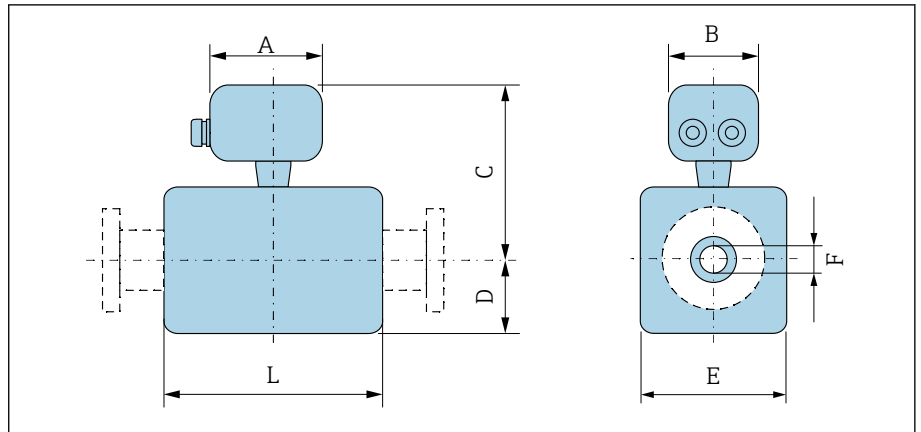

A0043178

DN		A ¹⁾	B	C	D	E	F	L ²⁾
[mm]	[in]	[mm]	[mm]	[mm]	[mm]	[mm]	[mm]	[mm]
2	1/12	126	70	129	48	43	2.25	86
4	1/32	126	70	129	48	43	4.5	86
8	5/16	126	70	129	48	43	9	86
15	1/2	126	70	129	48	43	16	86
-	1	126	70	133	52	56	22.6	86
25	-	126	70	133	52	56	26.0	86
40	1 1/2	126	70	136	53	107	34.8	140
50	2	126	70	143	60	120	47.5	140
65	-	126	70	150	67	135	60.2	140
80	3	126	70	157	74	148	72.9	140
100	4	126	70	170	87	174	97.4	140
125	-	126	70	186	103	206	120.0	200
150	6	126	70	200	117	234	146.9	200

- 1) Depending on the cable gland used: values up to + 30 mm
 2) Total length depends on the process connections.

Sensor flange connection

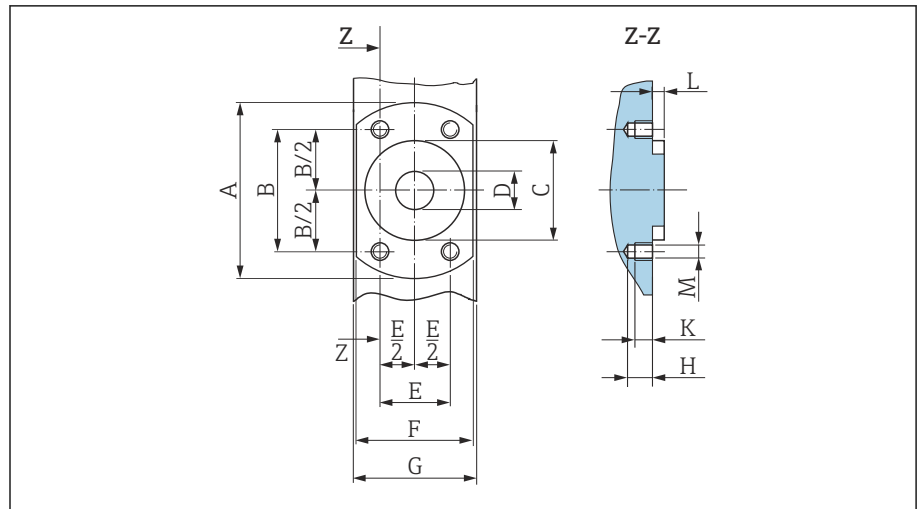

A0017657

13 Front view without process connections

[mm]	DN		A [mm]	B [mm]	C [mm]	D [mm]	E [mm]	F [mm]	G [mm]	H [mm]	K [mm]	L [mm]	M
	[in]												
2		1/12	62	41.6	34	9	24	42	43	8.5	6	4	M6
4		1/32	62	41.6	34	9	24	42	43	8.5	6	4	M6
8		5/16	62	41.6	34	9	24	42	43	8.5	6	4	M6
15		1/2	62	41.6	34	16	24	42	43	8.5	6	4	M6
25		-	72	50.2	44	26	29	55	56	8.5	6	4	M6

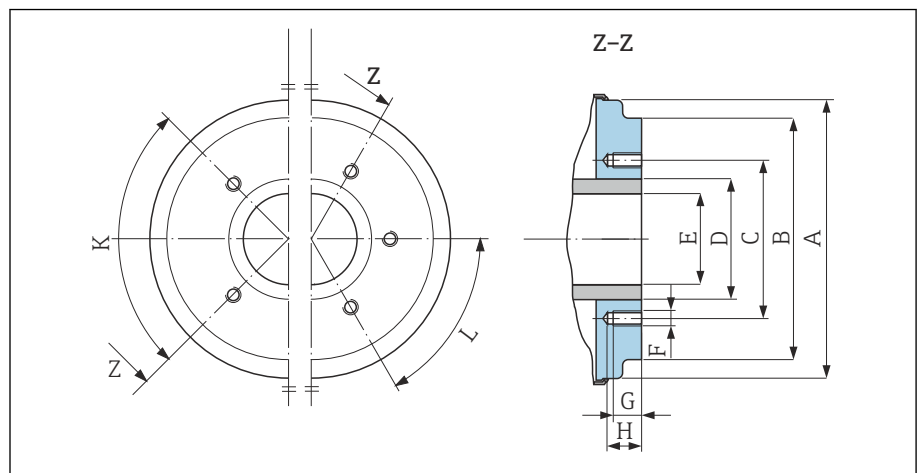

A0005528

14 Front view without process connections

[mm]	DN		A [mm]	B [mm]	C [mm]	D [mm]	E [mm]	F [mm]	G [mm]	H [mm]	Tapped holes	
	[in]										90° ±0.5°	60° ±0.5°
40		1 1/2	99.7	85.8	71.0	48.3	34.8	M8	12	17	4	-
50		2	112.7	98.8	83.5	60.3	47.5	M8	12	17	4	-
65		-	127.7	114.8	100.0	76.1	60.2	M8	12	17	-	6

DN		A	B	C	D	E	F	G	H	K	L
[mm]	[in]	[mm]	[mm]	[mm]	[mm]	[mm]	[mm]	[mm]	[mm]	90° ±0.5°	60° ±0.5°
		Tapped holes									
80	3	140.7	133.5	114.0	88.9	72.9	M8	12	17	-	6
100	4	166.7	159.5	141.0	114.3	97.4	M8	12	17	-	6
125	-	198.7	191.5	171.0	139.7	120.0	M10	15	20	-	6
150	6	226.7	219.5	200.0	168.3	146.9	M10	15	20	-	6

Flange connections

Flange DIN 11864-2 Form A, flange with groove

Stainless steel: order code for "Process connection", option DQS

Suitable for pipe similar to EN 10357 series A, flange with groove

DN 2 to 8 as standard with DN 10 flanges

Surface roughness: $Ra_{max} = 0.76 \mu m$

i Please note the internal diameters of the measuring pipe and process connection (E) when cleaning with pigs.

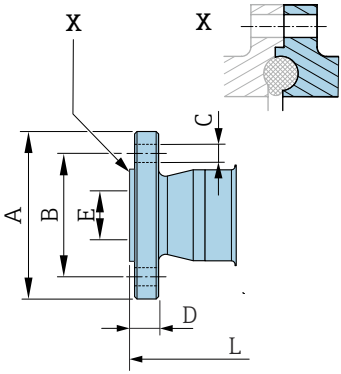

DN [mm]	Pipe [mm]	A [mm]	B [mm]	C [mm]	D [mm]	E [mm]	L [mm]
2 to 8	13 × 1.5 (DN 10)	54	37	4 × Ø9	10	10	183
15	19 × 1.5 (DN 15)	59	42	4 × Ø9	10	16	183
25	29 × 1.5 (DN 25)	70	53	4 × Ø9	10	26	183

A0043232

Flange DIN 11864-2 Form A, flange with notch

Stainless steel: order code for "Process connection", option DRS

Suitable for pipe similar to EN 10357 series A, flange with notch

Surface roughness: $Ra_{max} = 0.76 \mu m$

i Please note the internal diameters of the measuring pipe and process connection (E) when cleaning with pigs.

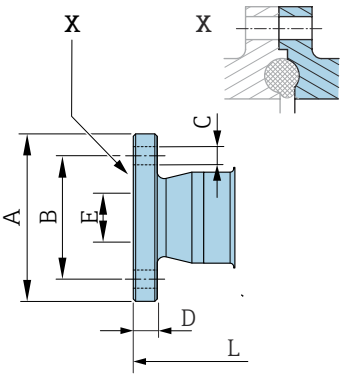

DN [mm]	Pipe [mm]	A [mm]	B [mm]	C [mm]	D [mm]	E [mm]	L [mm]
40	41 × 1.5	82	65	4 × Ø9	10	38	246
50	53 × 1.5	94	77	4 × Ø9	10	50	246
65	70 × 2	113	95	8 × Ø9	10	66	246
80	85 × 2	133	112	8 × Ø11	10	81	270
100	104 × 2	159	137	8 × Ø11	10	100	278
125	129 × 2	183	161	8 × Ø11	10	125	362
150	154 × 2	213	188	8 × Ø14	10	150	362

A0042819

Flange similar to EN 1092-1 (DIN 2501/DIN 2512N): PN 40

Stainless steel: order code for "Process connection", option D5S

Surface roughness: EN 1092-1 Form B1 (DIN 2526 Form C), $R_a \leq 1.6 \mu\text{m}$

DN 2 to 8 with DN 15 flanges as standard

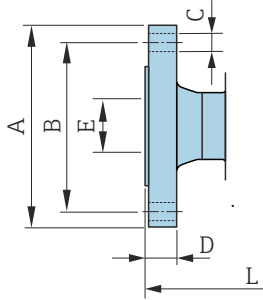

A0042813

DN [mm]	A [mm]	B [mm]	C [mm]	D [mm]	E [mm]	L [mm]
2 to 8	95	65	4 × Ø14	16	17.3	198.4
15	95	65	4 × Ø14	16	17.3	198.4
25	115	85	4 × Ø14	18	28.5	198.4

Flange similar to ASME B16.5, Class 150

Stainless steel: order code for "Process connection", option A1S

Surface roughness: $R_a \leq 1.6 \mu\text{m}$

DN 2 to 8 as standard with DN 15 flanges

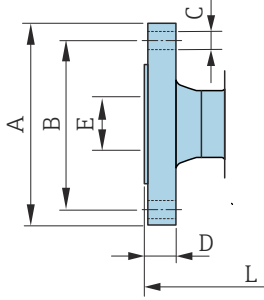

A0042813

DN [mm]	A [mm]	B [mm]	C [mm]	D [mm]	E [mm]	L [mm]
2 to 8	90	60.3	4 × Ø15.7	11.2	15.7	218
15	90	60.3	4 × Ø15.7	11.2	15.7	218
25	110	79.4	4 × Ø15.7	14.2	26.7	230

Flange according to JIS B2220, 20K

Stainless steel: order code for "Process connection", option N4S

Surface roughness: $R_a \leq 1.6 \mu\text{m}$

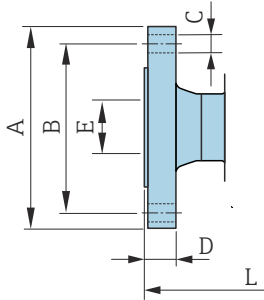

A0042813

DN [mm]	A [mm]	B [mm]	C [mm]	D [mm]	E [mm]	L [mm]
2 to 8	95	70	4 × Ø15	14	15	220
15	95	70	4 × Ø15	14	15	220
25	125	90	4 × Ø19	16	25	220

Clamp connections

Tri-Clamp

1.4404/316L: order code for "Process connection", option FAS

Suitable for pipe similar to ASME BPE (DIN 11866 series C)

Surface roughness: $Ra_{max} = 0.76 \mu m$

i Pay attention to the internal diameters of the measuring pipe and process connection (B) when cleaning with pigs.

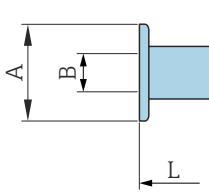

A0043179

DN [mm]	Pipe [mm]	A [mm]	B [mm]	L [mm]
2 to 8	12.7 × 1.65	25	9.4	143
15	19.1 × 1.65	25	15.8	143
25	25.4 × 1.65	50.4	22.1	143
40	38.1 × 1.65	50.4	34.8	220
50	50.8 × 1.65	63.9	47.5	220
65	63.5 × 1.65	77.4	60.2	220
80	76.2 × 1.65	90.9	72.9	220
100	101.6 × 2.11	118.9	97.4	220
150	152.4 × 2.77	166.9	146.9	300

Welding nipple

Welding socket similar to EN 10357

1.4404/316L: order code for "Process connection", option DAS

Suitable for pipe EN 10357 series A

Surface roughness: $Ra_{max} = 0.76 \mu\text{m}$

i Please note the internal diameters of the measuring tube and process connection (B) when cleaning with pigs.

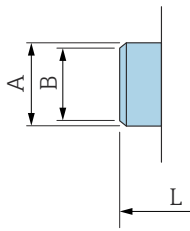

A0043180

DN [mm]	Pipe [mm]	A [mm]	B [mm]	L [mm]
2 to 8	13 × 1.5	13	10	132.6
15	19 × 1.5	19	16	132.6
25	29 × 1.5	29	26	132.6
40	41 × 1.5	41	38	220
50	53 × 1.5	53	50	220
65	70 × 2	70	66	220
80	85 × 2	85	81	220
100	104 × 2	104	100	220
125	129 × 2	129	125	300
150	154 × 2	154	150	300

Welding nipple similar to ISO 1127

1.4404/316L: Order code for "Process connection", option A2S

Suitable for pipe ISO 1127, series 1

Surface roughness: $Ra_{max} = 0.76 \mu\text{m}$

i When cleaning with pigs, pay attention to the internal diameters of the measuring pipe and process connection (dimension B).

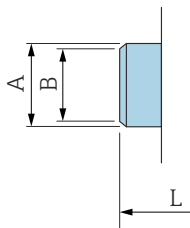

A0043180

DN [mm]	Pipe [mm]	A [mm]	B [mm]	L [mm]
2 to 8	13.5 × 2.30	13.5	9	126.6
15	21.3 × 2.65	21.3	16	126.6
25	33.7 × 3.25	33.7	27.2	126.6

Welding nipple similar to ISO 2037

1.4404/316L: order code for "Process connection", option IAS

Suitable for pipe ISO 1127 (series 1 to 3, differ per nominal diameter)

Surface roughness: $Ra_{max} = 0.76 \mu\text{m}$

i When cleaning with pigs, pay attention to the internal diameters of the measuring pipe and process connection (dimension B).

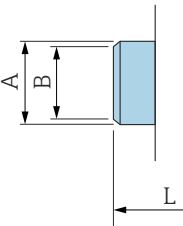

A technical drawing of a cylindrical sensor probe. Dimension A is the total length of the probe. Dimension B is the length of the sensing element. Dimension L is the length of the probe's body. The drawing shows the probe inserted into a pipe.

DN [mm]	Pipe [mm]	A [mm]	B [mm]	L [mm]
2 to 8	12.7 × 1.65	12	10	118.2
15	19.05 × 1.65	18	16	118.2
25	25.4 × 1.60	25	22.6	118.2
40	38 × 1.2	38	35.6	220
50	51 × 1.2	51	48.6	220
65	63.5 × 1.6	63.5	60.3	220
80	76.1 × 1.6	76.1	72.9	220
100	101.6 × 2	101.6	97.6	220
125	139.7 × 2	139.7	135.7	380
150	168.3 × 2.6	168.3	163.1	380

A0043180

Welding nipple similar to ASME BPE

1.4404/316L: order code for "Process connection", option AAS

Suitable for pipe similar to ASME BPE (DIN 11866 Range C)

Surface roughness: $Ra_{max} = 0.76 \mu m$

i When cleaning with pigs, pay attention to the internal diameters of the measuring pipe and process connection (dimension B).

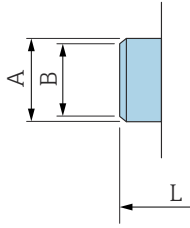

A0043180

DN [mm]	Pipe [mm]	A [mm]	B [mm]	L [mm]
2 to 8	12.7 × 1.65	12.7	9	118.2
15	19.1 × 1.65	19.1	16	118.2
25	25.4 × 1.65	25.4	22.6	118.2
40	38.1 × 1.65	38.1	34.8	220
50	50.8 × 1.65	50.8	47.5	220
65	63.5 × 1.65	63.5	60.2	220
80	76.2 × 1.65	76.2	72.9	220
100	101.6 × 1.65	101.6	97.4	220
150	152.4 × 2.77	152.4	146.9	300

Couplings

Threaded coupling similar to DIN 11851

1.4404/316L: order code for "Process connection", option DCS

Suitable for pipe EN 10357 series B (DN 2 to 25)

Surface roughness: $Ra_{max} = 0.76 \mu m$

i Please note the internal diameters of the measuring tube and process connection (B) when cleaning with pigs.

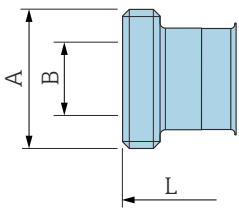

DN [mm]	Pipe [mm]	A [mm]	B [mm]	L [mm]
2 to 8	12 × 1 (DN 10)	Rd 28 × 1/8	10	174
15	18 × 1.5	Rd 34 × 1/8	16	174
25	28 × 1 or 28 × 1.5	Rd 52 × 1/8	26	190

A0048695

1.4404/316L: order code for "Process connection", option DCS

Suitable for pipe EN 10357 series A (DN 40 to 150)

Surface roughness: $Ra_{max} = 0.76 \mu m$

i Please note the internal diameters of the measuring tube and process connection (B) when cleaning with pigs.

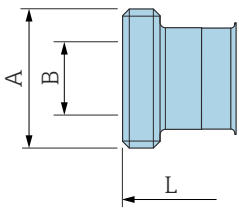

DN [mm]	Pipe [mm]	A [mm]	B [mm]	L [mm]
40	41 × 1.5	Rd 65 × 1/8	38	260
50	53 × 1.5	Rd 78 × 1/8	50	260
65	70 × 2	Rd 95 × 1/8	66	270
80	85 × 2	Rd 110 × 1/4	81	280
100	104 × 2	Rd 130 × 1/4	100	290
125	129 × 2	Rd 160 × 1/4	125	380
150	154 × 2	Rd 160 × 1/4	150	390

A0048695

Threaded hygienic connection similar to DIN 11864-1, Form A

1.4404/316L: order code for "Process connection", option DDS

Suitable for pipe EN 10357 series A

Surface roughness: $Ra_{max} = 0.76 \mu m$

i Pay attention to the internal diameters of the measuring pipe and process connection (B) when cleaning with pigs.

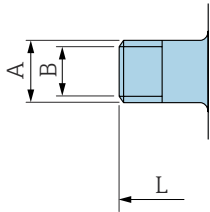

A0043253

DN [mm]	Pipe [mm]	A [mm]	B [mm]	L [mm]
2 to 8	Pipe 13 × 1.5 (DN 10)	Rd 28 × 1/8	10	170
15	Pipe 19 × 1.5	Rd 34 × 1/8	16	170
25	Pipe 29 × 1.5	Rd 52 × 1/6	26	184
40	41 × 1.5	Rd 65 × 1/6	38	256
50	53 × 1.5	Rd 78 × 1/6	50	256
65	70 × 2	Rd 95 × 1/6	66	266
80	85 × 2	Rd 110 × 1/4	81	276
100	104 × 2	Rd 130 × 1/4	100	286

Thread similar to SMS 1145

1.4404/316L: Order code for "Process connection", option SAS

Surface roughness: $Ra_{max} = 0.76 \mu m$

i When cleaning with pigs, pay attention to the internal diameters of the measuring pipe and process connection (B).

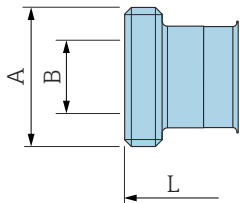

A0043257

DN [mm]	Pipe [mm]	DN SMS 1145 [mm]	A [mm]	B [mm]	L [mm]
25	1	25	Rd 40 × 1/6	22.6	147.6
40	38.1 × 1.65	38	Rd 60 × 1/6	34.8	256
50	50.8 × 1.65	51	Rd 70 × 1/6	47.5	256
65	63.5 × 1.65	63.5	Rd 85 × 1/6	60.2	266
80	76.2 × 1.65	76	Rd 98 × 1/6	72.6	276
100	101.6 × 1.65	101.6	Rd 132 × 1/6	97.4	286

External thread similar to ISO 228/DIN 2999

1.4404/316L: order code for "Process connection", option I2S

Suitable for internal thread ISO 228/DIN 2999

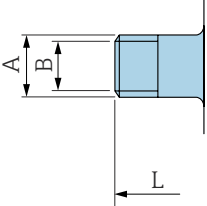
Surface roughness: $R_a \leq 1.6 \mu\text{m}$

The technical drawing shows a side view of a pipe connection. Dimension A is the total length of the connection. Dimension B is the length of the threaded section. Dimension L is the length of the pipe section. The drawing is positioned to the left of the table.

DN [mm]	Pipe [mm]	A [mm]	B [mm]	L [mm]
2 to 8	R $\frac{3}{8}$	R $10.1 \times \frac{3}{8}$	10	166
15	R $\frac{1}{2}$	R $13.2 \times \frac{1}{2}$	16	166
25	R 1	R 16.5×1	25	170

A0043253

Mounting kit

Wall mounting kit

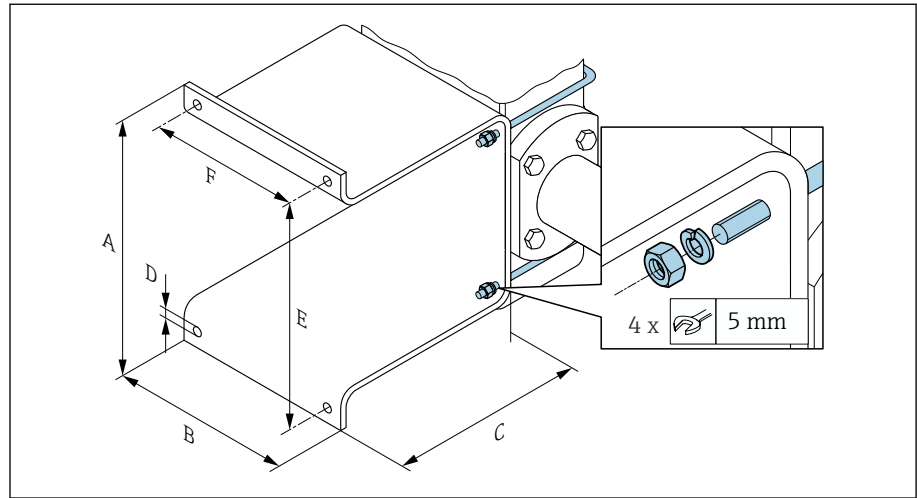

A0054890

A	B	C	Ø D	E	F
[mm]	[mm]	[mm]	[mm]	[mm]	[mm]
137	110	120	7	125	88

Accessories

Grounding rings

Order code: DK5HR-****

1.4435 (316L), Alloy C22, tantalum

For lap joint flange made of PVDF and PVC adhesive sleeve

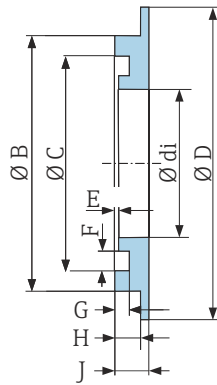

A0017673

DN [mm]	di [mm]	B [mm]	C [mm]	D [mm]	D [mm]	E [mm]	G [mm]	H [mm]	J [mm]
2 to 8	9	22	17.6	33.9	0.5	3.5	1.9	3.4	4.5
15	16	29	24.6	33.9	0.5	3.5	1.9	3.4	4.5
25	26	39	34.6	43.9	0.5	3.5	1.9	3.4	4.5

Spacer

Order code: DK5HB-****

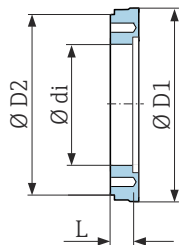

A0017294

DN [mm]	di [mm]	D1 [mm]	D2 [mm]	L [mm]
80	72.9	140.7	141	30
100	97.4	166.7	162	30

Male thread with O-ring seal

Order code: DKH**-GD**

1.4404/316L

Suitable for female thread NPT

Surface roughness: $R_a \leq 1.6 \mu\text{m}$

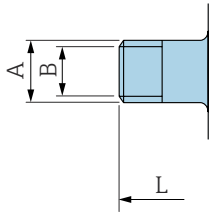

A0043253

DN [mm]	Thread [mm]	A [mm]	B [mm]	L [mm]
2 to 8	NPT 3/8	R 15.5 × 3/8	10	186
15	NPT 1/2	R 20 × 1/2	16	186
25	NPT 1	R 25 × 1	25	196

Female thread with O-ring seal

Order code: DKH**-GC**

1.4404/316L

Suitable for male thread NPT

Surface roughness: $R_a \leq 1.6 \mu\text{m}$

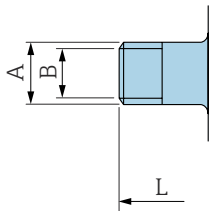

A0043253

DN [mm]	Thread [mm]	A [mm]	B [mm]	L [mm]
2 to 8	NPT 3/8	R 13 × 3/8	8.9	176
15	NPT 1/2	R 14 × 1/2	16	176
25	NPT 1	R 17 × 1	27.2	188

Tri-Clamp

Order code: DKH**-HF**

1.4404 (316L)

Suitable for pipe according to BS 4825/ASME BPE (constriction of OD 1" according to DN15)

Surface roughness: $Ra_{max} = 0.76 \mu m$

i Pay attention to the internal diameters of the measuring pipe and process connection (B) when cleaning with pigs.

DN [mm]	Piping	A [mm]	B [mm]	L [mm]
15	OD 1"	50.4	22.1	143

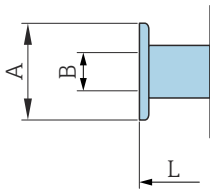

A0043179

Weather protection cover

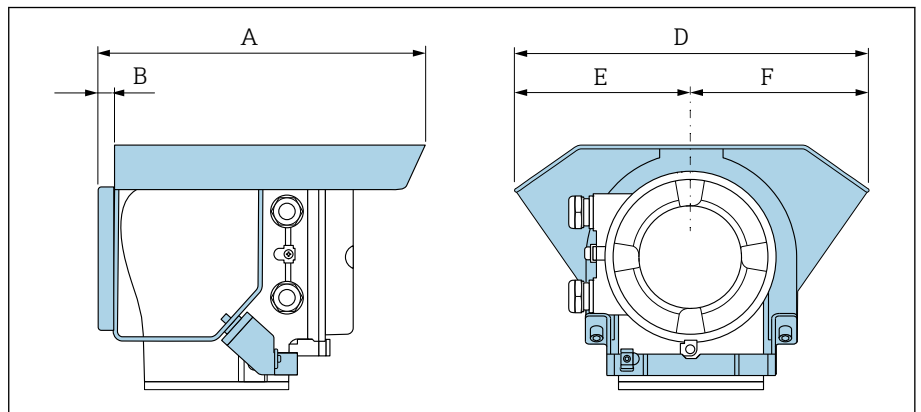

A0042332

A [mm]	B [mm]	D [mm]	E [mm]	F [mm]
257	12	280	140	140

15 Dimensions in US units

Compact version	144
Order code for "Housing", option A and G "Aluminum, coated"	144
Order code for "Housing", option M "Compact, polycarbonate"	145
Remote version	146
Transmitter remote version	146
Sensor remote version	147
Sensor flange connection	148
Flange connections	150
Flange similar to ASME B16.5, Class 150	150
Clamp connections	150
Tri-Clamp	150
Welding nipple	151
Welding nipple similar to ISO 1127	151
Welding nipple similar to ISO 2037	151
Welding nipple similar to ASME BPE	151
Couplings	153
Thread similar to SMS 1145	153
Mounting kits	154
Wall mounting kit	154
Accessories	155
Spacer	155
Clamp connections with aseptic gasket seal available for order	155
Couplings with O-ring seal available for order	156
Grounding rings	157
Weather protection cover	157

Compact version

Order code for "Housing", option A and G "Aluminum, coated"

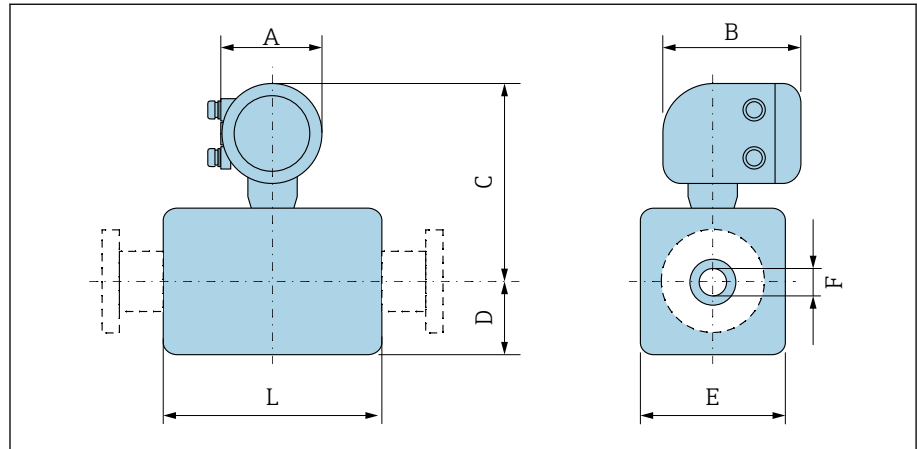

A0043172

DN		A ¹⁾	B	C	D	E	F	L ²⁾
[mm]	[in]	[in]	[in]	[in]	[in]	[in]	[in]	[in]
2	1/12	5.47	7.01	9.25	1.89	1.69	0.089	3.39
4	1/32	5.47	7.01	9.25	1.89	1.69	0.18	3.39
8	5/16	5.47	7.01	9.25	1.89	1.69	0.35	3.39
15	1/2	5.47	7.01	9.25	1.89	1.69	0.63	3.39
-	1	5.47	7.01	9.41	2.05	2.2	0.89	3.39
25	-	5.47	7.01	9.41	2.05	2.2	1.02	3.39
40	1 1/2	5.47	7.01	9.53	2.13	4.21	1.37	5.51
50	2	5.47	7.01	9.8	2.36	4.72	1.87	5.51
65	-	5.47	7.01	10.08	2.68	5.31	2.37	5.51
80	3	5.47	7.01	10.35	2.91	5.83	2.87	5.51
100	4	5.47	7.01	10.87	3.43	6.85	3.83	5.51
125	-	5.47	7.01	11.5	4.06	8.11	4.72	7.87
150	6	5.47	7.01	12.05	4.61	9.21	5.78	7.87

- 1) Depending on the cable gland used; values up to +1.18 in
- 2) Total length depends on the process connections.

Order code for "Housing", option M "Compact, polycarbonate"

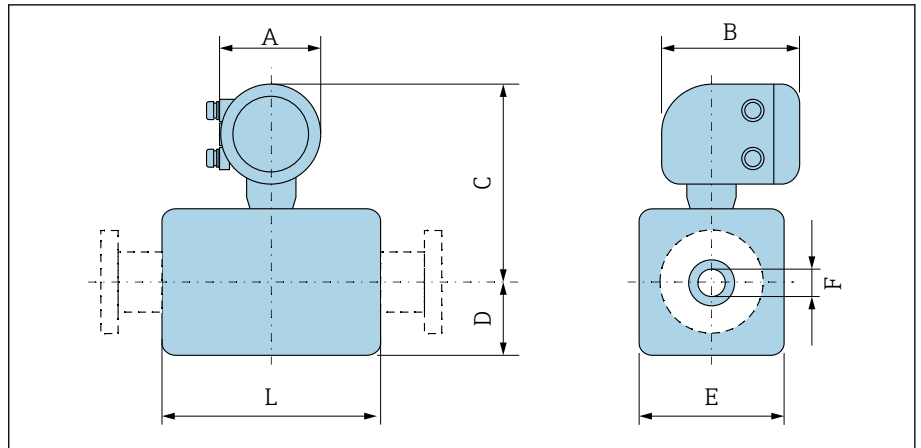

A0043172

DN		A ¹⁾	B	C	D	E	F	L ²⁾
[mm]	[in]	[in]	[in]	[in]	[in]	[in]	[in]	[in]
2	1/12	5.2	6.77	9.13	2.17	1.69	0.089	3.39
4	1/32	5.2	6.77	9.13	2.17	1.69	0.18	3.39
8	5/16	5.2	6.77	9.13	2.17	1.69	0.35	3.39
15	1/2	5.2	6.77	9.13	2.17	1.69	0.63	3.39
-	1	5.2	6.77	9.33	2.17	2.2	0.89	3.39
25	-	5.2	6.77	9.33	2.17	2.2	1.02	3.39
40	1 1/2	5.2	6.77	9.45	2.13	4.21	1.37	5.51
50	2	5.2	6.77	9.72	2.36	4.72	1.87	5.51
65	-	5.2	6.77	10	2.64	5.31	2.37	5.51
80	3	5.2	6.77	10.24	2.91	5.83	2.87	5.51
100	4	5.2	6.77	10.75	3.43	6.85	3.83	5.51
125	-	5.2	6.77	11.38	4.06	8.11	4.72	7.87
150	6	5.2	6.77	11.93	4.61	9.21	5.78	7.87

- 1) Depending on the cable gland used: values up to +1.18 in
 2) Total length depends on the process connections.

Remote version

Transmitter remote version

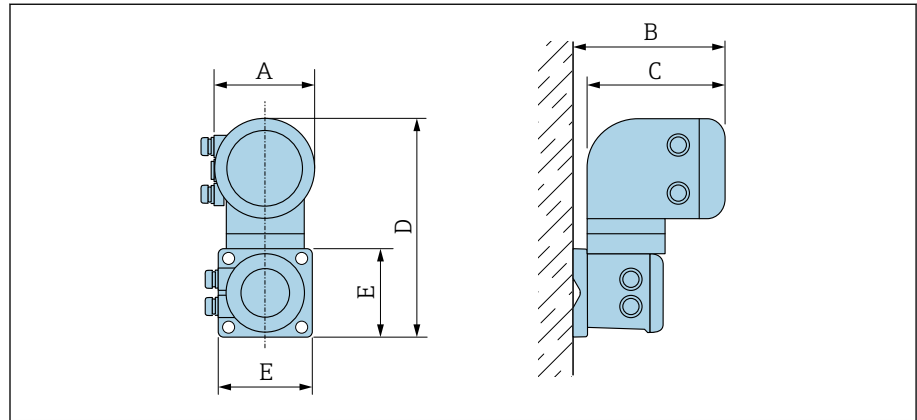

A0042715

Order code for "Housing"	A ¹⁾ [in]	B [in]	C [in]	D [in]	E [in]
Option N "Remote, polycarbonate"	5.2	7.36	6.77	12.09	5.12
Option P and T "Remote, coated aluminum"	5.47	7.28	7.01	12.17	5.12

1) Depending on the cable entry used: values up to +1.18 in

Sensor remote version

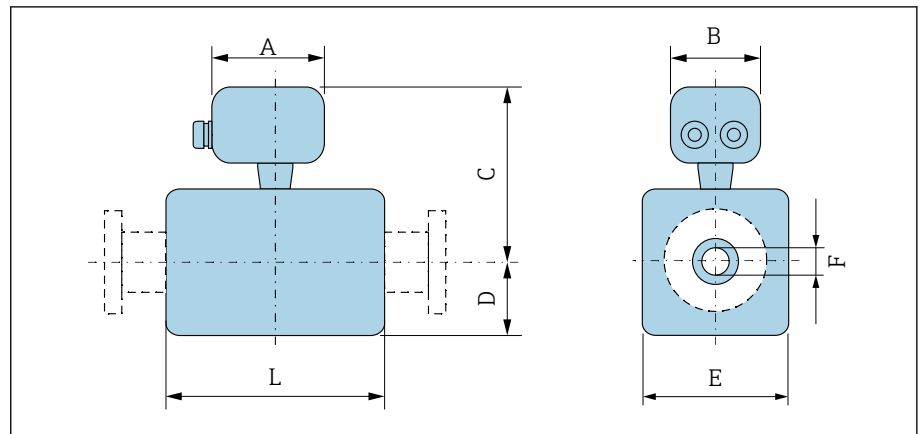

A0043178

DN		A ¹⁾	B	C	D	E	F	L ²⁾
[mm]	[in]	[in]	[in]	[in]	[in]	[in]	[in]	[in]
2	1/12	4.96	2.76	5.08	1.89	1.69	0.089	3.39
4	1/32	4.96	2.76	5.08	1.89	1.69	0.18	3.39
8	5/16	4.96	2.76	5.08	1.89	1.69	0.35	3.39
15	1/2	4.96	2.76	5.08	1.89	1.69	0.63	3.39
-	1	4.96	2.76	5.24	2.05	2.2	0.89	3.39
25	-	4.96	2.76	5.24	2.05	2.2	1.02	3.39
40	1 1/2	4.96	2.76	5.35	2.09	4.21	1.37	5.51
50	2	4.96	2.76	5.63	2.36	4.72	1.87	5.51
65	-	4.96	2.76	5.91	2.64	5.31	2.37	5.51
80	3	4.96	2.76	6.18	2.91	5.83	2.87	5.51
100	4	4.96	2.76	6.69	3.43	6.85	3.83	5.51
125	-	4.96	2.76	7.32	4.06	8.11	4.72	7.87
150	6	4.96	2.76	7.87	4.61	9.21	5.78	7.87

- 1) Depending on the cable gland used: values up to +1.18 in
 2) Total length depends on the process connections.

Sensor flange connection

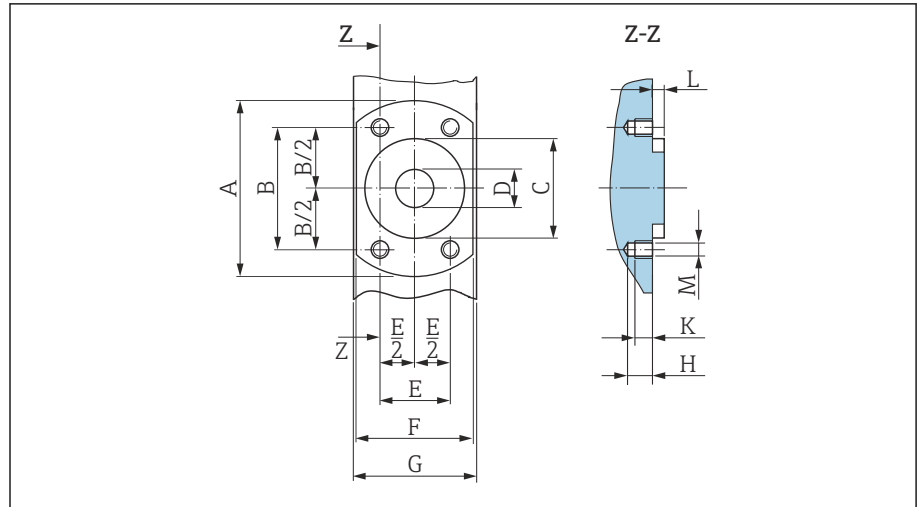

A0017657

15 Front view without process connections

[mm]	DN		A [in]	B [in]	C [in]	D [in]	E [in]	F [in]	G [in]	H [in]	K [in]	L [in]	M [mm]
	[in]												
2		1/12	2.44	1.64	1.34	0.35	0.94	1.65	1.69	0.33	0.24	0.16	M6
4		1/32	2.44	1.64	1.34	0.35	0.94	1.65	1.69	0.33	0.24	0.16	M6
8		5/16	2.44	1.64	1.34	0.35	0.94	1.65	1.69	0.33	0.24	0.16	M6
15		1/2	2.44	1.64	1.34	0.63	0.94	1.65	1.69	0.33	0.24	0.16	M6
25		-	2.83	1.98	1.73	1.02	1.14	2.17	2.2	0.33	0.24	0.16	M6

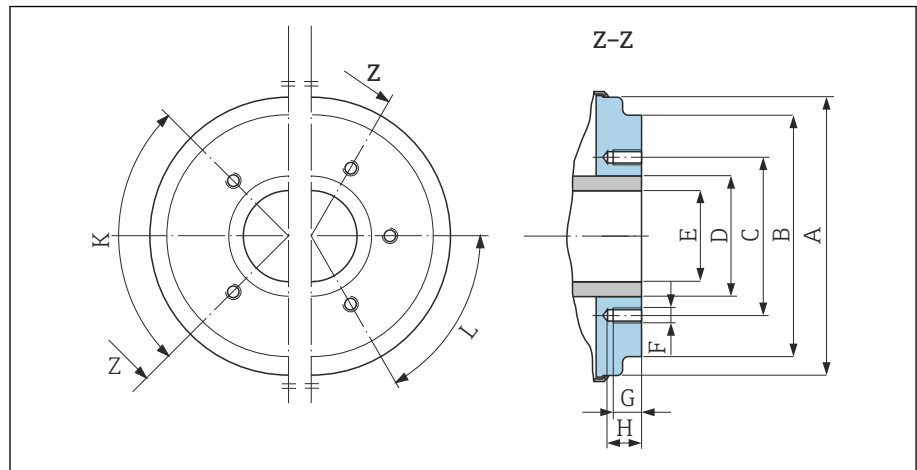

A0005528

16 Front view without process connections

[mm]	DN		A [in]	B [in]	C [in]	D [in]	E [in]	F [mm]	G [in]	H [in]	Tapped holes	
	[in]										90° ±0.5°	60° ±0.5°
40		1 1/2	3.93	3.38	2.8	1.9	1.37	M8	0.47	0.67	4	-
50		2	4.44	3.89	3.29	2.37	1.87	M8	0.47	0.67	4	-
65		-	5.03	4.52	3.94	3	2.37	M8	0.47	0.67	-	6

DN		A	B	C	D	E	F	G	H	K	L
[mm]	[in]	[in]	[in]	[in]	[in]	[in]	[mm]	[in]	[in]	90° ±0.5°	60° ±0.5°
		Tapped holes									
80	3	5.54	5.26	4.49	3.5	2.87	M8	0.47	0.67	-	6
100	4	6.56	6.28	5.55	4.5	3.83	M8	0.47	0.67	-	6
125	-	7.82	7.54	6.73	5.5	4.72	M10	0.59	0.79	-	6
150	6	8.93	8.64	7.87	6.63	5.78	M10	0.59	0.79	-	6

Flange connections

Flange similar to ASME B16.5, Class 150

Stainless steel: order code for "Process connection", option A1S

Surface roughness: $R_a \leq 63 \mu\text{in}$

DN $\frac{1}{12}$ " to $\frac{5}{16}$ " with DN $\frac{1}{2}$ " flanges as standard

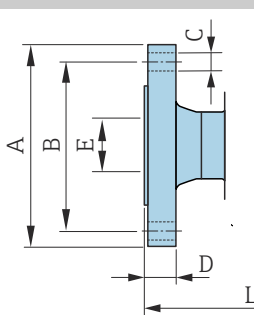

DN [in]	A [in]	B [in]	C [in]	D [in]	E [in]	L [in]
$\frac{1}{12}$ to $\frac{5}{16}$	3.54	2.37	$4 \times \emptyset 0.62$	0.44	0.62	8.58
$\frac{1}{2}$	3.54	2.37	$4 \times \emptyset 0.62$	0.44	0.62	8.58
1	4.33	3.13	$4 \times \emptyset 0.62$	0.56	1.05	9.06

A0042813

Clamp connections

Tri-Clamp

1.4404/316L: order code for "Process connection", option FAS

Suitable for pipe similar to ASME BPE (DIN 11866 Range C)

Surface roughness: $R_{a\text{max}} = 30 \mu\text{in}$

i When cleaning with pigs, pay attention to the internal diameters of the measuring pipe and process connection (B).

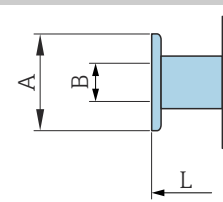

DN [in]	Pipe [in]	A [in]	B [in]	L [in]
$\frac{1}{12}$ to $\frac{5}{16}$	0.5×0.065	0.98	0.37	5.63
$\frac{1}{2}$	0.75×0.065	0.98	0.62	5.63
1	1×0.065	1.98	0.87	5.63
1 $\frac{1}{2}$	1.5×0.065	1.98	1.37	8.66
2	2×0.065	2.52	1.87	8.66
3	3×0.065	3.58	2.87	8.66
4	4×0.083	4.68	3.83	8.66
6	6×0.109	6.57	5.78	11.81

A0043179

Welding nipple

Welding nipple similar to ISO 1127

1.4404/316L: Order code for "Process connection", option A2S

Suitable for pipe ISO 1127, series 1

Surface roughness: $Ra_{max} = 30 \mu\text{in}$

i When cleaning with pigs, pay attention to the internal diameters of the measuring pipe and process connection (dimension B).

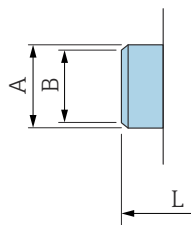

DN [in]	Pipe [in]	A [in]	B [in]	L [in]
$\frac{1}{12}$ to $\frac{5}{16}$	0.53 × 0.09	0.53	0.35	4.99
$\frac{1}{2}$	0.84 × 0.10	0.84	0.63	4.99

A0043180

Welding nipple similar to ISO 2037

1.4404/316L: order code for "Process connection", option IAS

Suitable for pipe ISO 1127 (series 1 to 3, differ per nominal diameter)

Surface roughness: $Ra_{max} = 30 \mu\text{in}$

i When cleaning with pigs, pay attention to the internal diameters of the measuring pipe and process connection (dimension B).

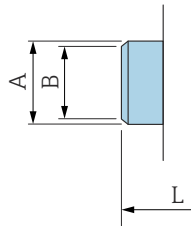

DN [in]	Piping [in]	A [in]	B [in]	L [in]
$\frac{1}{12}$ to $\frac{5}{16}$	0.5 × 0.065	0.47	0.39	4.65
$\frac{1}{2}$	0.75 × 0.065	0.71	0.63	4.65
1	1 × 0.06	0.98	0.89	4.65
1 ½	1.5 × 0.05	1.5	1.4	8.66
2	2 × 0.05	2	1.91	8.66
3	3 × 0.06	3	2.87	8.66
4	4 × 0.08	4	3.84	8.66
5	5.5 × 0.08	5.5	5.34	14.96
6	6.63 × 0.1	6.63	6.42	14.96

A0043180

Welding nipple similar to ASME BPE

1.4404/316L: order code for "Process connection", option AAS

Suitable for pipe similar to ASME BPE (DIN 11866 Range C)

Surface roughness: $Ra_{max} = 30 \mu\text{in}$

i When cleaning with pigs, pay attention to the internal diameters of the measuring pipe and process connection (dimension B).

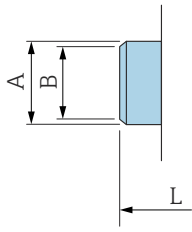

A0043180

DN [in]	Pipe [in]	A [in]	B [in]	L [in]
$\frac{1}{12}$ to $\frac{5}{16}$	0.5×0.065	0.5	0.35	4.65
$\frac{1}{2}$	0.75×0.065	0.75	0.63	4.65
1	1×0.065	1	0.89	4.65
$1 \frac{1}{2}$	1.5×0.065	1.5	1.37	8.66
2	2×0.065	2	1.87	8.66
3	3×0.065	3	2.87	8.66
4	4×0.065	4	3.83	8.66
6	6×0.109	6	5.78	11.81

Couplings

Thread similar to SMS 1145

1.4404/316l: Order code for "Process connection", option SAS

Surface roughness: $Ra_{max} = 30 \mu\text{in}$

i When cleaning with pigs, pay attention to the internal diameters of the measuring pipe and process connection (B).

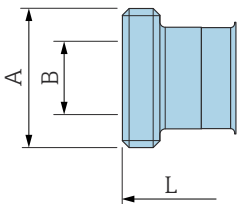

A technical drawing of a coupling component. It shows a cylindrical part with a flange on one end. Dimension A is the total length of the component. Dimension B is the length of the flange section. Dimension L is the length of the main cylindrical body.

DN [in]	Pipe [in]	DN SMS 1145 [in]	A [in]	B [in]	L [in]
1	1	1	Rd 1.57 × 0.17	0.89	5.81
1 ½	1.5 × 0.06	1.5	Rd 2.36 × ¼	1.37	10.1
2	2 × 0.06	2	Rd 2.76 × ¼	1.87	10.1
3	3 × 0.06	3	Rd 3.86 × ¼	2.86	10.9
4	4 × 0.08	4	Rd 5.20 × ¼	3.83	11.3

A0043257

Mounting kits

Wall mounting kit

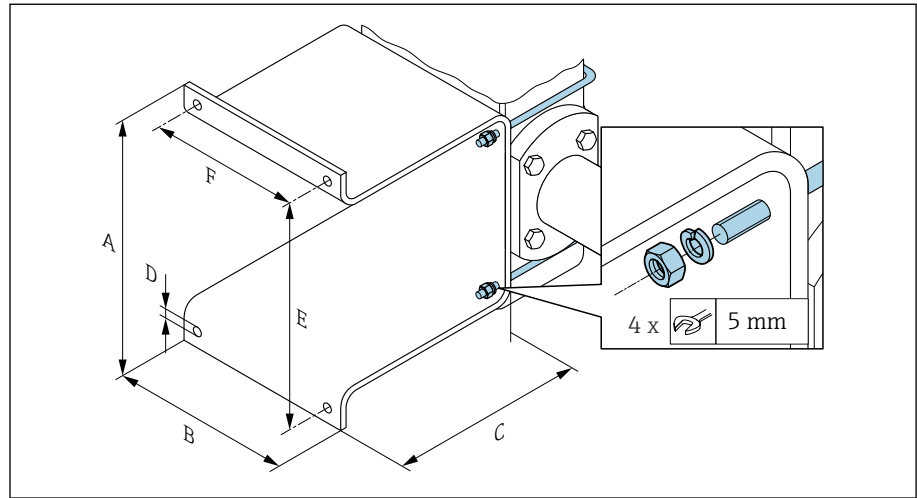

A	B	C	Ø D	E	F
[in]	[in]	[in]	[in]	[in]	[in]
5.39	4.33	4.72	0.28	4.92	3.46

Accessories

Spacer

Order code: DK5HB-****

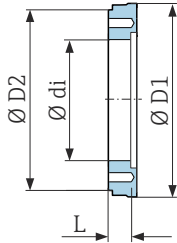

A0017294

DN [in]	di [in]	D1 [in]	D2 [in]	L [in]
3	2.87	5.54	5.55	1.30
4	3.83	6.56	6.38	1.30

Clamp connections with aseptic gasket seal available for order

Order code: DKH**-HF**

1.4404 (316L)

Suitable for pipe according to BS 4825/ASME BPE (constriction of OD 1" according to DN15)

Surface roughness: $Ra_{max} = 30 \mu\text{in}$

i Pay attention to the internal diameters of the measuring pipe and process connection (B) when cleaning with pigs.

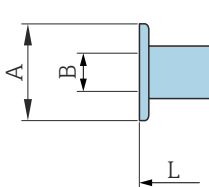

A0043179

DN [in]	Piping	A [in]	B [in]	L [in]
½	OD 1"	1.98	0.87	5.63

Couplings with O-ring seal available for order

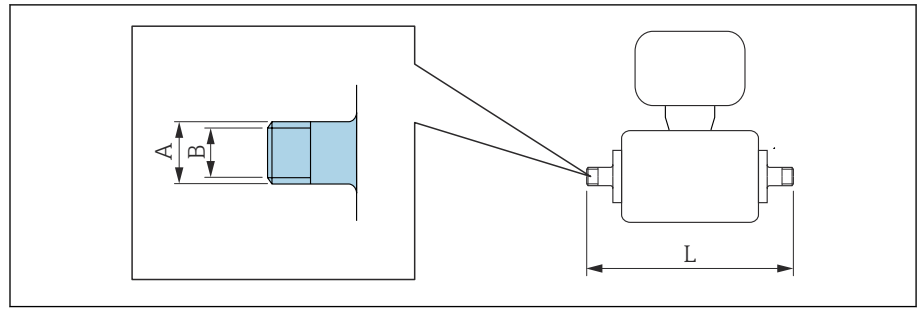

A0027509

Male thread
 1.4404 (316L)
 Order code: DKH**-GD**

DN [in]	Suitable for female thread NPT [in]	A [in]	B [in]	L [in]
1/12 to 3/8	NPT 3/8	R 0.61 × 3/8	0.39	7.39
1/2	NPT 1/2	R 0.79 × 1/2	0.63	7.39
1	NPT 1	R 1 × 1	1.00	7.73

Surface roughness: Ra ≤ 63 µin

Female thread
 1.4404 (316L)
 Order code: DKH**-GC**

DN [in]	Suitable for male thread NPT [in]	A [in]	B [in]	L [in]
1/12 to 3/8	NPT 3/8	R 0.51 × 3/8	0.35	6.93
1/2	NPT 1/2	R 0.55 × 1/2	0.63	6.93
1	NPT 1	R 0.67 × 1	1.07	7.41

Surface roughness: Ra ≤ 63 µin

Grounding rings

Order code: DK5HR-****

1.4435 (316L), Alloy C22, tantalum

For lap joint flange made of PVDF and PVC adhesive sleeve

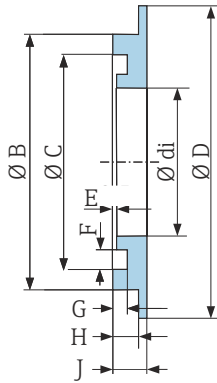

DN [in]	di [in]	B [in]	C [in]	D [in]	D [in]	E [in]	G [in]	H [in]	J [in]
1/12 to 3/8	0.35	0.87	0.69	1.33	0.02	0.14	0.07	0.13	0.18
1/2	0.63	1.14	0.97	1.33	0.02	0.14	0.07	0.13	0.18
1	0.89	1.44	1.23	1.73	0.02	0.14	0.07	0.13	0.18

A0017673

Weather protection cover

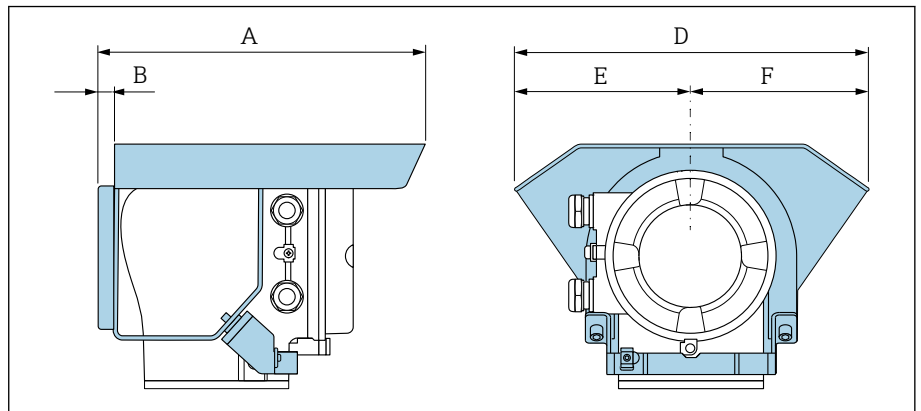

A0042332



A [in]	B [in]	D [in]	E [in]	F [in]
10.12	0.47	11.02	5.51	5.51

16 Accessories



Device-specific accessories	160
Communication-specific accessories	161
Service-specific accessory	161
System components	162

Device-specific accessories







Transmitter

Accessories	Description	Order number
Proline 10 transmitter	 Installation Instructions EA01350D	5XBBXX-*...*
Weather protection cover	Protects the device from weather exposure:  Installation Instructions EA01351D	71502730
Connecting cable	Can be ordered with the device. The following cable lengths are available: order code for "Cable, sensor connection" <ul style="list-style-type: none"> ▪ 5 m (16 ft) ▪ 10 m (32 ft) ▪ 20 m (65 ft) ▪ User-configurable cable length m (ft)  Max. cable length: 200 m (660 ft)	DK5013-*...*

Sensor



Accessories	Description
Adapter set	Adapter connections for installing a Promag H instead of a Promag 30/33 A or Promag 30/33 H (DN 25). Consists of: <ul style="list-style-type: none"> ▪ 2 process connections ▪ Screws ▪ Seals
Seal set	Replacement of seals
Centering star	A centering star is needed if an installed device with DN 80 or DN 100 must be replaced and the new sensor is shorter.
Welding jig	If using process connections with welding jigs: Welding jig for installation in piping.
Grounding rings	Ground medium in lined measuring pipes.  Installation Instructions EA00070D
Ground disks	Ground medium in lined measuring pipes.  Installation Instructions EA00070D
Wall mounting kit	Wall mounting kit (only DN 2 to 25 (1/12 to 1"))
Mounting kit	Consists of: <ul style="list-style-type: none"> ▪ 2 process connections ▪ Screws ▪ Seals

Communication-specific accessories



Accessory	Description
Commubox FXA195 USB/HART modem	Intrinsically safe HART communication with FieldCare and FieldXpert  Technical Information TI00404F
Commubox FXA291	Connects the Endress+Hauser devices with the CDI interface (= Endress+Hauser Common Data Interface) to the USB interface of a personal computer or laptop.  Technical Information TI405C/07
HART loop converter HMX50	Is used to evaluate and convert dynamic HART process variables to analog current signals or limit values.  <ul style="list-style-type: none"> ▪ Technical Information TI00429F ▪ Operating Instructions BA00371F
Fieldgate FXA42	Transmission of measured values from connected 4 to 20 mA analog and digital devices.  <ul style="list-style-type: none"> ▪ Technical Information TI01297S ▪ Operating Instructions BA01778S ▪ Product page: www.endress.com/fxa42
Field Xpert SMT50	The Field Xpert SMT50 table PC for device configuration enables mobile plant asset management. It is suitable for commissioning and maintenance staff to manage field instruments with a digital communication interface and to record progress. This tablet PC is designed as an all-in-one solution with a preinstalled driver library and is an easy-to-use, touch-sensitive tool which can be used to manage field instruments throughout their entire life cycle.  <ul style="list-style-type: none"> ▪ Technical Information TI01555S ▪ Operating Instructions BA02053S ▪ Product page: www.endress.com/smt50
Field Xpert SMT70	Tablet PC for the configuration of the device. Enables mobile Plant Asset Management to manage the devices with a digital communication interface. Suitable for Zone 2.  <ul style="list-style-type: none"> ▪ Technical Information TI01342S ▪ Operating Instructions BA01709S ▪ Product page: www.endress.com/smt70
Field Xpert SMT77	Tablet PC for the configuration of the device. Enables mobile Plant Asset Management to manage the devices with a digital communication interface. Suitable for Zone 1.  <ul style="list-style-type: none"> ▪ Technical Information TI01418S ▪ Operating Instructions BA01923S ▪ Product page: www.endress.com/smt77

Service-specific accessory

Accessory	Description	Order code
Applicator	Software for selecting and sizing Endress+Hauser devices.	https://portal.endress.com/webapp/applicator
Netilion	IIoT ecosystem: Unlock knowledge With the Netilion IIoT ecosystem, Endress+Hauser allows you to optimize your plant performance, digitize workflows, share knowledge, and enhance collaboration. Based on decades of experience in process automation, Endress+Hauser offers the process industry an IIoT ecosystem that enables you to gain useful insights from data. These insights can be used to optimize processes, leading to increased plant availability, efficiency, and reliability - ultimately resulting in a more profitable plant.	www.netilion.endress.com

Accessory	Description	Order code
FieldCare	FDT-based plant asset management software from Endress+Hauser. Management and configuration of Endress+Hauser devices.  Operating Instructions BA00027S and BA00059S	<ul style="list-style-type: none"> ▪ Device driver: www.endress.com → Download Area ▪ CD-ROM (contact Endress+Hauser) ▪ DVD (contact Endress+Hauser)
DeviceCare	Software for connecting and configuring Endress+Hauser devices.  <ul style="list-style-type: none"> ▪ Technical Information: TI01134S ▪ Innovation brochure: IN01047S 	<ul style="list-style-type: none"> ▪ Device driver: www.endress.com → Download Area ▪ CD-ROM (contact Endress+Hauser) ▪ DVD (contact Endress+Hauser)

System components

Accessories	Description
Memograph M	Graphic data manager: <ul style="list-style-type: none"> ▪ Record measured values ▪ Monitor limit values ▪ Analyze measuring points  <ul style="list-style-type: none"> ▪ Technical Information TI00133R ▪ Operating Instructions BA00247R
iTEMP	Temperature transmitter: <ul style="list-style-type: none"> ▪ Measure the absolute pressure and gauge pressure of gases, vapors and liquids ▪ Read the medium temperature  "Fields of Activity" document FA00006T

17 Appendix

Examples of electric terminals

164

Examples of electric terminals

Current output 4 to 20 mA HART

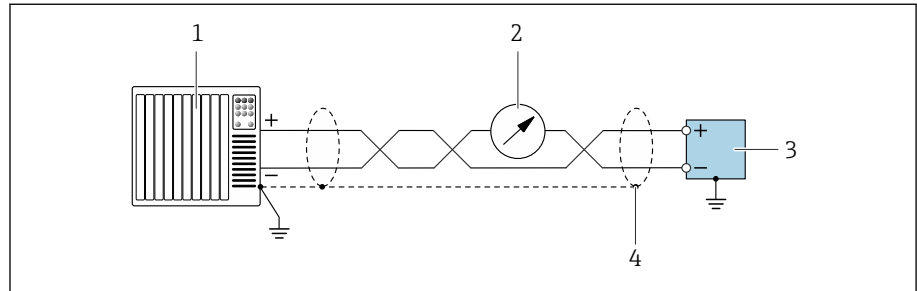

A0055862

17 Connection example for 4 to 20 mA current output with HART (active)

- 1 Automation system with 4 to 20 mA current input with HART (e.g. PLC)
- 2 Optional display unit: Note maximum load
- 3 Transmitter with 4 to 20 mA current output with HART (active)
- 4 Ground the cable shield on one side only. For installations in compliance with NAMUR NE98, grounding of the cable shield on both sides is required.

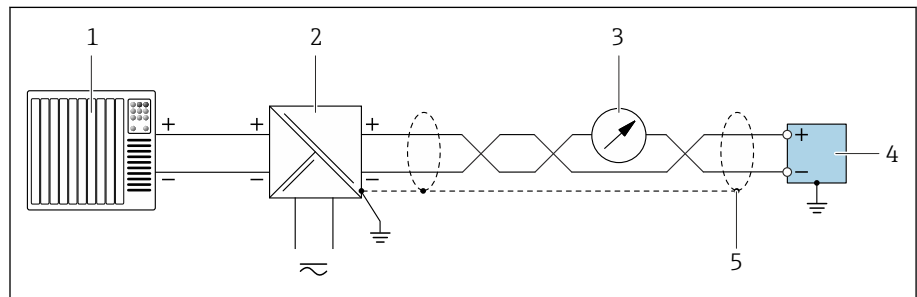

A0055861

18 Connection example for 4 to 20 mA current output with HART (passive)

- 1 Automation system with 4 to 20 mA current input with HART (e.g. PLC)
- 2 Power supply
- 3 Optional display unit: Note maximum load
- 4 Transmitter with 4 to 20 mA current output with HART (passive)
- 5 Ground the cable shield on one side only. For installations in compliance with NAMUR NE98, grounding of the cable shield on both sides is required.

Pulse output/frequency output/switch output

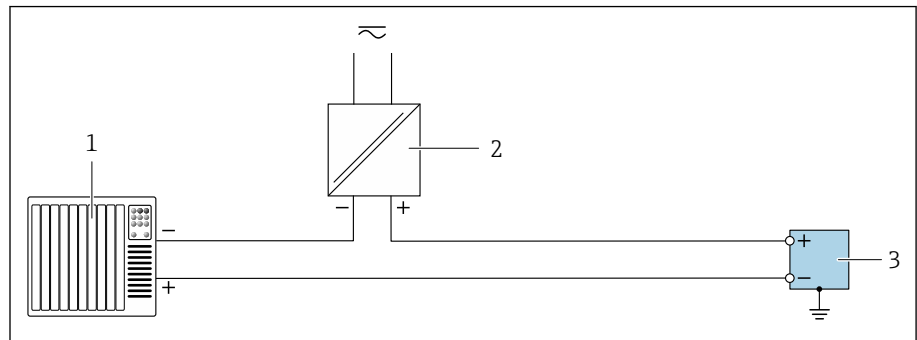

A0055855

19 Connection example for pulse output/frequency output/switch output (passive)

- 1 Automation system with pulse input/frequency input/switch input (e.g. PLC)
- 2 Power supply
- 3 Transmitter with pulse output/frequency output/switch output (passive)

Index

A

- Adapting the diagnostic behavior 79
- Ambient conditions
 - Vibration resistance and shock resistance 104
- Ambient temperature
 - Influence 103
- Ambient temperature range 104
- Applicator 92
- Approvals 115

C

- Certificates and approvals 115
- Certifications 115
- Check
 - Connection 52
- Checking the storage conditions (checklist) 21
- Checklist
 - Post-connection check 52
 - Post-mounting check 37
- Commissioning 65, 66
 - see Commissioning wizard
 - see Via local operation
 - see Via SmartBlue App
- Switching on the device 67
- Commissioning the device 68
- Compatibility 24
- Conductivity 106
- Connecting cable terminal assignment
 - Sensor connection housing 43
- Connecting the connecting cable
 - Sensor connection housing 43
 - Transmitter connection housing 44

D

- Date of manufacture 17, 18
- Degree of protection 104
- Design
 - Device 22
- Device
 - Design 22
 - Disposal 90
 - Removal 90
- Device components 22
- Device description files 62
- Device history 24
- Device locking, status 72
- Device name
 - Sensor 18
 - Transmitter 17
- Diagnosis
 - Symbols 77
- Diagnostic information
 - Design, description 78
 - DeviceCare 78
 - FieldCare 78
 - LED 75

- Local display 77
- Overview 80
- Remedial measures 80
- Diagnostic information in FieldCare or DeviceCare . . . 78
- Diagnostic information via LED 75
- Diagnostic list 83
- Diagnostic message 77
- Display
 - Current diagnostic event 83
 - Previous diagnostic event 83
- Display values
 - For locking status 72
- Disposal 89
- Disposing of the device 90

E

- Electromagnetic compatibility 105
- Electronics module 22
- Endress+Hauser services
 - Maintenance 88
- Environmental conditions
 - Ambient temperature 104
 - Storage temperature 104
- Error messages
 - see Diagnostic messages
- Event logbook 83
- Events list 83
- Extended order code
 - Sensor 18
 - Transmitter 17

F

- Filtering the event logbook 84
- Firmware history 24
- Fitted electrodes 113
- Flow limit 107

G

- Galvanic isolation 97
- General troubleshooting 74

H

- HART certification 117
- HART protocol
 - Device variables 62
 - Dynamic variables 62

I

- Identifying the device 17
- Incoming acceptance (checklist) 16
- Influence
 - Ambient temperature 103
- Influence of ambient temperature 103
- Input 92
- Inspection
 - Installation procedure 37
 - Received goods 16

- Intended use 16
- L**
- Local display
 see Diagnostic message
 see In alarm condition
- Local operation 68
- Low flow cut off 97
- M**
- Magnetism 31
- Magnetism and static electricity 31
- Main electronics module 22
- Maintenance tasks 88
 Replacing seals 88
- Materials 112
- Maximum measurement error 101
- Measured variable
 see Process variables
- Measured variables via HART protocol 62
- Measuring device
 Mounting the sensor
 Mounting grounding rings 32
- Measuring instrument
 Mounting the sensor
 Welding nipple 32
- Measuring principle 16
- Measuring range 92
- Measuring tube specification 111
- Medium temperature range 106
- N**
- Nameplate
 Sensor 18
 Transmitter 17
- Non-Ex approval 115
- O**
- Operable flow range 92
- Operation 71
- Order code 17, 18
- Output signal 94
- Output variables 94
- Overview of diagnostic information 80
- P**
- Packaging disposal 21
- Parameter settings
 Device management (Submenu) 72
- Pending diagnostic events 83
- Performance characteristics 101
- Pharmaceutical compatibility 116
- Post-connection check 66
- Post-connection check (checklist) 52
- Post-installation check 66
- Post-installation check and post-connection check 66
- Post-mounting check (checklist) 37
- Pressure Equipment Directive 115
- Pressure loss 110
- Pressure tightness 110
- Pressure/temperature ratings 108
- Process conditions
 Conductivity 106
 Flow limit 107
 Medium temperature 106
 Pressure loss 110
 Pressure tightness 110
 Pressure/temperature ratings 108
- Product design 22
- Product identification 17
- R**
- Radio approval 117
- Reading off the device locking status 72
- Reading out the event logbook 83
- Recycling of packaging materials 21
- Reference operating conditions 101
- Registered trademarks 9
- Removing the device 90
- Repeatability 103
- Replacement seals 88
- Replacing seals 88
- Resetting the device
 Settings 85
- S**
- Safety Instructions 11
- Sensor nameplate 18
- Serial number 17, 18
- Services 88
- Signal on alarm 97
- SmartBlue App 68
- Standards and guidelines 117
- Static electricity 31
- Status signals 77
- Storage 21
- Storage conditions 21
- Storage temperature 21, 104
- Storage temperature range 104
- Submenu
 Device management 72
 Events list 83
- Surface roughness 113
- Switching on the device 67
- System design
 see Device design
- System integration 61
- T**
- Temperature measurement response time 103
- Temperature range
 Storage temperature 21
- Tools
 Transport 19
- Transmitter nameplate 17
- Transport
 Transporting the device 19
- Troubleshooting
 General 74

U

- User operation 53
- Using the device
 - see Intended use

V

- Vibration resistance and shock resistance 104

W

- W@M Device Viewer 17
- Weight
 - Transport (notes) 19
- Wiring the sensor connection housing 43
- Wiring the transmitter housing 44



www.addresses.endress.com
