

Description of Device Parameters

Proline Promass 300

Coriolis flowmeter
HART

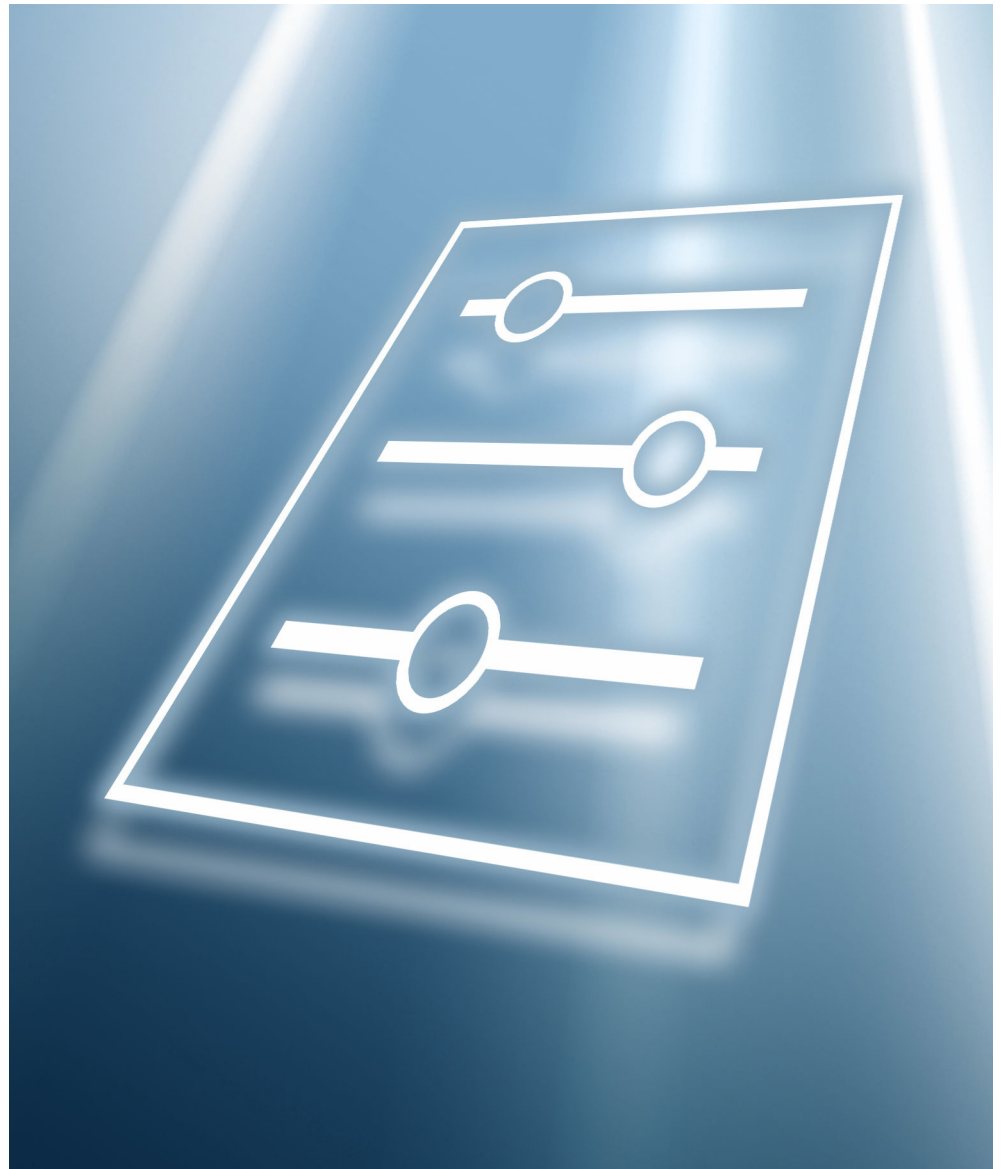

Table of contents

1	About this document	4		
1.1	Document function	4		
1.2	Target group	4		
1.3	Using this document	4		
1.3.1	Information on the document structure	4		
1.3.2	Structure of a parameter description	6		
1.4	Symbols used	6		
1.4.1	Symbols for certain types of information	6		
1.4.2	Symbols in graphics	7		
1.5	Documentation	7		
1.5.1	Standard documentation	7		
1.5.2	Supplementary device-dependent documentation	7		
2	Overview of the Expert operating menu	9		
3	Description of device parameters	12		
3.1	"System" submenu	15		
3.1.1	"Display" submenu	15		
3.1.2	"Configuration backup" submenu	34		
3.1.3	"Diagnostic handling" submenu	37		
3.1.4	"Administration" submenu	51		
3.2	"Sensor" submenu	57		
3.2.1	"Measured values" submenu	58		
3.2.2	"System units" submenu	89		
3.2.3	"Process parameters" submenu	100		
3.2.4	"Measurement mode" submenu	108		
3.2.5	"External compensation" submenu	111		
3.2.6	"Calculated values" submenu	114		
3.2.7	"Sensor adjustment" submenu	118		
3.2.8	"Calibration" submenu	137		
3.2.9	"Testpoints" submenu	139		
3.3	"I/O configuration" submenu	146		
3.4	"Input" submenu	148		
3.4.1	"Current input 1 to n" submenu	149		
3.4.2	"Status input 1 to n" submenu	152		
3.5	"Output" submenu	154		
3.5.1	"Current output 1 to n" submenu	154		
3.5.2	"Pulse/frequency/switch output 1 to n" submenu	169		
3.5.3	"Relay output 1 to n" submenu	190		
3.5.4	"Double pulse output" submenu	197		
3.6	"Communication" submenu	202		
3.6.1	"HART input" submenu	203		
3.6.2	"HART output" submenu	208		
3.6.3	"Diagnostic configuration" submenu	230		
3.6.4	"Web server" submenu	243		
3.6.5	"WLAN settings" wizard	247		
3.6.6	"OPC-UA configuration" submenu	253		
3.7	"Application" submenu	254		
3.7.1	"Totalizer 1 to n" submenu	255		
3.7.2	"Viscosity" submenu	259		
3.7.3	"Concentration" submenu	260		
3.7.4	"Custody transfer" submenu	260		
3.7.5	"Petroleum" submenu	260		
3.7.6	"Application specific calculations" submenu	260		
3.7.7	"Medium index" submenu	266		
3.8	"Diagnostics" submenu	269		
3.8.1	"Diagnostic list" submenu	272		
3.8.2	"Event logbook" submenu	276		
3.8.3	"Custody transfer logbook" submenu	278		
3.8.4	"Device information" submenu	278		
3.8.5	"Main electronic module + I/O module 1" submenu	282		
3.8.6	"Sensor electronic module (ISEM)" submenu	283		
3.8.7	"I/O module 2" submenu	284		
3.8.8	"I/O module 3" submenu	285		
3.8.9	"I/O module 4" submenu	286		
3.8.10	"Display module" submenu	287		
3.8.11	"Data logging" submenu	288		
3.8.12	"Min/max values" submenu	298		
3.8.13	"Heartbeat Technology" submenu	309		
3.8.14	"Simulation" submenu	321		
4	Country-specific factory settings	333		
4.1	SI units	333		
4.1.1	System units	333		
4.1.2	Full scale values	333		
4.1.3	Output current span	334		
4.1.4	Pulse value	334		
4.1.5	Switch-on point low flow cut off	334		
4.2	US units	335		
4.2.1	System units	336		
4.2.2	Full scale values	336		
4.2.3	Output current span	336		
4.2.4	Pulse value	337		
4.2.5	Switch-on point low flow cut off	337		
5	Explanation of abbreviated units	339		
5.1	SI units	339		
5.2	US units	339		
5.3	Imperial units	341		
	Index	342		

1 About this document

1.1 Document function

The document is part of the Operating Instructions and serves as a reference for parameters, providing a detailed explanation of each individual parameter of the Expert operating menu.

It is used to perform tasks that require detailed knowledge of the function of the device:

- Commissioning measurements under difficult conditions
- Optimal adaptation of the measurement to difficult conditions
- Detailed configuration of the communication interface
- Error diagnostics in difficult cases

1.2 Target group

The document is aimed at specialists who work with the device over the entire life cycle and perform specific configurations.

1.3 Using this document

1.3.1 Information on the document structure

The document lists the submenus and their parameters according to the structure from the **Expert** menu (→  9), which is displayed when the "**Maintenance**" user role is enabled.

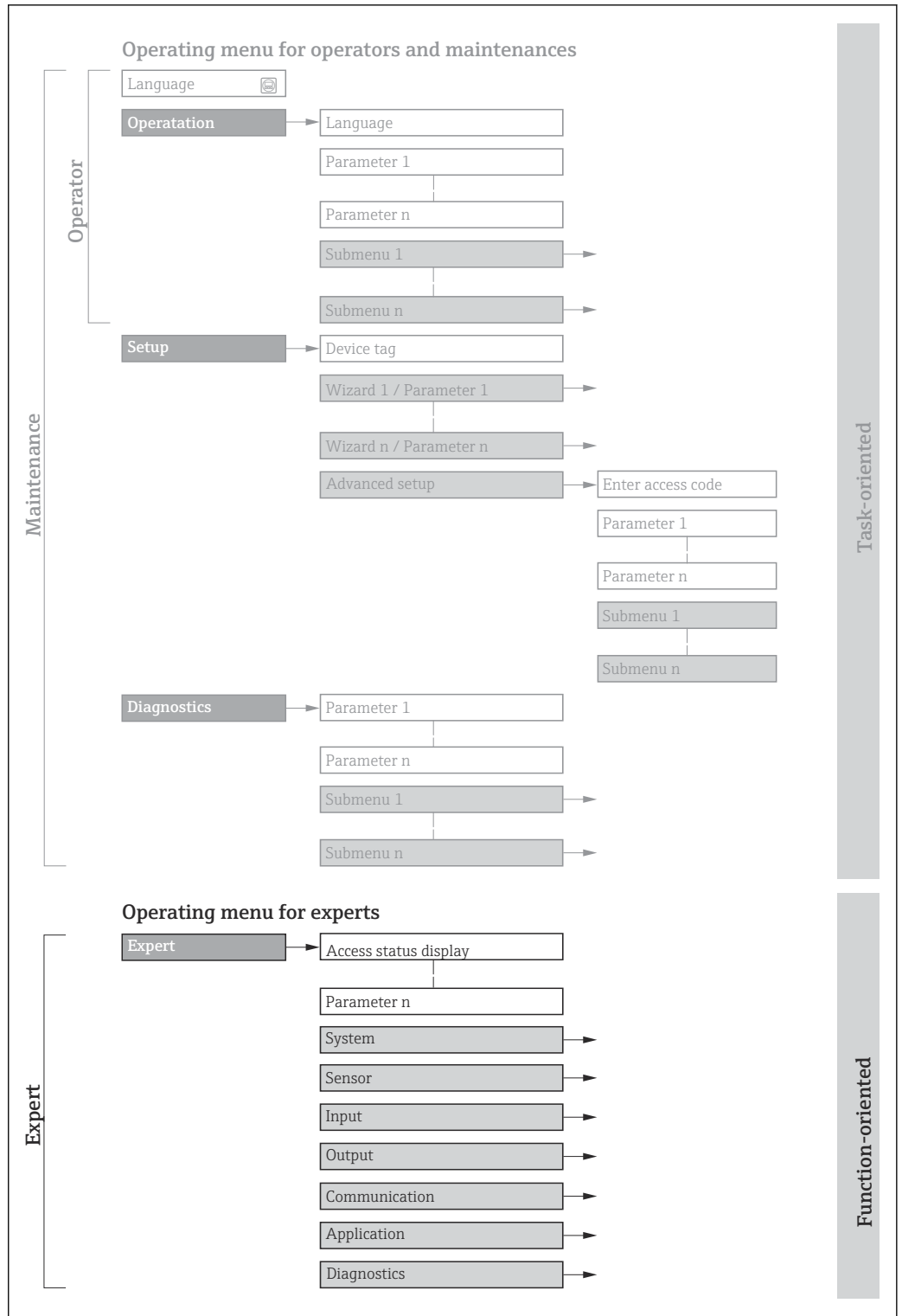



A0029160-EN

1 Sample graphic for the schematic layout of the operating menu

- Additional information regarding:
- The arrangement of the parameters according to the menu structure of the **Operation** menu, **Setup** menu, **Diagnostics** menu with a brief description: Operating Instructions → 7
 - Operating concept of the operating menus: Operating Instructions → 7







1.3.2 Structure of a parameter description

The individual parts of a parameter description are described in the following section:

Complete parameter name	Write-protected parameter = 
Navigation	 Navigation path to the parameter via the local display (direct access code) or web browser  Navigation path to the parameter via the operating tool The names of the menus, submenus and parameters are abbreviated to the form in which they appear on the display and in the operating tool.
Prerequisite	The parameter is only available under these specific conditions
Description	Description of the parameter function
Selection	List of the individual options for the parameter <ul style="list-style-type: none"> ■ Option 1 ■ Option 2
User entry	Parameter entry range
User interface	Display value/data of the parameter
Factory setting	Default setting ex works
Additional information	Additional explanations (e.g. in examples): <ul style="list-style-type: none"> ■ On individual options ■ On display values/data ■ On the input range ■ On the factory setting ■ On the parameter function

1.4 Symbols used

1.4.1 Symbols for certain types of information

Symbol	Meaning
	Tip Indicates additional information.
	Reference to documentation
	Reference to page
	Reference to graphic
 <small>A0028662</small>	Operation via local display
 <small>A0028663</small>	Operation via operating tool
 <small>A0028665</small>	Write-protected parameter

1.4.2 Symbols in graphics

Symbol	Meaning
1, 2, 3 ...	Item numbers
A, B, C, ...	Views
A-A, B-B, C-C, ...	Sections

1.5 Documentation

1.5.1 Standard documentation

Operating Instructions

Measuring device	Documentation code
Promass A 300 (8A3B**-...)	BA01482D
Promass A 300 (8A3C**-...)	BA01816D
Promass E 300	BA01484D
Promass F 300	BA01485D
Promass H 300	BA01486D
Promass I 300	BA01487D
Promass O 300	BA01488D
Promass P 300	BA01489D
Promass Q 300	BA01490D
Promass S 300	BA01491D
Promass X 300	BA01492D

1.5.2 Supplementary device-dependent documentation

Special Documentation

Contents	Documentation code
Information on the Pressure Equipment Directive	SD01614D
Remote display and operating module DKX001	SD01763D
Radio approvals for WLAN interface for A309/A310 display module	SD01793D
Web server	SD01662D
OPC-UA Server	SD02039D
Heartbeat Technology	SD01642D
Concentration measurement	SD01644D
Petroleum	SD02097D
Petroleum & locking function	SD02499D
Viscosity measurement Promass I	SD01646D
Custody transfer (counter for liquids other than water)	SD01688D
Custody transfer (counter for gas)	SD02415D
Custody transfer (counter for gas, in accordance with the German Measurement and Calibration Ordinance (Mess- und Eichverordnung))	SD02580D

Contents	Documentation code
Advanced density function	SD02354D
Overrun measurement	SD02342D

2 Overview of the Expert operating menu

The following table provides an overview of the menu structure of the expert operating menu and its parameters. The page reference indicates where the associated description of the submenu or parameter can be found.













▶ Expert	
Direct access (0106)	→ 12
Locking status (0004)	→ 13
User role (0005)	→ 14
Enter access code (0003)	→ 14
▶ System	→ 15
▶ Display	→ 15
▶ Configuration backup	→ 34
▶ Diagnostic handling	→ 37
▶ Administration	→ 51
▶ Sensor	→ 57
▶ Measured values	→ 58
▶ System units	→ 89
▶ Process parameters	→ 100
▶ Calculated values	→ 114
▶ Measurement mode	→ 108
▶ External compensation	→ 111
▶ Sensor adjustment	→ 118
▶ Calibration	→ 137
▶ Testpoints	→ 139
▶ I/O configuration	→ 146
I/O module 1 to n terminal numbers (3902-1 to n)	→ 146

I/O module 1 to n information (3906-1 to n)	→ 147
I/O module 1 to n type (3901-1 to n)	→ 147
Apply I/O configuration (3907)	→ 148
I/O alteration code (2762)	→ 148
▶ Input	→ 148
▶ Current input 1 to n	→ 149
▶ Status input 1 to n	→ 152
▶ Output	→ 154
▶ Current output 1 to n	→ 154
▶ Pulse/frequency/switch output 1 to n	→ 169
▶ Relay output 1 to n	→ 190
▶ Double pulse output	→ 197
▶ Communication	→ 202
▶ HART input	→ 203
▶ HART output	→ 208
▶ Diagnostic configuration	→ 230
▶ Web server	→ 243
▶ WLAN settings	→ 247
▶ OPC-UA configuration	→ 253
▶ Application	→ 254
Reset all totalizers (2806)	→ 254
▶ Totalizer 1 to n	→ 255
▶ Viscosity	→ 259
▶ Concentration	→ 260

▶ Custody transfer	→ 260
▶ Petroleum	→ 260
▶ Application specific calculations	→ 260
▶ Medium index	→ 266
▶ Diagnostics	→ 269
Actual diagnostics (0691)	→ 269
Previous diagnostics (0690)	→ 270
Operating time from restart (0653)	→ 271
Operating time (0652)	→ 271
▶ Diagnostic list	→ 272
▶ Event logbook	→ 276
▶ Custody transfer logbook	→ 278
▶ Device information	→ 278
▶ Main electronic module + I/O module 1	→ 282
▶ Sensor electronic module (ISEM)	→ 283
▶ I/O module 2	→ 284
▶ I/O module 3	→ 285
▶ Display module	→ 287
▶ Data logging	→ 288
▶ Min/max values	→ 298
▶ Heartbeat Technology	→ 309
▶ Simulation	→ 321

3 Description of device parameters

In the following section, the parameters are listed according to the menu structure of the local display. Specific parameters for the operating tools are included at the appropriate points in the menu structure.

 Expert		
Direct access (0106)		→  12
Locking status (0004)		→  13
User role (0005)		→  14
Enter access code (0003)		→  14
▶ System		→  15
▶ Sensor		→  57
▶ I/O configuration		→  146
▶ Input		→  148
▶ Output		→  154
▶ Communication		→  202
▶ Application		→  254
▶ Diagnostics		→  269

Direct access

Navigation

 Expert → Direct access (0106)

Description

Use this function to enter the access code to enable direct access to the desired parameter via the local display. A parameter number is assigned to each parameter for this purpose.

User entry

0 to 65 535

Additional information

User entry

The direct access code consists of a 5-digit number (at maximum) and the channel number, which identifies the channel of a process variable: e.g. 00914-2. In the navigation view, this appears on the right-hand side in the header of the selected parameter.

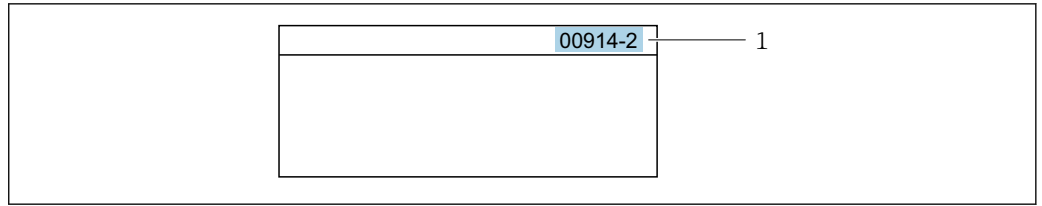

A0029414

1 Direct access code

Note the following when entering the direct access code:

- The leading zeros in the direct access code do not have to be entered.
Example: Enter "914" instead of "00914"
- If no channel number is entered, channel 1 is opened automatically.
Example: Enter 00914 → **Assign process variable** parameter
- If a different channel is opened: Enter the direct access code with the corresponding channel number.
Example: Enter 00914-2 → **Assign process variable** parameter

Locking status

Navigation Expert → Locking status (0004)

Description Displays the active write protection.

- User interface**
- Hardware locked
 - SIL locked
 - CT active - defined parameters
 - CT active - all parameters
 - Temporarily locked





Additional information *User interface*

If two or more types of write protection are active, the write protection with the highest priority is shown on the local display. In the operating tool all active types of write protection are displayed.







Detailed information on access authorization is provided in the "User roles and associated access authorization" and "Operating concept" sections of the Operations Instructions for the device → 7

Selection

Options	Description
None	The access authorization displayed in the Access status parameter (→ 14) applies . Only appears on local display.
Hardware locked (priority 1)	The DIP switch for hardware locking is activated on the PCB board. This locks write access to the parameters (e.g. via local display or operating tool) .
SIL locked (priority 2)	The SIL mode is enabled. This locks write access to the parameters (e.g. via local display or operating tool).

Options	Description
CT active - all parameters (priority 3)	 Only available for Promass F, O, Q and X. The DIP switch for custody transfer mode is activated on the PCB board. Locks the parameters that are relevant for custody transfer and also parameters that are predefined by Endress+Hauser and are not relevant for custody transfer (e.g. on local display or operating tool).  For detailed information on custody transfer mode, see the Special Documentation for the device →  7
CT active - defined parameters (priority 4)	The DIP switch for the custody transfer mode is activated on the PCB board. Only locks the parameters that are relevant for custody transfer (e.g. on the local display or operating tool).  For detailed information on custody transfer mode, see the Special Documentation for the device →  7
Temporarily locked (priority 5)	Write access to the parameters is temporarily locked on account of internal processes running in the device (e.g. data upload/download, reset, etc.). Once the internal processing has been completed, the parameters can be changed once again.

User role

Navigation	 Expert → User role (0005)
Description	Displays the access authorization to the parameters via the local display, Web browser or operating tool.
User interface	<ul style="list-style-type: none"> ▪ Maintenance ▪ Service
Factory setting	Maintenance
Additional information	<p><i>Description</i></p> <p> Access authorization can be modified via the Enter access code parameter (→  14).</p> <p> If additional write protection is active, this restricts the current access authorization even further.</p> <p><i>User interface</i></p> <p> Detailed information on access authorization is provided in the "User roles and associated access authorization" and "Operating concept" sections of the Operations Instructions for the device →  7</p>

Enter access code

Navigation	 Expert → Ent. access code (0003)
Description	Use this function to enter the user-specific release code to remove parameter write protection.

User entry

Max. 16-digit character string comprising numbers, letters and special characters

3.1 "System" submenu

Navigation  Expert → System

▶ System	
▶ Display	→ 15
▶ Configuration backup	→ 34
▶ Diagnostic handling	→ 37
▶ Administration	→ 51

3.1.1 "Display" submenu

Navigation  Expert → System → Display

▶ Display	
Display language (0104)	→ 16
Format display (0098)	→ 17
Value 1 display (0107)	→ 19
0% bargraph value 1 (0123)	→ 21
100% bargraph value 1 (0125)	→ 22
Decimal places 1 (0095)	→ 22
Value 2 display (0108)	→ 22
Decimal places 2 (0117)	→ 23
Value 3 display (0110)	→ 23
0% bargraph value 3 (0124)	→ 24
100% bargraph value 3 (0126)	→ 24
Decimal places 3 (0118)	→ 25

Value 4 display (0109)	→  25
Decimal places 4 (0119)	→  26
Value 5 display (0145)	→  26
Decimal places 5 (0149)	→  27
Value 6 display (0146)	→  28
Decimal places 6 (0150)	→  28
Value 7 display (0147)	→  29
Decimal places 7 (0151)	→  29
Value 8 display (0148)	→  30
Decimal places 8 (0152)	→  30
Display interval (0096)	→  31
Display damping (0094)	→  32
Header (0097)	→  32
Header text (0112)	→  33
Separator (0101)	→  33
Contrast display (0105)	→  34
Backlight (0111)	→  34

Display language

Navigation

  Expert → System → Display → Display language (0104)

Prerequisite

A local display is provided.

Description

Use this function to select the configured language on the local display.

Selection

- English
- Deutsch
- Français
- Español
- Italiano
- Nederlands

- Portuguesa
- Polski
- русский язык (Russian)
- Svenska
- Türkçe
- 中文 (Chinese)
- 日本語 (Japanese)
- 한국어 (Korean)
- tiếng Việt (Vietnamese)
- čeština (Czech)

Factory setting English (alternatively, the ordered language is preset in the device)

Format display

Navigation  Expert → System → Display → Format display (0098)

Prerequisite A local display is provided.

Description Use this function to select how the measured value is shown on the local display.





Selection

- 1 value, max. size
- 1 bargraph + 1 value
- 2 values
- 1 value large + 2 values
- 4 values

Factory setting 1 value, max. size

Additional information *Description*



The display format (size, bar graph etc.) and number of measured values displayed simultaneously (1 to 8) can be configured. This setting only applies to normal operation.

-  The **Value 1 display** parameter (→  19)...**Value 8 display** parameter (→  30) are used to specify which measured values are shown on the local display and in what order.
 - If more measured values are specified than the display mode selected permits, then the values alternate on the device display. The display time until the next change is configured using the **Display interval** parameter (→  31).

Custody transfer mode

 Only available for Promass F, O, Q and X.

- Once the measuring device has been enabled for custody transfer mode, depending on the custody transfer approval selected the display can switch between showing the relevant information and the custody transfer counter.
- In addition, a padlock symbol appears in the header of the display (.

 For detailed information on custody transfer mode, see the Special Documentation for the device →  7

Possible measured values shown on the local display:

"1 value, max. size" option



A0013099

"1 bargraph + 1 value" option

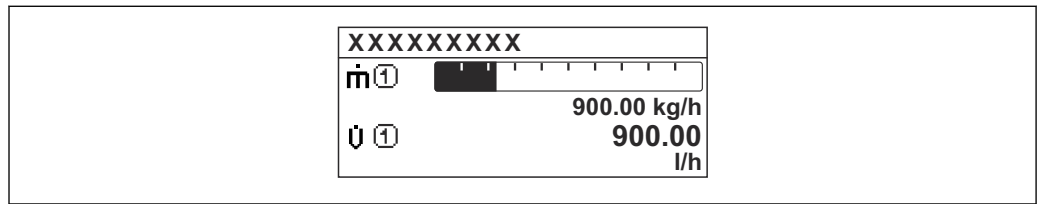

A0013098

"2 values" option

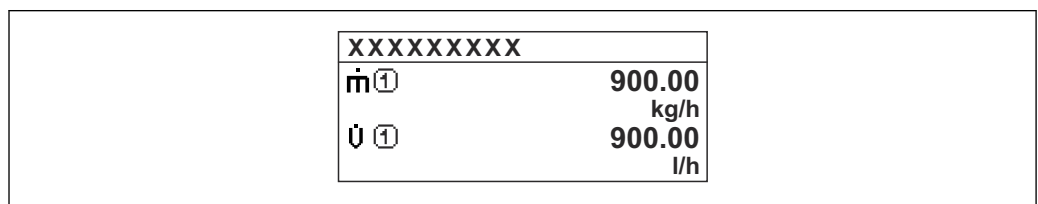

A0013100

"1 value large + 2 values" option

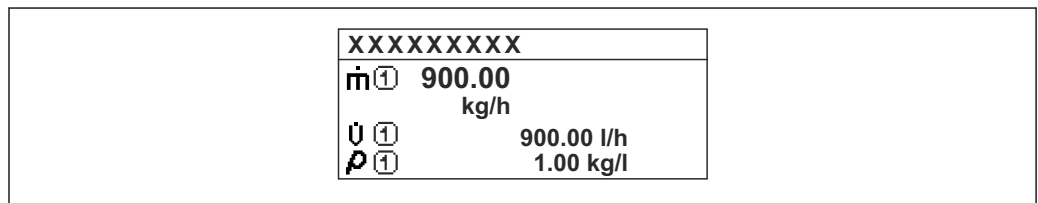

A0013102

"4 values" option

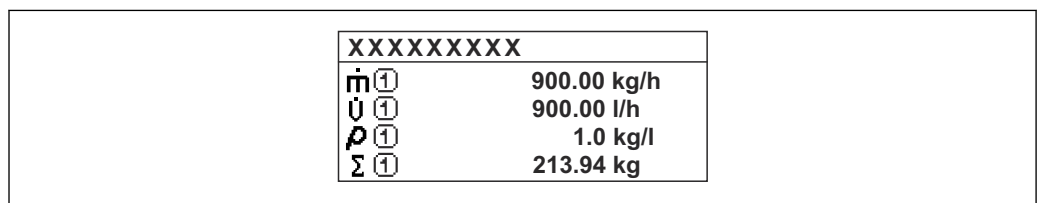

A0013103

**Value 1 display****Navigation**

Expert → System → Display → Value 1 display (0107)

Prerequisite

A local display is provided.

Description

Use this function to select one of the measured values shown on the local display.

Selection

- Mass flow
- Volume flow
- Corrected volume flow *
- Density
- Reference density *
- Density 2 *
- Time period signal frequency (TPS) *
- Time period signal (TPS) *
- Temperature
- Pressure
- Dynamic viscosity *
- Dynamic viscosity *
- Kinematic viscosity *
- Temp. compensated dynamic viscosity *
- Temp. compensated kinematic viscosity *
- Totalizer 1
- Totalizer 2
- Totalizer 3
- GSV flow *
- GSV flow alternative *
- NSV flow *
- NSV flow alternative *
- S&W volume flow *
- Reference density alternative *
- Weighted density average *
- Weighted temperature average *
- Water cut *
- Oil density *
- Water density *
- Oil mass flow *
- Water mass flow *
- Oil volume flow *
- Water volume flow *
- Oil corrected volume flow *
- Water corrected volume flow *
- Concentration *
- Target mass flow *
- Carrier mass flow *
- Target volume flow *
- Carrier volume flow *
- Target corrected volume flow *
- Carrier corrected volume flow *
- Application specific output 0 *
- Application specific output 1 *
- Inhomogeneous medium index
- Suspended bubbles index *
- HBSI *

* Visibility depends on order options or device settings



- Raw value mass flow
- Exciter current 0
- Exciter current 1 *
- Oscillation damping 0
- Oscillation damping 1 *
- Oscillation damping fluctuation 0 *
- Oscillation damping fluctuation 1 *
- Oscillation frequency 0
- Oscillation frequency 1 *
- Frequency fluctuation 0 *
- Frequency fluctuation 1 *
- Oscillation amplitude 0 *
- Oscillation amplitude 1 *
- Signal asymmetry
- Torsion signal asymmetry *
- Electronics temperature
- Sensor index coil asymmetry
- Test point 0
- Test point 1
- Current output 1
- Current output 2 *
- Current output 3 *
- Current output 4 *

Factory setting

Mass flow

Additional information*Description*

If several measured values are displayed at once, the measured value selected here will be the first value to be displayed. The value is only displayed during normal operation.

 The **Format display** parameter (→  17) is used to specify how many measured values are displayed simultaneously and how.

Custody transfer mode

 Only available for Promass F, O, Q and X.

* Visibility depends on order options or device settings

Once the measuring device has been enabled for custody transfer mode, depending on the custody transfer approval selected the display can switch to show the relevant information.



For detailed information on custody transfer mode, see the Special Documentation for the device → 7

Dependency



The unit of the displayed measured value is taken from the **System units** submenu (→ 89).

Selection

- **Oscillation frequency** option

Displays the current oscillation frequency of the measuring tubes. This frequency depends on the density of the medium.

- **Oscillation amplitude** option

Displays the relative oscillation amplitude of the measuring tubes in relation to the preset value. This value is 100 % under optimum conditions.

- **Oscillation damping** option

Displays the current oscillation damping. Oscillation damping is an indicator of the sensor's current need for excitation power.

- **Signal asymmetry** option

Displays the relative difference between the oscillation amplitude at the inlet and outlet of the sensor. The measured value is the result of production tolerances of the sensor coils and should remain constant over the life time of a sensor.

0% bargraph value 1

Navigation

Expert → System → Display → 0% bargraph 1 (0123)

Prerequisite

A local display is provided.

Description

Use this function to enter the 0% bar graph value to be shown on the display for the measured value 1.

User entry

Signed floating-point number

Factory setting

Country-specific:

- 0 kg/h
- 0 lb/min

Additional information

Description



The **Format display** parameter (→ 17) is used to specify that the measured value is to be displayed as a bar graph.

User entry



The unit of the displayed measured value is taken from the **System units** submenu (→ 89).

100% bargraph value 1







Navigation	Expert → System → Display → 100% bargraph 1 (0125)
Prerequisite	A local display is provided.
Description	Use this function to enter the 100% bar graph value to be shown on the display for the measured value 1.
User entry	Signed floating-point number
Factory setting	Depends on country and nominal diameter → 333
Additional information	<p><i>Description</i></p> <p> The Format display parameter (→ 17) is used to specify that the measured value is to be displayed as a bar graph.</p> <p><i>User entry</i></p> <p> The unit of the displayed measured value is taken from the System units submenu (→ 89).</p>

Decimal places 1





Navigation	Expert → System → Display → Decimal places 1 (0095)
Prerequisite	A measured value is specified in the Value 1 display parameter (→ 19).
Description	Use this function to select the number of decimal places for measured value 1.
Selection	<ul style="list-style-type: none"> ▪ x ▪ x.x ▪ x.xx ▪ x.xxx ▪ x.xxxx ▪ x.xxxxx ▪ x.xxxxxx
Factory setting	x.xx
Additional information	<p><i>Description</i></p> <p> This setting does not affect the accuracy of the device for measuring or calculating the value.</p>

Value 2 display





Navigation	Expert → System → Display → Value 2 display (0108)
Prerequisite	A local display is provided.

Description	Use this function to select a measured value that is shown on the local display.
Selection	For the picklist, see the Value 1 display parameter (→  19)
Factory setting	None
Additional information	<p><i>Description</i></p> <p>If several measured values are displayed at once, the measured value selected here will be the second value to be displayed. The value is only displayed during normal operation.</p> <p> The Format display parameter (→  17) is used to specify how many measured values are displayed simultaneously and how.</p> <p><i>Dependency</i></p> <p> The unit of the displayed measured value is taken from the System units submenu (→  89).</p>

Decimal places 2

Navigation	  Expert → System → Display → Decimal places 2 (0117)
Prerequisite	A measured value is specified in the Value 2 display parameter (→  22).
Description	Use this function to select the number of decimal places for measured value 2.
Selection	<ul style="list-style-type: none"> ■ x ■ x.x ■ x.xx ■ x.xxx ■ x.xxxx ■ x.xxxxx ■ x.xxxxxx
Factory setting	x.xx
Additional information	<p><i>Description</i></p> <p> This setting does not affect the accuracy of the device for measuring or calculating the value.</p>



Value 3 display

Navigation	  Expert → System → Display → Value 3 display (0110)
Prerequisite	A local display is provided.
Description	Use this function to select a measured value that is shown on the local display.
Selection	For the picklist, see the Value 1 display parameter (→  19)



Factory setting None

Additional information *Description*



If several measured values are displayed at once, the measured value selected here will be the third value to be displayed. The value is only displayed during normal operation.

 The **Format display** parameter (→  17) is used to specify how many measured values are displayed simultaneously and how.

Selection

 The unit of the displayed measured value is taken from the **System units** submenu (→  89).

0% bargraph value 3

Navigation   Expert → System → Display → 0% bargraph 3 (0124)



Prerequisite A selection was made in the **Value 3 display** parameter (→  23).

Description Use this function to enter the 0% bar graph value to be shown on the display for the measured value 3.

User entry Signed floating-point number

Factory setting Country-specific:
 ■ 0 kg/h
 ■ 0 lb/min



Additional information *Description*

 The **Format display** parameter (→  17) is used to specify that the measured value is to be displayed as a bar graph.

User entry

 The unit of the displayed measured value is taken from the **System units** submenu (→  89).

100% bargraph value 3

Navigation   Expert → System → Display → 100% bargraph 3 (0126)



Prerequisite A selection was made in the **Value 3 display** parameter (→  23).

Description Use this function to enter the 100% bar graph value to be shown on the display for the measured value 3.



User entry Signed floating-point number

Factory setting 0

Additional information*Description*

 The **Format display** parameter (→  17) is used to specify that the measured value is to be displayed as a bar graph.

User entry

 The unit of the displayed measured value is taken from the **System units** submenu (→  89).

Decimal places 3

**Navigation**

  Expert → System → Display → Decimal places 3 (0118)

Prerequisite

A measured value is specified in the **Value 3 display** parameter (→  23).

Description

Use this function to select the number of decimal places for measured value 3.

Selection

- x
- x.x
- x.xx
- x.xxx
- x.xxxx
- x.xxxxx
- x.xxxxxx

Factory setting

x.xx

Additional information*Description*

 This setting does not affect the accuracy of the device for measuring or calculating the value.

Value 4 display

**Navigation**

  Expert → System → Display → Value 4 display (0109)

Prerequisite

A local display is provided.

Description







Use this function to select a measured value that is shown on the local display.

Selection





For the picklist, see the **Value 1 display** parameter (→  19)

Factory setting



None









Additional information	<p><i>Description</i></p> <p>If several measured values are displayed at once, the measured value selected here will be the fourth value to be displayed. The value is only displayed during normal operation.</p> <p> The Format display parameter (→  17) is used to specify how many measured values are displayed simultaneously and how.</p> <p><i>Selection</i></p> <p> The unit of the displayed measured value is taken from the System units submenu (→  89).</p> <p><i>Custody transfer mode</i></p> <p> Only available for Promass F, O, Q and X.</p> <p>Once the measuring device has been enabled for custody transfer mode, depending on the custody transfer approval selected the display can switch to showing the custody transfer counter.</p> <p> For detailed information on custody transfer mode, see the Special Documentation for the device →  7</p>
-------------------------------	---

Decimal places 4





Navigation	  Expert → System → Display → Decimal places 4 (0119)
Prerequisite	A measured value is specified in the Value 4 display parameter (→  25).
Description	Use this function to select the number of decimal places for measured value 4.
Selection	<ul style="list-style-type: none"> ▪ X ▪ X.X ▪ X.XX ▪ X.XXX ▪ X.XXXX ▪ X.XXXXX ▪ X.XXXXXX
Factory setting	x.xx
Additional information	<p><i>Description</i></p> <p> This setting does not affect the accuracy of the device for measuring or calculating the value.</p>















Value 5 display

Navigation	  Expert → System → Display → Value 5 display (0145)
Prerequisite	A local display is provided.
Description	Use this function to select one of the measured values shown on the local display.

Selection	For the picklist, see the Value 1 display parameter (→  19)
Factory setting	None
Additional information	<p><i>Description</i></p> <p>If several measured values are displayed at once, the measured value selected here will be the fifth value to be displayed. The value is only displayed during normal operation.</p> <p> The Format display parameter (→  17) is used to specify how many measured values are displayed simultaneously and how.</p> <p><i>Selection</i></p> <p> The unit of the displayed measured value is taken from the System units submenu (→  89).</p> <p><i>Custody transfer mode</i></p> <p> Only available for Promass F, O, Q and X.</p> <p>Once the measuring device has been enabled for custody transfer mode, depending on the custody transfer approval selected the display can switch to showing the custody transfer counter.</p> <p> For detailed information on custody transfer mode, see the Special Documentation for the device →  7</p>









Decimal places 5

Navigation	  Expert → System → Display → Decimal places 5 (0149)
Prerequisite	A measured value is specified in the Value 5 display parameter (→  26).
Description	Use this function to select the number of decimal places for measured value 5.
Selection	<ul style="list-style-type: none"> ■ x ■ x.x ■ x.xx ■ x.xxx ■ x.xxxx ■ x.xxxxx ■ x.xxxxxx
Factory setting	x.xx
Additional information	<p><i>Description</i></p> <p> This setting does not affect the accuracy of the device for measuring or calculating the value.</p>



Value 6 display 	
Navigation	  Expert → System → Display → Value 6 display (0146)
Prerequisite	A local display is provided.
Description	Use this function to select one of the measured values shown on the local display.
Selection	For the picklist, see the Value 1 display parameter (→  19)
Factory setting	None
Additional information	<p><i>Description</i></p> <p>If several measured values are displayed at once, the measured value selected here will be the sixth value to be displayed. The value is only displayed during normal operation.</p> <p> The Format display parameter (→  17) is used to specify how many measured values are displayed simultaneously and how.</p> <p><i>Selection</i></p> <p> The unit of the displayed measured value is taken from the System units submenu (→  89).</p> <p><i>Custody transfer mode</i></p> <p> Only available for Promass F, O, Q and X.</p> <p>Once the measuring device has been enabled for custody transfer mode, depending on the custody transfer approval selected the display can switch to showing the custody transfer counter.</p> <p> For detailed information on custody transfer mode, see the Special Documentation for the device →  7</p>
Decimal places 6 	
Navigation	  Expert → System → Display → Decimal places 6 (0150)
Prerequisite	A measured value is specified in the Value 6 display parameter (→  28).
Description	Use this function to select the number of decimal places for measured value 6.
Selection	<ul style="list-style-type: none"> ■ x ■ x.x ■ x.xx ■ x.xxx ■ x.xxxx ■ x.xxxxx ■ x.xxxxxx
Factory setting	x.xx

Additional information	<p><i>Description</i></p> <p> This setting does not affect the accuracy of the device for measuring or calculating the value.</p>
-------------------------------	--

Value 7 display

Navigation	 Expert → System → Display → Value 7 display (0147)
Prerequisite	A local display is provided.
Description	Use this function to select one of the measured values shown on the local display.
Selection	For the picklist, see the Value 1 display parameter (→  19)
Factory setting	None
Additional information	<p><i>Description</i></p> <p>If several measured values are displayed at once, the measured value selected here will be the seventh value to be displayed. The value is only displayed during normal operation.</p> <p> The Format display parameter (→  17) is used to specify how many measured values are displayed simultaneously and how.</p> <p><i>Selection</i></p> <p> The unit of the displayed measured value is taken from the System units submenu (→  89).</p> <p><i>Custody transfer mode</i></p> <p> Only available for Promass F, O, Q and X.</p> <p>Once the measuring device has been enabled for custody transfer mode, depending on the custody transfer approval selected the display can switch to showing the custody transfer counter.</p> <p> For detailed information on custody transfer mode, see the Special Documentation for the device →  7</p>

Decimal places 7

Navigation	 Expert → System → Display → Decimal places 7 (0151)
Prerequisite	A measured value is specified in the Value 7 display parameter (→  29).
Description	Use this function to select the number of decimal places for measured value 7.
Selection	<ul style="list-style-type: none"> ■ x ■ x.x ■ x.xx ■ x.xxx

- X.XXXX
- X.XXXXX
- X.XXXXXX

Factory setting

x.xx

Additional information*Description*

This setting does not affect the accuracy of the device for measuring or calculating the value.

Value 8 display**Navigation**

Expert → System → Display → Value 8 display (0148)

Prerequisite

A local display is provided.

Description

Use this function to select a measured value that is shown on the local display.

SelectionFor the picklist, see the **Value 1 display** parameter (→ 19)**Factory setting**

None

Additional information*Description*

If several measured values are displayed at once, the measured value selected here will be the eighth value to be displayed. The value is only displayed during normal operation.



The **Format display** parameter (→ 17) is used to specify how many measured values are displayed simultaneously and how.

Selection

The unit of the displayed measured value is taken from the **System units** submenu (→ 89).

Custody transfer mode

Only available for Promass F, O, Q and X.

Once the measuring device has been enabled for custody transfer mode, depending on the custody transfer approval selected the display can switch to showing the custody transfer counter.



For detailed information on custody transfer mode, see the Special Documentation for the device → 7

Decimal places 8**Navigation**









Expert → System → Display → Decimal places 8 (0152)

PrerequisiteA measured value is specified in the **Value 8 display** parameter (→ 30).**Description**

Use this function to select the number of decimal places for measured value 8.

Selection	<ul style="list-style-type: none"> ▪ x ▪ x.x ▪ x.xx ▪ x.xxx ▪ x.xxxx ▪ x.xxxxx ▪ x.xxxxxx
Factory setting	x.xx
Additional information	<p><i>Description</i></p> <p> This setting does not affect the accuracy of the device for measuring or calculating the value.</p>

Display interval

Navigation	 Expert → System → Display → Display interval (0096)
Prerequisite	A local display is provided.
Description	Use this function to enter the length of time the measured values are displayed if the values alternate on the display.
User entry	1 to 10 s
Factory setting	5 s
Additional information	<p><i>Description</i></p> <p>This type of alternating display only occurs automatically if the number of measured values defined exceeds the number of values the selected display format can display simultaneously.</p> <p> ▪ The Value 1 display parameter (→  19)...Value 8 display parameter (→  30) are used to specify which measured values are shown on the local display.</p> <p>▪ The display format for the measured values displayed is defined in the Format display parameter (→  17).</p> <p><i>Custody transfer mode</i></p> <p> Only available for Promass F, O, Q and X.</p> <p>Once the measuring device has been enabled for custody transfer mode, depending on the custody transfer approval selected the display can switch between showing the relevant information and the custody transfer counter.</p> <p> For detailed information on custody transfer mode, see the Special Documentation for the device →  7</p>

Display damping

Navigation	Expert → System → Display → Display damping (0094)
Prerequisite	A local display is provided.
Description	Use this function to enter a time constant for the reaction time of the local display to fluctuations in the measured value caused by process conditions.
User entry	0.0 to 999.9 s
Factory setting	0.0 s
Additional information	<p><i>User entry</i></p> <p>Use this function to enter a time constant (PT1 element ¹⁾) for display damping:</p> <ul style="list-style-type: none"> ▪ If a low time constant is entered, the display reacts particularly quickly to fluctuating measured variables. ▪ On the other hand, the display reacts more slowly if a high time constant is entered. <p> Damping is switched off if 0 is entered (factory setting).</p>

Header

Navigation	Expert → System → Display → Header (0097)
Prerequisite	A local display is provided.
Description	Use this function to select the contents of the header of the local display.
Selection	<ul style="list-style-type: none"> ▪ Device tag ▪ Free text
Factory setting	Device tag
Additional information	<p><i>Description</i></p> <p>The header text only appears during normal operation.</p>

1) proportional transmission behavior with first order delay

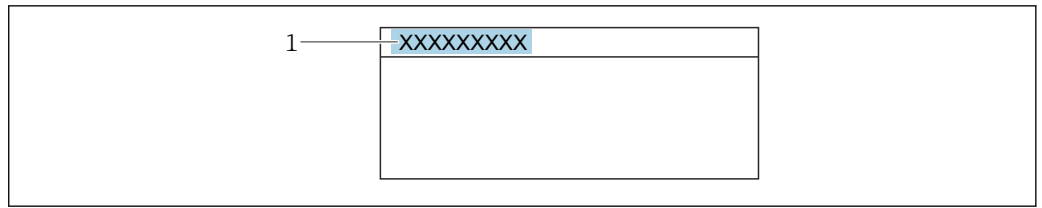

A0029422

1 Position of the header text on the display

Selection

- Device tag
Is defined in the **Device tag** parameter (→ 279).
- Free text
Is defined in the **Header text** parameter (→ 33).

Header text



Navigation

Expert → System → Display → Header text (0112)

Prerequisite

The **Free text** option is selected in the **Header** parameter (→ 32).

Description

Use this function to enter a customer-specific text for the header of the local display.

User entry

Max. 12 characters, such as letters, numbers or special characters (e.g. @, %, /)

Factory setting

Additional information

Description

The header text only appears during normal operation.

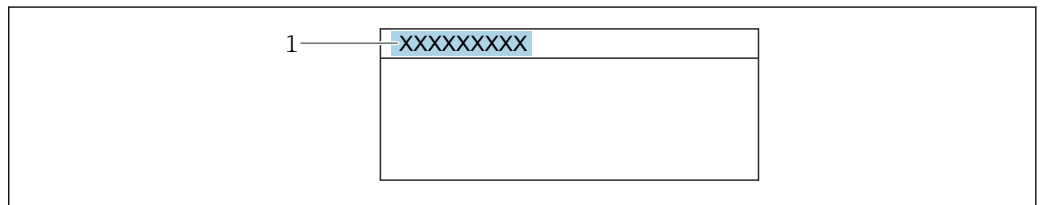

A0029422

1 Position of the header text on the display

User entry

The number of characters displayed depends on the characters used.

Separator



Navigation

Expert → System → Display → Separator (0101)

Prerequisite

A local display is provided.



Description Use this function to select the decimal separator.

Selection

- . (point)
- , (comma)

Factory setting . (point)

Contrast display

Navigation   Expert → System → Display → Contrast display (0105)

Prerequisite A local display is provided.

Description Use this function to enter a value to adapt the display contrast to the ambient conditions (e.g. the lighting or viewing angle).

User entry 20 to 80 %

Factory setting Depends on the display

Backlight

Navigation   Expert → System → Display → Backlight (0111)

Prerequisite One of the following conditions is met:

- Order code for "Display; operation", option **F** "4-line, illum.; touch control"
- Order code for "Display; operation", option **G** "4-line, illum.; touch control +WLAN"
- Order code for "Display; operation", option **O** "Remote display 4-line illuminated; 10m/30ft cable; touch control"

Description Use this function to switch the backlight of the local display on and off.

Selection





- Disable
- Enable

Factory setting Enable

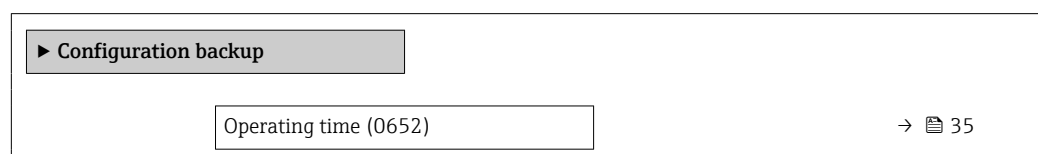

3.1.2 "Configuration backup" submenu

Navigation   Expert → System → Config. backup





Last backup (2757)	→  35
Configuration management (2758)	→  35
Backup state (2759)	→  36
Comparison result (2760)	→  36



Operating time

Navigation	  Expert → System → Config. backup → Operating time (0652)
Description	Use this function to display the length of time the device has been in operation.
User interface	Days (d), hours (h), minutes (m) and seconds (s)
Additional information	<i>User interface</i> The maximum number of days is 9999, which is equivalent to 27 years.

Last backup

Navigation	  Expert → System → Config. backup → Last backup (2757)
Description	Displays the time since a backup copy of the data was last saved to the device memory.
User interface	Days (d), hours (h), minutes (m) and seconds (s)

Configuration management

Navigation	  Expert → System → Config. backup → Config. managem. (2758)
Description	Use this function to select an action to save the data to the device memory.
Selection	<ul style="list-style-type: none"> ■ Cancel ■ Execute backup ■ Restore * ■ Compare * ■ Clear backup data
Factory setting	Cancel

* Visibility depends on order options or device settings

Additional information *Selection*

Options	Description
Cancel	No action is executed and the user exits the parameter.
Execute backup	A backup copy of the current device configuration is saved from the HistoROM backup to the memory of the device. The backup copy includes the transmitter data of the device. The following message appears on local display: Backup active, please wait!
Restore	The last backup copy of the device configuration is restored from the device memory to the device's HistoROM backup. The backup copy includes the transmitter data of the device. The following message appears on local display: Restore active! Do not interrupt power supply!
Compare	The device configuration saved in the device memory is compared with the current device configuration of the HistoROM backup. The following message appears on local display: Comparing files The result can be viewed in Comparison result parameter.
Clear backup data	The backup copy of the device configuration is deleted from the memory of the device. The following message appears on local display: Deleting file

HistoROM

A HistoROM is a "non-volatile" device memory in the form of an EEPROM.

Backup state

Navigation

 Expert → System → Config. backup → Backup state (2759)

Description

Displays the status of the data backup process.

User interface

- None
- Backup in progress
- Restoring in progress
- Delete in progress
- Compare in progress
- Restoring failed
- Backup failed

Factory setting

None

Comparison result

Navigation

 Expert → System → Config. backup → Compar. result (2760)

Description

Displays the last result of the comparison of the data records in the device memory and in the HistoROM.

User interface

- Settings identical
- Settings not identical
- No backup available



- Backup settings corrupt
- Check not done
- Dataset incompatible

Factory setting

Check not done

Additional information

Description

 The comparison is started via the **Compare** option in the **Configuration management** parameter (→  35).

Selection

Options	Description
Settings identical	The current device configuration of the HistoROM is identical to the backup copy in the device memory. If the transmitter configuration of another device has been transmitted to the device via HistoROM in the Configuration management parameter, the current device configuration of the HistoROM is only partially identical to the backup copy in the device memory: The settings for the transmitter are not identical.
Settings not identical	The current device configuration of the HistoROM is not identical to the backup copy in the device memory.
No backup available	There is no backup copy of the device configuration of the HistoROM in the device memory.
Backup settings corrupt	The current device configuration of the HistoROM is corrupt or not compatible with the backup copy in the device memory.
Check not done	The device configuration of the HistoROM has not yet been compared to the backup copy in the device memory.
Dataset incompatible	The backup copy in the device memory is not compatible with the device.

HistoROM

A HistoROM is a "non-volatile" device memory in the form of an EEPROM.

3.1.3 "Diagnostic handling" submenu

Navigation  Expert → System → Diagn. handling

▶ Diagnostic handling

Alarm delay (0651)

→  38

▶ Diagnostic behavior

→  38

Alarm delay**Navigation**

Expert → System → Diagn. handling → Alarm delay (0651)

Description

Use this function to enter the time interval until the device generates a diagnostic message.



The diagnostic message is reset without a time delay.

User entry

0 to 60 s

Factory setting

0 s

Additional information*Effect*

This setting affects the following diagnostic messages:



- 046 Sensor limit exceeded
- 140 Sensor signal asymmetrical
- 142 Sensor index coil asymmetry too high
- 311 Sensor electronics (ISEM) faulty
- 599 Custody transfer logbook full
- 830 Sensor temperature too high
- 831 Sensor temperature too low
- 832 Electronics temperature too high
- 833 Electronics temperature too low
- 834 Process temperature too high
- 835 Process temperature too low
- 843 Process limit
- 862 Partly filled pipe
- 912 Medium inhomogeneous
- 913 Medium unsuitable
- 915 Viscosity out of specification
- 944 Monitoring failed
- 984 Condensation risk



"Diagnostic behavior" submenu

Each item of diagnostic information is assigned a specific diagnostic behavior at the factory. The user can change this assignment for specific diagnostic information in the **Diagnostic behavior** submenu (→ 38).

The following options are available in the **Assign behavior of diagnostic no. xxx** parameters:

Options	Description
Alarm	The device stops measurement. The signal outputs and totalizers assume the defined alarm condition. A diagnostic message is generated. The background lighting changes to red.
Warning	The device continues to measure. The signal outputs and totalizers are not affected. A diagnostic message is generated.

Options	Description
Logbook entry only	The device continues to measure. The diagnostic message is displayed only in the Event logbook submenu (→  276) (Event list submenu (→  277)) and is not displayed in alternation with the operational display.
Off	The diagnostic event is ignored, and no diagnostic message is generated or entered.

 For a list of all the diagnostic events, see the Operating Instructions for the device →  7

Navigation  Expert → System → Diagn. handling → Diagn. behavior

► Diagnostic behavior	
Assign behavior of diagnostic no. 140 (0708)	→  41
Assign behavior of diagnostic no. 046 (0709)	→  41
Assign behavior of diagnostic no. 142 (0648)	→  41
Assign behavior of diagnostic no. 144 (0731)	→  42
Assign behavior of diagnostic no. 374 (0710)	→  42
Assign behavior of diagnostic no. 302 (0739)	→  42
Assign behavior of diagnostic no. 304 (0644)	→  43
Assign behavior of diagnostic no. 441 (0657)	→  43
Assign behavior of diagnostic no. 442 (0658)	→  43
Assign behavior of diagnostic no. 443 (0659)	→  44
Assign behavior of diagnostic no. 444 (0740)	→  44
Assign behavior of diagnostic no. 543 (0643)	→  44
Assign behavior of diagnostic no. 599 (0646)	→  45

Assign behavior of diagnostic no. 830 (0800)	→ 45
Assign behavior of diagnostic no. 831 (0641)	→ 45
Assign behavior of diagnostic no. 832 (0681)	→ 46
Assign behavior of diagnostic no. 833 (0682)	→ 46
Assign behavior of diagnostic no. 834 (0700)	→ 46
Assign behavior of diagnostic no. 835 (0702)	→ 47
Assign behavior of diagnostic no. 842 (0638)	→ 47
Assign behavior of diagnostic no. 862 (0679)	→ 48
Assign behavior of diagnostic no. 912 (0703)	→ 48
Assign behavior of diagnostic no. 913 (0712)	→ 48
Assign behavior of diagnostic no. 915 (0649)	→ 49
Assign behavior of diagnostic no. 941 (0632)	→ 49
Assign behavior of diagnostic no. 942 (0633)	→ 49
Assign behavior of diagnostic no. 943 (0634)	→ 50
Assign behavior of diagnostic no. 944 (0732)	→ 50
Assign behavior of diagnostic no. 948 (0744)	→ 51
Assign behavior of diagnostic no. 984 (0647)	→ 51

Assign behavior of diagnostic no. 140 (Sensor signal asymmetrical)

Navigation	Expert → System → Diagn. handling → Diagn. behavior → Diagnostic no. 140 (0708)
Description	Use this function to change the diagnostic behavior of the 140 Sensor signal asymmetrical diagnostic message.
Selection	<ul style="list-style-type: none"> ▪ Off ▪ Alarm ▪ Warning ▪ Logbook entry only
Factory setting	Alarm
Additional information	For a detailed description of the options available: → 38

Assign behavior of diagnostic no. 046 (Sensor limit exceeded)

Navigation	Expert → System → Diagn. handling → Diagn. behavior → Diagnostic no. 046 (0709)
Description	Use this function to change the diagnostic behavior of the 046 Sensor limit exceeded diagnostic message.
Selection	<ul style="list-style-type: none"> ▪ Off ▪ Alarm ▪ Warning ▪ Logbook entry only
Factory setting	Alarm
Additional information	For a detailed description of the options available: → 38

Assign behavior of diagnostic no. 142 (Sensor index coil asymmetry too high)

Navigation	Expert → System → Diagn. handling → Diagn. behavior → Diagnostic no. 142 (0648)
Description	Change behavior of diagnostic event with diagnostic number 142 'Sensor index coil asymmetry too high'.
Selection	<ul style="list-style-type: none"> ▪ Off ▪ Alarm ▪ Warning ▪ Logbook entry only
Factory setting	Logbook entry only

Assign behavior of diagnostic no. 144 (Measurement error too high)

Navigation	Expert → System → Diagn. handling → Diagn. behavior → Diagnostic no. 144 (0731)
Description	Change behavior of diagnostic event with diagnostic number 144 'Measurement error too high'.
Selection	<ul style="list-style-type: none"> ▪ Off ▪ Alarm ▪ Warning ▪ Logbook entry only
Factory setting	Alarm
Additional information	For a detailed description of the options available: → 38

Assign behavior of diagnostic no. 374 (Sensor electronics (ISEM) faulty)

Navigation	Expert → System → Diagn. handling → Diagn. behavior → Diagnostic no. 374 (0710)
Description	Use this function to change the diagnostic behavior of the 374 Sensor electronics (ISEM) faulty diagnostic message.
Selection	<ul style="list-style-type: none"> ▪ Off ▪ Alarm ▪ Warning ▪ Logbook entry only
Factory setting	Warning
Additional information	For a detailed description of the options available: → 38

Assign behavior of diagnostic no. 302 (Device verification active)

Navigation	Expert → System → Diagn. handling → Diagn. behavior → Diagnostic no. 302 (0739)
Description	Use this function to change the diagnostic behavior of the 302 Device verification active diagnostic message.
Selection	<ul style="list-style-type: none"> ▪ Off ▪ Warning ▪ Logbook entry only
Factory setting	Warning
Additional information	For a detailed description of the options available: → 38

Assign behavior of diagnostic no. 304

Navigation	Expert → System → Diagn. handling → Diagn. behavior → Diagnostic no. 304 (0644)
Description	Change behavior of diagnostic event with diagnostic number 304 'Device verification failed'.
Selection	<ul style="list-style-type: none"> ▪ Off ▪ Alarm ▪ Warning ▪ Logbook entry only
Factory setting	Warning

Assign behavior of diagnostic no. 441 (Current output 1 to n)

Navigation	Expert → System → Diagn. handling → Diagn. behavior → Diagnostic no. 441 (0657)
Description	Use this function to change the diagnostic behavior of the 441 Current output 1 to n diagnostic message.
Selection	<ul style="list-style-type: none"> ▪ Off ▪ Alarm ▪ Warning ▪ Logbook entry only
Factory setting	Warning
Additional information	For a detailed description of the options available: → 38

Assign behavior of diagnostic no. 442 (Frequency output 1 to n)

Navigation	Expert → System → Diagn. handling → Diagn. behavior → Diagnostic no. 442 (0658)
Prerequisite	The measuring device has a pulse/frequency/switch output.
Description	Use this function to change the diagnostic behavior of the 442 Frequency output 1 to n diagnostic message.
Selection	<ul style="list-style-type: none"> ▪ Off ▪ Alarm ▪ Warning ▪ Logbook entry only
Factory setting	Warning
Additional information	For a detailed description of the options available: → 38

Assign behavior of diagnostic no. 443 (Pulse output 1 to n)

Navigation	Expert → System → Diagn. handling → Diagn. behavior → Diagnostic no. 443 (0659)
Prerequisite	The measuring device has a pulse/frequency/switch output.
Description	Use this function to change the diagnostic behavior of the 443 Pulse output 1 to n diagnostic message.
Selection	<ul style="list-style-type: none"> ▪ Off ▪ Alarm ▪ Warning ▪ Logbook entry only
Factory setting	Warning
Additional information	For a detailed description of the options available: → 38

Assign behavior of diagnostic no. 444 (Current input 1 to n)

Navigation	Expert → System → Diagn. handling → Diagn. behavior → Diagnostic no. 444 (0740)
Prerequisite	The device has one current input.
Description	Use this function to change the diagnostic behavior of the 444 Current input 1 to n diagnostic message.
Selection	<ul style="list-style-type: none"> ▪ Off ▪ Alarm ▪ Warning ▪ Logbook entry only
Factory setting	Warning
Additional information	For a detailed description of the options available: → 38

Assign behavior of diagnostic no. 543 (Double pulse output)

Navigation	Expert → System → Diagn. handling → Diagn. behavior → Diagnostic no. 543 (0643)
Description	Use this function to change the diagnostic behavior of the 543 Double pulse output diagnostic message.
Selection	<ul style="list-style-type: none"> ▪ Off ▪ Alarm ▪ Warning ▪ Logbook entry only

Factory setting Warning

Additional information  For a detailed description of the options available: →  38

Assign behavior of diagnostic no. 599 (Custody transfer logbook full)

Navigation   Expert → System → Diagn. handling → Diagn. behavior → Diagnostic no. 599 (0646)

Description Use this function to select the diagnostic behavior of the **△S599 Custody transfer logbook full** diagnostic message

Selection

- Off
- Alarm
- Warning
- Logbook entry only

Factory setting Warning

Assign behavior of diagnostic no. 830 (Sensor temperature too high)



Navigation   Expert → System → Diagn. handling → Diagn. behavior → Diagnostic no. 830 (0800)

Description Use this function to change the diagnostic behavior of the **830 Sensor temperature too high** diagnostic message.

Selection

- Off
- Alarm
- Warning
- Logbook entry only

Factory setting Warning

Additional information  For a detailed description of the options available: →  38

Assign behavior of diagnostic no. 831 (Sensor temperature too low)

Navigation   Expert → System → Diagn. handling → Diagn. behavior → Diagnostic no. 831 (0641)

Description Use this function to change the diagnostic behavior of the **831 Sensor temperature too low** diagnostic message.

Selection

- Off
- Alarm
- Warning
- Logbook entry only

Factory setting

Warning

Additional information

For a detailed description of the options available: → 38

Assign behavior of diagnostic no. 832 (Electronics temperature too high)**Navigation**

Expert → System → Diagn. handling → Diagn. behavior → Diagnostic no. 832 (0681)

DescriptionUse this function to change the diagnostic behavior of the **832 Electronics temperature too high** diagnostic message.**Selection**

- Off
- Alarm
- Warning
- Logbook entry only

Factory setting

Logbook entry only

Additional information

For a detailed description of the options available: → 38

Assign behavior of diagnostic no. 833 (Electronics temperature too low)**Navigation**

Expert → System → Diagn. handling → Diagn. behavior → Diagnostic no. 833 (0682)

DescriptionUse this function to change the diagnostic behavior of the **833 Electronics temperature too low** diagnostic message.**Selection**

- Off
- Alarm
- Warning
- Logbook entry only

Factory setting

Logbook entry only



Additional information

For a detailed description of the options available: → 38





Assign behavior of diagnostic no. 834 (Process temperature too high)**Navigation**

Expert → System → Diagn. handling → Diagn. behavior → Diagnostic no. 834 (0700)





DescriptionUse this function to change the diagnostic behavior of the **834 Process temperature too high** diagnostic message.

Selection	<ul style="list-style-type: none"> ▪ Off ▪ Alarm ▪ Warning ▪ Logbook entry only
Factory setting	Warning
Additional information	 For a detailed description of the options available: →  38

Assign behavior of diagnostic no. 835 (Process temperature too low)

Navigation	  Expert → System → Diagn. handling → Diagn. behavior → Diagnostic no. 835 (0702)
Description	Use this function to change the diagnostic behavior of the 835 Process temperature too low diagnostic message.
Selection	<ul style="list-style-type: none"> ▪ Off ▪ Alarm ▪ Warning ▪ Logbook entry only
Factory setting	Warning
Additional information	 For a detailed description of the options available: →  38

Assign behavior of diagnostic no. 842 (Process limit)

Navigation	  Expert → System → Diagn. handling → Diagn. behavior → Diagnostic no. 842 (0638)
Description	Use this function to change the diagnostic behavior of the 842 Process limit diagnostic message.
Selection	<ul style="list-style-type: none"> ▪ Off ▪ Alarm ▪ Warning ▪ Logbook entry only
Factory setting	Off
Additional information	 For a detailed description of the options available: →  38

Assign behavior of diagnostic no. 862 (Empty pipe)



Navigation	Expert → System → Diagn. handling → Diagn. behavior → Diagnostic no. 862 (0679)
Description	Use this function to change the diagnostic behavior of the 862 Empty pipe diagnostic message.
Selection	<ul style="list-style-type: none">▪ Off▪ Alarm▪ Warning▪ Logbook entry only
Factory setting	Warning
Additional information	For a detailed description of the options available: → 38

Assign behavior of diagnostic no. 912 (Medium inhomogeneous)



Navigation	Expert → System → Diagn. handling → Diagn. behavior → Diagnostic no. 912 (0703)
Description	Use this function to change the diagnostic behavior of the 912 Medium inhomogeneous diagnostic message.
Selection	<ul style="list-style-type: none">▪ Off▪ Alarm▪ Warning▪ Logbook entry only
Factory setting	Warning
Additional information	For a detailed description of the options available: → 38

Assign behavior of diagnostic no. 913 (Medium unsuitable)



Navigation	Expert → System → Diagn. handling → Diagn. behavior → Diagnostic no. 913 (0712)
Description	Use this function to change the diagnostic behavior of the 913 Medium unsuitable diagnostic message.
Selection	<ul style="list-style-type: none">▪ Off▪ Alarm▪ Warning▪ Logbook entry only
Factory setting	Warning
Additional information	For a detailed description of the options available: → 38

Assign behavior of diagnostic no. 915 (Viscosity out of specification)

Navigation	Expert → System → Diagn. handling → Diagn. behavior → Diagnostic no. 915 (0649)
Description	Change behavior of diagnostic event with diagnostic number 915 'Viscosity out of specification'.
Selection	<ul style="list-style-type: none"> ▪ Off ▪ Alarm ▪ Warning ▪ Logbook entry only
Factory setting	Logbook entry only

Assign behavior of diagnostic no. 941 (API/ASTM temperature outside specification)

Navigation	Expert → System → Diagn. handling → Diagn. behavior → Diagnostic no. 941 (0632)
Prerequisite	For the following order code: "Application package", option EJ "Petroleum"
Description	Use this function to change the diagnostic behavior of the diagnostic message 'API/ASTM temperature outside specification'.
Selection	<ul style="list-style-type: none"> ▪ Off ▪ Alarm ▪ Warning ▪ Logbook entry only
Factory setting	Warning
Additional information	For a detailed description of the options available: → 38

Assign behavior of diagnostic no. 942 (API/ASTM density out of specification)

Navigation	Expert → System → Diagn. handling → Diagn. behavior → Diagnostic no. 942 (0633)
Prerequisite	For the following order code: "Application package", option EJ "Petroleum"
Description	Use this function to change the diagnostic behavior of 'API/ASTM temperature outside specification'.
Selection	<ul style="list-style-type: none"> ▪ Off ▪ Alarm ▪ Warning ▪ Logbook entry only

Factory setting

Warning

Additional information

For a detailed description of the options available: → 38

Assign behavior of diagnostic no. 943 (API/ASTM pressure outside specification)**Navigation**

Expert → System → Diagn. handling → Diagn. behavior → Diagnostic no. 943 (0634)

Prerequisite

For the following order code:

"Application package", option EJ "Petroleum"

Description

Use this function to change the diagnostic behavior of 'API/ASTM pressure outside specification'.

Selection

- Off
- Alarm
- Warning
- Logbook entry only

Factory setting

Warning

Additional information

For a detailed description of the options available: → 38

Assign behavior of diagnostic no. 944 (Monitoring failed)**Navigation**

Expert → System → Diagn. handling → Diagn. behavior → Diagnostic no. 944 (0732)

DescriptionUse this function to change the diagnostic behavior of the **944 Monitoring failed** diagnostic message.**Selection**

- Off
- Alarm
- Warning
- Logbook entry only

Factory setting

Warning

Additional information

For a detailed description of the options available: → 38

Assign behavior of diagnostic no. 948 (Oscillation damping too high)



Navigation	Expert → System → Diagn. handling → Diagn. behavior → Diagnostic no. 948 (0744)
Description	Use this function to change the diagnostic behavior of the 948 Oscillation damping too high diagnostic message.
Selection	<ul style="list-style-type: none"> ▪ Off ▪ Alarm ▪ Warning ▪ Logbook entry only
Factory setting	Warning
Additional information	For a detailed description of the options available: → 38

Assign behavior of diagnostic no. 984 (Condensation risk)



Navigation	Expert → System → Diagn. handling → Diagn. behavior → Diagnostic no. 984 (0647)
Description	Change behavior of diagnostic event with diagnostic number 984 'Condensation risk'.
Selection	<ul style="list-style-type: none"> ▪ Off ▪ Alarm ▪ Warning ▪ Logbook entry only
Factory setting	Warning

3.1.4 "Administration" submenu

Navigation Expert → System → Administration

▶ Administration

▶ Define access code → 52

▶ Reset access code → 53

Device reset (0000) → 54

Transmitter identifier (2765) → 55

Activate SW option (0029)	→ 55
Software option overview (0015)	→ 56

"Define access code" wizard



 The **Define access code** wizard (→ 52) is only available when operating via the local display or Web browser.

If operating via the operating tool, the **Define access code** parameter can be found directly in the **Administration** submenu. There is no **Confirm access code** parameter if the device is operated via the operating tool.

Navigation  Expert → System → Administration → Def. access code

▶ Define access code	
Define access code	→ 52
Confirm access code	→ 53

Define access code

Navigation   Expert → System → Administration → Def. access code → Def. access code

Description Use this function to enter a user-specific release code to restrict write-access to the parameters. This protects the device configuration against any inadvertent modifications via the local display, Web browser, FieldCare or DeviceCare (via CDI-RJ45 service interface).

User entry Max. 16-digit character string comprising numbers, letters and special characters

Additional information *Description*

The write protection affects all parameters in the document marked with the  symbol.

On the local display, the  symbol in front of a parameter indicates that the parameter is write-protected.

The parameters that cannot be write-accessed are grayed out in the Web browser.

 Once the access code has been defined, write-protected parameters can only be modified if the access code is entered in the **Enter access code** parameter (→ 14).

 If you lose the access code, please contact your Endress+Hauser sales organization.

User entry

A message is displayed if the access code is not in the input range.

Factory setting

If the factory setting is not changed or **0** is defined as the access code, the parameters are not write-protected and the device configuration data can be modified. The user is logged on in the **"Maintenance"** role.

Confirm access code



Navigation	Expert → System → Administration → Def. access code → Confirm code
Description	Enter the defined release code a second time to confirm the release code.
User entry	Max. 16-digit character string comprising numbers, letters and special characters

"Reset access code" submenu

Navigation Expert → System → Administration → Reset acc. code

▶ **Reset access code**

Operating time (0652)	→ 53
Reset access code (0024)	→ 53

Operating time

Navigation	Expert → System → Administration → Reset acc. code → Operating time (0652)
Description	Use this function to display the length of time the device has been in operation.
User interface	Days (d), hours (h), minutes (m) and seconds (s)
Additional information	<i>User interface</i> The maximum number of days is 9999, which is equivalent to 27 years.

Reset access code

Navigation	Expert → System → Administration → Reset acc. code → Reset acc. code (0024)
Description	Use this function to enter a reset code to reset the user-specific access codes to the factory setting .
User entry	Character string comprising numbers, letters and special characters
Factory setting	0x00

Additional information*Description*

For a reset code, contact your Endress+Hauser service organization.

User entry

The reset code can only be entered via:

- Web browser
- DeviceCare, FieldCare (via CDI RJ45 interface)
- Fieldbus

Additional parameters in the "Administration" submenu**Device reset****Navigation**

Expert → System → Administration → Device reset (0000)

Description

Reset the device configuration - either entirely or in part - to a defined state.

Selection

- Cancel
- To delivery settings
- Restart device
- Restore S-DAT backup *

Factory setting



Cancel

Additional information*Options*





Options	Description
Cancel	No action is executed and the user exits the parameter.
To delivery settings	Every parameter for which a customer-specific default setting was ordered is reset to the customer-specific value. All other parameters are reset to the factory setting.
Restart device	The restart resets every parameter with data stored in volatile memory (RAM) to the factory setting (e.g. measured value data). The device configuration remains unchanged.
Restore S-DAT backup	Restores the data that is saved on the S-DAT. Additional information: This function can be used to resolve the memory issue "083 Memory content inconsistent" or to restore the S-DAT data when a new S-DAT has been installed. This option is displayed only in an alarm condition.

* Visibility depends on order options or device settings

Transmitter identifier 

Navigation	  Expert → System → Administration → Transm. identif. (2765)
Description	Select transmitter identifier.
User interface	<ul style="list-style-type: none"> ■ Unknown ■ 500 ■ 300
Factory setting	300

Activate SW option 

Navigation	  Expert → System → Administration → Activate SW opt. (0029)
Description	Use this function to enter an activation code to enable an additional, ordered software option.
User entry	Max. 10-digit string consisting of numbers.
Factory setting	Depends on the software option ordered
Additional information	<p><i>Description</i></p> <p>If a measuring device was ordered with an additional software option, the activation code is programmed in the device at the factory.</p> <p><i>User entry</i></p> <p> To activate a software option subsequently, please contact your Endress+Hauser sales organization.</p> <p>NOTE!</p> <p>The activation code is linked to the serial number of the measuring device and varies according to the device and software option.</p> <p>If an incorrect or invalid code is entered, this results in the loss of software options that have already been activated.</p> <ul style="list-style-type: none"> ▶ Before you enter a new activation code, make a note of the current activation code . ▶ Enter the new activation code provided by Endress+Hauser when the new software option was ordered. ▶ Once the activation code has been entered, check if the new software option is displayed in the Software option overview parameter (→  56). ↳ The new software option is active if it is displayed. ↳ If the new software option is not displayed or all software options have been deleted, the code entered was either incorrect or invalid. ▶ If the code entered is incorrect or invalid, enter the old activation code .

- ▶ Have your Endress+Hauser sales organization check the new activation code remembering to specify the serial number or ask for the code again.

Example for a software option

Order code for "Application package", option **EA** "Extended HistoROM"

 The software options currently enabled are displayed in the **Software option overview** parameter (→  56).

Web browser

 Once a software option has been activated, the page must be loaded again in the Web browser.

Software option overview

Navigation

 Expert → System → Administration → SW option overv. (0015)

Description

Displays all the software options that are enabled in the device.

User interface

- Extended HistoROM *
- SIL *
- Petroleum *
- Concentration *
- Viscosity/Hydrocarbon viscosity monitor. *
- Custody transfer *
- OPC-UA *
- Application specific calculations *
- Heartbeat Monitoring *
- Heartbeat Verification *
- Extended density function *

Additional information

Description

Displays all the options that are available if ordered by the customer.

"Extended HistoROM" option

Order code for "Application package", option EA "Extended HistoROM"

"SIL" option

Order code for "Additional approval", option LA "SIL"

"Heartbeat Verification" option and "Heartbeat Monitoring" option

Order code for "Application package", option EB "Heartbeat Verification + Monitoring"

"Concentration" option

Order code for "Application package", option ED "Concentration" and option EE "Special density"

"Viscosity" option

 Only available for Promass I.

* Visibility depends on order options or device settings

Order code for "Application package", option EG "Viscosity"

"Custody transfer" option

The measuring device has an approval for custody transfer measurement.

 Detailed information on the national and international approvals for custody transfer that are currently available can be supplied by your Endress+Hauser sales organization.

"Petroleum" option

 Only available for Promass E, F, O, Q and X.

Order code for "Application package", option EJ "Petroleum"

"OPC-UA" option

 Only available for the HART communication protocol.

Order code for "Application package", option EL "OPC-UA Server"

"Extended density function" option

 Only available for Promass Q DN25 to DN100.

Order code for "Application package", option EH "Extended density function"

Option "Premium density + Extended density function"

 Only available for Promass Q DN25.

Order code for "Application package", option EI "Premium density, ±0.1 kg/m³ + Extended density function"

3.2 "Sensor" submenu

Navigation  Expert → Sensor

▶ Sensor	
▶ Measured values	→ 58
▶ System units	→ 89
▶ Process parameters	→ 100
▶ Calculated values	→ 114
▶ Measurement mode	→ 108
▶ External compensation	→ 111
▶ Sensor adjustment	→ 118

▶ Calibration	→ 137
▶ Testpoints	→ 139

3.2.1 "Measured values" submenu

Navigation   Expert → Sensor → Measured val.













▶ Measured values	
▶ Process variables	→ 58
▶ Totalizer	→ 81
▶ Input values	→ 83
▶ Output values	→ 85

"Process variables" submenu



Navigation   Expert → Sensor → Measured val. → Process variab.

▶ Process variables	
Mass flow	→ 60
Volume flow	→ 60
Corrected volume flow	→ 61
Density	→ 61
Reference density	→ 61
Temperature	→ 62
Pressure	→ 62
Dynamic viscosity	→ 62
Kinematic viscosity	→ 63
Temp. compensated dynamic viscosity	→ 63
Temp. compensated kinematic viscosity	→ 63
Concentration	→ 64

Target mass flow	→ 64
Carrier mass flow	→ 65
Target corrected volume flow	→ 65
Carrier corrected volume flow	→ 65
Target volume flow	→ 66
Carrier volume flow	→ 66
CTL	→ 67
CPL	→ 67
CTPL	→ 67
S&W volume flow	→ 68
S&W correction value	→ 68
Reference density alternative	→ 69
GSV flow	→ 69
GSV flow alternative	→ 70
NSV flow	→ 70
NSV flow alternative	→ 71
Oil CTL	→ 71
Oil CPL	→ 72
Oil CTPL	→ 72
Water CTL	→ 72
CTL alternative	→ 73
CPL alternative	→ 73
Oil reference density	→ 74
Water reference density	→ 74
Oil density	→ 75

Water density	→  75
Density 2	→  76
Water cut	→  76
Oil volume flow	→  76
Oil corrected volume flow	→  77
Oil mass flow	→  77
Water volume flow	→  78
Water corrected volume flow	→  78
Water mass flow	→  79
Weighted density average	→  79
Weighted temperature average	→  80
Time period signal (TPS)	→  80
Time period signal frequency (TPS)	→  81



Mass flow

Navigation   Expert → Sensor → Measured val. → Process variab. → Mass flow (1838)



Description Displays the mass flow that is currently measured.

User interface Signed floating-point number

Additional information *Dependency*

 The unit is taken from the **Mass flow unit** parameter (→  90)

Volume flow

Navigation   Expert → Sensor → Measured val. → Process variab. → Volume flow (1847)



Description Displays the volume flow that is currently calculated.

User interface Signed floating-point number

Additional information*Description*

The volume flow is calculated from the mass flow currently measured and the density currently measured.

Dependency

 The unit is taken from the **Volume flow unit** parameter (→  91)

Corrected volume flow

Navigation

  Expert → Sensor → Measured val. → Process variab. → CorrecVolumeFlow (1851)



Description

Displays the corrected volume flow that is currently measured.

User interface

Signed floating-point number

Additional information*Dependency*

 The unit is taken from the **Corrected volume flow unit** parameter (→  94)

Density

Navigation

  Expert → Sensor → Measured val. → Process variab. → Density (1850)

Description

Displays the density that is currently measured.

User interface



Signed floating-point number

Additional information*Dependency*

 The unit is taken from the **Density unit** parameter (→  95)

Reference density

Navigation

  Expert → Sensor → Measured val. → Process variab. → Ref.density (1852)



Description

Displays the reference density that is currently calculated.



User interface

Signed floating-point number



Additional information*Dependency*

 The unit is taken from the **Reference density unit** parameter (→  96)





Temperature

Navigation	 Expert → Sensor → Measured val. → Process variab. → Temperature (1853)
Description	Displays the medium temperature that is currently measured.
User interface	Signed floating-point number
Additional information	<i>Dependency</i>  The unit is taken from the Temperature unit parameter (→  98)





Pressure

Navigation	 Expert → Sensor → Measured val. → Process variab. → Pressure (6129)
Description	Displays the fixed or external pressure value.
User interface	Signed floating-point number
Additional information	<i>Dependency</i>  The unit is taken from the Pressure unit parameter (→  98)





Dynamic viscosity

Navigation	 Expert → Sensor → Measured val. → Process variab. → Dynam. viscosity (1854)
Prerequisite	For the following order code: "Application package", option EG "Viscosity"  The software options currently enabled are displayed in the Software option overview parameter (→  56).
Description	Displays the dynamic viscosity that is currently calculated.
User interface	Signed floating-point number
Additional information	<i>Dependency</i>  The unit is taken from the Dynamic viscosity unit parameter.



Kinematic viscosity





Navigation	 Expert → Sensor → Measured val. → Process variab. → Kinematic visc. (1857)
Prerequisite	For the following order code: "Application package", option EG "Viscosity"  The software options currently enabled are displayed in the Software option overview parameter (→  56).
Description	Displays the kinematic viscosity that is currently calculated.
User interface	Signed floating-point number
Additional information	<i>Dependency</i>  The unit is taken from the Kinematic viscosity unit parameter (0578).

Temp. compensated dynamic viscosity





Navigation	 Expert → Sensor → Measured val. → Process variab. → TempCompDynVisc (1872)
Prerequisite	For the following order code: "Application package", option EG "Viscosity"  The software options currently enabled are displayed in the Software option overview parameter (→  56).
Description	Displays the temperature compensation that is currently calculated for the viscosity.
User interface	Signed floating-point number
Additional information	<i>Dependency</i>  The unit is taken from the Dynamic viscosity unit parameter.

Temp. compensated kinematic viscosity





Navigation	 Expert → Sensor → Measured val. → Process variab. → TempCompKinVisc (1863)
Prerequisite	For the following order code: "Application package", option EG "Viscosity"  The software options currently enabled are displayed in the Software option overview parameter (→  56).
Description	Displays the temperature compensation that is currently calculated for the kinetic viscosity.
User interface	Signed floating-point number

Additional information	<p><i>Dependency</i></p> <p> The unit is taken from the Kinematic viscosity unit parameter (0578).</p>
<hr/>	
Concentration	
<hr/>	
Navigation	 Expert → Sensor → Measured val. → Process variab. → Concentration (1887)
Prerequisite	<p>For the following order code: Order code for "Application package", option ED "Concentration"</p> <p> The software options currently enabled are displayed in the Software option overview parameter (→  56).</p>
Description	Displays the concentration that is currently calculated.
User interface	Signed floating-point number
Additional information	<p><i>Dependency</i></p> <p> The unit is taken from the Concentration unit parameter (0613).</p>





Target mass flow

Navigation	 Expert → Sensor → Measured val. → Process variab. → Target mass flow (1864)
Prerequisite	<p>With the following conditions: Order code for "Application package", option ED "Concentration"</p> <p> The software options currently enabled are displayed in the Software option overview parameter (→  56).</p>
Description	Displays the mass flow that is currently measured for the target medium.
User interface	Signed floating-point number
Additional information	<p><i>Dependency</i></p> <p> The unit is taken from the Mass flow unit parameter (→  90)</p>



Carrier mass flow

Navigation	 Expert → Sensor → Measured val. → Process variab. → Carrier mass fl. (1865)
Prerequisite	With the following conditions: Order code for "Application package", option ED "Concentration"  The software options currently enabled are displayed in the Software option overview parameter (→  56).
Description	Displays the mass flow of the carrier medium that is currently measured.
User interface	Signed floating-point number
Additional information	<i>Dependency</i>  The unit is taken from the Mass flow unit parameter (→  90)

Target corrected volume flow



Navigation	 Expert → Sensor → Measured val. → Process variab. → Targ.corr.vol.fl (1893)
Prerequisite	With the following conditions: <ul style="list-style-type: none"> ▪ Order code for "Application package", option ED "Concentration" ▪ The Ethanol in water option or %mass / %volume option is selected in the Liquid type parameter.  The software options currently enabled are displayed in the Software option overview parameter (→  56).
Description	Displays the corrected volume flow that is currently measured for the target fluid.
User interface	Signed floating-point number
Additional information	<i>Dependency</i>  The unit is taken from the Volume flow unit parameter (→  91)

Carrier corrected volume flow

Navigation	 Expert → Sensor → Measured val. → Process variab. → Carr.corr.vol.fl (1894)
Prerequisite	With the following conditions: <ul style="list-style-type: none"> ▪ Order code for "Application package", option ED "Concentration" ▪ In the Liquid type parameter, the Ethanol in water option or %mass / %volume option is selected.  The software options currently enabled are displayed in the Software option overview parameter (→  56).
Description	Displays the corrected volume flow currently measured for the carrier fluid.

User interface Signed floating-point number

Additional information *Dependency*



 The unit is taken from the **Volume flow unit** parameter (→  91)

Target volume flow

Navigation   Expert → Sensor → Measured val. → Process variab. → Target vol. flow (1895)

Prerequisite With the following conditions:



- Order code for "Application package", option **ED** "Concentration"
- The **Ethanol in water** option or **%mass / %volume** option is selected in the **Liquid type** parameter.
- The **%vol** option is selected in the **Concentration unit** parameter.

 The software options currently enabled are displayed in the **Software option overview** parameter (→  56).



Description Displays the volume flow currently measured for the target medium.

User interface Signed floating-point number

Additional information *Dependency*

 The unit is taken from the **Volume flow unit** parameter (→  91)

Carrier volume flow

Navigation   Expert → Sensor → Measured val. → Process variab. → Carrier vol. fl. (1896)

Prerequisite With the following conditions:



- Order code for "Application package", option **ED** "Concentration"
- The **Ethanol in water** option or **%mass / %volume** option is selected in the **Liquid type** parameter.
- The **%vol** option is selected in the **Concentration unit** parameter.

 The software options currently enabled are displayed in the **Software option overview** parameter (→  56).



Description Use this function to display the volume flow currently measured for the carrier medium.

User interface Signed floating-point number



Additional information *Dependency*

 The unit is taken from the **Volume flow unit** parameter (→  91)



CTL

Navigation	 Expert → Sensor → Measured val. → Process variab. → CTL (4191)
Prerequisite	<p>For the following order code:</p> <ul style="list-style-type: none"> ▪ "Application package", option EJ "Petroleum" ▪ In the Petroleum mode parameter, the API referenced correction option is selected. <p> The software options currently enabled are displayed in the Software option overview parameter (→  56).</p>
Description	Displays the correction factor which represents the effect of temperature on the fluid. This is used to convert the measured volume flow and the measured density to values at reference temperature.
User interface	Positive floating-point number
Factory setting	–

CPL







Navigation	 Expert → Sensor → Measured val. → Process variab. → CPL (4192)
Prerequisite	<p>For the following order code:</p> <ul style="list-style-type: none"> ▪ "Application package", option EJ "Petroleum" ▪ In the Petroleum mode parameter, the API referenced correction option is selected. <p> The software options currently enabled are displayed in the Software option overview parameter (→  56).</p>
Description	Displays the correction factor which represents the effect of pressure on the fluid. This is used to convert the measured volume flow and the measured density to values at reference pressure.
User interface	Positive floating-point number
Factory setting	–

CTPL



Navigation	 Expert → Sensor → Measured val. → Process variab. → CTPL (4193)
Prerequisite	<p>For the following order code:</p> <ul style="list-style-type: none"> ▪ "Application package", option EJ "Petroleum" ▪ In the Petroleum mode parameter, the API referenced correction option is selected. <p> The software options currently enabled are displayed in the Software option overview parameter (→  56).</p>

Description	Displays the combined correction factor which represents the effect of temperature and pressure on the fluid. This is used to convert the measured volume flow and the measured density to values at reference temperature and reference pressure.
User interface	Positive floating-point number
Factory setting	–







S&W volume flow

Navigation	 Expert → Sensor → Measured val. → Process variab. → S&W volume flow (4161)
Prerequisite	For the following order code: <ul style="list-style-type: none"> ▪ "Application package", option EJ "Petroleum" ▪ In the Petroleum mode parameter, the API referenced correction option is selected.  The software options currently enabled are displayed in the Software option overview parameter (→  56).
Description	Displays the S&W volume flow which is calculated from the measured total volume flow minus the net volume flow. <i>Dependency</i> The unit is taken from: Volume flow unit parameter (→  91)
User interface	Signed floating-point number
Factory setting	–
Additional information	 The unit is taken from the Volume flow unit parameter (→  91)







S&W correction value

Navigation	 Expert → Sensor → Measured val. → Process variab. → S&W correction (4194)
Prerequisite	For the following order code: <ul style="list-style-type: none"> ▪ "Application package", option EJ "Petroleum" ▪ In the S&W input mode parameter, the External value option or the Current input 1... option is selected.  The software options currently enabled are displayed in the Software option overview parameter (→  56).
Description	Shows the correction value for sediment and water.
User interface	Positive floating-point number
Factory setting	–







Reference density alternative

Navigation	 Expert → Sensor → Measured val. → Process variab. → Ref.dens.altern. (4168)
Prerequisite	<p>For the following order code:</p> <ul style="list-style-type: none"> ▪ "Application package", option EJ "Petroleum" ▪ In the Petroleum mode parameter, the API referenced correction option is selected. <p> The software options currently enabled are displayed in the Software option overview parameter (→  56).</p>
Description	<p>Displays the fluid density at the alternative reference temperature.</p> <p><i>Dependency</i></p> <p>The unit is taken from: Reference density unit parameter (→  96)</p>
User interface	Signed floating-point number
Factory setting	–
Additional information	 The unit is taken from the Reference density unit parameter (→  96)







GSV flow

Navigation	 Expert → Sensor → Measured val. → Process variab. → GSV flow (4157)
Prerequisite	<p>For the following order code:</p> <ul style="list-style-type: none"> ▪ "Application package", option EJ "Petroleum" ▪ In the Petroleum mode parameter, the API referenced correction option is selected. <p> The software options currently enabled are displayed in the Software option overview parameter (→  56).</p>
Description	<p>Displays the measured total volume flow, corrected to the reference temperature and the reference pressure.</p> <p><i>Dependency</i></p> <p>The unit is taken from: Corrected volume flow unit parameter (→  94)</p>
User interface	Signed floating-point number
Factory setting	–
Additional information	 The unit is taken from the Corrected volume flow unit parameter (→  94)







GSV flow alternative

Navigation	 Expert → Sensor → Measured val. → Process variab. → GSVa (4158)
Prerequisite	<p>For the following order code:</p> <ul style="list-style-type: none"> ▪ "Application package", option EJ "Petroleum" ▪ In the Petroleum mode parameter, the API referenced correction option is selected. <p> The software options currently enabled are displayed in the Software option overview parameter (→  56).</p>
Description	<p>Displays the measured total volume flow, corrected to the alternative reference temperature and the alternative reference pressure.</p> <p><i>Dependency</i></p> <p>The unit is taken from: Corrected volume flow unit parameter (→  94)</p>
User interface	Signed floating-point number
Factory setting	–
Additional information	 The unit is taken from the Corrected volume flow unit parameter (→  94)



NSV flow

Navigation	 Expert → Sensor → Measured val. → Process variab. → NSV flow (4159)
Prerequisite	<p>For the following order code:</p> <ul style="list-style-type: none"> ▪ "Application package", option EJ "Petroleum" ▪ In the Petroleum mode parameter, the API referenced correction option is selected. <p> The software options currently enabled are displayed in the Software option overview parameter (→  56).</p>
Description	<p>Displays the net volume flow which is calculated from the measured total volume flow minus the value for sediment & water and minus the shrinkage.</p> <p><i>Dependency</i></p> <p>The unit is taken from: Corrected volume flow unit parameter (→  94)</p>
User interface	Signed floating-point number
Factory setting	–
Additional information	 The unit is taken from the Corrected volume flow unit parameter (→  94)



NSV flow alternative

Navigation	 Expert → Sensor → Measured val. → Process variab. → NSVa (4160)
Prerequisite	<p>For the following order code:</p> <ul style="list-style-type: none"> ▪ "Application package", option EJ "Petroleum" ▪ In the Petroleum mode parameter, the API referenced correction option is selected. <p> The software options currently enabled are displayed in the Software option overview parameter (→  56).</p>
Description	<p>Displays the net volume flow which is calculated from the measured alternative total volume minus the value for sediment & water and minus the shrinkage.</p> <p><i>Dependency</i></p> <p>The unit is taken from: Corrected volume flow unit parameter (→  94)</p>
User interface	Signed floating-point number
Factory setting	–
Additional information	 The unit is taken from the Corrected volume flow unit parameter (→  94)



Oil CTL

Navigation	 Expert → Sensor → Measured val. → Process variab. → Oil CTL (4175)
Prerequisite	<p>For the following order code:</p> <ul style="list-style-type: none"> ▪ "Application package", option EJ "Petroleum" ▪ In the Petroleum mode parameter, the Net oil & water cut option is selected. <p> The software options currently enabled are displayed in the Software option overview parameter (→  56).</p>
Description	<p>Displays the correction factor which represents the effect of temperature on the oil. This is used to convert the measured oil volume flow and the measured oil density to values at reference temperature.</p>
User interface	Positive floating-point number
Factory setting	–



Oil CPL

Navigation	 Expert → Sensor → Measured val. → Process variab. → Oil CPL (4177)
Prerequisite	<p>For the following order code:</p> <ul style="list-style-type: none"> ▪ "Application package", option EJ "Petroleum" ▪ In the Petroleum mode parameter, the Net oil & water cut option is selected. <p> The software options currently enabled are displayed in the Software option overview parameter (→  56).</p>
Description	Displays the correction factor which represents the effect of pressure on the oil. This is used to convert the measured oil volume flow and the measured oil density to values at reference pressure.
User interface	Positive floating-point number
Factory setting	–

Oil CTPL



Navigation	 Expert → Sensor → Measured val. → Process variab. → Oil CTPL (4176)
Prerequisite	<p>For the following order code:</p> <ul style="list-style-type: none"> ▪ "Application package", option EJ "Petroleum" ▪ In the Petroleum mode parameter, the Net oil & water cut option is selected. <p> The software options currently enabled are displayed in the Software option overview parameter (→  56).</p>
Description	Displays the combined correction factor which represents the effect of temperature and pressure on the oil. This is used to convert the measured oil volume flow and the measured oil density to values at reference temperature and reference pressure.
User interface	Positive floating-point number
Factory setting	–

Water CTL



Navigation	 Expert → Sensor → Measured val. → Process variab. → Water CTL (4172)
Prerequisite	<p>For the following order code:</p> <ul style="list-style-type: none"> ▪ "Application package", option EJ "Petroleum" ▪ In the Petroleum mode parameter, the Net oil & water cut option is selected. <p> The software options currently enabled are displayed in the Software option overview parameter (→  56).</p>

Description	Displays the correction factor which represents the effect of temperature on the water. This is used to convert the measured water volume flow and the measured water density to values at reference temperature.
User interface	Positive floating-point number
Factory setting	–





CTL alternative

Navigation	 Expert → Sensor → Measured val. → Process variab. → CTL alternative (4174)
Prerequisite	For the following order code: <ul style="list-style-type: none"> ▪ "Application package", option EJ "Petroleum" ▪ In the Petroleum mode parameter, the API referenced correction option is selected.  The software options currently enabled are displayed in the Software option overview parameter (→  56).
Description	Displays the correction factor which represents the effect of temperature on the fluid. This is used to convert the measured volume flow and the measured density to values at the alternative reference temperature.
User interface	Positive floating-point number
Factory setting	–





CPL alternative

Navigation	 Expert → Sensor → Measured val. → Process variab. → CPL alternative (4197)
Prerequisite	For the following order code: <ul style="list-style-type: none"> ▪ "Application package", option EJ "Petroleum" ▪ In the Petroleum mode parameter, the API referenced correction option is selected.  The software options currently enabled are displayed in the Software option overview parameter (→  56).
Description	Displays the correction factor which represents the effect of pressure on the fluid. This is used to convert the measured volume flow and the measured density to values at the alternative reference pressure.
User interface	Positive floating-point number
Factory setting	–





Oil reference density

Navigation	 Expert → Sensor → Measured val. → Process variab. → Oil ref. density (4195)
Prerequisite	For the following order code: <ul style="list-style-type: none">▪ "Application package", option EJ "Petroleum"▪ In the Petroleum mode parameter, the Net oil & water cut option is selected.  The software options currently enabled are displayed in the Software option overview parameter (→  56).
Description	Shows the oil density at the reference temperature.
User interface	Signed floating-point number
Factory setting	–
Additional information	<i>Dependency</i>  The unit is taken from the Reference density unit parameter (→  96)





Water reference density

Navigation	 Expert → Sensor → Measured val. → Process variab. → Water ref. dens. (4196)
Prerequisite	For the following order code: <ul style="list-style-type: none">▪ "Application package", option EJ "Petroleum"▪ In the Petroleum mode parameter, the Net oil & water cut option is selected.  The software options currently enabled are displayed in the Software option overview parameter (→  56).
Description	Shows the water density at the reference temperature.
User interface	Signed floating-point number
Factory setting	–
Additional information	<i>Dependency</i>  The unit is taken from: Water reference density unit parameter



Oil density

Navigation	 Expert → Sensor → Measured val. → Process variab. → Oil density (4169)
Prerequisite	<p>For the following order code:</p> <ul style="list-style-type: none"> ▪ "Application package", option EJ "Petroleum" ▪ In the Petroleum mode parameter, the Net oil & water cut option is selected. <p> The software options currently enabled are displayed in the Software option overview parameter (→  56).</p>
Description	Displays the density of the oil currently measured.
User interface	Signed floating-point number
Factory setting	–
Additional information	<p><i>Dependency</i></p> <p> The unit is taken from: Oil density unit parameter</p>



Water density

Navigation	 Expert → Sensor → Measured val. → Process variab. → Water density (4170)
Prerequisite	<p>For the following order code:</p> <ul style="list-style-type: none"> ▪ "Application package", option EJ "Petroleum" ▪ In the Petroleum mode parameter, the Net oil & water cut option is selected. <p> The software options currently enabled are displayed in the Software option overview parameter (→  56).</p>
Description	Displays the density of the water currently measured.
User interface	Signed floating-point number
Factory setting	–
Additional information	<p><i>Dependency</i></p> <p> The unit is taken from: Water density unit parameter</p>





Density 2

Navigation	 Expert → Sensor → Measured val. → Process variab. → Density 2 (1905)
Prerequisite	<p>For the following order code:</p> <ul style="list-style-type: none"> ▪ "Application package", option EH "Extended density function" ▪ "Application package", option EI "Premium density" <p> The software options currently enabled are displayed in the Software option overview parameter (→  56).</p>
Description	Shows the density currently measured in the second density unit specified.
User interface	Signed floating-point number

Water cut



Navigation	 Expert → Sensor → Measured val. → Process variab. → Water cut (4171)
Prerequisite	<p>For the following order code:</p> <ul style="list-style-type: none"> ▪ "Application package", option EJ "Petroleum" ▪ In the Petroleum mode parameter, the API referenced correction option is selected. <p> The software options currently enabled are displayed in the Software option overview parameter (→  56).</p>
Description	Displays the percentage water volume flow in relation to the total volume flow of the fluid.
User interface	0 to 100 %
Factory setting	-

Oil volume flow



Navigation	 Expert → Sensor → Measured val. → Process variab. → Oil volume flow (4178)
Prerequisite	<p>For the following order code:</p> <ul style="list-style-type: none"> ▪ "Application package", option EJ "Petroleum" ▪ In the Petroleum mode parameter, the Net oil & water cut option is selected. <p> The software options currently enabled are displayed in the Software option overview parameter (→  56).</p>
Description	<p>Displays the currently calculated volume flow of the oil.</p> <p>Dependency:</p> <ul style="list-style-type: none"> ▪ Based on the value displayed in the Water cut parameter (→  76) ▪ The unit is taken from: Volume flow unit parameter (→  91)
User interface	Signed floating-point number

Factory setting –

Additional information *Dependency*

 The unit is taken from the **Volume flow unit** parameter (→  91)



Oil corrected volume flow

Navigation   Expert → Sensor → Measured val. → Process variab. → Oil corr.vol.fl. (4179)

Prerequisite

For the following order code:



- "Application package", option **EJ** "Petroleum"
- In the **Petroleum mode** parameter, the **Net oil & water cut** option is selected.

 The software options currently enabled are displayed in the **Software option overview** parameter (→  56).

Description

Displays the currently calculated volume flow of the oil, calculated to values at reference temperature and reference pressure.

Dependency:

- Based on the value displayed in the **Water cut** parameter (→  76)
- The unit is taken from: **Corrected volume flow unit** parameter (→  94)



User interface

Signed floating-point number



Factory setting

–

Additional information

 The unit is taken from the **Corrected volume flow unit** parameter (→  94)



Oil mass flow

Navigation   Expert → Sensor → Measured val. → Process variab. → Oil mass flow (4180)

Prerequisite

For the following order code:



- "Application package", option **EJ** "Petroleum"
- In the **Petroleum mode** parameter, the **Net oil & water cut** option is selected.

 The software options currently enabled are displayed in the **Software option overview** parameter (→  56).

Description

Displays the currently calculated mass flow of the oil.

Dependency:

- Based on the value displayed in the **Water cut** parameter (→  76)
- The unit is taken from: **Mass flow unit** parameter (→  90)

User interface

Signed floating-point number

Factory setting



–

Additional information*Dependency*

 The unit is taken from the **Mass flow unit** parameter (→  90)

Water volume flow



Navigation

  Expert → Sensor → Measured val. → Process variab. → Water vol. flow (4181)

Prerequisite

For the following order code:



- "Application package", option **EJ** "Petroleum"
- In the **Petroleum mode** parameter, the **Net oil & water cut** option is selected.

 The software options currently enabled are displayed in the **Software option overview** parameter (→  56).

Description

Displays the currently calculated volume flow of the water.

Dependency:

- Based on the value displayed in the **Water cut** parameter (→  76)
- The unit is taken from: **Volume flow unit** parameter (→  91)



User interface

Signed floating-point number

Factory setting



–

Additional information*Dependency*

 The unit is taken from the **Volume flow unit** parameter (→  91)

Water corrected volume flow

Navigation

  Expert → Sensor → Measured val. → Process variab. → Water corr.v.fl. (4182)

Prerequisite

For the following order code:



- "Application package", option **EJ** "Petroleum"
- In the **Petroleum mode** parameter, the **Net oil & water cut** option is selected.

 The software options currently enabled are displayed in the **Software option overview** parameter (→  56).

Description

Displays the currently calculated volume flow of the water, calculated to values at reference temperature and reference pressure.

Dependency:

- Based on the value displayed in the **Water cut** parameter (→  76)
- The unit is taken from: **Corrected volume flow unit** parameter (→  94)



User interface

Signed floating-point number







Factory setting

–







Additional information

 The unit is taken from the **Corrected volume flow unit** parameter (→  94)







Water mass flow

Navigation	 Expert → Sensor → Measured val. → Process variab. → Water mass flow (4183)
Prerequisite	<p>For the following order code:</p> <ul style="list-style-type: none"> ▪ "Application package", option EJ "Petroleum" ▪ In the Petroleum mode parameter, the Net oil & water cut option is selected. <p> The software options currently enabled are displayed in the Software option overview parameter (→  56).</p>
Description	<p>Displays the currently calculated mass flow of the water.</p> <p>Dependency:</p> <ul style="list-style-type: none"> ▪ Based on the value displayed in the Water cut parameter (→  76) ▪ The unit is taken from: Mass flow unit parameter (→  90)
User interface	Signed floating-point number
Factory setting	–
Additional information	<p><i>Dependency</i></p> <p> The unit is taken from the Mass flow unit parameter (→  90)</p>



Weighted density average

Navigation	 Expert → Sensor → Measured val. → Process variab. → Density average (4184)
Prerequisite	<p>For the following order code:</p> <ul style="list-style-type: none"> ▪ "Application package", option EJ "Petroleum" ▪ "Application package", option EM "Petroleum + Locking function" <p> The software options currently enabled are displayed in the Software option overview parameter (→  56).</p>
Description	<p>Displays the weighted average for the density since the last time the density averages were reset.</p> <p>Dependency:</p> <ul style="list-style-type: none"> ▪ The unit is taken from: Density unit parameter (→  95) ▪ The value is reset to NaN (Not a Number) via the Reset weighted averages parameter
User interface	Signed floating-point number
Factory setting	–
Additional information	<p><i>Dependency</i></p> <p> <ul style="list-style-type: none"> ▪ The unit is taken from: Density unit parameter (→  95) ▪ The value is reset to NaN (Not a Number) via the Reset weighted averages parameter </p>

Weighted temperature average



Navigation	 Expert → Sensor → Measured val. → Process variab. → Temp. average (4185)
Prerequisite	<p>For the following order code:</p> <ul style="list-style-type: none"> ▪ "Application package", option EJ "Petroleum" ▪ "Application package", option EM "Petroleum + Locking function" <p> The software options currently enabled are displayed in the Software option overview parameter (→  56).</p>
Description	<p>Displays the weighted average for the temperature since the last time the temperature averages were reset.</p> <p>Dependency:</p> <ul style="list-style-type: none"> ▪ The unit is taken from: Temperature unit parameter (→  98) ▪ The value is reset to NaN (Not a Number) via the Reset weighted averages parameter
User interface	Signed floating-point number
Factory setting	–
Additional information	<p><i>Dependency</i></p> <p> <ul style="list-style-type: none"> ▪ The unit is taken from: Temperature unit parameter (→  98) ▪ The value is reset to NaN (Not a Number) via the Reset weighted averages parameter </p>

Time period signal (TPS)

Navigation	 Expert → Sensor → Measured val. → Process variab. → TPS (1903)
Prerequisite	<p>For the following order code:</p> <ul style="list-style-type: none"> ▪ "Application package", option EH "Extended density function" ▪ "Application package", option EI "Premium density" <p> The software options currently enabled are displayed in the Software option overview parameter (→  56).</p>
Description	Shows the time period signal (TPS) currently calculated. Corresponds to the measured density.
User interface	Positive floating-point number

Time period signal frequency (TPS)

Navigation  Expert → Sensor → Measured val. → Process variab. → TPS frequency (1904)

Prerequisite For the following order code:
 ■ "Application package", option **EH** "Extended density function"
 ■ "Application package", option **EI** "Premium density"
 The software options currently enabled are displayed in the **Software option overview** parameter (→  56).

Description Shows the frequency of the time period signal (TPS) currently calculated. Corresponds to the measured density.

User interface 0 to 10 000 Hz

"Totalizer" submenu

Navigation  Expert → Sensor → Measured val. → Totalizer

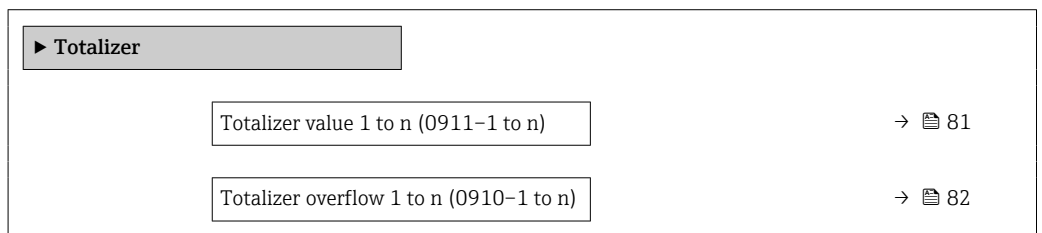

Totalizer value 1 to n

Navigation  Expert → Sensor → Measured val. → Totalizer → Totalizer val. 1 to n (0911-1 to n)

Prerequisite A process variable is selected in the **Assign process variable** parameter (→  255) of the **Totalizer 1 to n** submenu.

Description Displays the current totalizer counter reading.

User interface Signed floating-point number



Additional information*Description*

As the operating tool can only display a maximum of 7 digits, if the display range is exceeded the current counter reading is the sum of the totalizer value and the overflow value from the **Totalizer overflow 1 to n** parameter.

 In the event of an error, the totalizer adopts the mode defined in the **Failure mode** parameter (→  259).

User interface

The value of the process variable totalized since measuring began can be positive or negative. This depends on the settings in the **Totalizer operation mode** parameter (→  257).

 The unit of the selected process variable is specified for the totalizer in the **Unit totalizer** parameter (→  256).

Example

Calculation of the current totalizer reading when the value exceeds the 7-digit display range of the operating tool:

- Value in the **Totalizer value 1** parameter: 1 968 457 m³
- Value in the **Totalizer overflow 1** parameter: $1 \cdot 10^7$ (1 overflow) = 10 000 000 m³
- Current totalizer reading: 11 968 457 m³

Totalizer overflow 1 to n**Navigation**

  Expert → Sensor → Measured val. → Totalizer → Tot. overflow 1 to n (0910-1 to n)

Prerequisite

A process variable is selected in the **Assign process variable** parameter (→  255) of the **Totalizer 1 to n** submenu.

Description

Displays the current totalizer overflow.



User interface

Integer with sign

Additional information*Description*

If the current totalizer reading exceeds 7 digits, which is the maximum value range that can be displayed by the operating tool, the value above this range is output as an overflow. The current totalizer value is therefore the sum of the overflow value and the totalizer value from the **Totalizer value 1 to n** parameter.

User interface

 The unit of the selected process variable is specified for the totalizer in the **Unit totalizer** parameter (→  256).

Example

Calculation of the current totalizer reading when the value exceeds the 7-digit display range of the operating tool:

- Value in the **Totalizer value 1** parameter: 1 968 457 m³
- Value in the **Totalizer overflow 1** parameter: $2 \cdot 10^7$ (2 overflows) = 20 000 000 [m³]
- Current totalizer reading: 21 968 457 m³

Totalizer 1 to n value

Navigation	🔍📄 Expert → Sensor → Measured val. → Totalizer → Tot. 1 to n value
Description	Shows the totalizer value reported to the controller for further processing.
User interface	Signed floating-point number
Factory setting	0 m ³

Totalizer 1 to n status

Navigation	🔍📄 Expert → Sensor → Measured val. → Totalizer → Tot. 1 to n status
Description	Shows the status of the totalizer value reported to the controller for further processing ('Good', 'Uncertain', 'Bad').
User interface	<ul style="list-style-type: none"> ▪ Good ▪ Uncertain ▪ Bad
Factory setting	Good

Totalizer 1 to n status (Hex)

Navigation	🔍📄 Expert → Sensor → Measured val. → Totalizer → Status 1 to n (Hex)
Description	Shows the status of the totalizer value reported to the controller for further processing (Hex).
User interface	0 to 255
Factory setting	128

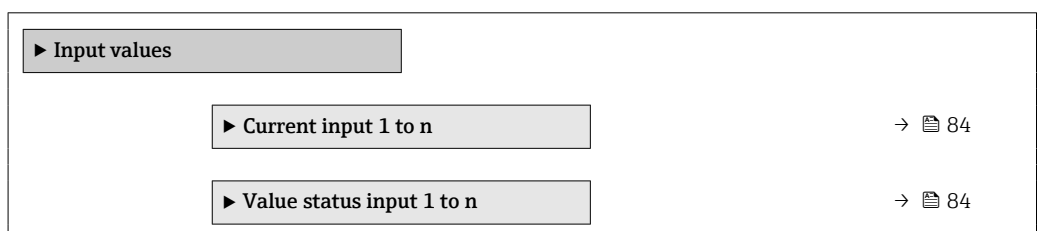

"Input values" submenu

Navigation 🔍📄 Expert → Sensor → Measured val. → Input values



"Current input 1 to n" submenu

Navigation  Expert → Sensor → Measured val. → Input values → Current input 1 to n

► Current input 1 to n	
Measured values 1 to n (1603-1 to n)	→  84
Measured current 1 to n (1604-1 to n)	→  84

Measured values 1 to n

Navigation	 Expert → Sensor → Measured val. → Input values → Current input 1 to n → Measured val. 1 to n (1603-1 to n)
Description	Displays the current input value.
User interface	Signed floating-point number

Measured current 1 to n

Navigation	 Expert → Sensor → Measured val. → Input values → Current input 1 to n → Measur. curr. 1 to n (1604-1 to n)
Description	Displays the current value of the current input.
User interface	0 to 22.5 mA

"Value status input 1 to n" submenu

Navigation  Expert → Sensor → Measured val. → Input values → Val.stat.inp. 1 to n

► Value status input 1 to n	
Value status input (1353-1 to n)	→  85





Value status input

- Navigation**  Expert → Sensor → Measured val. → Input values → Val.stat.inp. 1 to n → Val.stat.inp. (1353-1 to n)
- Description** Displays the current input signal level.
- User interface**
- High
 - Low

"Output values" submenu

Navigation  Expert → Sensor → Measured val. → Output values



▶ **Output values**

- ▶ Value current output 1 to n →  85
- ▶ Pulse/frequency/switch output 1 to n →  86
- ▶ Relay output 1 to n →  88
- ▶ Double pulse output →  89

"Value current output 1 to n" submenu

Navigation  Expert → Sensor → Measured val. → Output values → Val. curr.outp 1 to n



▶ **Value current output 1 to n**

- Output current (0361-1 to n) →  85
- Measured current (0366-1 to n) →  86

Output current

- Navigation**  Expert → Sensor → Measured val. → Output values → Val. curr.outp 1 to n → Output curr. (0361-1 to n)
- Description** Displays the current value currently calculated for the current output.
- User interface** 0 to 22.5 mA



Measured current

Navigation   Expert → Sensor → Measured val. → Output values → Val. curr.outp 1 to n → Measur. curr. (0366-1 to n)



Description Displays the actual measured value of the output current.

User interface 0 to 30 mA



"Pulse/frequency/switch output 1 to n" submenu

Navigation   Expert → Sensor → Measured val. → Output values → PFS output 1 to n

▶ **Pulse/frequency/switch output 1 to n**

Output frequency (0471-1 to n)	→  86
Pulse output 1 to n (0456-1 to n)	→  86
Switch state (0461-1 to n)	→  87

Output frequency



Navigation   Expert → Sensor → Measured val. → Output values → PFS output 1 to n → Output freq. (0471-1 to n)

Prerequisite In the **Operating mode** parameter (→  171), the **Frequency** option is selected.

Description Displays the actual value of the output frequency which is currently measured.

User interface 0.0 to 12 500.0 Hz

Pulse output 1 to n

Navigation   Expert → Sensor → Measured val. → Output values → PFS output 1 to n → Pulse output 1 to n (0456-1 to n)

Prerequisite The **Pulse** option is selected in the **Operating mode** parameter (→  171) parameter.

Description Displays the pulse frequency currently output.

User interface Positive floating-point number

Additional information *Description*

- The pulse output is an open collector output.
- This is configured at the factory in such a way that the transistor is conductive for the duration of the pulse (NO contact) and is safety-oriented.

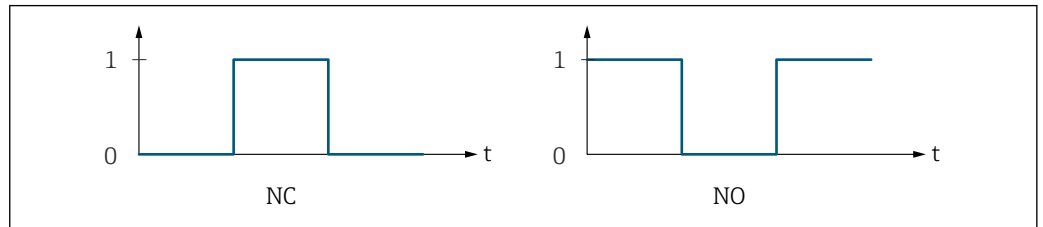

A0028726

0 Non-conductive
 1 Conductive
 NC NC contact (normally closed)
 NO NO contact (normally open)

The output behavior can be reversed via the **Invert output signal** parameter (→ [190](#)) i.e. the transistor does not conduct for the duration of the pulse.

In addition, the behavior of the output in the event of a device alarm (**Failure mode** parameter (→ [175](#))) can be configured.

Switch state

Navigation Expert → Sensor → Measured val. → Output values → PFS output 1 to n → Switch state (0461-1 to n)

Prerequisite The **Switch** option is selected in the **Operating mode** parameter (→ [171](#)).

Description Displays the current switch status of the status output.

User interface



- Open
- Closed

Additional information *User interface*

- Open
The switch output is not conductive.
- Closed
The switch output is conductive.

"Relay output 1 to n" submenu

Navigation  Expert → Sensor → Measured val. → Output values → Relay output 1 to n

▶ Relay output 1 to n	
Switch state (0801-1 to n)	→  88
Switch cycles (0815-1 to n)	→  88
Max. switch cycles number (0817-1 to n)	→  88

Switch state

Navigation  Expert → Sensor → Measured val. → Output values → Relay output 1 to n → Switch state (0801-1 to n)

Description Displays the current status of the relay output.

User interface

- Open
- Closed

Additional information *User interface*

- Open
The relay output is not conductive.
- Closed
The relay output is conductive.

Switch cycles

Navigation  Expert → Sensor → Measured val. → Output values → Relay output 1 to n → Switch cycles (0815-1 to n)

Description Displays all the switch cycles performed.

User interface Positive integer

Max. switch cycles number

Navigation  Expert → Sensor → Measured val. → Output values → Relay output 1 to n → Max. cycles no. (0817-1 to n)

Description Displays the maximum number of guaranteed switch cycles.

User interface Positive integer

"Double pulse output" submenu

Navigation  Expert → Sensor → Measured val. → Output values → Double pulse out

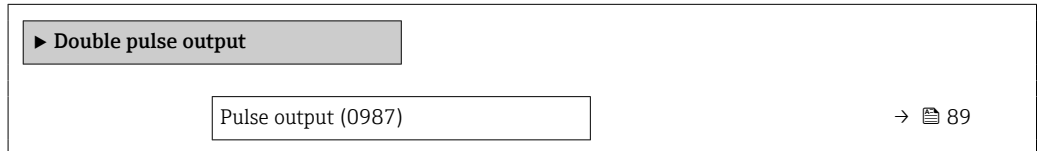



Pulse output

Navigation  Expert → Sensor → Measured val. → Output values → Double pulse out → Pulse output (0987)

Description Displays the pulse frequency of the double pulse output which is currently output.





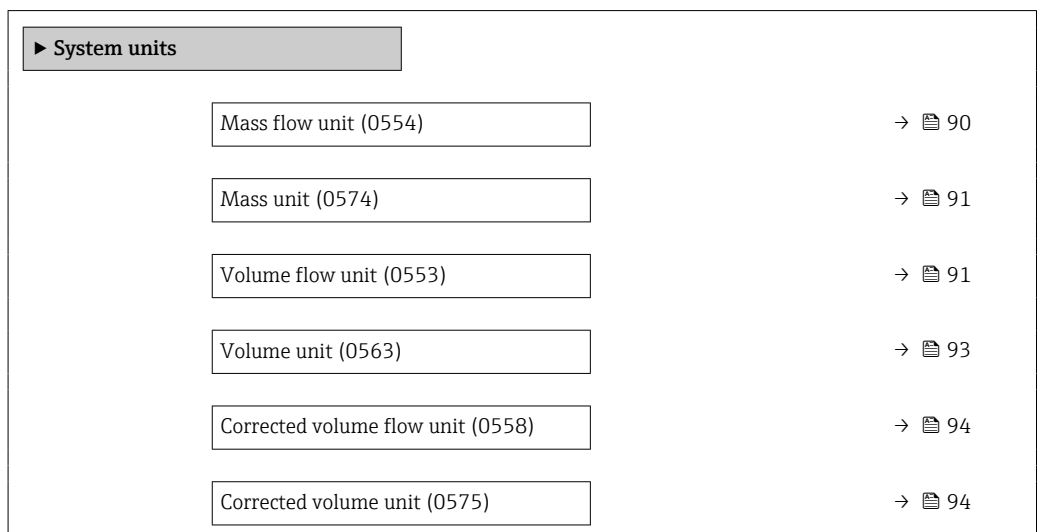

User interface Positive floating-point number

Additional information  For a detailed description and example: **Pulse output** parameter (→  86)

3.2.2 "System units" submenu

Navigation  Expert → Sensor → System units



Density unit (0555)	→  95
Reference density unit (0556)	→  96
Density 2 unit (0619)	→  97
Temperature unit (0557)	→  98
Pressure unit (0564)	→  98
Date/time format (2812)	→  99

Mass flow unit

Navigation

  Expert → Sensor → System units → Mass flow unit (0554)

Description

Use this function to select the unit for the mass flow.

Selection

SI units

- g/s
- g/min
- g/h
- g/d
- kg/s
- kg/min
- kg/h
- kg/d
- t/s
- t/min
- t/h
- t/d

US units

- oz/s
- oz/min
- oz/h
- oz/d
- lb/s
- lb/min
- lb/h
- lb/d
- STon/s
- STon/min
- STon/h
- STon/d

Factory setting



Country-specific:

- kg/h (DN > 150 (6"): **t/h** option)
- lb/min

Additional information

Effect

The selected unit applies for:

- **Target mass flow** parameter (→  64)
- **Carrier mass flow** parameter (→  65)
- **Mass flow** parameter (→  60)

Selection

 For an explanation of the abbreviated units: →  339

Customer-specific units

 The unit for the customer-specific mass is specified in the **User mass text** parameter.

Mass unit
**Navigation**

Expert → Sensor → System units → Mass unit (0574)

Description

Use this function to select the unit for the mass.

Selection*SI units*

- g
- kg
- t

US units

- oz
- lb
- STon

Factory setting

Country-specific:

- kg (DN > 150 (6"): **t** option)
- lb

Additional information*Selection*

For an explanation of the abbreviated units: → 339

Customer-specific unitsThe unit for the customer-specific mass is specified in the **User mass text** parameter.

Volume flow unit
**Navigation**

Expert → Sensor → System units → Volume flow unit (0553)

Description

Use this function to select the unit for the volume flow.

Selection*SI units*

- cm³/s
- cm³/min
- cm³/h
- cm³/d
- dm³/s
- dm³/min
- dm³/h
- dm³/d
- m³/s
- m³/min
- m³/h
- m³/d
- ml/s
- ml/min
- ml/h
- ml/d
- l/s
- l/min
- l/h
- l/d
- hl/s
- hl/min
- hl/h
- hl/d
- Ml/s
- Ml/min
- Ml/h
- Ml/d

US units

- af/s
- af/min
- af/h
- af/d
- ft³/s
- ft³/min
- ft³/h
- ft³/d
- kft³/s
- kft³/min
- kft³/h
- kft³/d
- MMft³/s
- MMft³/min
- MMft³/h
- Mft³/d
- fl oz/s (us)
- fl oz/min (us)
- fl oz/h (us)
- fl oz/d (us)
- gal/s (us)
- gal/min (us)
- gal/h (us)
- gal/d (us)
- Mgal/s (us)
- Mgal/min (us)
- Mgal/h (us)
- Mgal/d (us)
- bbl/s (us;oil)
- bbl/min (us;oil)
- bbl/h (us;oil)
- bbl/d (us;oil)
- bbl/s (us;tank)
- bbl/min (us;tank)
- bbl/h (us;tank)
- bbl/d (us;tank)
- kgal/s (us)
- kgal/min (us)
- kgal/h (us)
- kgal/d (us)

Imperial units

- gal/s (imp)
- gal/min (imp)
- gal/h (imp)
- gal/d (imp)
- Mgal/s (imp)
- Mgal/min (imp)
- Mgal/h (imp)
- Mgal/d (imp)
- bbl/s (imp;oil)
- bbl/min (imp;oil)
- bbl/h (imp;oil)
- bbl/d (imp;oil)

or

US units

- bbl/s (us;liq.) *
- bbl/min (us;liq.) *
- bbl/h (us;liq.) *
- bbl/d (us;liq.) *
- bbl/s (us;beer) *
- bbl/min (us;beer) *
- bbl/h (us;beer) *
- bbl/d (us;beer) *

Imperial units

- bbl/s (imp;beer) *
- bbl/min (imp;beer) *
- bbl/h (imp;beer) *
- bbl/d (imp;beer) *

* Visibility depends on order options or device settings

Factory setting Depends on country:
 ■ l/h (DN > 150 (6"): **m³/h** option)
 ■ gal/min (us)

Additional information *Effect*
 The selected unit applies for:
Volume flow parameter (→ ⓘ 60)

Selection

 For an explanation of the abbreviated units: → ⓘ 339

Customer-specific units

 The unit for the customer-specific volume is specified in the **User volume text** parameter.

Volume unit



Navigation ⓘ ⓘ Expert → Sensor → System units → Volume unit (0563)

Description Use this function to select the unit for the volume.

Selection

SI units

- cm³
- dm³
- m³
- ml
- l
- hl
- Ml Mega

US units

- af
- ft³
- Mft³
- Mft³
- fl oz (us)
- gal (us)
- kgal (us)
- Mgal (us)
- bbl (us;oil)
- bbl (us;tank)

Imperial units

- gal (imp)
- Mgal (imp)
- bbl (imp;oil)

or

US units

- bbl (us;liq.)*
- bbl (us;beer)*

Imperial units

- bbl (imp;beer)*

* Visibility depends on order options or device settings

Factory setting Country-specific:
 ■ l (DN > 150 (6"): **m³** option)
 ■ gal (us)

Additional information *Selection*

 For an explanation of the abbreviated units: → ⓘ 339

Customer-specific units

 The unit for the customer-specific volume is specified in the **User volume text** parameter.

Corrected volume flow unit 

Navigation   Expert → Sensor → System units → Cor.volflow unit (0558)

Description Use this function to select the unit for the corrected volume flow.

Selection	<i>SI units</i>	<i>US units</i>	<i>Imperial units</i>
	<ul style="list-style-type: none"> ■ NI/s ■ NI/min ■ NI/h ■ NI/d ■ Nhl/s ■ Nhl/min ■ Nhl/h ■ Nhl/d ■ Nm³/s ■ Nm³/min ■ Nm³/h ■ Nm³/d ■ Sl/s ■ Sl/min ■ Sl/h ■ Sl/d ■ Sm³/s ■ Sm³/min ■ Sm³/h ■ Sm³/d 	<ul style="list-style-type: none"> ■ Sft³/s ■ Sft³/min ■ Sft³/h ■ Sft³/d ■ MSft³/s ■ MSft³/min ■ MSft³/h ■ MSft³/D ■ MMSft³/s ■ MMSft³/min ■ MMSft³/h ■ MMSft³/d ■ Sgal/s (us) ■ Sgal/min (us) ■ Sgal/h (us) ■ Sgal/d (us) ■ Sbbbl/s (us;liq.) ■ Sbbbl/min (us;liq.) ■ Sbbbl/h (us;liq.) ■ Sbbbl/d (us;liq.) ■ Sbbbl/s (us;oil) ■ Sbbbl/min (us;oil) ■ Sbbbl/h (us;oil) ■ Sbbbl/d (us;oil) 	<ul style="list-style-type: none"> ■ Sgal/s (imp) ■ Sgal/min (imp) ■ Sgal/h (imp) ■ Sgal/d (imp)



Factory setting Country-specific:

- NI/h (DN > 150 (6"): **Nm³/h** option)
- Sft³/min



Additional information *Result*

The selected unit applies for:
Corrected volume flow parameter (→  61)

Selection

 For an explanation of the abbreviated units: →  339



Corrected volume unit 

Navigation   Expert → Sensor → System units → Corr. vol. unit (0575)

Description Use this function to select the unit for the corrected volume.

Selection	<i>SI units</i> <ul style="list-style-type: none"> ■ NI ■ Nhl ■ Nm³ ■ Sl ■ Sm³ 	<i>US units</i> <ul style="list-style-type: none"> ■ Sft³ ■ MSft³ ■ MMSft³ ■ Sgal (us) ■ Sbbl (us;liq.) ■ Sbbl (us;oil) 	<i>Imperial units</i> Sgal (imp)
------------------	---	--	-------------------------------------

Factory setting	Country-specific: <ul style="list-style-type: none"> ■ NI (DN > 150 (6"): Nm³ option) ■ Sft³
------------------------	--

Additional information	<i>Selection</i>  For an explanation of the abbreviated units: →  339
-------------------------------	--

Density unit 

Navigation	 Expert → Sensor → System units → Density unit (0555)
-------------------	--

Description	Use this function to select the unit for the density.
--------------------	---

Selection	<i>SI units</i> <ul style="list-style-type: none"> ■ g/cm³ ■ g/m³ ■ g/ml ■ g/l ■ kg/l ■ kg/dm³ ■ kg/m³ ■ SD4°C ■ SD15°C ■ SD20°C ■ SG4°C ■ SG15°C ■ SG20°C 	<i>US units</i> <ul style="list-style-type: none"> ■ lb/ft³ ■ lb/gal (us) ■ lb/bbl (us;oil) ■ lb/bbl (us;tank) ■ lb/in³ ■ STon/yd³ 	<i>Imperial units</i> <ul style="list-style-type: none"> ■ lb/gal (imp) ■ lb/bbl (imp;oil)
------------------	---	---	--

Other units
°API

or

US units
SG60°F*

* Visibility depends on order options or device settings

or

<i>US units</i>	<i>Imperial units</i>
■ lb/bbl (us;liq.) *	■ lb/bbl (imp;beer) *
■ lb/bbl (us;beer) *	

* Visibility depends on order options or device settings

Factory setting



Country-specific:

- kg/l
- lb/ft³

Additional information

Effect

The selected unit applies for:

- **Density setpoint 1** parameter (→  121)
- **Density setpoint 2** parameter (→  121)
- **Density** parameter (→  61)

Selection

- SD = specific density
The specific density is the ratio of the medium density to the water density at a water temperature of +4 °C (+39 °F), +15 °C (+59 °F), +20 °C (+68 °F).
- SG = specific gravity
The specific gravity is the ratio of the medium density to the water density at a water temperature of +4 °C (+39 °F), +15 °C (+59 °F), +20 °C (+68 °F).



For an explanation of the abbreviated units: →  339

Customer-specific units



The unit for the customer-specific density is specified in the **User density text** parameter.

Reference density unit**Navigation**

  Expert → Sensor → System units → Ref. dens. unit (0556)

Description

Use this function to select the unit for the reference density.

Selection

<i>SI units</i>	<i>US units</i>	<i>Other units</i>
■ kg/Nm ³	■ lb/Sft ³	°APIbase
■ kg/Nl	■ RD60°F	
■ g/Scm ³		
■ kg/Sm ³		
■ RD15°C		
■ RD20°C		

Factory setting

Country-dependent

- kg/Nl
- lb/Sft³

Additional information

Result

The selected unit applies for:

- **External reference density** parameter (→ ⓘ 116)
- **Fixed reference density** parameter (→ ⓘ 116)
- **Reference density** parameter (→ ⓘ 61)



Selection

 For an explanation of the abbreviated units: → ⓘ 339

Density 2 unit



Navigation

  Expert → Sensor → System units → Density 2 unit (0619)

Description

Select second density unit.

Selection

SI units

- g/cm³
- g/m³
- g/ml
- g/l
- kg/l
- kg/dm³
- kg/m³
- SD4°C
- SD15°C
- SD20°C
- SG4°C
- SG15°C
- SG20°C

US units

- lb/ft³
- lb/gal (us)
- lb/bbl (us;oil)
- lb/bbl (us;tank)
- lb/in³
- STon/yd³

Imperial units

- lb/gal (imp)
- lb/bbl (imp;oil)

Other units

°API

or

US units

SG60°F*

* Visibility depends on order options or device settings

or

US units

- lb/bbl (us;liq.)*
- lb/bbl (us;beer)*

Imperial units

lb/bbl (imp;beer)*

* Visibility depends on order options or device settings

Factory setting

Depends on country:

- kg/l
- lb/ft³

Additional information*Selection*



- SD = specific density
The specific density is the ratio of the medium density to the water density at a water temperature of +4 °C (+39 °F), +15 °C (+59 °F), +20 °C (+68 °F).
- SG = specific gravity
The specific gravity is the ratio of the medium density to the water density at a water temperature of +4 °C (+39 °F), +15 °C (+59 °F), +20 °C (+68 °F).

 For an explanation of the abbreviated units: →  339

Customer-specific units

 The unit for the customer-specific density is specified in the **User density text** parameter.

Temperature unit**Navigation**

  Expert → Sensor → System units → Temperature unit (0557)

Description

Use this function to select the unit for the temperature.

Selection*SI units*

- °C
- K

US units

- °F
- °R









Factory setting

Country-specific:



- °C
- °F

Additional information*Effect*

The selected unit applies for:

- **Maximum value** parameter (→  300)
- **Minimum value** parameter (→  300)
- **Maximum value** parameter (→  301)
- **Minimum value** parameter (→  300)
- **Maximum value** parameter (→  302)
- **Minimum value** parameter (→  301)
- **External temperature** parameter (→  113)
- **Reference temperature** parameter (6222)
- **Temperature** parameter (→  62)
- **Reference temperature** parameter (→  116)

Selection







 For an explanation of the abbreviated units: →  339

Pressure unit**Navigation**





  Expert → Sensor → System units → Pressure unit (0564)

Description

Use this function to select the unit for the pipe pressure.







Selection	<i>SI units</i> <ul style="list-style-type: none"> ■ MPa a ■ MPa g ■ kPa a ■ kPa g ■ Pa a ■ Pa g ■ bar ■ bar g 	<i>US units</i> <ul style="list-style-type: none"> ■ psi a ■ psi g
Factory setting	Country-specific: <ul style="list-style-type: none"> ■ bar a ■ psi a 	
Additional information	<i>Result</i> The unit is taken from: <ul style="list-style-type: none"> ■ Pressure value parameter (→  112) ■ External pressure parameter (→  112) ■ Pressure value parameter (→  62) <i>Selection</i>  For an explanation of the abbreviated units: →  339 <i>Customer-specific units</i>  The unit for the customer-specific energy is defined in the User pressure text parameter.	

Date/time format

Navigation	  Expert → Sensor → System units → Date/time format (2812)
Description	Use this function to select the desired time format for calibration history.
Selection	<ul style="list-style-type: none"> ■ dd.mm.yy hh:mm ■ dd.mm.yy hh:mm am/pm ■ mm/dd/yy hh:mm ■ mm/dd/yy hh:mm am/pm
Factory setting	dd.mm.yy hh:mm
Additional information	<i>Selection</i>  For an explanation of the abbreviated units: →  339

3.2.3 "Process parameters" submenu

Navigation  Expert → Sensor → Process param.

▶ Process parameters	
Flow damping (1802)	→  100
Density damping (1803)	→  101
Temperature damping (1822)	→  101
Flow override (1839)	→  102
Density limit (4199)	→  102
▶ Low flow cut off	→  103
▶ Partially filled pipe detection	→  106

Flow damping

Navigation  Expert → Sensor → Process param. → Flow damping (1802)

Description Use this function to enter a time constant for flow damping (PT1 element). Reduction of the variability of the flow measured value (in relation to interference). For this purpose, the depth of the flow filter is adjusted: when the filter setting increases, the reaction time of the device also increases.

User entry 0 to 100.0 s

Factory setting 0 s

Additional information*Description*

 The damping is performed by a PT1 element ²⁾.



User entry

- Value = 0: no damping
- Value > 0: damping is increased



 Damping is switched off if **0** is entered (factory setting).

Effect

 The damping affects the following variables of the device:

- Outputs →  154
- Low flow cut off →  103
- Totalizers →  255

Density damping**Navigation**

  Expert → Sensor → Process param. → Density damping (1803)

Description

Use this function to enter a time constant for the damping (PT1 element) of the density measured value.

User entry

0 to 999.9 s

Factory setting

0 s

Additional information*Description*



 The damping is performed by a PT1 element ³⁾.

User entry

- Value = 0: no damping
- Value > 0: damping is increased

 Damping is switched off if **0** is entered (factory setting).

Temperature damping**Navigation**

  Expert → Sensor → Process param. → Temp. damping (1822)

Description

Use this function to enter a time constant for the damping (PT1 element) of the temperature measured value.

User entry

0 to 999.9 s

2) Proportional behavior with first-order lag

3) Proportional behavior with first-order lag

Factory setting 0 s

Additional information *Description*

 The damping is performed by a PT1 element ⁴⁾.

User entry

- Value = 0: no damping
- Value > 0: damping is increased

 Damping is switched off if **0** is entered (factory setting).

Flow override

Navigation   Expert → Sensor → Process param. → Flow override (1839)

Description Use this function to select whether to interrupt the evaluation of measured values. This is useful for the cleaning processes of a pipeline, for example.

Selection

- Off
- On

Factory setting Off

Additional information *Description*

Flow override is active

- The **453 Flow override** diagnostic message is output.
- Output values
 - Temperature: continues to be output
 - Totalizer 1...3: stop being totalized

 The **Flow override** option can also be activated in the **Status input** submenu: **Assign status input** parameter (→  152).

Density limit

Navigation   Expert → Sensor → Process param. → Density limit (4199)



Description Enter limit value for the observed oil density. For higher °API values or lower kg/m³ values this limit value will be output.

User entry Positive floating-point number





Factory setting 0 kg/l

4) Proportional behavior with first-order lag



"Low flow cut off" submenu

Navigation   Expert → Sensor → Process param. → Low flow cut off







▶ **Low flow cut off**

Assign process variable (1837)	→  103
On value low flow cutoff (1805)	→  103
Off value low flow cutoff (1804)	→  104
Pressure shock suppression (1806)	→  104

Assign process variable 

Navigation	  Expert → Sensor → Process param. → Low flow cut off → Assign variable (1837)
Description	Use this function to select the process variable for low flow cutoff detection.
Selection	<ul style="list-style-type: none"> ■ Off ■ Mass flow ■ Volume flow ■ Corrected volume flow *
Factory setting	Mass flow

On value low flow cutoff 

Navigation	  Expert → Sensor → Process param. → Low flow cut off → On value (1805)
Prerequisite	A process variable is selected in the Assign process variable parameter (→  103).
Description	Use this function to enter a switch-on value for low flow cut off. Low flow cut off is activated if the value entered is not equal to 0 →  104.
User entry	Positive floating-point number
Factory setting	Depends on country and nominal diameter →  334
Additional information	<p><i>Dependency</i></p> <p> The unit depends on the process variable selected in the Assign process variable parameter (→  103).</p>

* Visibility depends on order options or device settings

Off value low flow cutoff

Navigation	Expert → Sensor → Process param. → Low flow cut off → Off value (1804)
Prerequisite	A process variable is selected in the Assign process variable parameter (→ 103).
Description	Use this function to enter a switch-off value for low flow cut off. The switch-off value is entered as a positive hysteresis from the switch-on value → 103.
User entry	0 to 100.0 %
Factory setting	50 %
Additional information	<i>Example</i>

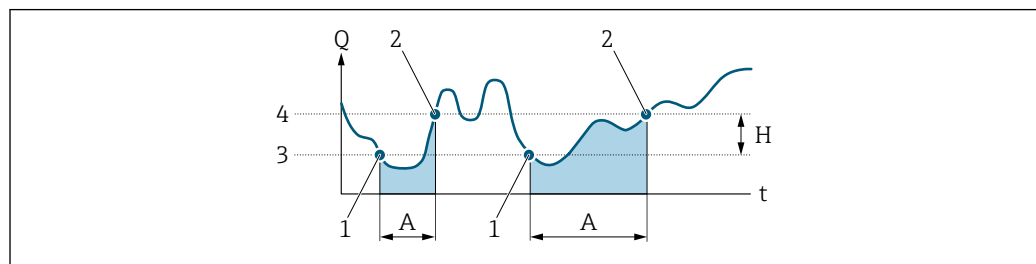

A0012887

<i>Q</i>	<i>Flow</i>
<i>t</i>	<i>Time</i>
<i>H</i>	<i>Hysteresis</i>
<i>A</i>	<i>Low flow cut off active</i>
<i>1</i>	<i>Low flow cut off is activated</i>
<i>2</i>	<i>Low flow cut off is deactivated</i>
<i>3</i>	<i>On value entered</i>
<i>4</i>	<i>Off value entered</i>

Pressure shock suppression

Navigation	Expert → Sensor → Process param. → Low flow cut off → Pres. shock sup. (1806)
Prerequisite	A process variable is selected in the Assign process variable parameter (→ 103).
Description	Use this function to enter the time interval for signal suppression (= active pressure shock suppression).
User entry	0 to 100 s
Factory setting	0 s

Additional information

Description

Pressure shock suppression is enabled

- Prerequisite:
 - Flow rate < on-value of low flow cut off
 - or
 - Change in the flow direction
- Output values
 - Current output: outputs the current corresponding to zero flow
 - Flow displayed: 0
 - Totalizer: the totalizers are pegged at the last correct value

Pressure shock suppression is disabled

- Prerequisite: the time interval set in this function has elapsed.
- If the flow also exceeds the off value for low flow cut off, the device starts processing and displaying the current flow value again.

Example

When closing a valve, momentarily strong fluid movements may occur in the pipeline, which are registered by the measuring system. These totalized flow values lead to a false totalizer status, particularly during batching processes.

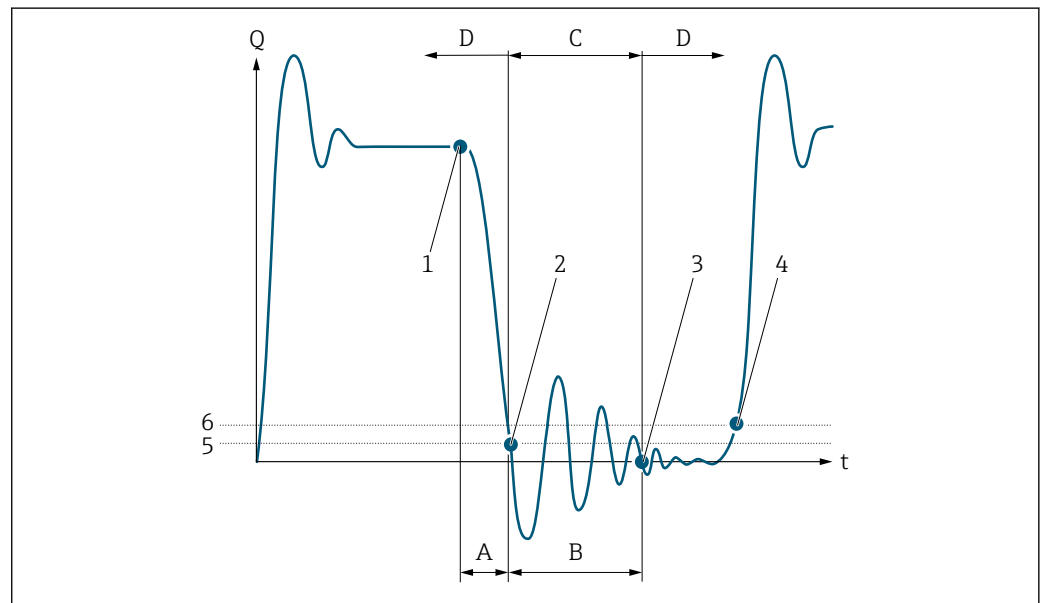





A0012888

- Q Flow
- t Time
- A After run
- B Pressure shock
- C Pressure shock suppression active according to the time entered
- D Pressure shock suppression inactive
- 1 Valve closes
- 2 Flow falls below the on-value of the low flow cut off: pressure shock suppression is activated
- 3 The time entered has elapsed: pressure shock suppression is deactivated
- 4 The current flow value is processed and displayed again
- 5 On value for low flow cut off
- 6 Off value for low flow cut off

"Partially filled pipe detection" submenu

Navigation  Expert → Sensor → Process param. → Partial pipe det

▶ Partially filled pipe detection	
Assign process variable (1860)	→  106
Low value partial filled pipe detection (1861)	→  106
High value partial filled pipe detection (1858)	→  107
Response time part. filled pipe detect. (1859)	→  107
Maximum damping partial filled pipe det. (6040)	→  108

Assign process variable

Navigation  Expert → Sensor → Process param. → Partial pipe det → Assign variable (1860)

Description Use this function to select a process variable to detect empty or partially filled measuring tubes.

For gas measurement: Deactivate monitoring due to low gas density.

Selection

- Off
- Density
- Calculated reference density

Factory setting Off

Low value partial filled pipe detection

Navigation  Expert → Sensor → Process param. → Partial pipe det → Low value (1861)





Prerequisite A process variable is selected in the **Assign process variable** parameter (→  106).

Description Use this function to enter a lower limit value to enable detection of empty or partially filled measuring tubes. If the measured density falls below this value, monitoring is enabled.







User entry Signed floating-point number

Factory setting Depends on country:



- 200 kg/m³
- 12.5 lb/ft³

Additional information	<p><i>User entry</i></p> <p>The lower limit value must be less than the upper limit value defined in the High value partial filled pipe detection parameter (→  107).</p> <p> The unit depends on the process variable selected in the Assign process variable parameter (→  106).</p> <p><i>Limit value</i></p> <p> If the displayed value is outside the limit value, the measuring device displays the 862 Partly filled pipe diagnostic message.</p>
-------------------------------	---

High value partial filled pipe detection

Navigation	  Expert → Sensor → Process param. → Partial pipe det → High value (1858)
Prerequisite	A process variable is selected in the Assign process variable parameter (→  106).
Description	Use this function to enter an upper limit value to enable detection of empty or partially filled measuring tubes. If the measured density exceeds this value, detection is enabled.
User entry	Signed floating-point number
Factory setting	Depends on country: <ul style="list-style-type: none"> ▪ 6 000 kg/m³ ▪ 374.6 lb/ft³
Additional information	<p><i>User entry</i></p> <p>The upper limit value must be greater than the lower limit value defined in the Low value partial filled pipe detection parameter (→  106).</p> <p> The unit depends on the process variable selected in the Assign process variable parameter (→  106).</p> <p><i>Limit value</i></p> <p> If the displayed value is outside the limit value, the measuring device displays the 862 Partly filled pipe diagnostic message.</p>

Response time part. filled pipe detect.

Navigation	  Expert → Sensor → Process param. → Partial pipe det → Response time (1859)
Prerequisite	A process variable is selected in the Assign process variable parameter (→  106).
Description	Use this function to enter the minimum time (hold time) the signal must be present before diagnostic message S962 "Pipe only partly filled" is triggered in the event of a partially filled or empty measuring pipe.
User entry	0 to 100 s
Factory setting	1 s

Maximum damping partial filled pipe det.

Navigation	Expert → Sensor → Process param. → Partial pipe det → Max. damping (6040)
Description	Use this function to enter a damping value to enable detection of empty or partially filled measuring tubes.
User entry	Positive floating-point number
Factory setting	0
Additional information	<p><i>Description</i></p> <p>If oscillation damping exceeds the specified value, the measuring device presumes that the pipe is partially filled and the flow signal is set to 0. The measuring device displays the △S862 Partly filled pipe diagnostic message. In the case of non-homogeneous media or air pockets, the damping of the measuring tubes increases.</p> <p><i>User entry</i></p> <ul style="list-style-type: none"> ▪ Damping is disabled if 0 is entered (factory setting). ▪ Damping is enabled if the value entered is greater than 0. ▪ The value entered depends on application-specific influence variables, such as the medium, nominal diameter, sensor etc. <p><i>Example</i></p> <ul style="list-style-type: none"> ▪ If the pipe is filled normally the value of the oscillation damping is 500. ▪ If the pipe is partially filled the value of the oscillation damping is > 5000. ▪ A practical damping value would then be 2000: enter 2000 as the value.

3.2.4 "Measurement mode" submenu

Navigation Expert → Sensor → Measurement mode

▶ Measurement mode	
MFT (Multi-Frequency Technology)	→ 109
Select medium type	→ 109
Select gas type	→ 109
Reference sound velocity	→ 110
Temperature coefficient sound velocity	→ 110
Gas Fraction Handler	→ 110

MFT (Multi-Frequency Technology)

Navigation	Expert → Sensor → Measurement mode → MFT (6242)
Description	Enable/disable multi-frequency technology to increase the measuring accuracy in the event of microbubbles in the medium.
Selection	<ul style="list-style-type: none"> ■ No ■ Yes
Factory setting	Yes
Additional information	Multi-frequency technology increases the measuring accuracy in the event of microbubbles in the medium (e.g. when measuring ice-cream, cream cheese, milk, honey, jam, viscous heavy oils, gas-saturated media etc.).

Select medium type

Navigation	Expert → Sensor → Measurement mode → SelectMediumType (6062)
Description	Use this function to select the type of medium: "Gas" or "Liquid". Select the "Other" option in exceptional cases in order to enter the properties of the medium manually (e.g. for highly compressive liquids such as sulfuric acid).
Selection	<ul style="list-style-type: none"> ■ Liquid ■ Gas ■ Other
Factory setting	Liquid



Select gas type

Navigation	Expert → Sensor → Measurement mode → Select gas type (6074)
Prerequisite	In the Medium selection submenu, the Gas option is selected.
Description	Select measured gas type.
Selection	<ul style="list-style-type: none"> ■ Air ■ Ammonia NH3 ■ Argon Ar ■ Sulfur hexafluoride SF6 ■ Oxygen O2 ■ Ozone O3 ■ Nitrogen oxide NOx ■ Nitrogen N2 ■ Nitrous oxide N2O ■ Methane CH4 ■ Methane CH4 + 10% Hydrogen H2

- Methane CH₄ + 20% Hydrogen H₂
- Methane CH₄ + 30% Hydrogen H₂
- Hydrogen H₂
- Helium He
- Hydrogen chloride HCl
- Hydrogen sulfide H₂S
- Ethylene C₂H₄
- Carbon dioxide CO₂
- Carbon monoxide CO
- Chlorine Cl₂
- Butane C₄H₁₀
- Propane C₃H₈
- Propylene C₃H₆
- Ethane C₂H₆
- Other

Factory setting Methane CH₄

Reference sound velocity

Navigation   Expert → Sensor → Measurement mode → Sound velocity (6147)

Prerequisite In the **Select gas type** parameter (→  109), the **Other** option is selected.

Description Enter sound velocity of the gas at 0 °C (32 °F).

User entry 1 to 99 999.9999 m/s

Factory setting 415.0 m/s

Temperature coefficient sound velocity

Navigation   Expert → Sensor → Measurement mode → Temp. coeff. SV (6181)

Prerequisite In the **Select gas type** parameter (→  109), the **Other** option is selected.

Description Enter the temperature coefficient for the gas sound velocity.

User entry Positive floating point number

Factory setting 0.87 (m/s)/K

Gas Fraction Handler

Navigation   Expert → Sensor → Measurement mode → Gas Frac Handler (6377)

Description Activates the Gas Fraction Handler function for two phase media.

Selection

- Off
- Moderate
- Powerful

Factory setting

Moderate

Additional information

- When a second phase is detected, large fluctuations in the flow and density will occur.
- The Gas Fraction Handler stabilizes the output values and enables better readability for operators and easier interpretation by the distributed control system.
- The level of smoothing is adjusted according to the severity of the disturbances introduced by the second phase.



The influence of the disturbances can be configured in two steps via this switch:







- **Off** option: Deactivates the Gas Fraction Handler. When a second phase is present, large fluctuations of flow and density will occur.
- **Moderate** option: Use for applications with low level or intermittent levels of second phase.
- **Powerful** option: Use for applications with very significant levels of second phase.

The Gas Fraction Handler is cumulative to any fixed damping constants applied to flow and density that are set elsewhere in the instrument parameterization.

Additional information in the **Medium index** submenu (→  266)

3.2.5 "External compensation" submenu

Navigation   Expert → Sensor → External comp.

► External compensation	
Pressure compensation (6130)	→  112
Pressure value (6059)	→  112
External pressure (6209)	→  112
Temperature correction source (6184)	→  113
External temperature (6080)	→  113
Application specific input source 0 (6401)	→  114
Application specific input source 1 (6402)	→  114

Pressure compensation		
Navigation	Expert → Sensor → External comp. → Pressure compen. (6130)	
Description	Use this function to select the type of pressure compensation.	
Selection	<ul style="list-style-type: none"> ■ Off ■ Fixed value ■ External value * ■ Current input 1 * ■ Current input 2 * 	
Factory setting	Off	
Additional information	<i>Selection</i> <ul style="list-style-type: none"> ■ Fixed value A fixed pressure value is used for compensation: Pressure value parameter (→ 112) ■ External value The pressure value read in via HART is used for compensation. ■ Current input 1 option, Current input 2 option The pressure value read in via the current input is used for compensation. 	

Pressure value		
Navigation	Expert → Sensor → External comp. → Pressure value (6059)	
Prerequisite	In the Pressure compensation parameter (→ 112), the Fixed value option is selected.	
Description	Use this function to enter a value for the process pressure that is used for pressure correction.	
User entry	Positive floating-point number	
Factory setting	1.01325 bar	
Additional information	<i>Dependency</i> <p> The unit is taken from the Pressure unit parameter (→ 98)</p>	

External pressure		
Navigation	Expert → Sensor → External comp. → External press. (6209)	
Prerequisite	In the Pressure compensation parameter (→ 112), the External value option or the Current input 1...n option is selected.	



* Visibility depends on order options or device settings

Description Displays the external pressure value.

Additional information *Dependency*

 The unit is taken from the **Pressure unit** parameter (→  98)

Temperature correction source

Navigation   Expert → Sensor → External comp. → Temp.corr.source (6184)

Description Use this function to select the temperature mode.

Selection

- Internal measured value
- External value^{*}
- Current input 1^{*}
- Current input 2^{*}
- Current input 3^{*}

Factory setting Internal measured value

Additional information *Description*

Use this function to select the type of temperature compensation.

Selection

All the options available for selection are used for measured value compensation.

- Internal measured value
The temperature value measured internally (temperature sensor of the measuring sensor) is used for compensation.
- External value
The temperature value read in via HART is used for compensation.
- **Current input 1** option, **Current input 2** option, Visibility depends on order options or device settings.
The temperature value read in via the current input is used for compensation.



External temperature

Navigation   Expert → Sensor → External comp. → External temp. (6080)

Prerequisite In the **Temperature mode** parameter (→  113), the **External value** option or the **Current input 1...n** option is selected.

Description Displays the external temperature.

Additional information *Dependency*

 The unit is taken from the **Temperature unit** parameter (→  98)

* Visibility depends on order options or device settings

Application specific input source 0

Navigation	Expert → Sensor → External comp. → Spec. source 0 (6401)
Prerequisite	Only if application-specific calculation has been ordered as a special option.
Description	Select source for input value 0 used for the application specific calculation.
Selection	<ul style="list-style-type: none"> ■ Off ■ External value * ■ Current input 1 * ■ Current input 2 * ■ Current input 3 *
Factory setting	Off

Application specific input source 1

Navigation	Expert → Sensor → External comp. → Spec. source 1 (6402)
Prerequisite	Only if application-specific calculation has been ordered as a special option.
Description	Select source for the input value 1 used for the application specific calculation.
Selection	<ul style="list-style-type: none"> ■ Off ■ External value * ■ Current input 1 * ■ Current input 2 * ■ Current input 3 *
Factory setting	Off



3.2.6 "Calculated values" submenu

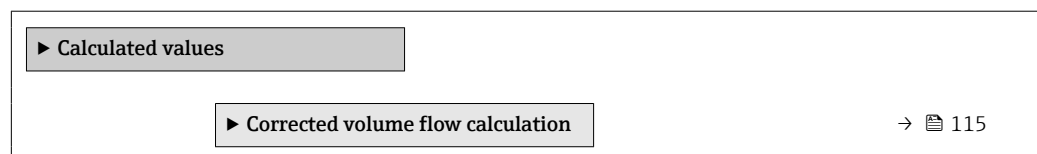





Navigation Expert → Sensor → Calculated value





* Visibility depends on order options or device settings

"Corrected volume flow calculation" submenu

Navigation   Expert → Sensor → Calculated value → Corr. vol.flow.

▶ Corrected volume flow calculation	
Select reference density (1812)	→  115
External reference density (6198)	→  116
Fixed reference density (1814)	→  116
Reference temperature (1816)	→  116
Linear expansion coefficient (1817)	→  117
Square expansion coefficient (1818)	→  117

Select reference density**Navigation**

  Expert → Sensor → Calculated value → Corr. vol.flow. → Select ref. dens (1812)

Description

Use this function to select the reference density for calculating the corrected volume flow.

Selection



- Fixed reference density
- Calculated reference density
- Current input 1 *
- Current input 2 *

Factory setting

Calculated reference density

Additional information*Selection*





The **Reference density by API table 53** option is suitable only for applications involving LPG⁵⁾, where the flow rate is measured on the basis of the corrected volume flow.

Selecting this option means that the reference density is used, taking into account the values in table 53 E of API MPMS section 11.2. Temperature measurement (measured internally or read into the device from an external source →  111 →  111) and density measurement take place during operation while the medium is flowing. The mass flow is divided by the reference density to give the corrected volume flow and is issued as an output signal.

* Visibility depends on order options or device settings





5) liquefied petroleum gas

External reference density

Navigation	 Expert → Sensor → Calculated value → Corr. vol.flow. → Ext. ref.density (6198)
Prerequisite	One of the following options is selected in the Corrected volume flow calculation parameter (→  115): <ul style="list-style-type: none"> ▪ Current input 1 * ▪ Current input 2 *
Description	Displays the reference density which is read in externally, e.g. via the current input, HART input.
User interface	Floating point number with sign
Additional information	<i>Dependency</i>  The unit is taken from the Reference density unit parameter (→  96)



Fixed reference density



Navigation	 Expert → Sensor → Calculated value → Corr. vol.flow. → Fix ref.density (1814)
Prerequisite	The Fixed reference density option is selected in the Corrected volume flow calculation parameter (→  115) parameter.
Description	Use this function to enter a fixed value for the reference density.
User entry	Positive floating-point number
Factory setting	1 kg/Nl
Additional information	<i>Dependency</i>  The unit is taken from the Reference density unit parameter (→  96)

Reference temperature



Navigation	 Expert → Sensor → Calculated value → Corr. vol.flow. → Ref. temperature (1816)
Prerequisite	The Calculated reference density option is selected in the Corrected volume flow calculation parameter (→  115) parameter.
Description	Use this function to enter a reference temperature for calculating the reference density.
User entry	-273.15 to 99 999 °C



* Visibility depends on order options or device settings

Factory setting

Country-specific:

- +20 °C
- +68 °F

Additional information*Dependency*

 The unit is taken from the **Temperature unit** parameter (→  98)



Reference density calculation

$$\rho_n = \rho \cdot (1 + \alpha \cdot \Delta t + \beta \cdot \Delta t^2)$$

A0023403

- ρ_N : reference density
- ρ : fluid density currently measured
- t : fluid temperature currently measured
- t_N : reference temperature at which the reference density is calculated (e.g. 20 °C)
- Δt : $t - t_N$
- α : linear expansion coefficient of the fluid, unit = [1/K]; K = Kelvin
- β : square expansion coefficient of the fluid, unit = [1/K²]

Linear expansion coefficient**Navigation**

  Expert → Sensor → Calculated value → Corr. vol.flow. → Linear exp coeff (1817)

Prerequisite

The **Calculated reference density** option is selected in the **Corrected volume flow calculation** parameter (→  115) parameter.

Description

Use this function to enter a linear, fluid-specific expansion coefficient for calculating the reference density.



User entry

Signed floating-point number

Factory setting

0.0 1/K

Square expansion coefficient**Navigation**

  Expert → Sensor → Calculated value → Corr. vol.flow. → Square exp coeff (1818)

Prerequisite

The **Calculated reference density** option is selected in the **Corrected volume flow calculation** parameter (→  115) parameter.

Description

For fluid with a non-linear expansion pattern: use this function to enter a quadratic, fluid-specific expansion coefficient for calculating the reference density.









User entry

Signed floating-point number



Factory setting0.0 1/K²

3.2.7 "Sensor adjustment" submenu

Navigation  Expert → Sensor → Sensor adjustm.

▶ Sensor adjustment	
Installation direction (1809)	→  118
Installation angle roll (6282)	→  118
Installation angle pitch (6236)	→  119
▶ Density adjustment	→  120
▶ Extended density adjustment	→  123
▶ Process variable adjustment	→  126
▶ Zero verification	→  131
▶ Zero adjustment	→  134

Installation direction

Navigation	 Expert → Sensor → Sensor adjustm. → Install. direct. (1809)
Description	Use this function to change the sign of the medium flow direction.
Selection	<ul style="list-style-type: none"> ■ Forward flow ■ Reverse flow
Factory setting	Forward flow
Additional information	<p><i>Description</i></p> <p> Before changing the sign: ascertain the actual direction of fluid flow with reference to the direction indicated by the arrow on the sensor nameplate.</p>

Installation angle roll

Navigation	 Expert → Sensor → Sensor adjustm. → Inst. angle roll (6282)
Prerequisite	Available only with Promass Q.
Description	Use this function to enter the roll angle in degrees to improve measuring accuracy.
User entry	-180 to 180°

Factory setting 0 °

Additional information The technically relevant roll angle is the angle shaded gray = -180 to +180 °.
 Example (blue): Installation of the device with a roll angle $\beta = +45^\circ$

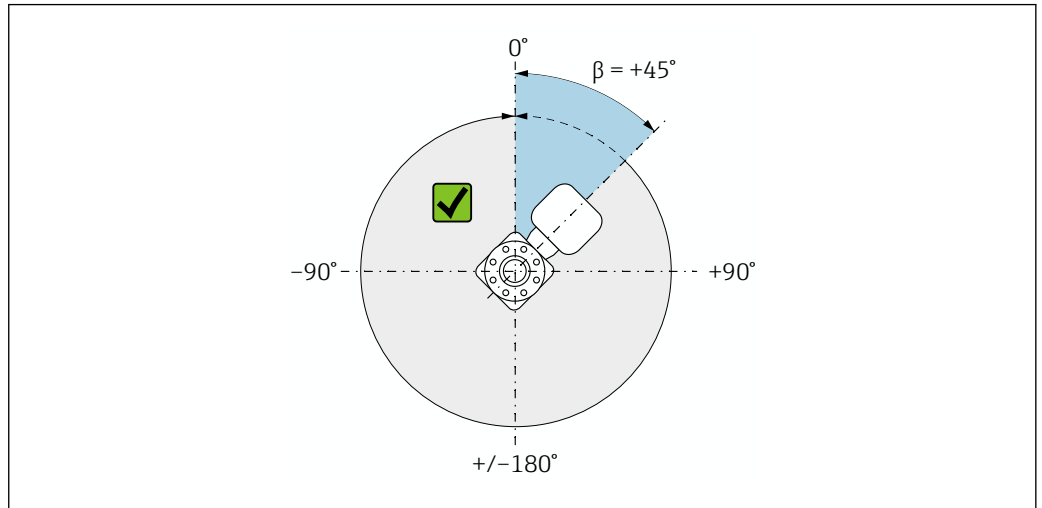

2 Top view in flow direction

A0040033

Installation angle pitch



Navigation Expert → Sensor → Sensor adjustm. → Inst.angle pitch (6236)

Prerequisite Available only with Promass Q.

Description Use this function to enter the pitch angle in degrees to improve measuring accuracy.

User entry -90 to +90 °

Factory setting 0 °

Additional information The technically relevant pitch angle is the angle shaded gray = -90 to +90 °.
 Example (blue): Installation of the device with a pitch angle $\alpha = +30^\circ$

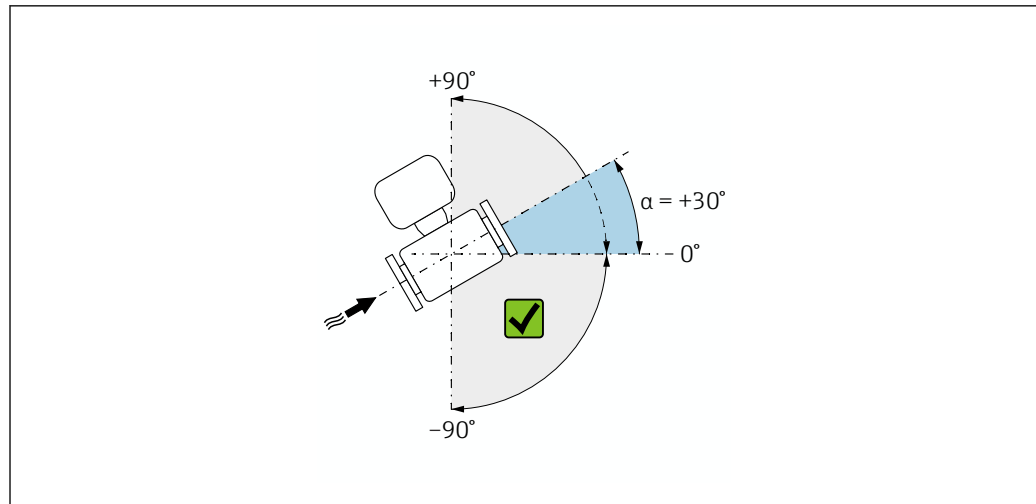

A0040032

3 Side view with flow direction from left to right.

"Density adjustment" submenu



Note the following before performing the adjustment:



- A density adjustment only makes sense if there is little variation in the operating conditions and the density adjustment is performed under the operating conditions.
- The density adjustment scales the internally computed density value with a user-specific slope and offset.
- A 1-point or 2-point density adjustment can be performed.
- For a 2-point density adjustment, there must be a difference of at least 0.2 kg/l between the two target density values.
- The reference media must be gas-free or pressurized so that any gas they contain is compressed.
- The reference density measurements must be performed at the same medium temperature that prevails in the process, as otherwise the density adjustment will not be accurate.
- The correction resulting from the density adjustment can be deleted with the **Restore original** option.

Navigation





Expert → Sensor → Sensor adjustm. → Density adjustm.



► Density adjustment	
Density adjustment mode (6043)	→ 121
Density setpoint 1 (6045)	→ 121
Density setpoint 2 (6046)	→ 121
Execute density adjustment (6041)	→ 122
Progress (2808)	→ 122

Density adjustment factor (6042)	→  122
Density adjustment offset (6044)	→  122



Density adjustment mode

Navigation	  Expert → Sensor → Sensor adjustm. → Density adjustm. → Adjustment mode (6043)
Description	Displays the method for field density adjustment.
Selection	<ul style="list-style-type: none"> ▪ 1 point adjustment ▪ 2 point adjustment
Factory setting	1 point adjustment

Density setpoint 1

Navigation	  Expert → Sensor → Sensor adjustm. → Density adjustm. → Density setpt 1 (6045)
Description	Displays the existing density value.
User entry	The entry depends on the unit selected in the Density unit parameter (0555) (→  95).
Factory setting	1 kg/l

Density setpoint 2

Navigation	  Expert → Sensor → Sensor adjustm. → Density adjustm. → Density setpt 2 (6046)
Prerequisite	In the Density adjustment mode parameter, the 2 point adjustment option is selected.
Description	Displays the second density setpoint.
User entry	The entry depends on the unit selected in the Density unit parameter (0555) (→  95).
Factory setting	1 kg/l





Execute density adjustment

Navigation	 Expert → Sensor → Sensor adjustm. → Density adjustm. → Density adjustm. (6041)
Description	Select the next step to be performed for the density adjustment.
Selection	<ul style="list-style-type: none"> ■ Cancel * ■ Busy * ■ Ok * ■ Density adjust failure * ■ Measure density 1 * ■ Measure density 2 * ■ Calculate * ■ Restore original *
Factory setting	Ok

Progress

Navigation	 Expert → Sensor → Sensor adjustm. → Density adjustm. → Progress (2808)
Description	The progress of the process is indicated.
User interface	0 to 100 %



Density adjustment factor

Navigation	  Expert → Sensor → Sensor adjustm. → Density adjustm. → Dens. adj factor (6042)
Description	Displays the current correction factor for the density.
User interface	Signed floating-point number
Factory setting	1
Additional information	 Manual adjustment of the value: Density factor parameter (→  129)



Density adjustment offset



Navigation	 Expert → Sensor → Sensor adjustm. → Density adjustm. → Dens. adj offset (6044)
Description	Shows the calculated correction offset for the density.

* Visibility depends on order options or device settings











User interface	Signed floating-point number
Factory setting	0
Additional information	 Manual adjustment of the value: Density offset parameter (→  128)

"Extended density adjustment" submenu

 For detailed information on the parameter descriptions of the "Extended density adjustment" application package, see the Special Documentation for the device →  7



Navigation   Expert → Sensor → Sensor adjustm. → ExtendDensAdjust

▶ Extended density adjustment

Constant offset (5968)	→  123
Linear density factor (5967)	→  124
Linear temperature factor (5966)	→  124
Linear pressure factor (5965)	→  124
Quadratic density factor (5964)	→  124
Quadratic temperature factor (5963)	→  125
Quadratic pressure factor (5962)	→  125
Combined density-temperature factor (5961)	→  125
Combined density-pressure factor (5971)	→  125
Combined temperature-pressure factor (5970)	→  126
Cubic temperature factor (5969)	→  126

Constant offset





Navigation   Expert → Sensor → Sensor adjustm. → ExtendDensAdjust → ConstantOffset (5968)

Description Shows the constant offset.

User entry Signed floating-point number

Factory setting 0 kg/m³

Linear density factor



Navigation   Expert → Sensor → Sensor adjustm. → ExtendDensAdjust → LinearDensFactor (5967)

Description Shows the linear density factor.

User entry Signed floating-point number

Factory setting 1

Linear temperature factor

Navigation   Expert → Sensor → Sensor adjustm. → ExtendDensAdjust → LinearTempFactor (5966)

Description Shows the linear temperature factor.

User entry Signed floating-point number

Factory setting 0 (kg/m³)/°C

Linear pressure factor



Navigation   Expert → Sensor → Sensor adjustm. → ExtendDensAdjust → LinearPressFact (5965)

Description Shows the linear pressure factor.

User entry Signed floating-point number

Factory setting 0 (kg/m³)/bara

Quadratic density factor



Navigation   Expert → Sensor → Sensor adjustm. → ExtendDensAdjust → QuadrDensFactor (5964)

Description Shows the quadratic density factor.

User entry Signed floating-point number

Factory setting 0 1/(kg/m³)

Quadratic temperature factor



Navigation   Expert → Sensor → Sensor adjustm. → ExtendDensAdjust → QuadrTempFactor (5963)

Description Shows the quadratic temperature factor.

User entry Signed floating-point number

Factory setting 0 (kg/m³)/°C²

Quadratic pressure factor



Navigation   Expert → Sensor → Sensor adjustm. → ExtendDensAdjust → QuadrPressFactor (5962)

Description Shows the quadratic pressure factor.

User entry Signed floating-point number

Factory setting 0 (kg/m³)/bara²

Combined density-temperature factor

Navigation   Expert → Sensor → Sensor adjustm. → ExtendDensAdjust → DensTempFactor (5961)

Description Shows the combined density-temperature factor.

User entry Signed floating-point number

Factory setting 0 1/°C

Combined density-pressure factor



Navigation   Expert → Sensor → Sensor adjustm. → ExtendDensAdjust → DensPressFactor (5971)

Description Shows the combined density-pressure factor.

User entry Signed floating-point number

Factory setting 0 1/bara

Combined temperature-pressure factor



Navigation   Expert → Sensor → Sensor adjustm. → ExtendDensAdjust → TempPressFactor (5970)

Description Shows the combined temperature-pressure factor.

User entry Signed floating-point number

Factory setting 0 (kg/m³)/(°C bara)

Cubic temperature factor



Navigation   Expert → Sensor → Sensor adjustm. → ExtendDensAdjust → CubicTempFactor (5969)



Description Shows the cubic temperature factor.





User entry Signed floating-point number







Factory setting 0 (kg/m³)/°C³

"Process variable adjustment" submenu

 The adjustments to the offsets and factors in the **Process variable adjustment** submenu (→  126) do not affect the calculated values, such as concentration, NSV.



Navigation   Expert → Sensor → Sensor adjustm. → Variable adjust

► Process variable adjustment	
Mass flow offset (1831)	→  127
Mass flow factor (1832)	→  127
Volume flow offset (1841)	→  128
Volume flow factor (1846)	→  128
Density offset (1848)	→  128

Density factor (1849)	→  129
Corrected volume flow offset (1866)	→  129
Corrected volume flow factor (1867)	→  129
Reference density offset (1868)	→  130
Reference density factor (1869)	→  130
Temperature offset (1870)	→  130
Temperature factor (1871)	→  131



Mass flow offset





Navigation	  Expert → Sensor → Sensor adjustm. → Variable adjust → Mass flow offset (1831)
Description	Use this function to enter the zero point shift for the mass flow trim. The mass flow unit on which the shift is based is kg/s.
User entry	Signed floating-point number
Factory setting	0 kg/s
Additional information	<p><i>Description</i></p> <p> Corrected value = (factor × value) + offset</p>

Mass flow factor





Navigation	  Expert → Sensor → Sensor adjustm. → Variable adjust → Mass flow factor (1832)
Description	Use this function to enter a quantity factor (without time) for the mass flow. This multiplication factor is applied over the mass flow range.
User entry	Positive floating-point number
Factory setting	1
Additional information	<p><i>Description</i></p> <p> Corrected value = (factor × value) + offset</p>



Volume flow offset 

Navigation	 Expert → Sensor → Sensor adjustm. → Variable adjust → Vol. flow offset (1841)
Description	Use this function to enter the zero point shift for the volume flow trim. The volume flow unit on which the shift is based is m ³ /s.
User entry	Signed floating-point number
Factory setting	0 m ³ /s
Additional information	<i>Description</i>  Corrected value = (factor × value) + offset

Volume flow factor 

Navigation	 Expert → Sensor → Sensor adjustm. → Variable adjust → Vol. flow factor (1846)
Description	Use this function to enter a quantity factor (without time) for the volume flow. This multiplication factor is applied over the volume flow range.
User entry	Positive floating-point number
Factory setting	1
Additional information	<i>Description</i>  Corrected value = (factor × value) + offset

Density offset 

Navigation	 Expert → Sensor → Sensor adjustm. → Variable adjust → Density offset (1848)
Description	Use this function to enter the zero point shift for the density trim. The density unit on which the shift is based is kg/m ³ .
User entry	Signed floating-point number
Factory setting	0 kg/m ³
Additional information	<i>Description</i>  Corrected value = (factor × value) + offset

Density factor



Navigation	Expert → Sensor → Sensor adjustm. → Variable adjust → Density factor (1849)
Description	Use this function to enter a quantity factor for the density. This multiplication factor is applied over the density range.
User entry	Positive floating-point number
Factory setting	1
Additional information	<i>Description</i> Corrected value = (factor × value) + offset

Corrected volume flow offset



Navigation	Expert → Sensor → Sensor adjustm. → Variable adjust → Corr. vol offset (1866)
Description	Use this function to enter the zero point shift for the corrected volume flow trim. The corrected volume flow unit on which the shift is based is 1 Nm ³ /s.
User entry	Signed floating-point number
Factory setting	0 Nm ³ /s
Additional information	<i>Description</i> Corrected value = (factor × value) + offset

Corrected volume flow factor



Navigation	Expert → Sensor → Sensor adjustm. → Variable adjust → Corr. vol factor (1867)
Description	Use this function to enter a quantity factor (without time) for the corrected volume flow. This multiplication factor is applied over the corrected volume flow range.
User entry	Positive floating-point number
Factory setting	1
Additional information	<i>Description</i> Corrected value = (factor × value) + offset

Reference density offset 

Navigation   Expert → Sensor → Sensor adjustm. → Variable adjust → Ref.dens. offset (1868)

Description Use this parameter to enter the zero point shift for the reference density trim. The reference density unit on which the shift is based is 1 kg/Nm³.

User entry Signed floating-point number

Factory setting 0 kg/Nm³

Additional information *Description*

 Corrected value = (factor × value) + offset

Reference density factor 

Navigation   Expert → Sensor → Sensor adjustm. → Variable adjust → Ref.dens. factor (1869)

Description Use this function to enter a quantity factor (without time) for the reference density. This multiplication factor is applied over the reference density range.



User entry Positive floating-point number

Factory setting 1

Additional information *Description*

 Corrected value = (factor × value) + offset

Temperature offset 

Navigation   Expert → Sensor → Sensor adjustm. → Variable adjust → Temp. offset (1870)

Description Use this function to enter the zero point shift for the temperature trim. The temperature unit on which the shift is based is K.

User entry Signed floating-point number

Factory setting 0 K

Additional information *Description*

 Corrected value = (factor × value) + offset

Temperature factor



Navigation	Expert → Sensor → Sensor adjustm. → Variable adjust → Temp. factor (1871)
Description	Use this function to enter a quantity factor for the temperature. In each case, this factor refers to the temperature in K.
User entry	Positive floating-point number
Factory setting	1
Additional information	<p><i>Description</i></p> <p> Corrected value = (factor × value) + offset</p>

"Zero verification" wizard

Navigation Expert → Sensor → Sensor adjustm. → ZeroVerification

▶ Zero verification

Process conditions	→ 131
Progress (2808)	→ 132
Status (6253)	→ 132
Additional information	→ 132
Recommendation: (6000)	→ 133
Root cause (6444)	→ 133
Abort cause	→ 133
Zero point measured (5999)	→ 133
Zero point standard deviation (5996)	→ 134

Process conditions

Navigation	Expert → Sensor → Sensor adjustm. → ZeroVerification → Process condit.
Description	Ensure process conditions as follows.

Selection	<ul style="list-style-type: none"> ■ Tubes are completely filled ■ Process operational pressure applied ■ No-flow conditions (closed valves) ■ Process and ambient temperatures stable
------------------	--

Factory setting	-
------------------------	---

Progress

Navigation	 Expert → Sensor → Sensor adjustm. → ZeroVerification → Progress (2808)
-------------------	--

Description	The progress of the process is indicated.
--------------------	---

User interface	0 to 100 %
-----------------------	------------

Status

Navigation	 Expert → Sensor → Sensor adjustm. → ZeroVerification → Status (6253)
-------------------	---

Description	Shows the status of the process.
--------------------	----------------------------------

User interface	<ul style="list-style-type: none"> ■ Busy ■ Failed ■ Done
-----------------------	--

Factory setting	-
------------------------	---

Additional information

Navigation	 Expert → Sensor → Sensor adjustm. → ZeroVerification → Additional info.
-------------------	---

Description	Indicate whether to display additional information.
--------------------	---

Selection	<ul style="list-style-type: none"> ■ Hide ■ Show
------------------	--

Factory setting	Hide
------------------------	------

Recommendation:

Navigation	 Expert → Sensor → Sensor adjustm. → ZeroVerification → Recommendation: (6000)
Description	Indicates whether an adjustment is recommended. Only recommended if the measured zero point deviates significantly from the current zero point.
User interface	<ul style="list-style-type: none"> ▪ Do not adjust zero point ▪ Adjust zero point
Factory setting	–

Root cause

Navigation	 Expert → Sensor → Sensor adjustm. → ZeroVerification → Root cause (6444)
Description	Shows the diagnostic and remedy.
User interface	<ul style="list-style-type: none"> ▪ Zero point too high. Ensure no-flow. ▪ Zero point is unstable. Ensure no-flow. ▪ Fluctuation high. Avoid 2-phase medium.
Factory setting	–

Abort cause

Navigation	 Expert → Sensor → Sensor adjustm. → ZeroVerification → Abort cause
Description	Indicates why the wizard was aborted.
User interface	<ul style="list-style-type: none"> ▪ Check process conditions! ▪ A technical issue has occurred
Factory setting	–

Zero point measured













Navigation	 Expert → Sensor → Sensor adjustm. → ZeroVerification → ZeroPointMeasur. (5999)
Description	Shows the zero point measured for the adjustment.
User interface	Signed floating-point number
Factory setting	–

Zero point standard deviation

Navigation	 Expert → Sensor → Sensor adjustm. → ZeroVerification → ZeroStdDev (5996)
Description	Shows the standard deviation of the zero point measured.
User interface	Positive floating-point number
Factory setting	–

"Zero adjustment" wizard

Navigation  Expert → Sensor → Sensor adjustm. → Zero adjustment

► Zero adjustment	
Process conditions	→  135
Progress (2808)	→  135
Status (6253)	→  135
Root cause (6444)	→  135
Abort cause	→  136
Root cause (6444)	→  135
Reliability of measured zero point (5982)	→  136
Additional information	→  136
Reliability of measured zero point (5982)	→  136
Zero point measured (5999)	→  136
Zero point standard deviation (5996)	→  137
Select action (5995)	→  137

Process conditions

Navigation	 Expert → Sensor → Sensor adjustm. → Zero adjustment → Process condit.
Description	Ensure process conditions as follows.
Selection	<ul style="list-style-type: none"> ■ Tubes are completely filled ■ Process operational pressure applied ■ No-flow conditions (closed valves) ■ Process and ambient temperatures stable
Factory setting	–



Progress

Navigation	 Expert → Sensor → Sensor adjustm. → Zero adjustment → Progress (2808)
Description	The progress of the process is indicated.
User interface	0 to 100 %

Status

Navigation	 Expert → Sensor → Sensor adjustm. → Zero adjustment → Status (6253)
Description	Shows the status of the process.
User interface	<ul style="list-style-type: none"> ■ Busy ■ Failed ■ Done
Factory setting	–



Root cause

Navigation	  Expert → Sensor → Sensor adjustm. → Zero adjustment → Root cause (6444)
Description	Shows the diagnostic and remedy.
User interface	<ul style="list-style-type: none"> ■ Zero point too high. Ensure no-flow. ■ Zero point is unstable. Ensure no-flow. ■ Fluctuation high. Avoid 2-phase medium.

Abort cause

Navigation	 Expert → Sensor → Sensor adjustm. → Zero adjustment → Abort cause
Description	Indicates why the wizard was aborted.
User interface	<ul style="list-style-type: none"> ■ Check process conditions! ■ A technical issue has occurred
Factory setting	–

Reliability of measured zero point

Navigation	  Expert → Sensor → Sensor adjustm. → Zero adjustment → ZeroReliability (5982)
Description	Indicates the reliability of the zero point measured.
User interface	<ul style="list-style-type: none"> ■ Not done ■ Good ■ Uncertain
Factory setting	–

Additional information

Navigation	 Expert → Sensor → Sensor adjustm. → Zero adjustment → Additional info.
Description	Indicate whether to display additional information.
Selection	<ul style="list-style-type: none"> ■ Hide ■ Show
Factory setting	Hide

Zero point measured

Navigation	 Expert → Sensor → Sensor adjustm. → Zero adjustment → ZeroPointMeasur. (5999)
Description	Shows the zero point measured for the adjustment.
User interface	Signed floating-point number
Factory setting	–

Zero point standard deviation





Navigation	 Expert → Sensor → Sensor adjustm. → Zero adjustment → ZeroStdDev (5996)
Description	Shows the standard deviation of the zero point measured.
User interface	Positive floating-point number
Factory setting	0

Select action

Navigation	 Expert → Sensor → Sensor adjustm. → Zero adjustment → Select action (5995)
Description	Select the zero point value to apply.
Selection	<ul style="list-style-type: none"> ▪ Keep current zero point ▪ Apply zero point measured ▪ Apply factory zero point *
Factory setting	Keep current zero point

3.2.8 "Calibration" submenu

Navigation   Expert → Sensor → Calibration

► Calibration	
Calibration factor (6025)	→  138
Zero point (6195)	→  138
Nominal diameter (2807)	→  138
CO to 5 (6022)	→  138

* Visibility depends on order options or device settings

Calibration factor



Navigation	 Expert → Sensor → Calibration → Cal. factor (6025)
Description	Displays the current calibration factor for the sensor.
User interface	Signed floating-point number
Factory setting	Depends on nominal diameter and calibration.

Zero point



Navigation	 Expert → Sensor → Calibration → Zero point (6195)
Description	Use this function to enter the zero point correction value for the sensor.
User entry	Signed floating-point number
Factory setting	Depends on nominal diameter and calibration.



Nominal diameter

Navigation	 Expert → Sensor → Calibration → Nominal diameter (2807)
Description	Displays the nominal diameter of the sensor.
User interface	DNxx / x"
Factory setting	Depends on the size of the sensor
Additional information	<i>Description</i>  The value is also specified on the sensor nameplate.

C0 to 5



















Navigation	 Expert → Sensor → Calibration → C0 to 5 (6022)
Description	Displays the current density coefficients C0 to 5 of the sensor.
User interface	Signed floating-point number
Factory setting	Depends on nominal diameter and calibration.

3.2.9 "Testpoints" submenu







 The **Testpoints** submenu (→  139) is used to test the measuring device or the application.

Navigation   Diagnostics → Testpoints





Navigation   Expert → Sensor → Testpoints

▶ Testpoints	
Raw value mass flow	→  140
Oscillation frequency 0 to 1	→  140
Frequency fluctuation 0 to 1	→  140
Oscillation amplitude 0 to 1	→  141
Oscillation damping 0 to 1	→  141
Oscillation damping fluctuation 0 to 1	→  142
Signal asymmetry 0	→  142
Torsion signal asymmetry	→  143
Sensor electronics temperature (ISEM)	→  143
Carrier pipe temperature	→  143
Casing pipe temperature	→  144
Exciter current 0 to 1	→  144
Test point 0	→  144
Test point 1	→  145
Temperature difference measuring tube	→  145
Temperat. difference meas. tube-carrier	→  145
Sensor index coil asymmetry	→  145
Sensor index coil asymmetry reliability	→  146





Raw value mass flow

Navigation	  Diagnostics → Testpoints → Raw mass flow (6140)   Expert → Sensor → Testpoints → Raw mass flow (6140)
Description	Shows the current measured raw value of the mass flow.
User interface	Signed floating-point number
Additional information	<p><i>Description</i></p> <p>Displays the mass flow value before offset and factor correction, damping, low flow cut off and monitoring of a partially filled pipe. This value can be used to check the current zero point; similar to the zero point verification function.</p> <p><i>Dependency</i></p> <p> The unit is taken from the Mass flow unit parameter (→  90)</p>





Oscillation frequency 0 to 1

Navigation	  Diagnostics → Testpoints → Osc. freq. 0 to 1 (6067)   Expert → Sensor → Testpoints → Osc. freq. 0 to 1 (6067)
Prerequisite	<ul style="list-style-type: none"> ▪ Oscillation frequency 0 is available for all Promass sensors. ▪ Oscillation frequency 1 is only available for the Promass I and Promass Q sensors.
Description	Shows the current oscillation frequency of the measuring tubes. The frequency depends on the medium density.
User interface	Positive floating point number





Frequency fluctuation 0 to 1



Navigation	  Diagnostics → Testpoints → Freq. fluct. 0 to 1 (6175)   Expert → Sensor → Testpoints → Freq. fluct. 0 to 1 (6175)
Prerequisite	<p>Order code for "Application package", option EB "Heartbeat Verification + Monitoring" available:</p> <ul style="list-style-type: none"> ▪ Frequency fluctuation 0 is available for all Promass sensors. ▪ Frequency fluctuation 1 is only available for the Promass I and Promass Q sensors.
Description	Shows the current fluctuation of the oscillation frequency.
User interface	Signed floating-point number

Oscillation amplitude 0 to 1





Navigation	  Diagnostics → Testpoints → Osc. ampl. 0 to 1 (6006)   Expert → Sensor → Testpoints → Osc. ampl. 0 to 1 (6006)
Prerequisite	<p>Order code for "Application package", option EB "Heartbeat Verification + Monitoring" available:</p> <ul style="list-style-type: none"> ▪ Oscillation amplitude 0 is available for all Promass sensors. ▪ Oscillation amplitude 1 is only available for the Promass I and Promass Q sensors.
Description	Use this function to display the relative oscillation amplitude of the sensor in relation to the optimum value.
User interface	Signed floating-point number
Additional information	<p><i>Description</i></p> <p>This value is 100 % under optimum conditions. The value can fall in the case of complex media (two-phase, high viscosity or high gas velocity).</p> <p><i>Limit values</i></p> <p>5 %</p> <p> If the displayed value is outside the limit value, the measuring device displays the following diagnostic messages:</p> <ul style="list-style-type: none"> ▪ △S913 Medium unsuitable diagnostic message, associated service ID 205 Osc Amp Limit Explanation: The measured oscillation amplitude has dropped below the xMin limit value. ▪ △S912 Medium inhomogeneous diagnostic message, associated service ID 196 Fluid Inhomogeneous Amp <ul style="list-style-type: none"> ▪ Explanation: The fluctuation (standard deviation) of the amplitude is too high. ▪ Possible cause: Air or suspended solids in the medium (multiphase)

Oscillation damping 0 to 1





Navigation	  Diagnostics → Testpoints → Osc. damping 0 to 1 (6038)   Expert → Sensor → Testpoints → Osc. damping 0 to 1 (6038)
Prerequisite	<ul style="list-style-type: none"> ▪ Oscillation damping 0 is available for all Promass sensors. ▪ Oscillation damping 1 is only available for the Promass I and Promass Q sensors.
Description	Displays the current oscillation damping.
User interface	Positive floating-point number

Additional information	<p><i>Description</i></p> <p>Oscillation damping is an indicator of the sensor's current need for excitation power.</p> <p><i>Limit values</i></p> <p>The damping depends on the transmitter type and model and changes with the type of medium (differences between models: approx. $\pm 30\%$). The minimum value is reached when the sensor is empty. The value can reach several 1 000 in the case of viscous media, and even several 10 000 in the case of multi-phase media. In such cases, the relative oscillation amplitude should also be used for diagnosis.</p> <p> If the displayed value is outside the limit value, the measuring device displays the following diagnostic message:  S862 Partly filled pipe diagnostic message, associated service ID 146 Density Monitoring</p>
-------------------------------	--





Oscillation damping fluctuation 0 to 1

Navigation	<p>  Diagnostics → Testpoints → Osc.damp.fluct0 to 1 (6172)</p> <p>  Expert → Sensor → Testpoints → Osc.damp.fluct0 to 1 (6172)</p>
Prerequisite	<p>Order code for "Application package", option EB "Heartbeat Verification + Monitoring" available:</p> <ul style="list-style-type: none"> ▪ Tube damping fluctuation 0 is available for all Promass sensors. ▪ Tube damping fluctuation 1 is only available for the Promass I and Promass Q sensors.
Description	Shows the current fluctuation of the oscillation damping.
User interface	Signed floating-point number







Signal asymmetry 0

Navigation	<p>  Diagnostics → Testpoints → Signal asymm. 0 (6013)</p> <p>  Expert → Sensor → Testpoints → Signal asymm. 0 (6013)</p>
Description	Displays the relative difference between the oscillation amplitude measured at the inlet and outlet of the sensor.
User interface	Signed floating-point number
Additional information	<p><i>Description</i></p> <p>The measured value is the result of production tolerances of the sensor coils and should remain constant over the life time of a sensor.</p>





Torsion signal asymmetry

Navigation	  Diagnostics → Testpoints → Tors.sig.asymm. (6289)   Expert → Sensor → Testpoints → Tors.sig.asymm. (6289)
Prerequisite	This parameter is only available: with the order code for "Application package", option EB "Heartbeat Verification + Monitoring" and the Promass I or Promass Q sensor.
Description	Shows the relative difference of the signal amplitudes of the inlet sensor and outlet sensor of the second oscillation mode.
User interface	Signed floating-point number

Sensor electronics temperature (ISEM)

Navigation	  Diagnostics → Testpoints → Sensor elec.temp (6053)   Expert → Sensor → Testpoints → Sensor elec.temp (6053)
Description	Displays the current temperature inside the main electronics.
User interface	Signed floating-point number
Additional information	<p>NOTE! Stay within the specified ambient temperature range.</p> <p><i>Dependency</i></p> <p> The unit is taken from the Temperature unit parameter (→  98)</p>

Carrier pipe temperature

Navigation	  Diagnostics → Testpoints → Carr. pipe temp. (6027)   Expert → Sensor → Testpoints → Carr. pipe temp. (6027)
Prerequisite	<ul style="list-style-type: none"> ■ Order code for "Application package", option EB "Heartbeat Verification + Monitoring" ■ If the carrier tube temperature is provided: <ul style="list-style-type: none"> ■ Promass A ■ Promass F ■ Promass H ■ Promass I ■ Promass O ■ Promass P ■ Promass Q ■ Promass S ■ Promass X
Description	Use this function to display the current temperature of the measuring tube housing. Displays the 2nd measured temperature for compensation.

User interface Signed floating-point number

Additional information *Limit values*

In thermally insulated sensors, the carrier tube temperature can reach the temperature of the medium.

Dependency



The unit is taken from the **Temperature unit** parameter (0557)

Casing pipe temperature

Navigation Diagnostics → Testpoints → CasingPipeTemp. (6411)

Expert → Sensor → Testpoints → CasingPipeTemp. (6411)

Prerequisite This parameter is only available: with the order code for "Application package", option EB "Heartbeat Verification + Monitoring" and the Promass I sensor

Description Displays the temperature of the casing pipe.

User interface Signed floating-point number

Exciter current 0 to 1

Navigation Diagnostics → Testpoints → Exc. current 0 to 1 (6055)

Expert → Sensor → Testpoints → Exc. current 0 to 1 (6055)

Prerequisite

- Exciter current 0 is available for all Promass sensors.
- Exciter current 1 is only available for the Promass I and Promass Q sensors.

Description Rms value of the exciter current.

User interface Signed floating-point number

Additional information **NOTE!**

The maximum available excitation current has been reached when the oscillation amplitude shown is less than 100 %.

Test point 0





Navigation Diagnostics → Testpoints → Test point 0 (6425)

Expert → Sensor → Testpoints → Test point 0 (6425)

Description Shows the value for the selected test point. Can only be configured by Endress+Hauser.

Factory setting 0





Test point 1

Navigation   Diagnostics → Testpoints → Test point 1 (6426)
  Expert → Sensor → Testpoints → Test point 1 (6426)

Description Shows the value for the selected test point. Can only be configured by Endress+Hauser.

Factory setting 0

Temperature difference measuring tube





Navigation   Diagnostics → Testpoints → TempDiffMeasTube (6344)
  Expert → Sensor → Testpoints → TempDiffMeasTube (6344)

Prerequisite This parameter is only available for the Promass Q sensor.

Description Shows the temperature difference between the outlet and the inlet of the measuring tube.

User interface Signed floating-point number

Temperat. difference meas. tube-carrier





Navigation   Diagnostics → Testpoints → TempDiffTubeCarr
  Expert → Sensor → Testpoints → TempDiffTubeCarr

Description Shows the temperature difference between the measuring tube and the carrier pipe.

User interface Signed floating-point number

Factory setting 0 K

Sensor index coil asymmetry



Navigation   Diagnostics → Testpoints → SensIndCoilAsym. (5951)
  Expert → Sensor → Testpoints → SensIndCoilAsym. (5951)

Description Shows the sensor index coil asymmetry (SICA) currently measured.

User interface Signed floating-point number





Factory setting 0 %

Sensor index coil asymmetry reliability

Navigation	 Diagnostics → Testpoints → SensIndCoilAReli (5952)  Expert → Sensor → Testpoints → SensIndCoilAReli (5952)
Description	Indicates the reliability of the sensor index coil asymmetry value (SICA) currently measured.
User interface	<ul style="list-style-type: none"> ■ Good ■ Uncertain ■ Bad
Factory setting	Bad

3.3 "I/O configuration" submenu

Navigation  Expert → I/O config.

▶ I/O configuration	
I/O module 1 to n terminal numbers (3902-1 to n)	→  146
I/O module 1 to n information (3906-1 to n)	→  147
I/O module 1 to n type (3901-1 to n)	→  147
Apply I/O configuration (3907)	→  148
I/O alteration code (2762)	→  148

I/O module 1 to n terminal numbers

Navigation	 Expert → I/O config. → I/O 1 to n terminals (3902-1 to n)
Description	Displays the terminal numbers used by the I/O module.

User interface	<ul style="list-style-type: none"> ■ Not used ■ 26-27 (I/O 1) ■ 24-25 (I/O 2) ■ 22-23 (I/O 3)
-----------------------	---

I/O module 1 to n information

Navigation	 Expert → I/O config. → I/O 1 to n info (3906-1 to n)
Description	Displays information about the plugged in I/O module.
User interface	<ul style="list-style-type: none"> ■ Not plugged ■ Invalid ■ Not configurable ■ Configurable ■ HART
Additional information	<p><i>"Not plugged" option</i> The I/O module is not plugged in.</p> <p><i>"Invalid" option</i> The I/O module is not plugged correctly.</p> <p><i>"Not configurable" option</i> The I/O module is not configurable.</p> <p><i>"Configurable" option</i> The I/O module is configurable.</p> <p><i>"Fieldbus" option</i> The I/O module is configured for HART.</p>

I/O module 1 to n type

Navigation	 Expert → I/O config. → I/O 1 to n type (3901-1 to n)
Prerequisite	<p>For the following order code:</p> <ul style="list-style-type: none"> ■ "Output; input 2", option D "Configurable I/O initial setting off" ■ "Output; input 3", option D "Configurable I/O initial setting off"
Description	Use this function to select the I/O module type for the configuration of the I/O module.
Selection	<ul style="list-style-type: none"> ■ Off ■ Current output * ■ Current input * ■ Status input *

* Visibility depends on order options or device settings

- Pulse/frequency/switch output *
- Double pulse output *
- Relay output *

Factory setting Off

Apply I/O configuration

Navigation   Expert → I/O config. → Apply I/O config (3907)

Description Use this function to activate the newly configured I/O module type.

Selection

- No
- Yes

Factory setting No

I/O alteration code

Navigation   Expert → I/O config. → I/O alterat.code (2762)

Description Use this function to enter the ordered activation code to activate the I/O configuration change.

User entry Positive integer

Factory setting 0

Additional information *Description*
The I/O configuration is changed in the **I/O module type** parameter (→  147).

3.4 "Input" submenu

Navigation   Expert → Input

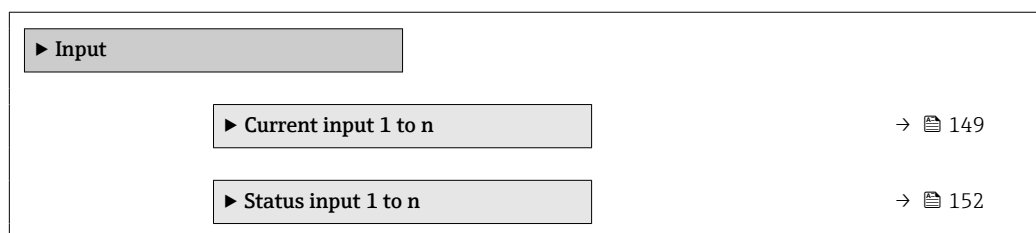







* Visibility depends on order options or device settings

3.4.1 "Current input 1 to n" submenu

Navigation  Expert → Input → Current input 1 to n

▶ **Current input 1 to n**

Terminal number (1611-1 to n)	→  149
Signal mode (1610-1 to n)	→  149
Current span (1605-1 to n)	→  150
0/4 mA value (1606-1 to n)	→  150
20 mA value (1607-1 to n)	→  151
Failure mode (1601-1 to n)	→  151
Failure value (1602-1 to n)	→  151

Terminal number

Navigation  Expert → Input → Current input 1 to n → Terminal no. (1611-1 to n)

Description Displays the terminal numbers used by the current input module.

User interface

- Not used
- 24-25 (I/O 2)
- 22-23 (I/O 3)

Additional information *"Not used" option*
 The current input module does not use any terminal numbers.

Signal mode

Navigation  Expert → Input → Current input 1 to n → Signal mode (1610-1 to n)

Prerequisite The measuring device is **not** approved for use in the hazardous area with type of protection Ex-i.

Description Use this function to select the signal mode for the current input.



Selection

- Passive
- Active *

* Visibility depends on order options or device settings

Factory setting Active

Current span

Navigation   Expert → Input → Current input 1 to n → Current span (1605-1 to n)

Description Use this function to select the current range for the process value output and the upper and lower level for signal on alarm.

Selection

- 4...20 mA (4... 20.5 mA)
- 4...20 mA NE (3.8...20.5 mA)
- 4...20 mA US (3.9...20.8 mA)
- 0...20 mA (0... 20.5 mA)



Factory setting Country-specific:

- 4...20 mA NE (3.8...20.5 mA)
- 4...20 mA US (3.9...20.8 mA)

Additional information *Examples*

 Sample values for the current range: **Current span** parameter (→  157)

0/4 mA value

Navigation   Expert → Input → Current input 1 to n → 0/4 mA value (1606-1 to n)



Description Use this function to enter a value for the 4 mA current.

User entry Signed floating-point number

Factory setting 0

Additional information *Current input behavior*

The current input behaves differently depending on the settings configured in the following parameters:

- Current span (→  150)
- Failure mode (→  151)





Configuration examples

 Pay attention to the configuration examples for **4 mA value** parameter (→  159).

20 mA value 	
Navigation	  Expert → Input → Current input 1 to n → 20 mA value (1607-1 to n)
Description	Use this function to enter a value for the 20 mA current.
User entry	Signed floating-point number
Factory setting	Depends on country and nominal diameter
Additional information	<p><i>Configuration examples</i></p> <p> Pay attention to the configuration examples for 4 mA value parameter (→  159).</p>
Failure mode 	
Navigation	  Expert → Input → Current input 1 to n → Failure mode (1601-1 to n)
Description	Use this function to select the input behavior when measuring a current outside the configured Current span parameter (→  150).
Selection	<ul style="list-style-type: none"> ▪ Alarm ▪ Last valid value ▪ Defined value
Factory setting	Alarm
Additional information	<p><i>Options</i></p> <ul style="list-style-type: none"> ▪ Alarm An error message is set. ▪ Last valid value The last valid measured value is used. ▪ Defined value A user-defined measured value is used (Failure value parameter (→  151)).
Failure value 	
Navigation	  Expert → Input → Current input 1 to n → Failure value (1602-1 to n)
Prerequisite	In the Failure mode parameter (→  151), the Defined value option is selected.
Description	Use this function to enter the value that the device uses if it does not receive an input signal from the external device, or if the input signal is invalid.
User entry	Signed floating-point number
Factory setting	0

3.4.2 "Status input 1 to n" submenu

Navigation  Expert → Input → Status input 1 to n

▶ Status input 1 to n	
Terminal number (1358-1 to n)	→  152
Assign status input (1352-1 to n)	→  152
Value status input (1353-1 to n)	→  153
Active level (1351-1 to n)	→  153
Response time status input (1354-1 to n)	→  154

Terminal number

Navigation  Expert → Input → Status input 1 to n → Terminal no. (1358-1 to n)

Description Displays the terminal numbers used by the status input module.

User interface

- Not used
- 24-25 (I/O 2)
- 22-23 (I/O 3)

Additional information *"Not used" option*
The status input module does not use any terminal numbers.

Assign status input

Navigation  Expert → Input → Status input 1 to n → Assign stat.inp. (1352-1 to n)

Description Use this function to select the function for the status input.

Selection

- Off
- Reset totalizer 1
- Reset totalizer 2
- Reset totalizer 3
- Reset all totalizers
- Flow override
- Zero adjustment
- Reset weighted averages *
- Reset weighted averages + totalizer 3 *

* Visibility depends on order options or device settings



Factory setting Off

Additional information *Custody transfer mode*

 Only available for Promass F, O, Q and X.



NOTE!

Before enabling the measuring device for custody transfer mode, make sure that the **Off** option is selected in the Assign status input.

 For detailed information on custody transfer mode, see the Special Documentation for the device →  7



Additional information *Selection*

- Off
The status input is switched off.
- Reset totalizer 1...3
The individual totalizers are reset.
- Reset all totalizers
All totalizers are reset.
- Flow override
The Flow override (→  102) is activated.

 Note on the Flow override (→  102):

- The Flow override (→  102) is enabled as long as the level is at the status input (continuous signal).
- All other assignments react to a change in level (pulse) at the status input.

Value status input



Navigation   Expert → Input → Status input 1 to n → Val.stat.inp. (1353–1 to n)

Description Displays the current input signal level.

User interface

- High
- Low

Active level

Navigation   Expert → Input → Status input 1 to n → Active level (1351–1 to n)



Description Use this function to determine the input signal level at which the assigned function is activated.

Selection

- High
- Low





Factory setting High

Response time status input

Navigation	  Expert → Input → Status input 1 to n → Response time (1354-1 to n)
Description	Use this function to enter the minimum time period for which the input signal level must be present before the selected function is activated.
User entry	5 to 200 ms
Factory setting	50 ms







3.5 "Output" submenu







Navigation   Expert → Output

▶ Output	
▶ Current output 1 to n	→  154
▶ Pulse/frequency/switch output 1 to n	→  169
▶ Relay output 1 to n	→  190
▶ Double pulse output	→  197



3.5.1 "Current output 1 to n" submenu

Navigation   Expert → Output → Curr.output 1 to n



▶ Current output 1 to n	
Terminal number	→  155
Signal mode	→  155
Process variable current output	→  156
Current range output	→  157
Fixed current	→  158
Lower range value output	→  159
Upper range value output	→  161

Measuring mode current output	→  161
Damping current output	→  166
Failure behavior current output	→  167
Failure current	→  168
Output current	→  168
Measured current	→  169

Terminal number

Navigation	  Expert → Output → Curr.output 1 to n → Terminal no. (0379-1 to n)
Description	Displays the terminal numbers used by the current output module.
User interface	<ul style="list-style-type: none"> ■ Not used ■ 26-27 (I/O 1) ■ 24-25 (I/O 2) ■ 22-23 (I/O 3)
Additional information	<p><i>"Not used" option</i></p> <p>The current output module does not use any terminal numbers.</p>

Signal mode

Navigation	  Expert → Output → Curr.output 1 to n → Signal mode (0377-1 to n)
Description	Use this function to select the signal mode for the current output.
Selection	<ul style="list-style-type: none"> ■ Active * ■ Passive *
Factory setting	Active

* Visibility depends on order options or device settings

Process variable current output
**Navigation**

Expert → Output → Curr.output 1 to n → Proc.var. outp (0359-1 to n)

Description

Use this function to select a process variable for the current output.

Detailed description of the options **Oscillation frequency**, **Oscillation amplitude**, **Oscillation damping** and **Signal asymmetry: Value 1 display** parameter (→ 19)

Selection

- Off *
- Mass flow
- Volume flow
- Corrected volume flow *
- Density
- Reference density *
- Temperature
- Pressure
- GSV flow *
- GSV flow alternative *
- NSV flow *
- NSV flow alternative *
- S&W volume flow *
- Reference density alternative *
- Water cut *
- Oil density *
- Water density *
- Oil mass flow *
- Water mass flow *
- Oil volume flow *
- Water volume flow *
- Oil corrected volume flow *
- Water corrected volume flow *
- Target mass flow *
- Carrier mass flow *
- Concentration *
- Dynamic viscosity *
- Kinematic viscosity *
- Temp. compensated dynamic viscosity *
- Temp. compensated kinematic viscosity *
- GSV flow *
- GSV flow alternative *
- NSV flow *
- NSV flow alternative *
- S&W volume flow *
- Reference density alternative *
- Water cut *
- Oil density *
- Water density *
- Oil mass flow *
- Water mass flow *
- Oil volume flow *
- Water volume flow *
- Oil corrected volume flow *
- Water corrected volume flow *
- Target volume flow *
- Carrier volume flow *

* Visibility depends on order options or device settings

- Target corrected volume flow *
- Carrier corrected volume flow *
- Application specific output 0 *
- Application specific output 1 *
- Inhomogeneous medium index
- Suspended bubbles index *
- Raw value mass flow
- Exciter current 0
- Oscillation damping 0
- Oscillation damping fluctuation 0 *
- Oscillation frequency 0
- Frequency fluctuation 0 *
- Signal asymmetry
- Torsion signal asymmetry *
- Carrier pipe temperature
- Oscillation frequency 1 *
- Frequency fluctuation 0 *
- Oscillation amplitude 0 *
- Oscillation amplitude 1 *
- Frequency fluctuation 1 *
- Oscillation damping 1 *
- Oscillation damping fluctuation 0 *
- Oscillation damping fluctuation 1 *
- Exciter current 1 *
- HBSI *
- Electronics temperature
- Sensor index coil asymmetry
- Test point 0
- Test point 1

Factory setting

Mass flow

Current range output**Navigation**

Expert → Output → Curr.output 1 to n → Curr.range out (0353-1 to n)

Description

Select current range for process value output and upper/lower level for alarm signal.

Selection

- 4...20 mA NE (3.8...20.5 mA)
- 4...20 mA US (3.9...20.8 mA)
- 4...20 mA (4... 20.5 mA)
- 0...20 mA (0... 20.5 mA)
- Fixed value

Factory setting

Depends on country:

- 4...20 mA NE (3.8...20.5 mA)
- 4...20 mA US (3.9...20.8 mA)

* Visibility depends on order options or device settings

Additional information*Description*

- i** In the event of a device alarm, the current output adopts the value specified in the **Failure mode** parameter (→ [167](#)).
- If the measured value is outside the measuring range, the **△S441 Current output 1 to n** diagnostic message is displayed.
- The measuring range is specified via the **Lower range value output** parameter (→ [159](#)) and **Upper range value output** parameter (→ [161](#)).

"Fixed current" option

- This option is used for a HART Multidrop network.
- It can only be used for the 4...20 mA HART current output (current output 1).
- The current value is set via the **Fixed current** parameter (→ [158](#)).

Example

Shows the relationship between the current range for the output of the process value and the two signal on alarm levels:

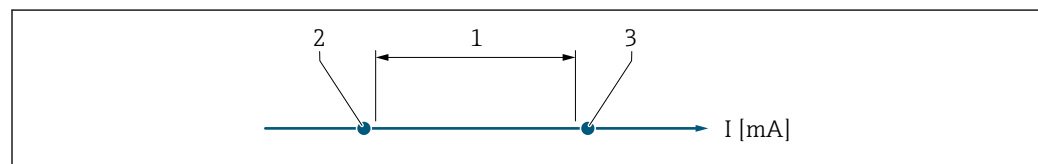

A0034351

- 1 Current range for process value
- 2 Lower level for signal on alarm
- 3 Upper level for signal on alarm

Selection

Selection	1	2	3
4...20 mA NE (3.8...20.5 mA)	3.8 to 20.5 mA	< 3.6 mA	> 21.95 mA
4...20 mA US (3.9...20.8 mA)	3.9 to 20.8 mA US	< 3.6 mA	> 21.95 mA
4...20 mA (4... 20.5 mA)	4 to 20.5 mA	< 3.6 mA	> 21.95 mA
0...20 mA (0... 20.5 mA)	0 to 20.5 mA	0 mA	> 21.95 mA

- i** If the flow exceeds or falls below the upper or lower signal on alarm level, the **△S441 Current output 1 to n** diagnostic message is displayed.

Fixed current**Navigation**

Expert → Output → Curr.output 1 to n → Fixed current (0365-1 to n)

Prerequisite

The **Fixed current** option is selected in the **Current span** parameter (→ [157](#)).

Description

Use this function to enter a constant current value for the current output.

User entry

0 to 22.5 mA

Factory setting

22.5 mA

Lower range value output

Navigation	Expert → Output → Curr.output 1 to n → Low.range outp (0367-1 to n)
Prerequisite	<p>One of the following options is selected in the Current span parameter (→ 157):</p> <ul style="list-style-type: none"> ■ 4...20 mA NE (3.8...20.5 mA) ■ 4...20 mA US (3.9...20.8 mA) ■ 4...20 mA (4... 20.5 mA) ■ 0...20 mA (0... 20.5 mA)
Description	Use this function to enter a value for the start of measuring range.
User entry	Signed floating-point number
Factory setting	<p>Depends on country:</p> <ul style="list-style-type: none"> ■ 0 kg/h ■ 0 lb/min
Additional information	<p><i>Description</i></p> <p>Positive and negative values are permitted depending on the process variable assigned in the Assign current output parameter (→ 156). In addition, the value can be greater than or smaller than the value assigned for the 20 mA current in the Upper range value output parameter (→ 161).</p> <p><i>Dependency</i></p> <p> The unit depends on the process variable selected in the Assign current output parameter (→ 156).</p> <p><i>Current output behavior</i></p> <p>The current output behaves differently depending on the settings configured in the following parameters:</p> <ul style="list-style-type: none"> ■ Current span (→ 157) ■ Failure mode (→ 167) <p><i>Configuration examples</i></p> <p>Some examples of parameter settings and their effect on the current output are given in the following section.</p> <p>Configuration example A</p> <p>Measurement mode with Forward flow option</p> <ul style="list-style-type: none"> ■ Lower range value output parameter (→ 159) = not equal to zero flow (e.g. -250 m³/h) ■ Upper range value output parameter (→ 161) = not equal to zero flow (e.g. +750 m³/h) ■ Calculated current value = 8 mA at zero flow

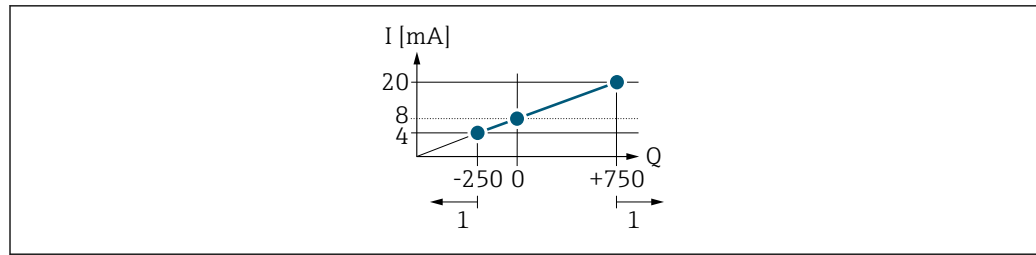

A0013757

- Q* Flow
I Current
 1 Measuring range is exceeded or undershot

The operational range of the measuring device is defined by the values entered for the **Lower range value output** parameter (→ ☰ 159) and **Upper range value output** parameter (→ ☰ 161). If the effective flow exceeds or falls below this operational range, the **△S441 Current output 1 to n** diagnostic message is output.

Configuration example B

Measurement mode with **Forward/Reverse flow** option

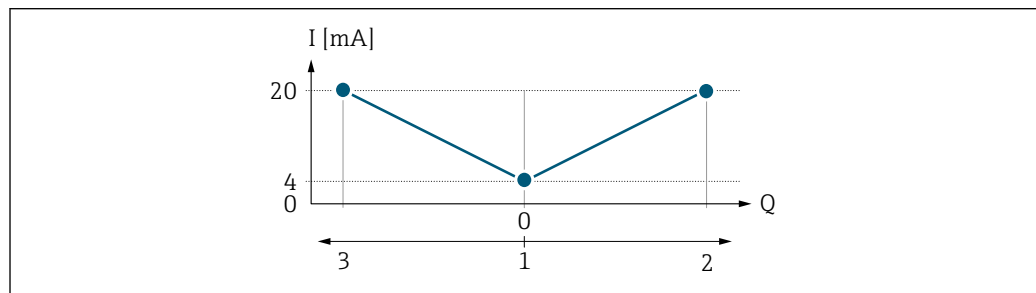

A0013758

- I* Current
Q Flow
 1 Start of measuring range output (0/4 mA)
 2 Forward flow
 3 Reverse flow

The current output signal is independent of the direction of flow (absolute amount of the measured variable). The values for the **Lower range value output** parameter (→ ☰ 159) and **Upper range value output** parameter (→ ☰ 161) must have the same algebraic sign. The value for the **Upper range value output** parameter (→ ☰ 161) (e.g. reverse flow) corresponds to the mirrored value for the **Upper range value output** parameter (→ ☰ 161) (e.g. forward flow).

Configuration example C

Measurement mode with **Reverse flow compensation** option

If flow is characterized by severe fluctuations (e.g. when using reciprocating pumps), flow components outside the measuring range are buffered, balanced and output after a maximum delay of 60 s → ☰ 161.

Upper range value output

Navigation	Expert → Output → Curr.output 1 to n → Upp.range outp (0372-1 to n)
Prerequisite	One of the following options is selected in the Current span parameter (→ 157): <ul style="list-style-type: none"> ■ 4...20 mA NE (3.8...20.5 mA) ■ 4...20 mA US (3.9...20.8 mA) ■ 4...20 mA (4... 20.5 mA) ■ 0...20 mA (0... 20.5 mA)
Description	Use this function to enter a value for the end of measuring range.
User entry	Signed floating-point number
Factory setting	Depends on country and nominal diameter → 333
Additional information	<p><i>Description</i></p> <p>Positive and negative values are permitted depending on the process variable assigned in the Assign current output parameter (→ 156). In addition, the value can be greater than or smaller than the value assigned for the 0/4 mA current in the Lower range value output parameter (→ 159).</p> <p><i>Dependency</i></p> <p> The unit depends on the process variable selected in the Assign current output parameter (→ 156).</p> <p><i>Example</i></p> <ul style="list-style-type: none"> ■ Value assigned to 0/4 mA = -250 m³/h ■ Value assigned to 20 mA = +750 m³/h ■ Calculated current value = 8 mA (at zero flow) <p>If the Forward/Reverse flow option is selected in the Measuring mode parameter (→ 161), different algebraic signs cannot be entered for the values for the Lower range value output parameter (→ 159) and Upper range value output parameter (→ 161). The △S441 Current output 1 to n diagnostic message is displayed.</p> <p><i>Configuration examples</i></p> <p> Pay attention to the configuration examples for the Lower range value output parameter (→ 159).</p>

Measuring mode current output

Navigation	Expert → Output → Curr.output 1 to n → Meas.mode outp (0351-1 to n)
Prerequisite	One of the following options is selected in the Assign current output parameter (→ 156): <ul style="list-style-type: none"> ■ Mass flow ■ Volume flow ■ Corrected volume flow ■ Target mass flow*

* Visibility depends on order options or device settings

- Carrier mass flow *
- Density
- Reference density
- Concentration *
- Dynamic viscosity *
- Kinematic viscosity *
- Temp. compensated dynamic viscosity *
- Temp. compensated kinematic viscosity *
- Temperature
- Carrier pipe temperature *
- Electronics temperature
- Oscillation frequency 0
- Oscillation frequency 1 *
- Oscillation amplitude 0 *
- Oscillation amplitude 1 *
- Frequency fluctuation 0
- Frequency fluctuation 1 *
- Oscillation damping 0
- Oscillation damping 1 *
- Oscillation damping fluctuation 0
- Oscillation damping fluctuation 1 *
- Signal asymmetry
- Exciter current 0
- Exciter current 1 *
- HBSI *

 Detailed description of the options **Oscillation frequency**, **Oscillation amplitude**, **Oscillation damping** and **Signal asymmetry: Value 1 display** parameter (→  19)

One of the following options is selected in the **Current span** parameter (→  157):

- 4...20 mA NE (3.8...20.5 mA)
- 4...20 mA US (3.9...20.8 mA)
- 4...20 mA (4... 20.5 mA)
- 0...20 mA (0... 20.5 mA)

Description Use this function to select the measuring mode for the current output.

Selection



- Forward flow
- Forward/Reverse flow *
- Reverse flow compensation

Factory setting Forward flow

Additional information *Description*

 The process variable that is assigned to the current output via the **Assign current output** parameter (→  156) is displayed below the parameter.

"Forward flow" option

The current output signal is proportional to the process variable assigned. The measuring range is defined by the values that are assigned to the **Lower range value output** parameter (→  159) and the **Upper range value output** parameter (→  161).

* Visibility depends on order options or device settings

The flow components outside the scaled measuring range are taken into account for signal output as follows:

- Both values are defined such that they are not equal to zero flow e.g.:
 - start of measuring range = $-5 \text{ m}^3/\text{h}$
 - end of measuring range = $10 \text{ m}^3/\text{h}$
- If the effective flow exceeds or falls below this measuring range, the **△S441 Current output 1 to n** diagnostic message is output.

"Forward/Reverse flow" option

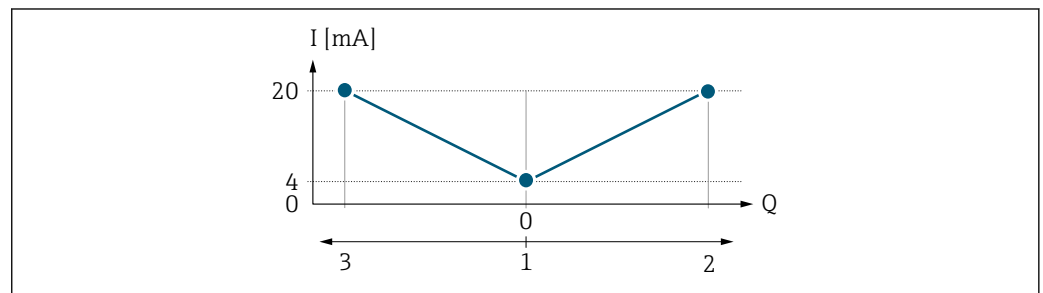

A0013758

- I Current
- Q Flow
- 1 Start of measuring range output (0/4 mA)
- 2 Forward flow
- 3 Reverse flow

- The current output signal is independent of the direction of flow (absolute amount of the measured variable). The values for the **Lower range value output** parameter (→ [☰ 159](#)) and **Upper range value output** parameter (→ [☰ 161](#)) must have the same algebraic sign.
- The value for the **Upper range value output** parameter (→ [☰ 161](#)) (e.g. reverse flow) corresponds to the mirrored value for the **Upper range value output** parameter (→ [☰ 161](#)) (e.g. forward flow).

"Reverse flow compensation" option

The **Reverse flow compensation** option is primarily used to compensate for intermittent backflow that can arise with displacement pumps due to wear or high-viscosity medium. The reverse flow is recorded in a buffer memory and offset against the next forward flow.

If buffering cannot be processed within approx. 60 s, the **△S441 Current output 1 to n** diagnostic message is displayed.

In the event of prolonged and undesired reverse flow, flow values can accumulate in the buffer memory. Due to the configuration of the current output, these values are not factored in, however, i.e. there is no compensation for the reverse flow.

If this option is set, the measuring device does not smoothen the flow signal. The flow signal is not attenuated.

Examples of how the current output behaves

Example 1

Defined measuring range: lower range value and upper range value with the **same** sign

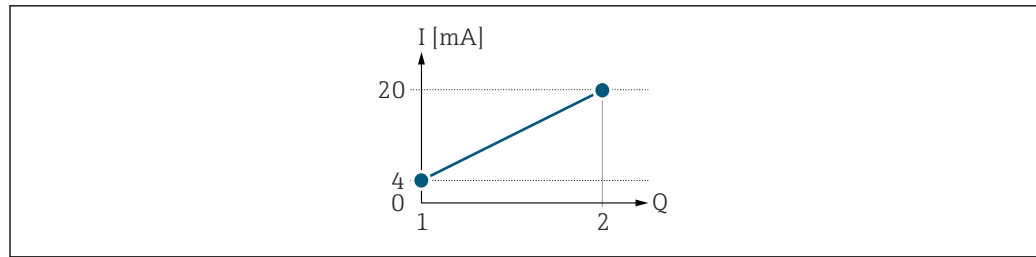

A0028084

4 Measuring range

- I Current
- Q Flow
- 1 Lower range value (Start of measuring range output)
- 2 Upper range value (end of measuring range output)

With the following flow response:

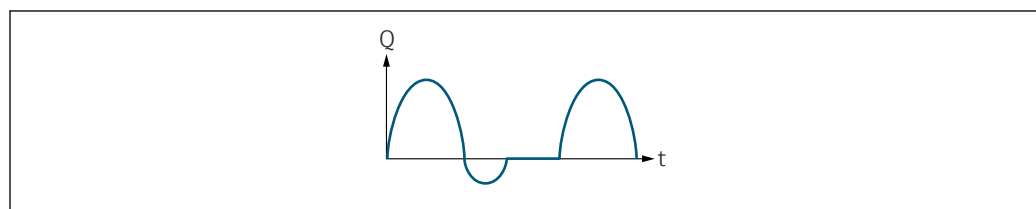

A0028091

5 Flow response

- Q Flow
- t Time

With **Forward flow** option

The current output signal is proportional to the process variable assigned. The flow components outside the scaled measuring range are not taken into account for signal output:.

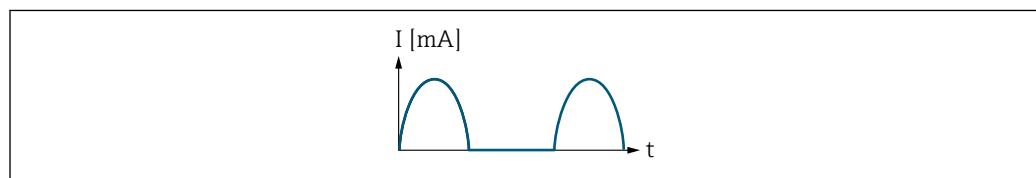

A0028092

- I Current
- t Time

With **Forward/Reverse flow** option

The current output signal is independent of the direction of flow.

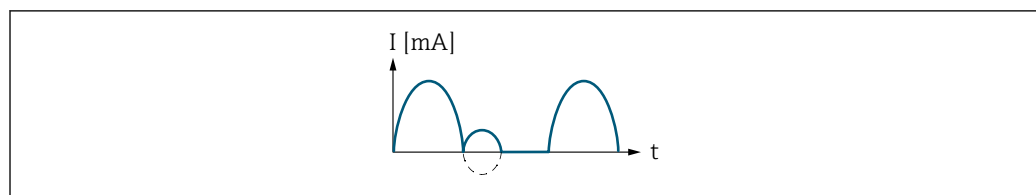

A0028093

- I Current
- t Time

With **Reverse flow compensation** option

Flow components outside the measuring span are buffered, balanced and output after a maximum delay of 60 s.

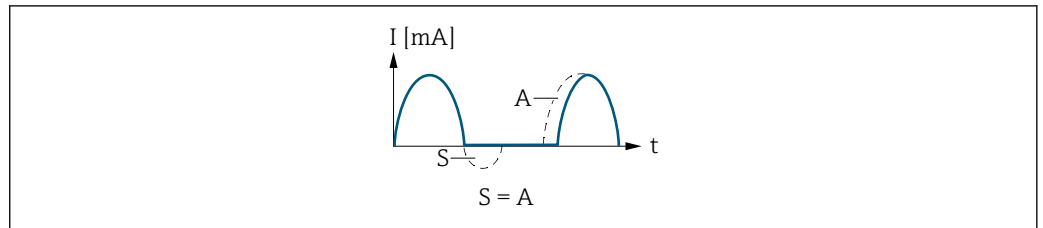

A0028094

- I* Current
- t* Time
- S* Flow components saved
- A* Balancing of saved flow components

Example 2

Defined measuring range: lower range value and upper range value with **different** signs

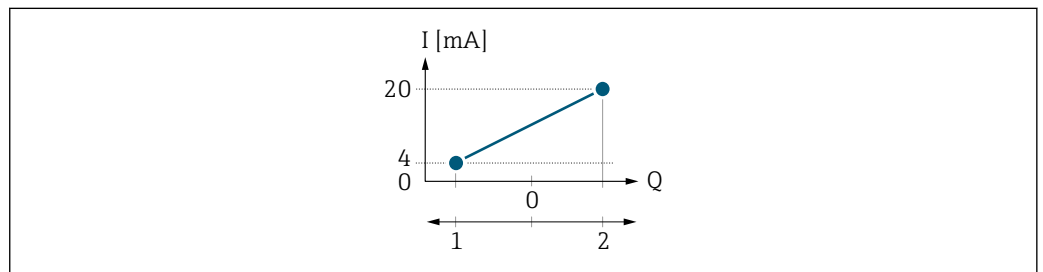

A0028095

6 Measuring range

- I* Current
- Q* Flow
- 1 Lower range value (Start of measuring range output)
- 2 Upper range value (end of measuring range output)

With flow a (–) outside, b (– –) inside the measuring range

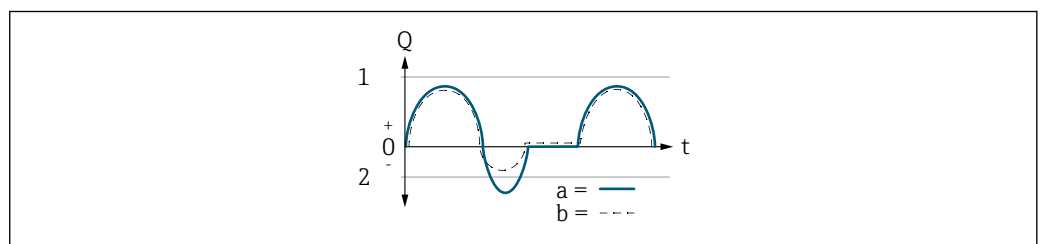

A0028098

- Q* Flow
- t* Time
- 1 Lower range value (Start of measuring range output)
- 2 Upper range value (end of measuring range output)

With **Forward flow** option

- a (–): The flow components outside the scaled measuring range cannot be taken into account for signal output.
The **△S441 Current output 1 to n** diagnostic message is output.
- b (– –): The current output signal is proportional to the process variable assigned.

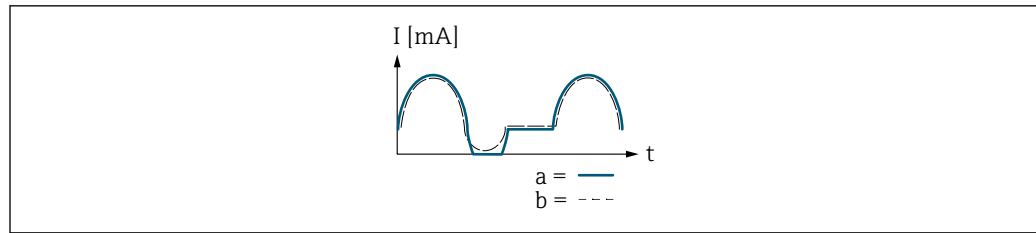

A0028100

I Current
 t Time

With **Forward/Reverse flow** option

This option cannot be selected here since the values for the **Lower range value output** parameter (\rightarrow 159) and **Upper range value output** parameter (\rightarrow 161) have different algebraic signs.

With **Reverse flow compensation** option

Flow components outside the measuring span are buffered, balanced and output after a maximum delay of 60 s.

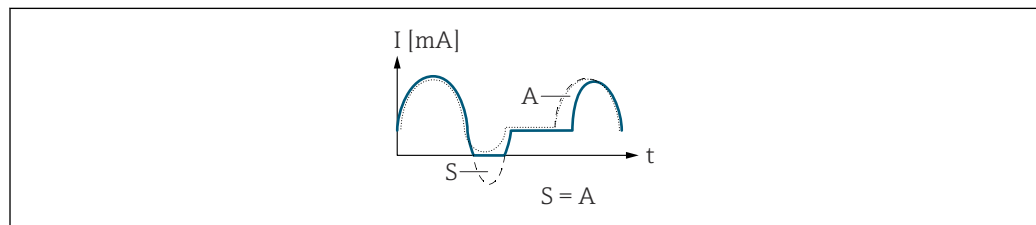

A0028101

I Current
 t Time
 S Flow components saved
 A Balancing of saved flow components

Damping current output



Navigation

Expert \rightarrow Output \rightarrow Curr.output 1 to n \rightarrow Damp.curr.outp (0363-1 to n)

Prerequisite

A process variable is selected in the **Assign current output** parameter (\rightarrow 156) and one of the following options is selected in the **Current span** parameter (\rightarrow 157):

- 4...20 mA NE (3.8...20.5 mA)
- 4...20 mA US (3.9...20.8 mA)
- 4...20 mA (4... 20.5 mA)
- 0...20 mA (0... 20.5 mA)

Description

Use this function to enter a time constant for the reaction time of the current output signal to fluctuations in the measured value caused by process conditions.

User entry





0.0 to 999.9 s

Factory setting

1.0 s

Additional information	<p><i>User entry</i></p> <p>Use this function to enter a time constant (PT1 element ⁶⁾) for current output damping:</p> <ul style="list-style-type: none"> ▪ If a low time constant is entered, the current output reacts particularly quickly to fluctuating measured variables. ▪ On the other hand, the current output reacts more slowly if a high time constant is entered. <p> Damping is switched off if 0 is entered (factory setting).</p>
-------------------------------	--

Failure behavior current output

Navigation	  Expert → Output → Curr.output 1 to n → Fail.behav.out (0364-1 to n)
Prerequisite	<p>A process variable is selected in the Assign current output parameter (→  156) and one of the following options is selected in the Current span parameter (→  157):</p> <ul style="list-style-type: none"> ▪ 4...20 mA NE (3.8...20.5 mA) ▪ 4...20 mA US (3.9...20.8 mA) ▪ 4...20 mA (4... 20.5 mA) ▪ 0...20 mA (0... 20.5 mA)
Description	Use this function to select the value of the current output in the event of a device alarm.
Selection	<ul style="list-style-type: none"> ▪ Min. ▪ Max. ▪ Last valid value ▪ Actual value ▪ Fixed value
Factory setting	Max.



6) proportional transmission behavior with first order delay

Additional information*Description*

 This setting does not affect the failsafe mode of other outputs and totalizers. This is specified in separate parameters.



"Min." option

The current output adopts the value of the lower level for signal on alarm.

 The signal on alarm level is defined via the **Current span** parameter (→  157).

"Max." option

The current output adopts the value of the upper level for signal on alarm.

 The signal on alarm level is defined via the **Current span** parameter (→  157).

"Last valid value" option



The current output adopts the last measured value that was valid before the device alarm occurred.

"Actual value" option



The current output adopts the measured value on the basis of the current flow measurement; the device alarm is ignored.

"Defined value" option

The current output adopts a defined measured value.

 The measured value is defined via the **Failure current** parameter (→  168).

Failure current**Navigation**

  Expert → Output → Curr.output 1 to n → Fail. current (0352-1 to n)

Prerequisite

The **Defined value** option is selected in the **Failure mode** parameter (→  167).

Description

Use this function to enter a fixed value that the current output adopts in the event of a device alarm.



User entry

0 to 22.5 mA

Factory setting

22.5 mA

Output current**Navigation**

  Expert → Output → Curr.output 1 to n → Output curr. (0361-1 to n)

Description

Displays the current value currently calculated for the current output.

User interface

3.59 to 22.5 mA

Measured current

Navigation	🏠🏠 Expert → Output → Curr.output 1 to n → Measur. curr. (0366-1 to n)
Description	Displays the actual measured value of the output current.
User interface	0 to 30 mA

3.5.2 "Pulse/frequency/switch output 1 to n" submenu

Navigation 🏠🏠 Expert → Output → PFS output 1 to n



▶ **Pulse/frequency/switch output 1 to n**

Terminal number (0492-1 to n)	→ 📄 170
Signal mode (0490-1 to n)	→ 📄 171
Operating mode (0469-1 to n)	→ 📄 171
Assign pulse output (0460-1 to n)	→ 📄 173
Pulse scaling (0455-1 to n)	→ 📄 173
Pulse width (0452-1 to n)	→ 📄 174
Measuring mode (0457-1 to n)	→ 📄 175
Failure mode (0480-1 to n)	→ 📄 175
Pulse output 1 to n (0456-1 to n)	→ 📄 176
Assign frequency output (0478-1 to n)	→ 📄 177
Minimum frequency value (0453-1 to n)	→ 📄 178
Maximum frequency value (0454-1 to n)	→ 📄 178
Measuring value at minimum frequency (0476-1 to n)	→ 📄 179
Measuring value at maximum frequency (0475-1 to n)	→ 📄 179

Measuring mode (0479-1 to n)	→  179
Damping output (0477-1 to n)	→  181
Failure mode (0451-1 to n)	→  182
Failure frequency (0474-1 to n)	→  182
Output frequency (0471-1 to n)	→  183
Switch output function (0481-1 to n)	→  183
Assign diagnostic behavior (0482-1 to n)	→  184
Assign limit (0483-1 to n)	→  184
Switch-on value (0466-1 to n)	→  186
Switch-off value (0464-1 to n)	→  187
Assign flow direction check (0484-1 to n)	→  187
Assign status (0485-1 to n)	→  188
Switch-on delay (0467-1 to n)	→  188
Switch-off delay (0465-1 to n)	→  188
Failure mode (0486-1 to n)	→  189
Switch state (0461-1 to n)	→  189
Invert output signal (0470-1 to n)	→  190

Terminal number

Navigation

  Expert → Output → PFS output 1 to n → Terminal no. (0492-1 to n)

Description

Displays the terminal numbers used by the pulse/frequency/switch output module.

User interface

- Not used
- 24-25 (I/O 2)
- 22-23 (I/O 3)

Additional information

"Not used" option

The pulse/frequency/switch output module does not use any terminal numbers.

Signal mode



Navigation	Expert → Output → PFS output 1 to n → Signal mode (0490-1 to n)
Description	Use this function to select the signal mode for the pulse/frequency/switch output.
Selection	<ul style="list-style-type: none"> ■ Passive ■ Active * ■ Passive NE
Factory setting	Passive

Operating mode



Navigation	Expert → Output → PFS output 1 to n → Operating mode (0469-1 to n)
Description	Use this function to select the operating mode of the output as a pulse, frequency or switch output.
Selection	<ul style="list-style-type: none"> ■ Pulse ■ Frequency ■ Switch
Factory setting	Pulse
Additional information	<p><i>"Pulse" option</i></p> <p>Quantity-dependent pulse with configurable pulse width</p> <ul style="list-style-type: none"> ■ Whenever a specific mass, volume, corrected volume, target mass or carrier mass is reached (pulse value), a pulse is output, the duration of which was set previously (pulse width). ■ The pulses are never shorter than the set duration. <p>Example</p> <ul style="list-style-type: none"> ■ Flow rate approx. 100 g/s ■ Pulse value 0.1 g ■ Pulse width 0.05 ms ■ Pulse rate 1 000 Impuls/s

* Visibility depends on order options or device settings

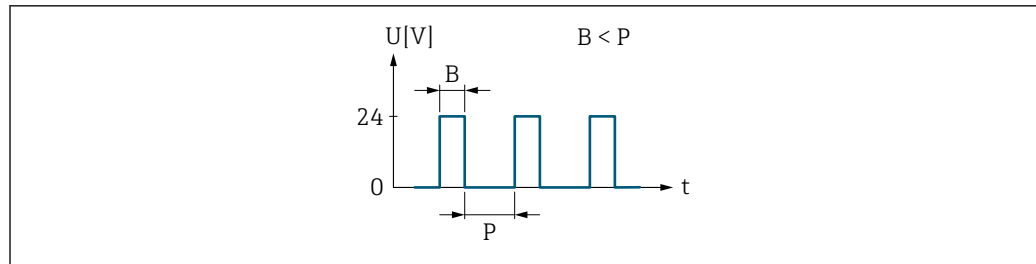

A0026883

7 Quantity-proportional pulse (pulse value) with pulse width to be configured

B Pulse width entered

P Pauses between the individual pulses

"Frequency" option

Flow-proportional frequency output with on/off ratio of 1:1

An output frequency is output that is proportional to the value of a process variable, such as mass flow, volume flow, corrected volume flow, target mass flow, carrier mass flow, density, reference density, concentration, dynamic viscosity, kinematic viscosity, temperature-compensated dynamic viscosity, temperature-compensated kinematic viscosity, temperature, carrier tube temperature, electronics temperature, oscillation frequency, frequency fluctuation, oscillation amplitude, oscillation damping, oscillation damping fluctuation, signal asymmetry or excitation current.

Example

- Flow rate approx. 100 g/s
- Max. frequency 10 kHz
- Flow rate at max. frequency 1000 g/s
- Output frequency approx. 1000 Hz

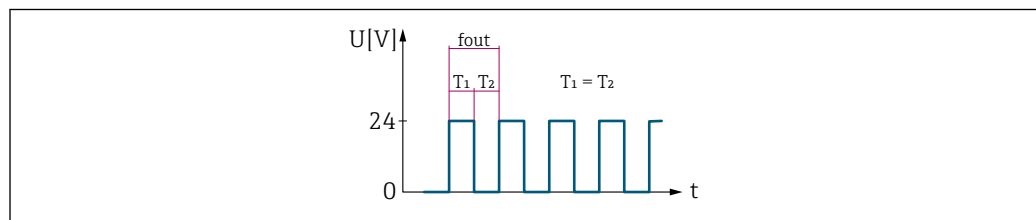

A0026886

8 Flow-proportional frequency output

"Switch" option

Contact for displaying a condition (e.g. alarm or warning if a limit value is reached)

Example

Alarm response without alarm

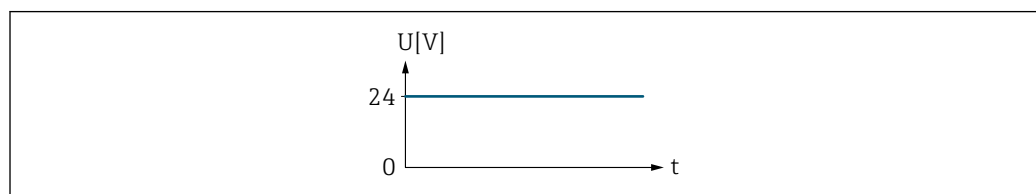

A0026884

9 No alarm, high level

Example

Alarm response in case of alarm

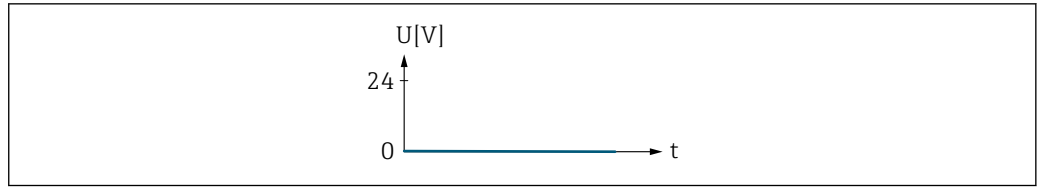

10 Alarm, low level

A0026885

Assign pulse output



Navigation

Expert → Output → PFS output 1 to n → Assign pulse (0460-1 to n)

Prerequisite

The **Pulse** option is selected in the **Operating mode** parameter (→ 171).

Description

Use this function to select the process variable for the pulse output.

Selection

- Off
- Mass flow
- Volume flow
- Corrected volume flow *
- Target mass flow *
- Carrier mass flow *
- Target volume flow *
- Carrier volume flow *
- Target corrected volume flow *
- Carrier corrected volume flow *
- GSV flow *
- GSV flow alternative *
- NSV flow *
- NSV flow alternative *
- S&W volume flow *
- Oil mass flow *
- Water mass flow *
- Oil volume flow *
- Water volume flow *
- Oil corrected volume flow *
- Water corrected volume flow *

Factory setting

Off

Pulse scaling



Navigation

Expert → Output → PFS output 1 to n → Pulse scaling (0455-1 to n)

Prerequisite

The **Pulse** option is selected in the **Operating mode** parameter (→ 171) and a process variable is selected in the **Assign pulse output** parameter (→ 173).

Description

Use this function to enter the value for the measured value that a pulse is equivalent to.

* Visibility depends on order options or device settings

User entry	Positive floating point number
Factory setting	Depends on country and nominal diameter → 📄 334
Additional information	<p><i>User entry</i></p> <p>Weighting of the pulse output with a quantity.</p> <p>The lower the pulse value, the</p> <ul style="list-style-type: none"> ▪ better the resolution. ▪ the higher the frequency of the pulse response.

Pulse width



Navigation	📄📄 Expert → Output → PFS output 1 to n → Pulse width (0452-1 to n)
Prerequisite	The Pulse option is selected in the Operating mode parameter (→ 📄 171) and a process variable is selected in the Assign pulse output parameter (→ 📄 173).
Description	Use this function to enter the duration of the output pulse.
User entry	0.05 to 2 000 ms
Factory setting	100 ms
Additional information	<p><i>Description</i></p> <ul style="list-style-type: none"> ▪ Define how long a pulse is (duration). ▪ The maximum pulse rate is defined by $f_{\max} = 1 / (2 \times \text{pulse width})$. ▪ The interval between two pulses lasts at least as long as the set pulse width. ▪ The maximum flow is defined by $Q_{\max} = f_{\max} \times \text{pulse value}$. ▪ If the flow exceeds these limit values, the measuring device displays the 443 Pulse output 1 to n diagnostic message.

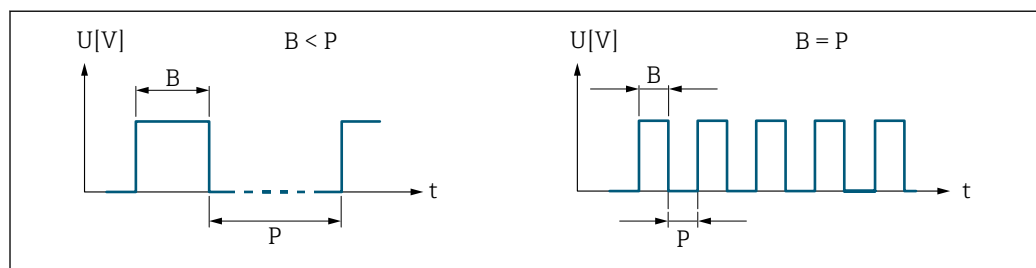

A0026882

B Pulse width entered
P Pauses between the individual pulses

Example

- Pulse value: 0.1 g
- Pulse width: 0.1 ms
- f_{\max} : $1 / (2 \times 0.1 \text{ ms}) = 5 \text{ kHz}$
- Q_{\max} : $5 \text{ kHz} \times 0.1 \text{ g} = 0.5 \text{ kg/s}$

Measuring mode

Navigation	Expert → Output → PFS output 1 to n → Measuring mode (0457-1 to n)
Prerequisite	In the Operating mode parameter (→ 171), the Pulse option is selected, and one of the following options is selected in the Assign pulse output parameter (→ 173): <ul style="list-style-type: none"> ■ Mass flow ■ Volume flow ■ Corrected volume flow ■ Target mass flow * ■ Carrier mass flow *
Description	Use this function to select the measuring mode for the pulse output.
Selection	<ul style="list-style-type: none"> ■ Forward flow ■ Forward/Reverse flow ■ Reverse flow ■ Reverse flow compensation
Factory setting	Forward flow
Additional information	<p><i>Selection</i></p> <ul style="list-style-type: none"> ■ Forward flow Positive flow is output, negative flow is not output. ■ Forward/Reverse flow Positive and negative flow are output (absolute value), but a distinction is not made between positive and negative flow. ■ Reverse flow Negative flow is output, positive flow is not output. ■ Reverse flow compensation The flow components outside the measuring range are buffered, balanced and output after a maximum delay of 60 s. <p> For a detailed description of the options available, see the Measuring mode parameter (→ 161)</p> <p><i>Examples</i></p> <p> For a detailed description of the configuration examples, see the Measuring mode parameter (→ 161)</p>



Failure mode



Navigation	Expert → Output → PFS output 1 to n → Failure mode (0480-1 to n)
Prerequisite	The Pulse option is selected in the Operating mode parameter (→ 171) and a process variable is selected in the Assign pulse output parameter (→ 173).
Description	Use this function to select the failure mode of the pulse output in the event of a device alarm.

* Visibility depends on order options or device settings

Selection	<ul style="list-style-type: none"> ■ Actual value ■ No pulses
Factory setting	No pulses
Additional information	<p><i>Description</i></p> <p>The dictates of safety render it advisable to ensure that the pulse output shows a predefined behavior in the event of a device alarm.</p> <p><i>Selection</i></p> <ul style="list-style-type: none"> ■ Actual value In the event of a device alarm, the pulse output continues on the basis of the current flow measurement. The fault is ignored. ■ No pulses In the event of a device alarm, the pulse output is "switched off". <p>NOTICE! A device alarm is a measuring device error that must be taken seriously. It can affect the measurement quality such that the quality can no longer be guaranteed. The Actual value option is only recommended if it can be guaranteed that all possible alarm conditions will not affect the measurement quality.</p>

Pulse output 1 to n

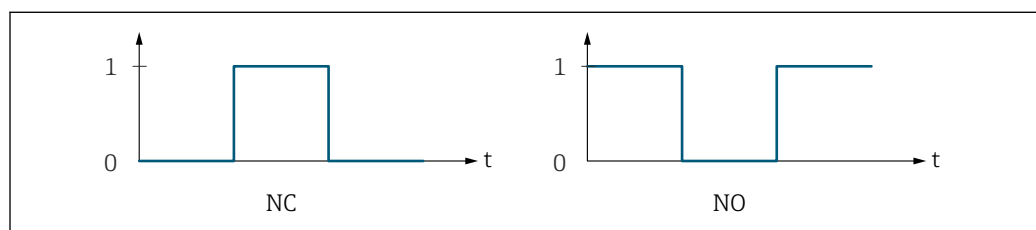
Navigation	 Expert → Output → PFS output 1 to n → Pulse output 1 to n (0456-1 to n)
Prerequisite	The Pulse option is selected in the Operating mode parameter (→  171) parameter.
Description	Displays the pulse frequency currently output.
User interface	Positive floating-point number
Additional information	<p><i>Description</i></p> <ul style="list-style-type: none"> ■ The pulse output is an open collector output. ■ This is configured at the factory in such a way that the transistor is conductive for the duration of the pulse (NO contact) and is safety-oriented.



A0028726

0 Non-conductive
 1 Conductive
 NC NC contact (normally closed)
 NO NO contact (normally open)

The output behavior can be reversed via the **Invert output signal** parameter (→  190) i.e. the transistor does not conduct for the duration of the pulse.

In addition, the behavior of the output in the event of a device alarm (**Failure mode** parameter (→  175)) can be configured.

Assign frequency output
**Navigation**

Expert → Output → PFS output 1 to n → Assign freq. (0478-1 to n)

Prerequisite

In the **Operating mode** parameter (→ 171), the **Frequency** option is selected.

Description

Use this function to select the process variable for the frequency output.



Detailed description of the options **Oscillation frequency**, **Oscillation amplitude**, **Oscillation damping** and **Signal asymmetry: Value 1 display** parameter (→ 19)

Selection



- Off
- Mass flow
- Volume flow
- Corrected volume flow *
- Density
- Reference density *
- Time period signal frequency (TPS) *
- Temperature
- Pressure
- Dynamic viscosity *
- Kinematic viscosity *
- Temp. compensated dynamic viscosity *
- Temp. compensated kinematic viscosity *
- GSV flow *
- GSV flow alternative *
- NSV flow *
- NSV flow alternative *
- S&W volume flow *
- Reference density alternative *
- Water cut *
- Oil density *
- Water density *
- Oil mass flow *
- Water mass flow *
- Oil volume flow *
- Water volume flow *
- Oil corrected volume flow *
- Water corrected volume flow *
- Concentration *
- Target mass flow *
- Carrier mass flow *
- Target volume flow *
- Carrier volume flow *
- Target corrected volume flow *
- Carrier corrected volume flow *
- Application specific output 0 *
- Application specific output 1 *
- Inhomogeneous medium index
- Suspended bubbles index *
- HBSI *
- Raw value mass flow
- Exciter current 0
- Exciter current 1 *
- Oscillation damping 0



* Visibility depends on order options or device settings

- Oscillation damping 1 *
- Oscillation damping fluctuation 0 *
- Oscillation damping fluctuation 1 *
- Oscillation frequency 0
- Oscillation frequency 1 *
- Frequency fluctuation 0 *
- Frequency fluctuation 1 *
- Oscillation amplitude 0 *
- Oscillation amplitude 1 *
- Signal asymmetry
- Torsion signal asymmetry *
- Carrier pipe temperature
- Electronics temperature
- Sensor index coil asymmetry
- Test point 0
- Test point 1

Factory setting Off

Minimum frequency value

Navigation   Expert → Output → PFS output 1 to n → Min. freq. value (0453-1 to n)



Prerequisite The **Frequency** option is selected in the **Operating mode** parameter (→  171) and a process variable is selected in the **Assign frequency output** parameter (→  177).



Description Use this function to enter the minimum frequency.

User entry 0.0 to 10 000.0 Hz

Factory setting 0.0 Hz

Maximum frequency value

Navigation   Expert → Output → PFS output 1 to n → Max. freq. value (0454-1 to n)

Prerequisite The **Frequency** option is selected in the **Operating mode** parameter (→  171) and a process variable is selected in the **Assign frequency output** parameter (→  177).

Description Use this function to enter the end value frequency.

User entry 0.0 to 10 000.0 Hz

Factory setting 10 000.0 Hz

* Visibility depends on order options or device settings

Measuring value at minimum frequency

Navigation	Expert → Output → PFS output 1 to n → Val. at min.freq (0476-1 to n)
Prerequisite	The Frequency option is selected in the Operating mode parameter (→ 171) and a process variable is selected in the Assign frequency output parameter (→ 177).
Description	Use this function to enter the measured value for the start value frequency.
User entry	Signed floating-point number
Factory setting	Depends on country and nominal diameter
Additional information	<p><i>Dependency</i></p> <p> The entry depends on the process variable selected in the Assign frequency output parameter (→ 177).</p>

Measuring value at maximum frequency

Navigation	Expert → Output → PFS output 1 to n → Val. at max.freq (0475-1 to n)
Prerequisite	The Frequency option is selected in the Operating mode parameter (→ 171) and a process variable is selected in the Assign frequency output parameter (→ 177).
Description	Use this function to enter the measured value for the end value frequency.
User entry	Signed floating-point number
Factory setting	Depends on country and nominal diameter
Additional information	<p><i>Description</i></p> <p>Use this function to enter the maximum measured value at the maximum frequency. The selected process variable is output as a proportional frequency.</p> <p><i>Dependency</i></p> <p> The entry depends on the process variable selected in the Assign frequency output parameter (→ 177).</p>

Measuring mode

Navigation	Expert → Output → PFS output 1 to n → Measuring mode (0479-1 to n)
Prerequisite	<p>In the Operating mode parameter (→ 171), the Frequency option is selected, and one of the following options is selected in the Assign frequency output parameter (→ 177):</p> <ul style="list-style-type: none"> ■ Mass flow ■ Volume flow ■ Corrected volume flow

- Target mass flow *
- Carrier mass flow *
- Density
- Reference density
- Concentration *
- Dynamic viscosity *
- Kinematic viscosity *
- Temp. compensated dynamic viscosity *
- Temp. compensated kinematic viscosity *
- Temperature
- Carrier pipe temperature *
- Electronics temperature
- Oscillation frequency 0
- Oscillation frequency 1 *
- Frequency fluctuation 0
- Frequency fluctuation 1 *
- Oscillation amplitude 0 *
- Oscillation amplitude 1 *
- Oscillation damping 0
- Oscillation damping 1 *
- Oscillation damping fluctuation 0
- Oscillation damping fluctuation 1 *
- Signal asymmetry
- Exciter current 0
- Exciter current 1 *

 Detailed description of the options **Oscillation frequency**, **Oscillation amplitude**, **Oscillation damping** and **Signal asymmetry: Value 1 display** parameter (→  19)

Description

Use this function to select the measuring mode for the frequency output.

Selection



- Forward flow
- Forward/Reverse flow
- Reverse flow compensation

Factory setting



Forward flow

Additional information

Selection

 For a detailed description of the options available, see the **Measuring mode** parameter (→  161)

Examples

 For a detailed description of the configuration examples, see the **Measuring mode** parameter (→  161)

* Visibility depends on order options or device settings

Damping output
**Navigation**

Expert → Output → PFS output 1 to n → Damping out. (0477-1 to n)

Prerequisite

In the **Operating mode** parameter (→ 171), the **Frequency** option is selected, and one of the following options is selected in the **Assign frequency output** parameter (→ 177):

- Mass flow
- Volume flow
- Corrected volume flow
- Target mass flow *
- Carrier mass flow *
- Density
- Reference density
- Concentration *
- Dynamic viscosity *
- Kinematic viscosity *
- Temp. compensated dynamic viscosity *
- Temp. compensated kinematic viscosity *
- Temperature
- Carrier pipe temperature *
- Electronics temperature
- Oscillation frequency 0
- Oscillation frequency 1 *
- Frequency fluctuation 0
- Frequency fluctuation 1 *
- Oscillation amplitude 0 *
- Oscillation amplitude 1 *
- Oscillation damping 0
- Oscillation damping 1 *
- Oscillation damping fluctuation 0
- Oscillation damping fluctuation 1 *
- Signal asymmetry
- Exciter current 0
- Exciter current 1 *

Detailed description of the options **Oscillation frequency**, **Oscillation amplitude**, **Oscillation damping** and **Signal asymmetry: Value 1 display** parameter (→ 19)

Description

Use this function to enter a time constant for the reaction time of the output signal to fluctuations in the measured value.

User entry

0 to 999.9 s

Factory setting

0.0 s

Additional information

User entry







Use this function to enter a time constant (PT1 element ⁷⁾) for frequency output damping:







- If a low time constant is entered, the current output reacts particularly quickly to fluctuating measured variables.
- On the other hand, the current output reacts more slowly if a high time constant is entered.

Damping is switched off if **0** is entered (factory setting).



* Visibility depends on order options or device settings
 7) proportional transmission behavior with first order delay

The frequency output is subject to separate damping that is independent of all preceding time constants.

Failure mode 	
Navigation	  Expert → Output → PFS output 1 to n → Failure mode (0451-1 to n)
Prerequisite	The Frequency option is selected in the Operating mode parameter (→  171) and a process variable is selected in the Assign frequency output parameter (→  177).
Description	Use this function to select the failure mode of the frequency output in the event of a device alarm.
Selection	<ul style="list-style-type: none"> ■ Actual value ■ Defined value ■ 0 Hz
Factory setting	0 Hz
Additional information	<p><i>Selection</i></p> <ul style="list-style-type: none"> ■ Actual value In the event of a device alarm, the frequency output continues on the basis of the current flow measurement. The device alarm is ignored. ■ Defined value In the event of a device alarm, the frequency output continues on the basis of a predefined value. The Failure frequency (→  182) replaces the current measured value, making it possible to bypass the device alarm. The actual measurement is switched off for the duration of the device alarm. ■ 0 Hz In the event of a device alarm, the frequency output is "switched off". <p>NOTICE! A device alarm is a measuring device error that must be taken seriously. It can affect the measurement quality such that the quality can no longer be guaranteed. The Actual value option is only recommended if it can be guaranteed that all possible alarm conditions will not affect the measurement quality.</p>



Failure frequency 	
Navigation	  Expert → Output → PFS output 1 to n → Failure freq. (0474-1 to n)
Prerequisite	In the Operating mode parameter (→  171), the Frequency option is selected, in the Assign frequency output parameter (→  177) a process variable is selected, and in the Failure mode parameter (→  182), the Defined value option is selected.
Description	Use this function to enter the value for the frequency output in the event of a device alarm in order to bypass the alarm.
User entry	0.0 to 12 500.0 Hz
Factory setting	0.0 Hz

Output frequency

Navigation	 Expert → Output → PFS output 1 to n → Output freq. (0471-1 to n)
Prerequisite	In the Operating mode parameter (→  171), the Frequency option is selected.
Description	Displays the actual value of the output frequency which is currently measured.
User interface	0.0 to 12 500.0 Hz

Switch output function



Navigation	 Expert → Output → PFS output 1 to n → Switch out funct (0481-1 to n)
Prerequisite	The Switch option is selected in the Operating mode parameter (→  171).
Description	Use this function to select a function for the switch output.
Selection	<ul style="list-style-type: none"> ▪ Off ▪ On ▪ Diagnostic behavior ▪ Limit ▪ Flow direction check ▪ Status
Factory setting	Off
Additional information	<p><i>Selection</i></p> <ul style="list-style-type: none"> ▪ Off The switch output is permanently switched off (open, non-conductive). ▪ On The switch output is permanently switched on (closed, conductive). ▪ Diagnostic behavior Indicates if the diagnostic event is present or not. Is used to output diagnostic information and to react to it appropriately at the system level. ▪ Limit Indicates if a specified limit value has been reached for the process variable. Is used to output diagnostic information relating to the process and to react to it appropriately at the system level. ▪ Flow direction check Indicates the flow direction (forward or reverse flow). ▪ Status Displays the device status depending on whether empty pipe detection or low flow cut off is selected.

Assign diagnostic behavior

Navigation	Expert → Output → PFS output 1 to n → Assign diag. beh (0482-1 to n)
Prerequisite	<ul style="list-style-type: none"> ■ In the Operating mode parameter (→ 171), the Switch option is selected. ■ In the Switch output function parameter (→ 183), the Diagnostic behavior option is selected.
Description	Use this function to select the diagnostic event category that is displayed for the switch output.
Selection	<ul style="list-style-type: none"> ■ Alarm ■ Alarm or warning ■ Warning
Factory setting	Alarm
Additional information	<p><i>Description</i></p> <p> If no diagnostic event is pending, the switch output is closed and conductive.</p> <p><i>Selection</i></p> <ul style="list-style-type: none"> ■ Alarm The switch output signals only diagnostic events in the alarm category. ■ Alarm or warning The switch output signals diagnostic events in the alarm and warning category. ■ Warning The switch output signals only diagnostic events in the warning category.

Assign limit

Navigation	Expert → Output → PFS output 1 to n → Assign limit (0483-1 to n)
Prerequisite	<ul style="list-style-type: none"> ■ In the Operating mode parameter (→ 171), the Switch option is selected. ■ In the Switch output function parameter (→ 183), the Limit option is selected.
Description	Use this function to select a process variable for the limit function.
Selection	<ul style="list-style-type: none"> ■ Mass flow ■ Volume flow ■ Corrected volume flow * ■ Target mass flow * ■ Carrier mass flow * ■ Target volume flow * ■ Carrier volume flow * ■ Target corrected volume flow * ■ Carrier corrected volume flow * ■ Density ■ Reference density * ■ Reference density alternative *

* Visibility depends on order options or device settings

- GSV flow *
- GSV flow alternative *
- NSV flow *
- NSV flow alternative *
- S&W volume flow *
- Water cut *
- Oil density *
- Water density *
- Oil mass flow *
- Water mass flow *
- Oil volume flow *
- Water volume flow *
- Oil corrected volume flow *
- Water corrected volume flow *
- Dynamic viscosity *
- Concentration *
- Kinematic viscosity *
- Temp. compensated dynamic viscosity *
- Temp. compensated kinematic viscosity *
- Temperature
- Totalizer 1
- Totalizer 2
- Totalizer 3
- Oscillation damping
- Pressure
- Application specific output 0 *
- Application specific output 1 *
- Inhomogeneous medium index
- Suspended bubbles index *

Factory setting

Volume flow

Additional information

Description

Behavior of status output when Switch-on value > Switch-off value:

- Process variable > Switch-on value: transistor is conductive
- Process variable < Switch-off value: transistor is non-conductive

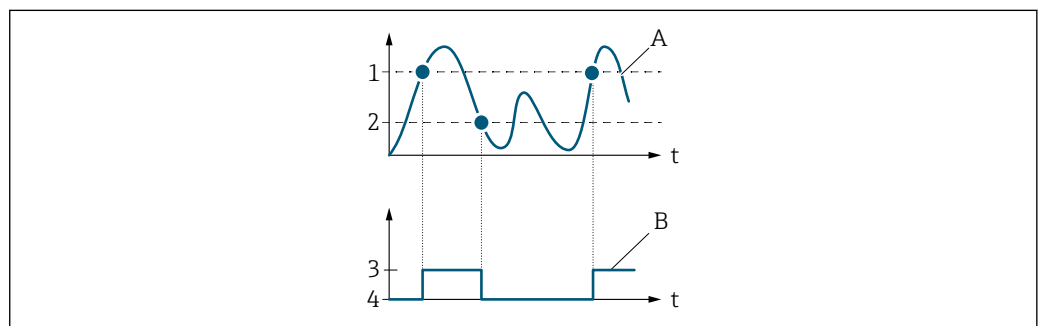

A0026891

- 1 Switch-on value
- 2 Switch-off value
- 3 Conductive
- 4 Non-conductive
- A Process variable
- B Status output

* Visibility depends on order options or device settings

Behavior of status output when Switch-on value < Switch-off value:

- Process variable < Switch-on value: transistor is conductive
- Process variable > Switch-off value: transistor is non-conductive

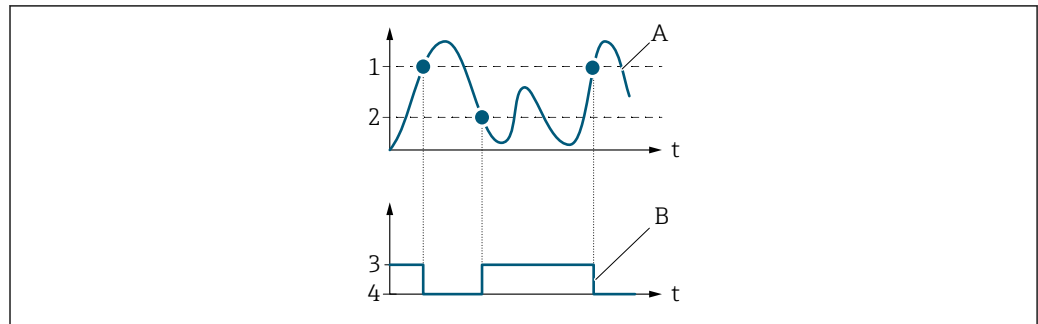

A0026892

- 1 Switch-off value
- 2 Switch-on value
- 3 Conductive
- 4 Non-conductive
- A Process variable
- B Status output

Behavior of status output when Switch-on value = Switch-off value:

- Process variable > Switch-on value: transistor is conductive
- Process variable < Switch-off value: transistor is non-conductive

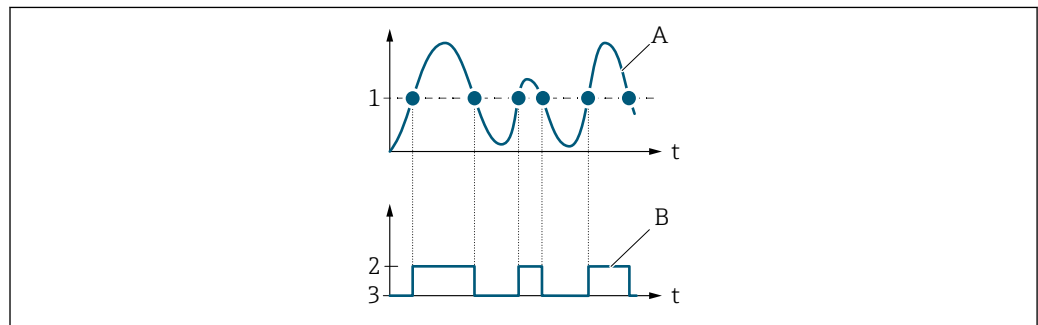

A0026893

- 1 Switch-on value = Switch-off value
- 2 Conductive
- 3 Non-conductive
- A Process variable
- B Status output

Switch-on value



Navigation

Expert → Output → PFS output 1 to n → Switch-on value (0466-1 to n)

Prerequisite



- The **Switch** option is selected in the **Operating mode** parameter (→ 171).
- The **Limit** option is selected in the **Switch output function** parameter (→ 183).

Description







Use this function to enter the measured value for the switch-on point.

User entry





Signed floating-point number

Factory setting	Country-specific: <ul style="list-style-type: none"> ■ 0 kg/h ■ 0 lb/min
Additional information	<p><i>Description</i></p> <p>Use this function to enter the limit value for the switch-on value (process variable > switch-on value = closed, conductive).</p> <p> When using a hysteresis: Switch-on value > Switch-off value.</p> <p><i>Dependency</i></p> <p> The unit depends on the process variable selected in the Assign limit parameter (→  184).</p>

Switch-off value

Navigation	  Expert → Output → PFS output 1 to n → Switch-off value (0464-1 to n)
Prerequisite	<ul style="list-style-type: none"> ■ The Switch option is selected in the Operating mode parameter (→  171). ■ The Limit option is selected in the Switch output function parameter (→  183).
Description	Use this function to enter the measured value for the switch-off point.
User entry	Signed floating-point number
Factory setting	Country-specific: <ul style="list-style-type: none"> ■ 0 kg/h ■ 0 lb/min
Additional information	<p><i>Description</i></p> <p>Use this function to enter the limit value for the switch-off value (process variable < switch-off value = open, non-conductive).</p> <p> When using a hysteresis: Switch-on value > Switch-off value.</p> <p><i>Dependency</i></p> <p> The unit depends on the process variable selected in the Assign limit parameter (→  184).</p>

Assign flow direction check

Navigation	  Expert → Output → PFS output 1 to n → Assign dir.check (0484-1 to n)
Prerequisite	<ul style="list-style-type: none"> ■ The Switch option is selected in the Operating mode parameter (→  171). ■ The Flow direction check option is selected in the Switch output function parameter (→  183).
Description	Use this function to select a process variable for monitoring the flow direction.

- Selection**
- Off
 - Volume flow
 - Mass flow
 - Corrected volume flow *

Factory setting Mass flow

Assign status

Navigation   Expert → Output → PFS output 1 to n → Assign status (0485-1 to n)

- Prerequisite**
- The **Switch** option is selected in the **Operating mode** parameter (→  171).
 - The **Status** option is selected in the **Switch output function** parameter (→  183).

Description Use this function to select a device status for the switch output.



- Selection**
- Partially filled pipe detection
 - Low flow cut off

Factory setting Partially filled pipe detection

Additional information *Selection*

If empty pipe detection or low flow cut off are active, the output is conductive. Otherwise, the switch output is non-conductive.

Switch-on delay

Navigation   Expert → Output → PFS output 1 to n → Switch-on delay (0467-1 to n)



- Prerequisite**
- The **Switch** option is selected in the **Operating mode** parameter (→  171).
 - The **Limit** option is selected in the **Switch output function** parameter (→  183).

Description Use this function to enter a delay time for switching on the switch output.

User entry 0.0 to 100.0 s

Factory setting 0.0 s

Switch-off delay



Navigation   Expert → Output → PFS output 1 to n → Switch-off delay (0465-1 to n)

- Prerequisite**
- The **Switch** option is selected in the **Operating mode** parameter (→  171).
 - The **Limit** option is selected in the **Switch output function** parameter (→  183).



* Visibility depends on order options or device settings

Description	Use this function to enter a delay time for switching off the switch output.
User entry	0.0 to 100.0 s
Factory setting	0.0 s

Failure mode

Navigation	  Expert → Output → PFS output 1 to n → Failure mode (0486-1 to n)
Description	Use this function to select a failsafe mode for the switch output in the event of a device alarm.
Selection	<ul style="list-style-type: none"> ▪ Actual status ▪ Open ▪ Closed
Factory setting	Open
Additional information	<p><i>Options</i></p> <ul style="list-style-type: none"> ▪ Actual status In the event of a device alarm, faults are ignored and the current behavior of the input value is output by the switch output. The Actual status option behaves in the same way as the current input value. ▪ Open In the event of a device alarm, the switch output's transistor is set to non-conductive. ▪ Closed In the event of a device alarm, the switch output's transistor is set to conductive.

Switch state

Navigation	  Expert → Output → PFS output 1 to n → Switch state (0461-1 to n)
Prerequisite	The Switch option is selected in the Operating mode parameter (→  171).
Description	Displays the current switch status of the status output.
User interface	<ul style="list-style-type: none"> ▪ Open ▪ Closed
Additional information	<p><i>User interface</i></p> <ul style="list-style-type: none"> ▪ Open The switch output is not conductive. ▪ Closed The switch output is conductive.

Invert output signal 🔒

Navigation 📄📄 Expert → Output → PFS output 1 to n → Invert outp.sig. (0470-1 to n)

Description Use this function to select whether to invert the output signal.

Selection

- No
- Yes

Factory setting No

Additional information *Selection*
No option (passive - negative)

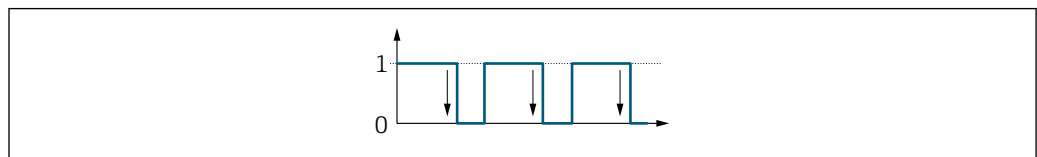

A0026693

Yes option (passive - positive)

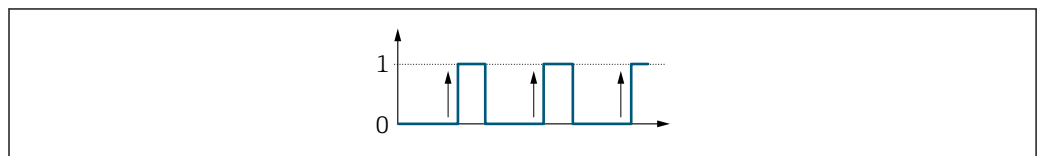







A0026692

3.5.3 "Relay output 1 to n" submenu



Navigation 📄📄 Expert → Output → Relay output 1 to n

▶ **Relay output 1 to n**



Terminal number (0812-1 to n)	→ 📄 191
Relay output function (0804-1 to n)	→ 📄 191
Assign flow direction check (0808-1 to n)	→ 📄 192
Assign limit (0807-1 to n)	→ 📄 192
Assign diagnostic behavior (0806-1 to n)	→ 📄 193
Assign status (0805-1 to n)	→ 📄 194

Switch-off value (0809-1 to n)	→  194
Switch-off delay (0813-1 to n)	→  195
Switch-on value (0810-1 to n)	→  195
Switch-on delay (0814-1 to n)	→  196
Failure mode (0811-1 to n)	→  196
Switch state (0801-1 to n)	→  196
Powerless relay status (0816-1 to n)	→  197

Terminal number



Navigation	  Expert → Output → Relay output 1 to n → Terminal no. (0812-1 to n)
Description	Displays the terminal numbers used by the relay output module.
User interface	<ul style="list-style-type: none"> ■ Not used ■ 24-25 (I/O 2) ■ 22-23 (I/O 3)
Additional information	<p><i>"Not used" option</i></p> <p>The relay output module does not use any terminal numbers.</p>

Relay output function



Navigation	  Expert → Output → Relay output 1 to n → Relay outp.func. (0804-1 to n)
Description	Use this function to select an output function for the relay output.
Selection	<ul style="list-style-type: none"> ■ Closed ■ Open ■ Diagnostic behavior ■ Limit ■ Flow direction check ■ Digital Output
Factory setting	Closed

Additional information	<p><i>Selection</i></p> <ul style="list-style-type: none"> ■ Closed The relay output is permanently switched on (closed, conductive). ■ Open The relay output is permanently switched off (open, non-conductive). ■ Diagnostic behavior Indicates if the diagnostic event is present or not. Is used to output diagnostic information and to react to it appropriately at the system level. ■ Limit Indicates if a specified limit value has been reached for the process variable. Is used to output diagnostic information relating to the process and to react to it appropriately at the system level. ■ Flow direction check Indicates the flow direction (forward or reverse flow). ■ Digital Output Indicates the device status depending on whether empty pipe detection or low flow cut off is selected.
-------------------------------	---

Assign flow direction check

Navigation	  Expert → Output → Relay output 1 to n → Assign dir.check (0808-1 to n)
Prerequisite	The Flow direction check option is selected in the Relay output function parameter (→  191).
Description	Use this function to select a process variable for monitoring the flow direction.
Selection	<ul style="list-style-type: none"> ■ Off ■ Volume flow ■ Mass flow ■ Corrected volume flow *
Factory setting	Mass flow

Assign limit

Navigation	  Expert → Output → Relay output 1 to n → Assign limit (0807-1 to n)
Prerequisite	The Limit option is selected in the Relay output function parameter (→  191).
Description	Use this function to select a process variable for the limit value function.
Selection	<ul style="list-style-type: none"> ■ Mass flow ■ Volume flow ■ Corrected volume flow * ■ Target mass flow * ■ Carrier mass flow * ■ Target volume flow *

* Visibility depends on order options or device settings

- Carrier volume flow *
- Target corrected volume flow *
- Carrier corrected volume flow *
- Density
- Reference density *
- Reference density alternative *
- GSV flow *
- GSV flow alternative *
- NSV flow *
- NSV flow alternative *
- S&W volume flow *
- Water cut *
- Oil density *
- Water density *
- Oil mass flow *
- Water mass flow *
- Oil volume flow *
- Water volume flow *
- Oil corrected volume flow *
- Water corrected volume flow *
- Dynamic viscosity *
- Concentration *
- Kinematic viscosity *
- Temp. compensated dynamic viscosity *
- Temp. compensated kinematic viscosity *
- Temperature
- Totalizer 1
- Totalizer 2
- Totalizer 3
- Oscillation damping
- Pressure
- Application specific output 0 *
- Application specific output 1 *
- Inhomogeneous medium index
- Suspended bubbles index *

Factory setting

Mass flow

Assign diagnostic behavior**Navigation**

Expert → Output → Relay output 1 to n → Assign diag. beh (0806-1 to n)

Prerequisite

In the **Relay output function** parameter (→ 191), the **Diagnostic behavior** option is selected.

Description

Use this function to select the category of the diagnostic events that are displayed for the relay output.

Selection

- Alarm
- Alarm or warning
- Warning

* Visibility depends on order options or device settings

Factory setting Alarm



Additional information *Description*

 If no diagnostic event is pending, the relay output is closed and conductive.

Selection

- Alarm
The relay output signals only diagnostic events in the alarm category.
- Alarm or warning
The relay output signals diagnostic events in the alarm and warning category.
- Warning
The relay output signals only diagnostic events in the warning category.

Assign status

Navigation   Expert → Output → Relay output 1 to n → Assign status (0805-1 to n)

Prerequisite In the **Relay output function** parameter (→  191), the **Digital Output** option is selected.



Description Use this function to select the device status for the relay output.

Selection

- Partially filled pipe detection
- Low flow cut off

Factory setting Partially filled pipe detection

Switch-off value

Navigation   Expert → Output → Relay output 1 to n → Switch-off value (0809-1 to n)



Prerequisite In the **Relay output function** parameter (→  191), the **Limit** option is selected.

Description Use this function to enter the measured value for the switch-off point.



User entry Signed floating-point number

Factory setting Country-specific:







- 0 kg/h
- 0 lb/min

Additional information	<p><i>Description</i></p> <p>Use this function to enter the limit value for the switch-off value (process variable < switch-off value = open, non-conductive).</p> <p> When using a hysteresis: Switch-on value > Switch-off value.</p> <p><i>Dependency</i></p> <p> The unit is dependent on the process variable selected in the Assign limit parameter (→  192).</p>
-------------------------------	---

Switch-off delay

Navigation	  Expert → Output → Relay output 1 to n → Switch-off delay (0813-1 to n)
Prerequisite	In the Relay output function parameter (→  191), the Limit option is selected.
Description	Use this function to enter a delay time for switching off the switch output.
User entry	0.0 to 100.0 s
Factory setting	0.0 s

Switch-on value

Navigation	  Expert → Output → Relay output 1 to n → Switch-on value (0810-1 to n)
Prerequisite	The Limit option is selected in the Relay output function parameter (→  191).
Description	Use this function to enter the measured value for the switch-on point.
User entry	Signed floating-point number
Factory setting	Country-specific: <ul style="list-style-type: none"> ■ 0 kg/h ■ 0 lb/min
Additional information	<p><i>Description</i></p> <p>Use this function to enter the limit value for the switch-on value (process variable > switch-on value = closed, conductive).</p> <p> When using a hysteresis: Switch-on value > Switch-off value.</p> <p><i>Dependency</i></p> <p> The unit is dependent on the process variable selected in the Assign limit parameter (→  192).</p>

Switch-on delay

Navigation	Expert → Output → Relay output 1 to n → Switch-on delay (0814-1 to n)
Prerequisite	In the Relay output function parameter (→ 191), the Limit option is selected.
Description	Use this function to enter a delay time for switching on the switch output.
User entry	0.0 to 100.0 s
Factory setting	0.0 s

Failure mode

Navigation	Expert → Output → Relay output 1 to n → Failure mode (0811-1 to n)
Description	Use this function to select the failure mode of the relay output in the event of a device alarm.
Selection	<ul style="list-style-type: none"> ▪ Actual status ▪ Open ▪ Closed
Factory setting	Open
Additional information	<p><i>Selection</i></p> <ul style="list-style-type: none"> ▪ Actual status In the event of a device alarm, faults are ignored and the current behavior of the input value is output by the relay output. The Actual status option behaves in the same way as the current input value. ▪ Open In the event of a device alarm, the relay output's transistor is set to non-conductive. ▪ Closed In the event of a device alarm, the relay output's transistor is set to conductive.

Switch state

Navigation	Expert → Output → Relay output 1 to n → Switch state (0801-1 to n)
Description	Displays the current status of the relay output.
User interface	<ul style="list-style-type: none"> ▪ Open ▪ Closed

- Additional information** *User interface*
- Open
The relay output is not conductive.
 - Closed
The relay output is conductive.

Powerless relay status





- Navigation** Expert → Output → Relay output 1 to n → Powerless relay (0816-1 to n)
- Description** Use this function to select the quiescent state for the relay output.
- Selection**
- Open
 - Closed
- Factory setting** Open
- Additional information** *Selection*
- Open
The relay output is not conductive.
 - Closed
The relay output is conductive.

3.5.4 "Double pulse output" submenu



Navigation Expert → Output → Double pulse out

▶ **Double pulse output**



Master terminal number (0981)	→ 198
Slave terminal number (0990)	→ 198
Signal mode (0991)	→ 198
Assign pulse output (0982)	→ 199
Value per pulse (0983)	→ 199
Pulse width (0986)	→ 200
Phase shift (0992)	→ 200
Measuring mode (0984)	→ 200

Failure mode (0985)	→  201
Pulse output (0987)	→  202
Invert output signal (0993)	→  202



Master terminal number

Navigation	  Expert → Output → Double pulse out → Master term. no. (0981)
Description	Displays the master terminal number for the double pulse output.
User interface	<ul style="list-style-type: none"> ■ Not used ■ 24-25 (I/O 2) ■ 22-23 (I/O 3)
Additional information	<p><i>"Not used" option</i></p> <p>The double pulse output does not use any terminal numbers.</p>

Slave terminal number

Navigation	  Expert → Output → Double pulse out → Slave term. no. (0990)
Description	Displays the slave terminal number for the double pulse output.
User interface	<ul style="list-style-type: none"> ■ Not used ■ 24-25 (I/O 2) ■ 22-23 (I/O 3)
Additional information	<p><i>"Not used" option</i></p> <p>The double pulse output does not use any terminal numbers.</p>



Signal mode

Navigation	  Expert → Output → Double pulse out → Signal mode (0991)
Description	Use this function to select the signal mode for the double pulse output.
Selection	<ul style="list-style-type: none"> ■ Passive ■ Active * ■ Passive NE

* Visibility depends on order options or device settings

Factory setting Passive

Assign pulse output

Navigation   Expert → Output → Double pulse out → Assign pulse (0982)

Description Use this function to select a process variable for the double pulse output.

Selection

- Off
- Mass flow
- Volume flow
- Corrected volume flow *
- Target mass flow *
- Carrier mass flow *
- Target volume flow *
- Carrier volume flow *
- Target corrected volume flow *
- Carrier corrected volume flow *
- GSV flow *
- GSV flow alternative *
- NSV flow *
- NSV flow alternative *
- S&W volume flow *
- Oil mass flow *
- Water mass flow *
- Oil volume flow *
- Water volume flow *
- Oil corrected volume flow *
- Water corrected volume flow *

Factory setting Off

Value per pulse

Navigation   Expert → Output → Double pulse out → Value per pulse (0983)

Description Use this function to enter the value for the measured value that a pulse is equivalent to.

User entry Signed floating-point number

Factory setting Depends on country and nominal diameter →  334

Additional information *User entry*

Weighting of the pulse output with a quantity.





The lower the pulse value, the

- better the resolution.
- the higher the frequency of the pulse response.

* Visibility depends on order options or device settings



Pulse width



Navigation	  Expert → Output → Double pulse out → Pulse width (0986)
Description	Use this function to enter the duration of the output pulse.
User entry	0.5 to 2 000 ms
Factory setting	0.5 ms
Additional information	 For a detailed description and example: Pulse width parameter (→  174)



Phase shift







Navigation	  Expert → Output → Double pulse out → Phase shift (0992)
Description	Use this function to select the degree of phase shift.
Selection	<ul style="list-style-type: none">■ 90°■ 180°
Factory setting	90°
Additional information	<i>Selection</i> <ul style="list-style-type: none">■ 90° Phase shift by a quarter period.■ 180° Phase shift by a half period, which is equivalent to a phase reversal.

Measuring mode





Navigation	  Expert → Output → Double pulse out → Measuring mode (0984)
Description	Use this function to select the measuring mode for the double pulse output.
Selection	<ul style="list-style-type: none">■ Forward flow■ Forward/Reverse flow■ Reverse flow■ Reverse flow compensation
Factory setting	Forward flow

Additional information	<p><i>Selection</i></p> <ul style="list-style-type: none"> ■ Forward flow Positive flow is output, negative flow is not output. ■ Forward/Reverse flow Positive and negative flow are output (absolute value), but a distinction is not made between positive and negative flow. ■ Reverse flow Negative flow is output, positive flow is not output. ■ Reverse flow compensation The flow components outside the span are buffered, balanced and output after a maximum delay of 60 s. <p> For a detailed description of the options available, see the Measuring mode parameter (→  161)</p> <p><i>Examples</i></p> <p> For a detailed description of the configuration examples, see the Measuring mode parameter (→  161)</p>
-------------------------------	---

Failure mode

Navigation	 Expert → Output → Double pulse out → Failure mode (0985)
Description	Use this function to select the failure mode of the double pulse output in the event of a device alarm.
Selection	<ul style="list-style-type: none"> ■ Actual value ■ No pulses
Factory setting	No pulses
Additional information	<p><i>Description</i></p> <p>The dictates of safety render it advisable to ensure that the double pulse output shows a predefined behavior in the event of a device alarm.</p> <p><i>Selection</i></p> <ul style="list-style-type: none"> ■ Actual value In the event of a device alarm, the double pulse output continues on the basis of the current flow measurement. The fault is ignored. ■ No pulses In the case of the double pulse output, if a device alarm occurs one pulse output is stopped and the other pulse output runs at the maximum pulse frequency. <p>NOTICE! A device alarm is a measuring device error that must be taken seriously. It can affect the measurement quality such that the quality can no longer be guaranteed. The Actual value option is only recommended if it can be guaranteed that all possible alarm conditions will not affect the measurement quality.</p>

Pulse output

Navigation	 Expert → Output → Double pulse out → Pulse output (0987)
Description	Displays the pulse frequency of the double pulse output which is currently output.
User interface	Positive floating-point number
Additional information	 For a detailed description and example: Pulse output parameter (→  86)

Invert output signal



Navigation	 Expert → Output → Double pulse out → Invert outp.sig. (0993)
Description	Use this function to select whether to invert the output signal.
Selection	<ul style="list-style-type: none"> ▪ No ▪ Yes
Factory setting	No
Additional information	<i>Selection</i> No option (passive - negative)

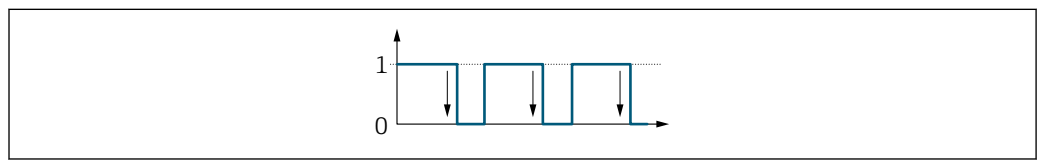

A0026693

Yes option (passive - positive)

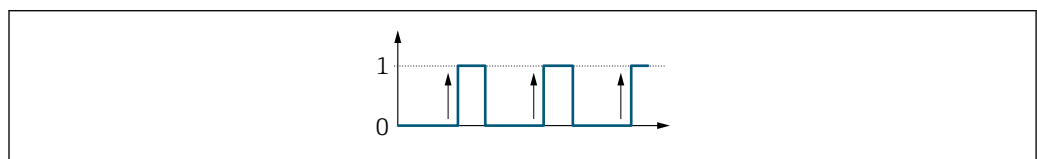

A0026692

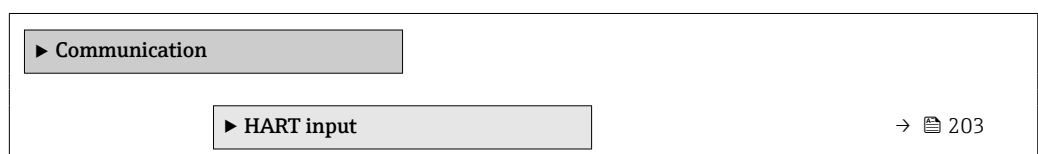

3.6 "Communication" submenu

Navigation  Expert → Communication





▶ HART output	→ 208
▶ Diagnostic configuration	→ 230
▶ Web server	→ 243
▶ WLAN settings	→ 247
▶ OPC-UA configuration	→ 253

3.6.1 "HART input" submenu





Navigation   Expert → Communication → HART input





▶ HART input	
▶ Configuration	→ 203
▶ Input	→ 208





"Configuration" submenu

Navigation   Expert → Communication → HART input → Configuration

▶ Configuration	
Capture mode (7001)	→ 204
Device ID (7007)	→ 204
Device type (7008)	→ 204
Manufacturer ID (7009)	→ 205
Burst command (7006)	→ 205
Slot number (7010)	→ 206
Timeout (7005)	→ 206
Failure mode (7011)	→ 207
Failure value (7012)	→ 207



Capture mode 	
Navigation	  Expert → Communication → HART input → Configuration → Capture mode (7001)
Description	Use this function to select the capture mode via burst or master communication.
Selection	<ul style="list-style-type: none"> ■ Off ■ Burst network ■ Master network
Factory setting	Off
Additional information	<p><i>"Burst network" option</i></p> <p>The device records data transmitted via burst in the network.</p> <p> An external pressure sensor must be in the burst mode.</p> <p><i>"Master network" option</i></p> <p>In this case, the device must be located in a HART network in which a HART master (control) queries the measured values of the up to 64 network participants. The device reacts only to the responses of a specific device in the network. Device ID, device type, manufacturer ID and the HART commands used by the master must be defined.</p>

Device ID 	
Navigation	  Expert → Communication → HART input → Configuration → Device ID (7007)
Prerequisite	The Master network option is selected in the Capture mode parameter (→  204).
Description	Use this function to enter the device ID of the HART slave device whose data are to be recorded.
User entry	<p>6-digit value:</p> <ul style="list-style-type: none"> ■ Via local operation: enter as hexadecimal or decimal number ■ Via operating tool: enter as decimal number
Factory setting	0
Additional information	 In addition to the device ID and manufacturer ID, the device type is part of the unique ID. Each HART device is uniquely identified by the unique device ID.



Device type 	
Navigation	  Expert → Communication → HART input → Configuration → Device type (7008)
Prerequisite	In the Capture mode parameter (→  204), the Master network option is selected.

Description	Use this function to enter the device type of the HART slave device whose data are to be recorded.
User entry	2-digit hexadecimal number
Factory setting	0x00
Additional information	 In addition to the device ID and manufacturer ID, the device type is part of the unique ID. Each HART device is uniquely identified by the unique device ID.

Manufacturer ID

Navigation	 Expert → Communication → HART input → Configuration → Manufacturer ID (7009)
Prerequisite	The Master network option is selected in the Capture mode parameter (→  204).
Description	Use this function to enter the manufacturer ID of the HART slave device whose data are to be recorded.
User entry	2-digit value: <ul style="list-style-type: none"> ▪ Via local operation: enter as hexadecimal or decimal number ▪ Via operating tool: enter as decimal number
Factory setting	0
Additional information	 In addition to the device ID and manufacturer ID, the device type is part of the unique ID. Each HART device is uniquely identified by the unique device ID.

Burst command

Navigation	 Expert → Communication → HART input → Configuration → Burst command (7006)
Prerequisite	The Burst network option or the Master network option are selected in the Capture mode parameter (→  204).
Description	Use this function to select the burst command to be recorded.
Selection	<ul style="list-style-type: none"> ▪ Command 1 ▪ Command 3 ▪ Command 9 ▪ Command 33
Factory setting	Command 1

Additional information	<i>Selection</i> <ul style="list-style-type: none"> ■ Command 1 Use this function to capture the primary variable. ■ Command 3 Use this function to capture the dynamic HART variables and the current. ■ Command 9 Use this function to capture the dynamic HART variables including the associated status. ■ Command 33 Use this function to capture the dynamic HART variables including the associated unit.
-------------------------------	--

Slot number	
--------------------	---

Navigation   Expert → Communication → HART input → Configuration → Slot number (7010)

Prerequisite The **Burst network** option or the **Master network** option is selected in the **Capture mode** parameter (→  204).

Description Use this function to enter the position of the process variable to be recorded in the burst command.

User entry 1 to 8

Factory setting 1

Additional information *User entry*

Slot	Command			
	1	3	9	33
1	PV	PV	HART variable (slot 1)	HART variable (slot 1)
2	–	SV	HART variable (slot 2)	HART variable (slot 2)
3	–	TV	HART variable (slot 3)	HART variable (slot 3)
4	–	QV	HART variable (slot 4)	HART variable (slot 4)
5	–	–	HART variable (slot 5)	–
6	–	–	HART variable (slot 6)	–
7	–	–	HART variable (slot 7)	–
8	–	–	HART variable (slot 8)	–

Timeout	
----------------	---

Navigation   Expert → Communication → HART input → Configuration → Timeout (7005)

Prerequisite The **Burst network** option or the **Master network** option is selected in the **Capture mode** parameter (→  204).

Description Use this function to enter the maximum permitted interval between two HART frames.

User entry 1 to 120 s

Factory setting 5 s

Additional information *Description*

 If the interval is exceeded, the measuring device displays the **F882 Input signal** diagnostic message.

Failure mode

Navigation  Expert → Communication → HART input → Configuration → Failure mode (7011)

Prerequisite In the **Capture mode** parameter (→  204), the **Burst network** option or **Master network** option is selected.

Description Use this function to select the device behavior if no data are recorded within the maximum permitted interval.

Selection

- Alarm
- Last valid value
- Defined value

Factory setting Alarm



Additional information *Options*

- Alarm
An error message is set.
- Last valid value
The last valid measured value is used.
- Defined value
A user-defined measured value is used: (**Failure value** parameter (→  207)).

Failure value

Navigation  Expert → Communication → HART input → Configuration → Failure value (7012)

Prerequisite The following conditions are met:

- In the **Capture mode** parameter (→  204), the **Burst network** option or **Master network** option is selected.
- In the **Failure mode** parameter (→  207), the **Defined value** option is selected.



Description Use this function to enter the measured value to be used if no data are recorded within the maximum permitted interval.

User entry Signed floating-point number

Factory setting 0

"Input" submenu

Navigation  Expert → Communication → HART input → Input

▶ Input	
Value (7003)	→  208
Status (7004)	→  208

Value

Navigation  Expert → Communication → HART input → Input → Value (7003)

Description Displays the value of the device variable recorded by the HART input.

User interface Signed floating-point number

Additional information *Dependency*
 The unit is taken from the **Temperature unit** parameter (→  98)

Status

Navigation  Expert → Communication → HART input → Input → Status (7004)



Description Displays the value of the device variable recorded by the HART input in accordance with the HART specification.

User interface

- Manual/Fixed
- Good
- Poor accuracy
- Bad



3.6.2 "HART output" submenu

Navigation  Expert → Communication → HART output

▶ HART output	
▶ Configuration	→  209
▶ Burst configuration	→  211

▶ Information	→ 218
▶ Output	→ 221

"Configuration" submenu



Navigation   Expert → Communication → HART output → Configuration

▶ Configuration	
HART short tag (0220)	→ 209
Device tag (0215)	→ 209
HART address (0219)	→ 210
No. of preambles (0217)	→ 210
Fieldbus writing access (0273)	→ 210

HART short tag



Navigation

  Expert → Communication → HART output → Configuration → HART short tag (0220)

Description

Use this function to enter a brief description for the measuring point. This can be edited and displayed via HART protocol or using the local display.

User entry

Max. 8 characters: A to Z, 0 to 9 and certain special characters (e.g. punctuation marks, @, %).

Factory setting

PROMASS

Device tag



Navigation

  Expert → Communication → HART output → Configuration → Device tag (0215)

Description

Use this function to enter the name for the measuring point.



User entry

Max. 32 characters, such as letters, numbers or special characters (e.g. @, %, /).



Factory setting

Promass



HART address 

Navigation	  Expert → Communication → HART output → Configuration → HART address (0219)
Description	Use this function to enter the address via which the data exchange takes place via HART protocol.
User entry	0 to 63
Factory setting	0
Additional information	<p><i>Description</i></p> <p>For addressing in a HART Multidrop network, the Fixed current option must be set in the Current span parameter (→  157) (current output 1).</p>

No. of preambles 

Navigation	  Expert → Communication → HART output → Configuration → No. of preambles (0217)
Description	Use this function to enter the number of preambles in the HART protocol.
User entry	2 to 20
Factory setting	5
Additional information	<p><i>User entry</i></p> <p>As every modem component can "swallow" a byte, 2-byte preambles at least must be defined.</p>

Fieldbus writing access 

Navigation	  Expert → Communication → HART output → Configuration → Fieldb.writ.acc. (0273)
Description	Use this function to restrict access to the measuring device via fieldbus (HART interface).
Selection	<ul style="list-style-type: none"> ■ Read + write ■ Read only
Factory setting	Read + write



Additional information*Description*















If read and/or write protection is enabled, the parameter can only be controlled and reset via local operation. Access is no longer possible via operating tools.



Selection



- Read + write
The parameters are readable and writable.
- Read only
The parameters are only readable.

"Burst configuration 1 to n" submenu*Navigation*

  Expert → Communication → HART output → Burst config.
→ Burst config. 1 to n

► Burst configuration 1 to n	
Burst mode 1 to n (2032-1 to n)	→  212
Burst command 1 to n (2031-1 to n)	→  212
Burst variable 0 (2033)	→  213
Burst variable 1 (2034)	→  215
Burst variable 2 (2035)	→  215
Burst variable 3 (2036)	→  215
Burst variable 4 (2037)	→  215
Burst variable 5 (2038)	→  216
Burst variable 6 (2039)	→  216
Burst variable 7 (2040)	→  216
Burst trigger mode (2044-1 to n)	→  216
Burst trigger level (2043-1 to n)	→  217
Min. update period (2042-1 to n)	→  217
Max. update period (2041-1 to n)	→  218



Burst mode 1 to n 	
Navigation	  Expert → Communication → HART output → Burst config. → Burst config. 1 to n → Burst mode 1 to n (2032-1 to n)
Description	Use this function to select whether to activate the HART burst mode for burst message X.
Selection	<ul style="list-style-type: none"> ■ Off ■ On
Factory setting	Off
Additional information	<p><i>Options</i></p> <ul style="list-style-type: none"> ■ Off The measuring device transmits data only when requested by the HART master. ■ On The measuring device transmits data regularly without being requested.

Burst command 1 to n 	
Navigation	  Expert → Communication → HART output → Burst config. → Burst config. 1 to n → Burst command 1 to n (2031-1 to n)
Description	Use this function to select the HART command that is sent to the HART master.
Selection	<ul style="list-style-type: none"> ■ Command 1 ■ Command 2 ■ Command 3 ■ Command 9 ■ Command 33 ■ Command 48
Factory setting	Command 2
Additional information	<p><i>Selection</i></p> <ul style="list-style-type: none"> ■ Command 1 Read out the primary variable. ■ Command 2 Read out the current and the main measured value as a percentage. ■ Command 3 Read out the dynamic HART variables and the current. ■ Command 9 Read out the dynamic HART variables including the related status. ■ Command 33 Read out the dynamic HART variables including the related unit. ■ Command 48 Read out the complete device diagnostics. <p><i>"Command 33" option</i></p> <p>The HART device variables are defined via Command 107.</p>

The following measured variables (HART device variables) can be read out:

- Mass flow
- Volume flow
- Corrected volume flow
- Target mass flow *
- Carrier mass flow *
- Density
- Reference density
- Concentration *
- Dynamic viscosity *
- Kinematic viscosity *
- Temp. compensated dynamic viscosity *
- Temp. compensated kinematic viscosity *
- Temperature
- Totalizer 1...3
- HBSI *
- Pressure
- HART input
- Percent of range
- Measured current
- Primary variable (PV)
- Secondary variable (SV)
- Tertiary variable (TV)
- Quaternary variable (QV)

Commands

-  ■ Information about the defined details of the command: HART specifications
- The measured variables (HART device variables) are assigned to the dynamic variables in the **Output** submenu (→  154).

Burst variable 0

Navigation	 Expert → Communication → HART output → Burst config. → Burst config. 1 to n → Burst variable 0 (2033)
Description	For HART command 9 and 33: select the HART device variable or the process variable.
Selection	<ul style="list-style-type: none"> ■ Mass flow ■ Volume flow ■ Corrected volume flow * ■ Density ■ Reference density * ■ Temperature ■ Totalizer 1 ■ Totalizer 2 ■ Totalizer 3 ■ GSV flow * ■ GSV flow alternative * ■ NSV flow * ■ NSV flow alternative * ■ S&W volume flow * ■ Reference density alternative *

* Visibility depends on order options or device settings

- Water cut *
- Oil density *
- Water density *
- Oil mass flow *
- Water mass flow *
- Oil volume flow *
- Water volume flow *
- Oil corrected volume flow *
- Water corrected volume flow *
- Target mass flow *
- Carrier mass flow *
- Concentration *
- Dynamic viscosity *
- Kinematic viscosity *
- Temp. compensated dynamic viscosity *
- Temp. compensated kinematic viscosity *
- Totalizer 1
- Totalizer 2
- Totalizer 3
- GSV flow *
- GSV flow alternative *
- NSV flow *
- NSV flow alternative *
- S&W volume flow *
- Reference density alternative *
- Water cut *
- Oil density *
- Water density *
- Oil mass flow *
- Water mass flow *
- Oil volume flow *
- Water volume flow *
- Oil corrected volume flow *
- Water corrected volume flow *
- Target volume flow *
- Carrier volume flow *
- Target corrected volume flow *
- Carrier corrected volume flow *
- HBSI *
- Sensor index coil asymmetry
- Test point 0
- Test point 1
- HART input
- Percent of range
- Measured current
- Primary variable (PV)
- Secondary variable (SV)
- Tertiary variable (TV)
- Quaternary variable (QV)
- Not used

Factory setting

Volume flow

Additional information*Selection*If a burst message is not configured, the **Not used** option is set.

* Visibility depends on order options or device settings

Burst variable 1



Navigation	Expert → Communication → HART output → Burst config. → Burst config. 1 to n → Burst variable 1 (2034)
Description	For HART command 9 and 33: select the HART device variable or the process variable.
Selection	See the Burst variable 0 parameter (→ 213).
Factory setting	Not used

Burst variable 2



Navigation	Expert → Communication → HART output → Burst config. → Burst config. 1 to n → Burst variable 2 (2035)
Description	For HART command 9 and 33: select the HART device variable or the process variable.
Selection	See the Burst variable 0 parameter (→ 213).
Factory setting	Not used

Burst variable 3



Navigation	Expert → Communication → HART output → Burst config. → Burst config. 1 to n → Burst variable 3 (2036)
Description	For HART command 9 and 33: select the HART device variable or the process variable.
Selection	See the Burst variable 0 parameter (→ 213).
Factory setting	Not used

Burst variable 4



Navigation	Expert → Communication → HART output → Burst config. → Burst config. 1 to n → Burst variable 4 (2037)
Description	For HART command 9: select the HART device variable or the process variable.
Selection	See the Burst variable 0 parameter (→ 213).
Factory setting	Not used

Burst variable 5



Navigation	Expert → Communication → HART output → Burst config. → Burst config. 1 to n → Burst variable 5 (2038)
Description	For HART command 9: select the HART device variable or the process variable.
Selection	See the Burst variable 0 parameter (→ 213).
Factory setting	Not used

Burst variable 6



Navigation	Expert → Communication → HART output → Burst config. → Burst config. 1 to n → Burst variable 6 (2039)
Description	For HART command 9: select the HART device variable or the process variable.
Selection	See the Burst variable 0 parameter (→ 213).
Factory setting	Not used

Burst variable 7







Navigation	Expert → Communication → HART output → Burst config. → Burst config. 1 to n → Burst variable 7 (2040)
Description	For HART command 9: select the HART device variable or the process variable.
Selection	See the Burst variable 0 parameter (→ 213).
Factory setting	Not used

Burst trigger mode





Navigation	Expert → Communication → HART output → Burst config. → Burst config. 1 to n → Trigger mode (2044-1 to n)
Description	Use this function to select the event that triggers burst message X.

Selection	<ul style="list-style-type: none"> ■ Continuous ■ Window* ■ Rising* ■ Falling* ■ On change
Factory setting	Continuous
Additional information	<p><i>Selection</i></p> <ul style="list-style-type: none"> ■ Continuous The message is sent continuously, at least at intervals corresponding to the time frame specified in the Burst min period parameter (→  217). ■ Window The message is sent if the specified measured value has changed by the value in the Burst trigger level parameter (→  217). ■ Rising The message is sent if the specified measured value exceeds the value in the Burst trigger level parameter (→  217). ■ Falling The message is sent if the specified measured value drops below the value in the Burst trigger level parameter (→  217). ■ On change The message is sent if a measured value changes in the burst message.



Burst trigger level



Navigation	  Expert → Communication → HART output → Burst config. → Burst config. 1 to n → Trigger level (2043-1 to n)
Description	For entering the burst trigger value.
User entry	Signed floating-point number
Additional information	<p><i>Description</i></p> <p>Together with the option selected in the Burst trigger mode parameter (→  216) the burst trigger value determines the time of burst message X.</p>

Min. update period



Navigation	  Expert → Communication → HART output → Burst config. → Burst config. 1 to n → Min. upd. per. (2042-1 to n)
Description	Use this function to enter the minimum time span between two burst commands of burst message X.
User entry	Positive integer

* Visibility depends on order options or device settings

Factory setting 1 000 ms

Max. update period

Navigation  Expert → Communication → HART output → Burst config. → Burst config. 1 to n
→ Max. upd. per. (2041–1 to n)











Description Use this function to enter the maximum time span between two burst commands of burst message X.

User entry Positive integer



Factory setting 2 000 ms

"Information" submenu



Navigation  Expert → Communication → HART output → Information

▶ Information	
Device revision (0204)	→  219
Device ID (0221)	→  219
Device type (0209)	→  219
Manufacturer ID (0259)	→  220
HART revision (0205)	→  220
HART descriptor (0212)	→  220
HART message (0216)	→  220
Hardware revision (0206)	→  221
Software revision (0224)	→  221
HART date code (0202)	→  221



Device revision

Navigation	 Expert → Communication → HART output → Information → Device revision (0204)
Description	Displays the device revision with which the device is registered with the HART Communication Foundation.
User interface	2-digit hexadecimal number
Factory setting	7
Additional information	<p><i>Description</i></p> <p> The device revision is needed to assign the appropriate device description file (DD) to the device.</p>

Device ID

Navigation	 Expert → Communication → HART output → Information → Device ID (0221)
Description	Use this function to view the device ID for identifying the measuring device in a HART network.
User interface	6-digit hexadecimal number
Additional information	<p><i>Description</i></p> <p> In addition to the device type and manufacturer ID, the device ID is part of the unique ID. Each HART device is uniquely identified by the unique device ID.</p>

Device type

Navigation	 Expert → Communication → HART output → Information → Device type (0209)
Description	Displays the device type with which the measuring device is registered with the HART Communication Foundation.
User interface	2-digit hexadecimal number
Factory setting	0x3B (for Promass 300/500)
Additional information	<p><i>Description</i></p> <p> The device type is specified by the manufacturer. It is needed to assign the appropriate device description file (DD) to the device.</p>

Manufacturer ID

Navigation	 Expert → Communication → HART output → Information → Manufacturer ID (0259)
Description	Use this function to view the manufacturer ID with which the measuring device is registered with the HART Communication Foundation.
User interface	2-digit hexadecimal number
Factory setting	0x11 (for Endress+Hauser)

HART revision

Navigation	 Expert → Communication → HART output → Information → HART revision (0205)
Description	Use this function to display the HART protocol revision of the measuring device.
User interface	5 to 7
Factory setting	7

HART descriptor



Navigation	 Expert → Communication → HART output → Information → HART descriptor (0212)
Description	Use this function to enter a description for the measuring point. This can be edited and displayed via HART protocol or using the local display.
User entry	Max. 16 characters such as letters, numbers or special characters (e.g. @, %, /)
Factory setting	Promass300/500

HART message



Navigation	 Expert → Communication → HART output → Information → HART message (0216)
Description	Use this function to enter a HART message which is sent via the HART protocol when requested by the master.
User entry	Max. 32 characters such as letters, numbers or special characters (e.g. @, %, /)
Factory setting	Promass300/500

Hardware revision

Navigation	Expert → Communication → HART output → Information → Hardware rev. (0206)
Description	Displays the hardware revision of the measuring device.
User interface	0 to 255
Factory setting	2

Software revision

Navigation	Expert → Communication → HART output → Information → Software rev. (0224)
Description	Displays the software revision of the measuring device.
User interface	0 to 255
Factory setting	7

HART date code









Navigation	Expert → Communication → HART output → Information → HART date code (0202)
Description	Use this function to enter the date information for individual use.
User entry	Date entry format: yyyy-mm-dd
Factory setting	2009-07-20
Additional information	<i>Example</i> Device installation date

"Output" submenu

Navigation Expert → Communication → HART output → Output

▶ **Output**

Assign PV (0234)	→ 222
Primary variable (PV) (0201)	→ 224

Assign SV (0235)	→  224
Secondary variable (SV) (0226)	→  226
Assign TV (0236)	→  226
Tertiary variable (TV) (0228)	→  228
Assign QV (0237)	→  228
Quaternary variable (QV) (0203)	→  230

Assign PV

Navigation

  Expert → Communication → HART output → Output → Assign PV (0234)

Description

Use this function to select a measured variable (HART device variable) for the primary dynamic variable (PV).

Selection

- Off *
- Mass flow
- Volume flow
- Corrected volume flow *
- Density
- Reference density *
- Temperature
- Pressure
- GSV flow *
- GSV flow alternative *
- NSV flow *
- NSV flow alternative *
- S&W volume flow *
- Reference density alternative *
- Water cut *
- Oil density *
- Water density *
- Oil mass flow *
- Water mass flow *
- Oil volume flow *
- Water volume flow *
- Oil corrected volume flow *
- Water corrected volume flow *
- Target mass flow *
- Carrier mass flow *
- Concentration *
- Dynamic viscosity *
- Kinematic viscosity *
- Temp. compensated dynamic viscosity *
- Temp. compensated kinematic viscosity *

* Visibility depends on order options or device settings

- GSV flow *
- GSV flow alternative *
- NSV flow *
- NSV flow alternative *
- S&W volume flow *
- Reference density alternative *
- Water cut *
- Oil density *
- Water density *
- Oil mass flow *
- Water mass flow *
- Oil volume flow *
- Water volume flow *
- Oil corrected volume flow *
- Water corrected volume flow *
- Target volume flow *
- Carrier volume flow *
- Target corrected volume flow *
- Carrier corrected volume flow *
- Application specific output 0 *
- Application specific output 1 *
- Inhomogeneous medium index
- Suspended bubbles index *
- Raw value mass flow
- Exciter current 0
- Oscillation damping 0
- Oscillation damping fluctuation 0 *
- Oscillation damping fluctuation 1 *
- Oscillation frequency 0
- Frequency fluctuation 0 *
- Signal asymmetry
- Torsion signal asymmetry *
- Carrier pipe temperature *
- Oscillation frequency 1 *
- Frequency fluctuation 0 *
- Oscillation amplitude 0 *
- Oscillation amplitude 1 *
- Frequency fluctuation 1 *
- Oscillation damping 1 *
- Exciter current 1 *
- HBSI *
- Electronics temperature
- Sensor index coil asymmetry
- Test point 0
- Test point 1

Factory setting

Mass flow





Additional information

Selection

 Detailed description of the options **Oscillation frequency**, **Oscillation amplitude**, **Oscillation damping** and **Signal asymmetry: Value 1 display** parameter (→  19)

* Visibility depends on order options or device settings

Primary variable (PV)

Navigation	 Expert → Communication → HART output → Output → Primary var (PV) (0201)
Description	Displays the current measured value of the primary dynamic variable (PV).
User interface	Signed floating-point number
Additional information	<p><i>User interface</i></p> <p>The measured value displayed depends on the process variable selected in the Assign PV parameter (→  222).</p> <p><i>Dependency</i></p> <p> The unit of the displayed measured value is taken from the System units submenu (→  89).</p>

Assign SV



Navigation	 Expert → Communication → HART output → Output → Assign SV (0235)
Description	Use this function to select a measured variable (HART device variable) for the secondary dynamic variable (SV).
Selection	<ul style="list-style-type: none"> ■ Mass flow ■ Volume flow ■ Corrected volume flow * ■ Density ■ Reference density * ■ Temperature ■ Totalizer 1 ■ Totalizer 2 ■ Totalizer 3 ■ GSV flow * ■ GSV flow alternative * ■ NSV flow * ■ NSV flow alternative * ■ S&W volume flow * ■ Reference density alternative * ■ Water cut * ■ Oil density * ■ Water density * ■ Oil mass flow * ■ Water mass flow * ■ Oil volume flow * ■ Water volume flow * ■ Oil corrected volume flow * ■ Water corrected volume flow * ■ Current input 1 * ■ Current input 2 * ■ Current input 3 *

* Visibility depends on order options or device settings

- Target mass flow *
- Carrier mass flow *
- Concentration *
- Dynamic viscosity *
- Kinematic viscosity *
- Temp. compensated dynamic viscosity *
- Temp. compensated kinematic viscosity *
- Totalizer 1
- Totalizer 2
- Totalizer 3
- GSV flow *
- GSV flow alternative *
- NSV flow *
- NSV flow alternative *
- S&W volume flow *
- Reference density alternative *
- Water cut *
- Oil density *
- Water density *
- Oil mass flow *
- Water mass flow *
- Oil volume flow *
- Water volume flow *
- Oil corrected volume flow *
- Water corrected volume flow *
- Current input 1 *
- Current input 2 *
- Current input 3 *
- Target volume flow *
- Carrier volume flow *
- Target corrected volume flow *
- Carrier corrected volume flow *
- Application specific output 0 *
- Application specific output 1 *
- Inhomogeneous medium index
- Suspended bubbles index *
- Raw value mass flow
- Exciter current 0
- Exciter current 1 *
- Oscillation damping 0
- Oscillation damping 1 *
- Oscillation damping fluctuation 0 *
- Oscillation damping fluctuation 1 *
- Oscillation frequency 0
- Oscillation frequency 1 *
- Frequency fluctuation 0 *
- Frequency fluctuation 1 *
- Oscillation amplitude 0 *
- Oscillation amplitude 1 *
- Signal asymmetry
- Torsion signal asymmetry *
- Carrier pipe temperature
- HBSI *
- Electronics temperature

* Visibility depends on order options or device settings

- Sensor index coil asymmetry
- Test point 0
- Test point 1

Factory setting

Totalizer 1

Secondary variable (SV)**Navigation**
 Expert → Communication → HART output → Output → Second.var(SV) (0226)
Description

Displays the current measured value of the secondary dynamic variable (SV).



User interface

Signed floating-point number

Additional information*User interface*

The measured value displayed depends on the process variable selected in the **Assign SV** parameter (→  224).

Dependency

 The unit of the displayed measured value is taken from the **System units** submenu (→  89).

Assign TV**Navigation**
 Expert → Communication → HART output → Output → Assign TV (0236)
Description

Use this function to select a measured variable (HART device variable) for the tertiary (third) dynamic variable (TV).

Selection

- Mass flow
- Volume flow
- Corrected volume flow *
- Density
- Reference density *
- Temperature
- Totalizer 1
- Totalizer 2
- Totalizer 3
- GSV flow *
- GSV flow alternative *
- NSV flow *
- NSV flow alternative *
- S&W volume flow *
- Reference density alternative *
- Water cut *
- Oil density *
- Water density *
- Oil mass flow *

* Visibility depends on order options or device settings

- Water mass flow^{*}
- Oil volume flow^{*}
- Water volume flow^{*}
- Oil corrected volume flow^{*}
- Water corrected volume flow^{*}
- Current input 1^{*}
- Current input 2^{*}
- Current input 3^{*}
- Target mass flow^{*}
- Carrier mass flow^{*}
- Concentration^{*}
- Dynamic viscosity^{*}
- Kinematic viscosity^{*}
- Temp. compensated dynamic viscosity^{*}
- Temp. compensated kinematic viscosity^{*}
- Totalizer 1
- Totalizer 2
- Totalizer 3
- GSV flow^{*}
- GSV flow alternative^{*}
- NSV flow^{*}
- NSV flow alternative^{*}
- S&W volume flow^{*}
- Reference density alternative^{*}
- Water cut^{*}
- Oil density^{*}
- Water density^{*}
- Oil mass flow^{*}
- Water mass flow^{*}
- Oil volume flow^{*}
- Water volume flow^{*}
- Oil corrected volume flow^{*}
- Water corrected volume flow^{*}
- Current input 1^{*}
- Current input 2^{*}
- Current input 3^{*}
- Target volume flow^{*}
- Carrier volume flow^{*}
- Target corrected volume flow^{*}
- Carrier corrected volume flow^{*}
- Application specific output 0^{*}
- Application specific output 1^{*}
- Inhomogeneous medium index
- Suspended bubbles index^{*}
- Raw value mass flow
- Exciter current 0
- Exciter current 1^{*}
- Oscillation damping 0
- Oscillation damping 1^{*}
- Oscillation damping fluctuation 0^{*}
- Oscillation damping fluctuation 1^{*}
- Oscillation frequency 0
- Oscillation frequency 1^{*}
- Frequency fluctuation 0^{*}
- Frequency fluctuation 1^{*}
- Oscillation amplitude 0^{*}

* Visibility depends on order options or device settings

- Oscillation amplitude 1 *
- Signal asymmetry
- Torsion signal asymmetry *
- Carrier pipe temperature *
- HBSI *
- Electronics temperature
- Sensor index coil asymmetry
- Test point 0
- Test point 1

Factory setting

Totalizer 2

Tertiary variable (TV)**Navigation**
 Expert → Communication → HART output → Output → Tertiary var(TV) (0228)
Description

Displays the current measured value of the tertiary dynamic variable (TV).



User interface

Signed floating-point number

Additional information*User interface*

The measured value displayed depends on the process variable selected in the **Assign TV** parameter (→  226).

Dependency

 The unit of the displayed measured value is taken from the **System units** submenu (→  89).

Assign QV**Navigation**
 Expert → Communication → HART output → Output → Assign QV (0237)
Description

Use this function to select a measured variable (HART device variable) for the quaternary (fourth) dynamic variable (QV).

Selection

- Mass flow
- Volume flow
- Corrected volume flow *
- Density
- Reference density *
- Temperature
- Totalizer 1
- Totalizer 2
- Totalizer 3
- GSV flow *
- GSV flow alternative *
- NSV flow *
- NSV flow alternative *

* Visibility depends on order options or device settings

- S&W volume flow *
- Reference density alternative *
- Water cut *
- Oil density *
- Water density *
- Oil mass flow *
- Water mass flow *
- Oil volume flow *
- Water volume flow *
- Oil corrected volume flow *
- Water corrected volume flow *
- Current input 1 *
- Current input 2 *
- Current input 3 *
- Target mass flow *
- Carrier mass flow *
- Concentration *
- Dynamic viscosity *
- Kinematic viscosity *
- Temp. compensated dynamic viscosity *
- Temp. compensated kinematic viscosity *
- Totalizer 1
- Totalizer 2
- Totalizer 3
- GSV flow *
- GSV flow alternative *
- NSV flow *
- NSV flow alternative *
- S&W volume flow *
- Reference density alternative *
- Water cut *
- Oil density *
- Water density *
- Oil mass flow *
- Water mass flow *
- Oil volume flow *
- Water volume flow *
- Oil corrected volume flow *
- Water corrected volume flow *
- Current input 1 *
- Current input 2 *
- Current input 3 *
- Target volume flow *
- Carrier volume flow *
- Target corrected volume flow *
- Carrier corrected volume flow *
- Application specific output 0 *
- Application specific output 1 *
- Inhomogeneous medium index
- Suspended bubbles index *
- Raw value mass flow
- Exciter current 0
- Exciter current 1 *
- Oscillation damping 0
- Oscillation damping 1 *
- Oscillation damping fluctuation 0 *

* Visibility depends on order options or device settings

- Oscillation damping fluctuation 1 *
- Oscillation frequency 0
- Oscillation frequency 1 *
- Frequency fluctuation 0 *
- Frequency fluctuation 1 *
- Oscillation amplitude 0 *
- Oscillation amplitude 1 *
- Signal asymmetry
- Torsion signal asymmetry *
- Carrier pipe temperature *
- HBSI *
- Electronics temperature
- Sensor index coil asymmetry
- Test point 0
- Test point 1

Factory setting

Totalizer 3

Quaternary variable (QV)**Navigation**
 Expert → Communication → HART output → Output → Quaterna.var(QV) (0203)
Description

Displays the current measured value of the quaternary dynamic variable (QV).



User interface

Signed floating-point number



Additional information*User interface*

The measured value displayed depends on the process variable selected in the **Assign QV** parameter (→  228).

Dependency

 The unit of the displayed measured value is taken from the **System units** submenu (→  89).

3.6.3 "Diagnostic configuration" submenu

 For a list of all the diagnostic events, see the Operating Instructions for the device (→  7)

Assign a category to the particular diagnostic event:

















Category	Meaning
Failure (F)	A device error is present. The measured value is no longer valid.
Function check (C)	The device is in service mode (e.g. during a simulation).













* Visibility depends on order options or device settings

Category	Meaning
Out of specification (S)	The device is being operated: <ul style="list-style-type: none"> ▪ Outside its technical specification limits (e.g. outside the process temperature range) ▪ Outside of the configuration carried out by the user (e.g. maximum flow in parameter 20 mA value)
Maintenance required (M)	Maintenance is required. The measured value is still valid.
No effect (N)	Has no effect on the condensed status ¹⁾ .

1) Condensed status according to NAMUR recommendation NE107

Navigation  Expert → Communication → Diag. config.

► Diagnostic configuration	
Event category 046 (0246)	→  232
Event category 142 (0280)	→  233
Event category 140 (0244)	→  233
Event category 144 (0303)	→  233
Event category 374 (0245)	→  234
Event category 304 (0283)	→  234
Event category 441 (0210)	→  234
Event category 442 (0230)	→  235
Event category 443 (0231)	→  235
Event category 444 (0211)	→  236
Event category 543 (0276)	→  236
Event category 599 (0279)	→  236
Event category 830 (0240)	→  237
Event category 831 (0241)	→  237
Event category 832 (0218)	→  238
Event category 833 (0225)	→  238
Event category 834 (0227)	→  238

Event category 835 (0229)	→  239
Event category 842 (0295)	→  239
Event category 862 (0214)	→  240
Event category 912 (0243)	→  240
Event category 913 (0242)	→  240
Event category 915 (0282)	→  241
Event category 941 (0294)	→  241
Event category 942 (0302)	→  241
Event category 943 (0301)	→  242
Event category 944 (0304)	→  242
Event category 948 (0275)	→  242
Event category 984 (0278)	→  243

Event category 046 (Sensor limit exceeded)



Navigation

 Expert → Communication → Diag. config. → Event category 046 (0246)

Description

Use this function to select a category for the **046 Sensor limit exceeded** diagnostic message.

Selection

- Failure (F)
- Function check (C)
- Out of specification (S)
- Maintenance required (M)
- No effect (N)

Factory setting

Out of specification (S)

Additional information

 For a detailed description of the event categories available for selection: →  230

Event category 142 (Sensor index coil asymmetry too high)



Navigation	Expert → Communication → Diag. config. → Event category 142 (0280)
Description	Select category for diagnostic message.
Selection	<ul style="list-style-type: none"> ■ Failure (F) ■ Function check (C) ■ Out of specification (S) ■ Maintenance required (M) ■ No effect (N)
Factory setting	No effect (N)
Additional information	For a detailed description of the event categories available for selection: → 230

Event category 140 (Sensor signal asymmetrical)



Navigation	Expert → Communication → Diag. config. → Event category 140 (0244)
Description	Use this function to select a category for the 140 Sensor signal asymmetrical diagnostic message.
Selection	<ul style="list-style-type: none"> ■ Failure (F) ■ Function check (C) ■ Out of specification (S) ■ Maintenance required (M) ■ No effect (N)
Factory setting	Out of specification (S)
Additional information	For a detailed description of the event categories available for selection: → 230

Event category 144 (Measurement error too high)

Navigation	Expert → Communication → Diag. config. → Event category 144 (0303)
Description	Select category for diagnostic message.
Selection	<ul style="list-style-type: none"> ■ Failure (F) ■ Function check (C) ■ Out of specification (S) ■ Maintenance required (M) ■ No effect (N)
Factory setting	Out of specification (S)

Additional information  For a detailed description of the event categories available for selection: →  230

Event category 374 (Main electronic failure)



Navigation  Expert → Communication → Diag. config. → Event category 374 (0245)

Description Use this function to assign a category to the diagnostic message "374 Sensor electronics (ISEM) faulty".

Selection

- Failure (F)
- Function check (C)
- Out of specification (S)
- Maintenance required (M)
- No effect (N)

Factory setting Out of specification (S)

Additional information  For a detailed description of the event categories available for selection: →  230

Event category 304 (Device verification failed)



Navigation  Expert → Communication → Diag. config. → Event category 304 (0283)

Description Select category for diagnostic message.

Selection

- Failure (F)
- Function check (C)
- Out of specification (S)
- Maintenance required (M)
- No effect (N)



Factory setting Failure (F)

Additional information  For a detailed description of the event categories available for selection: →  230



Event category 441 (Current output 1 to n)

Navigation  Expert → Communication → Diag. config. → Event category 441 (0210)



Description Use this function to select a category for the **441 Current output 1 to n** diagnostic message.

Selection	<ul style="list-style-type: none"> ■ Failure (F) ■ Function check (C) ■ Out of specification (S) ■ Maintenance required (M) ■ No effect (N)
Factory setting	Out of specification (S)
Additional information	 For a detailed description of the event categories available for selection: →  230

Event category 442 (Frequency output 1 to n)

Navigation	 Expert → Communication → Diag. config. → Event category 442 (0230)
Prerequisite	The pulse/frequency/switch output is available.
Description	Use this function to select a category for the 442 Frequency output 1 to n diagnostic message.
Selection	<ul style="list-style-type: none"> ■ Failure (F) ■ Function check (C) ■ Out of specification (S) ■ Maintenance required (M) ■ No effect (N)
Factory setting	Out of specification (S)
Additional information	 For a detailed description of the event categories available for selection: →  230

Event category 443 (Pulse output 1 to n)

Navigation	 Expert → Communication → Diag. config. → Event category 443 (0231)
Prerequisite	The pulse/frequency/switch output is available.
Description	Use this function to select a category for the 443 Pulse output 1 to n diagnostic message.
Selection	<ul style="list-style-type: none"> ■ Failure (F) ■ Function check (C) ■ Out of specification (S) ■ Maintenance required (M) ■ No effect (N)
Factory setting	Out of specification (S)
Additional information	 For a detailed description of the event categories available for selection: →  230

Event category 444 (Current input 1 to n)



Navigation	Expert → Communication → Diag. config. → Event category 444 (0211)
Prerequisite	The current input is available.
Description	Use this function to select a category for the 444 Current input 1 to n diagnostic message.
Selection	<ul style="list-style-type: none">■ Failure (F)■ Function check (C)■ Out of specification (S)■ Maintenance required (M)■ No effect (N)
Factory setting	Out of specification (S)
Additional information	<i>Selection</i> For a detailed description of the event categories available for selection: → 230

Event category 543 (Double pulse output)



Navigation	Expert → Communication → Diag. config. → Event category 543 (0276)
Description	Use this option to select a category for the 543 Double pulse output diagnostic message.
Selection	<ul style="list-style-type: none">■ Failure (F)■ Function check (C)■ Out of specification (S)■ Maintenance required (M)■ No effect (N)
Factory setting	Out of specification (S)
Additional information	For a detailed description of the event categories available for selection: → 230



Event category 599 (Custody transfer logbook full)



Navigation	Expert → Communication → Diag. config. → Event category 599 (0279)
Description	Select category for diagnostic message.
Selection	<ul style="list-style-type: none">■ Failure (F)■ Function check (C)■ Out of specification (S)■ Maintenance required (M)■ No effect (N)

Factory setting Out of specification (S)

Additional information *Selection*

 For a detailed description of the event categories available for selection: →  230

Event category 830 (Sensor temperature too high)



Navigation  Expert → Communication → Diag. config. → Event category 830 (0240)

Description Use this function to select a category for the **830 Sensor temperature too high** diagnostic message.

Selection

- Failure (F)
- Function check (C)
- Out of specification (S)
- Maintenance required (M)
- No effect (N)

Factory setting Out of specification (S)

Additional information  For a detailed description of the event categories available for selection: →  230

Event category 831 (Sensor temperature too low)



Navigation  Expert → Communication → Diag. config. → Event category 831 (0241)

Description Use this function to select a category for the **831 Sensor temperature too low** diagnostic message.

Selection

- Failure (F)
- Function check (C)
- Out of specification (S)
- Maintenance required (M)
- No effect (N)

Factory setting Out of specification (S)

Additional information  For a detailed description of the event categories available for selection: →  230

Event category 832 (Electronics temperature too high)

Navigation	Expert → Communication → Diag. config. → Event category 832 (0218)
Description	Use this function to select a category for the 832 Electronics temperature too high diagnostic message.
Selection	<ul style="list-style-type: none"> ■ Failure (F) ■ Function check (C) ■ Out of specification (S) ■ Maintenance required (M) ■ No effect (N)
Factory setting	Out of specification (S)
Additional information	<i>Selection</i> For a detailed description of the event categories available for selection: → 230

Event category 833 (Electronics temperature too low)

Navigation	Expert → Communication → Diag. config. → Event category 833 (0225)
Description	Use this option to select a category for the 833 Electronics temperature too low diagnostic message.
Selection	<ul style="list-style-type: none"> ■ Failure (F) ■ Function check (C) ■ Out of specification (S) ■ Maintenance required (M) ■ No effect (N)
Factory setting	Out of specification (S)
Additional information	<i>Selection</i> For a detailed description of the event categories available for selection: → 230

Event category 834 (Process temperature too high)

Navigation	Expert → Communication → Diag. config. → Event category 834 (0227)
Description	Use this option to select a category for the 834 Process temperature too high diagnostic message.

- Selection**
- Failure (F)
 - Function check (C)
 - Out of specification (S)
 - Maintenance required (M)
 - No effect (N)

Factory setting Out of specification (S)

Additional information *Selection*



For a detailed description of the event categories available for selection: → 230

Event category 835 (Process temperature too low)

Navigation Expert → Communication → Diag. config. → Event category 835 (0229)

Description Use this option to select a category for the **835 Process temperature too low** diagnostic message.

- Selection**
- Failure (F)
 - Function check (C)
 - Out of specification (S)
 - Maintenance required (M)
 - No effect (N)

Factory setting Out of specification (S)

Additional information *Selection*



For a detailed description of the event categories available for selection: → 230

Event category 842 (Process value above limit)

Navigation Expert → Communication → Diag. config. → Event category 842 (0295)



Description Change status signal of diagnostic event with diagnostic number 842 'Process limit'.

- Selection**
- Failure (F)
 - Function check (C)
 - Out of specification (S)
 - Maintenance required (M)
 - No effect (N)

Factory setting Out of specification (S)



Event category 862 (Empty pipe)



Navigation	 Expert → Communication → Diag. config. → Event category 862 (0214)
Description	Use this option to select a category for the 862 Empty pipe diagnostic message.
Selection	<ul style="list-style-type: none">■ Failure (F)■ Function check (C)■ Out of specification (S)■ Maintenance required (M)■ No effect (N)
Factory setting	Out of specification (S)
Additional information	 For a detailed description of the event categories available for selection: →  230

Event category 912 (Medium inhomogeneous)



Navigation	 Expert → Communication → Diag. config. → Event category 912 (0243)
Description	Use this function to select a category for the 912 Medium inhomogeneous diagnostic message.
Selection	<ul style="list-style-type: none">■ Failure (F)■ Function check (C)■ Out of specification (S)■ Maintenance required (M)■ No effect (N)
Factory setting	Out of specification (S)
Additional information	 For a detailed description of the event categories available for selection: →  230

Event category 913 (Medium unsuitable)



Navigation	 Expert → Communication → Diag. config. → Event category 913 (0242)
Description	Use this function to select a category for the 913 Medium unsuitable diagnostic message.
Selection	<ul style="list-style-type: none">■ Failure (F)■ Function check (C)■ Out of specification (S)■ Maintenance required (M)■ No effect (N)
Factory setting	Out of specification (S)

Additional information  For a detailed description of the event categories available for selection: →  230

Event category 915 (Viscosity out of specification)



Navigation  Expert → Communication → Diag. config. → Event category 915 (0282)

Description Select category for diagnostic message.

Selection

- Failure (F)
- Function check (C)
- Out of specification (S)
- Maintenance required (M)
- No effect (N)

Factory setting No effect (N)

Additional information  For a detailed description of the event categories available for selection: →  230

Event category 941 (API/ASTM temperature out of specificat.)

Navigation  Expert → Communication → Diag. config. → Event category 941 (0294)

Description Select category for diagnostic message.

Selection

- Failure (F)
- Function check (C)
- Out of specification (S)
- Maintenance required (M)
- No effect (N)

Factory setting Out of specification (S)

Additional information  For a detailed description of the event categories available for selection: →  230

Event category 942 (API/ASTM density out of specification)



Navigation  Expert → Communication → Diag. config. → Event category 942 (0302)

Description Select category for diagnostic message.

Selection

- Failure (F)
- Function check (C)
- Out of specification (S)
- Maintenance required (M)
- No effect (N)

Factory setting Out of specification (S)

Additional information  For a detailed description of the event categories available for selection: →  230

Event category 943 (API pressure out of specification)



Navigation  Expert → Communication → Diag. config. → Event category 943 (0301)

Description Select category for diagnostic message.

Selection

- Failure (F)
- Function check (C)
- Out of specification (S)
- Maintenance required (M)
- No effect (N)

Factory setting Out of specification (S)

Additional information  For a detailed description of the event categories available for selection: →  230

Event category 944 (Monitoring failed)



Navigation  Expert → Communication → Diag. config. → Event category 944 (0304)

Description Select category for diagnostic message.

Selection

- Failure (F)
- Function check (C)
- Out of specification (S)
- Maintenance required (M)
- No effect (N)



Factory setting Out of specification (S)

Additional information  For a detailed description of the event categories available for selection: →  230

Event category 948 (Tube damping too high)



Navigation  Expert → Communication → Diag. config. → Event category 948 (0275)

Description Use this function to assign a category to the **948 Tube damping too high** diagnostic message.



Selection	<ul style="list-style-type: none"> ■ Failure (F) ■ Function check (C) ■ Out of specification (S) ■ Maintenance required (M) ■ No effect (N)
Factory setting	Out of specification (S)
Additional information	 For a detailed description of the event categories available for selection: →  230

Event category 984 (Condensation risk)











Navigation	 Expert → Communication → Diag. config. → Event category 984 (0278)
Description	Select category for diagnostic message.
Selection	<ul style="list-style-type: none"> ■ Failure (F) ■ Function check (C) ■ Out of specification (S) ■ Maintenance required (M) ■ No effect (N)
Factory setting	Out of specification (S)
Additional information	 For a detailed description of the event categories available for selection: →  230

3.6.4 "Web server" submenu



Navigation   Expert → Communication → Web server

▶ **Web server**

Web server language (7221)	→  244
MAC address (7214)	→  244
DHCP client (7212)	→  245
IP address (7209)	→  245
Subnet mask (7211)	→  245
Default gateway (7210)	→  246

Web server functionality (7222)	→  246
Login page (7273)	→  246

Web server language

Navigation   Expert → Communication → Web server → Webserv.language (7221)

Description Use this function to select the language configured for the Web server.

Selection

- English
- Deutsch
- Français
- Español
- Italiano
- Nederlands
- Portuguesa
- Polski
- русский язык (Russian)
- Svenska
- Türkçe
- 中文 (Chinese)
- 日本語 (Japanese)
- 한국어 (Korean)
- tiếng Việt (Vietnamese)
- čeština (Czech)

Factory setting English

MAC address

Navigation   Expert → Communication → Web server → MAC Address (7214)

Description Displays the MAC⁸⁾ address of the measuring device.

User interface Unique 12-digit character string comprising letters and numbers

Factory setting Each measuring device is given an individual address.

Additional information *Example*
For the display format
00:07:05:10:01:5F

8) Media Access Control

DHCP client



Navigation	Expert → Communication → Web server → DHCP client (7212)
Description	Use this function to activate and deactivate the DHCP client functionality.
Selection	<ul style="list-style-type: none"> ▪ Off ▪ On
Factory setting	On
Additional information	<p><i>Effect</i></p> <p>If the DHCP client functionality of the web server is selected, the IP address (→ 245), Subnet mask (→ 245) and Default gateway (→ 246) are set automatically.</p> <ul style="list-style-type: none"> Identification is via the MAC address of the measuring device. ▪ The IP address (→ 245) in the IP address parameter (→ 245) is ignored as long as the DHCP client parameter (→ 245) is active. This is also the case, in particular, if the DHCP server cannot be reached. The IP address (→ 245) in the parameter of the same name is only used if the DHCP client parameter (→ 245) is inactive.

IP address







Navigation	Expert → Communication → Web server → IP address (7209)
Description	Display or enter the IP address of the Web server integrated in the measuring device.
User entry	4 octet: 0 to 255 (in the particular octet)
Factory setting	192.168.1.212

Subnet mask





Navigation	Expert → Communication → Web server → Subnet mask (7211)
Description	Display or enter the subnet mask.
User entry	4 octet: 0 to 255 (in the particular octet)
Factory setting	255.255.255.0

Default gateway



Navigation	  Expert → Communication → Web server → Default gateway (7210)
Description	Display or enter the Default gateway (→  246).
User entry	4 octet: 0 to 255 (in the particular octet)
Factory setting	0.0.0.0



Web server functionality

Navigation	  Expert → Communication → Web server → Webserver funct. (7222)
Description	Use this function to switch the Web server on and off.
Selection	<ul style="list-style-type: none"> ▪ Off ▪ HTML Off ▪ On
Factory setting	On
Additional information	<p><i>Description</i></p> <p> Once disabled, the Web server functionality can only be enabled again via the local display, the FieldCare operating tool or the DeviceCare operating tool.</p>

Selection

Option	Description
Off	<ul style="list-style-type: none"> ▪ The Web server is completely disabled. ▪ Port 80 is locked.
HTML Off	The HTML version of the Web server is not available.
On	<ul style="list-style-type: none"> ▪ The complete Web server functionality is available. ▪ JavaScript is used. ▪ The password is transferred in an encrypted state. ▪ Any change to the password is also transferred in an encrypted state.

Login page





















Navigation	  Expert → Communication → Web server → Login page (7273)
Description	Use this function to select the format of the login page.
Selection	<ul style="list-style-type: none"> ▪ Without header ▪ With header



Factory setting

With header



3.6.5 "WLAN settings" wizard

Navigation  Expert → Communication → WLAN settings



▶ WLAN settings	
WLAN (2702)	→  248
WLAN mode (2717)	→  248
SSID name (2714)	→  248
Network security (2705)	→  249
Security identification (2718)	→  249
User name (2715)	→  249
WLAN password (2716)	→  250
WLAN IP address (2711)	→  250
WLAN MAC address (2703)	→  250
WLAN subnet mask (2709)	→  251
WLAN MAC address (2703)	→  250
WLAN passphrase (2706)	→  251
WLAN MAC address (2703)	→  250
Assign SSID name (2708)	→  251
SSID name (2707)	→  252
2.4 GHz WLAN channel (2704)	→  252
Select antenna (2713)	→  252
Connection state (2722)	→  252
Received signal strength (2721)	→  253

WLAN IP address (2711)	→  250
Gateway IP address (2719)	→  253
IP address domain name server (2720)	→  253



WLAN

Navigation	  Expert → Communication → WLAN settings → WLAN (2702)
Description	Use this function to enable and disable the WLAN connection.
Selection	<ul style="list-style-type: none"> ■ Disable ■ Enable
Factory setting	Enable

WLAN mode

Navigation	  Expert → Communication → WLAN settings → WLAN mode (2717)
Description	Use this function to select the WLAN mode.
Selection	<ul style="list-style-type: none"> ■ WLAN access point ■ WLAN Client
Factory setting	WLAN access point

SSID name

Navigation	  Expert → Communication → WLAN settings → SSID name (2714)
Prerequisite	The client is activated.
Description	Use this function to enter the user-defined SSID name (max. 32 characters) of the WLAN network.
User entry	–
Factory setting	–

Network security

Navigation	Expert → Communication → WLAN settings → Network security (2705)
Description	Use this function to select the type of security for the WLAN interface.
Selection	<ul style="list-style-type: none"> ■ Unsecured ■ WPA2-PSK ■ EAP-PEAP with MSCHAPv2 * ■ EAP-PEAP MSCHAPv2 no server authentic. * ■ EAP-TLS *
Factory setting	WPA2-PSK
Additional information	<p><i>Selection</i></p> <ul style="list-style-type: none"> ■ Unsecured Access the WLAN connection without identification. ■ WPA2-PSK Access the WLAN connection with a network key. ■ EAP-PEAP with MSCHAPv2 Access the WLAN connection with a password-based authentication protocol. ■ EAP-PEAP MSCHAPv2 no server authentic. Access the WLAN connection with a password-based protocol without server authentication. ■ EAP-TLS Access the WLAN connection with a certificate-based, two-way authentication of the client and network.

Security identification

Navigation	Expert → Communication → WLAN settings → Sec. identific. (2718)
Description	Use this function to select the security settings (download via the menu: Data Management > Security > Download WLAN).
User interface	<ul style="list-style-type: none"> ■ Trusted issuer certificate ■ Device certificate ■ Device private key



User name

Navigation	Expert → Communication → WLAN settings → User name (2715)
Description	Use this function to enter the username of the WLAN network.
User entry	–

* Visibility depends on order options or device settings

Factory setting –

WLAN password



Navigation   Expert → Communication → WLAN settings → WLAN password (2716)

Description Use this function to enter the WLAN password for the WLAN network.

User entry –

Factory setting –

WLAN IP address

Navigation   Expert → Communication → WLAN settings → WLAN IP address (2711)

Description Use this function to enter the IP address of the measuring device's WLAN connection.

User entry 4 octet: 0 to 255 (in the particular octet)

Factory setting 192.168.1.212

WLAN MAC address

Navigation   Expert → Communication → WLAN settings → WLAN MAC address (2703)







Description Displays the MAC ⁹⁾ address of the measuring device.

User interface Unique 12-digit character string comprising letters and numbers

Factory setting Each measuring device is given an individual address.

Additional information *Example*
For the display format
00:07:05:10:01:5F

9) Media Access Control

WLAN subnet mask	
Navigation	  Expert → Communication → WLAN settings → WLAN subnet mask (2709)
Description	Use this function to enter the subnet mask.
User entry	4 octet: 0 to 255 (in the particular octet)
Factory setting	255.255.255.0
WLAN passphrase	
Navigation	  Expert → Communication → WLAN settings → WLAN passphrase (2706)
Prerequisite	The WPA2-PSK option is selected in the Security type parameter (→  249).
Description	Use this function to enter the network key.
User entry	8 to 32-digit character string comprising numbers, letters and special characters (without spaces)
Factory setting	Serial number of the measuring device (e.g. L100A802000)
Assign SSID name	
Navigation	  Expert → Communication → WLAN settings → Assign SSID name (2708)
Description	Use this function to select which name is used for the SSID ¹⁰⁾ .
Selection	<ul style="list-style-type: none"> ▪ Device tag ▪ User-defined
Factory setting	User-defined
Additional information	<p><i>Selection</i></p> <ul style="list-style-type: none"> ▪ Device tag The device tag name is used as the SSID. ▪ User-defined A user-defined name is used as the SSID.

10) Service Set Identifier

SSID name	
Navigation	Expert → Communication → WLAN settings → SSID name (2707)
Prerequisite	<ul style="list-style-type: none"> ▪ The User-defined option is selected in the Assign SSID name parameter (→ 251). ▪ The WLAN access point option is selected in the WLAN mode parameter (→ 248).
Description	Use this function to enter a user-defined SSID name.
User entry	Max. 32-digit character string comprising numbers, letters and special characters
Factory setting	EH_device designation_last 7 digits of the serial number (e.g. EH_Promass_300_A802000)

2.4 GHz WLAN channel	
Navigation	Expert → Communication → WLAN settings → WLAN channel (2704)
Description	Use this function to enter the 2.4 GHz WLAN channel.
User entry	1 to 11
Factory setting	6
Additional information	<p><i>Description</i></p> <p> ▪ It is only necessary to enter a 2.4 GHz WLAN channel if multiple WLAN devices are in use.</p> <p>▪ If just one measuring device is in use, it is recommended to keep the factory setting.</p>

Select antenna	
Navigation	Expert → Communication → WLAN settings → Select antenna (2713)
Description	Use this function to select whether the external or internal antenna is used for reception.
Selection	<ul style="list-style-type: none"> ▪ External antenna ▪ Internal antenna
Factory setting	Internal antenna

Connection state	
Navigation	Expert → Communication → WLAN settings → Connection state (2722)
Description	The connection status is displayed.

User interface ▪ Connected
 ▪ Not connected

Factory setting Not connected

Received signal strength

Navigation  Expert → Communication → WLAN settings → Rec.sig.strength (2721)

Description Displays the signal strength received.

User interface ▪ Low
 ▪ Medium
 ▪ High

Factory setting High

Gateway IP address

Navigation  Expert → Communication → WLAN settings → Gateway IP addr. (2719)

Description Use this function to enter the IP address of the gateway.

User interface Character string comprising numbers, letters and special characters

Factory setting 192.168.1.212

IP address domain name server

Navigation  Expert → Communication → WLAN settings → IP address DNS (2720)

Description Use this function to enter the IP address of the domain name server.

User interface Character string comprising numbers, letters and special characters

Factory setting 192.168.1.212

3.6.6 "OPC-UA configuration" submenu



For detailed information on the parameter descriptions for the **OPC-UA server** application package, refer to the Special Documentation for the device →  7

Navigation  Expert → Communication → OPC-UA config.



3.7 "Application" submenu

Navigation   Expert → Application

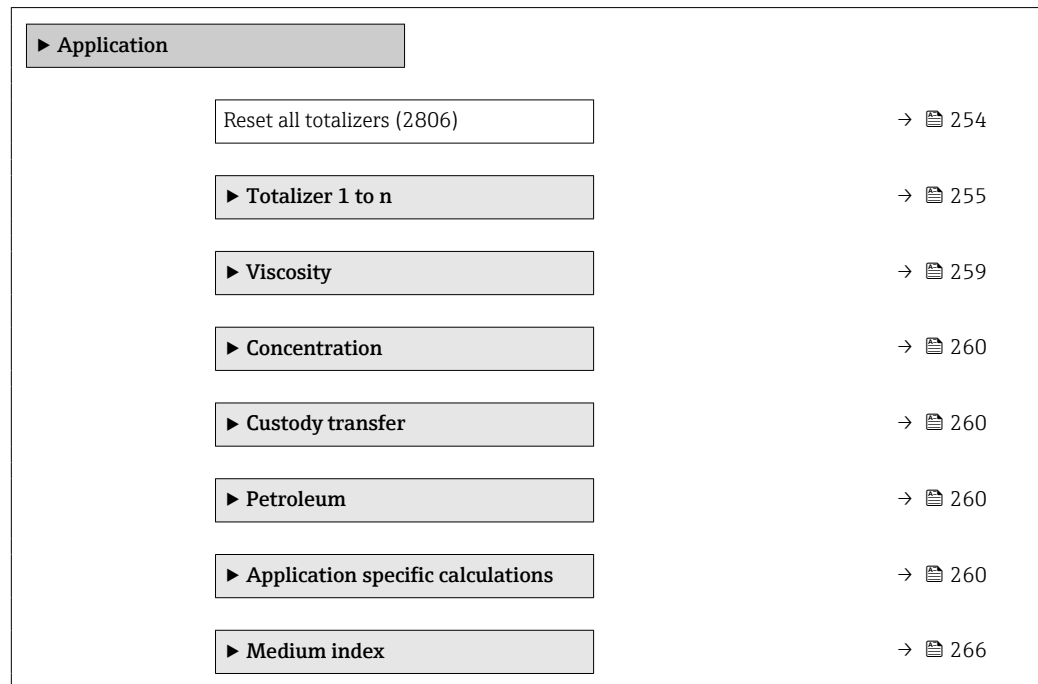

Reset all totalizers

Navigation   Expert → Application → Reset all tot. (2806)

Description Use this function to reset all totalizers to the value **0** and restart the totaling process. This deletes all the flow values previously totalized.

Selection

- Cancel
- Reset + totalize







Factory setting Cancel

Additional information *Selection*

Options	Description
Cancel	No action is executed and the user exits the parameter.
Reset + totalize	Resets all totalizers to 0 and restarts the totaling process. This deletes all the flow values previously totalized.

3.7.1 "Totalizer 1 to n" submenu

Navigation  Expert → Application → Totalizer 1 to n

► Totalizer 1 to n	
Assign process variable (0914-1 to n)	→  255
Unit totalizer 1 to n (0915-1 to n)	→  256
Totalizer operation mode (0908-1 to n)	→  257
Control Totalizer 1 to n (0912-1 to n)	→  258
Preset value 1 to n (0913-1 to n)	→  258
Failure mode (0901-1 to n)	→  259

Assign process variable

Navigation  Expert → Application → Totalizer 1 to n → Assign variable (0914-1 to n)

Description Use this function to select a process variable for the Totalizer 1 to n.

- Selection
- Off
 - Mass flow
 - Volume flow
 - Corrected volume flow *
 - Target mass flow *
 - Carrier mass flow *
 - Target volume flow *
 - Carrier volume flow *
 - Target corrected volume flow *
 - Carrier corrected volume flow *
 - GSV flow *
 - GSV flow alternative *
 - NSV flow *
 - NSV flow alternative *
 - S&W volume flow *
 - Oil mass flow *
 - Water mass flow *
 - Oil volume flow *
 - Water volume flow *
 - Oil corrected volume flow *
 - Water corrected volume flow *
 - Raw value mass flow

Factory setting Mass flow

* Visibility depends on order options or device settings

Additional information *Description*

 If the option selected is changed, the device resets the totalizer to 0.

Selection

If the **Off** option is selected, only the **Assign process variable** parameter (→  255) is still displayed in the **Totalizer 1 to n** submenu. All other parameters in the submenu are hidden.

Unit totalizer 1 to n**Navigation**

 Expert → Application → Totalizer 1 to n → Unit totalizer 1 to n (0915-1 to n)

Prerequisite

A process variable is selected in the **Assign process variable** parameter (→  255) of the **Totalizer 1 to n** submenu.

Description

Use this function to select the process variable unit for the Totalizer 1 to n (→  255).

Selection*SI units*

- g^{*}
- kg^{*}
- t^{*}

US units

- oz^{*}
- lb^{*}
- STon^{*}

* Visibility depends on order options or device settings

or

SI units

- cm³^{*}
- dm³^{*}
- m³^{*}
- ml^{*}
- l^{*}
- hl^{*}
- Ml Mega^{*}

US units

- af^{*}
- ft³^{*}
- Mft³^{*}
- Mft³^{*}
- fl oz (us)^{*}
- gal (us)^{*}
- kgal (us)^{*}
- Mgal (us)^{*}
- bbl (us;oil)^{*}
- bbl (us;tank)^{*}

Imperial units

- gal (imp)^{*}
- Mgal (imp)^{*}
- bbl (imp;oil)^{*}

* Visibility depends on order options or device settings

or

US units

- bbl (us;liq.)^{*}
- bbl (us;beer)^{*}

Imperial units

- bbl (imp;beer)^{*}

* Visibility depends on order options or device settings

or

SI units

- Nl^{*}
- Nhl^{*}
- Nm³^{*}
- Sl^{*}
- Sm³^{*}

US units

- Sft³^{*}
- MSft³^{*}
- MMSft³^{*}
- Sgal (us)^{*}
- Sdbl (us;liq.)^{*}
- Sdbl (us;oil)^{*}

Imperial units

- Sgal (imp)^{*}

* Visibility depends on order options or device settings

or

Other units

- None^{*}

* Visibility depends on order options or device settings



Factory setting

Depends on country:

- kg
- lb

Additional information

Description

 The unit is selected separately for each totalizer. It is independent of the selection made in the **System units** submenu (→  89).

Selection

The selection is dependent on the process variable selected in the **Assign process variable** parameter (→  255).

Totalizer operation mode



Navigation

 Expert → Application → Totalizer 1 to n → Operation mode (0908-1 to n)

Prerequisite

A process variable is selected in the **Assign process variable** parameter (→  255) of the **Totalizer 1 to n** submenu.

Description

Use this function to select how the totalizer summates the flow.

Selection

- Net
- Forward
- Reverse

Factory setting



Net

Additional information

Selection

- Net flow total
Flow values in the forward and reverse flow direction are totalized and balanced against one another. Net flow is registered in the flow direction.
- Forward flow total
Only the flow in the forward flow direction is totalized.
- Reverse flow total
Only the flow in the reverse flow direction is totalized (= reverse flow quantity).



Control Totalizer 1 to n

Navigation	 Expert → Application → Totalizer 1 to n → Control Tot. 1 to n (0912-1 to n)
Prerequisite	A process variable is selected in the Assign process variable parameter (→  255) of the Totalizer 1 to n submenu.
Description	Use this function to select the control of totalizer value 1-3.
Selection	<ul style="list-style-type: none"> ■ Totalize ■ Reset + hold * ■ Preset + hold * ■ Reset + totalize ■ Preset + totalize * ■ Hold *
Factory setting	Totalize
Additional information	<i>Selection</i>

Options	Description
Totalize	The totalizer is started or continues running.
Reset + hold	The totaling process is stopped and the totalizer is reset to 0.
Preset + hold ¹⁾	The totaling process is stopped and the totalizer is set to its defined start value from the Preset value parameter.
Reset + totalize	The totalizer is reset to 0 and the totaling process is restarted.
Preset + totalize ¹⁾	The totalizer is set to the defined start value in the Preset value parameter and the totaling process is restarted.
Hold	Totalizing is stopped.

1) Visible depending on the order options or device settings

Preset value 1 to n

Navigation	 Expert → Application → Totalizer 1 to n → Preset value 1 to n (0913-1 to n)
Prerequisite	A process variable is selected in the Assign process variable parameter (→  255) of the Totalizer 1 to n submenu.
Description	Use this function to enter a start value for the Totalizer 1 to n.
User entry	Signed floating-point number
Factory setting	Country-specific: <ul style="list-style-type: none"> ■ 0 kg ■ 0 lb

* Visibility depends on order options or device settings

Additional information*User entry*

 The unit of the selected process variable is specified for the totalizer in the **Unit totalizer** parameter (→  256).

Example

This configuration is suitable for applications such as iterative filling processes with a fixed batch quantity.

Failure mode**Navigation**

  Expert → Application → Totalizer 1 to n → Failure mode (0901-1 to n)

Prerequisite

A process variable is selected in the **Assign process variable** parameter (→  255) of the **Totalizer 1 to n** submenu.

Description

Use this function to select how a totalizer behaves in the event of a device alarm.

Selection

- Hold
- Continue
- Last valid value + continue

Factory setting

Hold

Additional information*Description*



 This setting does not affect the failsafe mode of other totalizers and the outputs. This is specified in separate parameters.

Selection

- Stop
The totalizer is stopped in the event of a device alarm.
- Actual value
The totalizer continues to count based on the actual (current) measured value; the device alarm is ignored.
- Last valid value
The totalizer continues to count based on the last valid measured value before the device alarm occurred.

3.7.2 "Viscosity" submenu

 Only available for Promass I.

 For detailed information on the parameter descriptions for the **Viscosity** application package, refer to the Special Documentation for the device →  7

Navigation

  Expert → Application → Viscosity

► Viscosity

3.7.3 "Concentration" submenu



 For detailed information on the parameter descriptions for the **Concentration** application package, refer to the Special Documentation for the device →  7

Navigation  Expert → Application → Concentration



3.7.4 "Custody transfer" submenu



 Only available for Promass F, O, Q and X.

 For detailed information on the parameter descriptions for custody transfer measurement, see the Special Documentation for the device →  7

Navigation  Expert → Application → Custody transfer



3.7.5 "Petroleum" submenu

 For detailed information on the parameter descriptions for the **Petroleum** application package, refer to the Special Documentation for the device →  7

Navigation  Expert → Application → Petroleum



3.7.6 "Application specific calculations" submenu

 Only available if "Application-specific calculations" has been ordered.

Navigation  Expert → Application → Appl.spec. calc.

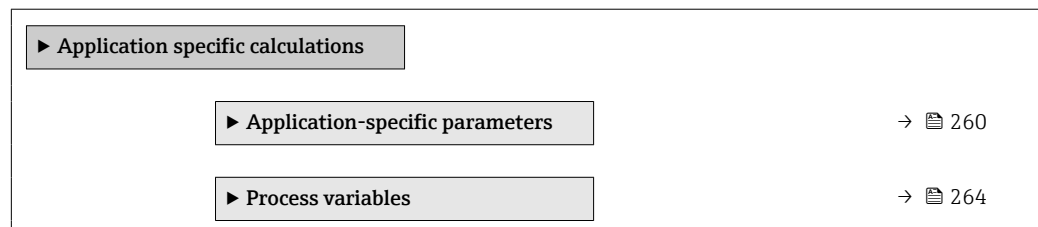











"Application-specific parameters" submenu

 Only available if "Application-specific calculations" has been ordered.

Navigation  Expert → Application → Appl.spec. calc. → Appl.spec.param.

▶ Application-specific parameters

Parameter 0 (6358)	→  261
Parameter 1 (6359)	→  261
Parameter 2 (6360)	→  262
Parameter 3 (6361)	→  262
Parameter 4 (6345)	→  262
Parameter 5 (6346)	→  262
Parameter 6 (6347)	→  263
Parameter 7 (6348)	→  263
Parameter 8 (6349)	→  263
Parameter 9 (6350)	→  263

Parameter 0

Navigation	 Expert → Application → Appl.spec. calc. → Appl.spec.param. → Parameter 0 (6358)
Description	Enter application specific value 0 for application specific calculation.
User entry	Signed floating-point number
Factory setting	0

Parameter 1

Navigation	 Expert → Application → Appl.spec. calc. → Appl.spec.param. → Parameter 1 (6359)
Description	Enter application specific value 1 for application specific calculation.
User entry	Signed floating-point number
Factory setting	0

Parameter 2



Navigation	Expert → Application → Appl.spec. calc. → Appl.spec.param. → Parameter 2 (6360)
Description	Enter application specific value 2 for application specific calculation.
User entry	Signed floating-point number
Factory setting	0

Parameter 3



Navigation	Expert → Application → Appl.spec. calc. → Appl.spec.param. → Parameter 3 (6361)
Description	Enter application specific value 3 for application specific calculation.
User entry	Signed floating-point number
Factory setting	0

Parameter 4



Navigation	Expert → Application → Appl.spec. calc. → Appl.spec.param. → Parameter 4 (6345)
Description	Enter application specific value 4 for application specific calculation.
User entry	Signed floating-point number
Factory setting	0

Parameter 5



Navigation	Expert → Application → Appl.spec. calc. → Appl.spec.param. → Parameter 5 (6346)
Description	Enter application specific value 5 for application specific calculation.
User entry	Signed floating-point number
Factory setting	0

Parameter 6



Navigation	Expert → Application → Appl.spec. calc. → Appl.spec.param. → Parameter 6 (6347)
Description	Enter application specific value 6 for application specific calculation.
User entry	Signed floating-point number
Factory setting	0

Parameter 7



Navigation	Expert → Application → Appl.spec. calc. → Appl.spec.param. → Parameter 7 (6348)
Description	Enter application specific value 7 for application specific calculation.
User entry	Signed floating-point number
Factory setting	0

Parameter 8



Navigation	Expert → Application → Appl.spec. calc. → Appl.spec.param. → Parameter 8 (6349)
Description	Enter application specific value 8 for application specific calculation.
User entry	Signed floating-point number
Factory setting	0

Parameter 9





Navigation	Expert → Application → Appl.spec. calc. → Appl.spec.param. → Parameter 9 (6350)
Description	Enter application specific value 9 for application specific calculation.
User entry	Signed floating-point number
Factory setting	0

"Process variables" submenu

 Only available if "Application-specific calculations" has been ordered.

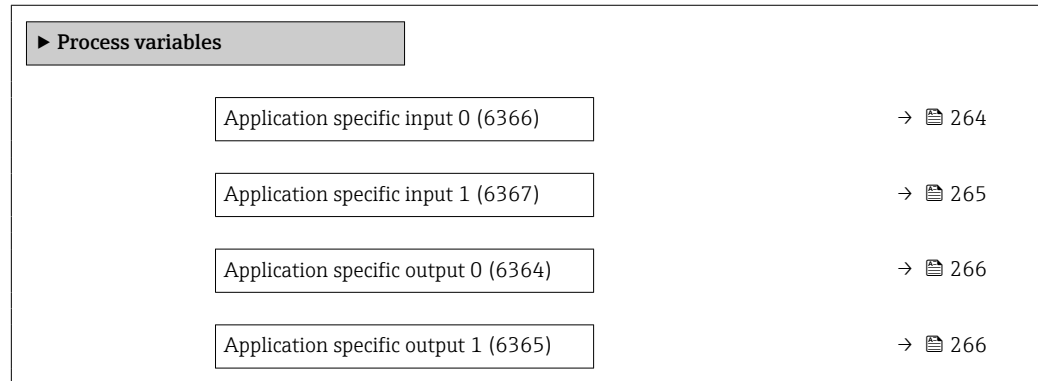
Navigation  Expert → Application → Appl.spec. calc. → Process variab.

**Application specific input 0**

Navigation	 Expert → Application → Appl.spec. calc. → Process variab. → Spec. input 0 (6366)
Description	Shows the application specific input value 0 used for the application specific calculation.
User interface	Signed floating-point number
Factory setting	0

Fail-safe type application specific 0

Navigation	 Expert → Application → Appl.spec. calc. → Process variab. → FSTypeAppSpec 0 (2098)
Description	Use this function to select the failsafe mode for the application-specific input value 0.
Selection	<ul style="list-style-type: none"> ■ Fail-safe value ■ Fallback value ■ Off
Factory setting	Off

Fail-safe value application specific 0

Navigation	Expert → Application → Appl.spec. calc. → Process variab. → FSValueAppSpec 0 (2099)
Description	Use this function to enter the failsafe value for the application-specific input value 0.
User entry	Signed floating-point number
Factory setting	0

Application specific input 1

Navigation	Expert → Application → Appl.spec. calc. → Process variab. → Spec. input 1 (6367)
Description	Shows the application specific input value 1 used for the application specific calculation.
User interface	Signed floating-point number
Factory setting	0

Fail-safe type application specific 1

Navigation	Expert → Application → Appl.spec. calc. → Process variab. → FSTypeAppSpec 1 (2100)
Description	Use this function to select the failsafe mode for the application-specific input value 1.
Selection	<ul style="list-style-type: none"> ■ Fail-safe value ■ Fallback value ■ Off
Factory setting	Off

Fail-safe value application specific 1

Navigation	Expert → Application → Appl.spec. calc. → Process variab. → FSValueAppSpec 1 (65535)
Description	Use this function to enter the failsafe value for the application-specific input value 1.
User entry	Signed floating-point number
Factory setting	0

Application specific output 0

Navigation	 Expert → Application → Appl.spec. calc. → Process variab. → Spec. output 0 (6364)
Description	Shows the calculated application specific output value 0.
User interface	Signed floating-point number
Factory setting	0





Application specific output 1

Navigation	 Expert → Application → Appl.spec. calc. → Process variab. → Spec. output 1 (6365)
Description	Shows the calculated specific output value 1.
User interface	Signed floating-point number
Factory setting	0

3.7.7 "Medium index" submenu

The following additional parameters and settings are part of the Gas Fraction Handler function. Due to its use of two operating frequencies (MFT - Multi-Frequency-Technology), Promass Q can provide additional diagnostic information about entrained gas that is suspended in the process liquid and the measured density is $> 400 \text{ kg/m}^3$. The gas typically occurs in viscous liquids in the form of microbubbles or small bubbles.

Navigation  Expert → Application → Medium index

► Medium index	
Inhomogeneous medium index (6368)	→  267
Cut off inhomogeneous wet gas (6375)	→  267
Cut off inhomogeneous liquid (6374)	→  267
Suspended bubbles index (6376)	→  268
Cut off suspended bubbles (6370)	→  268

Cut off inhomogeneous wet gas



Navigation	Expert → Application → Medium index → Cut off inh. gas (6375)
Description	Enter cut off value for wet gas applications. Below this value the 'Inhomogeneous medium index' is set to 0.
User entry	Positive floating-point number
Factory setting	0.25
Additional information	This parameter is used for wet gas applications. If the 'Index inhomogeneous medium' drops below this value and the measured density is $< 400 \text{ kg/m}^3$, the 'Index inhomogeneous medium' is reported as zero.

Cut off inhomogeneous liquid





Navigation	Expert → Application → Medium index → Cut off liquid (6374)
Description	Enter cut off value for liquid applications. Below this value the 'Inhomogeneous medium index' is set to 0.
User entry	Positive floating-point number
Factory setting	0.05
Additional information	This parameter is used for entrained gas in liquid applications or for solids in liquid applications. If the 'Index inhomogeneous medium' drops below this value and the measured density is $< 400 \text{ kg/m}^3$, the 'Index inhomogeneous medium' is reported as zero.

Inhomogeneous medium index



Navigation	Expert → Application → Medium index → InhomogMedIndex (6368)
Description	Shows the degree of inhomogeneity of the medium.
User interface	Signed floating-point number
Additional information	<ul style="list-style-type: none"> ▪ The 'Index inhomogeneous medium' diagnostic indicates the overall scale of two-phase flow associated with free bubbles. ▪ If the liquid does not contain entrained gas, the value is 0. For very high levels of gas content (e.g. associated with slug flow), the value is over 10. ▪ The diagnostic index generally increases with an increasing gas volume content. The index will not saturate with an excessive second phase.

- Although the index shows a qualitative correlation to the severity of gas entrainment, it should not be understood on a one-to-one basis as the gas volume content.
- The 'Index inhomogeneous medium' is reproducible under the same entrained gas conditions and can help to better understand the process conditions and the level of gas entrainment in relative terms.
- Similarly, the diagnostic index can also be used to describe the relative share of solids in a liquid application or the relative share of a liquid phase in a wet gas application.

Cut off suspended bubbles

















Navigation	  Expert → Application → Medium index → Cut off bubbles (6370)
Prerequisite	The parameter is only available for Promass Q.
Description	Enter the cut off value for suspended bubbles. Below this value the 'Index for suspended bubbles' is set to 0.
User entry	Positive floating-point number
Factory setting	0.05
Additional information	This parameter is used for gas entrained in liquid applications in the form of suspended bubbles. If the 'Index inhomogeneous medium' drops below this value, the 'Index inhomogeneous medium' is reported as zero.

Suspended bubbles index

Navigation	  Expert → Application → Medium index → SuspBubblesIndex (6376)
Prerequisite	The diagnostic index is only available for Promass Q.
Description	Shows the relative amount of suspended bubbles in the medium.
User interface	Signed floating-point number
Additional information	<ul style="list-style-type: none"> ■ This diagnostic index value describes the relative amount of microbubbles or small suspended bubbles in a process medium. ■ If there is no entrained gas in the form of suspended bubbles in a liquid, the value is 0 or nearly 0, and for very high levels of suspended gas the value exceeds 10. ■ The diagnostic index generally increases with increasing gas volumes, but the scaling is not linear in relation to the percentage gas content. ■ The index will not saturate with an excessive second phase. ■ The 'Index inh. medium' can help to better understand the process conditions and the level of gas entrainment in relative terms, but the index values cannot be interpreted on an absolute basis.

3.8 "Diagnostics" submenu

Navigation  Expert → Diagnostics

▶ Diagnostics	
Actual diagnostics (0691)	→  269
Previous diagnostics (0690)	→  270
Operating time from restart (0653)	→  271
Operating time (0652)	→  271
▶ Diagnostic list	→  272
▶ Event logbook	→  276
▶ Custody transfer logbook	→  278
▶ Device information	→  278
▶ Main electronic module + I/O module 1	→  282
▶ Sensor electronic module (ISEM)	→  283
▶ I/O module 2	→  284
▶ I/O module 3	→  285
▶ Display module	→  287
▶ Data logging	→  288
▶ Min/max values	→  298
▶ Heartbeat Technology	→  309
▶ Simulation	→  321





Actual diagnostics

Navigation



 Expert → Diagnostics → Actual diagnos. (0691)

Prerequisite





A diagnostic event has occurred.

Description	Displays the current diagnostic message. If two or more messages occur simultaneously, the message with the highest priority is shown on the display.
User interface	Symbol for diagnostic behavior, diagnostic code and short message.
Additional information	<p><i>Display</i></p> <p> Additional pending diagnostic messages can be viewed in the Diagnostic list submenu (→  272).</p> <p> Via the local display: the time stamp and corrective measures referring to the cause of the diagnostic message can be accessed via the  key.</p> <p><i>Example</i></p> <p>For the display format: F271 Main electronic failure</p>



Timestamp

Navigation	 Expert → Diagnostics → Timestamp
Description	Displays the operating time when the current diagnostic message occurred.
User interface	Days (d), hours (h), minutes (m) and seconds (s)
Additional information	<p><i>Display</i></p> <p> The diagnostic message can be viewed via the Actual diagnostics parameter (→  269).</p> <p><i>Example</i></p> <p>For the display format: 24d12h13m00s</p>



Previous diagnostics

Navigation	  Expert → Diagnostics → Prev.diagnostics (0690)
Prerequisite	Two diagnostic events have already occurred.
Description	Displays the diagnostic message that occurred before the current message.
User interface	Symbol for diagnostic behavior, diagnostic code and short message.
Additional information	<p><i>Display</i></p> <p> Via the local display: the time stamp and corrective measures referring to the cause of the diagnostic message can be accessed via the  key.</p> <p><i>Example</i></p> <p>For the display format: F271 Main electronic failure</p>



Timestamp

Navigation	 Expert → Diagnostics → Timestamp
Description	Displays the operating time when the last diagnostic message before the current message occurred.
User interface	Days (d), hours (h), minutes (m) and seconds (s)
Additional information	<p><i>Display</i></p> <p> The diagnostic message can be viewed via the Previous diagnostics parameter (→  270).</p> <p><i>Example</i></p> <p>For the display format: 24d12h13m00s</p>

Operating time from restart





Navigation	  Expert → Diagnostics → Time fr. restart (0653)
Description	Use this function to display the time the device has been in operation since the last device restart.
User interface	Days (d), hours (h), minutes (m) and seconds (s)

Operating time





Navigation	  Expert → Diagnostics → Operating time (0652)
Description	Use this function to display the length of time the device has been in operation.
User interface	Days (d), hours (h), minutes (m) and seconds (s)
Additional information	<p><i>User interface</i></p> <p>The maximum number of days is 9999, which is equivalent to 27 years.</p>

3.8.1 "Diagnostic list" submenu

Navigation  Expert → Diagnostics → Diagnostic list

▶ Diagnostic list	
Diagnostics 1 (0692)	→  272
Diagnostics 2 (0693)	→  273
Diagnostics 3 (0694)	→  274
Diagnostics 4 (0695)	→  274
Diagnostics 5 (0696)	→  275

Diagnostics 1

Navigation	 Expert → Diagnostics → Diagnostic list → Diagnostics 1 (0692)
Description	Displays the current diagnostics message with the highest priority.
User interface	Symbol for diagnostic behavior, diagnostic code and short message.
Additional information	<p><i>Display</i></p> <p> Via the local display: the time stamp and corrective measures referring to the cause of the diagnostic message can be accessed via the  key.</p> <p><i>Examples</i></p> <p>For the display format:</p> <ul style="list-style-type: none"> ▪  F271 Main electronic failure ▪  F276 I/O module failure

Timestamp 1

Navigation	 Expert → Diagnostics → Diagnostic list → Timestamp
Description	Displays the operating time when the diagnostic message with the highest priority occurred.
User interface	Days (d), hours (h), minutes (m) and seconds (s)

Additional information*Display*The diagnostic message can be viewed via the **Diagnostics 1** parameter (→ 272).*Example*

For the display format:

24d12h13m00s

Diagnostics 2

Navigation

Expert → Diagnostics → Diagnostic list → Diagnostics 2 (0693)

Description

Displays the current diagnostics message with the second-highest priority.

User interface

Symbol for diagnostic behavior, diagnostic code and short message.

Additional information*Display*

Via the local display: the time stamp and corrective measures referring to the cause of the diagnostic message can be accessed via the key.

Examples

For the display format:

- F271 Main electronic failure
- F276 I/O module failure

Timestamp 2

Navigation

Expert → Diagnostics → Diagnostic list → Timestamp

Description

Displays the operating time when the diagnostic message with the second-highest priority occurred.

User interface





Days (d), hours (h), minutes (m) and seconds (s)

Additional information*Display*The diagnostic message can be viewed via the **Diagnostics 2** parameter (→ 273).*Example*



For the display format:

24d12h13m00s

Diagnostics 3

Navigation	 Expert → Diagnostics → Diagnostic list → Diagnostics 3 (0694)
Description	Displays the current diagnostics message with the third-highest priority.
User interface	Symbol for diagnostic behavior, diagnostic code and short message.
Additional information	<p><i>Display</i></p> <p> Via the local display: the time stamp and corrective measures referring to the cause of the diagnostic message can be accessed via the  key.</p> <p><i>Examples</i></p> <p>For the display format:</p> <ul style="list-style-type: none"> ■  F271 Main electronic failure ■  F276 I/O module failure



Timestamp 3

Navigation	 Expert → Diagnostics → Diagnostic list → Timestamp
Description	Displays the operating time when the diagnostic message with the third-highest priority occurred.
User interface	Days (d), hours (h), minutes (m) and seconds (s)
Additional information	<p><i>Display</i></p> <p> The diagnostic message can be viewed via the Diagnostics 3 parameter (→  274).</p> <p><i>Example</i></p> <p>For the display format: 24d12h13m00s</p>

Diagnostics 4



Navigation	 Expert → Diagnostics → Diagnostic list → Diagnostics 4 (0695)
Description	Displays the current diagnostics message with the fourth-highest priority.
User interface	Symbol for diagnostic behavior, diagnostic code and short message.

Additional information*Display*

 Via the local display: the time stamp and corrective measures referring to the cause of the diagnostic message can be accessed via the  key.

Examples

For the display format:

-  F271 Main electronic failure
-  F276 I/O module failure

Timestamp 4

Navigation

 Expert → Diagnostics → Diagnostic list → Timestamp



Description

Displays the operating time when the diagnostic message with the fourth-highest priority occurred.

User interface

Days (d), hours (h), minutes (m) and seconds (s)

Additional information*Display*

 The diagnostic message can be viewed via the **Diagnostics 4** parameter (→  274).

Example

For the display format:

24d12h13m00s

Diagnostics 5

Navigation

 Expert → Diagnostics → Diagnostic list → Diagnostics 5 (0696)



Description

Displays the current diagnostics message with the fifth-highest priority.

User interface



Symbol for diagnostic behavior, diagnostic code and short message.

Additional information*Display*



 Via the local display: the time stamp and corrective measures referring to the cause of the diagnostic message can be accessed via the  key.

Examples

For the display format:

-  F271 Main electronic failure
-  F276 I/O module failure

Timestamp 5

Navigation	 Expert → Diagnostics → Diagnostic list → Timestamp
Description	Displays the operating time when the diagnostic message with the fifth-highest priority occurred.
User interface	Days (d), hours (h), minutes (m) and seconds (s)
Additional information	<p><i>Display</i></p> <p> The diagnostic message can be viewed via the Diagnostics 5 parameter (→  275).</p>

Example

For the display format:
24d12h13m00s

3.8.2 "Event logbook" submenu

Viewing event messages

Event messages are displayed in chronological order. The event history includes both diagnostic events and information events. The symbol in front of the timestamp indicates whether the event has started or ended.

Navigation  Expert → Diagnostics → Event logbook

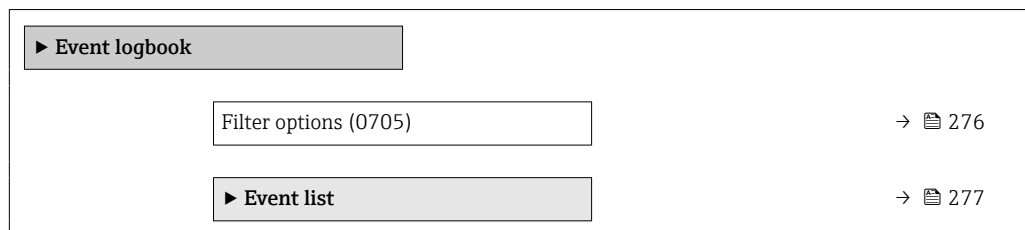

Filter options



Navigation	 Expert → Diagnostics → Event logbook → Filter options (0705)
Description	Use this function to select the category whose event messages are displayed in the event list of the local display.
Selection	<ul style="list-style-type: none"> ■ All ■ Failure (F) ■ Function check (C) ■ Out of specification (S) ■ Maintenance required (M) ■ Information (I)

Factory setting All

Additional information *Description*

-  The status signals are categorized in accordance with VDI/VDE 2650 and NAMUR Recommendation NE 107:
- F = Failure
 - C = Function Check
 - S = Out of Specification
 - M = Maintenance Required

"Event list" submenu

-  The **Event list** submenu is only displayed if operating via the local display.
- If operating via the FieldCare operating tool, the event list can be read out with a separate FieldCare module.
- If operating via the Web browser, the event messages can be found directly in the **Event logbook** submenu.

Navigation  Expert → Diagnostics → Event logbook → Event list

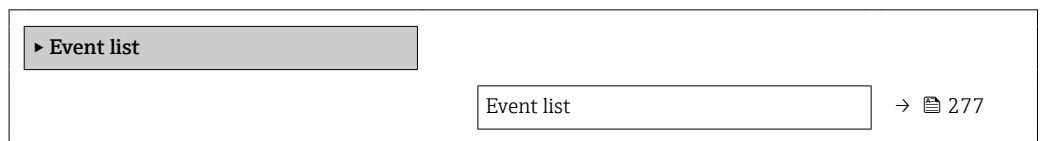

Event list

Navigation  Expert → Diagnostics → Event logbook → Event list

Description Displays the history of event messages of the category selected in the **Filter options** parameter (→  276).

User interface

- For a "Category I" event message
Information event, short message, symbol for event recording and operating time when error occurred
- For a "Category F, C, S, M" event message (status signal)
Diagnostics code, short message, symbol for event recording and operating time when error occurred

Additional information *Description*

A maximum of 20 event messages are displayed in chronological order.

If the **Extended HistoROM** application package (order option) is enabled in the device, the event list can contain up to 100 entries .

The following symbols indicate whether an event has occurred or has ended:

- ↻: Occurrence of the event
- ↺: End of the event

Examples

For the display format:



- I1091 Configuration modified
↻ 24d12h13m00s
- ⓧF271 Main electronic failure
↻ 01d04h12min30s

HistoROM

A HistoROM is a "non-volatile" device memory in the form of an EEPROM.

3.8.3 "Custody transfer logbook" submenu

 Only available for Promass F, O, Q and X.

 For detailed information on the parameter descriptions for custody transfer measurement, see the Special Documentation for the device →  7

Navigation  Expert → Diagnostics → Cust.transf.log.



3.8.4 "Device information" submenu

Navigation  Expert → Diagnostics → Device info

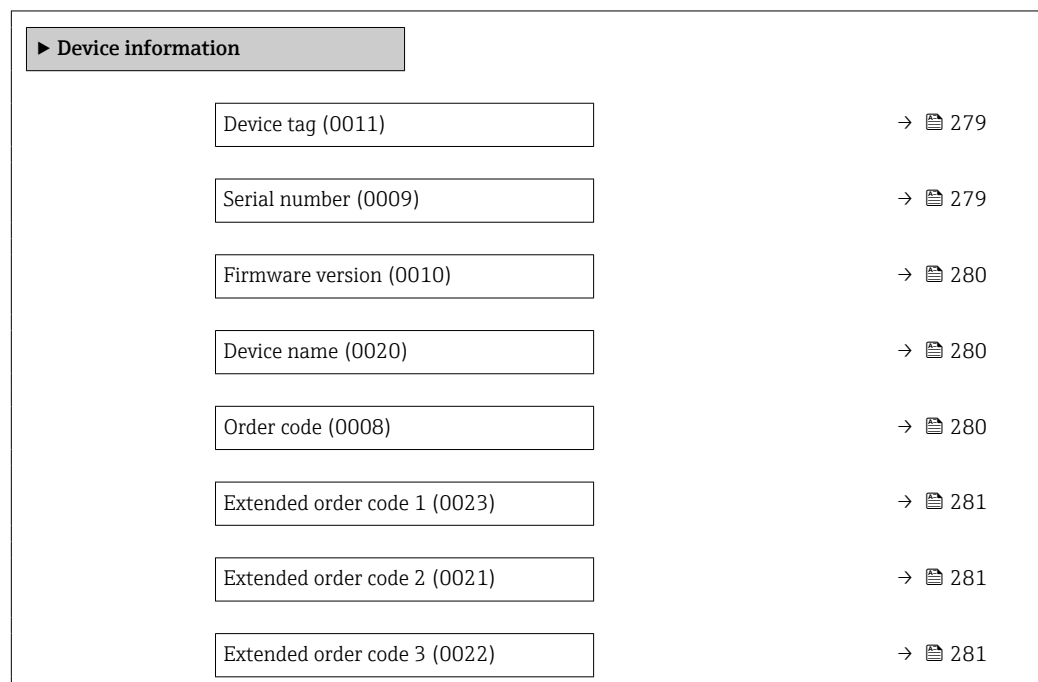

Configuration counter (0233)	→ 281
ENP version (0012)	→ 282

Device tag

Navigation	Expert → Diagnostics → Device info → Device tag (0011)
Description	Displays a unique name for the measuring point so it can be identified quickly within the plant. It is displayed in the header.
User interface	Max. 32 characters, such as letters, numbers or special characters (e.g. @, %, /).
Factory setting	Promass
Additional information	<i>User interface</i>

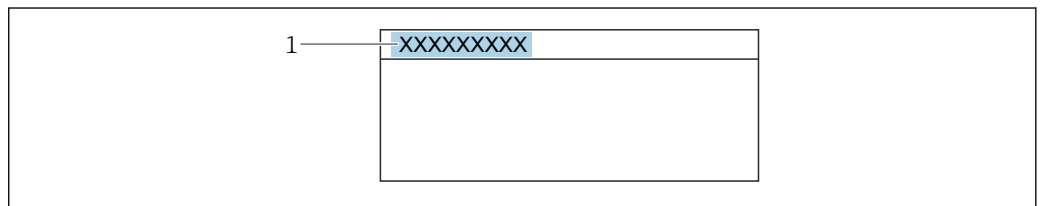

A0029422

1 Position of the header text on the display

The number of characters displayed depends on the characters used.

Serial number

Navigation	Expert → Diagnostics → Device info → Serial number (0009)
Description	Displays the serial number of the measuring device. i The number can be found on the nameplate of the sensor and transmitter.
User interface	Max. 11-digit character string comprising letters and numbers.
Additional information	<i>Description</i> i Uses of the serial number <ul style="list-style-type: none"> ■ To identify the measuring device quickly, e.g. when contacting Endress+Hauser. ■ To obtain specific information on the measuring device using the Device Viewer: www.endress.com/deviceviewer

Firmware version

Navigation  Expert → Diagnostics → Device info → Firmware version (0010)

Description Displays the device firmware version installed.

User interface Character string in the format xx.yy.zz

Additional information *Display*

-  The Firmware version is also located:
- On the title page of the Operating instructions
 - On the transmitter nameplate

Device name

Navigation  Expert → Diagnostics → Device info → Device name (0020)

Description Displays the name of the transmitter. It can also be found on the nameplate of the transmitter.

User interface Promass 300/500

Order code



Navigation  Expert → Diagnostics → Device info → Order code (0008)

Description Displays the device order code.

User interface Character string composed of letters, numbers and certain punctuation marks (e.g. /).

Additional information *Description*

-  The order code can be found on the nameplate of the sensor and transmitter in the "Order code" field.

The order code is generated from the extended order code through a process of reversible transformation. The extended order code indicates the attributes for all the device features in the product structure. The device features are not directly readable from the order code.

-  **Uses of the order code**
- To order an identical spare device.
 - To identify the device quickly and easily, e.g. when contacting Endress+Hauser.

Extended order code 1



Navigation	Expert → Diagnostics → Device info → Ext. order cd. 1 (0023)
Description	Displays the first part of the extended order code. On account of length restrictions, the extended order code is split into a maximum of 3 parameters.
User interface	Character string
Additional information	<i>Description</i> The extended order code indicates the version of all the features of the product structure for the measuring device and thus uniquely identifies the measuring device. The extended order code can also be found on the nameplate of the sensor and transmitter in the "Ext. ord. cd." field.

Extended order code 2



Navigation	Expert → Diagnostics → Device info → Ext. order cd. 2 (0021)
Description	Displays the second part of the extended order code.
User interface	Character string
Additional information	For additional information, see Extended order code 1 parameter (→ 281)

Extended order code 3



Navigation	Expert → Diagnostics → Device info → Ext. order cd. 3 (0022)
Description	Displays the third part of the extended order code.
User interface	Character string
Additional information	For additional information, see Extended order code 1 parameter (→ 281)

Configuration counter



Navigation	Expert → Diagnostics → Device info → Config. counter (0233)
Description	Displays the number of parameter modifications for the device. When the user changes a parameter setting, this counter is incremented.
User interface	0 to 65 535

ENP version

Navigation	 Expert → Diagnostics → Device info → ENP version (0012)
Description	Displays the version of the electronic nameplate.
User interface	Character string
Factory setting	2.02.00
Additional information	<p><i>Description</i></p> <p>This electronic nameplate stores a data record for device identification that includes more data than the nameplates attached to the outside of the device.</p>

3.8.5 "Main electronic module + I/O module 1" submenu

Navigation  Expert → Diagnostics → Main elec.+I/O1

<div style="background-color: #cccccc; padding: 2px;">▶ Main electronic module + I/O module 1</div>	
Firmware version	→  282
Build no. software	→  282
Bootloader revision	→  283

Firmware version

Navigation	 Expert → Diagnostics → Main elec.+I/O1 → Firmware version (0072)
Description	Use this function to display the software revision of the module.
User interface	Positive integer

Build no. software



Navigation	 Expert → Diagnostics → Main elec.+I/O1 → Build no. softw. (0079)
Description	Use this function to display the software build number of the module.
User interface	Positive integer

Bootloader revision

Navigation	 Expert → Diagnostics → Main elec.+I/O1 → Bootloader rev. (0073)
Description	Use this function to display the bootloader revision of the software.
User interface	Positive integer

3.8.6 "Sensor electronic module (ISEM)" submenu

Navigation  Expert → Diagnostics → Sens. electronic

▶ Sensor electronic module (ISEM)	
Firmware version (0072)	→  283
Build no. software (0079)	→  283
Bootloader revision (0073)	→  284



Firmware version

Navigation	 Expert → Diagnostics → Sens. electronic → Firmware version (0072)
Description	Use this function to display the software revision of the module.
User interface	Positive integer

Build no. software





Navigation	 Expert → Diagnostics → Sens. electronic → Build no. softw. (0079)
Description	Use this function to display the software build number of the module.
User interface	Positive integer

Bootloader revision



Navigation	  Expert → Diagnostics → Sens. electronic → Bootloader rev. (0073)
Description	Use this function to display the bootloader revision of the software.
User interface	Positive integer

3.8.7 "I/O module 2" submenu



Navigation   Expert → Diagnostics → I/O module 2

▶ I/O module 2	
I/O module 2 terminal numbers (3902-2)	→  284
Firmware version (0072)	→  284
Build no. software (0079)	→  285
Bootloader revision (0073)	→  285

I/O module 2 terminal numbers

Navigation	  Expert → Diagnostics → I/O module 2 → I/O 2 terminals (3902-2)
Description	Displays the terminal numbers used by the I/O module.
User interface	<ul style="list-style-type: none"> ▪ Not used ▪ 26-27 (I/O 1) ▪ 24-25 (I/O 2) ▪ 22-23 (I/O 3)

Firmware version

Navigation	  Expert → Diagnostics → I/O module 2 → Firmware version (0072)
Description	Use this function to display the software revision of the module.
User interface	Positive integer

Build no. software





Navigation	 Expert → Diagnostics → I/O module 2 → Build no. softw. (0079)
Description	Use this function to display the software build number of the module.
User interface	Positive integer

Bootloader revision

Navigation	 Expert → Diagnostics → I/O module 2 → Bootloader rev. (0073)
Description	Use this function to display the bootloader revision of the software.
User interface	Positive integer

3.8.8 "I/O module 3" submenu



Navigation  Expert → Diagnostics → I/O module 3

▶ I/O module 3	
I/O module 3 terminal numbers (3902-3)	→  285
Firmware version (0072)	→  286
Build no. software (0079)	→  286
Bootloader revision (0073)	→  286



I/O module 3 terminal numbers

Navigation	 Expert → Diagnostics → I/O module 3 → I/O 3 terminals (3902-3)
Description	Displays the terminal numbers used by the I/O module.
User interface	<ul style="list-style-type: none"> ■ Not used ■ 26-27 (I/O 1) ■ 24-25 (I/O 2) ■ 22-23 (I/O 3)



Firmware version

Navigation	  Expert → Diagnostics → I/O module 3 → Firmware version (0072)
Description	Use this function to display the software revision of the module.
User interface	Positive integer

Build no. software





Navigation	  Expert → Diagnostics → I/O module 3 → Build no. softw. (0079)
Description	Use this function to display the software build number of the module.
User interface	Positive integer

Bootloader revision



Navigation	  Expert → Diagnostics → I/O module 3 → Bootloader rev. (0073)
Description	Use this function to display the bootloader revision of the software.
User interface	Positive integer

3.8.9 "I/O module 4" submenu



Navigation   Expert → Diagnostics → I/O module 4

▶ I/O module 4	
I/O module 4 terminal numbers (3902-4)	→  287
Firmware version (0072)	→  287
Build no. software (0079)	→  287
Bootloader revision (0073)	→  287



I/O module 4 terminal numbers

Navigation	  Expert → Diagnostics → I/O module 4 → I/O 4 terminals (3902-4)
Description	Displays the terminal numbers used by the I/O module.
User interface	<ul style="list-style-type: none"> ▪ Not used ▪ 26-27 (I/O 1) ▪ 24-25 (I/O 2) ▪ 22-23 (I/O 3)



Firmware version

Navigation	  Expert → Diagnostics → I/O module 4 → Firmware version (0072)
Description	Use this function to display the software revision of the module.
User interface	Positive integer



Build no. software

Navigation	  Expert → Diagnostics → I/O module 4 → Build no. softw. (0079)
Description	Use this function to display the software build number of the module.
User interface	Positive integer

Bootloader revision

Navigation	  Expert → Diagnostics → I/O module 4 → Bootloader rev. (0073)
Description	Use this function to display the bootloader revision of the software.
User interface	Positive integer

3.8.10 "Display module" submenu

Navigation   Expert → Diagnostics → Display module

▶ Display module

Firmware version (0072)	→ 288
Build no. software (0079)	→ 288
Bootloader revision (0073)	→ 288

Firmware version

Navigation	 Expert → Diagnostics → Display module → Firmware version (0072)
Description	Use this function to display the software revision of the module.
User interface	Positive integer

Build no. software

Navigation	 Expert → Diagnostics → Display module → Build no. softw. (0079)
Description	Use this function to display the software build number of the module.
User interface	Positive integer













Bootloader revision

Navigation	 Expert → Diagnostics → Display module → Bootloader rev. (0073)
Description	Use this function to display the bootloader revision of the software.
User interface	Positive integer

3.8.11 "Data logging" submenu

Navigation  Expert → Diagnostics → Data logging

▶ Data logging	
Assign channel 1 (0851)	→ 289
Assign channel 2 (0852)	→ 291

Assign channel 3 (0853)	→  292
Assign channel 4 (0854)	→  292
Logging interval (0856)	→  292
Clear logging data (0855)	→  293
Data logging (0860)	→  293
Logging delay (0859)	→  294
Data logging control (0857)	→  294
Data logging status (0858)	→  295
Entire logging duration (0861)	→  295
► Display channel 1	→  295
► Display channel 2	→  297
► Display channel 3	→  297
► Display channel 4	→  298

Assign channel 1

Navigation

  Expert → Diagnostics → Data logging → Assign chan. 1 (0851)

Prerequisite

The **Extended HistoROM** application package is available.



The software options currently enabled are displayed in the **Software option overview** parameter (→  56).

Description

Use this function to select a process variable for the data logging channel.

Selection

- Off
- Mass flow
- Volume flow
- Corrected volume flow *
- Density
- Reference density *
- Temperature
- Pressure
- GSV flow *
- GSV flow alternative *

* Visibility depends on order options or device settings

- NSV flow *
- NSV flow alternative *
- S&W volume flow *
- Reference density alternative *
- Water cut *
- Oil density *
- Water density *
- Oil mass flow *
- Water mass flow *
- Oil volume flow *
- Water volume flow *
- Oil corrected volume flow *
- Water corrected volume flow *
- Target mass flow *
- Carrier mass flow *
- Concentration *
- Dynamic viscosity *
- Kinematic viscosity *
- Temp. compensated dynamic viscosity *
- Temp. compensated kinematic viscosity *
- GSV flow *
- GSV flow alternative *
- NSV flow *
- NSV flow alternative *
- S&W volume flow *
- Reference density alternative *
- Water cut *
- Oil density *
- Water density *
- Oil mass flow *
- Water mass flow *
- Oil volume flow *
- Water volume flow *
- Oil corrected volume flow *
- Water corrected volume flow *
- Target volume flow *
- Carrier volume flow *
- Target corrected volume flow *
- Carrier corrected volume flow *
- Application specific output 0 *
- Application specific output 1 *
- Inhomogeneous medium index
- Suspended bubbles index *
- HBSI *
- Raw value mass flow
- Exciter current 0
- Oscillation damping 0
- Oscillation damping fluctuation 0 *
- Oscillation frequency 0
- Frequency fluctuation 0 *
- Signal asymmetry
- Torsion signal asymmetry *
- Carrier pipe temperature *
- Oscillation frequency 1 *
- Frequency fluctuation 0 *
- Frequency fluctuation 1 *

* Visibility depends on order options or device settings

- Oscillation amplitude *
- Oscillation amplitude 1 *
- Oscillation damping 1 *
- Oscillation damping fluctuation 0 *
- Oscillation damping fluctuation 1 *
- Exciter current 1 *
- Electronics temperature
- Sensor index coil asymmetry
- Test point 0
- Test point 1
- Current output 1
- Current output 2 *
- Current output 3 *
- Current output 4 *

Factory setting

Off

Additional information*Description*



A total of 1000 measured values can be logged. This means:

- 1000 data points if 1 logging channel is used
- 500 data points if 2 logging channels are used
- 333 data points if 3 logging channels are used
- 250 data points if 4 logging channels are used

Once the maximum number of data points is reached, the oldest data points in the data log are cyclically overwritten in such a way that the last 1000, 500, 333 or 250 measured values are always in the log (ring memory principle).

 The log contents are cleared if the option selected is changed.

Selection



 Detailed description of the options **Oscillation frequency**, **Oscillation amplitude**, **Oscillation damping** and **Signal asymmetry: Assign current output** parameter (→  156)

Assign channel 2**Navigation**

  Expert → Diagnostics → Data logging → Assign chan. 2 (0852)

Prerequisite

The **Extended HistorOM** application package is available.

 The software options currently enabled are displayed in the **Software option overview** parameter (→  56).

Description

Use this function to select a process variable for the data logging channel.







Selection







For the picklist, see the **Assign channel 1** parameter (→  289)





Factory setting

Off

* Visibility depends on order options or device settings



Assign channel 3 	
Navigation	  Expert → Diagnostics → Data logging → Assign chan. 3 (0853)
Prerequisite	The Extended HistoROM application package is available.  The software options currently enabled are displayed in the Software option overview parameter (→  56).
Description	Use this function to select a process variable for the data logging channel.
Selection	For the picklist, see the Assign channel 1 parameter (→  289)
Factory setting	Off

Assign channel 4 	
Navigation	  Expert → Diagnostics → Data logging → Assign chan. 4 (0854)
Prerequisite	The Extended HistoROM application package is available.  The software options currently enabled are displayed in the Software option overview parameter (→  56).
Description	Use this function to select a process variable for the data logging channel.
Selection	For the picklist, see the Assign channel 1 parameter (→  289)
Factory setting	Off

Logging interval 	
Navigation	  Expert → Diagnostics → Data logging → Logging interval (0856)
Prerequisite	The Extended HistoROM application package is available.  The software options currently enabled are displayed in the Software option overview parameter (→  56).
Description	Use this function to enter the logging interval T_{\log} for data logging.
User entry	0.1 to 3 600.0 s
Factory setting	1.0 s

Additional information	<p><i>Description</i></p> <p>This defines the interval between the individual data points in the data log, and thus the maximum loggable process time T_{\log}:</p> <ul style="list-style-type: none"> ▪ If 1 logging channel is used: $T_{\log} = 1000 \times t_{\log}$ ▪ If 2 logging channels are used: $T_{\log} = 500 \times t_{\log}$ ▪ If 3 logging channels are used: $T_{\log} = 333 \times t_{\log}$ ▪ If 4 logging channels are used: $T_{\log} = 250 \times t_{\log}$ <p>Once this time elapses, the oldest data points in the data log are cyclically overwritten such that a time of T_{\log} always remains in the memory (ring memory principle).</p> <p> The log contents are cleared if the length of the logging interval is changed.</p> <p><i>Example</i></p> <p>If 1 logging channel is used:</p> <ul style="list-style-type: none"> ▪ $T_{\log} = 1000 \times 1 \text{ s} = 1\,000 \text{ s} \approx 15 \text{ min}$ ▪ $T_{\log} = 1000 \times 10 \text{ s} = 10\,000 \text{ s} \approx 3 \text{ h}$ ▪ $T_{\log} = 1000 \times 80 \text{ s} = 80\,000 \text{ s} \approx 1 \text{ d}$ ▪ $T_{\log} = 1000 \times 3\,600 \text{ s} = 3\,600\,000 \text{ s} \approx 41 \text{ d}$
-------------------------------	---

Clear logging data

Navigation	 Expert → Diagnostics → Data logging → Clear logging (0855)
Prerequisite	<p>The Extended HistorOM application package is available.</p> <p> The software options currently enabled are displayed in the Software option overview parameter (→  56).</p>
Description	Use this function to clear the entire logging data.
Selection	<ul style="list-style-type: none"> ▪ Cancel ▪ Clear data
Factory setting	Cancel
Additional information	<p><i>Selection</i></p> <ul style="list-style-type: none"> ▪ Cancel The data is not cleared. All the data is retained. ▪ Clear data The logging data is cleared. The logging process starts from the beginning.

Data logging

Navigation	 Expert → Diagnostics → Data logging → Data logging (0860)
Description	Use this function to select the data logging method.
Selection	<ul style="list-style-type: none"> ▪ Overwriting ▪ Not overwriting

Factory setting Overwriting

Additional information *Selection*

- Overwriting
The device memory applies the FIFO principle.
- Not overwriting
Data logging is canceled if the measured value memory is full (single shot).

Logging delay

Navigation   Expert → Diagnostics → Data logging → Logging delay (0859)

Prerequisite In the **Data logging** parameter (→  293), the **Not overwriting** option is selected.

Description Use this function to enter the time delay for measured value logging.

User entry 0 to 999 h

Factory setting 0 h

Additional information *Description*

Once data logging has been started with the **Data logging control** parameter (→  294), the device does not save any data for the duration of the delay time entered.

Data logging control

Navigation   Expert → Diagnostics → Data logging → Data log.control (0857)

Prerequisite In the **Data logging** parameter (→  293), the **Not overwriting** option is selected.

Description Use this function to start and stop measured value logging.

Selection

- None
- Delete + start
- Stop

Factory setting None

Additional information *Selection*

- None
Initial measured value logging status.
- Delete + start
All the measured values recorded for all the channels are deleted and measured value logging starts again.
- Stop
Measured value logging is stopped.

Data logging status

Navigation	🔍📄 Expert → Diagnostics → Data logging → Data log. status (0858)
Prerequisite	In the Data logging parameter (→ 📄 293), the Not overwriting option is selected.
Description	Displays the measured value logging status.
User interface	<ul style="list-style-type: none"> ▪ Done ▪ Delay active ▪ Active ▪ Stopped
Factory setting	Done
Additional information	<i>Selection</i> <ul style="list-style-type: none"> ▪ Done Measured value logging has been performed and completed successfully. ▪ Delay active Measured value logging has been started but the logging interval has not yet elapsed. ▪ Active The logging interval has elapsed and measured value logging is active. ▪ Stopped Measured value logging is stopped.

Entire logging duration

Navigation	🔍📄 Expert → Diagnostics → Data logging → Logging duration (0861)
Prerequisite	In the Data logging parameter (→ 📄 293), the Not overwriting option is selected.
Description	Displays the total logging duration.
User interface	Positive floating-point number
Factory setting	0 s

"Display channel 1" submenu



Navigation 🔍 Expert → Diagnostics → Data logging → Displ.channel 1



Display channel 1

Navigation
 Expert → Diagnostics → Data logging → Displ.channel 1
Prerequisite

The **Extended HistoROM** application package is available.

 The software options currently enabled are displayed in the **Software option overview** parameter (→  56).

One of the following options is selected in the **Assign channel 1** parameter (→  289):



- Mass flow
- Volume flow
- Corrected volume flow
- Target mass flow *
- Carrier mass flow *
- Density
- Reference density
- Concentration *
- Dynamic viscosity *
- Kinematic viscosity *
- Temp. compensated dynamic viscosity *
- Temp. compensated kinematic viscosity *
- Carrier pipe temperature
- Electronics temperature
- Current output 1
- Oscillation frequency 0
- Oscillation frequency 1 *
- Frequency fluctuation 0
- Frequency fluctuation 1 *
- Oscillation amplitude *
- Oscillation amplitude 1 *
- Oscillation damping 0
- Oscillation damping 1 *
- Oscillation damping fluctuation 0
- Oscillation damping fluctuation 1 *
- Signal asymmetry
- Exciter current 0
- Exciter current 1 *

Description

Displays the measured value trend for the logging channel in the form of a chart.

Additional information

Prerequisite

 Detailed description of the options **Oscillation frequency**, **Oscillation amplitude**, **Oscillation damping** and **Signal asymmetry**: **Assign current output** parameter (→  156)

Description

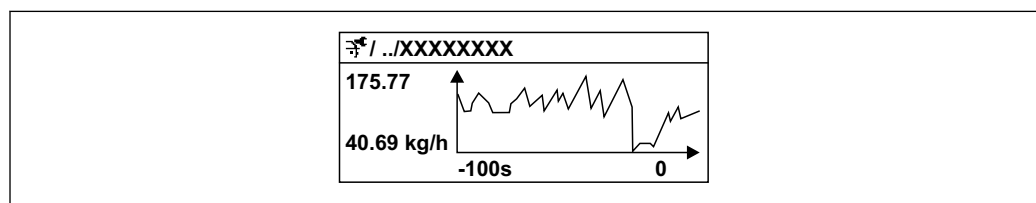

A0016357

 11 Chart of a measured value trend

* Visibility depends on order options or device settings

- x-axis: depending on the number of channels selected displays 250 to 1000 measured values of a process variable.
- y-axis: displays the approximate measured value span and constantly adapts this to the ongoing measurement.

"Display channel 2" submenu

Navigation  Expert → Diagnostics → Data logging → Displ.channel 2



Display channel 2

Navigation  Expert → Diagnostics → Data logging → Displ.channel 2

Prerequisite A process variable is specified in the **Assign channel 2** parameter.

Description See the **Display channel 1** parameter →  296

"Display channel 3" submenu

Navigation  Expert → Diagnostics → Data logging → Displ.channel 3



Display channel 3

Navigation  Expert → Diagnostics → Data logging → Displ.channel 3

Prerequisite A process variable is specified in the **Assign channel 3** parameter.

Description See the **Display channel 1** parameter →  296

"Display channel 4" submenu

Navigation  Expert → Diagnostics → Data logging → Displ.channel 4

**Display channel 4****Navigation**

 Expert → Diagnostics → Data logging → Displ.channel 4

Prerequisite

A process variable is specified in the **Assign channel 4** parameter.

Description

See the **Display channel 1** parameter →  296

3.8.12 "Min/max values" submenu

Navigation   Expert → Diagnostics → Min/max val.

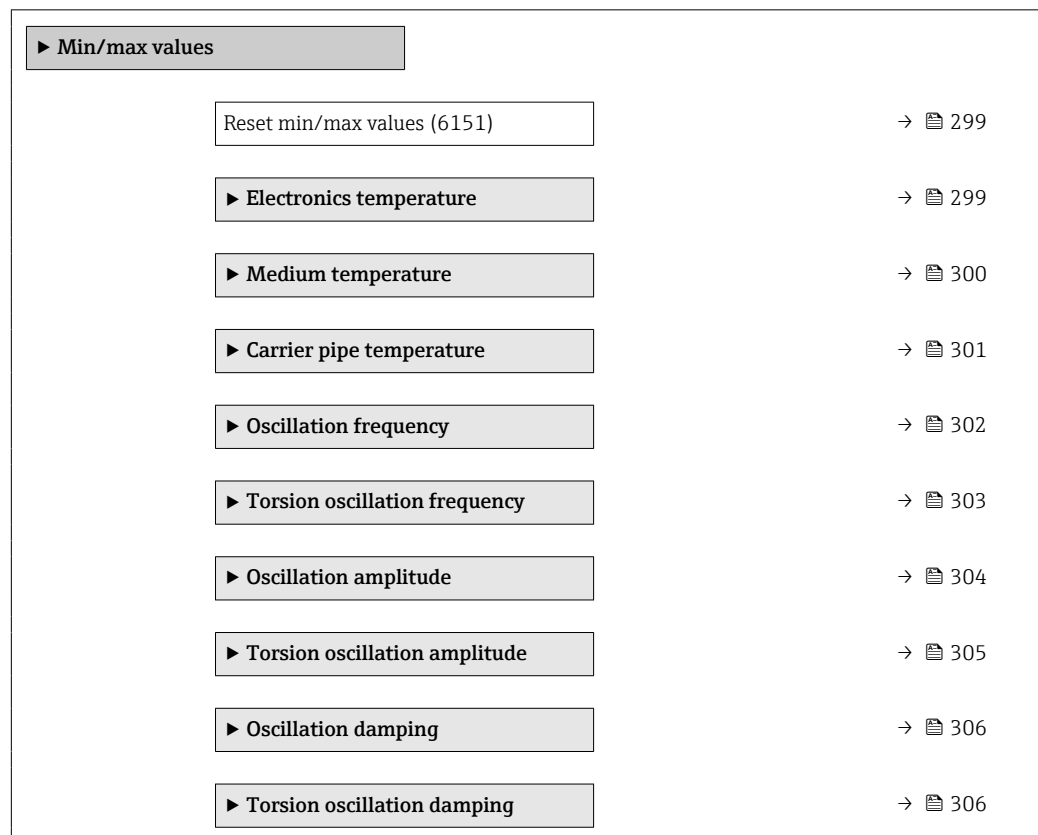

▶ Signal asymmetry	→ ⓘ 307
▶ Torsion signal asymmetry	→ ⓘ 308

Reset min/max values



Navigation

Expert → Diagnostics → Min/max val. → Reset min/max (6151)

Description

Use this function to select measured variables whose minimum, maximum and average measured values are to be reset.

Selection

- Cancel
- Oscillation amplitude *
- Oscillation amplitude 1 *
- Oscillation damping
- Torsion oscillation damping *
- Oscillation frequency
- Torsion oscillation frequency *
- Signal asymmetry
- Torsion signal asymmetry *

Factory setting

Cancel

Additional information

Selection

Detailed description of the options **Oscillation frequency**, **Oscillation amplitude**, **Oscillation damping** and **Signal asymmetry: Value 1 display** parameter (→ ⓘ 19)



"Electronics temperature" submenu

Navigation Expert → Diagnostics → Min/max val. → Electronics temp



▶ Electronics temperature	
Minimum value	→ ⓘ 300
Maximum value	→ ⓘ 300

* Visibility depends on order options or device settings

Minimum value



Navigation	 Expert → Diagnostics → Min/max val. → Electronics temp → Minimum value (6052)
Description	Displays the lowest previously measured temperature value of the main electronics module.
User interface	Signed floating-point number
Additional information	<i>Dependency</i>  The unit is taken from the Temperature unit parameter (→  98)

Maximum value

Navigation	 Expert → Diagnostics → Min/max val. → Electronics temp → Maximum value (6051)
Description	Displays the highest previously measured temperature value of the main electronics module.
User interface	Signed floating-point number
Additional information	<i>Dependency</i>  The unit is taken from the Temperature unit parameter (→  98)

"Medium temperature" submenu

Navigation  Expert → Diagnostics → Min/max val. → Medium temp.



▶ Medium temperature	
Minimum value (6109)	→  300
Maximum value (6108)	→  301

Minimum value

Navigation	 Expert → Diagnostics → Min/max val. → Medium temp. → Minimum value (6109)
Description	Displays the lowest previously measured medium temperature value.
User interface	Signed floating-point number



Additional information

Dependency

 The unit is taken from the **Temperature unit** parameter (→  98)

Maximum value

Navigation

  Expert → Diagnostics → Min/max val. → Medium temp. → Maximum value (6108)

Description



Displays the highest previously measured medium temperature value.

User interface



Signed floating-point number

Additional information



Dependency

 The unit is taken from the **Temperature unit** parameter (→  98)

"Carrier pipe temperature" submenu



Navigation   Expert → Diagnostics → Min/max val. → Carr. pipe temp.

▶ Carrier pipe temperature

Minimum value (6030)	→  301
Maximum value (6029)	→  302

Minimum value

Navigation

  Expert → Diagnostics → Min/max val. → Carr. pipe temp. → Minimum value (6030)

Prerequisite

 Only available for:

- Promass A
- Promass F
- Promass H
- Promass I
- Promass O
- Promass P
- PromassQ
- Promass S
- Promass X



For the following order code
 "Application package", option **EB** "Heartbeat Verification + Monitoring"

Description



Displays the lowest previously measured temperature value of the carrier pipe.

User interface Signed floating-point number

Additional information *Dependency*

 The unit is taken from the **Temperature unit** parameter (→  98)

Maximum value

Navigation   Expert → Diagnostics → Min/max val. → Carr. pipe temp. → Maximum value (6029)

Prerequisite  Only available for:

- Promass A
- Promass F
- Promass H
- Promass I
- Promass O
- Promass P
- PromassQ
- Promass S
- Promass X

For the following order code
"Application package", option **EB** "Heartbeat Verification + Monitoring"



Description Displays the highest previously measured temperature value of the carrier pipe.

User interface Signed floating-point number



Additional information *Dependency*

 The unit is taken from the **Temperature unit** parameter (→  98)

"Oscillation frequency" submenu

Navigation   Expert → Diagnostics → Min/max val. → Oscil. frequency

▶ Oscillation frequency

Minimum value (6071)	→  303
Maximum value (6070)	→  303

Minimum value

Navigation	 Expert → Diagnostics → Min/max val. → Oscil. frequency → Minimum value (6071)
Description	Displays the lowest previously measured oscillation frequency.
User interface	Signed floating-point number



Maximum value

Navigation	 Expert → Diagnostics → Min/max val. → Oscil. frequency → Maximum value (6070)
Description	Displays the highest previously measured oscillation frequency.
User interface	Signed floating-point number



"Torsion oscillation frequency" submenu

Navigation  Expert → Diagnostics → Min/max val. → Tors.oscil.freq.

▶ **Torsion oscillation frequency**

Minimum value (6069)	→  303
Maximum value (6068)	→  304

Minimum value

Navigation	 Expert → Diagnostics → Min/max val. → Tors.oscil.freq. → Minimum value (6069)
Prerequisite	 Only available for Promass I and Q. For the following order code: "Application package", option EB "Heartbeat Verification + Monitoring"
Description	Displays the lowest previously measured torsion oscillation frequency.
User interface	Signed floating-point number

Maximum value

Navigation  Expert → Diagnostics → Min/max val. → Tors.oscil.freq. → Maximum value (6068)

Prerequisite  Only available for Promass I and Q.

For the following order code:
"Application package", option **EB** "Heartbeat Verification + Monitoring"



Description Displays the highest previously measured torsion oscillation frequency.

User interface Signed floating-point number

"Oscillation amplitude" submenu

Navigation  Expert → Diagnostics → Min/max val. → Oscil. amplitude

▶ **Oscillation amplitude**

Minimum value (6010)	→  304
Maximum value (6009)	→  304

Minimum value

Navigation  Expert → Diagnostics → Min/max val. → Oscil. amplitude → Minimum value (6010)

Description Displays the lowest previously measured oscillation amplitude.

User interface Signed floating-point number

Maximum value

Navigation  Expert → Diagnostics → Min/max val. → Oscil. amplitude → Maximum value (6009)



Description Displays the highest previously measured oscillation amplitude.

User interface Signed floating-point number

"Torsion oscillation amplitude" submenu

Navigation  Expert → Diagnostics → Min/max val. → Tor. osc. amp.

▶ Torsion oscillation amplitude

Minimum value (6008)	→  305
Maximum value (6007)	→  305

Minimum value

Navigation  Expert → Diagnostics → Min/max val. → Tor. osc. amp. → Minimum value (6008)

Prerequisite  Only available for Promass I and Q.

For the following order code:
"Application package", option **EB** "Heartbeat Verification + Monitoring"

Description Displays the lowest previously measured torsion oscillation amplitude.

User interface Signed floating-point number

Maximum value

Navigation  Expert → Diagnostics → Min/max val. → Tor. osc. amp. → Maximum value (6007)

Prerequisite  Only available for Promass I and Q.



For the following order code:
"Application package", option **EB** "Heartbeat Verification + Monitoring"

Description Displays the highest previously measured torsion oscillation amplitude.

User interface Signed floating-point number

"Oscillation damping" submenu

Navigation  Expert → Diagnostics → Min/max val. → Oscil. damping

► Oscillation damping	
Minimum value (6122)	→  306
Maximum value (6121)	→  306

Minimum value

Navigation  Expert → Diagnostics → Min/max val. → Oscil. damping → Minimum value (6122)

Description Displays the lowest previously measured oscillation damping.

User interface Signed floating-point number

Maximum value



Navigation  Expert → Diagnostics → Min/max val. → Oscil. damping → Maximum value (6121)

Description Displays the highest previously measured oscillation damping.



User interface Signed floating-point number

"Torsion oscillation damping" submenu



Navigation  Expert → Diagnostics → Min/max val. → Tors.oscil.damp.

► Torsion oscillation damping	
Minimum value (6120)	→  307
Maximum value (6119)	→  307

Minimum value

- Navigation**  Expert → Diagnostics → Min/max val. → Tors.oscil.damp. → Minimum value (6120)
- Prerequisite**  Only available for Promass I and Q.
For the following order code:
"Application package", option **EB** "Heartbeat Verification + Monitoring"
- Description** Displays the lowest previously measured torsion oscillation damping.
- User interface** Signed floating-point number



Maximum value

- Navigation**  Expert → Diagnostics → Min/max val. → Tors.oscil.damp. → Maximum value (6119)
- Prerequisite**  Only available for Promass I and Q.
For the following order code:
"Application package", option **EB** "Heartbeat Verification + Monitoring"
- Description** Displays the highest previously measured torsion oscillation damping.
- User interface** Signed floating-point number

"Signal asymmetry" submenu

Navigation  Expert → Diagnostics → Min/max val. → Signal asymmetry

▶ Signal asymmetry



Minimum value (6015)	→  307
Maximum value (6014)	→  308

Minimum value

- Navigation**  Expert → Diagnostics → Min/max val. → Signal asymmetry → Minimum value (6015)
- Description** Displays the lowest previously measured signal asymmetry.

User interface Signed floating-point number



Maximum value

Navigation   Expert → Diagnostics → Min/max val. → Signal asymmetry → Maximum value (6014)



Description Displays the highest previously measured signal asymmetry.

User interface Signed floating-point number



"Torsion signal asymmetry" submenu

Navigation   Expert → Diagnostics → Min/max val. → Tors.sig.asymm.

▶ Torsion signal asymmetry

Minimum value (6284)	→  308
Maximum value (6283)	→  308

Minimum value

Navigation   Expert → Diagnostics → Min/max val. → Tors.sig.asymm. → Minimum value (6284)



Prerequisite  Only available for Promass I and Q.

For the following order code:
"Application package", option **EB** "Heartbeat Verification + Monitoring"

Description Displays the lowest previously measured torsion signal asymmetry.

User interface Signed floating-point number

Maximum value

Navigation   Expert → Diagnostics → Min/max val. → Tors.sig.asymm. → Maximum value (6283)

Prerequisite  Only available for Promass I and Q.

For the following order code:
 "Application package", option **EB** "Heartbeat Verification + Monitoring"





Description	Displays the highest previously measured torsion signal asymmetry.
User interface	Signed floating-point number

3.8.13 "Heartbeat Technology" submenu

 For detailed information on the parameter descriptions for the **Heartbeat Verification+Monitoring**: Special Documentation for the device →  7

Navigation  Expert → Diagnostics → Heartbeat Techn.



▶ Heartbeat Technology

- ▶ Heartbeat base settings →  309
- ▶ Performing verification →  310
- ▶ Verification results →  316
- ▶ Heartbeat Monitoring →  319
- ▶ Monitoring results →  320

"Heartbeat base settings" submenu

Navigation  Expert → Diagnostics → Heartbeat Techn. → Base settings

▶ Heartbeat base settings

- Plant operator (2754) →  309
- Location (2755) →  310

Plant operator

Navigation	 Expert → Diagnostics → Heartbeat Techn. → Base settings → Plant operator (2754)
Description	Use this function to enter the plant operator.
User entry	Max. 32 characters such as letters, numbers or special characters (e.g. @, %, /)















Location**Navigation** Expert → Diagnostics → Heartbeat Techn. → Base settings → Location (2755)**Description**

Use this function to enter the location.

User entry

Max. 32 characters such as letters, numbers or special characters (e.g. @, %, /)

"Performing verification" wizard*Navigation* Expert → Diagnostics → Heartbeat Techn. → Perform.verific.

► Performing verification	
Year (2846)	→  311
Month (2845)	→  311
Day (2842)	→  311
Hour (2843)	→  312
AM/PM (2813)	→  312
Minute (2844)	→  312
Verification mode (12105)	→  313
External device information (12101)	→  313
Start verification (12127)	→  313
Progress (2808)	→  314
Measured values (12102)	→  314
Output values (12103)	→  315
Status (12153)	→  315
Verification result (12149)	→  315

Year



Navigation	Expert → Diagnostics → Heartbeat Techn. → Perform.verific. → Year (2846)
Prerequisite	Can be edited if Heartbeat Verification is not active.
Description	Use this function to enter the year of recalibration.
User entry	9 to 99
Factory setting	10

Month





Navigation	Expert → Diagnostics → Heartbeat Techn. → Perform.verific. → Month (2845)
Prerequisite	Can be edited if Heartbeat Verification is not active.
Description	Use this function to select the month of recalibration.
Selection	<ul style="list-style-type: none"> ▪ January ▪ February ▪ March ▪ April ▪ May ▪ June ▪ July ▪ August ▪ September ▪ October ▪ November ▪ December
Factory setting	January

Day







Navigation	Expert → Diagnostics → Heartbeat Techn. → Perform.verific. → Day (2842)
Prerequisite	Can be edited if Heartbeat Verification is not active.
Description	Use this function to enter the day of the month of recalibration.
User entry	1 to 31 d
Factory setting	1 d



Hour 











Navigation	  Expert → Diagnostics → Heartbeat Techn. → Perform.verific. → Hour (2843)
Prerequisite	 Can be edited if Heartbeat Verification is not active.
Description	Use this function to enter the hour of recalibration.
User entry	0 to 23 h
Factory setting	12 h

AM/PM 

Navigation	  Expert → Diagnostics → Heartbeat Techn. → Perform.verific. → AM/PM (2813)
Prerequisite	 Can be edited if Heartbeat Verification is not active. The dd.mm.yy hh:mm am/pm option or the mm/dd/yy hh:mm am/pm option is selected in the Date/time format parameter (2812) (→  99).
Description	Use this function to select the time entry in the morning (AM option) or afternoon (PM option) in the case of 12-hour notation.
Selection	<ul style="list-style-type: none"> ▪ AM ▪ PM
Factory setting	AM

Minute 

Navigation	  Expert → Diagnostics → Heartbeat Techn. → Perform.verific. → Minute (2844)
Prerequisite	 Can be edited if Heartbeat Verification is not active.
Description	Use this function to enter the minutes of recalibration.
User entry	0 to 59 min
Factory setting	0 min

Verification mode 	
Navigation	  Expert → Diagnostics → Heartbeat Techn. → Perform.verific. → Verificat. mode (12105)
Prerequisite	Can be edited if verification status is not active.
Description	Select verification mode. Standard verification: Verification is performed automatically by the device and without manual checking of external measured variables. Extended verification: Similar to internal verification but with the entry of external measured variables (see also "Measured values" parameter).
Selection	<ul style="list-style-type: none"> ■ Standard verification ■ Extended verification
Factory setting	Standard verification
External device information 	
Navigation	  Expert → Diagnostics → Heartbeat Techn. → Perform.verific. → Ext. device info (12101)
Prerequisite	With the following conditions: <ul style="list-style-type: none"> ■ The Extended verification option is selected in the Verification mode parameter (→  313). ■ Can be edited if the verification status is not active.
Description	Record measuring equipment for extended verification.
User entry	Free text entry
Factory setting	–
Start verification 	
Navigation	  Expert → Diagnostics → Heartbeat Techn. → Perform.verific. → Start verificat. (12127)
Description	Start the verification. To carry out a complete verification, select the selection parameters individually. Once the external measured values have been recorded, verification is started using the Start option.

Selection	<ul style="list-style-type: none"> ■ Cancel ■ Output 1 low value * ■ Output 1 high value * ■ Output 2 low value * ■ Output 2 high value * ■ Output 3 low value * ■ Output 3 high value * ■ Frequency output 1 * ■ Pulse output 1 * ■ Frequency output 2 * ■ Pulse output 2 * ■ Double pulse output * ■ Start
------------------	---

Factory setting	Cancel
------------------------	--------

Progress

Navigation	 Expert → Diagnostics → Heartbeat Techn. → Perform.verific. → Progress (2808)
-------------------	--

Description	The progress of the process is indicated.
--------------------	---

User interface	0 to 100 %
-----------------------	------------

Measured values



Navigation	 Expert → Diagnostics → Heartbeat Techn. → Perform.verific. → Measured val. (12102)
-------------------	--

Prerequisite	One of the following options is selected in the Start verification parameter (→  313):
---------------------	--

- Output 1 low value
- Output 1 high value
- Output 2 low value
- Output 2 high value
- Output 3 low value
- Output 3 high value
- Frequency output 1
- Pulse output 1
- Frequency output 2
- Pulse output 2
- Double pulse output

Description	Use this function to enter the measured values (actual values) for the external measured variables:.
--------------------	--

- Current output: Output current in [mA]
- Pulse/frequency output: Output frequency in [Hz]
- Double pulse output: Output frequency in [Hz]

* Visibility depends on order options or device settings

User entry Signed floating-point number

Factory setting 0

Output values

Navigation  Expert → Diagnostics → Heartbeat Techn. → Perform.verific. → Output values (12103)

Description Displays the simulated output values (target values) for the external measured variables:

- Current output: Output current in [mA].
- Pulse/frequency output: Output frequency in [Hz].

User interface Signed floating-point number

Factory setting -

Status

Navigation  Expert → Diagnostics → Heartbeat Techn. → Perform.verific. → Status (12153)

Description Displays the current status of the verification.

User interface

- Done
- Busy
- Failed
- Not done

Verification result

Navigation  Expert → Diagnostics → Heartbeat Techn. → Perform.verific. → Verific. result (12149)

Description Displays the overall result of the verification.

 Detailed description of results classification:









User interface

- Not supported
- Passed
- Not done
- Failed

Factory setting Not done

"Verification results" submenu

Navigation  Expert → Diagnostics → Heartbeat Techn. → Verific. results

► Verification results	
Date/time (manually entered) (12142)	→  316
Verification ID (12141)	→  316
Operating time (12126)	→  317
Verification result (12149)	→  317
Sensor (12152)	→  317
HBSI (12167)	→  318
Sensor electronic module (ISEM) (12151)	→  318
I/O module (12145)	→  318
System status (12109)	→  319

Date/time (manually entered)

Navigation	 Expert → Diagnostics → Heartbeat Techn. → Verific. results → Date/time (12142)
Prerequisite	The verification has been performed.
Description	Date and time.
User interface	dd.mmmm.yyyy; hh:mm
Factory setting	1 January 2010; 12:00

Verification ID

Navigation	 Expert → Diagnostics → Heartbeat Techn. → Verific. results → Verification ID (12141)
Prerequisite	The verification has been performed.
Description	Displays consecutive numbering of the verification results in the measuring device.

User interface 0 to 65 535

Factory setting 0

Operating time

Navigation  Expert → Diagnostics → Heartbeat Techn. → Verific. results → Operating time (12126)

Prerequisite The verification has been performed.

Description Indicates how long the device has been in operation up to the verification.

User interface Days (d), hours (h), minutes (m), seconds (s)

Factory setting –

Verification result

Navigation  Expert → Diagnostics → Heartbeat Techn. → Verific. results → Verific. result (12149)

Description Displays the overall result of the verification.

 Detailed description of results classification:

User interface

- Not supported
- Passed
- Not done
- Failed

Factory setting Not done

Sensor

Navigation  Expert → Diagnostics → Heartbeat Techn. → Verific. results → Sensor (12152)

Prerequisite The **Failed** option result is shown in the **Overall result** parameter (→  315).

Description Displays the result for the sensor.



 Detailed description of results classification:

User interface

- Not supported
- Passed
- Not done
- Failed

Factory setting Not done

HBSI

Navigation   Expert → Diagnostics → Heartbeat Techn. → Verific. results → HBSI (12167)

Prerequisite In the **Overall result** parameter (→  315), the **Failed** option was displayed.

Description Displays the relative change in the sensor with all the sensor components.



 Detailed description of results classification:

User interface

- Not supported
- Passed
- Not done
- Failed

Factory setting Not done

Sensor electronic module (ISEM)

Navigation   Expert → Diagnostics → Heartbeat Techn. → Verific. results → Sens. electronic (12151)

Prerequisite The **Failed** option result is shown in the **Overall result** parameter (→  315).

Description Displays the result for the sensor electronics module (ISEM).



 Detailed description of results classification:

User interface

- Not supported
- Passed
- Not done
- Failed

Factory setting Not done

I/O module

Navigation   Expert → Diagnostics → Heartbeat Techn. → Verific. results → I/O module (12145)

Prerequisite In the **Overall result** parameter (→  315), the **Failed** option was displayed.

Description Displays the result for I/O module monitoring of the I/O module.

- For current output: Accuracy of the current
- For pulse output: Accuracy of the pulses
- For frequency output: Accuracy of the frequency
- Current input: Accuracy of the current
- Double pulse output: Accuracy of the pulses
- Relay output: Number of switching cycles

 Detailed description of results classification:

- User interface**
- Not supported
 - Passed
 - Not done
 - Not plugged
 - Failed

Factory setting Not done

System status

Navigation  Expert → Diagnostics → Heartbeat Techn. → Verific. results → System status (12109)

Prerequisite The **Failed** option result is shown in the **Overall result** parameter (→  315).

Description Displays the system condition. Tests the measuring device for active errors.

 Detailed description of results classification:



- User interface**
- Not supported
 - Passed
 - Not done
 - Failed

Factory setting Not done

"Heartbeat Monitoring" submenu

Navigation  Expert → Diagnostics → Heartbeat Techn. → Heartbeat Mon.

▶ **Heartbeat Monitoring**

Activate monitoring (12129)	→  320
HBSI cycle time (12110)	→  320

Activate monitoring

Navigation	Expert → Diagnostics → Heartbeat Techn. → Heartbeat Mon. → Act. monitoring (12129)
Description	Time-controlled HBSI option does not apply for Promass I and Promass Q.
Selection	Time-controlled HBSI
Factory setting	On

HBSI cycle time

Navigation	Expert → Diagnostics → Heartbeat Techn. → Heartbeat Mon. → HBSI cycle time (12110)
Prerequisite	In the Activate monitoring parameter (→ 320), the Time-controlled HBSI option is selected. Not available for Promass I.
Description	Use this function to enter the cycle time for determining the HBSI measured value. The HBSI measured value may only be determined in the configured cycle time in the firmware if the Activate monitoring parameter (→ 320) is set to Scheduled HBSI option.
User entry	0.5 to 4 320 h
Factory setting	12 h

"Monitoring results" submenu

Navigation Expert → Diagnostics → Heartbeat Techn. → Monitor. results

▶ Monitoring results	
HBSI (12115)	→ 321
HBSI value reliability (6380)	→ 321

HBSI

Navigation	📄📄 Expert → Diagnostics → Heartbeat Techn. → Monitor. results → HBSI (12115)
Description	Displays the relative change of the entire sensor, with all its electrical, mechanical and electromechanical components incorporated in the sensor housing (including the measuring tube, electrodynamic pick-ups, excitation system, cables etc.), in % of the reference value.
User interface	Signed floating-point number
Factory setting	0...4 %

HBSI value reliability

Navigation	📄📄 Expert → Diagnostics → Heartbeat Techn. → Monitor. results → HBSI val.reliab. (6380)
Description	Shows the status of the HBSI value. Uncertain or Bad: Due to difficult process conditions over a long time no HBSI value could be determined.
User interface	<ul style="list-style-type: none"> ▪ Good ▪ Uncertain ▪ Bad
Factory setting	Uncertain

3.8.14 "Simulation" submenu

Navigation 📄📄 Expert → Diagnostics → Simulation



▶ Simulation

Assign simulation process variable (1810)	→ 📄 322
Process variable value (1811)	→ 📄 323
Current output 1 to n simulation (0354-1 to n)	→ 📄 324
Current output value (0355)	→ 📄 324
Frequency output 1 to n simulation (0472-1 to n)	→ 📄 325

Frequency output 1 to n value (0473-1 to n)	→  325
Pulse output simulation 1 to n (0458-1 to n)	→  325
Pulse value 1 to n (0459-1 to n)	→  326
Switch output simulation 1 to n (0462-1 to n)	→  326
Switch state 1 to n (0463-1 to n)	→  327
Relay output 1 to n simulation (0802-1 to n)	→  327
Switch state 1 to n (0803-1 to n)	→  328
Pulse output simulation (0988)	→  328
Pulse value (0989)	→  329
Device alarm simulation (0654)	→  329
Diagnostic event category (0738)	→  330
Diagnostic event simulation (0737)	→  330
Current input 1 to n simulation (1608-1 to n)	→  330
Value current input 1 to n (1609-1 to n)	→  331
Status input 1 to n simulation (1355-1 to n)	→  331
Input signal level 1 to n (1356-1 to n)	→  332

Assign simulation process variable

Navigation



  Expert → Diagnostics → Simulation → Assign proc.var. (1810)

Description



Use this function to select a process variable for the simulation process that is activated. The display alternates between the measured value and a diagnostic message of the "Function check" category (C) while simulation is in progress.

Selection	<ul style="list-style-type: none"> ■ Off ■ Mass flow ■ Volume flow ■ Corrected volume flow[*] ■ Target volume flow[*] ■ Carrier volume flow[*] ■ Target corrected volume flow[*] ■ Carrier corrected volume flow[*] ■ Density ■ Reference density[*] ■ Reference density alternative[*] ■ GSV flow[*] ■ GSV flow alternative[*] ■ NSV flow[*] ■ NSV flow alternative[*] ■ S&W volume flow[*] ■ Water cut[*] ■ Oil density[*] ■ Water density[*] ■ Oil mass flow[*] ■ Water mass flow[*] ■ Oil volume flow[*] ■ Water volume flow[*] ■ Oil corrected volume flow[*] ■ Water corrected volume flow[*] ■ Temperature ■ Dynamic viscosity[*] ■ Kinematic viscosity[*] ■ Temp. compensated dynamic viscosity[*] ■ Temp. compensated kinematic viscosity[*] ■ Concentration[*] ■ Target mass flow[*] ■ Carrier mass flow[*] ■ Time period signal frequency (TPS)[*]
Factory setting	Off
Additional information	<p><i>Description</i></p> <p> The simulation value of the process variable selected is defined in the Process variable value parameter (→  323).</p>



Process variable value

Navigation	  Expert → Diagnostics → Simulation → Proc. var. value (1811)
Prerequisite	A process variable is selected in the Assign simulation process variable parameter (→  322).
Description	Use this function to enter a simulation value for the selected process variable. Subsequent measured value processing and the signal output use this simulation value. In this way, users can verify whether the measuring device has been configured correctly.



* Visibility depends on order options or device settings

User entry	Depends on the process variable selected
Factory setting	0
Additional information	<i>User entry</i>  The unit of the displayed measured value is taken from the System units submenu (→  89).

Current output 1 to n simulation

Navigation	 Expert → Diagnostics → Simulation → Curr.outp 1 to n sim. (0354-1 to n)
Description	Use this function to switch simulation of the current output on and off. The display alternates between the measured value and a diagnostic message of the "Function check" category (C) while simulation is in progress.
Selection	<ul style="list-style-type: none"> ■ Off ■ On
Factory setting	Off
Additional information	<i>Description</i>  The desired simulation value is defined in the Value current output 1 to n parameter. <i>Selection</i> <ul style="list-style-type: none"> ■ Off Current simulation is switched off. The device is in normal measuring mode or another process variable is being simulated. ■ On Current simulation is active.

Current output value

Navigation	 Expert → Diagnostics → Simulation → Curr.outp val. (0355)
Prerequisite	In the Current output 1 to n simulation parameter, the On option is selected.
Description	Use this function to enter a current value for the simulation. In this way, users can verify the correct adjustment of the current output and the correct function of downstream switching units.
User entry	3.59 to 22.5 mA
Additional information	<i>Dependency</i> The input range is dependent on the option selected in the Current span parameter (→  157).

Frequency output 1 to n simulation





Navigation	Expert → Diagnostics → Simulation → Freq.outp 1 to n sim. (0472-1 to n)
Prerequisite	In the Operating mode parameter (→ 171), the Frequency option is selected.
Description	Use this function to switch simulation of the frequency output on and off. The display alternates between the measured value and a diagnostic message of the "Function check" category (C) while simulation is in progress.
Selection	<ul style="list-style-type: none"> ▪ Off ▪ On
Factory setting	Off
Additional information	<p><i>Description</i></p> <p> The desired simulation value is defined in the Frequency value 1 to n parameter.</p> <p><i>Selection</i></p> <ul style="list-style-type: none"> ▪ Off Frequency simulation is switched off. The device is in normal measuring mode or another process variable is being simulated. ▪ On Frequency simulation is active.

Frequency output 1 to n value



Navigation	Expert → Diagnostics → Simulation → Freq.outp 1 to n val. (0473-1 to n)
Prerequisite	In the Frequency simulation 1 to n parameter, the On option is selected.
Description	Use this function to enter a frequency value for the simulation. In this way, users can verify the correct adjustment of the frequency output and the correct function of downstream switching units.
User entry	0.0 to 12 500.0 Hz

Pulse output simulation 1 to n





Navigation	Expert → Diagnostics → Simulation → Puls.outp.sim. 1 to n (0458-1 to n)
Prerequisite	In the Operating mode parameter (→ 171), the Pulse option is selected.
Description	Use this function to switch simulation of the pulse output on and off. The display alternates between the measured value and a diagnostic message of the "Function check" category (C) while simulation is in progress.

Selection	<ul style="list-style-type: none"> ■ Off ■ Fixed value ■ Down-counting value
Factory setting	Off
Additional information	<p><i>Description</i></p> <p> The desired simulation value is defined in the Pulse value 1 to n parameter.</p> <p><i>Selection</i></p> <ul style="list-style-type: none"> ■ Off Pulse simulation is switched off. The device is in normal measuring mode or another process variable is being simulated. ■ Fixed value Pulses are continuously output with the pulse width specified in the Pulse width parameter (→  174). ■ Down-counting value The pulses specified in the Pulse value parameter (→  326) are output.

Pulse value 1 to n



Navigation	  Expert → Diagnostics → Simulation → Pulse value 1 to n (0459-1 to n)
Prerequisite	In the Pulse output simulation 1 to n parameter, the Down-counting value option is selected.
Description	Use this function to enter a pulse value for the simulation. In this way, users can verify the correct adjustment of the pulse output and the correct function of downstream switching units.
User entry	0 to 65 535

Switch output simulation 1 to n



Navigation	  Expert → Diagnostics → Simulation → Switch sim. 1 to n (0462-1 to n)
Prerequisite	In the Operating mode parameter (→  171), the Switch option is selected.
Description	Use this function to switch simulation of the switch output on and off. The display alternates between the measured value and a diagnostic message of the "Function check" category (C) while simulation is in progress.
Selection	<ul style="list-style-type: none"> ■ Off ■ On
Factory setting	Off

Additional information	<p><i>Description</i></p> <p> The desired simulation value is defined in the Switch state 1 to n parameter.</p> <p><i>Selection</i></p> <ul style="list-style-type: none"> ▪ Off Switch simulation is switched off. The device is in normal measuring mode or another process variable is being simulated. ▪ On Switch simulation is active.
-------------------------------	--

Switch state 1 to n

Navigation	 Expert → Diagnostics → Simulation → Switch state 1 to n (0463-1 to n)
Description	Use this function to select a switch value for the simulation. In this way, users can verify the correct adjustment of the switch output and the correct function of downstream switching units.
Selection	<ul style="list-style-type: none"> ▪ Open ▪ Closed
Additional information	<p><i>Selection</i></p> <ul style="list-style-type: none"> ▪ Open Switch simulation is switched off. The device is in normal measuring mode or another process variable is being simulated. ▪ Closed Switch simulation is active.

Relay output 1 to n simulation

Navigation	 Expert → Diagnostics → Simulation → Relay out. 1 to n sim (0802-1 to n)
Description	Use this function to switch simulation of the relay output on and off. The display alternates between the measured value and a diagnostic message of the "Function check" category (C) while simulation is in progress.
Selection	<ul style="list-style-type: none"> ▪ Off ▪ On
Factory setting	Off

Additional information*Description*

 The desired simulation value is defined in the **Switch state 1 to n** parameter.

Selection

- Off
Relay simulation is switched off. The device is in normal measuring mode or another process variable is being simulated.
- On
Relay simulation is active.

Switch state 1 to n**Navigation**

 Expert → Diagnostics → Simulation → Switch state 1 to n (0803-1 to n)

Prerequisite

The **On** option is selected in the **Switch output simulation 1 to n** parameter parameter.

Description

Use this function to select a relay value for the simulation. In this way, users can verify the correct adjustment of the relay output and the correct function of downstream switching units.

Selection

- Open
- Closed

Additional information*Selection*

- Open
Relay simulation is switched off. The device is in normal measuring mode or another process variable is being simulated.
- Closed
Relay simulation is active.

Pulse output simulation**Navigation**

 Expert → Diagnostics → Simulation → Puls.outp.sim. (0988)

Description









Use this function to switch simulation of the double pulse output on and off. The display alternates between the measured value and a diagnostic message of the "Function check" category (C) while simulation is in progress.

Selection



- Off
- Fixed value
- Down-counting value

Factory setting





Off

Additional information	<p><i>Description</i></p> <p> The desired simulation value is defined in the Pulse value parameter (→  329).</p> <p><i>Selection</i></p> <ul style="list-style-type: none"> ▪ Off Simulation of the double pulse output is switched off. The device is in normal measuring mode or another process variable is being simulated. ▪ Fixed value Pulses are continuously output with the pulse width specified in the Pulse width parameter (→  200). ▪ Down-counting value The pulses specified in the Pulse value parameter (→  329) are output.
<hr/>	
Pulse value	
Navigation	 Expert → Diagnostics → Simulation → Pulse value (0989)
Prerequisite	In the Pulse output simulation parameter (→  328), the Down-counting value option is selected.
Description	Use this function to enter a pulse value for simulation of the double pulse output. In this way, users can verify the correct adjustment of the double pulse output and the correct function of downstream switching units.
User entry	0 to 65 535
<hr/>	
Device alarm simulation	
Navigation	 Expert → Diagnostics → Simulation → Dev. alarm sim. (0654)
Description	Use this function to switch the device alarm on and off.
Selection	<ul style="list-style-type: none"> ▪ Off ▪ On
Factory setting	Off
Additional information	<p><i>Description</i></p> <p>The display alternates between the measured value and a diagnostic message of the "Function check" category (C) while simulation is in progress.</p>



Diagnostic event category





Navigation	 Expert → Diagnostics → Simulation → Event category (0738)
Description	Use this function to select the category of the diagnostic events that are displayed for the simulation in the Diagnostic event simulation parameter (→  330).
Selection	<ul style="list-style-type: none"> ■ Sensor ■ Electronics ■ Configuration ■ Process
Factory setting	Process





Diagnostic event simulation

Navigation	  Expert → Diagnostics → Simulation → Diag. event sim. (0737)
Description	Use this function to select a diagnostic event for the simulation process that is activated.
Selection	<ul style="list-style-type: none"> ■ Off ■ Diagnostic event picklist (depends on the category selected)
Factory setting	Off
Additional information	<p><i>Description</i></p> <p> For the simulation, you can choose from the diagnostic events of the category selected in the Diagnostic event category parameter (→  330).</p>

Current input 1 to n simulation

Navigation	  Expert → Diagnostics → Simulation → Curr.inp 1 to n sim. (1608-1 to n)
Description	<p>Option for switching simulation of the current input on and off. The display alternates between the measured value and a diagnostic message of the "Function check" category (C) while simulation is in progress.</p> <p> The desired simulation value is defined in the Value current input 1 to n parameter.</p>
Selection	<ul style="list-style-type: none"> ■ Off ■ On
Factory setting	Off

Additional information	<i>Selection</i> <ul style="list-style-type: none"> ▪ Off Current simulation is switched off. The device is in normal measuring mode or another process variable is being simulated. ▪ On Current simulation is active.
<hr/>	
Value current input 1 to n 	
Navigation	  Expert → Diagnostics → Simulation → Value curr.inp 1 to n (1609–1 to n)
Prerequisite	In the Current input 1 to n simulation parameter, the On option is selected.
Description	Use this function to enter the current value for the simulation. In this way, users can verify the correct configuration of the current input and the correct function of upstream feed-in units.
User entry	0 to 22.5 mA

<hr/>	
Status input 1 to n simulation 	
Navigation	  Expert → Diagnostics → Simulation → Status inp 1 to n sim (1355–1 to n)
Description	Use this function to switch simulation of the status input on and off. The display alternates between the measured value and a diagnostic message of the "Function check" category (C) while simulation is in progress.
Selection	<ul style="list-style-type: none"> ▪ Off ▪ On
Factory setting	Off
Additional information	<i>Description</i> <p> The desired simulation value is defined in the Input signal level parameter (→  332).</p> <i>Selection</i> <ul style="list-style-type: none"> ▪ Off Simulation for the status input is switched off. The device is in normal measuring mode or another process variable is being simulated. ▪ On Simulation for the status input is active.

Input signal level 1 to n

**Navigation**

Expert → Diagnostics → Simulation → Signal level 1 to n (1356-1 to n)

Prerequisite

In the **Status input simulation** parameter (→ 331), the **On** option is selected.

Description

Use this function to select the signal level for the simulation of the status input. In this way, users can verify the correct configuration of the status input and the correct function of upstream feed-in units.

Selection

- High
- Low

4 Country-specific factory settings

4.1 SI units

 Not valid for USA and Canada.



4.1.1 System units

Process variable	Unit
Mass	kg
Mass flow	kg/h
Volume	l
Volume flow	l/h
Corrected volume	NI
Corrected volume flow	NI/h
Density	kg/l
Reference density	kg/NI
Temperature	°C
Pressure	bar a

4.1.2 Full scale values

 The factory settings apply to the following parameters:

- 20 mA value (full scale value of the current output)
- 100% bar graph value 1

 For detailed information about the full scale value for measuring devices for custody transfer, see the Special Documentation for the device →  7

Nominal diameter [mm]	[kg/h]
1	4
2	20
4	90
8	400
15	1300
15 FB	3600
25	3600
25 FB	9000
40	9000
40 FB	14000
50	14000
50 FB	36000
80	36000
100	60000
150	130 t/h
200	230 t/h

Nominal diameter [mm]	[kg/h]
250	360 t/h
350	650 t/h

4.1.3 Output current span

Output	Current range
Current output 1...n	4 to 20 mA NAMUR

4.1.4 Pulse value



For detailed information about the pulse value for measuring devices for custody transfer, see the Special Documentation for the device → 7

Nominal diameter [mm]	[kg/p]
1	0.001
2	0.01
4	0.01
8	0.1
15	0.1
15 FB	1
25	1
25 FB	1
40	1
40 FB	10
50	10
50 FB	10
80	10
100	10
150	100
200	100
250	100
350	100

4.1.5 Switch-on point low flow cut off



The switch-on point depends on the type of medium and the nominal diameter.

Nominal diameter [mm]	On-value for liquid [kg/h]
1	0.08
2	0.4
4	1.8
8	8
15	26

Nominal diameter [mm]	On-value for liquid [kg/h]
15 FB	72
25	72
25 FB	180
40	180
40 FB	300
50	300
50 FB	720
80	720
100	1200
150	2.6 t/h
200	1.15 t/h
250	4.6 t/h
350	13 t/h

Nominal diameter [mm]	On-value for gas [kg/h]
1	0.02
2	0.1
4	0.45
8	2
15	6.5
15 FB	18
25	18
25 FB	45
40	45
40 FB	75
50	75
50 FB	180
80	180
100	300
150	650
200	1.0 t/h
250	1.8 t/h
350	3.25 t/h

4.2 US units



 Only valid for USA and Canada.

4.2.1 System units

Process variable	Unit
Mass	lb
Mass flow	lb/min
Volume	gal (us)
Volume flow	gal/min (us)
Corrected volume	Sft ³
Corrected volume flow	Sft ³ /min
Density	lb/ft ³
Reference density	lb/Sft ³
Temperature	°F
Pressure	psi a

4.2.2 Full scale values

-  The factory settings apply to the following parameters:
- 20 mA value (full scale value of the current output)
 - 100% bar graph value 1

 For detailed information about the full scale value for measuring devices for custody transfer, see the Special Documentation for the device →  7

Nominal diameter [in]	[lb/min]
1/24	0.15
1/12	0.75
1/8	3.3
3/8	15
1/2	50
1/2 FB	130
1	130
1 FB	330
1 1/2	330
1 1/2 FB	550
2	550
2 FB	1300
3	1300
4	2200
6	4800
8	8500
10	13000
14	23500

4.2.3 Output current span

Output	Current range
Current output 1...n	4 to 20 mA US

4.2.4 Pulse value



For detailed information about the pulse value for measuring devices for custody transfer, see the Special Documentation for the device → 7

Nominal diameter [in]	[lb/p]
1/24	0.002
1/12	0.02
1/8	0.02
3/8	0.2
1/2	0.2
1/2 FB	2
1	2
1 FB	2
1 1/2	2
1 1/2 FB	20
2	20
2 FB	20
3	20
4	20
6	200
8	200
10	200
14	200

4.2.5 Switch-on point low flow cut off



The switch-on point depends on the type of medium and the nominal diameter.

Nominal diameter [in]	On-value for liquid [lb/min]
1/24	0.003
1/12	0.015
1/8	0.066
3/8	0.3
1/2	1
1/2 FB	2.6
1	2.6
1 FB	6.6
1 1/2	6.6
1 1/2 FB	11
2	11
2 FB	26
3	26
4	44
6	95

Nominal diameter [in]	On-value for liquid [lb/min]
8	165
10	260
14	470

Nominal diameter [in]	On-value for gas [lb/min]
$\frac{1}{24}$	0.001
$\frac{1}{12}$	0.004
$\frac{1}{8}$	0.016
$\frac{3}{8}$	0.075
$\frac{1}{2}$	0.25
$\frac{1}{2}$ FB	0.65
1	0.65
1 FB	1.65
$1\frac{1}{2}$	1.65
$1\frac{1}{2}$ FB	2.75
2	2.75
2 FB	6.5
3	6.5
4	11
6	23.75
8	36.74
10	65
14	117.5

5 Explanation of abbreviated units

5.1 SI units

Process variable	Units	Explanation
Density	g/cm ³ , g/m ³	Gram/volume unit
	kg/dm ³ , kg/l, kg/m ³	Kilogram/volume unit
	SD4°C, SD15°C, SD20°C	Specific density: The specific density is the ratio of the density of the fluid to the density of water at a water temperature of 4 °C (39 °F), 15 °C (59 °F), 20 °C (68 °F).
	SG4°C, SG15°C, SG20°C	Specific gravity: The specific gravity is the ratio of the density of the fluid to the density of water at a water temperature of 4 °C (39 °F), 15 °C (59 °F), 20 °C (68 °F).
Pressure	Pa a, kPa a, MPa a	Pascal, kilopascal, megapascal (absolute)
	bar	Bar
	Pa g, kPa g, MPa g	Pascal, kilopascal, megapascal (relative/gauge)
	bar g	Bar (relative/gauge)
Mass	g, kg, t	Gram, kilogram, metric ton
Mass flow	g/s, g/min, g/h, g/d	Gram/time unit
	kg/s, kg/min, kg/h, kg/d	Kilogram/time unit
	t/s, t/min, t/h, t/d	Metric ton/time unit
Reference density	kg/Nm ³ , kg/Nl, g/Scm ³ , kg/Sm ³	Kilogram, gram/standard volume unit
Corrected volume	Nl, Nm ³ , Sm ³	Normal liter, normal cubic meter, standard cubic meter
Corrected volume flow	Nl/s, Nl/min, Nl/h, Nl/d	Normal liter/time unit
	Nm ³ /s, Nm ³ /min, Nm ³ /h, Nm ³ /d	Normal cubic meter/time unit
	Sm ³ /s, Sm ³ /min, Sm ³ /h, Sm ³ /d	Standard cubic meter/time unit
Temperature	°C, K	Celsius, Kelvin
Volume	cm ³ , dm ³ , m ³	Cubic centimeter, cubic decimeter, cubic meter
	ml, l, hl, Ml Mega	Milliliter, liter, hectoliter, megaliter
Volume flow	cm ³ /s, cm ³ /min, cm ³ /h, cm ³ /d	Cubic centimeter/time unit
	dm ³ /s, dm ³ /min, dm ³ /h, dm ³ /d	Cubic decimeter/time unit
	m ³ /s, m ³ /min, m ³ /h, m ³ /d	Cubic meter/time unit
	ml/s, ml/min, ml/h, ml/d	Milliliter/time unit
	l/s, l/min, l/h, l/d	Liter/time unit
	hl/s, hl/min, hl/h, hl/d	Hectoliter/time unit
	Ml/s, Ml/min, Ml/h, Ml/d	Megaliter/time unit
Time	s, m, h, d, y	Second, minute, hour, day, year

5.2 US units

Process variable	Units	Explanation
Density	lb/ft ³ , lb/gal (us)	Pound/cubic foot, pound/gallon
	lb/bbl (us;liq.), lb/bbl (us;beer), lb/bbl (us;oil), lb/bbl (us;tank)	Pound/volume unit

Process variable	Units	Explanation
Pressure	psi a	Pounds per square inch (absolute)
	psi g	Pounds per square inch (gauge)
Mass	oz, lb, STon	Ounce, pound, standard ton
Mass flow	oz/s, oz/min, oz/h, oz/d	Ounce/time unit
	lb/s, lb/min, lb/h, lb/d	Pound/time unit
	STon/s, STon/min, STon/h, STon/d	Standard ton/time unit
Reference density	lb/Sft ³	Weight unit/standard volume unit
Corrected volume	Sft ³ , Sgal (us), Sbbl (us;liq.)	Standard cubic foot, standard gallon, standard barrel
Corrected volume flow	Sft ³ /s, Sft ³ /min, Sft ³ /h, Sft ³ /d	Standard cubic foot/time unit
	Sgal/s (us), Sgal/min (us), Sgal/h (us), Sgal/d (us)	Standard gallon/time unit
	Sbbl/s (us;liq.), Sbbl/min (us;liq.), Sbbl/h (us;liq.), Sbbl/d (us;liq.)	Barrel/time unit (normal liquids)
Temperature	°F, °R	Fahrenheit, Rankine
Volume	af	Acre foot
	ft ³	Cubic foot
	fl oz (us), gal (us), kgal (us), Mgal (us)	Fluid ounce, gallon, kilogallon, million gallon
	bbbl (us;liq.), bbl (us;beer), bbl (us;oil), bbl (us;tank)	Barrel (normal liquids), barrel (beer), barrel (petrochemicals), barrel (filling tanks)
Volume flow	af/s, af/min, af/h, af/d	Acre foot/time unit
	ft ³ /s, ft ³ /min, ft ³ /h, ft ³ /d	Cubic foot/time unit
	fl oz/s (us), fl oz/min (us), fl oz/h (us), fl oz/d (us)	Fluid ounce/time unit
	gal/s (us), gal/min (us), gal/h (us), gal/d (us)	Gallon/time unit
	kgal/s (us), kgal/min (us), kgal/h (us), kgal/d (us)	Kilogallon/time unit
	Mgal/s (us), Mgal/min (us), Mgal/h (us), Mgal/d (us)	Million gallon/time unit
	bbbl/s (us;liq.), bbl/min (us;liq.), bbl/h (us;liq.), bbl/d (us;liq.)	Barrel/time unit (normal liquids) Normal liquids: 31.5 gal/bbl
	bbbl/s (us;beer), bbl/min (us;beer), bbl/h (us;beer), bbl/d (us;beer)	Barrel /time unit (beer) Beer: 31.0 gal/bbl
	bbbl/s (us;oil), bbl/min (us;oil), bbl/h (us;oil), bbl/d (us;oil)	Barrel/time unit (petrochemicals) Petrochemicals: 42.0 gal/bbl
	bbbl/s (us;tank), bbl/min (us;tank), bbl/h (us;tank), bbl/d (us;tank)	Barrel/time unit (filling tank) Filling tanks: 55.0 gal/bbl
Time	s, m, h, d, y	Second, minute, hour, day, year
	am, pm	Ante meridiem (before midday), post meridiem (after midday)

5.3 Imperial units

Process variable	Units	Explanation
Density	lb/gal (imp), lb/bbl (imp;beer), lb/bbl (imp;oil)	Pound/volume unit
Corrected volume	Sgal (imp)	Standard gallon
Corrected volume flow	Sgal/s (imp), Sgal/min (imp), Sgal/h (imp), Sgal/d (imp)	Standard gallon/time unit
Volume	gal (imp), Mgal (imp)	Gallon, mega gallon
	bbl (imp;beer), bbl (imp;oil)	Barrel (beer), barrel (petrochemicals)
Volume flow	gal/s (imp), gal/min (imp), gal/h (imp), gal/d (imp)	Gallon/time unit
	Mgal/s (imp), Mgal/min (imp), Mgal/h (imp), Mgal/d (imp)	Mega gallon/time unit
	bbl/s (imp;beer), bbl/min (imp;beer), bbl/h (imp;beer), bbl/d (imp;beer)	Barrel /time unit (beer) Beer: 36.0 gal/bbl
	bbl/s (imp;oil), bbl/min (imp;oil), bbl/h (imp;oil), bbl/d (imp;oil)	Barrel/time unit (petrochemicals) Petrochemicals: 34.97 gal/bbl
Time	s, m, h, d, y	Second, minute, hour, day, year
	am, pm	Ante meridiem (before midday), post meridiem (after midday)

Index

0 ... 9

0/4 mA value (Parameter)	150
0% bargraph value 1 (Parameter)	21
0% bargraph value 3 (Parameter)	24
2.4 GHz WLAN channel (Parameter)	252
20 mA value (Parameter)	151
100% bargraph value 1 (Parameter)	22
100% bargraph value 3 (Parameter)	24

A

Abort cause (Parameter)	133, 136
Activate monitoring (Parameter)	320
Activate SW option (Parameter)	55
Active level (Parameter)	153
Actual diagnostics (Parameter)	269
Additional information (Parameter)	132, 136
Administration (Submenu)	51
Alarm delay (Parameter)	38
AM/PM (Parameter)	312
Application (Submenu)	254
Application specific calculations (Submenu)	260
Application specific input 0 (Parameter)	264
Application specific input 1 (Parameter)	265
Application specific input source 0 (Parameter)	114
Application specific input source 1 (Parameter)	114
Application specific output 0 (Parameter)	266
Application specific output 1 (Parameter)	266
Application-specific parameters (Submenu)	260
Apply I/O configuration (Parameter)	148
Assign behavior of diagnostic no. 046 (Parameter)	41
Assign behavior of diagnostic no. 140 (Parameter)	41
Assign behavior of diagnostic no. 142 (Parameter)	41
Assign behavior of diagnostic no. 144 (Parameter)	42
Assign behavior of diagnostic no. 302 (Parameter)	42
Assign behavior of diagnostic no. 304 (Parameter)	43
Assign behavior of diagnostic no. 374 (Parameter)	42
Assign behavior of diagnostic no. 441 (Parameter)	43
Assign behavior of diagnostic no. 442 (Parameter)	43
Assign behavior of diagnostic no. 443 (Parameter)	44
Assign behavior of diagnostic no. 444 (Parameter)	44
Assign behavior of diagnostic no. 543 (Parameter)	44
Assign behavior of diagnostic no. 599 (Parameter)	45
Assign behavior of diagnostic no. 830 (Parameter)	45
Assign behavior of diagnostic no. 831 (Parameter)	45
Assign behavior of diagnostic no. 832 (Parameter)	46
Assign behavior of diagnostic no. 833 (Parameter)	46
Assign behavior of diagnostic no. 834 (Parameter)	46
Assign behavior of diagnostic no. 835 (Parameter)	47
Assign behavior of diagnostic no. 842 (Parameter)	47
Assign behavior of diagnostic no. 862 (Parameter)	48
Assign behavior of diagnostic no. 912 (Parameter)	48
Assign behavior of diagnostic no. 913 (Parameter)	48
Assign behavior of diagnostic no. 915 (Parameter)	49
Assign behavior of diagnostic no. 941 (Parameter)	49
Assign behavior of diagnostic no. 942 (Parameter)	49
Assign behavior of diagnostic no. 943 (Parameter)	50

Assign behavior of diagnostic no. 944 (Parameter)	50
Assign behavior of diagnostic no. 948 (Parameter)	51
Assign behavior of diagnostic no. 984 (Parameter)	51
Assign channel 1 (Parameter)	289
Assign channel 2 (Parameter)	291
Assign channel 3 (Parameter)	292
Assign channel 4 (Parameter)	292
Assign diagnostic behavior (Parameter)	184, 193
Assign flow direction check (Parameter)	187, 192
Assign frequency output (Parameter)	177
Assign limit (Parameter)	184, 192
Assign process variable (Parameter)	103, 106, 255
Assign pulse output (Parameter)	173, 199
Assign PV (Parameter)	222
Assign QV (Parameter)	228
Assign simulation process variable (Parameter)	322
Assign SSID name (Parameter)	251
Assign status (Parameter)	188, 194
Assign status input (Parameter)	152
Assign SV (Parameter)	224
Assign TV (Parameter)	226

B

Backlight (Parameter)	34
Backup state (Parameter)	36
Bootloader revision (Parameter)	283, 284, 285, 286, 287, 288
Build no. software (Parameter)	282, 283, 285, 286, 287, 288
Burst command (Parameter)	205
Burst command 1 to n (Parameter)	212
Burst configuration 1 to n (Submenu)	211
Burst mode 1 to n (Parameter)	212
Burst trigger level (Parameter)	217
Burst trigger mode (Parameter)	216
Burst variable 0 (Parameter)	213
Burst variable 1 (Parameter)	215
Burst variable 2 (Parameter)	215
Burst variable 3 (Parameter)	215
Burst variable 4 (Parameter)	215
Burst variable 5 (Parameter)	216
Burst variable 6 (Parameter)	216
Burst variable 7 (Parameter)	216

C

CO to 5 (Parameter)	138
Calculated values (Submenu)	114
Calibration (Submenu)	137
Calibration factor (Parameter)	138
Capture mode (Parameter)	204
Carrier corrected volume flow (Parameter)	65
Carrier mass flow (Parameter)	65
Carrier pipe temperature (Parameter)	143
Carrier pipe temperature (Submenu)	301
Carrier volume flow (Parameter)	66
Casing pipe temperature (Parameter)	144

- Clear logging data (Parameter) 293
 - Combined density-pressure factor (Parameter) 125
 - Combined density-temperature factor (Parameter) 125
 - Combined temperature-pressure factor (Parameter) 126
 - Communication (Submenu) 202
 - Comparison result (Parameter) 36
 - Concentration (Parameter) 64
 - Concentration (Submenu) 260
 - Configuration (Submenu) 203, 209
 - Configuration backup (Submenu) 34
 - Configuration counter (Parameter) 281
 - Configuration management (Parameter) 35
 - Confirm access code (Parameter) 53
 - Connection state (Parameter) 252
 - Constant offset (Parameter) 123
 - Contrast display (Parameter) 34
 - Control Totalizer 1 to n (Parameter) 258
 - Corrected volume flow (Parameter) 61
 - Corrected volume flow calculation (Submenu) 115
 - Corrected volume flow factor (Parameter) 129
 - Corrected volume flow offset (Parameter) 129
 - Corrected volume flow unit (Parameter) 94
 - Corrected volume unit (Parameter) 94
 - CPL (Parameter) 67
 - CPL alternative (Parameter) 73
 - CTL (Parameter) 67
 - CTL alternative (Parameter) 73
 - CTPL (Parameter) 67
 - Cubic temperature factor (Parameter) 126
 - Current input 1 to n (Submenu) 84, 149
 - Current input 1 to n simulation (Parameter) 330
 - Current output 1 to n (Submenu) 154
 - Current output 1 to n simulation (Parameter) 324
 - Current output value (Parameter) 324
 - Current range output (Parameter) 157
 - Current span (Parameter) 150
 - Custody transfer (Submenu) 260
 - Custody transfer logbook (Submenu) 278
 - Cut off inhomogeneous liquid (Parameter) 267
 - Cut off inhomogeneous wet gas (Parameter) 267
 - Cut off suspended bubbles (Parameter) 268
- D**
- Damping current output (Parameter) 166
 - Damping output (Parameter) 181
 - Data logging (Parameter) 293
 - Data logging (Submenu) 288
 - Data logging control (Parameter) 294
 - Data logging status (Parameter) 295
 - Date/time (manually entered) (Parameter) 316
 - Date/time format (Parameter) 99
 - Day (Parameter) 311
 - Decimal places 1 (Parameter) 22
 - Decimal places 2 (Parameter) 23
 - Decimal places 3 (Parameter) 25
 - Decimal places 4 (Parameter) 26
 - Decimal places 5 (Parameter) 27
 - Decimal places 6 (Parameter) 28
 - Decimal places 7 (Parameter) 29
 - Decimal places 8 (Parameter) 30
 - Default gateway (Parameter) 246
 - Define access code (Parameter) 52
 - Define access code (Wizard) 52
 - Density (Parameter) 61
 - Density 2 (Parameter) 76
 - Density 2 unit (Parameter) 97
 - Density adjustment (Wizard) 120
 - Density adjustment factor (Parameter) 122
 - Density adjustment mode (Parameter) 121
 - Density adjustment offset (Parameter) 122
 - Density damping (Parameter) 101
 - Density factor (Parameter) 129
 - Density limit (Parameter) 102
 - Density offset (Parameter) 128
 - Density setpoint 1 (Parameter) 121
 - Density setpoint 2 (Parameter) 121
 - Density unit (Parameter) 95
 - Device alarm simulation (Parameter) 329
 - Device ID (Parameter) 204, 219
 - Device information (Submenu) 278
 - Device name (Parameter) 280
 - Device reset (Parameter) 54
 - Device revision (Parameter) 219
 - Device tag (Parameter) 209, 279
 - Device type (Parameter) 204, 219
 - DHCP client (Parameter) 245
 - Diagnostic behavior (Submenu) 38
 - Diagnostic configuration (Submenu) 230
 - Diagnostic event category (Parameter) 330
 - Diagnostic event simulation (Parameter) 330
 - Diagnostic handling (Submenu) 37
 - Diagnostic list (Submenu) 272
 - Diagnostics (Submenu) 269
 - Diagnostics 1 (Parameter) 272
 - Diagnostics 2 (Parameter) 273
 - Diagnostics 3 (Parameter) 274
 - Diagnostics 4 (Parameter) 274
 - Diagnostics 5 (Parameter) 275
 - Direct access
 - 0/4 mA value
 - Current input 1 to n (1606–1 to n) 150
 - 0% bargraph value 1 (0123) 21
 - 0% bargraph value 3 (0124) 24
 - 2.4 GHz WLAN channel (2704) 252
 - 20 mA value
 - Current input 1 to n (1607–1 to n) 151
 - 100% bargraph value 1 (0125) 22
 - 100% bargraph value 3 (0126) 24
 - Activate monitoring (12129) 320
 - Activate SW option (0029) 55
 - Active level
 - Status input 1 to n (1351–1 to n) 153
 - Actual diagnostics (0691) 269
 - Alarm delay (0651) 38
 - AM/PM (2813) 312
 - Application specific input 0 (6366) 264
 - Application specific input 1 (6367) 265
 - Application specific input source 0 (6401) 114

- Application specific input source 1 (6402) 114
- Application specific output 0 (6364) 266
- Application specific output 1 (6365) 266
- Apply I/O configuration (3907) 148
- Assign behavior of diagnostic no. 046 (0709) 41
- Assign behavior of diagnostic no. 140 (0708) 41
- Assign behavior of diagnostic no. 142 (0648) 41
- Assign behavior of diagnostic no. 144 (0731) 42
- Assign behavior of diagnostic no. 302 (0739) 42
- Assign behavior of diagnostic no. 304 (0644) 43
- Assign behavior of diagnostic no. 374 (0710) 42
- Assign behavior of diagnostic no. 441 (0657) 43
- Assign behavior of diagnostic no. 442 (0658) 43
- Assign behavior of diagnostic no. 443 (0659) 44
- Assign behavior of diagnostic no. 444 (0740) 44
- Assign behavior of diagnostic no. 543 (0643) 44
- Assign behavior of diagnostic no. 599 (0646) 45
- Assign behavior of diagnostic no. 830 (0800) 45
- Assign behavior of diagnostic no. 831 (0641) 45
- Assign behavior of diagnostic no. 832 (0681) 46
- Assign behavior of diagnostic no. 833 (0682) 46
- Assign behavior of diagnostic no. 834 (0700) 46
- Assign behavior of diagnostic no. 835 (0702) 47
- Assign behavior of diagnostic no. 842 (0638) 47
- Assign behavior of diagnostic no. 862 (0679) 48
- Assign behavior of diagnostic no. 912 (0703) 48
- Assign behavior of diagnostic no. 913 (0712) 48
- Assign behavior of diagnostic no. 915 (0649) 49
- Assign behavior of diagnostic no. 941 (0632) 49
- Assign behavior of diagnostic no. 942 (0633) 49
- Assign behavior of diagnostic no. 943 (0634) 50
- Assign behavior of diagnostic no. 944 (0732) 50
- Assign behavior of diagnostic no. 948 (0744) 51
- Assign behavior of diagnostic no. 984 (0647) 51
- Assign channel 1 (0851) 289
- Assign channel 2 (0852) 291
- Assign channel 3 (0853) 292
- Assign channel 4 (0854) 292
- Assign diagnostic behavior
 - Pulse/frequency/switch output 1 to n (0482–1 to n) 184
 - Relay output 1 to n (0806–1 to n) 193
- Assign flow direction check
 - Pulse/frequency/switch output 1 to n (0484–1 to n) 187
 - Relay output 1 to n (0808–1 to n) 192
- Assign frequency output
 - Pulse/frequency/switch output 1 to n (0478–1 to n) 177
- Assign limit
 - Pulse/frequency/switch output 1 to n (0483–1 to n) 184
 - Relay output 1 to n (0807–1 to n) 192
- Assign process variable
 - Totalizer 1 to n (0914–1 to n) 255
- Assign process variable (1837) 103
- Assign process variable (1860) 106
- Assign pulse output
 - Pulse/frequency/switch output 1 to n (0460–1 to n) 173
- Assign pulse output (0982) 199
- Assign PV (0234) 222
- Assign QV (0237) 228
- Assign simulation process variable (1810) 322
- Assign SSID name (2708) 251
- Assign status
 - Pulse/frequency/switch output 1 to n (0485–1 to n) 188
 - Relay output 1 to n (0805–1 to n) 194
- Assign status input
 - Status input 1 to n (1352–1 to n) 152
- Assign SV (0235) 224
- Assign TV (0236) 226
- Backlight (0111) 34
- Backup state (2759) 36
- Bootloader revision
 - I/O module 2 (0073) 285, 286, 287
 - I/O module 3 (0073) 285, 286, 287
 - I/O module 4 (0073) 285, 286, 287
- Bootloader revision (0073) 283, 284, 288
- Build no. software
 - I/O module 2 (0079) 285, 286, 287
 - I/O module 3 (0079) 285, 286, 287
 - I/O module 4 (0079) 285, 286, 287
- Build no. software (0079) 282, 283, 288
- Burst command (7006) 205
- Burst command 1 to n (2031–1 to n) 212
- Burst mode 1 to n (2032–1 to n) 212
- Burst trigger level
 - Burst configuration 1 to n (2043–1 to n) 217
- Burst trigger mode
 - Burst configuration 1 to n (2044–1 to n) 216
- Burst variable 0
 - Burst configuration 1 to n (2033) 213
- Burst variable 1
 - Burst configuration 1 to n (2034) 215
- Burst variable 2
 - Burst configuration 1 to n (2035) 215
- Burst variable 3
 - Burst configuration 1 to n (2036) 215
- Burst variable 4
 - Burst configuration 1 to n (2037) 215
- Burst variable 5
 - Burst configuration 1 to n (2038) 216
- Burst variable 6
 - Burst configuration 1 to n (2039) 216
- Burst variable 7
 - Burst configuration 1 to n (2040) 216
- C0 to 5 (6022) 138
- Calibration factor (6025) 138
- Capture mode (7001) 204
- Carrier corrected volume flow (1894) 65
- Carrier mass flow (1865) 65
- Carrier pipe temperature (6027) 143
- Carrier volume flow (1896) 66
- Casing pipe temperature (6411) 144

- Clear logging data (0855) 293
- Combined density-pressure factor (5971) 125
- Combined density-temperature factor (5961) 125
- Combined temperature-pressure factor (5970) 126
- Comparison result (2760) 36
- Concentration (1887) 64
- Configuration counter (0233) 281
- Configuration management (2758) 35
- Connection state (2722) 252
- Constant offset (5968) 123
- Contrast display (0105) 34
- Control Totalizer 1 to n (0912-1 to n) 258
- Corrected volume flow (1851) 61
- Corrected volume flow factor (1867) 129
- Corrected volume flow offset (1866) 129
- Corrected volume flow unit (0558) 94
- Corrected volume unit (0575) 94
- CPL (4192) 67
- CPL alternative (4197) 73
- CTL (4191) 67
- CTL alternative (4174) 73
- CTPL (4193) 67
- Cubic temperature factor (5969) 126
- Current input 1 to n simulation (1608-1 to n) 330
- Current output 1 to n simulation (0354-1 to n) 324
- Current output value (0355) 324
- Current range output
 - Current output 1 to n (0353-1 to n) 157
- Current span
 - Current input 1 to n (1605-1 to n) 150
- Cut off inhomogeneous liquid (6374) 267
- Cut off inhomogeneous wet gas (6375) 267
- Cut off suspended bubbles (6370) 268
- Damping current output
 - Current output 1 to n (0363-1 to n) 166
- Damping output
 - Pulse/frequency/switch output 1 to n (0477-1 to n) 181
- Data logging (0860) 293
- Data logging control (0857) 294
- Data logging status (0858) 295
- Date/time (manually entered) (12142) 316
- Date/time format (2812) 99
- Day (2842) 311
- Decimal places 1 (0095) 22
- Decimal places 2 (0117) 23
- Decimal places 3 (0118) 25
- Decimal places 4 (0119) 26
- Decimal places 5 (0149) 27
- Decimal places 6 (0150) 28
- Decimal places 7 (0151) 29
- Decimal places 8 (0152) 30
- Default gateway (7210) 246
- Density (1850) 61
- Density 2 (1905) 76
- Density 2 unit (0619) 97
- Density adjustment factor (6042) 122
- Density adjustment mode (6043) 121
- Density adjustment offset (6044) 122
- Density damping (1803) 101
- Density factor (1849) 129
- Density limit (4199) 102
- Density offset (1848) 128
- Density setpoint 1 (6045) 121
- Density setpoint 2 (6046) 121
- Density unit (0555) 95
- Device alarm simulation (0654) 329
- Device ID (0221) 219
- Device ID (7007) 204
- Device name (0020) 280
- Device reset (0000) 54
- Device revision (0204) 219
- Device tag (0011) 279
- Device tag (0215) 209
- Device type (0209) 219
- Device type (7008) 204
- DHCP client (7212) 245
- Diagnostic event category (0738) 330
- Diagnostic event simulation (0737) 330
- Diagnostics 1 (0692) 272
- Diagnostics 2 (0693) 273
- Diagnostics 3 (0694) 274
- Diagnostics 4 (0695) 274
- Diagnostics 5 (0696) 275
- Direct access (0106) 12
- Display damping (0094) 32
- Display interval (0096) 31
- Display language (0104) 16
- Dynamic viscosity (1854) 62
- ENP version (0012) 282
- Enter access code (0003) 14
- Entire logging duration (0861) 295
- Event category 046 (0246) 232
- Event category 140 (0244) 233
- Event category 142 (0280) 233
- Event category 144 (0303) 233
- Event category 304 (0283) 234
- Event category 374 (0245) 234
- Event category 441 (0210) 234
- Event category 442 (0230) 235
- Event category 443 (0231) 235
- Event category 444 (0211) 236
- Event category 543 (0276) 236
- Event category 599 (0279) 236
- Event category 830 (0240) 237
- Event category 831 (0241) 237
- Event category 832 (0218) 238
- Event category 833 (0225) 238
- Event category 834 (0227) 238
- Event category 835 (0229) 239
- Event category 842 (0295) 239
- Event category 862 (0214) 240
- Event category 912 (0243) 240
- Event category 913 (0242) 240
- Event category 915 (0282) 241
- Event category 941 (0294) 241
- Event category 942 (0302) 241
- Event category 943 (0301) 242

- Event category 944 (0304) 242
- Event category 948 (0275) 242
- Event category 984 (0278) 243
- Exciter current 0 to 1 (6055) 144
- Execute density adjustment (6041) 122
- Extended order code 1 (0023) 281
- Extended order code 2 (0021) 281
- Extended order code 3 (0022) 281
- External device information (12101) 313
- External pressure (6209) 112
- External reference density (6198) 116
- External temperature (6080) 113
- Fail-safe type application specific 0 (2098) 264
- Fail-safe type application specific 1 (2100) 265
- Fail-safe value application specific 0 (2099) 265
- Fail-safe value application specific 1 (65535) 265
- Failure behavior current output
 - Current output 1 to n (0364-1 to n) 167
- Failure current
 - Current output 1 to n (0352-1 to n) 168
- Failure frequency
 - Pulse/frequency/switch output 1 to n (0474-1 to n) 182
- Failure mode
 - Current input 1 to n (1601-1 to n) 151
 - Pulse/frequency/switch output 1 to n (0451-1 to n) 182
 - Pulse/frequency/switch output 1 to n (0480-1 to n) 175
 - Pulse/frequency/switch output 1 to n (0486-1 to n) 189
 - Relay output 1 to n (0811-1 to n) 196
 - Totalizer 1 to n (0901-1 to n) 259
- Failure mode (0985) 201
- Failure mode (7011) 207
- Failure value
 - Current input 1 to n (1602-1 to n) 151
- Failure value (7012) 207
- Fieldbus writing access (0273) 210
- Filter options (0705) 276
- Firmware version
 - I/O module 2 (0072) 284, 286, 287
 - I/O module 3 (0072) 284, 286, 287
 - I/O module 4 (0072) 284, 286, 287
- Firmware version (0010) 280
- Firmware version (0072) 282, 283, 288
- Fixed current
 - Current output 1 to n (0365-1 to n) 158
- Fixed reference density (1814) 116
- Flow damping (1802) 100
- Flow override (1839) 102
- Format display (0098) 17
- Frequency fluctuation 0 to 1 (6175) 140
- Frequency output 1 to n simulation (0472-1 to n) 325
- Frequency output 1 to n value (0473-1 to n) 325
- Gas Fraction Handler (6377) 110
- Gateway IP address (2719) 253
- GSV flow (4157) 69
- GSV flow alternative (4158) 70
- Hardware revision (0206) 221
- HART address (0219) 210
- HART date code (0202) 221
- HART descriptor (0212) 220
- HART message (0216) 220
- HART revision (0205) 220
- HART short tag (0220) 209
- HBSI (12115) 321
- HBSI (12167) 318
- HBSI cycle time (12110) 320
- HBSI value reliability (6380) 321
- Header (0097) 32
- Header text (0112) 33
- High value partial filled pipe detection (1858) 107
- Hour (2843) 312
- I/O alteration code (2762) 148
- I/O module (12145) 318
- I/O module 1 to n information (3906-1 to n) 147
- I/O module 1 to n terminal numbers (3902-1 to n) 146
- I/O module 1 to n type (3901-1 to n) 147
- I/O module 2 terminal numbers (3902-2) 284, 285, 287
- I/O module 3 terminal numbers (3902-3) 284, 285, 287
- I/O module 4 terminal numbers (3902-4) 284, 285, 287
- Inhomogeneous medium index (6368) 267
- Input signal level 1 to n (1356-1 to n) 332
- Installation angle pitch (6236) 119
- Installation angle roll (6282) 118
- Installation direction (1809) 118
- Invert output signal
 - Pulse/frequency/switch output 1 to n (0470-1 to n) 190
- Invert output signal (0993) 202
- IP address (7209) 245
- IP address domain name server (2720) 253
- Kinematic viscosity (1857) 63
- Last backup (2757) 35
- Linear density factor (5967) 124
- Linear expansion coefficient (1817) 117
- Linear pressure factor (5965) 124
- Linear temperature factor (5966) 124
- Location (2755) 310
- Locking status (0004) 13
- Logging delay (0859) 294
- Logging interval (0856) 292
- Login page (7273) 246
- Low value partial filled pipe detection (1861) 106
- Lower range value output
 - Current output 1 to n (0367-1 to n) 159
- MAC address (7214) 244
- Manufacturer ID (0259) 220
- Manufacturer ID (7009) 205
- Mass flow (1838) 60
- Mass flow factor (1832) 127
- Mass flow offset (1831) 127

- Mass flow unit (0554) 90
- Mass unit (0574) 91
- Master terminal number (0981) 198
- Max. switch cycles number
Relay output 1 to n (0817-1 to n) 88
- Max. update period
Burst configuration 1 to n (2041-1 to n) 218
- Maximum damping partial filled pipe det. (6040)
. 108
- Maximum frequency value
Pulse/frequency/switch output 1 to n (0454-
1 to n) 178
- Maximum value (6007) 305
- Maximum value (6009) 304
- Maximum value (6014) 308
- Maximum value (6029) 302
- Maximum value (6051) 300
- Maximum value (6068) 304
- Maximum value (6070) 303
- Maximum value (6108) 301
- Maximum value (6119) 307
- Maximum value (6121) 306
- Maximum value (6283) 308
- Measured current
Current output 1 to n (0366-1 to n) 169
Value current output 1 to n (0366-1 to n) 86
- Measured current 1 to n (1604-1 to n) 84
- Measured values (12102) 314
- Measured values 1 to n (1603-1 to n) 84
- Measuring mode
Pulse/frequency/switch output 1 to n (0457-
1 to n) 175
Pulse/frequency/switch output 1 to n (0479-
1 to n) 179
- Measuring mode (0984) 200
- Measuring mode current output
Current output 1 to n (0351-1 to n) 161
- Measuring value at maximum frequency
Pulse/frequency/switch output 1 to n (0475-
1 to n) 179
- Measuring value at minimum frequency
Pulse/frequency/switch output 1 to n (0476-
1 to n) 179
- MFT (Multi-Frequency Technology) (6242) 109
- Min. update period
Burst configuration 1 to n (2042-1 to n) 217
- Minimum frequency value
Pulse/frequency/switch output 1 to n (0453-
1 to n) 178
- Minimum value (6008) 305
- Minimum value (6010) 304
- Minimum value (6015) 307
- Minimum value (6030) 301
- Minimum value (6052) 300
- Minimum value (6069) 303
- Minimum value (6071) 303
- Minimum value (6109) 300
- Minimum value (6120) 307
- Minimum value (6122) 306
- Minimum value (6284) 308
- Minute (2844) 312
- Month (2845) 311
- Network security (2705) 249
- No. of preambles (0217) 210
- Nominal diameter (2807) 138
- NSV flow (4159) 70
- NSV flow alternative (4160) 71
- Off value low flow cutoff (1804) 104
- Oil corrected volume flow (4179) 77
- Oil CPL (4177) 72
- Oil CTL (4175) 71
- Oil CTPL (4176) 72
- Oil density (4169) 75
- Oil mass flow (4180) 77
- Oil reference density (4195) 74
- Oil volume flow (4178) 76
- On value low flow cutoff (1805) 103
- Operating mode
Pulse/frequency/switch output 1 to n (0469-
1 to n) 171
- Operating time (0652) 35, 53, 271
- Operating time (12126) 317
- Operating time from restart (0653) 271
- Order code (0008) 280
- Oscillation amplitude 0 to 1 (6006) 141
- Oscillation damping 0 to 1 (6038) 141
- Oscillation damping fluctuation 0 to 1 (6172) 142
- Oscillation frequency 0 to 1 (6067) 140
- Output current
Current output 1 to n (0361-1 to n) 168
Value current output 1 to n (0361-1 to n) 85
- Output frequency
Pulse/frequency/switch output 1 to n (0471-
1 to n) 86, 183
- Output values (12103) 315
- Parameter 0 (6358) 261
- Parameter 1 (6359) 261
- Parameter 2 (6360) 262
- Parameter 3 (6361) 262
- Parameter 4 (6345) 262
- Parameter 5 (6346) 262
- Parameter 6 (6347) 263
- Parameter 7 (6348) 263
- Parameter 8 (6349) 263
- Parameter 9 (6350) 263
- Phase shift (0992) 200
- Plant operator (2754) 309
- Powerless relay status
Relay output 1 to n (0816-1 to n) 197
- Preset value 1 to n (0913-1 to n) 258
- Pressure (6129) 62
- Pressure compensation (6130) 112
- Pressure shock suppression (1806) 104
- Pressure unit (0564) 98
- Pressure value (6059) 112
- Previous diagnostics (0690) 270
- Primary variable (PV) (0201) 224

- Process variable current output
 Current output 1 to n (0359-1 to n) 156
- Process variable value (1811) 323
- Progress (2808) 122, 132, 135, 314
- Pulse output (0987) 89, 202
- Pulse output 1 to n (0456-1 to n) 86, 176
- Pulse output simulation (0988) 328
- Pulse output simulation 1 to n (0458-1 to n) . . . 325
- Pulse scaling
 Pulse/frequency/switch output 1 to n (0455-1 to n) 173
- Pulse value (0989) 329
- Pulse value 1 to n (0459-1 to n) 326
- Pulse width
 Pulse/frequency/switch output 1 to n (0452-1 to n) 174
- Pulse width (0986) 200
- Quadratic density factor (5964) 124
- Quadratic pressure factor (5962) 125
- Quadratic temperature factor (5963) 125
- Quaternary variable (QV) (0203) 230
- Raw value mass flow (6140) 140
- Received signal strength (2721) 253
- Recommendation: (6000) 133
- Reference density (1852) 61
- Reference density alternative (4168) 69
- Reference density factor (1869) 130
- Reference density offset (1868) 130
- Reference density unit (0556) 96
- Reference sound velocity (6147) 110
- Reference temperature (1816) 116
- Relay output 1 to n simulation (0802-1 to n) . . . 327
- Relay output function
 Relay output 1 to n (0804-1 to n) 191
- Reliability of measured zero point (5982) 136
- Reset access code (0024) 53
- Reset all totalizers (2806) 254
- Reset min/max values (6151) 299
- Response time part. filled pipe detect. (1859) . . . 107
- Response time status input
 Status input 1 to n (1354-1 to n) 154
- Root cause (6444) 133, 135
- S&W correction value (4194) 68
- S&W volume flow (4161) 68
- Secondary variable (SV) (0226) 226
- Security identification (2718) 249
- Select action (5995) 137
- Select antenna (2713) 252
- Select gas type (6074) 109
- Select medium type (6062) 109
- Select reference density (1812) 115
- Sensor (12152) 317
- Sensor electronic module (ISEM) (12151) 318
- Sensor electronics temperature (ISEM) (6053) . . 143
- Sensor index coil asymmetry (5951) 145
- Sensor index coil asymmetry reliability (5952) . . 146
- Separator (0101) 33
- Serial number (0009) 279
- Signal asymmetry 0 (6013) 142
- Signal mode
 Current input 1 to n (1610-1 to n) 149
- Current output 1 to n (0377-1 to n) 155
- Pulse/frequency/switch output 1 to n (0490-1 to n) 171
- Signal mode (0991) 198
- Slave terminal number (0990) 198
- Slot number (7010) 206
- Software option overview (0015) 56
- Software revision (0224) 221
- Square expansion coefficient (1818) 117
- SSID name (2707) 252
- SSID name (2714) 248
- Start verification (12127) 313
- Status (6253) 132, 135
- Status (7004) 208
- Status (12153) 315
- Status input 1 to n simulation (1355-1 to n) . . . 331
- Subnet mask (7211) 245
- Suspended bubbles index (6376) 268
- Switch cycles
 Relay output 1 to n (0815-1 to n) 88
- Switch output function
 Pulse/frequency/switch output 1 to n (0481-1 to n) 183
- Switch output simulation 1 to n (0462-1 to n) . . 326
- Switch state
 Pulse/frequency/switch output 1 to n (0461-1 to n) 87, 189
- Relay output 1 to n (0801-1 to n) 88, 196
- Switch state 1 to n (0463-1 to n) 327
- Switch state 1 to n (0803-1 to n) 328
- Switch-off delay
 Pulse/frequency/switch output 1 to n (0465-1 to n) 188
- Relay output 1 to n (0813-1 to n) 195
- Switch-off value
 Pulse/frequency/switch output 1 to n (0464-1 to n) 187
- Relay output 1 to n (0809-1 to n) 194
- Switch-on delay
 Pulse/frequency/switch output 1 to n (0467-1 to n) 188
- Relay output 1 to n (0814-1 to n) 196
- Switch-on value
 Pulse/frequency/switch output 1 to n (0466-1 to n) 186
- Relay output 1 to n (0810-1 to n) 195
- System status (12109) 319
- Target corrected volume flow (1893) 65
- Target mass flow (1864) 64
- Target volume flow (1895) 66
- Temp. compensated dynamic viscosity (1872) 63
- Temp. compensated kinematic viscosity (1863) . . . 63
- Temperature (1853) 62
- Temperature coefficient sound velocity (6181) . . 110
- Temperature correction source (6184) 113
- Temperature damping (1822) 101
- Temperature difference measuring tube (6344) . . 145

- Temperature factor (1871) 131
 - Temperature offset (1870) 130
 - Temperature unit (0557) 98
 - Terminal number
 - Current input 1 to n (1611–1 to n) 149
 - Current output 1 to n (0379–1 to n) 155
 - Pulse/frequency/switch output 1 to n (0492–1 to n) 170
 - Relay output 1 to n (0812–1 to n) 191
 - Status input 1 to n (1358–1 to n) 152
 - Tertiary variable (TV) (0228) 228
 - Test point 0 (6425) 144
 - Test point 1 (6426) 145
 - Time period signal (TPS) (1903) 80
 - Time period signal frequency (TPS) (1904) 81
 - Timeout (7005) 206
 - Timestamp 270, 271, 272, 273, 274, 275, 276
 - Torsion signal asymmetry (6289) 143
 - Totalizer operation mode
 - Totalizer 1 to n (0908–1 to n) 257
 - Totalizer overflow 1 to n (0910–1 to n) 82
 - Totalizer value 1 to n (0911–1 to n) 81
 - Transmitter identifier (2765) 55
 - Unit totalizer 1 to n (0915–1 to n) 256
 - Upper range value output
 - Current output 1 to n (0372–1 to n) 161
 - User name (2715) 249
 - User role (0005) 14
 - Value (7003) 208
 - Value 1 display (0107) 19
 - Value 2 display (0108) 22
 - Value 3 display (0110) 23
 - Value 4 display (0109) 25
 - Value 5 display (0145) 26
 - Value 6 display (0146) 28
 - Value 7 display (0147) 29
 - Value 8 display (0148) 30
 - Value current input 1 to n (1609–1 to n) 331
 - Value per pulse (0983) 199
 - Value status input
 - Status input 1 to n (1353–1 to n) 153
 - Value status input 1 to n (1353–1 to n) 85
 - Verification ID (12141) 316
 - Verification mode (12105) 313
 - Verification result (12149) 315, 317
 - Volume flow (1847) 60
 - Volume flow factor (1846) 128
 - Volume flow offset (1841) 128
 - Volume flow unit (0553) 91
 - Volume unit (0563) 93
 - Water corrected volume flow (4182) 78
 - Water CTL (4172) 72
 - Water cut (4171) 76
 - Water density (4170) 75
 - Water mass flow (4183) 79
 - Water reference density (4196) 74
 - Water volume flow (4181) 78
 - Web server functionality (7222) 246
 - Web server language (7221) 244
 - Weighted density average (4184) 79
 - Weighted temperature average (4185) 80
 - WLAN (2702) 248
 - WLAN IP address (2711) 250
 - WLAN MAC address (2703) 250
 - WLAN mode (2717) 248
 - WLAN passphrase (2706) 251
 - WLAN password (2716) 250
 - WLAN subnet mask (2709) 251
 - Year (2846) 311
 - Zero point (6195) 138
 - Zero point measured (5999) 133, 136
 - Zero point standard deviation (5996) 134, 137
 - Direct access (Parameter) 12
 - Display (Submenu) 15
 - Display channel 1 (Submenu) 295
 - Display channel 2 (Submenu) 297
 - Display channel 3 (Submenu) 297
 - Display channel 4 (Submenu) 298
 - Display damping (Parameter) 32
 - Display interval (Parameter) 31
 - Display language (Parameter) 16
 - Display module (Submenu) 287
 - Document
 - Explanation of the structure of a parameter description 6
 - Function 4
 - Structure 4
 - Symbols used 6
 - Target group 4
 - Using the document 4
 - Document function 4
 - Double pulse output (Submenu) 89, 197
 - Dynamic viscosity (Parameter) 62
- ## E
- Electronics temperature (Submenu) 299
 - ENP version (Parameter) 282
 - Enter access code (Parameter) 14
 - Entire logging duration (Parameter) 295
 - Event category 046 (Parameter) 232
 - Event category 140 (Parameter) 233
 - Event category 142 (Parameter) 233
 - Event category 144 (Parameter) 233
 - Event category 304 (Parameter) 234
 - Event category 374 (Parameter) 234
 - Event category 441 (Parameter) 234
 - Event category 442 (Parameter) 235
 - Event category 443 (Parameter) 235
 - Event category 444 (Parameter) 236
 - Event category 543 (Parameter) 236
 - Event category 599 (Parameter) 236
 - Event category 830 (Parameter) 237
 - Event category 831 (Parameter) 237
 - Event category 832 (Parameter) 238
 - Event category 833 (Parameter) 238
 - Event category 834 (Parameter) 238
 - Event category 835 (Parameter) 239
 - Event category 842 (Parameter) 239

Event category 862 (Parameter)	240
Event category 912 (Parameter)	240
Event category 913 (Parameter)	240
Event category 915 (Parameter)	241
Event category 941 (Parameter)	241
Event category 942 (Parameter)	241
Event category 943 (Parameter)	242
Event category 944 (Parameter)	242
Event category 948 (Parameter)	242
Event category 984 (Parameter)	243
Event list (Submenu)	277
Event logbook (Submenu)	276
Exciter current 0 to 1 (Parameter)	144
Execute density adjustment (Parameter)	122
Extended density adjustment (Submenu)	123
Extended order code 1 (Parameter)	281
Extended order code 2 (Parameter)	281
Extended order code 3 (Parameter)	281
External compensation (Submenu)	111
External device information (Parameter)	313
External pressure (Parameter)	112
External reference density (Parameter)	116
External temperature (Parameter)	113

F

Factory settings	333
SI units	333
US units	335
Fail-safe type application specific 0 (Parameter)	264
Fail-safe type application specific 1 (Parameter)	265
Fail-safe value application specific 0 (Parameter)	265
Fail-safe value application specific 1 (Parameter)	265
Failure behavior current output (Parameter)	167
Failure current (Parameter)	168
Failure frequency (Parameter)	182
Failure mode (Parameter)	151, 175, 182, 189, 196, 201, 207, 259
Failure value (Parameter)	151, 207
Fieldbus writing access (Parameter)	210
Filter options (Parameter)	276
Firmware version (Parameter)	280, 282, 283, 284, 286, 287, 288
Fixed current (Parameter)	158
Fixed reference density (Parameter)	116
Flow damping (Parameter)	100
Flow override (Parameter)	102
Format display (Parameter)	17
Frequency fluctuation 0 to 1 (Parameter)	140
Frequency output 1 to n simulation (Parameter)	325
Frequency output 1 to n value (Parameter)	325
Function	see Parameter

G

Gas Fraction Handler	
"Medium index" submenu	266
Gas Fraction Handler (Parameter)	110
Gateway IP address (Parameter)	253
GSV flow (Parameter)	69

GSV flow alternative (Parameter)	70
--	----

H

Hardware revision (Parameter)	221
HART address (Parameter)	210
HART date code (Parameter)	221
HART descriptor (Parameter)	220
HART input (Submenu)	203
HART message (Parameter)	220
HART output (Submenu)	208
HART revision (Parameter)	220
HART short tag (Parameter)	209
HBSI (Parameter)	318, 321
HBSI cycle time (Parameter)	320
HBSI value reliability (Parameter)	321
Header (Parameter)	32
Header text (Parameter)	33
Heartbeat base settings (Submenu)	309
Heartbeat Monitoring (Submenu)	319
Heartbeat Technology (Submenu)	309
High value partial filled pipe detection (Parameter)	107
Hour (Parameter)	312

I

I/O alteration code (Parameter)	148
I/O configuration (Submenu)	146
I/O module (Parameter)	318
I/O module 1 to n information (Parameter)	147
I/O module 1 to n terminal numbers (Parameter)	146
I/O module 1 to n type (Parameter)	147
I/O module 2 (Submenu)	284
I/O module 2 terminal numbers (Parameter)	284, 285, 287
I/O module 3 (Submenu)	285
I/O module 3 terminal numbers (Parameter)	284, 285, 287
I/O module 4 (Submenu)	286
I/O module 4 terminal numbers (Parameter)	284, 285, 287
Information (Submenu)	218
Inhomogeneous medium index (Parameter)	267
Input (Submenu)	148, 208
Input signal level 1 to n (Parameter)	332
Input values (Submenu)	83
Installation angle pitch (Parameter)	119
Installation angle roll (Parameter)	118
Installation direction (Parameter)	118
Invert output signal (Parameter)	190, 202
IP address (Parameter)	245
IP address domain name server (Parameter)	253

K

Kinematic viscosity (Parameter)	63
---	----

L

Last backup (Parameter)	35
Linear density factor (Parameter)	124
Linear expansion coefficient (Parameter)	117
Linear pressure factor (Parameter)	124
Linear temperature factor (Parameter)	124

- Location (Parameter) 310
- Locking status (Parameter) 13
- Logging delay (Parameter) 294
- Logging interval (Parameter) 292
- Login page (Parameter) 246
- Low flow cut off (Submenu) 103
- Low value partial filled pipe detection (Parameter) . . 106
- Lower range value output (Parameter) 159
- M**
- MAC address (Parameter) 244
- Main electronic module + I/O module 1 (Submenu) . 282
- Manufacturer ID (Parameter) 205, 220
- Mass flow (Parameter) 60
- Mass flow factor (Parameter) 127
- Mass flow offset (Parameter) 127
- Mass flow unit (Parameter) 90
- Mass unit (Parameter) 91
- Master terminal number (Parameter) 198
- Max. switch cycles number (Parameter) 88
- Max. update period (Parameter) 218
- Maximum damping partial filled pipe det.
(Parameter) 108
- Maximum frequency value (Parameter) 178
- Maximum value (Parameter)
. 300, 301, 302, 303, 304, 305, 306, 307, 308
- Measured current (Parameter) 86, 169
- Measured current 1 to n (Parameter) 84
- Measured values (Parameter) 314
- Measured values (Submenu) 58
- Measured values 1 to n (Parameter) 84
- Measurement mode (Submenu) 108
- Measuring mode (Parameter) 175, 179, 200
- Measuring mode current output (Parameter) 161
- Measuring value at maximum frequency (Parameter)
. 179
- Measuring value at minimum frequency (Parameter)
. 179
- Medium index (Submenu) 266
- Medium temperature (Submenu) 300
- MFT (Multi-Frequency Technology) (Parameter) . . 109
- Min. update period (Parameter) 217
- Min/max values (Submenu) 298
- Minimum frequency value (Parameter) 178
- Minimum value (Parameter)
. 300, 301, 303, 304, 305, 306, 307, 308
- Minute (Parameter) 312
- Monitoring results (Submenu) 320
- Month (Parameter) 311
- N**
- Network security (Parameter) 249
- No. of preambles (Parameter) 210
- Nominal diameter (Parameter) 138
- NSV flow (Parameter) 70
- NSV flow alternative (Parameter) 71
- O**
- Off value low flow cutoff (Parameter) 104
- Oil corrected volume flow (Parameter) 77
- Oil CPL (Parameter) 72
- Oil CTL (Parameter) 71
- Oil CTPL (Parameter) 72
- Oil density (Parameter) 75
- Oil mass flow (Parameter) 77
- Oil reference density (Parameter) 74
- Oil volume flow (Parameter) 76
- On value low flow cutoff (Parameter) 103
- OPC-UA configuration (Submenu) 253
- Operating mode (Parameter) 171
- Operating time (Parameter) 35, 53, 271, 317
- Operating time from restart (Parameter) 271
- Order code (Parameter) 280
- Oscillation amplitude (Submenu) 304
- Oscillation amplitude 0 to 1 (Parameter) 141
- Oscillation damping (Submenu) 306
- Oscillation damping 0 to 1 (Parameter) 141
- Oscillation damping fluctuation 0 to 1 (Parameter) . . 142
- Oscillation frequency (Submenu) 302
- Oscillation frequency 0 to 1 (Parameter) 140
- Output (Submenu) 154, 221
- Output current (Parameter) 85, 168
- Output frequency (Parameter) 86, 183
- Output values (Parameter) 315
- Output values (Submenu) 85
- P**
- Parameter
Structure of a parameter description 6
- Parameter 0 (Parameter) 261
- Parameter 1 (Parameter) 261
- Parameter 2 (Parameter) 262
- Parameter 3 (Parameter) 262
- Parameter 4 (Parameter) 262
- Parameter 5 (Parameter) 262
- Parameter 6 (Parameter) 263
- Parameter 7 (Parameter) 263
- Parameter 8 (Parameter) 263
- Parameter 9 (Parameter) 263
- Partially filled pipe detection (Submenu) 106
- Performing verification (Submenu) 310
- Petroleum (Submenu) 260
- Phase shift (Parameter) 200
- Plant operator (Parameter) 309
- Powerless relay status (Parameter) 197
- Preset value 1 to n (Parameter) 258
- Pressure (Parameter) 62
- Pressure compensation (Parameter) 112
- Pressure shock suppression (Parameter) 104
- Pressure unit (Parameter) 98
- Pressure value (Parameter) 112
- Previous diagnostics (Parameter) 270
- Primary variable (PV) (Parameter) 224
- Process conditions (Parameter) 131, 135
- Process parameters (Submenu) 100
- Process variable adjustment (Submenu) 126
- Process variable current output (Parameter) 156
- Process variable value (Parameter) 323

Process variables (Submenu) 58, 264
 Progress (Parameter) 122, 132, 135, 314
 Pulse output (Parameter) 89, 202
 Pulse output 1 to n (Parameter) 86, 176
 Pulse output simulation (Parameter) 328
 Pulse output simulation 1 to n (Parameter) 325
 Pulse scaling (Parameter) 173
 Pulse value (Parameter) 329
 Pulse value 1 to n (Parameter) 326
 Pulse width (Parameter) 174, 200
 Pulse/frequency/switch output 1 to n (Submenu)
 86, 169

Q

Quadratic density factor (Parameter) 124
 Quadratic pressure factor (Parameter) 125
 Quadratic temperature factor (Parameter) 125
 Quaternary variable (QV) (Parameter) 230

R

Raw value mass flow (Parameter) 140
 Received signal strength (Parameter) 253
 Recommendation: (Parameter) 133
 Reference density (Parameter) 61
 Reference density alternative (Parameter) 69
 Reference density factor (Parameter) 130
 Reference density offset (Parameter) 130
 Reference density unit (Parameter) 96
 Reference sound velocity (Parameter) 110
 Reference temperature (Parameter) 116
 Relay output 1 to n (Submenu) 88, 190
 Relay output 1 to n simulation (Parameter) 327
 Relay output function (Parameter) 191
 Reliability of measured zero point (Parameter) 136
 Reset access code (Parameter) 53
 Reset access code (Submenu) 53
 Reset all totalizers (Parameter) 254
 Reset min/max values (Parameter) 299
 Response time part. filled pipe detect. (Parameter) 107
 Response time status input (Parameter) 154
 Root cause (Parameter) 133, 135

S

S&W correction value (Parameter) 68
 S&W volume flow (Parameter) 68
 Secondary variable (SV) (Parameter) 226
 Security identification (Parameter) 249
 Select action (Parameter) 137
 Select antenna (Parameter) 252
 Select gas type (Parameter) 109
 Select medium type (Parameter) 109
 Select reference density (Parameter) 115
 Sensor (Parameter) 317
 Sensor (Submenu) 57
 Sensor adjustment (Submenu) 118
 Sensor electronic module (ISEM) (Parameter) 318
 Sensor electronic module (ISEM) (Submenu) 283
 Sensor electronics temperature (ISEM) (Parameter) 143
 Sensor index coil asymmetry (Parameter) 145

Sensor index coil asymmetry reliability (Parameter) 146
 Separator (Parameter) 33
 Serial number (Parameter) 279
 Signal asymmetry (Submenu) 307
 Signal asymmetry 0 (Parameter) 142
 Signal mode (Parameter) 149, 155, 171, 198
 Simulation (Submenu) 321
 Slave terminal number (Parameter) 198
 Slot number (Parameter) 206
 Software option overview (Parameter) 56
 Software revision (Parameter) 221
 Square expansion coefficient (Parameter) 117
 SSID name (Parameter) 248, 252
 Start verification (Parameter) 313
 Status (Parameter) 132, 135, 208, 315
 Status input 1 to n (Submenu) 152
 Status input 1 to n simulation (Parameter) 331
 Submenu
 Administration 51
 Application 254
 Application specific calculations 260
 Application-specific parameters 260
 Burst configuration 1 to n 211
 Calculated values 114
 Calibration 137
 Carrier pipe temperature 301
 Communication 202
 Concentration 260
 Configuration 203, 209
 Configuration backup 34
 Corrected volume flow calculation 115
 Current input 1 to n 84, 149
 Current output 1 to n 154
 Custody transfer 260
 Custody transfer logbook 278
 Data logging 288
 Device information 278
 Diagnostic behavior 38
 Diagnostic configuration 230
 Diagnostic handling 37
 Diagnostic list 272
 Diagnostics 269
 Display 15
 Display channel 1 295
 Display channel 2 297
 Display channel 3 297
 Display channel 4 298
 Display module 287
 Double pulse output 89, 197
 Electronics temperature 299
 Event list 277
 Event logbook 276
 Extended density adjustment 123
 External compensation 111
 HART input 203
 HART output 208
 Heartbeat base settings 309
 Heartbeat Monitoring 319
 Heartbeat Technology 309

- I/O configuration 146
 - I/O module 2 284
 - I/O module 3 285
 - I/O module 4 286
 - Information 218
 - Input 148, 208
 - Input values 83
 - Low flow cut off 103
 - Main electronic module + I/O module 1 282
 - Measured values 58
 - Measurement mode 108
 - Medium index 266
 - Medium temperature 300
 - Min/max values 298
 - Monitoring results 320
 - OPC-UA configuration 253
 - Oscillation amplitude 304
 - Oscillation damping 306
 - Oscillation frequency 302
 - Output 154, 221
 - Output values 85
 - Partially filled pipe detection 106
 - Performing verification 310
 - Petroleum 260
 - Process parameters 100
 - Process variable adjustment 126
 - Process variables 58, 264
 - Pulse/frequency/switch output 1 to n 86, 169
 - Relay output 1 to n 88, 190
 - Reset access code 53
 - Sensor 57
 - Sensor adjustment 118
 - Sensor electronic module (ISEM) 283
 - Signal asymmetry 307
 - Simulation 321
 - Status input 1 to n 152
 - System 15
 - System units 89
 - Testpoints 139
 - Torsion oscillation amplitude 305
 - Torsion oscillation damping 306
 - Torsion oscillation frequency 303
 - Torsion signal asymmetry 308
 - Totalizer 81
 - Totalizer 1 to n 255
 - Value current output 1 to n 85
 - Value status input 1 to n 84
 - Verification results 316
 - Viscosity 259
 - Web server 243
 - Subnet mask (Parameter) 245
 - Suspended bubbles index (Parameter) 268
 - Switch cycles (Parameter) 88
 - Switch output function (Parameter) 183
 - Switch output simulation 1 to n (Parameter) 326
 - Switch state (Parameter) 87, 88, 189, 196
 - Switch state 1 to n (Parameter) 327, 328
 - Switch-off delay (Parameter) 188, 195
 - Switch-off value (Parameter) 187, 194
 - Switch-on delay (Parameter) 188, 196
 - Switch-on value (Parameter) 186, 195
 - System (Submenu) 15
 - System status (Parameter) 319
 - System units (Submenu) 89
- T**
- Target corrected volume flow (Parameter) 65
 - Target group 4
 - Target mass flow (Parameter) 64
 - Target volume flow (Parameter) 66
 - Temp. compensated dynamic viscosity (Parameter) 63
 - Temp. compensated kinematic viscosity (Parameter) 63
 - Temperat. difference meas. tube-carrier (Parameter) 145
 - Temperature (Parameter) 62
 - Temperature coefficient sound velocity (Parameter) 110
 - Temperature correction source (Parameter) 113
 - Temperature damping (Parameter) 101
 - Temperature difference measuring tube (Parameter) 145
 - Temperature factor (Parameter) 131
 - Temperature offset (Parameter) 130
 - Temperature unit (Parameter) 98
 - Terminal number (Parameter) 149, 152, 155, 170, 191
 - Tertiary variable (TV) (Parameter) 228
 - Test point 0 (Parameter) 144
 - Test point 1 (Parameter) 145
 - Testpoints (Submenu) 139
 - Time period signal (TPS) (Parameter) 80
 - Time period signal frequency (TPS) (Parameter) 81
 - Timeout (Parameter) 206
 - Timestamp (Parameter) 270, 271, 272, 273, 274, 275, 276
 - Torsion oscillation amplitude (Submenu) 305
 - Torsion oscillation damping (Submenu) 306
 - Torsion oscillation frequency (Submenu) 303
 - Torsion signal asymmetry (Parameter) 143
 - Torsion signal asymmetry (Submenu) 308
 - Totalizer (Submenu) 81
 - Totalizer 1 to n (Submenu) 255
 - Totalizer 1 to n status (Hex) (Parameter) 83
 - Totalizer 1 to n status (Parameter) 83
 - Totalizer 1 to n value (Parameter) 83
 - Totalizer operation mode (Parameter) 257
 - Totalizer overflow 1 to n (Parameter) 82
 - Totalizer value 1 to n (Parameter) 81
 - Transmitter identifier (Parameter) 55
- U**
- Unit totalizer 1 to n (Parameter) 256
 - Upper range value output (Parameter) 161
 - User name (Parameter) 249
 - User role (Parameter) 14
- V**
- Value (Parameter) 208
 - Value 1 display (Parameter) 19
 - Value 2 display (Parameter) 22
 - Value 3 display (Parameter) 23
 - Value 4 display (Parameter) 25

Value 5 display (Parameter)	26
Value 6 display (Parameter)	28
Value 7 display (Parameter)	29
Value 8 display (Parameter)	30
Value current input 1 to n (Parameter)	331
Value current output 1 to n (Submenu)	85
Value per pulse (Parameter)	199
Value status input (Parameter)	85, 153
Value status input 1 to n (Submenu)	84
Verification ID (Parameter)	316
Verification mode (Parameter)	313
Verification result (Parameter)	315, 317
Verification results (Submenu)	316
Viscosity (Submenu)	259
Volume flow (Parameter)	60
Volume flow factor (Parameter)	128
Volume flow offset (Parameter)	128
Volume flow unit (Parameter)	91
Volume unit (Parameter)	93

W

Water corrected volume flow (Parameter)	78
Water CTL (Parameter)	72
Water cut (Parameter)	76
Water density (Parameter)	75
Water mass flow (Parameter)	79
Water reference density (Parameter)	74
Water volume flow (Parameter)	78
Web server (Submenu)	243
Web server functionality (Parameter)	246
Web server language (Parameter)	244
Weighted density average (Parameter)	79
Weighted temperature average (Parameter)	80
Wizard	
Define access code	52
Density adjustment	120
WLAN settings	247
Zero adjustment	134
Zero verification	131
WLAN (Parameter)	248
WLAN IP address (Parameter)	250
WLAN MAC address (Parameter)	250
WLAN mode (Parameter)	248
WLAN passphrase (Parameter)	251
WLAN password (Parameter)	250
WLAN settings (Wizard)	247
WLAN subnet mask (Parameter)	251

Y

Year (Parameter)	311
----------------------------	-----

Z

Zero adjustment (Wizard)	134
Zero point (Parameter)	138
Zero point measured (Parameter)	133, 136
Zero point standard deviation (Parameter)	134, 137
Zero verification (Wizard)	131



71577087

www.addresses.endress.com
