

Safety Instructions

Micropilot

FMR50/51/52/53/54/56/57

4-20 mA HART

Control Drawing XP/DIP



Document: XA01117F-B
Safety instructions for electrical apparatus for explosion-hazardous areas →  3

Document: XA01117F-B
Temperature tables →  15

Document: XA01117F-B
Attachment: Nameplate view →  73

Micropilot FMR50/51/52/53/54/56/57

4-20 mA HART

Table of contents

Associated documentation	4
Manufacturer's certificates	4
Manufacturer address	4
Extended order code	4
Combined type of protection (Approval code, 8A)	8
Safety instructions: General	8
Safety instructions: Special conditions	9
Safety instructions: Installation	10
Explosionproof / Flameproof	10
Class I, Div. 2, Groups A-D	11
Process seals	12
Temperature tables	12
Connection data	12

Associated documentation This document is an integral part of the following Operating Instructions:

- BA01045F/00 (FMR50)
- BA01049F/00 (FMR51, FMR52)
- BA01050F/00 (FMR53, FMR54)
- BA01048F/00 (FMR56, FMR57)

Manufacturer's certificates **FM C/US certificate**

Certificate number:

- FM19.US0045X
- FM19.CA0023X

Manufacturer address Endress+Hauser SE+Co. KG
Hauptstraße 1
79689 Maulburg, Germany
Address of the manufacturing plant: See nameplate.

Extended order code The extended order code is indicated on the nameplate, which is affixed to the device in such a way that it is clearly visible. Additional information about the nameplate is provided in the associated Operating Instructions.

Structure of the extended order code

FMR5x	-	*****	+	A*B*C*D*E*F*G*..
<i>(Device type)</i>		<i>(Basic specifications)</i>		<i>(Optional specifications)</i>

* = Placeholder

At this position, an option (number or letter) selected from the specification is displayed instead of the placeholders.

Basic specifications

The features that are absolutely essential for the device (mandatory features) are specified in the basic specifications. The number of positions depends on the number of features available. The selected option of a feature can consist of several positions.

Optional specifications

The optional specifications describe additional features for the device (optional features). The number of positions depends on the number of features available. The features have a 2-digit structure to aid identification (e.g. JA). The first digit (ID) stands for the feature group and consists of a number or a letter (e.g. J = Test, Certificate). The second digit constitutes the value that stands for the feature within the group (e.g. A = 3.1 material (wetted parts), inspection certificate).

More detailed information about the device is provided in the following tables. These tables describe the individual positions and IDs in the extended order code which are relevant to hazardous locations.

Extended order code: Micropilot



The following specifications reproduce an extract from the product structure and are used to assign:

- This documentation to the device (using the extended order code on the nameplate).
- The device options cited in the document.

Device type

FMR50, FMR51, FMR52, FMR53, FMR54, FMR56, FMR57

Basic specifications

Position 1, 2 (Approval)		
Selected option		Description
FMR5x	FC	FM C/US XP-IS Cl. I, Div. 1, Groups A,B,C,D; AIS Cl. I, Div. 1, Groups A,B,C,D
	FD	FM C/US XP-IS Cl. I, Div. 1, Groups A,B,C,D; DIP-IS Cl. II, III, Div. 1, Groups E,F,G; NI Class I, Div. 2, Groups A,B,C,D; AIS Cl.I, II, III, Div.1 Groups A-G; Class I, Zone 0/1, AEx/Ex ia/db [ia Ga] IIC Ga/Gb
	FE	FM C/US DIP-IS Cl. II, III, Div. 1, Groups E, F,G; AIS Cl. I, II, III, Div.1 Groups A-G
	8A	FM/CSA IS+XP-IS Cl. I, II, III, Div. 1, Groups A-G, AIS Cl. I, II, III, Div. 1, Groups A-G

Position 3 (Power Supply, Output)		
Selected option		Description
FMR5x	A	2-wire, 4-20 mA HART
	B	2-wire, 4-20 mA HART, switch output (PFS)
	C	2-wire, 4-20 mA HART, 4...20 mA
	K	4-wire 90-253 V AC; 4-20 mA HART
	L	4-wire 10.4-48 V DC; 4-20 mA HART

Position 4 (Display, Operation)		
Selected option		Description
FMR5x	A	Without, via communication
	C	SD02, 4-line, push buttons + data backup function
	E	SD03, 4-line, illum., touch control + data backup function
	L	Prepared for display FHX50 + M12 connection
	M	Prepared for display FHX50 + custom connection
	N	Prepared for display FHX50 + NPT1/2"

Position 5 (Housing)		
Selected option		Description
FMR51-54 FMR57	B	GT18 dual compartment, 316L
FMR5x	C	GT20 dual compartment, Alu, coated

Position 7, 8 (Antenna)		
Selected option		Description
FMR50	BM	Horn 40 mm/1½", PVDF encapsulated, -40...130°C
	BN	Horn 80 mm/3", PP cladded, -40...80°C
	BR	Horn 100 mm/4", PP cladded, -40...80°C
FMR51	Bx	Horn (different sizes)
FMR52	BO	Horn 50 mm/2", -196...200°C, flush mount
	BP	Horn 80 mm/3", -196...200°C, flush mount
FMR53	Cx	Rod (different sizes)
FMR54	Ax	Without Horn
	Bx	Horn (different sizes)
	Dx	Planar (different sizes)
FMR56	BN	Horn 80 mm/3", PP cladded, -40...80°C
	BR	Horn 100 mm/4", PP cladded, -40...80°C
FMR57	Bx	Horn (different sizes)
	Fx	Parabolic (different sizes)

Position 9, 10 (Seal)		
Selected option		Description
FMR51	A5	Viton GLT, -40...150°C
	C1	Kalrez, -20...150°C
	D2	Graphite, -196...450°C (HT)
	D3	Graphite, -40...250°C (XT)
FMR54	A7	Viton, -20...150°C (Planar)
	A8	Viton, -40...200°C
	B4	EPDM, -40...150°C
	C2	Kalrez, -20...200°C, conductive media max. 150°C
	D1	Graphite, -196...280°C (XT)
	D2	Graphite, -196...400°C (HT)
FMR57	A6	Viton GLT, -40...200°C
	D4	Graphite, -40...400°C (HT)

Position 11-13 (Process Connection)		
Selected option		Description
FMR51-54 FMR57	Axx Cxx Kxx	Flange (different sizes)
FMR50	GGF RGF	Thread, PVDF
	UAE	Mounting bracket
	XRO	Connection, without flange/mounting bracket
	XxG	Slip on flange (different sizes)

Position 11-13 (Process Connection)		
Selected option		Description
FMR51	Pxx	Flange (different sizes)
	Rxx	Thread
	Txx	Tri-Clamp
FMR52	Mxx	Slotted-nut
	Txx	Tri-Clamp
FMR53	RxJ	Thread, 316L
	RxF	Thread, PVDF
FMR56	UAE	Mounting bracket
	XR0	Connection, without flange/mounting bracket
	XxG	Slip on flange (different sizes)
FMR57	RxJ	Thread, 316L
	XxJ	Align. device (different sizes)

Position 14 (Air Purge Connection)		
Selected option		Description
FMR57	1	G1/4
	2	NPT1/4

Optional specifications

ID Jx (Test, Certificate)		
Selected option		Description
FMR51 ¹⁾ FMR52 FMR54 ²⁾	JN ³⁾	Ambient temperature transmitter -50°C

- 1) Only in connection with Position 9, 10 (Seal) = D2
- 2) Only in connection with Position 9, 10 (Seal) = D1, D2
- 3) Only in connection with Position 3 (Power Supply, Output) = A, B, C

ID Nx, Ox (Accessory Mounted)		
Selected option		Description
FMR5x	NF	Bluetooth
FMR51	OM OU OV	Antenna extension (different sizes)
	OW	Horn protection, PTFE, no airpurge possible
FMR54	OM ON OR OS	Antenna extension (different sizes)
	OP OT	Antenna extension (different sizes)
	OW	Horn protection, PTFE, no airpurge possible

Combined type of protection (Approval code, 8A)

Devices with approval code "8A" are suitable for installation with explosion protection type of Intrinsic Safety or Explosionproof.

- Before initial commissioning, specify the type of protection.
- It is not permitted to change the type of protection after initial commissioning as this can jeopardize the explosion protection.

For aluminum housings:

Void out the explosion protection that is not used on the nameplate.

For stainless steel housings:

Using a striking tool, mark the explosion protection used, or void out the explosion protection that is not used.

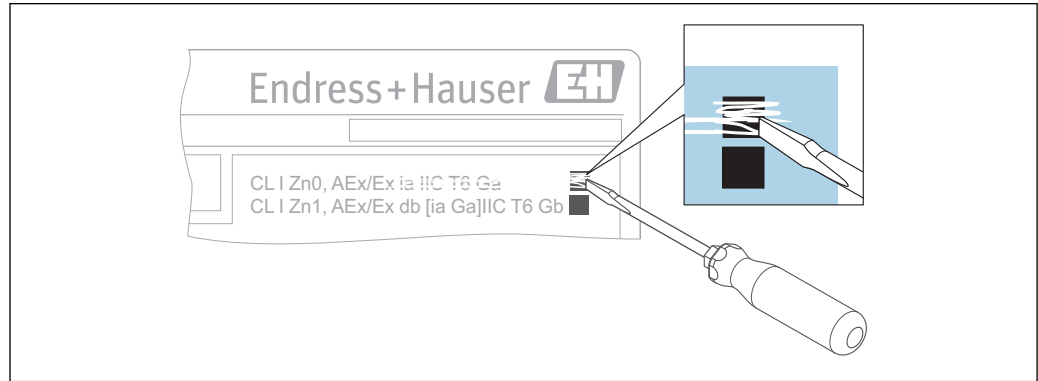

A003253

1

i It is critical to observe and follow the correct instructions for installation depending on the type of protection used. Refer to the following table for reference to the correct installation instructions.

Type of protection	Agency approval	Control Drawing no. / Document no.
Intrinsic Safety	CSA	XA01112F
	FM	XA01116F
Explosionproof	CSA	XA01113F
	FM	XA01117F

Class I, Division 2 installation:

References in this manual to Class I, Division 2 installation are not applicable for devices with the combined type of protection. For installation in Class I, Division 2, these devices must be installed per the applicable Division 1 intrinsic safety or explosionproof requirements.

Safety instructions: General

- Staff must meet the following conditions for mounting, electrical installation, commissioning and maintenance of the device:
 - Be suitably qualified for their role and the tasks they perform
 - Be trained in explosion protection
 - Be familiar with national regulations
- Install the device according to the manufacturer's instructions and national regulations.
- Do not operate the device outside the specified electrical, thermal and mechanical parameters.
- Only use the device in media to which the wetted materials have sufficient durability.

- Avoid electrostatic charging:
 - Of plastic surfaces (e.g. housing, sensor element, special varnishing, attached additional plates, ..)
 - Of isolated capacities (e.g. isolated metallic plates)
- Modifications to the device can affect the explosion protection and must be carried out by staff authorized to perform such work by Endress+Hauser.
- Refer to the temperature tables for the relationship between the permitted ambient temperature for the sensor and/or transmitter, depending on the range of application and the temperature class.

**Safety instructions:
Special conditions**

Permitted ambient temperature range at the electronics housing:
 $-40\text{ °C} \leq T_a \leq +80\text{ °C}$

Optional specification, ID Jx (Test, Certificate) = JN

Permitted ambient temperature range at the electronics housing:
 $-50\text{ °C} \leq T_a \leq +80\text{ °C}$

- Observe the information in the temperature tables.
- Use supply wires suitable for 20 K above the ambient temperature.
- In the case of process connections made of polymeric material or with polymeric coatings, avoid electrostatic charging of the plastic surfaces.
- In the event of additional or alternative special varnishing on the housing or other metal parts:
 - Observe the danger of electrostatic charging and discharge.
 - Do not rub surfaces with a dry cloth.

Device type FMR50, FMR52, FMR53, FMR54 (planar, enamel), FMR56

An antenna coated with non-conductive material can be used if avoiding electrostatic charging (e.g. through friction, cleaning, maintenance, strong medium flow).

Device type FMR51, FMR57 and Optional specification, ID Nx, Ox (Accessory Mounted) = OW

An antenna coated with non-conductive material can be used if avoiding electrostatic charging (e.g. through friction, cleaning, maintenance, strong medium flow).

Device type FMR57 and Basic specification, Position 11-13 (Process Connection) = Xxj

- Changing the position of the alignment device must be impossible:
 - After the alignment of the antenna via the pivot bracket
 - After tightening of the clamping flange
 - After setting the damping ring (torque 15 Nm)
- Degree of protection IP67 must be fulfilled.

Device type FMR57 and Basic specification, Position 14 (Air Purge Connection) = 1, 2

- If equipment with Ga/Gb or Da/Db is required: In the closed state the minimum degree of protection of the installation must be IP67.
- After removing the air purge connection: Lock the opening with a suitable plug.
 - Torque: 6-7 Nm
 - For Da/Db: thread engagement > 5 turns
- Degree of protection IP67 must be fulfilled.

Device type FMR51, FMR54, FMR57 and Optional specification, ID Nx, Ox (Accessory Mounted) = OM, ON, OR, OS, OU, OV, OP, OT

Avoid contact between sensor and tank wall. Take into account tank fittings and flow conditions (avoid sparks caused by impact and friction).

Safety instructions: Installation

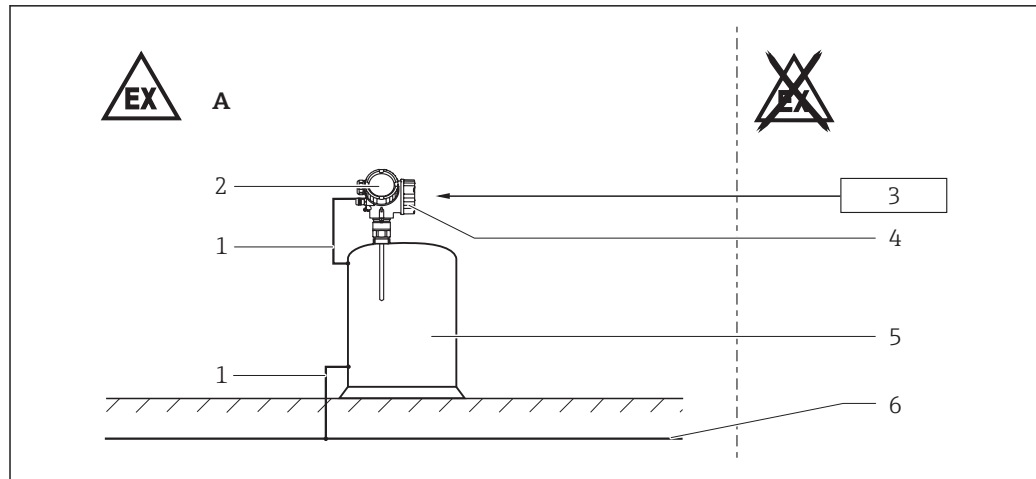

A0022630



- A** Class I, Div. 1 or 2, Groups A, B, C, D; Class II, Div. 1, Groups E, F, G; Zone 1
1 Potential equalization line
2 Electronics compartment Ex ia; Electronic insert
3 Power supply
4 Connection compartment XP/Ex db
5 Tank; Class I, Div. 1, Groups A, B, C, D; Class II, Div. 1, Groups E, F, G; Zone 0 or Zone 1
6 Potential equalization

- After aligning (rotating) the housing, retighten the fixing screw (see Operating Instructions).
- Install the device to exclude any mechanical damage or friction during the application. Pay particular attention to flow conditions and tank fittings.
- Before operation:
 - Screw in the cover all the way.
 - Tighten the securing clamp on the cover.
- The device can be equipped with the Bluetooth® module: refer to the Operating Instructions and specifications in the "Bluetooth® module" chapter.
- Continuous service temperature of the connecting cable: -40 °C to $\geq +85\text{ °C}$; in accordance with the range of service temperature taking into account additional influences of the process conditions ($T_{a,\min}$), ($T_{a,\max} + 20\text{ K}$).

Optional specification, ID Jx (Test, Certificate) = JN

Continuous service temperature of the connecting cable: -50 °C to $\geq +85\text{ °C}$; in accordance with the range of service temperature taking into account additional influences of the process conditions ($T_{a,\min}$), ($T_{a,\max} + 20\text{ K}$).

Basic specification, Position 4 (Display, Operation) = N

Observe national regulations and standards for conduit systems.

Basic specification, Position 3 (Power Supply, Output) = K

Connect the protective ground to the device.

Bluetooth® module

Optional specification, ID Nx (Accessory Mounted) = NF

- With Bluetooth® module installed: Use of external hardware not allowed (e.g. external display, service interface).
- The intrinsically safe input power circuit of the Bluetooth® module is isolated from ground.

Explosionproof / Flameproof

Class I, Div. 1, Groups A, B, C, D, Class II, Div. 1, Groups E, F, G, Class III
 Class I, Zone 1, AEx db [ia] IIC/Ex db [ia] IIC

- Install as per National Electrical Code (NFPA70) or Canadian Electrical Code, Part I (C22.1), as applicable.
- For the maximum supply voltage: See "Connection data" section.
- Control room equipment may not use or generate over $250\text{ V}_{\text{rms}}$.
- Seal unused entries with approved plugs that correspond to the type of protection. The plastic transport sealing plug does not meet this requirement and must therefore be replaced during installation.

- Antenna is intrinsically safe, AEx ia/Ex ia, and suitable for installation in Class I, II, III, Division 1 or Class I, Zone 0/1.
- When prepared for use with an approved remote display FHX50, remote display is intrinsically safe suitable for Class I, Division 1/Zone 0 locations and connection between transmitter housing and remote display is intrinsically safe field wiring.
- WARNINGS: Substitution of components may impair intrinsic safety.

Factory sealed

Explosionproof conduit seal not required for terminal compartment when installed in Division 1 locations.

Terminal compartment

Do not open when explosive atmosphere is present.

Class II and III

- Keep covers tight unless power has been switched off.
- Use a dust-tight seal at the conduit entry in a Class II and III location.

Class I, Div. 2, Groups A-D

The following instructions apply only for *Device type FMR5x, Basic specification, Position 1, 2 (Approval) = FD*

Device type FMR5x, Basic specification, Position 1, 2 (Approval) = FC and 8A are not marked for use in Class I, Division 2; however, these devices are suitable for this application when installed using the intrinsic safety instructions for Class I, Division 1.

Standard Wiring installation (only for NPT conduit entries)

- Install as per National Electrical Code (NFPA70) or Canadian Electrical Code, Part I (C22.1), as applicable.
- Using wiring methods appropriate for the location.
- Associated apparatus not required.
- For the maximum supply voltage: See "Connection data" section.
- Antenna is intrinsically safe, AEx ia/Ex ia, and suitable for installation in Class I, II, III, Division 1 or Class I, Zone 0/1.
- When prepared for use with an approved remote display FHX50, remote display is intrinsically safe suitable for Class I, Division 1/Zone 0 locations and connection between transmitter housing and remote display is intrinsically safe field wiring.
- WARNINGS: Explosion hazard - Do not disconnect equipment unless power has been switched off or the area is known to be non-hazardous.
- WARNINGS: Substitution of components may impair suitability for Class I, Div. 2.

Factory sealed

Explosionproof conduit seal not required for terminal compartment.

Process seals

The following device types are Dual Seal devices per ANSI/ISA 12.27.01 and do not require the use of an external secondary process seal.

Device type	Basic specification, Position 1, 2 (Approval)	MWP ¹⁾	Method of annunciation
FMR53 FMR54	FC, FD, 8A	12 bar	Process fluid leakage through vent located in electronics compartment.
FMR50-52 FMR56 FMR57	FC, FD, 8A	40 bar	When using the remote display FHX50: Leakage may also occur from the vent located in the remote display housing. No maintenance of annunciator necessary.

1) Maximum Working Pressure for the Dual Seal rating. This value may be a value less than the MWP for the device.

i Verify the chemical compatibility of the process seal specified on the nameplate in first position with the process fluid (see field "Mat." on the nameplate).

Basic specification, Position 4 (Display, Operation) = L M, N and a cable provided by customer, gland M16 or thread NPT1/2

To prevent possible leakage of process fluids in an area classified as non-hazardous, the FHX50 must be installed in the hazardous location when used with a device with a Dual Seal rating.

Temperature tables

→ 16

Connection data

Optional specification, ID Nx (Accessory Mounted) = NF

When using the Bluetooth® module: No changes to the connection values.

Connection compartment XP / AEx db/Ex db

Basic specification, Position 3 (Power Supply, Output) = A

Terminal 1 (+), 2 (-)
Power supply: $U_N = 35 V_{DC}$ $U_m = 250 V$ $I_{max} = 22 mA$

Basic specification, Position 3 (Power Supply, Output) = B

Terminal 1 (+), 2 (-)	Terminal 3 (+), 4 (-)
Power supply: $U_N = 35 V_{DC}$ $U_m = 250 V$ $I_{max} = 22 mA$	Switch output (PFS): $U_N = 35 V_{DC}$ $U_m = 250 V$

The power consumption of I/O modules with passive PFS output can be limited for certain applications.

- Recommended: Power consumption = 1 W. This is obtained for a supply voltage at the terminals of 27 V_{DC}.
- For higher supply voltages (U_{max}): Insert a serial resistance (R_v) in order to limit the power consumption, see table below.

Table for the PFS serial resistance (R_V):

Power consumption	1.0 W
Total power consumption	1.88 W
Internal resistance R_i	760 Ω

U_{max} [V]	R_V min
35	205 Ω
34	177 Ω
33	150 Ω
32	122 Ω
31	95 Ω
30	67 Ω
29	39 Ω
28	12 Ω
27	0 Ω

 For values associated with a higher or lower internal power consumption please contact Endress+Hauser.

Basic specification, Position 3 (Power Supply, Output) = C

Terminal 1 (+), 2 (-)	Terminal 3 (+), 4 (-)
Power supply: $U_N = 28 V_{DC}$ $U_m = 250 V$ $I_{max} = 22 mA$	Output 4 to 20 mA: $U_N = 28 V_{DC}$ $U_m = 250 V$ $I_{max} = 22 mA$

Basic specification, Position 3 (Power Supply, Output) = K

Terminal 1 (+), 2 (-)	Terminal 3 (+), 4 (-)
Power supply: $U_N = 253 V_{AC}, 50/60 Hz$ $U_m = 250 V$ $I_N = 25 mA$ $I_{max} = 160 mA$	Output 4 to 20 mA: $U_N = 22 V_{DC}$ $U_m = 250 V$ $I_{max} = 22 mA$

Basic specification, Position 3 (Power Supply, Output) = L

Terminal 1 (+), 2 (-)	Terminal 3 (+), 4 (-)
Power supply: $U_N = 48 V_{DC}$ $U_m = 250 V$ $I_N = 112 mA$ $I_{max} = 300 mA$	Output 4 to 20 mA: $U_N = 22 V_{DC}$ $U_m = 250 V$ $I_{max} = 22 mA$

Electronics compartment, intrinsically safe (AEx ia/Ex ia)**Service interface (CDI)**

Taking the following values into consideration, the device can be connected to the certified Endress+Hauser FXA291 service tool or a similar interface:

Service interface												
$U_i = 7.3 \text{ V}$ effective inner inductance $L_i = \text{negligible}$ effective inner capacitance $C_i = \text{negligible}$												
$U_o = 7.3 \text{ V}$ $I_o = 100 \text{ mA}$ $P_o = 160 \text{ mW}$												
$L_o \text{ (mH)} =$	5.00	2.00	1.00	0.50	0.20	0.10	0.05	0.02	0.01	0.005	0.002	0.001
$C_o \text{ (}\mu\text{F)} =$	0.73	1.20	1.60	2.00	2.60	3.20	4.00	5.50	7.30	10.00	12.70	12.70

Remote display interface

- Devices with *Basic specification, Position 4 (Display, Operation) = L, M, N* can be connected to the approved Endress+Hauser remote display FHX50.
- Refer to Safety Instructions XA01096F for additional installation instructions.

Micropilot FMR50/51/52/53/54/56/57

4-20 mA HART

Table of contents

Notes on the structure	16
Example diagrams of possible deratings	20
Compact; 1 channel	21
Compact; 2 channels	39
Class II, III, Division 1; 1 channel	71
Class II, III, Division 1; 2 channels	71

Notes on the structure

Extract from the extended order code

Device type

FMR50, FMR51, FMR52, FMR53, FMR54, FMR56, FMR57

Basic specifications

Position 1, 2 (Approval)		
Selected option		Description
FMR5x	FC	FM C/US XP-IS Cl. I, Div. 1, Groups A,B,C,D; AIS Cl. I, Div. 1, Groups A,B,C,D
	FD	FM C/US XP-IS Cl. I, Div. 1, Groups A,B,C,D; DIP-IS Cl. II, III, Div. 1, Groups E,F,G; NI Class I, Div. 2, Groups A,B,C,D; AIS Cl.I, II, III, Div.1 Groups A-G; Class I, Zone 0/1, AEx/Ex ia/db [ia Ga] IIC Ga/Gb
	FE	FM C/US DIP-IS Cl. II, III, Div. 1, Groups E, F,G; AIS Cl. I, II, III, Div.1 Groups A-G
	8A	FM/CSA IS+XP-IS Cl. I, II, III, Div. 1, Groups A-G, AIS Cl. I, II, III, Div. 1, Groups A-G

Position 3 (Power Supply, Output)		
Selected option		Description
FMR5x	A	2-wire, 4-20 mA HART
	B	2-wire, 4-20 mA HART, switch output (PFS)
	C	2-wire, 4-20 mA HART, 4...20 mA
	K	4-wire 90-253 V AC; 4-20 mA HART
	L	4-wire 10.4-48 V DC; 4-20 mA HART

Position 5 (Housing)		
Selected option		Description
FMR51-54 FMR57	B	GT18 dual compartment, 316L
FMR5x	C	GT20 dual compartment, Alu, coated

Position 7, 8 (Antenna)		
Selected option		Description
FMR50	BM	Horn 40 mm/1½", PVDF encapsulated, -40...130°C
	BN	Horn 80 mm/3", PP cladded, -40...80°C
	BR	Horn 100 mm/4", PP cladded, -40...80°C
FMR51	Bx	Horn (different sizes)
FMR52	BO	Horn 50 mm/2", -196...200°C, flush mount
	BP	Horn 80 mm/3", -196...200°C, flush mount
FMR53	Cx	Rod (different sizes)
FMR54	Ax	Without Horn
	Bx	Horn (different sizes)
	Dx	Planar (different sizes)

Position 7, 8 (Antenna)		
Selected option		Description
FMR56	BN	Horn 80 mm/3", PP cladded, -40...80°C
	BR	Horn 100 mm/4", PP cladded, -40...80°C
FMR57	Bx	Horn (different sizes)
	Fx	Parabolic (different sizes)

 Shown in the temperature tables exemplary as follows:

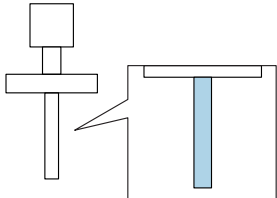

Position 9, 10 (Seal)		
Selected option		Description
FMR51	A5	Viton GLT, -40...150°C
	C1	Kalrez, -20...150°C
	D2	Graphite, -196...450°C (HT)
	D3	Graphite, -40...250°C (XT)
FMR54	A7	Viton, -20...150°C (Planar)
	A8	Viton, -40...200°C
	B4	EPDM, -40...150°C
	C2	Kalrez, -20...200°C, conductive media max. 150°C
	D1	Graphite, -196...280°C (XT)
	D2	Graphite, -196...400°C (HT)
FMR57	A6	Viton GLT, -40...200°C
	D4	Graphite, -40...400°C (HT)

 Shown in the temperature tables exemplary as follows:

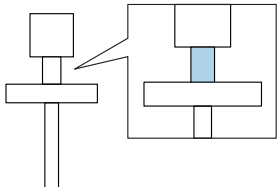

Position 11-13 (Process Connection)		
Selected option		Description
FMR51-54 FMR57	Axx Cxx Kxx	Flange (different sizes)
FMR50	GGF RGF	Thread, PVDF
	UAE	Mounting bracket
	XR0	Connection, without flange/mounting bracket
	XxG	Slip on flange (different sizes)

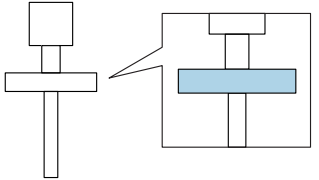

Position 11-13 (Process Connection)		
Selected option		Description
FMR51	Pxx	Flange (different sizes)
	Rxx	Thread
	Txx	Tri-Clamp
FMR52	Mxx	Slotted-nut
	Txx	Tri-Clamp
FMR53	Rxj	Thread, 316L
	RxF	Thread, PVDF
FMR56	UAE	Mounting bracket
	XRO	Connection, without flange/mounting bracket
	XxG	Slip on flange (different sizes)
FMR57	Rxj	Thread, 316L
	Xxj	Align. device (different sizes)
 Shown in the temperature tables exemplary as follows:		

Optional specifications

ID Jx (Test, Certificate)		
Selected option		Description
FMR51 ¹⁾ FMR52 FMR54 ²⁾	JN ³⁾	Ambient temperature transmitter -50°C

- 1) Only in connection with Position 9, 10 (Seal) = D2
- 2) Only in connection with Position 9, 10 (Seal) = D1, D2
- 3) Only in connection with Position 3 (Power Supply, Output) = A, B, C

General notes

-  Observe the permitted temperature range at the antenna.
-  Basic specification, Position 3 (Power Supply, Output) = B
Deratings are based on a power consumption of 1 W (PFS); →  12.

Description notes

-  Unless otherwise indicated, the positions always refer to the basic specification.

1st column: Position 5 (Housing) = A, B, ...



2nd column: Position 3 (Power Supply, Output) = A, B, ..

- (1): 1 channel used
- (2): 2 channels used

3rd column: Temperature classes T6 (85 °C) to T1 (450 °C)

Column P1 to P6: Position (temperature value) on the axes of the derating

- T_a: Ambient temperature in °C
- T_p: Process temperature in °C

 Column P6 is only relevant for version B of the derating.
 →  20

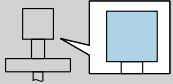
 = C	(1)	P1		P2		P3		P4		P5		P6		
		T _p	T _a	T _p	T _a	T _p	T _a	T _p	T _a	T _p	T _a	T _p	T _a	
	A, B, C	T6	-40	60	60	60	85	53	85	-40	-40	-40	-	-
		T5	-40	75	75	75	100	68	100	-40	-40	-40	-	-
		T4	-40	80	80	80	135	67	135	-40	-40	-40	-	-
		T3	-40	80	80	80	200	51	200	-40	-40	-40	-	-

A0038021-EN

Class II, III, Division 1

1st column: Position 5 (Housing) = A, B, ...

2nd column: Position 3 (Power Supply, Output) = A, B, ..

- (1): 1 channel used
- (2): 2 channels used

3rd column: Temperature values

 = C	(1)	
	B, C	T = T _a + 10 K

A0039389-EN

 T_a: Ambient temperature in °C

Example diagrams
of possible deratings

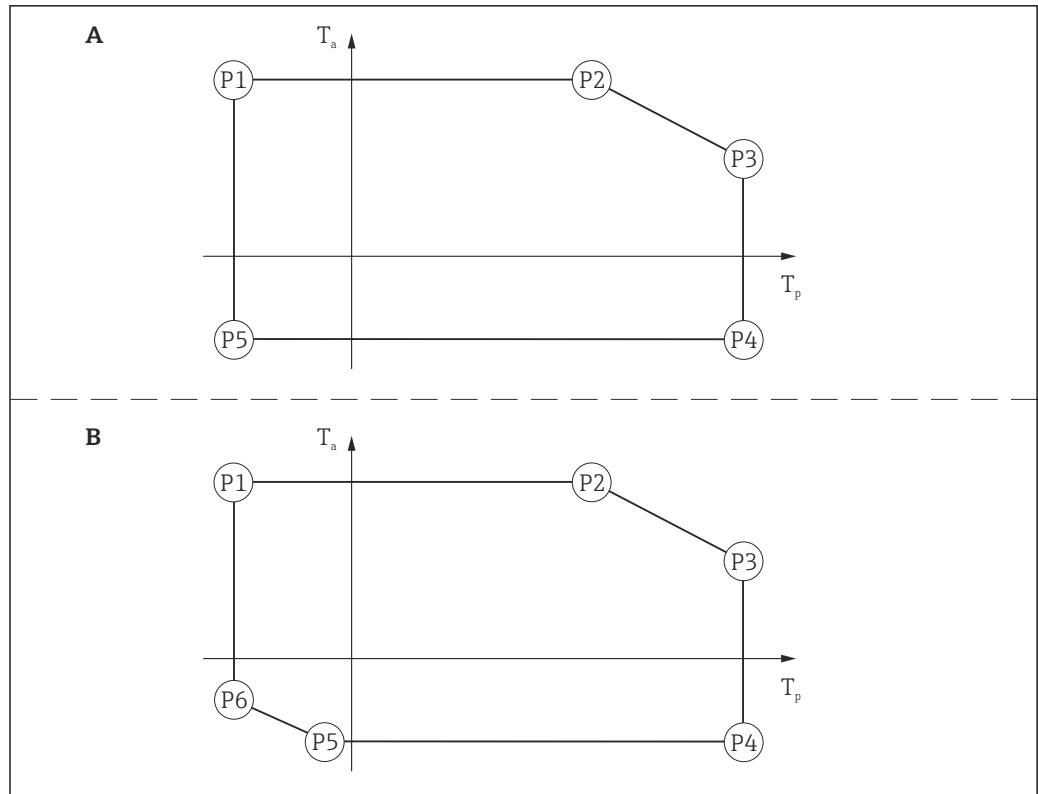

A0022717

3

Compact; 1 channel

Position 3 (Power Supply, Output) = A, B, C, K, L: 1 channel used

Page references to the temperature tables of the respective device types: See the following list.

- FMR50 → 21
- FMR51 → 22
- FMR52 → 26
- FMR53 → 28
- FMR54 → 30
- FMR56 → 36
- FMR57 → 37

 Explosion protection: XP / AEx db [ia]/Ex db [ia] or Division 2

Antenna: Class I, Zone 0 / Class I, Division 1;

Electronics housing: Class I, Zone 1 / Class I, Division 1 or Division 2

FMR50

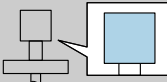
 = C	(1)	P1		P2		P3		P4		P5		P6		
		T _p	T _a	T _p	T _a	T _p	T _a	T _p	T _a	T _p	T _a	T _p	T _a	
	A, B, C	T6	-40	60	60	60	80	58	80	-40	-40	-40	-	-
	K, L	T6	-40	60	60	60	80	58	80	-40	-40	-40	-	-

 Explosion protection: XP / AEx db [ia]/Ex db [ia] or Division 2

Antenna: Class I, Zone 0 / Class I, Division 1;

Electronics housing: Class I, Zone 1 / Class I, Division 1 or Division 2

FMR51

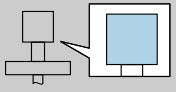
 = B	(1)	P1		P2		P3		P4		P5		P6		
		T _p	T _a	T _p	T _a	T _p	T _a	T _p	T _a	T _p	T _a	T _p	T _a	
	A, B, C	T6	-40	60	60	60	85	54	85	-40	-40	-40	-	-
		T5	-40	75	75	75	100	69	100	-40	-40	-40	-	-
		T4	-40	80	80	80	135	68	135	-40	-40	-40	-	-
		T3 ¹⁾	-40	80	80	80	150	65	150	-40	-40	-40	-	-
	K, L	T6	-40	60	60	60	85	54	85	-40	-40	-40	-	-
		T5	-40	75	75	75	100	69	100	-40	-40	-40	-	-
		T4	-40	76	76	76	135	64	135	-40	-40	-40	-	-
		T3 ¹⁾	-40	76	76	76	150	61	150	-40	-40	-40	-	-

1) Functional: Maximum permissible process temperature

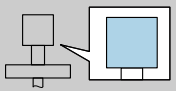
 = C	(1)	P1		P2		P3		P4		P5		P6		
		T _p	T _a	T _p	T _a	T _p	T _a	T _p	T _a	T _p	T _a	T _p	T _a	
	A, B, C	T6	-40	60	60	60	85	55	85	-40	-40	-40	-	-
		T5	-40	75	75	75	100	70	100	-40	-40	-40	-	-
		T4	-40	80	80	80	135	70	135	-40	-40	-40	-	-
		T3 ¹⁾	-40	80	80	80	150	68	150	-40	-40	-40	-	-
	K, L	T6	-40	60	60	60	85	55	85	-40	-40	-40	-	-
		T5	-40	75	75	75	100	70	100	-40	-40	-40	-	-
		T4	-40	76	76	76	135	66	135	-40	-40	-40	-	-
		T3 ¹⁾	-40	76	76	76	150	64	150	-40	-40	-40	-	-

1) Functional: Maximum permissible process temperature

FMR51

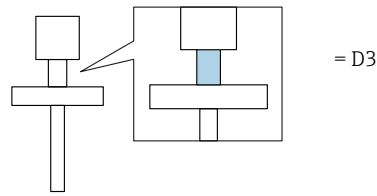

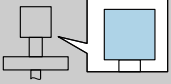
	(1)	P1		P2		P3		P4		P5		P6		
		T _p	T _a	T _p	T _a	T _p	T _a	T _p	T _a	T _p	T _a	T _p	T _a	
	A, B, C	T6	-40	60	60	60	85	57	85	-40	-40	-40	-	-
		T5	-40	75	75	75	100	72	100	-40	-40	-40	-	-
		T4	-40	80	80	80	135	74	135	-40	-40	-40	-	-
		T3	-40	80	80	80	200	67	200	-40	-40	-40	-	-
		T2 ¹⁾	-40	80	80	80	250	62	250	-40	-40	-40	-	-
	K, L	T6	-40	60	60	60	85	57	85	-40	-40	-40	-	-
		T5	-40	75	75	75	100	72	100	-40	-40	-40	-	-
		T4	-40	76	76	76	135	70	135	-40	-40	-40	-	-
		T3	-40	76	76	76	200	63	200	-40	-40	-40	-	-
		T2 ¹⁾	-40	76	76	76	250	58	250	-40	-40	-40	-	-

1) Functional: Maximum permissible process temperature

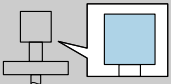
	(1)	P1		P2		P3		P4		P5		P6		
		T _p	T _a	T _p	T _a	T _p	T _a	T _p	T _a	T _p	T _a	T _p	T _a	
	A, B, C	T6	-40	60	60	60	85	58	85	-40	-40	-40	-	-
		T5	-40	75	75	75	100	73	100	-40	-40	-40	-	-
		T4	-40	80	80	80	135	75	135	-40	-40	-40	-	-
		T3	-40	80	80	80	200	70	200	-40	-40	-40	-	-
		T2 ¹⁾	-40	80	80	80	250	66	250	-40	-40	-40	-	-
	K, L	T6	-40	60	60	60	85	58	85	-40	-40	-40	-	-
		T5	-40	75	75	75	100	73	100	-40	-40	-40	-	-
		T4	-40	76	76	76	135	72	135	-40	-40	-40	-	-
		T3	-40	76	76	76	200	66	200	-40	-40	-40	-	-
		T2 ¹⁾	-40	76	76	76	250	62	250	-40	-40	-40	-	-

1) Functional: Maximum permissible process temperature

FMR51

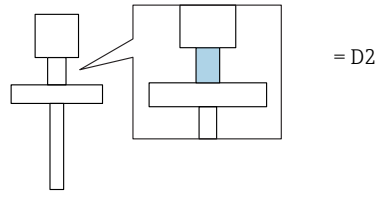

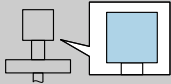
 = B	(1)	P1		P2		P3		P4		P5		P6		
		T _p	T _a	T _p	T _a	T _p	T _a	T _p	T _a	T _p	T _a	T _p	T _a	
	A, B, C	T6	-196	60	60	60	85	56	85	-40 -50 ¹⁾	-40 -50 ¹⁾	-40 -50 ¹⁾	-196	-15
		T5	-196	75	75	75	100	71	100	-40 -50 ¹⁾	-40 -50 ¹⁾	-40 -50 ¹⁾	-196	-15
		T4	-196	80	80	80	135	72	135	-40 -50 ¹⁾	-40 -50 ¹⁾	-40 -50 ¹⁾	-196	-15
		T3	-196	80	80	80	200	64	200	-40 -50 ¹⁾	-40 -50 ¹⁾	-40 -50 ¹⁾	-196	-15
		T2	-196	80	80	80	300	50	300	-40 -50 ¹⁾	-40 -50 ¹⁾	-40 -50 ¹⁾	-196	-15
	K, L	T6	-196	60	60	60	85	56	85	-40	-40	-40	-196	-15
		T5	-196	75	75	75	100	71	100	-40	-40	-40	-196	-15
		T4	-196	76	76	76	135	68	135	-40	-40	-40	-196	-15
		T3	-196	76	76	76	200	60	200	-40	-40	-40	-196	-15
		T2	-196	76	76	76	300	46	300	-40	-40	-40	-196	-15

1) Only in connection with Optional specification, ID Jx (Test, Certificate) = JN

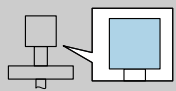
	(1)	P1		P2		P3		P4		P5		P6		
		T _p	T _a	T _p	T _a	T _p	T _a	T _p	T _a	T _p	T _a	T _p	T _a	
	A, B, C	T6	-196	60	60	60	85	57	85	-40 -50 ¹⁾	-40 -50 ¹⁾	-40 -50 ¹⁾	-196	-20 -28 ¹⁾
		T5	-196	75	75	75	100	72	100	-40 -50 ¹⁾	-40 -50 ¹⁾	-40 -50 ¹⁾	-196	-20 -28 ¹⁾
		T4	-196	80	80	80	135	74	135	-40 -50 ¹⁾	-40 -50 ¹⁾	-40 -50 ¹⁾	-196	-20 -28 ¹⁾
		T3	-196	80	80	80	200	67	200	-40 -50 ¹⁾	-40 -50 ¹⁾	-40 -50 ¹⁾	-196	-20 -28 ¹⁾
		T2	-196	80	80	80	300	56	300	-40 -50 ¹⁾	-40 -50 ¹⁾	-40 -50 ¹⁾	-196	-20 -28 ¹⁾
		T1	-196	80	80	80	450	39	450	-40 -50 ¹⁾	-40 -50 ¹⁾	-40 -50 ¹⁾	-196	-20 -28 ¹⁾
	K, L	T6	-196	60	60	60	85	57	85	-40	-40	-40	-196	-20
		T5	-196	75	75	75	100	72	100	-40	-40	-40	-196	-20
		T4	-196	76	76	76	135	70	135	-40	-40	-40	-196	-20
		T3	-196	76	76	76	200	63	200	-40	-40	-40	-196	-20
		T2	-196	76	76	76	300	52	300	-40	-40	-40	-196	-20
		T1	-196	76	76	76	450	36	450	-40	-40	-40	-196	-20

1) Only in connection with Optional specification, ID Jx (Test, Certificate) = JN

 Explosion protection: XP / AEx db [ia]/Ex db [ia] or Division 2

Antenna: Class I, Zone 0 / Class I, Division 1;

Electronics housing: Class I, Zone 1 / Class I, Division 1 or Division 2

FMR52

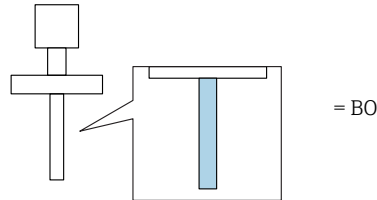

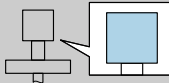
 = B	(1)	P1		P2		P3		P4		P5		P6		
		T _p	T _a	T _p	T _a	T _p	T _a	T _p	T _a	T _p	T _a	T _p	T _a	
	A, B, C	T6	-196	60	60	60	85	55	85	-40 -50 ¹⁾	-40 -50 ¹⁾	-40 -50 ¹⁾	-196	-3
		T5	-196	75	75	75	100	70	100	-40 -50 ¹⁾	-40 -50 ¹⁾	-40 -50 ¹⁾	-196	-3
		T4	-196	80	80	80	135	71	135	-40 -50 ¹⁾	-40 -50 ¹⁾	-40 -50 ¹⁾	-196	-3
		T3	-196	80	80	80	200	59	200	-40 -50 ¹⁾	-40 -50 ¹⁾	-40 -50 ¹⁾	-196	-3
	K, L	T6	-196	60	60	60	85	55	85	-40	-40	-40	-196	-3
		T5	-196	75	75	75	100	70	100	-40	-40	-40	-196	-3
		T4	-196	76	76	76	135	66	135	-40	-40	-40	-196	-3
		T3	-196	76	76	76	200	55	200	-40	-40	-40	-196	-3

1) Only in connection with Optional specification, ID Jx (Test, Certificate) = JN

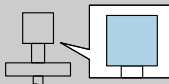
 = C	(1)	P1		P2		P3		P4		P5		P6		
		T _p	T _a	T _p	T _a	T _p	T _a	T _p	T _a	T _p	T _a	T _p	T _a	
	A, B, C	T6	-196	60	60	60	85	56	85	-40 -50 ¹⁾	-40 -50 ¹⁾	-40 -50 ¹⁾	-196	-14
		T5	-196	75	75	75	100	71	100	-40 -50 ¹⁾	-40 -50 ¹⁾	-40 -50 ¹⁾	-196	-14
		T4	-196	80	80	80	135	72	135	-40 -50 ¹⁾	-40 -50 ¹⁾	-40 -50 ¹⁾	-196	-14
		T3	-196	80	80	80	200	63	200	-40 -50 ¹⁾	-40 -50 ¹⁾	-40 -50 ¹⁾	-196	-14
	K, L	T6	-196	60	60	60	85	56	85	-40	-40	-40	-196	-14
		T5	-196	75	75	75	100	71	100	-40	-40	-40	-196	-14
		T4	-196	76	76	76	135	68	135	-40	-40	-40	-196	-14
		T3	-196	76	76	76	200	59	200	-40	-40	-40	-196	-14

1) Only in connection with Optional specification, ID Jx (Test, Certificate) = JN

FMR52

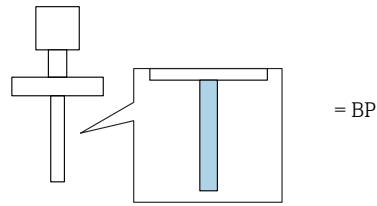

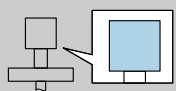
 = B	(1)	P1		P2		P3		P4		P5		P6		
		T _p	T _a	T _p	T _a	T _p	T _a	T _p	T _a	T _p	T _a	T _p	T _a	
	A, B, C	T6	-196	60	60	60	85	54	85	-40 -50 ¹⁾	-40 -50 ¹⁾	-40 -50 ¹⁾	-196	10
		T5	-196	75	75	75	100	69	100	-40 -50 ¹⁾	-40 -50 ¹⁾	-40 -50 ¹⁾	-196	10
		T4	-196	80	80	80	135	69	135	-40 -50 ¹⁾	-40 -50 ¹⁾	-40 -50 ¹⁾	-196	10
		T3	-196	80	80	80	200	55	200	-40 -50 ¹⁾	-40 -50 ¹⁾	-40 -50 ¹⁾	-196	10
	K, L	T6	-196	60	60	60	85	54	85	-40	-40	-40	-196	10
		T5	-196	75	75	75	100	69	100	-40	-40	-40	-196	10
		T4	-196	76	76	76	135	64	135	-40	-40	-40	-196	10
		T3	-196	76	76	76	200	51	200	-40	-40	-40	-196	10

1) Only in connection with Optional specification, ID Jx (Test, Certificate) = JN

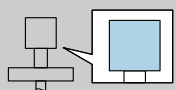
 = C	(1)	P1		P2		P3		P4		P5		P6		
		T _p	T _a	T _p	T _a	T _p	T _a	T _p	T _a	T _p	T _a	T _p	T _a	
	A, B, C	T6	-196	60	60	60	85	55	85	-40 -50 ¹⁾	-40 -50 ¹⁾	-40 -50 ¹⁾	-196	-8
		T5	-196	75	75	75	100	70	100	-40 -50 ¹⁾	-40 -50 ¹⁾	-40 -50 ¹⁾	-196	-8
		T4	-196	80	80	80	135	71	135	-40 -50 ¹⁾	-40 -50 ¹⁾	-40 -50 ¹⁾	-196	-8
		T3	-196	80	80	80	200	60	200	-40 -50 ¹⁾	-40 -50 ¹⁾	-40 -50 ¹⁾	-196	-8
	K, L	T6	-196	60	60	60	85	55	85	-40	-40	-40	-196	-8
		T5	-196	75	75	75	100	70	100	-40	-40	-40	-196	-8
		T4	-196	76	76	76	135	67	135	-40	-40	-40	-196	-8
		T3	-196	76	76	76	200	56	200	-40	-40	-40	-196	-8

1) Only in connection with Optional specification, ID Jx (Test, Certificate) = JN

i Explosion protection: XP / AEx db [ia]/Ex db [ia] or Division 2

Antenna: Class I, Zone 0 / Class I, Division 1;

Electronics housing: Class I, Zone 1 / Class I, Division 1 or Division 2

FMR53

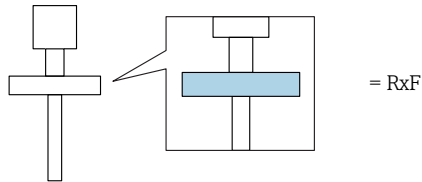

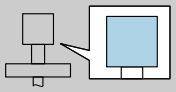
 = B, C	(1)	P1		P2		P3		P4		P5		P6		
		T _p	T _a	T _p	T _a	T _p	T _a	T _p	T _a	T _p	T _a	T _p	T _a	
	A, B, C	T6	-40	60	60	60	80	58	80	-40	-40	-40	-	-
	K, L	T6	-40	60	60	60	80	58	80	-40	-40	-40	-	-

FMR53

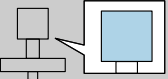
 = B	(1)	P1		P2		P3		P4		P5		P6		
		T _p	T _a	T _p	T _a	T _p	T _a	T _p	T _a	T _p	T _a	T _p	T _a	
	A, B, C	T6	-40	60	60	60	85	53	85	-40	-40	-40	-	-
		T5	-40	75	75	75	100	68	100	-40	-40	-40	-	-
		T4	-40	80	80	80	135	67	135	-40	-40	-40	-	-
		T3 ¹⁾	-40	80	80	80	150	64	150	-40	-40	-40	-	-
	K, L	T6	-40	60	60	60	85	53	85	-40	-40	-40	-	-
		T5	-40	75	75	75	100	68	100	-40	-40	-40	-	-
		T4	-40	76	76	76	135	63	135	-40	-40	-40	-	-
		T3 ¹⁾	-40	76	76	76	150	59	150	-40	-40	-40	-	-

1) Functional: Maximum permissible process temperature

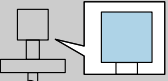
 = C	(1)	P1		P2		P3		P4		P5		P6		
		T _p	T _a	T _p	T _a	T _p	T _a	T _p	T _a	T _p	T _a	T _p	T _a	
	A, B, C	T6	-40	60	60	60	85	54	85	-40	-40	-40	-	-
		T5	-40	75	75	75	100	69	100	-40	-40	-40	-	-
		T4	-40	80	80	80	135	70	135	-40	-40	-40	-	-
		T3 ¹⁾	-40	80	80	80	150	67	150	-40	-40	-40	-	-
	K, L	T6	-40	60	60	60	85	54	85	-40	-40	-40	-	-
		T5	-40	75	75	75	100	69	100	-40	-40	-40	-	-
		T4	-40	76	76	76	135	65	135	-40	-40	-40	-	-
		T3 ¹⁾	-40	76	76	76	150	63	150	-40	-40	-40	-	-

1) Functional: Maximum permissible process temperature

 Explosion protection: XP / AEx db [ia]/Ex db [ia] or Division 2

Antenna: Class I, Zone 0 / Class I, Division 1;

Electronics housing: Class I, Zone 1 / Class I, Division 1 or Division 2

FMR54

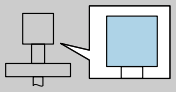
 = B	(1)	P1		P2		P3		P4		P5		P6		
		T _p	T _a	T _p	T _a	T _p	T _a	T _p	T _a	T _p	T _a	T _p	T _a	
	A, B, C	T6	-40	60	60	60	85	53	85	-40	-40	-40	-	-
		T5	-40	75	75	75	100	68	100	-40	-40	-40	-	-
		T4	-40	80	80	80	135	67	135	-40	-40	-40	-	-
		T3	-40	80	80	80	200	51	200	-40	-40	-40	-	-
	K, L	T6	-40	60	60	60	85	53	85	-40	-40	-40	-	-
		T5	-40	75	75	75	100	68	100	-40	-40	-40	-	-
		T4	-40	76	76	76	135	62	135	-40	-40	-40	-	-
		T3	-40	76	76	76	200	46	200	-40	-40	-40	-	-

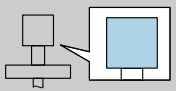
 = C	(1)	P1		P2		P3		P4		P5		P6		
		T _p	T _a	T _p	T _a	T _p	T _a	T _p	T _a	T _p	T _a	T _p	T _a	
	A, B, C	T6	-40	60	60	60	85	54	85	-40	-40	-40	-	-
		T5	-40	75	75	75	100	69	100	-40	-40	-40	-	-
		T4	-40	80	80	80	135	69	135	-40	-40	-40	-	-
		T3	-40	80	80	80	200	56	200	-40	-40	-40	-	-
	K, L	T6	-40	60	60	60	85	54	85	-40	-40	-40	-	-
		T5	-40	75	75	75	100	69	100	-40	-40	-40	-	-
		T4	-40	76	76	76	135	65	135	-40	-40	-40	-	-
		T3	-40	76	76	76	200	52	200	-40	-40	-40	-	-

FMR54

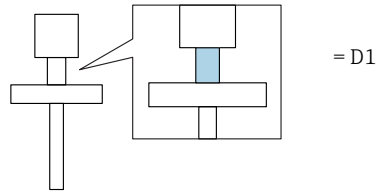

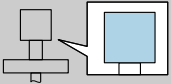
 = B	(1)	P1		P2		P3		P4		P5		P6		
		T _p	T _a	T _p	T _a	T _p	T _a	T _p	T _a	T _p	T _a	T _p	T _a	
	A, B, C	T6	-196	60	60	60	85	55	85	-40 -50 ¹⁾	-40 -50 ¹⁾	-40 -50 ¹⁾	-196	-4
		T5	-196	75	75	75	100	70	100	-40 -50 ¹⁾	-40 -50 ¹⁾	-40 -50 ¹⁾	-196	-4
		T4	-196	80	80	80	135	71	135	-40 -50 ¹⁾	-40 -50 ¹⁾	-40 -50 ¹⁾	-196	-4
		T3	-196	80	80	80	200	60	200	-40 -50 ¹⁾	-40 -50 ¹⁾	-40 -50 ¹⁾	-196	-4
		T2 ²⁾	-196	80	80	80	280	46	280	-40 -50 ¹⁾	-40 -50 ¹⁾	-40 -50 ¹⁾	-196	-4
	K, L	T6	-196	60	60	60	85	55	85	-40	-40	-40	-196	-4
		T5	-196	75	75	75	100	70	100	-40	-40	-40	-196	-4
		T4	-196	76	76	76	135	67	135	-40	-40	-40	-196	-4
		T3	-196	76	76	76	200	55	200	-40	-40	-40	-196	-4
		T2 ²⁾	-196	76	76	76	280	42	280	-40	-40	-40	-196	-4

1) Only in connection with Optional specification, ID Jx (Test, Certificate) = JN
 2) Functional: Maximum permissible process temperature

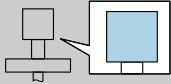
 = C	(1)	P1		P2		P3		P4		P5		P6		
		T _p	T _a	T _p	T _a	T _p	T _a	T _p	T _a	T _p	T _a	T _p	T _a	
	A, B, C	T6	-196	60	60	60	85	56	85	-40 -50 ¹⁾	-40 -50 ¹⁾	-40 -50 ¹⁾	-196	-15
		T5	-196	75	75	75	100	71	100	-40 -50 ¹⁾	-40 -50 ¹⁾	-40 -50 ¹⁾	-196	-15
		T4	-196	80	80	80	135	72	135	-40 -50 ¹⁾	-40 -50 ¹⁾	-40 -50 ¹⁾	-196	-15
		T3	-196	80	80	80	200	64	200	-40 -50 ¹⁾	-40 -50 ¹⁾	-40 -50 ¹⁾	-196	-15
		T2 ²⁾	-196	80	80	80	280	53	280	-40 -50 ¹⁾	-40 -50 ¹⁾	-40 -50 ¹⁾	-196	-15
	K, L	T6	-196	60	60	60	85	56	85	-40	-40	-40	-196	-15
		T5	-196	75	75	75	100	71	100	-40	-40	-40	-196	-15
		T4	-196	76	76	76	135	69	135	-40	-40	-40	-196	-15
		T3	-196	76	76	76	200	60	200	-40	-40	-40	-196	-15
		T2 ²⁾	-196	76	76	76	280	49	280	-40	-40	-40	-196	-15

- 1) Only in connection with Optional specification, ID Jx (Test, Certificate) = JN
 2) Functional: Maximum permissible process temperature

FMR54

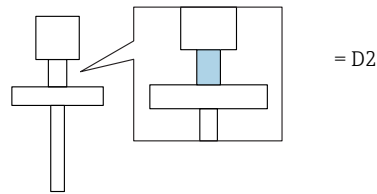

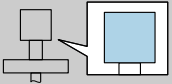
 = B	(1)	P1		P2		P3		P4		P5		P6		
		T _p	T _a	T _p	T _a	T _p	T _a	T _p	T _a	T _p	T _a	T _p	T _a	
	A, B, C	T6	-196	60	60	60	85	56	85	-40 -50 ¹⁾	-40 -50 ¹⁾	-40 -50 ¹⁾	-196	-13
		T5	-196	75	75	75	100	71	100	-40 -50 ¹⁾	-40 -50 ¹⁾	-40 -50 ¹⁾	-196	-13
		T4	-196	80	80	80	135	72	135	-40 -50 ¹⁾	-40 -50 ¹⁾	-40 -50 ¹⁾	-196	-13
		T3	-196	80	80	80	200	62	200	-40 -50 ¹⁾	-40 -50 ¹⁾	-40 -50 ¹⁾	-196	-13
		T2	-196	80	80	80	300	48	300	-40 -50 ¹⁾	-40 -50 ¹⁾	-40 -50 ¹⁾	-196	-13
		T1 ²⁾	-196	80	80	80	400	31	400	-40 -50 ¹⁾	-40 -50 ¹⁾	-40 -50 ¹⁾	-196	-13
	K, L	T6	-196	60	60	60	85	56	85	-40	-40	-40	-196	-13
		T5	-196	75	75	75	100	71	100	-40	-40	-40	-196	-13
		T4	-196	76	76	76	135	68	135	-40	-40	-40	-196	-13
		T3	-196	76	76	76	200	58	200	-40	-40	-40	-196	-13
		T2	-196	76	76	76	300	44	300	-40	-40	-40	-196	-13

- 1) Only in connection with Optional specification, ID Jx (Test, Certificate) = JN
- 2) Functional: Maximum permissible process temperature

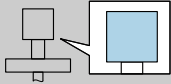
 = C	(1)	P1		P2		P3		P4		P5		P6		
		T _p	T _a	T _p	T _a	T _p	T _a	T _p	T _a	T _p	T _a	T _p	T _a	
	A, B, C	T6	-196	60	60	60	85	57	85	-40 -50 ¹⁾	-40 -50 ¹⁾	-40 -50 ¹⁾	-196	-19 -26 ¹⁾
		T5	-196	75	75	75	100	72	100	-40 -50 ¹⁾	-40 -50 ¹⁾	-40 -50 ¹⁾	-196	-19 -26 ¹⁾
		T4	-196	80	80	80	135	74	135	-40 -50 ¹⁾	-40 -50 ¹⁾	-40 -50 ¹⁾	-196	-19 -26 ¹⁾
		T3	-196	80	80	80	200	66	200	-40 -50 ¹⁾	-40 -50 ¹⁾	-40 -50 ¹⁾	-196	-19 -26 ¹⁾
		T2	-196	80	80	80	300	54	300	-40 -50 ¹⁾	-40 -50 ¹⁾	-40 -50 ¹⁾	-196	-19 -26 ¹⁾
		T1 ²⁾	-196	80	80	80	400	42	400	-40 -50 ¹⁾	-40 -50 ¹⁾	-40 -50 ¹⁾	-196	-19 -26 ¹⁾
	K, L	T6	-196	60	60	60	85	57	85	-40	-40	-40	-196	-19
		T5	-196	75	75	75	100	72	100	-40	-40	-40	-196	-19
		T4	-196	76	76	76	135	70	135	-40	-40	-40	-196	-19
		T3	-196	76	76	76	200	62	200	-40	-40	-40	-196	-19
		T2	-196	76	76	76	300	50	300	-40	-40	-40	-196	-19
		T1 ²⁾	-196	76	76	76	400	39	400	-40	-40	-40	-196	-19

1) Only in connection with Optional specification, ID Jx (Test, Certificate) = JN

2) Functional: Maximum permissible process temperature

FMR54

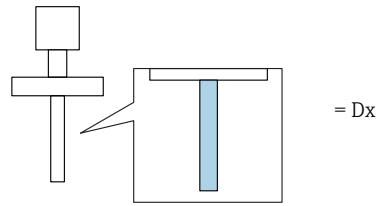

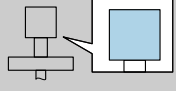
 = B	(1)	P1		P2		P3		P4		P5		P6		
		T _p	T _a	T _p	T _a	T _p	T _a	T _p	T _a	T _p	T _a	T _p	T _a	
	A, B, C	T6	-40	60	60	60	85	55	85	-40	-40	-40	-	-
		T5	-40	75	75	75	100	70	100	-40	-40	-40	-	-
		T4	-40	80	80	80	135	70	135	-40	-40	-40	-	-
		T3 ¹⁾	-40	80	80	80	150	68	150	-40	-40	-40	-	-
	K, L	T6	-40	60	60	60	85	55	85	-40	-40	-40	-	-
		T5	-40	75	75	75	100	70	100	-40	-40	-40	-	-
		T4	-40	76	76	76	135	66	135	-40	-40	-40	-	-
		T3 ¹⁾	-40	76	76	76	150	63	150	-40	-40	-40	-	-

1) Functional: Maximum permissible process temperature

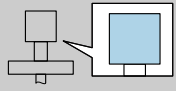
 = C	(1)	P1		P2		P3		P4		P5		P6		
		T _p	T _a	T _p	T _a	T _p	T _a	T _p	T _a	T _p	T _a	T _p	T _a	
	A, B, C	T6	-40	60	60	60	85	56	85	-40	-40	-40	-	-
		T5	-40	75	75	75	100	71	100	-40	-40	-40	-	-
		T4	-40	80	80	80	135	72	135	-40	-40	-40	-	-
		T3 ¹⁾	-40	80	80	80	150	70	150	-40	-40	-40	-	-
	K, L	T6	-40	60	60	60	85	56	85	-40	-40	-40	-	-
		T5	-40	75	75	75	100	71	100	-40	-40	-40	-	-
		T4	-40	76	76	76	135	68	135	-40	-40	-40	-	-
		T3 ¹⁾	-40	76	76	76	150	66	150	-40	-40	-40	-	-

1) Functional: Maximum permissible process temperature

 Explosion protection: XP / AEx db [ia]/Ex db [ia] or Division 2

Antenna: Class I, Zone 0 / Class I, Division 1;

Electronics housing: Class I, Zone 1 / Class I, Division 1 or Division 2

FMR56

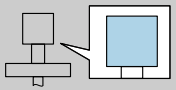
 = C	(1)		P1		P2		P3		P4		P5		P6	
			T _p	T _a	T _p	T _a	T _p	T _a	T _p	T _a	T _p	T _a	T _p	T _a
	A, B, C	T6	-40	60	60	60	80	58	80	-40	-40	-40	-	-
	K, L	T6	-40	60	60	60	80	58	80	-40	-40	-40	-	-

 Explosion protection: XP / AEx db [ia]/Ex db [ia] or Division 2

Antenna: Class I, Zone 0 / Class I, Division 1;

Electronics housing: Class I, Zone 1 / Class I, Division 1 or Division 2

FMR57

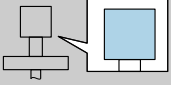
 = B	(1)	P1		P2		P3		P4		P5		P6		
		T _p	T _a	T _p	T _a	T _p	T _a	T _p	T _a	T _p	T _a	T _p	T _a	
	A, B, C	T6	-40	60	60	60	85	56	85	-40	-40	-40	-	-
		T5	-40	75	75	75	100	71	100	-40	-40	-40	-	-
		T4	-40	80	80	80	135	73	135	-40	-40	-40	-	-
		T3	-40	80	80	80	200	65	200	-40	-40	-40	-	-
	K, L	T6	-40	60	60	60	85	56	85	-40	-40	-40	-	-
		T5	-40	75	75	75	100	71	100	-40	-40	-40	-	-
		T4	-40	76	76	76	135	69	135	-40	-40	-40	-	-
		T3	-40	76	76	76	200	62	200	-40	-40	-40	-	-

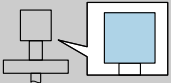
 = C	(1)	P1		P2		P3		P4		P5		P6		
		T _p	T _a	T _p	T _a	T _p	T _a	T _p	T _a	T _p	T _a	T _p	T _a	
	A, B, C	T6	-40	60	60	60	85	57	85	-40	-40	-40	-	-
		T5	-40	75	75	75	100	72	100	-40	-40	-40	-	-
		T4	-40	80	80	80	135	75	135	-40	-40	-40	-	-
		T3	-40	80	80	80	200	69	200	-40	-40	-40	-	-
	K, L	T6	-40	60	60	60	85	57	85	-40	-40	-40	-	-
		T5	-40	75	75	75	100	72	100	-40	-40	-40	-	-
		T4	-40	76	76	76	135	71	135	-40	-40	-40	-	-
		T3	-40	76	76	76	200	65	200	-40	-40	-40	-	-

FMR57

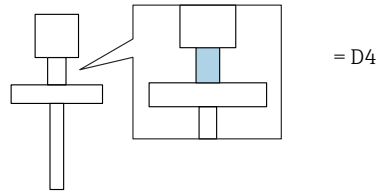

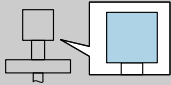
 = B	(1)	P1		P2		P3		P4		P5		P6		
		T _p	T _a	T _p	T _a	T _p	T _a	T _p	T _a	T _p	T _a	T _p	T _a	
	A, B, C	T6	-40	60	60	60	85	57	85	-40	-40	-40	-	-
		T5	-40	75	75	75	100	72	100	-40	-40	-40	-	-
		T4	-40	80	80	80	135	75	135	-40	-40	-40	-	-
		T3	-40	80	80	80	200	69	200	-40	-40	-40	-	-
		T2	-40	80	80	80	300	60	300	-40	-40	-40	-	-
		T1 ¹⁾	-40	80	80	80	400	51	400	-40	-40	-40	-	-
	K, L	T6	-40	60	60	60	85	57	85	-40	-40	-40	-	-
		T5	-40	75	75	75	100	72	100	-40	-40	-40	-	-
		T4	-40	76	76	76	135	71	135	-40	-40	-40	-	-
		T3	-40	76	76	76	200	65	200	-40	-40	-40	-	-
		T2	-40	76	76	76	300	56	300	-40	-40	-40	-	-
		T1 ¹⁾	-40	76	76	76	400	47	400	-40	-40	-40	-	-

1) Functional: Maximum permissible process temperature

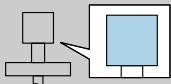
 = C	(1)	P1		P2		P3		P4		P5		P6		
		T _p	T _a	T _p	T _a	T _p	T _a	T _p	T _a	T _p	T _a	T _p	T _a	
	A, B, C	T6	-40	60	60	60	85	58	85	-40	-40	-40	-	-
		T5	-40	75	75	75	100	73	100	-40	-40	-40	-	-
		T4	-40	80	80	80	135	76	135	-40	-40	-40	-	-
		T3	-40	80	80	80	200	71	200	-40	-40	-40	-	-
		T2	-40	80	80	80	300	64	300	-40	-40	-40	-	-
		T1 ¹⁾	-40	80	80	80	400	57	400	-40	-40	-40	-	-
	K, L	T6	-40	60	60	60	85	58	85	-40	-40	-40	-	-
		T5	-40	75	75	75	100	73	100	-40	-40	-40	-	-
		T4	-40	76	76	76	135	72	135	-40	-40	-40	-	-
		T3	-40	76	76	76	200	68	200	-40	-40	-40	-	-
		T2	-40	76	76	76	300	61	300	-40	-40	-40	-	-
		T1 ¹⁾	-40	76	76	76	400	53	400	-40	-40	-40	-	-

1) Functional: Maximum permissible process temperature

Compact; 2 channels

Position 3 (Power Supply, Output) = B, C: 2 channels used

Page references to the temperature tables of the respective device types: See the following list.

- FMR50 → 39
- FMR51 → 40
- FMR52 → 47
- FMR53 → 52
- FMR54 → 56
- FMR56 → 66
- FMR57 → 67

 Explosion protection: XP / AEx db [ia]/Ex db [ia]

Antenna: Class I, Zone 0 / Class I, Division 1;
 Electronics housing: Class I, Zone 1 / Class I, Division 1

FMR50

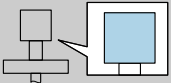
 = C	(2)		P1		P2		P3		P4		P5		P6	
			T _p	T _a	T _p	T _a	T _p	T _a	T _p	T _a	T _p	T _a	T _p	T _a
	B, C	T6	-40	60	60	60	80	58	80	-40	-40	-40	-	-

 Explosion protection: Division 2

Antenna: Class I, Zone 0 / Class I, Division 1;
 Electronics housing: Class I, Division 2

FMR50

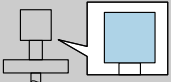
 = C	(2)		P1		P2		P3		P4		P5		P6	
			T _p	T _a	T _p	T _a	T _p	T _a	T _p	T _a	T _p	T _a	T _p	T _a
	B	T6	-40	51	51	51	80	49	80	-40	-40	-40	-	-
	C	T6	-40	60	60	60	80	58	80	-40	-40	-40	-	-

 Explosion protection: XP / AEx db [ia]/Ex db [ia]

Antenna: Class I, Zone 0 / Class I, Division 1;

Electronics housing: Class I, Zone 1 / Class I, Division 1

FMR51

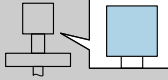
 = B	(2)	P1		P2		P3		P4		P5		P6		
		T _p	T _a	T _p	T _a	T _p	T _a	T _p	T _a	T _p	T _a	T _p	T _a	
	B	T6	-40	60	60	60	85	54	85	-40	-40	-40	-	-
		T5	-40	75	75	75	100	69	100	-40	-40	-40	-	-
		T4	-40	75	75	75	135	62	135	-40	-40	-40	-	-
		T3 ¹⁾	-40	75	75	75	150	59	150	-40	-40	-40	-	-
	C	T6	-40	60	60	60	85	54	85	-40	-40	-40	-	-
		T5	-40	75	75	75	100	69	100	-40	-40	-40	-	-
		T4	-40	78	78	78	135	66	135	-40	-40	-40	-	-
		T3 ¹⁾	-40	78	78	78	150	63	150	-40	-40	-40	-	-

1) Functional: Maximum permissible process temperature

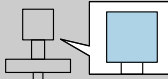
 = C	(2)	P1		P2		P3		P4		P5		P6		
		T _p	T _a	T _p	T _a	T _p	T _a	T _p	T _a	T _p	T _a	T _p	T _a	
	B	T6	-40	60	60	60	85	55	85	-40	-40	-40	-	-
		T5	-40	75	75	75	100	70	100	-40	-40	-40	-	-
		T4	-40	75	75	75	135	65	135	-40	-40	-40	-	-
		T3 ¹⁾	-40	75	75	75	150	62	150	-40	-40	-40	-	-
	C	T6	-40	60	60	60	85	55	85	-40	-40	-40	-	-
		T5	-40	75	75	75	100	70	100	-40	-40	-40	-	-
		T4	-40	78	78	78	135	68	135	-40	-40	-40	-	-
		T3 ¹⁾	-40	78	78	78	150	66	150	-40	-40	-40	-	-

1) Functional: Maximum permissible process temperature

FMR51

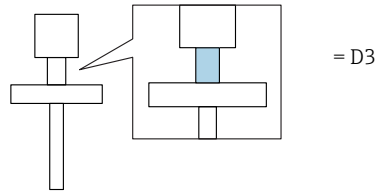

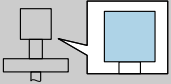
 = B	(2)	P1		P2		P3		P4		P5		P6		
		T _p	T _a	T _p	T _a	T _p	T _a	T _p	T _a	T _p	T _a	T _p	T _a	
	B	T6	-40	60	60	60	85	57	85	-40	-40	-40	-	-
		T5	-40	75	75	75	100	72	100	-40	-40	-40	-	-
		T4	-40	75	75	75	135	69	135	-40	-40	-40	-	-
		T3	-40	75	75	75	200	62	200	-40	-40	-40	-	-
		T2 ¹⁾	-40	75	75	75	250	57	250	-40	-40	-40	-	-
	C	T6	-40	60	60	60	85	57	85	-40	-40	-40	-	-
		T5	-40	75	75	75	100	72	100	-40	-40	-40	-	-
		T4	-40	78	78	78	135	72	135	-40	-40	-40	-	-
		T3	-40	78	78	78	200	65	200	-40	-40	-40	-	-
		T2 ¹⁾	-40	78	78	78	250	60	250	-40	-40	-40	-	-

1) Functional: Maximum permissible process temperature

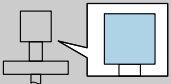
 = C	(2)	P1		P2		P3		P4		P5		P6		
		T _p	T _a	T _p	T _a	T _p	T _a	T _p	T _a	T _p	T _a	T _p	T _a	
	B	T6	-40	60	60	60	85	58	85	-40	-40	-40	-	-
		T5	-40	75	75	75	100	73	100	-40	-40	-40	-	-
		T4	-40	75	75	75	135	70	135	-40	-40	-40	-	-
		T3	-40	75	75	75	200	65	200	-40	-40	-40	-	-
		T2 ¹⁾	-40	75	75	75	250	60	250	-40	-40	-40	-	-
	C	T6	-40	60	60	60	85	58	85	-40	-40	-40	-	-
		T5	-40	75	75	75	100	73	100	-40	-40	-40	-	-
		T4	-40	78	78	78	135	73	135	-40	-40	-40	-	-
		T3	-40	78	78	78	200	68	200	-40	-40	-40	-	-
		T2 ¹⁾	-40	78	78	78	250	64	250	-40	-40	-40	-	-

1) Functional: Maximum permissible process temperature

FMR51

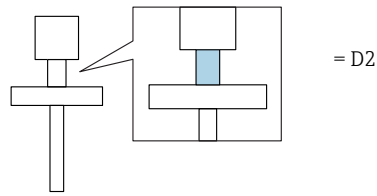

= B	(2)	P1		P2		P3		P4		P5		P6		
		T _p	T _a	T _p	T _a	T _p	T _a	T _p	T _a	T _p	T _a	T _p	T _a	
	B	T6	-196	60	60	60	85	56	85	-40 -50 ¹⁾	-40 -50 ¹⁾	-40 -50 ¹⁾	-196	-15
		T5	-196	75	75	75	100	71	100	-40 -50 ¹⁾	-40 -50 ¹⁾	-40 -50 ¹⁾	-196	-15
		T4	-196	75	75	75	135	67	135	-40 -50 ¹⁾	-40 -50 ¹⁾	-40 -50 ¹⁾	-196	-15
		T3	-196	75	75	75	200	58	200	-40 -50 ¹⁾	-40 -50 ¹⁾	-40 -50 ¹⁾	-196	-15
		T2	-196	75	75	75	300	44	300	-40 -50 ¹⁾	-40 -50 ¹⁾	-40 -50 ¹⁾	-196	-15
	C	T6	-196	60	60	60	85	56	85	-40 -50 ¹⁾	-40 -50 ¹⁾	-40 -50 ¹⁾	-196	-15
		T5	-196	75	75	75	100	71	100	-40 -50 ¹⁾	-40 -50 ¹⁾	-40 -50 ¹⁾	-196	-15
		T4	-196	78	78	78	135	70	135	-40 -50 ¹⁾	-40 -50 ¹⁾	-40 -50 ¹⁾	-196	-15
		T3	-196	78	78	78	200	61	200	-40 -50 ¹⁾	-40 -50 ¹⁾	-40 -50 ¹⁾	-196	-15
		T2	-196	78	78	78	300	48	300	-40 -50 ¹⁾	-40 -50 ¹⁾	-40 -50 ¹⁾	-196	-15

1) Only in connection with Optional specification, ID Jx (Test, Certificate) = JN

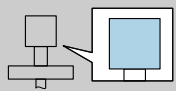
	(2)		P1		P2		P3		P4		P5		P6	
			T _p	T _a	T _p	T _a	T _p	T _a	T _p	T _a	T _p	T _a	T _p	T _a
	B	T6	-196	60	60	60	85	57	85	-40 -50 ¹⁾	-40 -50 ¹⁾	-40 -50 ¹⁾	-196	-20 -28 ¹⁾
		T5	-196	75	75	75	100	72	100	-40 -50 ¹⁾	-40 -50 ¹⁾	-40 -50 ¹⁾	-196	-20 -28 ¹⁾
		T4	-196	75	75	75	135	68	135	-40 -50 ¹⁾	-40 -50 ¹⁾	-40 -50 ¹⁾	-196	-20 -28 ¹⁾
		T3	-196	75	75	75	200	61	200	-40 -50 ¹⁾	-40 -50 ¹⁾	-40 -50 ¹⁾	-196	-20 -28 ¹⁾
		T2	-196	75	75	75	300	51	300	-40 -50 ¹⁾	-40 -50 ¹⁾	-40 -50 ¹⁾	-196	-20 -28 ¹⁾
		T1	-196	75	75	75	450	34	450	-40 -50 ¹⁾	-40 -50 ¹⁾	-40 -50 ¹⁾	-196	-20 -28 ¹⁾
	C	T6	-196	60	60	60	85	57	85	-40 -50 ¹⁾	-40 -50 ¹⁾	-40 -50 ¹⁾	-196	-20 -28 ¹⁾
		T5	-196	75	75	75	100	72	100	-40 -50 ¹⁾	-40 -50 ¹⁾	-40 -50 ¹⁾	-196	-20 -28 ¹⁾
		T4	-196	78	78	78	135	72	135	-40 -50 ¹⁾	-40 -50 ¹⁾	-40 -50 ¹⁾	-196	-20 -28 ¹⁾
		T3	-196	78	78	78	200	65	200	-40 -50 ¹⁾	-40 -50 ¹⁾	-40 -50 ¹⁾	-196	-20 -28 ¹⁾
		T2	-196	78	78	78	300	54	300	-40 -50 ¹⁾	-40 -50 ¹⁾	-40 -50 ¹⁾	-196	-20 -28 ¹⁾
		T1	-196	78	78	78	450	38	450	-40 -50 ¹⁾	-40 -50 ¹⁾	-40 -50 ¹⁾	-196	-20 -28 ¹⁾

1) Only in connection with Optional specification, ID Jx (Test, Certificate) = JN

 Explosion protection: Division 2

Antenna: Class I, Zone 0 / Class I, Division 1;
Electronics housing: Class I, Division 2

FMR51

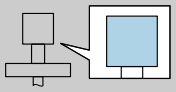
 = B	(2)	P1		P2		P3		P4		P5		P6		
		T _p	T _a	T _p	T _a	T _p	T _a	T _p	T _a	T _p	T _a	T _p	T _a	
	B	T6	-40	51	51	51	85	44	85	-40	-40	-40	-	-
		T5	-40	66	66	66	100	59	100	-40	-40	-40	-	-
		T4	-40	75	75	75	135	62	135	-40	-40	-40	-	-
		T3 ¹⁾	-40	75	75	75	150	59	150	-40	-40	-40	-	-
	C	T6	-40	60	60	60	85	54	85	-40	-40	-40	-	-
		T5	-40	75	75	75	100	69	100	-40	-40	-40	-	-
		T4	-40	78	78	78	135	66	135	-40	-40	-40	-	-
		T3 ¹⁾	-40	78	78	78	150	63	150	-40	-40	-40	-	-

1) Functional: Maximum permissible process temperature

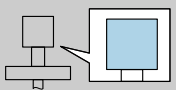
 = C	(2)	P1		P2		P3		P4		P5		P6		
		T _p	T _a	T _p	T _a	T _p	T _a	T _p	T _a	T _p	T _a	T _p	T _a	
	B	T6	-40	51	51	51	85	45	85	-40	-40	-40	-	-
		T5	-40	66	66	66	100	60	100	-40	-40	-40	-	-
		T4	-40	75	75	75	135	65	135	-40	-40	-40	-	-
		T3 ¹⁾	-40	75	75	75	150	62	150	-40	-40	-40	-	-
	C	T6	-40	60	60	60	85	55	85	-40	-40	-40	-	-
		T5	-40	75	75	75	100	70	100	-40	-40	-40	-	-
		T4	-40	78	78	78	135	68	135	-40	-40	-40	-	-
		T3 ¹⁾	-40	78	78	78	150	66	150	-40	-40	-40	-	-

1) Functional: Maximum permissible process temperature

FMR51

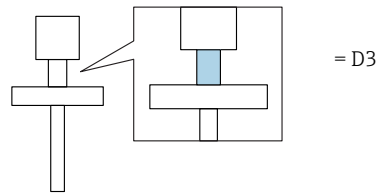

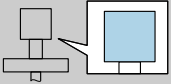
 = B	(2)	P1		P2		P3		P4		P5		P6		
		T _p	T _a	T _p	T _a	T _p	T _a	T _p	T _a	T _p	T _a	T _p	T _a	
	B	T6	-40	51	51	51	85	48	85	-40	-40	-40	-	-
		T5	-40	66	66	66	100	63	100	-40	-40	-40	-	-
		T4	-40	75	75	75	135	69	135	-40	-40	-40	-	-
		T3	-40	75	75	75	200	62	200	-40	-40	-40	-	-
		T2 ¹⁾	-40	75	75	75	250	57	250	-40	-40	-40	-	-
	C	T6	-40	60	60	60	85	57	85	-40	-40	-40	-	-
		T5	-40	75	75	75	100	72	100	-40	-40	-40	-	-
		T4	-40	78	78	78	135	72	135	-40	-40	-40	-	-
		T3	-40	78	78	78	200	65	200	-40	-40	-40	-	-
		T2 ¹⁾	-40	78	78	78	250	60	250	-40	-40	-40	-	-

1) Functional: Maximum permissible process temperature

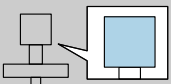
 = C	(2)	P1		P2		P3		P4		P5		P6		
		T _p	T _a	T _p	T _a	T _p	T _a	T _p	T _a	T _p	T _a	T _p	T _a	
	B	T6	-40	51	51	51	85	48	85	-40	-40	-40	-	-
		T5	-40	66	66	66	100	63	100	-40	-40	-40	-	-
		T4	-40	75	75	75	135	70	135	-40	-40	-40	-	-
		T3	-40	75	75	75	200	65	200	-40	-40	-40	-	-
		T2 ¹⁾	-40	75	75	75	250	60	250	-40	-40	-40	-	-
	C	T6	-40	60	60	60	85	58	85	-40	-40	-40	-	-
		T5	-40	75	75	75	100	73	100	-40	-40	-40	-	-
		T4	-40	78	78	78	135	73	135	-40	-40	-40	-	-
		T3	-40	78	78	78	200	68	200	-40	-40	-40	-	-
		T2 ¹⁾	-40	78	78	78	250	64	250	-40	-40	-40	-	-

1) Functional: Maximum permissible process temperature

FMR51

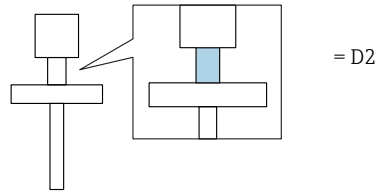

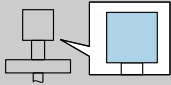
 = B	(2)	P1		P2		P3		P4		P5		P6		
		T _p	T _a	T _p	T _a	T _p	T _a	T _p	T _a	T _p	T _a	T _p	T _a	
	B	T6	-196	51	51	51	85	47	85	-40	-40	-40	-196	-15
		T5	-196	66	66	66	100	62	100	-40	-40	-40	-196	-15
		T4	-196	75	75	75	135	67	135	-40	-40	-40	-196	-15
		T3	-196	75	75	75	200	58	200	-40	-40	-40	-196	-15
		T2	-196	75	75	75	300	44	300	-40	-40	-40	-196	-15
	C	T6	-196	60	60	60	85	56	85	-40	-40	-40	-196	-15
		T5	-196	75	75	75	100	71	100	-40	-40	-40	-196	-15
		T4	-196	78	78	78	135	70	135	-40	-40	-40	-196	-15
		T3	-196	78	78	78	200	61	200	-40	-40	-40	-196	-15
		T2	-196	78	78	78	300	48	300	-40	-40	-40	-196	-15

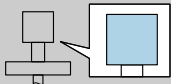
 = C	(2)	P1		P2		P3		P4		P5		P6		
		T _p	T _a	T _p	T _a	T _p	T _a	T _p	T _a	T _p	T _a	T _p	T _a	
	B	T6	-196	51	51	51	85	48	85	-40	-40	-40	-196	-20
		T5	-196	66	66	66	100	63	100	-40	-40	-40	-196	-20
		T4	-196	75	75	75	135	68	135	-40	-40	-40	-196	-20
		T3	-196	75	75	75	200	61	200	-40	-40	-40	-196	-20
		T2	-196	75	75	75	300	51	300	-40	-40	-40	-196	-20
		T1	-196	75	75	75	450	34	450	-40	-40	-40	-196	-20
	C	T6	-196	60	60	60	85	57	85	-40	-40	-40	-196	-20
		T5	-196	75	75	75	100	72	100	-40	-40	-40	-196	-20
		T4	-196	78	78	78	135	72	135	-40	-40	-40	-196	-20
		T3	-196	78	78	78	200	65	200	-40	-40	-40	-196	-20
		T1	-196	78	78	78	450	38	450	-40	-40	-40	-196	-20

 Explosion protection: XP / AEx db [ia]/Ex db [ia]

Antenna: Class I, Zone 0 / Class I, Division 1;

Electronics housing: Class I, Zone 1 / Class I, Division 1

FMR52

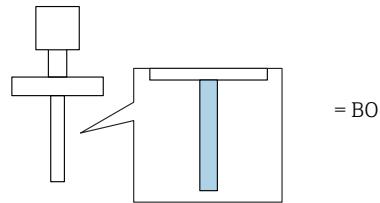

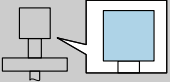
 = B	(2)	P1		P2		P3		P4		P5		P6		
		T _p	T _a	T _p	T _a	T _p	T _a	T _p	T _a	T _p	T _a	T _p	T _a	
	B	T6	-196	60	60	60	85	55	85	-40 -50 ¹⁾	-40 -50 ¹⁾	-40 -50 ¹⁾	-196	-3
		T5	-196	75	75	75	100	70	100	-40 -50 ¹⁾	-40 -50 ¹⁾	-40 -50 ¹⁾	-196	-3
		T4	-196	75	75	75	135	65	135	-40 -50 ¹⁾	-40 -50 ¹⁾	-40 -50 ¹⁾	-196	-3
		T3	-196	75	75	75	200	53	200	-40 -50 ¹⁾	-40 -50 ¹⁾	-40 -50 ¹⁾	-196	-3
	C	T6	-196	60	60	60	85	55	85	-40 -50 ¹⁾	-40 -50 ¹⁾	-40 -50 ¹⁾	-196	-3
		T5	-196	75	75	75	100	70	100	-40 -50 ¹⁾	-40 -50 ¹⁾	-40 -50 ¹⁾	-196	-3
		T4	-196	78	78	78	135	68	135	-40 -50 ¹⁾	-40 -50 ¹⁾	-40 -50 ¹⁾	-196	-3
		T3	-196	78	78	78	200	57	200	-40 -50 ¹⁾	-40 -50 ¹⁾	-40 -50 ¹⁾	-196	-3

1) Only in connection with Optional specification, ID Jx (Test, Certificate) = JN

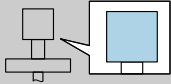
 = C	(2)		P1		P2		P3		P4		P5		P6	
			T _p	T _a	T _p	T _a	T _p	T _a	T _p	T _a	T _p	T _a	T _p	T _a
	B	T6	-196	60	60	60	85	56	85	-40 -50 ¹⁾	-40 -50 ¹⁾	-40 -50 ¹⁾	-196	-14
		T5	-196	75	75	75	100	71	100	-40 -50 ¹⁾	-40 -50 ¹⁾	-40 -50 ¹⁾	-196	-14
		T4	-196	75	75	75	135	67	135	-40 -50 ¹⁾	-40 -50 ¹⁾	-40 -50 ¹⁾	-196	-14
		T3	-196	75	75	75	200	58	200	-40 -50 ¹⁾	-40 -50 ¹⁾	-40 -50 ¹⁾	-196	-14
	C	T6	-196	60	60	60	85	56	85	-40 -50 ¹⁾	-40 -50 ¹⁾	-40 -50 ¹⁾	-196	-14
		T5	-196	75	75	75	100	71	100	-40 -50 ¹⁾	-40 -50 ¹⁾	-40 -50 ¹⁾	-196	-14
		T4	-196	78	78	78	135	70	135	-40 -50 ¹⁾	-40 -50 ¹⁾	-40 -50 ¹⁾	-196	-14
		T3	-196	78	78	78	200	61	200	-40 -50 ¹⁾	-40 -50 ¹⁾	-40 -50 ¹⁾	-196	-14

1) Only in connection with Optional specification, ID Jx (Test, Certificate) = JN

FMR52

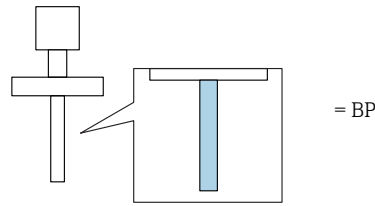

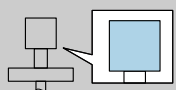
 = B	(2)		P1		P2		P3		P4		P5		P6	
			T _p	T _a	T _p	T _a	T _p	T _a	T _p	T _a	T _p	T _a	T _p	T _a
	B	T6	-196	60	60	60	85	54	85	-40 -50 ¹⁾	-40 -50 ¹⁾	-40 -50 ¹⁾	-196	10
		T5	-196	75	75	75	100	69	100	-40 -50 ¹⁾	-40 -50 ¹⁾	-40 -50 ¹⁾	-196	10
		T4	-196	75	75	75	135	63	135	-40 -50 ¹⁾	-40 -50 ¹⁾	-40 -50 ¹⁾	-196	10
		T3	-196	75	75	75	200	49	200	-40 -50 ¹⁾	-40 -50 ¹⁾	-40 -50 ¹⁾	-196	10
	C	T6	-196	60	60	60	85	54	85	-40 -50 ¹⁾	-40 -50 ¹⁾	-40 -50 ¹⁾	-196	10
		T5	-196	75	75	75	100	69	100	-40 -50 ¹⁾	-40 -50 ¹⁾	-40 -50 ¹⁾	-196	10
		T4	-196	78	78	78	135	66	135	-40 -50 ¹⁾	-40 -50 ¹⁾	-40 -50 ¹⁾	-196	10
		T3	-196	78	78	78	200	53	200	-40 -50 ¹⁾	-40 -50 ¹⁾	-40 -50 ¹⁾	-196	10

1) Only in connection with Optional specification, ID Jx (Test, Certificate) = JN

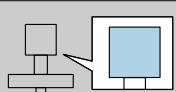
 = C	(2)		P1		P2		P3		P4		P5		P6	
			T _p	T _a	T _p	T _a	T _p	T _a	T _p	T _a	T _p	T _a	T _p	T _a
	B	T6	-196	60	60	60	85	55	85	-40 -50 ¹⁾	-40 -50 ¹⁾	-40 -50 ¹⁾	-196	-8
		T5	-196	75	75	75	100	70	100	-40 -50 ¹⁾	-40 -50 ¹⁾	-40 -50 ¹⁾	-196	-8
		T4	-196	75	75	75	135	65	135	-40 -50 ¹⁾	-40 -50 ¹⁾	-40 -50 ¹⁾	-196	-8
		T3	-196	75	75	75	200	54	200	-40 -50 ¹⁾	-40 -50 ¹⁾	-40 -50 ¹⁾	-196	-8
	C	T6	-196	60	60	60	85	55	85	-40 -50 ¹⁾	-40 -50 ¹⁾	-40 -50 ¹⁾	-196	-8
		T5	-196	75	75	75	100	70	100	-40 -50 ¹⁾	-40 -50 ¹⁾	-40 -50 ¹⁾	-196	-8
		T4	-196	78	78	78	135	69	135	-40 -50 ¹⁾	-40 -50 ¹⁾	-40 -50 ¹⁾	-196	-8
		T3	-196	78	78	78	200	58	200	-40 -50 ¹⁾	-40 -50 ¹⁾	-40 -50 ¹⁾	-196	-8

1) Only in connection with Optional specification, ID Jx (Test, Certificate) = JN

 Explosion protection: Division 2

Antenna: Class I, Zone 0 / Class I, Division 1;
 Electronics housing: Class I, Division 2

FMR52

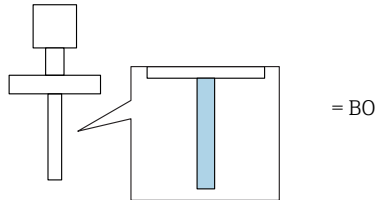

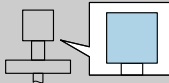
 = B	(2)	P1		P2		P3		P4		P5		P6		
		T _p	T _a	T _p	T _a	T _p	T _a	T _p	T _a	T _p	T _a	T _p	T _a	
	B	T6	-196	51	51	51	85	45	85	-40	-40	-40	-196	-3
		T5	-196	66	66	66	100	60	100	-40	-40	-40	-196	-3
		T4	-196	75	75	75	135	65	135	-40	-40	-40	-196	-3
		T3	-196	75	75	75	200	53	200	-40	-40	-40	-196	-3
	C	T6	-196	60	60	60	85	55	85	-40	-40	-40	-196	-3
		T5	-196	75	75	75	100	70	100	-40	-40	-40	-196	-3
		T4	-196	78	78	78	135	68	135	-40	-40	-40	-196	-3
		T3	-196	78	78	78	200	57	200	-40	-40	-40	-196	-3

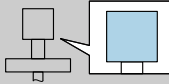
 = C	(2)	P1		P2		P3		P4		P5		P6		
		T _p	T _a	T _p	T _a	T _p	T _a	T _p	T _a	T _p	T _a	T _p	T _a	
	B	T6	-196	51	51	51	85	47	85	-40	-40	-40	-196	-14
		T5	-196	66	66	66	100	62	100	-40	-40	-40	-196	-14
		T4	-196	75	75	75	135	67	135	-40	-40	-40	-196	-14
		T3	-196	75	75	75	200	58	200	-40	-40	-40	-196	-14
	C	T6	-196	60	60	60	85	56	85	-40	-40	-40	-196	-14
		T5	-196	75	75	75	100	71	100	-40	-40	-40	-196	-14
		T4	-196	78	78	78	135	70	135	-40	-40	-40	-196	-14
		T3	-196	78	78	78	200	61	200	-40	-40	-40	-196	-14

FMR52

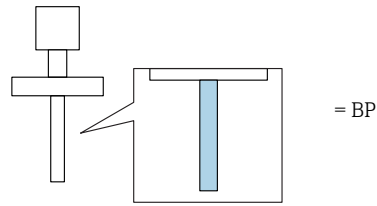

	(2)		P1		P2		P3		P4		P5		P6	
			T _p	T _a	T _p	T _a	T _p	T _a	T _p	T _a	T _p	T _a	T _p	T _a
	B	T6	-196	51	51	51	85	44	85	-40	-40	-40	-196	10
		T5	-196	66	66	66	100	59	100	-40	-40	-40	-196	10
		T4	-196	75	75	75	135	63	135	-40	-40	-40	-196	10
		T3	-196	75	75	75	200	49	200	-40	-40	-40	-196	10
	C	T6	-196	60	60	60	85	54	85	-40	-40	-40	-196	10
		T5	-196	75	75	75	100	69	100	-40	-40	-40	-196	10
		T4	-196	78	78	78	135	66	135	-40	-40	-40	-196	10
		T3	-196	78	78	78	200	53	200	-40	-40	-40	-196	10

	(2)		P1		P2		P3		P4		P5		P6	
			T _p	T _a	T _p	T _a	T _p	T _a	T _p	T _a	T _p	T _a	T _p	T _a
	B	T6	-196	51	51	51	85	46	85	-40	-40	-40	-196	-8
		T5	-196	66	66	66	100	61	100	-40	-40	-40	-196	-8
		T4	-196	75	75	75	135	65	135	-40	-40	-40	-196	-8
		T3	-196	75	75	75	200	54	200	-40	-40	-40	-196	-8
	C	T6	-196	60	60	60	85	55	85	-40	-40	-40	-196	-8
		T5	-196	75	75	75	100	70	100	-40	-40	-40	-196	-8
		T4	-196	78	78	78	135	69	135	-40	-40	-40	-196	-8
		T3	-196	78	78	78	200	58	200	-40	-40	-40	-196	-8

 Explosion protection: XP / AEx db [ia]/Ex db [ia]

Antenna: Class I, Zone 0 / Class I, Division 1;

Electronics housing: Class I, Zone 1 / Class I, Division 1

FMR53

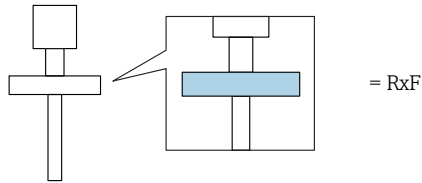

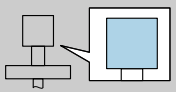
 = B, C	(2)		P1		P2		P3		P4		P5		P6	
			T _p	T _a	T _p	T _a	T _p	T _a	T _p	T _a	T _p	T _a	T _p	T _a
	B, C	T6	-40	60	60	60	80	58	80	-40	-40	-40	-	-

FMR53

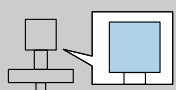
 = B	(2)	P1		P2		P3		P4		P5		P6		
		T _p	T _a	T _p	T _a	T _p	T _a	T _p	T _a	T _p	T _a	T _p	T _a	
	B	T6	-40	60	60	60	85	53	85	-40	-40	-40	-	-
		T5	-40	75	75	75	100	68	100	-40	-40	-40	-	-
		T4	-40	75	75	75	135	61	135	-40	-40	-40	-	-
		T3 ¹⁾	-40	75	75	75	150	58	150	-40	-40	-40	-	-
	C	T6	-40	60	60	60	85	53	85	-40	-40	-40	-	-
		T5	-40	75	75	75	100	68	100	-40	-40	-40	-	-
		T4	-40	78	78	78	135	65	135	-40	-40	-40	-	-
		T3 ¹⁾	-40	78	78	78	150	61	150	-40	-40	-40	-	-

1) Functional: Maximum permissible process temperature

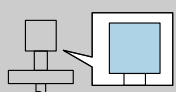
 = C	(2)	P1		P2		P3		P4		P5		P6		
		T _p	T _a	T _p	T _a	T _p	T _a	T _p	T _a	T _p	T _a	T _p	T _a	
	B	T6	-40	60	60	60	85	54	85	-40	-40	-40	-	-
		T5	-40	75	75	75	100	69	100	-40	-40	-40	-	-
		T4	-40	75	75	75	135	64	135	-40	-40	-40	-	-
		T3 ¹⁾	-40	75	75	75	150	61	150	-40	-40	-40	-	-
	C	T6	-40	60	60	60	85	54	85	-40	-40	-40	-	-
		T5	-40	75	75	75	100	69	100	-40	-40	-40	-	-
		T4	-40	78	78	78	135	67	135	-40	-40	-40	-	-
		T3 ¹⁾	-40	78	78	78	150	64	150	-40	-40	-40	-	-

1) Functional: Maximum permissible process temperature

 Explosion protection: Division 2

Antenna: Class I, Zone 0 / Class I, Division 1;
 Electronics housing: Class I, Division 2

FMR53

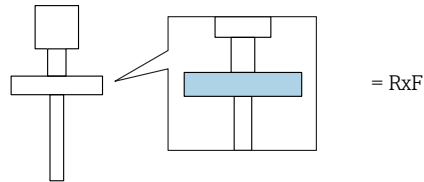

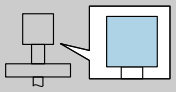
 = B, C	(2)	P1		P2		P3		P4		P5		P6	
		T _p	T _a	T _p	T _a	T _p	T _a	T _p	T _a	T _p	T _a	T _p	T _a
B	T6	-40	51	51	51	80	49	80	-40	-40	-40	-	-
C	T6	-40	60	60	60	80	58	80	-40	-40	-40	-	-

FMR53

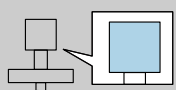
 = B	(2)	P1		P2		P3		P4		P5		P6		
		T _p	T _a	T _p	T _a	T _p	T _a	T _p	T _a	T _p	T _a	T _p	T _a	
	B	T6	-40	51	51	51	85	43	85	-40	-40	-40	-	-
		T5	-40	66	66	66	100	58	100	-40	-40	-40	-	-
		T4	-40	75	75	75	135	61	135	-40	-40	-40	-	-
		T3 ¹⁾	-40	75	75	75	150	58	150	-40	-40	-40	-	-
	C	T6	-40	60	60	60	85	53	85	-40	-40	-40	-	-
		T5	-40	75	75	75	100	68	100	-40	-40	-40	-	-
		T4	-40	78	78	78	135	65	135	-40	-40	-40	-	-
		T3 ¹⁾	-40	78	78	78	150	61	150	-40	-40	-40	-	-

1) Functional: Maximum permissible process temperature

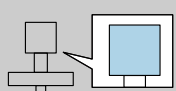
 = C	(2)	P1		P2		P3		P4		P5		P6		
		T _p	T _a	T _p	T _a	T _p	T _a	T _p	T _a	T _p	T _a	T _p	T _a	
	B	T6	-40	51	51	51	85	45	85	-40	-40	-40	-	-
		T5	-40	66	66	66	100	60	100	-40	-40	-40	-	-
		T4	-40	75	75	75	135	64	135	-40	-40	-40	-	-
		T3 ¹⁾	-40	75	75	75	150	61	150	-40	-40	-40	-	-
	C	T6	-40	60	60	60	85	54	85	-40	-40	-40	-	-
		T5	-40	75	75	75	100	69	100	-40	-40	-40	-	-
		T4	-40	78	78	78	135	67	135	-40	-40	-40	-	-
		T3 ¹⁾	-40	78	78	78	150	64	150	-40	-40	-40	-	-

1) Functional: Maximum permissible process temperature

 Explosion protection: XP / AEx db [ia]/Ex db [ia]

Antenna: Class I, Zone 0 / Class I, Division 1;

Electronics housing: Class I, Zone 1 / Class I, Division 1

FMR54

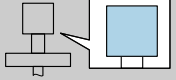
 = B	(2)	P1		P2		P3		P4		P5		P6		
		T _p	T _a	T _p	T _a	T _p	T _a	T _p	T _a	T _p	T _a	T _p	T _a	
	B	T6	-40	60	60	60	85	53	85	-40	-40	-40	-	-
		T5	-40	75	75	75	100	68	100	-40	-40	-40	-	-
		T4	-40	75	75	75	135	60	135	-40	-40	-40	-	-
		T3	-40	75	75	75	200	45	200	-40	-40	-40	-	-
	C	T6	-40	60	60	60	85	53	85	-40	-40	-40	-	-
		T5	-40	75	75	75	100	68	100	-40	-40	-40	-	-
		T4	-40	78	78	78	135	64	135	-40	-40	-40	-	-
		T3	-40	78	78	78	200	48	200	-40	-40	-40	-	-

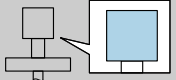
 = C	(2)	P1		P2		P3		P4		P5		P6		
		T _p	T _a	T _p	T _a	T _p	T _a	T _p	T _a	T _p	T _a	T _p	T _a	
	B	T6	-40	60	60	60	85	54	85	-40	-40	-40	-	-
		T5	-40	75	75	75	100	69	100	-40	-40	-40	-	-
		T4	-40	75	75	75	135	63	135	-40	-40	-40	-	-
		T3	-40	75	75	75	200	50	200	-40	-40	-40	-	-
	C	T6	-40	60	60	60	85	54	85	-40	-40	-40	-	-
		T5	-40	75	75	75	100	69	100	-40	-40	-40	-	-
		T4	-40	78	78	78	135	67	135	-40	-40	-40	-	-
		T3	-40	78	78	78	200	54	200	-40	-40	-40	-	-

FMR54

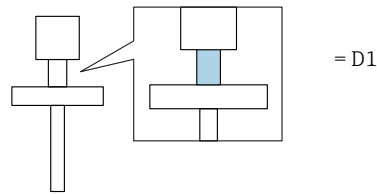

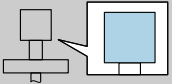
	(2)	P1		P2		P3		P4		P5		P6		
		T _p	T _a	T _p	T _a	T _p	T _a	T _p	T _a	T _p	T _a	T _p	T _a	
	B	T6	-196	60	60	60	85	55	85	-40 -50 ¹⁾	-40 -50 ¹⁾	-40 -50 ¹⁾	-196	-4
		T5	-196	75	75	75	100	70	100	-40 -50 ¹⁾	-40 -50 ¹⁾	-40 -50 ¹⁾	-196	-4
		T4	-196	75	75	75	135	65	135	-40 -50 ¹⁾	-40 -50 ¹⁾	-40 -50 ¹⁾	-196	-4
		T3	-196	75	75	75	200	54	200	-40 -50 ¹⁾	-40 -50 ¹⁾	-40 -50 ¹⁾	-196	-4
		T2 ²⁾	-196	75	75	75	280	40	280	-40 -50 ¹⁾	-40 -50 ¹⁾	-40 -50 ¹⁾	-196	-4
	C	T6	-196	60	60	60	85	55	85	-40 -50 ¹⁾	-40 -50 ¹⁾	-40 -50 ¹⁾	-196	-4
		T5	-196	75	75	75	100	70	100	-40 -50 ¹⁾	-40 -50 ¹⁾	-40 -50 ¹⁾	-196	-4
		T4	-196	78	78	78	135	68	135	-40 -50 ¹⁾	-40 -50 ¹⁾	-40 -50 ¹⁾	-196	-4
		T3	-196	78	78	78	200	57	200	-40 -50 ¹⁾	-40 -50 ¹⁾	-40 -50 ¹⁾	-196	-4
		T2 ²⁾	-196	78	78	78	280	44	280	-40 -50 ¹⁾	-40 -50 ¹⁾	-40 -50 ¹⁾	-196	-4

- 1) Only in connection with Optional specification, ID Jx (Test, Certificate) = JN
- 2) Functional: Maximum permissible process temperature

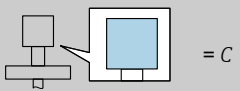
	(2)		P1		P2		P3		P4		P5		P6	
			T _p	T _a	T _p	T _a	T _p	T _a	T _p	T _a	T _p	T _a	T _p	T _a
	B	T6	-196	60	60	60	85	56	85	-40 -50 ¹⁾	-40 -50 ¹⁾	-40 -50 ¹⁾	-196	-15
		T5	-196	75	75	75	100	71	100	-40 -50 ¹⁾	-40 -50 ¹⁾	-40 -50 ¹⁾	-196	-15
		T4	-196	75	75	75	135	67	135	-40 -50 ¹⁾	-40 -50 ¹⁾	-40 -50 ¹⁾	-196	-15
		T3	-196	75	75	75	200	58	200	-40 -50 ¹⁾	-40 -50 ¹⁾	-40 -50 ¹⁾	-196	-15
		T2 ²⁾	-196	75	75	75	280	47	280	-40 -50 ¹⁾	-40 -50 ¹⁾	-40 -50 ¹⁾	-196	-15
	C	T6	-196	60	60	60	85	56	85	-40 -50 ¹⁾	-40 -50 ¹⁾	-40 -50 ¹⁾	-196	-15
		T5	-196	75	75	75	100	71	100	-40 -50 ¹⁾	-40 -50 ¹⁾	-40 -50 ¹⁾	-196	-15
		T4	-196	78	78	78	135	70	135	-40 -50 ¹⁾	-40 -50 ¹⁾	-40 -50 ¹⁾	-196	-15
		T3	-196	78	78	78	200	61	200	-40 -50 ¹⁾	-40 -50 ¹⁾	-40 -50 ¹⁾	-196	-15
		T2 ²⁾	-196	78	78	78	280	51	280	-40 -50 ¹⁾	-40 -50 ¹⁾	-40 -50 ¹⁾	-196	-15

1) Only in connection with Optional specification, ID Jx (Test, Certificate) = JN

2) Functional: Maximum permissible process temperature

FMR54

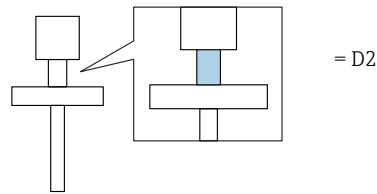

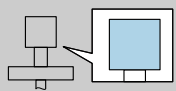
	(2)	P1		P2		P3		P4		P5		P6		
		T _p	T _a	T _p	T _a	T _p	T _a	T _p	T _a	T _p	T _a	T _p	T _a	
	B	T6	-196	60	60	60	85	56	85	-40 -50 ¹⁾	-40 -50 ¹⁾	-40 -50 ¹⁾	-196	-13
		T5	-196	75	75	75	100	71	100	-40 -50 ¹⁾	-40 -50 ¹⁾	-40 -50 ¹⁾	-196	-13
		T4	-196	75	75	75	135	66	135	-40 -50 ¹⁾	-40 -50 ¹⁾	-40 -50 ¹⁾	-196	-13
		T3	-196	75	75	75	200	57	200	-40 -50 ¹⁾	-40 -50 ¹⁾	-40 -50 ¹⁾	-196	-13
		T1 ²⁾	-196	75	75	75	300	42	300	-40 -50 ¹⁾	-40 -50 ¹⁾	-40 -50 ¹⁾	-196	-13
	C	T6	-196	60	60	60	85	56	85	-40 -50 ¹⁾	-40 -50 ¹⁾	-40 -50 ¹⁾	-196	-13
		T5	-196	75	75	75	100	71	100	-40 -50 ¹⁾	-40 -50 ¹⁾	-40 -50 ¹⁾	-196	-13
		T4	-196	78	78	78	135	70	135	-40 -50 ¹⁾	-40 -50 ¹⁾	-40 -50 ¹⁾	-196	-13
		T3	-196	78	78	78	200	60	200	-40 -50 ¹⁾	-40 -50 ¹⁾	-40 -50 ¹⁾	-196	-13
		T2	-196	78	78	78	300	46	300	-40 -50 ¹⁾	-40 -50 ¹⁾	-40 -50 ¹⁾	-196	-13
		T1 ²⁾	-196	78	78	78	400	31	400	-40 -50 ¹⁾	-40 -50 ¹⁾	-40 -50 ¹⁾	-196	-13

1) Only in connection with Optional specification, ID Jx (Test, Certificate) = JN

2) Functional: Maximum permissible process temperature

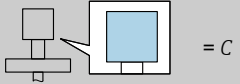
	(2)		P1		P2		P3		P4		P5		P6	
			T _p	T _a	T _p	T _a	T _p	T _a	T _p	T _a	T _p	T _a	T _p	T _a
	B	T6	-196	60	60	60	85	57	85	-40 -50 ¹⁾	-40 -50 ¹⁾	-40 -50 ¹⁾	-196	-19 -26 ¹⁾
		T5	-196	75	75	75	100	72	100	-40 -50 ¹⁾	-40 -50 ¹⁾	-40 -50 ¹⁾	-196	-19 -26 ¹⁾
		T4	-196	75	75	75	135	68	135	-40 -50 ¹⁾	-40 -50 ¹⁾	-40 -50 ¹⁾	-196	-19 -26 ¹⁾
		T3	-196	75	75	75	200	60	200	-40 -50 ¹⁾	-40 -50 ¹⁾	-40 -50 ¹⁾	-196	-19 -26 ¹⁾
		T2	-196	75	75	75	300	49	300	-40 -50 ¹⁾	-40 -50 ¹⁾	-40 -50 ¹⁾	-196	-19 -26 ¹⁾
		T1 ²⁾	-196	75	75	75	400	37	400	-40 -50 ¹⁾	-40 -50 ¹⁾	-40 -50 ¹⁾	-196	-19 -26 ¹⁾
	C	T6	-196	60	60	60	85	57	85	-40 -50 ¹⁾	-40 -50 ¹⁾	-40 -50 ¹⁾	-196	-19 -26 ¹⁾
		T5	-196	75	75	75	100	72	100	-40 -50 ¹⁾	-40 -50 ¹⁾	-40 -50 ¹⁾	-196	-19 -26 ¹⁾
		T4	-196	78	78	78	135	71	135	-40 -50 ¹⁾	-40 -50 ¹⁾	-40 -50 ¹⁾	-196	-19 -26 ¹⁾
		T3	-196	78	78	78	200	64	200	-40 -50 ¹⁾	-40 -50 ¹⁾	-40 -50 ¹⁾	-196	-19 -26 ¹⁾
		T2	-196	78	78	78	300	52	300	-40 -50 ¹⁾	-40 -50 ¹⁾	-40 -50 ¹⁾	-196	-19 -26 ¹⁾
		T1 ²⁾	-196	78	78	78	400	41	400	-40 -50 ¹⁾	-40 -50 ¹⁾	-40 -50 ¹⁾	-196	-19 -26 ¹⁾

1) Only in connection with Optional specification, ID Jx (Test, Certificate) = JN

2) Functional: Maximum permissible process temperature

FMR54

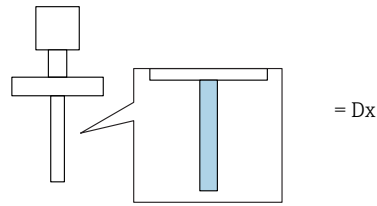

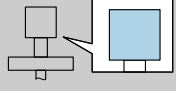
 = B	(2)		P1		P2		P3		P4		P5		P6	
			T _p	T _a	T _p	T _a	T _p	T _a	T _p	T _a	T _p	T _a	T _p	T _a
	B	T6	-40	60	60	60	85	55	85	-40	-40	-40	-	-
		T5	-40	75	75	75	100	70	100	-40	-40	-40	-	-
		T4	-40	75	75	75	135	64	135	-40	-40	-40	-	-
		T3 ¹⁾	-40	75	75	75	150	62	150	-40	-40	-40	-	-
	C	T6	-40	60	60	60	85	55	85	-40	-40	-40	-	-
		T5	-40	75	75	75	100	70	100	-40	-40	-40	-	-
		T4	-40	78	78	78	135	68	135	-40	-40	-40	-	-
		T3 ¹⁾	-40	78	78	78	150	65	150	-40	-40	-40	-	-

1) Functional: Maximum permissible process temperature

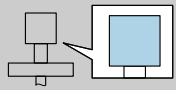
 = C	(2)		P1		P2		P3		P4		P5		P6	
			T _p	T _a	T _p	T _a	T _p	T _a	T _p	T _a	T _p	T _a	T _p	T _a
	B	T6	-40	60	60	60	85	56	85	-40	-40	-40	-	-
		T5	-40	75	75	75	100	71	100	-40	-40	-40	-	-
		T4	-40	75	75	75	135	66	135	-40	-40	-40	-	-
		T3 ¹⁾	-40	75	75	75	150	64	150	-40	-40	-40	-	-
	C	T6	-40	60	60	60	85	56	85	-40	-40	-40	-	-
		T5	-40	75	75	75	100	71	100	-40	-40	-40	-	-
		T4	-40	78	78	78	135	70	135	-40	-40	-40	-	-
		T3 ¹⁾	-40	78	78	78	150	68	150	-40	-40	-40	-	-

1) Functional: Maximum permissible process temperature

 Explosion protection: Division 2

Antenna: Class I, Zone 0 / Class I, Division 1;
 Electronics housing: Class I, Division 2

FMR54

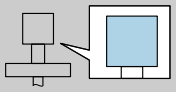
 = B	(2)	P1		P2		P3		P4		P5		P6		
		T _p	T _a	T _p	T _a	T _p	T _a	T _p	T _a	T _p	T _a	T _p	T _a	
	B	T6	-40	51	51	51	85	43	85	-40	-40	-40	-	-
		T5	-40	66	66	66	100	58	100	-40	-40	-40	-	-
		T4	-40	75	75	75	135	60	135	-40	-40	-40	-	-
		T3	-40	75	75	75	200	45	200	-40	-40	-40	-	-
	C	T6	-40	60	60	60	85	53	85	-40	-40	-40	-	-
		T5	-40	75	75	75	100	68	100	-40	-40	-40	-	-
		T4	-40	78	78	78	135	64	135	-40	-40	-40	-	-
		T3	-40	78	78	78	200	48	200	-40	-40	-40	-	-

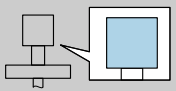
 = C	(2)	P1		P2		P3		P4		P5		P6		
		T _p	T _a	T _p	T _a	T _p	T _a	T _p	T _a	T _p	T _a	T _p	T _a	
	B	T6	-40	51	51	51	85	44	85	-40	-40	-40	-	-
		T5	-40	66	66	66	100	59	100	-40	-40	-40	-	-
		T4	-40	75	75	75	135	63	135	-40	-40	-40	-	-
		T3	-40	75	75	75	200	50	200	-40	-40	-40	-	-
	C	T6	-40	60	60	60	85	54	85	-40	-40	-40	-	-
		T5	-40	75	75	75	100	69	100	-40	-40	-40	-	-
		T4	-40	78	78	78	135	67	135	-40	-40	-40	-	-
		T3	-40	78	78	78	200	54	200	-40	-40	-40	-	-

FMR54

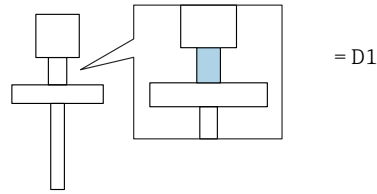

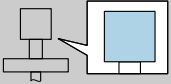
 = B	(2)	P1		P2		P3		P4		P5		P6		
		T _p	T _a	T _p	T _a	T _p	T _a	T _p	T _a	T _p	T _a	T _p	T _a	
	B	T6	-196	51	51	51	85	45	85	-40	-40	-40	-196	-4
		T5	-196	66	66	66	100	60	100	-40	-40	-40	-196	-4
		T4	-196	75	75	75	135	65	135	-40	-40	-40	-196	-4
		T3	-196	75	75	75	200	54	200	-40	-40	-40	-196	-4
		T2 ¹⁾	-196	75	75	75	280	40	280	-40	-40	-40	-196	-4
	C	T6	-196	60	60	60	85	55	85	-40	-40	-40	-196	-4
		T5	-196	75	75	75	100	70	100	-40	-40	-40	-196	-4
		T4	-196	78	78	78	135	68	135	-40	-40	-40	-196	-4
		T3	-196	78	78	78	200	57	200	-40	-40	-40	-196	-4
		T2 ¹⁾	-196	78	78	78	280	44	280	-40	-40	-40	-196	-4

1) Functional: Maximum permissible process temperature

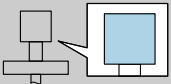
 = C	(2)	P1		P2		P3		P4		P5		P6		
		T _p	T _a	T _p	T _a	T _p	T _a	T _p	T _a	T _p	T _a	T _p	T _a	
	B	T6	-196	51	51	51	85	47	85	-40	-40	-40	-196	-15
		T5	-196	66	66	66	100	62	100	-40	-40	-40	-196	-15
		T4	-196	75	75	75	135	67	135	-40	-40	-40	-196	-15
		T3	-196	75	75	75	200	58	200	-40	-40	-40	-196	-15
		T2 ¹⁾	-196	75	75	75	280	47	280	-40	-40	-40	-196	-15
	C	T6	-196	60	60	60	85	56	85	-40	-40	-40	-196	-15
		T5	-196	75	75	75	100	71	100	-40	-40	-40	-196	-15
		T4	-196	78	78	78	135	70	135	-40	-40	-40	-196	-15
		T3	-196	78	78	78	200	61	200	-40	-40	-40	-196	-15
		T2 ¹⁾	-196	78	78	78	280	51	280	-40	-40	-40	-196	-15

1) Functional: Maximum permissible process temperature

FMR54

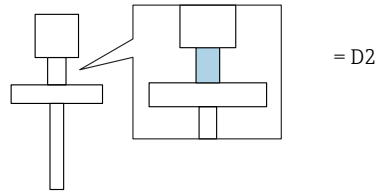

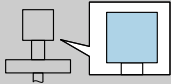
 = B	(2)	P1		P2		P3		P4		P5		P6		
		T _p	T _a	T _p	T _a	T _p	T _a	T _p	T _a	T _p	T _a	T _p	T _a	
	B	T6	-196	51	51	51	85	46	85	-40	-40	-40	-196	-13
		T5	-196	66	66	66	100	61	100	-40	-40	-40	-196	-13
		T4	-196	75	75	75	135	66	135	-40	-40	-40	-196	-13
		T3	-196	75	75	75	200	57	200	-40	-40	-40	-196	-13
		T2	-196	75	75	75	300	42	300	-40	-40	-40	-196	-13
	C	T6	-196	60	60	60	85	56	85	-40	-40	-40	-196	-13
		T5	-196	75	75	75	100	71	100	-40	-40	-40	-196	-13
		T4	-196	78	78	78	135	70	135	-40	-40	-40	-196	-13
		T3	-196	78	78	78	200	60	200	-40	-40	-40	-196	-13
		T2	-196	78	78	78	300	46	300	-40	-40	-40	-196	-13
		T1 ¹⁾	-196	78	78	78	400	31	400	-40	-40	-40	-196	-13

1) Functional: Maximum permissible process temperature

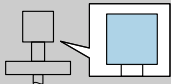
 = C	(2)	P1		P2		P3		P4		P5		P6		
		T _p	T _a	T _p	T _a	T _p	T _a	T _p	T _a	T _p	T _a	T _p	T _a	
	B	T6	-196	51	51	51	85	47	85	-40	-40	-40	-196	-19
		T5	-196	66	66	66	100	62	100	-40	-40	-40	-196	-19
		T4	-196	75	75	75	135	68	135	-40	-40	-40	-196	-19
		T3	-196	75	75	75	200	60	200	-40	-40	-40	-196	-19
		T2	-196	75	75	75	300	49	300	-40	-40	-40	-196	-19
		T1 ¹⁾	-196	75	75	75	400	37	400	-40	-40	-40	-196	-19
	C	T6	-196	60	60	60	85	57	85	-40	-40	-40	-196	-19
		T5	-196	75	75	75	100	72	100	-40	-40	-40	-196	-19
		T4	-196	78	78	78	135	71	135	-40	-40	-40	-196	-19
		T3	-196	78	78	78	200	64	200	-40	-40	-40	-196	-19
		T1 ¹⁾	-196	78	78	78	400	41	400	-40	-40	-40	-196	-19

1) Functional: Maximum permissible process temperature

FMR54

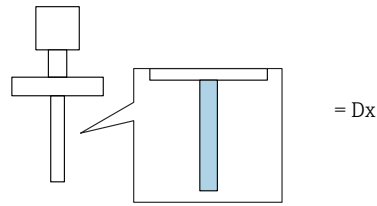

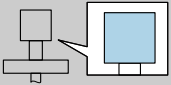
 = B	(2)	P1		P2		P3		P4		P5		P6		
		T _p	T _a	T _p	T _a	T _p	T _a	T _p	T _a	T _p	T _a	T _p	T _a	
	B	T6	-40	51	51	51	85	45	85	-40	-40	-40	-	-
		T5	-40	66	66	66	100	60	100	-40	-40	-40	-	-
		T4	-40	75	75	75	135	64	135	-40	-40	-40	-	-
		T3 ¹⁾	-40	75	75	75	150	62	150	-40	-40	-40	-	-
	C	T6	-40	60	60	60	85	55	85	-40	-40	-40	-	-
		T5	-40	75	75	75	100	70	100	-40	-40	-40	-	-
		T4	-40	78	78	78	135	68	135	-40	-40	-40	-	-
		T3 ¹⁾	-40	78	78	78	150	65	150	-40	-40	-40	-	-

1) Functional: Maximum permissible process temperature

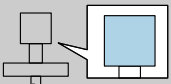
 = C	(2)	P1		P2		P3		P4		P5		P6		
		T _p	T _a	T _p	T _a	T _p	T _a	T _p	T _a	T _p	T _a	T _p	T _a	
	B	T6	-40	51	51	51	85	46	85	-40	-40	-40	-	-
		T5	-40	66	66	66	100	61	100	-40	-40	-40	-	-
		T4	-40	75	75	75	135	66	135	-40	-40	-40	-	-
		T3 ¹⁾	-40	75	75	75	150	64	150	-40	-40	-40	-	-
	C	T6	-40	60	60	60	85	56	85	-40	-40	-40	-	-
		T5	-40	75	75	75	100	71	100	-40	-40	-40	-	-
		T4	-40	78	78	78	135	70	135	-40	-40	-40	-	-
		T3 ¹⁾	-40	78	78	78	150	68	150	-40	-40	-40	-	-

1) Functional: Maximum permissible process temperature

 Explosion protection: XP / AEx db [ia]/Ex db [ia]

Antenna: Class I, Zone 0 / Class I, Division 1;
 Electronics housing: Class I, Zone 1 / Class I, Division 1

FMR56

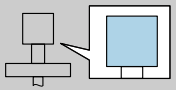
 = C	(2)	P1		P2		P3		P4		P5		P6		
		T _p	T _a	T _p	T _a	T _p	T _a	T _p	T _a	T _p	T _a	T _p	T _a	
	B, C	T6	-40	60	60	60	80	58	80	-40	-40	-40	-	-

 Explosion protection: Division 2

Antenna: Class I, Zone 0 / Class I, Division 1;
 Electronics housing: Class I, Division 2

FMR56

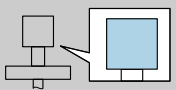
 = C	(2)	P1		P2		P3		P4		P5		P6		
		T _p	T _a	T _p	T _a	T _p	T _a	T _p	T _a	T _p	T _a	T _p	T _a	
	B	T6	-40	51	51	51	80	49	80	-40	-40	-40	-	-
	C	T6	-40	60	60	60	80	58	80	-40	-40	-40	-	-

 Explosion protection: XP / AEx db [ia]/Ex db [ia]

Antenna: Class I, Zone 0 / Class I, Division 1;
 Electronics housing: Class I, Zone 1 / Class I, Division 1

FMR57

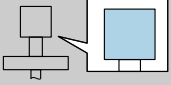
 = B	(2)	P1		P2		P3		P4		P5		P6		
		T _p	T _a	T _p	T _a	T _p	T _a	T _p	T _a	T _p	T _a	T _p	T _a	
	B	T6	-40	60	60	60	85	56	85	-40	-40	-40	-	-
		T5	-40	75	75	75	100	71	100	-40	-40	-40	-	-
		T4	-40	75	75	75	135	68	135	-40	-40	-40	-	-
		T3	-40	75	75	75	200	60	200	-40	-40	-40	-	-
	C	T6	-40	60	60	60	85	56	85	-40	-40	-40	-	-
		T5	-40	75	75	75	100	71	100	-40	-40	-40	-	-
		T4	-40	78	78	78	135	71	135	-40	-40	-40	-	-
		T3	-40	78	78	78	200	63	200	-40	-40	-40	-	-

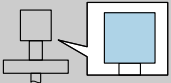
 = C	(2)	P1		P2		P3		P4		P5		P6		
		T _p	T _a	T _p	T _a	T _p	T _a	T _p	T _a	T _p	T _a	T _p	T _a	
	B	T6	-40	60	60	60	85	57	85	-40	-40	-40	-	-
		T5	-40	75	75	75	100	72	100	-40	-40	-40	-	-
		T4	-40	75	75	75	135	69	135	-40	-40	-40	-	-
		T3	-40	75	75	75	200	63	200	-40	-40	-40	-	-
	C	T6	-40	60	60	60	85	57	85	-40	-40	-40	-	-
		T5	-40	75	75	75	100	72	100	-40	-40	-40	-	-
		T4	-40	78	78	78	135	73	135	-40	-40	-40	-	-
		T3	-40	78	78	78	200	66	200	-40	-40	-40	-	-

FMR57

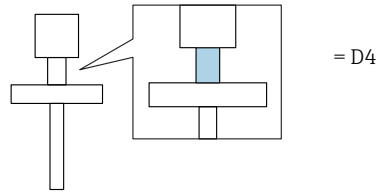

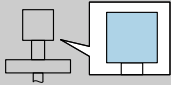
 = B	(2)	P1		P2		P3		P4		P5		P6		
		T _p	T _a	T _p	T _a	T _p	T _a	T _p	T _a	T _p	T _a	T _p	T _a	
	B	T6	-40	60	60	60	85	57	85	-40	-40	-40	-	-
		T5	-40	75	75	75	100	72	100	-40	-40	-40	-	-
		T4	-40	75	75	75	135	70	135	-40	-40	-40	-	-
		T3	-40	75	75	75	200	64	200	-40	-40	-40	-	-
		T2	-40	75	75	75	300	54	300	-40	-40	-40	-	-
		T1 ¹⁾	-40	75	75	75	400	45	400	-40	-40	-40	-	-
	C	T6	-40	60	60	60	85	57	85	-40	-40	-40	-	-
		T5	-40	75	75	75	100	72	100	-40	-40	-40	-	-
		T4	-40	78	78	78	135	73	135	-40	-40	-40	-	-
		T3	-40	78	78	78	200	67	200	-40	-40	-40	-	-
		T2	-40	78	78	78	300	58	300	-40	-40	-40	-	-
		T1 ¹⁾	-40	78	78	78	400	49	400	-40	-40	-40	-	-

1) Functional: Maximum permissible process temperature

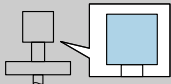
 = C	(2)	P1		P2		P3		P4		P5		P6		
		T _p	T _a	T _p	T _a	T _p	T _a	T _p	T _a	T _p	T _a	T _p	T _a	
	B	T6	-40	60	60	60	85	58	85	-40	-40	-40	-	-
		T5	-40	75	75	75	100	73	100	-40	-40	-40	-	-
		T4	-40	75	75	75	135	71	135	-40	-40	-40	-	-
		T3	-40	75	75	75	200	66	200	-40	-40	-40	-	-
		T2	-40	75	75	75	300	59	300	-40	-40	-40	-	-
		T1 ¹⁾	-40	75	75	75	400	52	400	-40	-40	-40	-	-
	C	T6	-40	60	60	60	85	58	85	-40	-40	-40	-	-
		T5	-40	75	75	75	100	73	100	-40	-40	-40	-	-
		T4	-40	78	78	78	135	74	135	-40	-40	-40	-	-
		T3	-40	78	78	78	200	69	200	-40	-40	-40	-	-
		T2	-40	78	78	78	300	62	300	-40	-40	-40	-	-
		T1 ¹⁾	-40	78	78	78	400	55	400	-40	-40	-40	-	-

1) Functional: Maximum permissible process temperature

 Explosion protection: Division 2

Antenna: Class I, Zone 0 / Class I, Division 1;
 Electronics housing: Class I, Division 2

FMR57

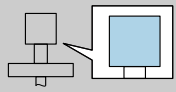
 = B	(2)	P1		P2		P3		P4		P5		P6		
		T _p	T _a	T _p	T _a	T _p	T _a	T _p	T _a	T _p	T _a	T _p	T _a	
	B	T6	-40	51	51	51	85	47	85	-40	-40	-40	-	-
		T5	-40	66	66	66	100	62	100	-40	-40	-40	-	-
		T4	-40	75	75	75	135	68	135	-40	-40	-40	-	-
		T3	-40	75	75	75	200	60	200	-40	-40	-40	-	-
	C	T6	-40	60	60	60	85	56	85	-40	-40	-40	-	-
		T5	-40	75	75	75	100	71	100	-40	-40	-40	-	-
		T4	-40	78	78	78	135	71	135	-40	-40	-40	-	-
		T3	-40	78	78	78	200	63	200	-40	-40	-40	-	-

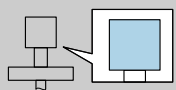
 = C	(2)	P1		P2		P3		P4		P5		P6		
		T _p	T _a	T _p	T _a	T _p	T _a	T _p	T _a	T _p	T _a	T _p	T _a	
	B	T6	-40	51	51	51	85	48	85	-40	-40	-40	-	-
		T5	-40	66	66	66	100	63	100	-40	-40	-40	-	-
		T4	-40	75	75	75	135	69	135	-40	-40	-40	-	-
		T3	-40	75	75	75	200	63	200	-40	-40	-40	-	-
	C	T6	-40	60	60	60	85	57	85	-40	-40	-40	-	-
		T5	-40	75	75	75	100	72	100	-40	-40	-40	-	-
		T4	-40	78	78	78	135	73	135	-40	-40	-40	-	-
		T3	-40	78	78	78	200	66	200	-40	-40	-40	-	-

FMR57

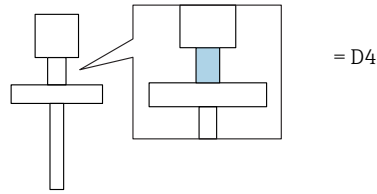

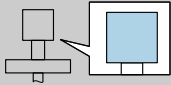
 = B	(2)	P1		P2		P3		P4		P5		P6		
		T _p	T _a	T _p	T _a	T _p	T _a	T _p	T _a	T _p	T _a	T _p	T _a	
	B	T6	-40	51	51	51	85	48	85	-40	-40	-40	-	-
		T5	-40	66	66	66	100	63	100	-40	-40	-40	-	-
		T4	-40	75	75	75	135	70	135	-40	-40	-40	-	-
		T3	-40	75	75	75	200	64	200	-40	-40	-40	-	-
		T2	-40	75	75	75	300	54	300	-40	-40	-40	-	-
		T1 ¹⁾	-40	75	75	75	400	45	400	-40	-40	-40	-	-
	C	T6	-40	60	60	60	85	57	85	-40	-40	-40	-	-
		T5	-40	75	75	75	100	72	100	-40	-40	-40	-	-
		T4	-40	78	78	78	135	73	135	-40	-40	-40	-	-
		T3	-40	78	78	78	200	67	200	-40	-40	-40	-	-
		T2	-40	78	78	78	300	58	300	-40	-40	-40	-	-
		T1 ¹⁾	-40	78	78	78	400	49	400	-40	-40	-40	-	-

1) Functional: Maximum permissible process temperature

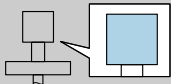
 = C	(2)	P1		P2		P3		P4		P5		P6		
		T _p	T _a	T _p	T _a	T _p	T _a	T _p	T _a	T _p	T _a	T _p	T _a	
	B	T6	-40	51	51	51	85	49	85	-40	-40	-40	-	-
		T5	-40	66	66	66	100	64	100	-40	-40	-40	-	-
		T4	-40	75	75	75	135	71	135	-40	-40	-40	-	-
		T3	-40	75	75	75	200	66	200	-40	-40	-40	-	-
		T2	-40	75	75	75	300	59	300	-40	-40	-40	-	-
		T1 ¹⁾	-40	75	75	75	400	52	400	-40	-40	-40	-	-
	C	T6	-40	60	60	60	85	58	85	-40	-40	-40	-	-
		T5	-40	75	75	75	100	73	100	-40	-40	-40	-	-
		T4	-40	78	78	78	135	74	135	-40	-40	-40	-	-
		T3	-40	78	78	78	200	69	200	-40	-40	-40	-	-
		T2	-40	78	78	78	300	62	300	-40	-40	-40	-	-
		T1 ¹⁾	-40	78	78	78	400	55	400	-40	-40	-40	-	-

1) Functional: Maximum permissible process temperature

**Class II, III, Division 1;
1 channel**

Position 3 (Power Supply, Output) = A, B, C, K, L: 1 channel used

FMR5x

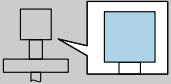
 = B, C	(1)	
	A, B, C	$T = T_a + 5 \text{ K}$
	K	$T = T_a + 9 \text{ K}$
	L	$T = T_a + 8 \text{ K}$

**Class II, III, Division 1;
2 channels**

Position 3 (Power Supply, Output) = B, C: 2 channels used

FMR5x

 = B, C	(2)	
	B, C	$T = T_a + 10 \text{ K}$

Micropilot FMR50/51/52/53/54/56/57

4-20 mA HART

Table of contents

Attachment: Nameplate view 74

Attachment: Nameplate view

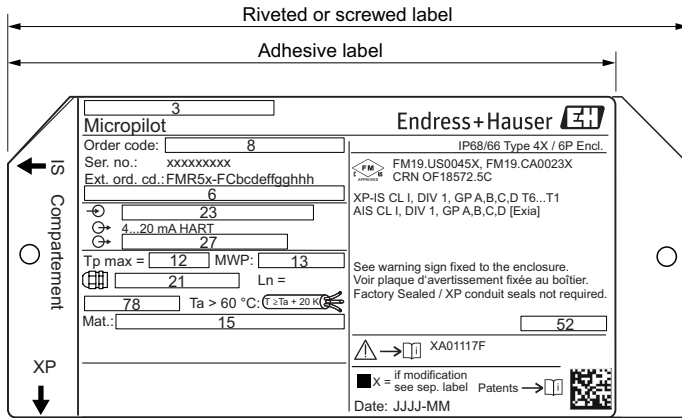

WARNINGS: Potential electrostatic charging hazard - see instructions. Substitution of components may impair suitability for hazardous locations.

AVERTISSEMENTS: Risque potentiel de décharges électrostatiques - voir consignes. La substitution de composants peut compromettre l'adaptabilité aux emplacements dangereux.

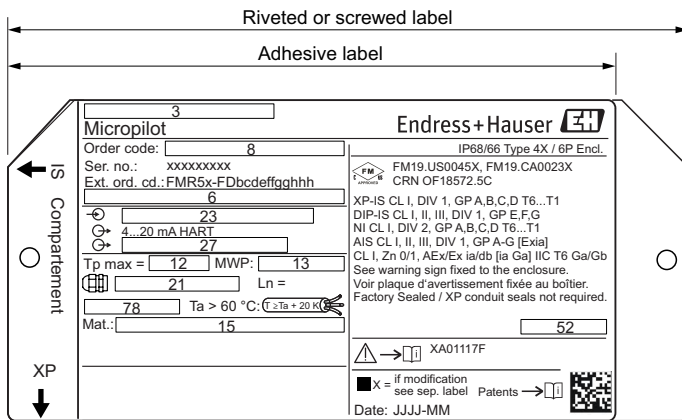

WARNINGS: Potential electrostatic charging hazard - see instructions. Substitution of components may impair suitability for hazardous locations. For Div. 2, do not disconnect equipment unless power has been switched off or area is known to be non-hazardous.

AVERTISSEMENTS: Risque potentiel de décharges électrostatiques - voir consignes. La substitution de composants peut compromettre l'adaptabilité aux emplacements dangereux. Pour Div. 2, débrancher appareil uniquement après avoir coupé l'alimentation électrique ou avoir vérifié qu'il ne soit pas installé en zone dangereuse.

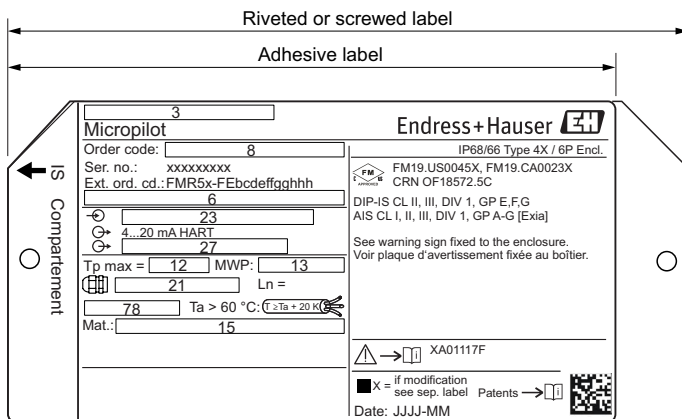

WARNINGS: Potential electrostatic charging hazard - see instructions. Keep covers tight when explosive dust atmosphere is present.

AVERTISSEMENTS: Risque potentiel de décharges électrostatiques - voir consignes. Garder les couvercles bien fermés en présence d'une atmosphère poussiéreuse explosive.

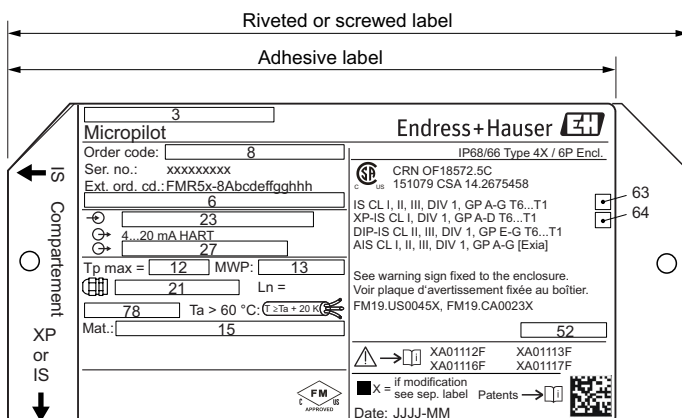

WARNINGS: Potential electrostatic charging hazard - see instructions. Substitution of components may impair suitability for hazardous locations.

AVERTISSEMENTS: Risque potentiel de décharges électrostatiques - voir consignes. La substitution de composants peut compromettre l'adaptabilité aux emplacements dangereux.

Factory Sealed / XP conduit seals not required.

Field no.	Order code FMR5x-aabcdeffgghh +options	Contents	Comment	
3	-	Made in Germany, 79689 Maulburg	Depending on production plant	
		Assembled in USA		
		Assembled in India		
6	-	+*****#	+options added to Order Code (multiple options may be added; options relevant to approval are included below)	
8	-	Ident.-No.	Individual no. for identically configured devices	
12	-	Actual process temperature	Depends on options ff, gg and hhh	
13	-	Permissible pressure (process): bar or psi	Depends on antenna type FMR5x and process connection (options hhh)	
15	-	Process wetted materials	Depends on options ff, gg and hhh	
21	e = A,B,I,M	M20x1,5 / M16x1,5	Cable Entry	
	e = D	NPT ½ / M16x1,5		
23	aa = FC,FD,FE	b = A,B	13 to 35 V _{DC} / 2-wire ¹⁾	Electrical Ratings depending on IO boards
		b = C	13 to 28 V _{DC} / 2-wire ¹⁾	
	aa = 8A	b = A,B	13 to 30 V _{DC} / 2-wire ¹⁾	
		b = C	13 to 28 V _{DC} / 2-wire ¹⁾	
	b = K	90 to 250 V _{AC} (50 to 60 Hz) 6 VA		
b = L	10.4 to 48 V _{DC}			
27	b = B	Switch output	2nd channel output	
	b = C	4 to 20 mA		
52	FMR50 FMR51 FMR52 FMR56 FMR57	Dual Seal	Dual Seal rating (MWP ...) required only when permissible pressure (Field 13) > 12 bar (174 psi).	
	FMR53 FMP54	Dual Seal (MWP: 12 bar (174 psi))	Use same units as Field 13.	
63, 64	-	(checkbox)	First installation checkbox	
78	-	T _a : -40 to +80 °C	Ambient temperature range	
	+options = JN	T _a : -50 to +80 °C		

1) In connection with Optional specification, ID Nx (Accessory Mounted) = NF: Add 3 V to low end



71449334

www.addresses.endress.com
