

Technical Information

Proline Promass E 100

Coriolis flowmeter



The flowmeter with minimum total cost of ownership and an ultra-compact transmitter

Application

- Measuring principle operates independently of physical fluid properties such as viscosity or density
- Accurate measurement of liquids and gases for a wide range of standard applications

Device properties

- Compact dual-tube sensor
- Medium temperature up to +150 °C (+302 °F)
- Process pressure up to 100 bar (1450 psi)
- Robust, ultra-compact transmitter housing
- Highest degree of protection: IP69
- Local display available

Your benefits

- Cost-effective – multipurpose device; an alternative to conventional volumetric flowmeters
- Fewer process measuring points – multivariable measurement (flow, density, temperature)
- Space-saving installation – no in-/outlet run needs
- Space-saving transmitter – full functionality on smallest footprint
- Time-saving local operation without additional software and hardware – integrated web server
- Integrated verification – Heartbeat Technology

Table of contents





About this document	4	Degree of protection	45
Symbols	4	Vibration resistance and shock resistance	46
Function and system design	5	Electromagnetic compatibility (EMC)	46
Measuring principle	5	Process	46
Measuring system	5	Medium temperature range	46
Equipment architecture	7	Medium density	47
Reliability	7	Pressure/temperature ratings	47
Input	8	Sensor housing	51
Measured variable	8	Rupture disk	52
Measuring range	8	Internal cleaning	52
Operable flow range	9	Flow limit	52
Input signal	9	Pressure loss	52
Output	9	Static pressure	52
Output signal	9	Thermal insulation	52
Signal on alarm	11	Heating	53
Ex connection data	13	Vibrations	53
Low flow cut off	14	Mechanical construction	54
Protocol-specific data	14	Dimensions in SI units	54
Power supply	24	Dimensions in US units	67
Terminal assignment	24	Weight	75
Pin assignment, device plug	31	Materials	75
Supply voltage	34	Process connections	77
Power consumption	34	Surface roughness	77
Current consumption	34	Operability	78
Device fuse	35	Operating concept	78
Power supply failure	35	Local display	78
Electrical connection	35	Remote operation	78
Potential equalization	37	Service interface	81
Terminals	37	Certificates and approvals	83
Cable entries	37	CE mark	83
Cable specification	37	UKCA marking	83
Performance characteristics	38	RCM marking	83
Reference operating conditions	38	Ex approval	83
Maximum measurement error	38	Hygienic compatibility	84
Repeatability	40	Pharmaceutical compatibility	84
Response time	40	HART certification	84
Influence of ambient temperature	40	Certification PROFIBUS	84
Influence of medium temperature	40	Certification PROFINET	84
Influence of medium pressure	41	EtherNet/IP certification	85
Design fundamentals	41	Modbus RS485 certification	85
Installation	42	Pressure Equipment Directive	85
Mounting location	42	Additional certification	85
Orientation	43	External standards and guidelines	85
Inlet and outlet runs	44	Ordering information	86
Special installation instructions	44	Product generation index	86
Installing the Safety Barrier Promass 100	45	Application packages	86
Environment	45	Heartbeat Technology	86
Ambient temperature range	45	Concentration measurement	87
Storage temperature	45	Petroleum & locking function	87
Climate class	45		

Accessories	87
Device-specific accessories	88
Communication-specific accessories	88
Service-specific accessories	89
System components	89
Documentation	90
Standard documentation	90
Supplementary device-dependent documentation	90
Registered trademarks	91









About this document

Symbols



Electrical symbols

Symbol	Meaning
	Direct current
	Alternating current
	Direct current and alternating current
	Ground connection A grounded terminal which, as far as the operator is concerned, is grounded via a grounding system.
	Protective earth (PE) Ground terminals that must be connected to ground prior to establishing any other connections. The ground terminals are located on the interior and exterior of the device: <ul style="list-style-type: none"> ▪ Interior ground terminal: protective earth is connected to the mains supply. ▪ Exterior ground terminal: device is connected to the plant grounding system.

Symbols for certain types of information

Symbol	Meaning
	Permitted Procedures, processes or actions that are permitted.
	Preferred Procedures, processes or actions that are preferred.
	Forbidden Procedures, processes or actions that are forbidden.
	Tip Indicates additional information.
	Reference to documentation
	Reference to page
	Reference to graphic
	Visual inspection

Symbols in graphics

Symbol	Meaning
1, 2, 3, ...	Item numbers
1 , 2 , 3 , ...	Series of steps
A, B, C, ...	Views
A-A, B-B, C-C, ...	Sections
	Hazardous area
	Safe area (non-hazardous area)
	Flow direction

Function and system design

Measuring principle

The measuring principle is based on the controlled generation of Coriolis forces. These forces are always present in a system when both translational and rotational movements are superimposed.

$$F_c = 2 \cdot \Delta m (v \cdot \omega)$$

F_c = Coriolis force

Δm = moving mass

ω = rotational velocity

v = radial velocity in rotating or oscillating system

The amplitude of the Coriolis force depends on the moving mass Δm , its velocity v in the system and thus on the mass flow. Instead of a constant rotational velocity ω , the sensor uses oscillation.

In the sensor, two parallel measuring tubes containing flowing medium oscillate in antiphase, acting like a vibrating fork. The Coriolis forces produced at the measuring tubes cause a phase shift in the tube oscillations (see illustration):

- At zero flow (when the medium is at a standstill) the two tubes oscillate in phase (1).
- Mass flow causes deceleration of the oscillation at the inlet of the tubes (2) and acceleration at the outlet (3).

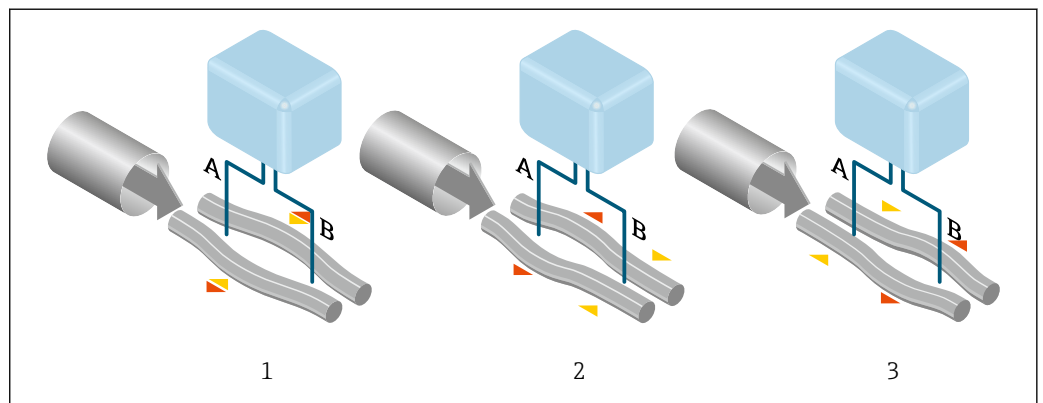

A0028850

The phase shift (A-B) increases with increasing mass flow. Electrodynamic sensors register the tube oscillations at the inlet and outlet. System balance is ensured by the antiphase oscillation of the two measuring tubes. The measuring principle operates independently of temperature, pressure, viscosity, conductivity and flow profile.

Density measurement

The measuring tube is continuously excited at its resonance frequency. A change in the mass and thus the density of the oscillating system (comprising measuring tube and medium) results in a corresponding, automatic adjustment in the oscillation frequency. The resonance frequency is thus a function of the medium density. The microprocessor utilizes this relationship to obtain a density signal.

Volume measurement

Together with the measured mass flow, this is used to calculate the volume flow.

Temperature measurement

The temperature of the measuring tube is determined in order to calculate the compensation factor due to temperature effects. This signal corresponds to the process temperature and is also available as an output signal.

Measuring system

The device consists of a transmitter and a sensor. If a device with Modbus RS485 intrinsically safe is ordered, the Safety Barrier Promass 100 is part of the scope of supply and must be implemented to operate the device.

The device is available as a compact version:

The transmitter and sensor form a mechanical unit.

Transmitter

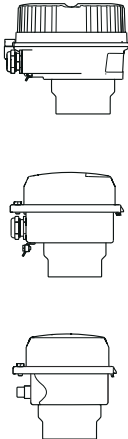
<p>Proline 100</p>  <p>A0016693</p> <p>A0016694</p> <p>A0016695</p>	<p>Device versions and materials:</p> <ul style="list-style-type: none"> ▪ Compact, aluminum, coated: Aluminum, AlSi10Mg, coated ▪ Compact, hygienic, stainless: Hygienic version, stainless steel 1.4301 (304) ▪ Ultra-compact, hygienic, stainless: Hygienic version, stainless steel 1.4301 (304) <p>Configuration:</p> <ul style="list-style-type: none"> ▪ Via operating tools (e.g. FieldCare, DeviceCare) ▪ Also for device version with local display (LCD): Via web browser ▪ Also for device version with 4-20 mA HART, pulse/frequency/switch output: Via web browser ▪ Also for device version with EtherNet/IP output: <ul style="list-style-type: none"> ▪ Via web browser ▪ Via Add-on Profile Level 3 for automation system from Rockwell Automation ▪ Via Electronic Data Sheet (EDS) ▪ Also for device version with PROFINET output: <ul style="list-style-type: none"> ▪ Via web browser ▪ Via device master file (GSD)
---	---

Sensor

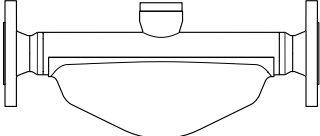
<p>Promass E</p>  <p>A0030940</p>	<ul style="list-style-type: none"> ▪ Bent dual-tube system ▪ For standard applications where stable and reliable measurements are required ▪ Simultaneous measurement of flow, volume flow, density and temperature (multivariable) ▪ Immune to process influences ▪ Nominal diameter range: DN 8 to 80 ($\frac{3}{8}$ to 3") ▪ Materials: <ul style="list-style-type: none"> ▪ Sensor: stainless steel, 1.4301 (304) ▪ Measuring tubes: stainless steel, 1.4539 (904L) ▪ Process connections: stainless steel, 1.4404 (316/316L)
---	--

Safety Barrier Promass 100

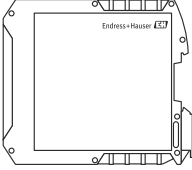
 <p>A0016763</p>	<ul style="list-style-type: none"> ▪ Dual-channel safety barrier for installation in non-hazardous locations or zone 2/div. 2: <ul style="list-style-type: none"> ▪ Channel 1: DC 24 V power supply ▪ Channel 2: Modbus RS485 ▪ In addition to current, voltage and power limitation, it offers galvanic isolation of circuits for explosion protection. ▪ Easy top-hat rail mounting (DIN 35 mm) for installation in control cabinets
---	--

Equipment architecture

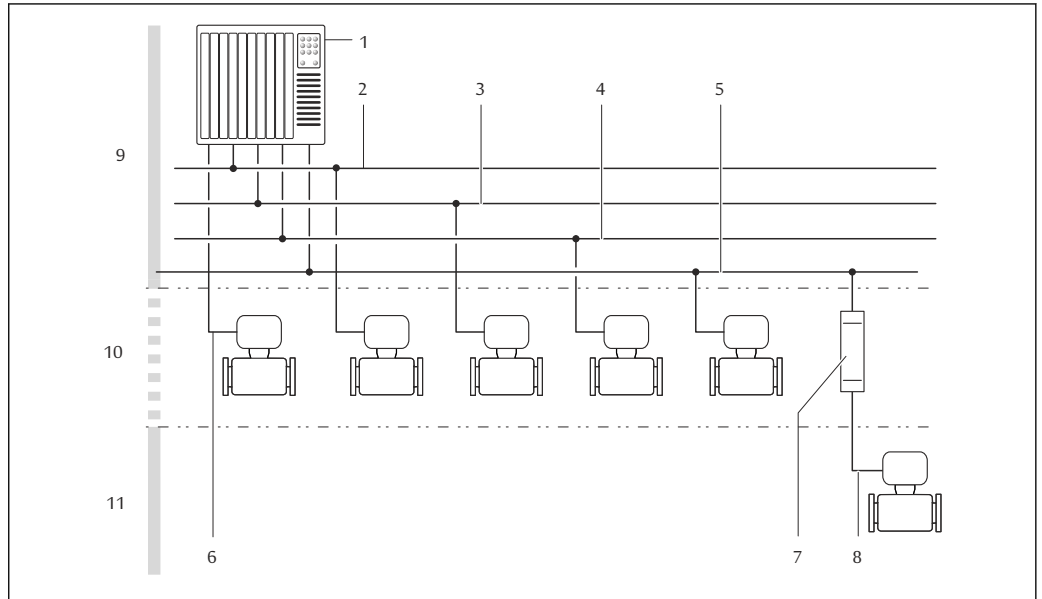

A0016779

1 Possibilities for integrating measuring instruments into a system

- 1 Automation system (e.g. PLC)
- 2 EtherNet/IP
- 3 PROFIBUS DP
- 4 PROFINET
- 5 Modbus RS485
- 6 4-20 mA HART, pulse/frequency/switch output
- 7 Safety Barrier Promass 100
- 8 Modbus RS485, intrinsically safe
- 9 Non-hazardous area
- 10 Non-hazardous area and Zone 2/Div. 2
- 11 Hazardous area and Zone 1/Div. 1

Reliability

IT security

The manufacturer warranty is valid only if the product is installed and used as described in the Operating Instructions. The product is equipped with security mechanisms to protect it against any inadvertent changes to the settings.

IT security measures, which provide additional protection for the product and associated data transfer, must be implemented by the operators themselves in line with their security standards.

Input

Measured variable

Direct measured variables

- Mass flow
- Density
- Temperature

Calculated measured variables

- Volume flow
- Corrected volume flow
- Reference density

Measuring range

Measuring range for liquids

DN		Measuring range full scale values $\dot{m}_{\min(F)}$ to $\dot{m}_{\max(F)}$	
[mm]	[in]	[kg/h]	[lb/min]
8	$\frac{3}{8}$	0 to 2 000	0 to 73.50
15	$\frac{1}{2}$	0 to 6 500	0 to 238.9
25	1	0 to 18 000	0 to 661.5
40	$1\frac{1}{2}$	0 to 45 000	0 to 1 654
50	2	0 to 70 000	0 to 2 573
80	3	0 to 180 000	0 to 6 615

Measuring range for gases



The full scale value depends on the density and the speed of sound of the gas used. The full scale value can be calculated with the following formulas:

$$\dot{m}_{\max(G)} = \text{minimum of } (\dot{m}_{\max(F)} \cdot \rho_G \cdot x) \text{ and } (\rho_G \cdot (c_G/2) \cdot d_i^2 \cdot (\pi/4) \cdot 3600 \cdot n)$$

$\dot{m}_{\max(G)}$	Maximum full scale value for gas [kg/h]
$\dot{m}_{\max(F)}$	Maximum full scale value for liquid [kg/h]
$\dot{m}_{\max(G)} < \dot{m}_{\max(F)}$	$\dot{m}_{\max(G)}$ can never be greater than $\dot{m}_{\max(F)}$
ρ_G	Gas density in [kg/m ³] at operating conditions
x	Limitation constant for max. gas flow [kg/m ³]
c_G	Speed of sound (gas) [m/s]
d_i	Measuring tube internal diameter [m]
π	Pi
$n = 2$	Number of measuring tubes

DN		x [kg/m ³]
[mm]	[in]	
8	$\frac{3}{8}$	85
15	$\frac{1}{2}$	110
25	1	125
40	$1\frac{1}{2}$	125



DN		x
[mm]	[in]	[kg/m ³]
50	2	125
80	3	155

 To calculate the measuring range, use the *Applicator* sizing tool →  89

If calculating the full scale value using the two formulas:

1. Calculate the full scale value with both formulas.
2. The smaller value is the value that must be used.

Recommended measuring range

 Flow limit →  52

Operable flow range

Over 1000 : 1.



Flow rates above the preset full scale value do not override the electronics unit, with the result that the totalizer values are registered correctly.

Input signal

External measured values

To increase the measurement accuracy of certain measured variables or to calculate the corrected volume flow for gases, the automation system can continuously write different measured values to the measuring instrument:

- Operating pressure to increase measurement accuracy (Endress+Hauser recommends the use of a pressure measuring instrument for absolute pressure, e.g. Cerabar M or Cerabar S)
- Medium temperature to increase measurement accuracy (e.g. iTEMP)
- Reference density for calculating the corrected volume flow for gases

 Various pressure transmitters and temperature measuring instruments can be ordered from Endress+Hauser: see "Accessories" section →  89

It is recommended to read in external measured values to calculate the following measured variables:

- Mass flow
- Corrected volume flow

HART protocol

The measured values are written from the automation system to the measuring device via the HART protocol. The pressure transmitter must support the following protocol-specific functions:

- HART protocol
- Burst mode

Digital communication

The measured values can be written by the automation system via:

- PROFIBUS DP
- Modbus RS485
- EtherNet/IP
- PROFINET

Output

Output signal

HART current output

Current output	4-20 mA HART (active)
Maximum output values	<ul style="list-style-type: none"> ▪ DC 24 V (no flow) ▪ 22.5 mA

Load	0 to 700 Ω
Resolution	0.38 μ A
Damping	Configurable: 0.07 to 999 s
Assignable measured variables	<ul style="list-style-type: none"> ▪ Mass flow ▪ Volume flow ▪ Corrected volume flow ▪ Density ▪ Reference density ▪ Temperature <p> The range of options increases if the measuring device has one or more application packages.</p>

Pulse/frequency/switch output

Function	Can be set to pulse, frequency or switch output
Version	Passive, open collector
Maximum input values	<ul style="list-style-type: none"> ▪ DC 30 V ▪ 25 mA
Voltage drop	For 25 mA: \leq DC 2 V
Pulse output	
Pulse width	Configurable: 0.05 to 2 000 ms
Maximum pulse rate	10 000 Impulse/s
Pulse value	Adjustable
Assignable measured variables	<ul style="list-style-type: none"> ▪ Mass flow ▪ Volume flow ▪ Corrected volume flow
Frequency output	
Output frequency	Configurable: 0 to 10 000 Hz
Damping	Configurable: 0 to 999 s
Pulse/pause ratio	1:1
Assignable measured variables	<ul style="list-style-type: none"> ▪ Mass flow ▪ Volume flow ▪ Corrected volume flow ▪ Density ▪ Reference density ▪ Temperature <p> The range of options increases if the measuring device has one or more application packages.</p>
Switch output	
Switching behavior	Binary, conductive or non-conductive
Switching delay	Configurable: 0 to 100 s

Number of switching cycles	Unlimited
Assignable functions	<ul style="list-style-type: none"> ▪ Off ▪ On ▪ Diagnostic behavior ▪ Limit value <ul style="list-style-type: none"> ▪ Mass flow ▪ Volume flow ▪ Corrected volume flow ▪ Density ▪ Reference density ▪ Temperature ▪ Totalizer 1-3 ▪ Flow direction monitoring ▪ Status <ul style="list-style-type: none"> ▪ Partially filled pipe detection ▪ Low flow cut off <p> The range of options increases if the measuring device has one or more application packages.</p>

PROFIBUS DP

Signal encoding	NRZ code
Data transfer	9.6 kBaud...12 MBaud
Terminating resistor	Integrated, can be activated via DIP switches

Modbus RS485

Physical interface	In accordance with EIA/TIA-485-A standard
Terminating resistor	<ul style="list-style-type: none"> ▪ For device version used in non-hazardous areas or Zone 2/Div. 2: integrated and can be activated via DIP switches on the transmitter electronics module ▪ For device version used in intrinsically safe areas: integrated and can be activated via DIP switches on the Safety Barrier Promass 100

EtherNet/IP

Standards	In accordance with IEEE 802.3
------------------	-------------------------------

PROFINET

Standards	In accordance with IEEE 802.3
------------------	-------------------------------

Signal on alarm

Depending on the interface, failure information is displayed as follows:

Current output

Current output 4-20 mA	
Failure mode	<p>Configurable:</p> <ul style="list-style-type: none"> ▪ 4 to 20 mA in accordance with NAMUR recommendation NE 43 ▪ 4 to 20 mA in accordance with US ▪ Min. value: 3.59 mA ▪ Max. value: 22.5 mA ▪ Definable value between: 3.59 to 22.5 mA ▪ Actual value ▪ Last valid value

Pulse/frequency/switch output

Pulse output	
Failure mode	Configurable: <ul style="list-style-type: none"> ▪ Actual value ▪ No pulses
Frequency output	
Failure mode	Configurable: <ul style="list-style-type: none"> ▪ Actual value ▪ 0 Hz ▪ Definable value between: 0 to 12 500 Hz
Switch output	
Failure mode	Configurable: <ul style="list-style-type: none"> ▪ Current status ▪ Open ▪ Closed

PROFIBUS DP

Status and alarm messages	Diagnostics in accordance with PROFIBUS PA Profile 3.02
---------------------------	---

Modbus RS485

Failure mode	Choose from: <ul style="list-style-type: none"> ▪ NaN value instead of current value ▪ Last valid value
--------------	---

EtherNet/IP

Device diagnostics	Device condition can be read out in Input Assembly
--------------------	--

PROFINET

Device diagnostics	According to "Application Layer protocol for decentralized periphery", Version 2.3
--------------------	--

Local display



Plain text display	With information on cause and remedial measures
Backlight	Red backlighting indicates a device error.



Status signal as per NAMUR recommendation NE 107

Interface/protocol

- Via digital communication:
 - HART protocol
 - PROFIBUS DP
 - Modbus RS485
 - EtherNet/IP
 - PROFINET
- Via service interface
Service interface CDI-RJ45
- Plain text display
With information on cause and remedial actions

 Additional information on remote operation →  78

Web browser

Plain text display	With information on cause and remedial measures
---------------------------	---

LEDs

Status information	Status indicated by various LEDs The following information is displayed depending on the device version: <ul style="list-style-type: none"> ▪ Supply voltage active ▪ Data transmission active ▪ Device alarm/error has occurred ▪ Network available ¹⁾ ▪ Connection established ¹⁾ ▪ PROFINET blinking feature ²⁾
---------------------------	--

- 1) Only available for PROFINET, Ethernet/IP
 2) Only available for PROFINET,

Ex connection data

These values only apply for the following device version:
 Order code for "Output", option M "Modbus RS485", for use in intrinsically safe areas

Safety Barrier Promass 100

Safety-related values

Terminal numbers			
Supply voltage		Signal transmission	
2 (L-)	1 (L+)	26 (B)	27 (A)
$U_{nom} = DC\ 24\ V$ $U_{max} = AC\ 260\ V$		$U_{nom} = DC\ 5\ V$ $U_{max} = AC\ 260\ V$	

Intrinsically safe values

Terminal numbers			
Supply voltage		Signal transmission	
20 (L-)	10 (L+)	62 (B)	72 (A)
$U_o = 16.24\ V$ $I_o = 623\ mA$ $P_o = 2.45\ W$ For IIC ¹⁾ : $L_o = 92.8\ \mu H, C_o = 0.433\ \mu F, L_o/R_o = 14.6\ \mu H/\Omega$ For IIC: $L_o = 92.8\ \mu H, C_o = 0.433\ \mu F, L_o/R_o = 14.6\ \mu H/\Omega$ For IIB ¹⁾ : $L_o = 372\ \mu H, C_o = 2.57\ \mu F, L_o/R_o = 58.3\ \mu H/\Omega$			
 For an overview and for information on the interdependencies between the gas group - sensor - nominal diameter, see the "Safety Instructions" (XA) document for the measuring device			

- 1) The gas group depends on the sensor and nominal diameter

Transmitter*Intrinsically safe values*

Order code for "Approval"	Terminal numbers			
	Supply voltage		Signal transmission	
	20 (L-)	10 (L+)	62 (B)	72 (A)
<ul style="list-style-type: none"> ▪ Option BM: ATEX II2G + IECEx Z1 Ex ia, II2D Ex tb ▪ Option BO: ATEX II1/2G + IECEx Z0/Z1 Ex ia, II2D ▪ Option BQ: ATEX II1/2G + IECEx Z0/Z1 Ex ia ▪ Option BU: ATEX II2G + IECEx Z1 Ex ia ▪ Option C2: CSA C/US IS Cl. I, II, III Div. 1 ▪ Option 85: ATEX II2G + IECEx Z1 Ex ia + CSA C/US IS Cl. I, II, III Div. 1 	$U_i = 16.24 \text{ V}$ $I_i = 623 \text{ mA}$ $P_i = 2.45 \text{ W}$ $L_i = 0 \text{ }\mu\text{H}$ $C_i = 6 \text{ nF}$			
 For an overview and for information on the interdependencies between the gas group - sensor - nominal diameter, see the "Safety Instructions" (XA) document for the measuring device				

Low flow cut off

The switch points for low flow cut off are user-selectable.

Protocol-specific data**HART**

Manufacturer ID	0x11
Device type ID	0x4A
HART protocol revision	7
Device description files (DTM, DD)	Information and files under: www.endress.com
HART load	Min. 250 Ω

<p>Dynamic variables</p>	<p>Read out the dynamic variables: HART command 3 The measured variables can be freely assigned to the dynamic variables.</p> <p>Measured variables for PV (primary dynamic variable)</p> <ul style="list-style-type: none"> ▪ Mass flow ▪ Volume flow ▪ Corrected volume flow ▪ Density ▪ Reference density ▪ Temperature <p>Measured variables for SV, TV, QV (secondary, tertiary and quaternary dynamic variable)</p> <ul style="list-style-type: none"> ▪ Mass flow ▪ Volume flow ▪ Corrected volume flow ▪ Density ▪ Reference density ▪ Temperature ▪ Totalizer 1 ▪ Totalizer 2 ▪ Totalizer 3 <p> The range of options increases if the measuring device has one or more application packages.</p> <p>Heartbeat Technology application package Additional measured variables are available with the Heartbeat Technology application package: Oscillation amplitude 0</p>
<p>Device variables</p>	<p>Read out the device variables: HART command 9 The device variables are permanently assigned.</p> <p>A maximum of 8 device variables can be transmitted:</p> <ul style="list-style-type: none"> ▪ 0 = mass flow ▪ 1 = volume flow ▪ 2 = corrected volume flow ▪ 3 = density ▪ 4 = reference density ▪ 5 = temperature ▪ 6 = totalizer 1 ▪ 7 = totalizer 2 ▪ 8 = totalizer 3 ▪ 13 = target mass flow ▪ 14 = carrier mass flow ▪ 15 = concentration



PROFIBUS DP

<p>Manufacturer ID</p>	<p>0x11</p>
<p>Ident number</p>	<p>0x1561</p>
<p>Profile version</p>	<p>3.02</p>
<p>Device description files (GSD, DTM, DD)</p>	<p>Information and files available at:</p> <ul style="list-style-type: none"> ▪ https://www.endress.com/download On the device product page: PRODUCTS → Product Finder → Links ▪ https://www.profibus.com

Output values (from measuring instrument to automation system)	Analog input 1 to 8 <ul style="list-style-type: none"> ▪ Mass flow ▪ Volume flow ▪ Corrected volume flow ▪ Target mass flow ▪ Carrier mass flow ▪ Density ▪ Reference density ▪ Concentration ▪ Temperature ▪ Carrier pipe temperature ▪ Electronics temperature ▪ Oscillation frequency ▪ Oscillation amplitude ▪ Frequency fluctuation ▪ Oscillation damping ▪ Tube damping fluctuation ▪ Signal asymmetry ▪ Exciter current Digital input 1 to 2 <ul style="list-style-type: none"> ▪ Partially filled pipe detection ▪ Low flow cut off Totalizer 1 to 3 <ul style="list-style-type: none"> ▪ Mass flow ▪ Volume flow ▪ Corrected volume flow
Input values (from automation system to measuring instrument)	Analog output 1 to 3 (fixed assignment) <ul style="list-style-type: none"> ▪ Pressure ▪ Temperature ▪ Reference density Digital output 1 to 3 (fixed assignment) <ul style="list-style-type: none"> ▪ Digital output 1: switch positive zero return on/off ▪ Digital output 2: perform zero adjustment ▪ Digital output 3: switch switch output on/off Totalizer 1 to 3 <ul style="list-style-type: none"> ▪ Totalize ▪ Reset and hold ▪ Preset and hold ▪ Stop ▪ Operating mode configuration: <ul style="list-style-type: none"> ▪ Net flow total ▪ Forward flow total ▪ Reverse flow total
Supported functions	<ul style="list-style-type: none"> ▪ Identification & maintenance Straightforward device identification on the part of the control system and nameplate ▪ PROFIBUS upload/download Reading and writing parameters is up to ten times faster with PROFIBUS upload/download. ▪ Condensed status Straightforward and self-explanatory diagnostic information by categorizing diagnostic messages that occur
Configuration of the device address	<ul style="list-style-type: none"> ▪ DIP switches on the I/O electronics module ▪ Via operating tools (e.g. FieldCare)

Modbus RS485

Protocol	Modbus Applications Protocol Specification V1.1
Device type	Slave
Slave address range	1 to 247
Broadcast address range	0

Function codes	<ul style="list-style-type: none"> ▪ 03: Read holding register ▪ 04: Read input register ▪ 06: Write single registers ▪ 08: Diagnostics ▪ 16: Write multiple registers ▪ 23: Read/write multiple registers
Broadcast messages	<p>Supported by the following function codes:</p> <ul style="list-style-type: none"> ▪ 06: Write single registers ▪ 16: Write multiple registers ▪ 23: Read/write multiple registers
Supported baud rate	<ul style="list-style-type: none"> ▪ 1 200 BAUD ▪ 2 400 BAUD ▪ 4 800 BAUD ▪ 9 600 BAUD ▪ 19 200 BAUD ▪ 38 400 BAUD ▪ 57 600 BAUD ▪ 115 200 BAUD
Data transfer mode	<ul style="list-style-type: none"> ▪ ASCII ▪ RTU
Data access	<p>Each device parameter can be accessed via Modbus RS485.</p> <p> For Modbus register information, see "Description of device parameters" documentation →  90</p>

EtherNet/IP

Protocol	<ul style="list-style-type: none"> ▪ The CIP Networks Library Volume 1: Common Industrial Protocol ▪ The CIP Networks Library Volume 2: Ethernet/IP Adaptation of CIP
Communication type	<ul style="list-style-type: none"> ▪ 10Base-T ▪ 100Base-TX
Device profile	Generic device (product type: 0x2B)
Manufacturer ID	0x49E
Device type ID	0x104A
Baud rates	Automatic ¹⁰ / ₁₀₀ Mbit with half-duplex and full-duplex detection
Polarity	Auto-polarity for automatic correction of crossed TxD and RxD pairs
Supported CIP connections	Max. 3 connections
Explicit connections	Max. 6 connections
I/O connections	Max. 6 connections (scanner)
Configuration options for measuring instrument	<ul style="list-style-type: none"> ▪ DIP switches on the electronics module for IP addressing ▪ Manufacturer-specific software (FieldCare) ▪ Add-on Profile Level 3 for Rockwell Automation control systems ▪ Web browser ▪ Electronic Data Sheet (EDS) integrated in the measuring instrument
Configuration of the EtherNet interface	<ul style="list-style-type: none"> ▪ Speed: 10 MBit, 100 MBit, auto (factory setting) ▪ Duplex: half-duplex, full-duplex, auto (factory setting)
Configuration of the device address	<ul style="list-style-type: none"> ▪ DIP switches on the electronics module for IP addressing (last octet) ▪ DHCP ▪ Manufacturer-specific software (FieldCare) ▪ Add-on Profile Level 3 for Rockwell Automation control systems ▪ Web browser ▪ Ethernet/IP tools, e.g. RSLinx (Rockwell Automation)
Device Level Ring (DLR)	No

Fix input			
RPI	5 ms to 10 s (factory setting: 20 ms)		
Exclusive Owner Multicast		Instance	Size [byte]
	Instance configuration:	0x68	398
	O → T configuration:	0x66	64
	T → O configuration:	0x64	44
Exclusive Owner Multicast		Instance	Size [byte]
	Instance configuration:	0x69	-
	O → T configuration:	0x66	64
	T → O configuration:	0x64	44
Input only Multicast		Instance	Size [byte]
	Instance configuration:	0x68	398
	O → T configuration:	0xC7	-
	T → O configuration:	0x64	44
Input only Multicast		Instance	Size [byte]
	Instance configuration:	0x69	-
	O → T configuration:	0xC7	-
	T → O configuration:	0x64	44
Input Assembly	<ul style="list-style-type: none"> ▪ Current device diagnostics ▪ Mass flow ▪ Volume flow ▪ Corrected volume flow ▪ Density ▪ Reference density ▪ Temperature ▪ Totalizer 1 ▪ Totalizer 2 ▪ Totalizer 3 		
Configurable Input			
RPI	5 ms to 10 s (factory setting: 20 ms)		
Exclusive Owner Multicast		Instance	Size [byte]
	Instance configuration:	0x68	398
	O → T configuration:	0x66	64
	T → O configuration:	0x65	88
Exclusive Owner Multicast		Instance	Size [byte]
	Instance configuration:	0x69	-
	O → T configuration:	0x66	64
	T → O configuration:	0x65	88
Input only Multicast		Instance	Size [byte]
	Instance configuration:	0x68	398
	O → T configuration:	0xC7	-
	T → O configuration:	0x65	88
Input only Multicast		Instance	Size [byte]
	Instance configuration:	0x69	-
	O → T configuration:	0xC7	-
	T → O configuration:	0x65	88

Configurable Input Assembly	<ul style="list-style-type: none"> ■ Current device diagnostics ■ Mass flow ■ Volume flow ■ Corrected volume flow ■ Density ■ Reference density ■ Temperature ■ Totalizer 1 ■ Totalizer 2 ■ Totalizer 3 <p> The range of options increases if the measuring device has one or more application packages.</p>
Fix output	
Output Assembly	<ul style="list-style-type: none"> ■ Activation of reset totalizers 1-3 ■ Activation of pressure compensation ■ Activation of reference density compensation ■ Activation of temperature compensation ■ Reset totalizers 1-3 ■ External pressure value ■ Pressure unit ■ External reference density ■ Reference density unit ■ External temperature ■ Temperature unit
Configuration	
Configuration Assembly	<p>Only the most common configurations are listed below.</p> <ul style="list-style-type: none"> ■ Software write protection ■ Mass flow unit ■ Mass unit ■ Volume flow unit ■ Volume unit ■ Corrected volume flow unit ■ Corrected volume unit ■ Density unit ■ Reference density unit ■ Temperature unit ■ Pressure unit ■ Length ■ Totalizer 1-3: <ul style="list-style-type: none"> ■ Assignment ■ Unit ■ Mode of operation ■ Failure mode ■ Alarm delay

PROFINET

Protocol	"Application layer protocol for decentral device periphery and distributed automation", version 2.3
Conformity class	B
Communication type	100 Mbps
Device profile	Application interface identifier 0xF600 Generic device
Manufacturer ID	0x11
Device type ID	0x844A
Device description files (GSD, DTM)	Information and files available at: <ul style="list-style-type: none"> ■ https://www.endress.com/download On the device product page: PRODUCTS → Product Finder → Links ■ https://www.profibus.com
Baud rates	Automatic 100 Mbit/s with full-duplex detection

Periods	From 8 ms
Polarity	Auto-polarity for automatic correction of crossed TxD and RxD pairs
Supported connections	<ul style="list-style-type: none"> ▪ 1 x AR (Application Relation) ▪ 1 x Input CR (Communication Relation) ▪ 1 x Output CR (Communication Relation) ▪ 1 x Alarm CR (Communication Relation)
Configuration options for measuring instrument	<ul style="list-style-type: none"> ▪ DIP switches on the electronics module, for device name assignment (last part) ▪ Manufacturer-specific software (FieldCare, DeviceCare) ▪ Web browser ▪ Device master file (GSD), can be read out via the integrated web server of the measuring instrument
Configuration of the device name	<ul style="list-style-type: none"> ▪ DIP switches on the electronics module, for device name assignment (last part) ▪ DCP protocol
Output values (from measuring instrument to automation system)	<p>Analog Input module (slot 1 to 14)</p> <ul style="list-style-type: none"> ▪ Mass flow ▪ Volume flow ▪ Corrected volume flow ▪ Target mass flow ▪ Carrier mass flow ▪ Density ▪ Reference density ▪ Concentration ▪ Temperature ▪ Carrier pipe temperature ▪ Electronics temperature ▪ Oscillation frequency ▪ Oscillation amplitude ▪ Frequency fluctuation ▪ Oscillation damping ▪ Tube damping fluctuation ▪ Signal asymmetry ▪ Exciter current <p>Discrete Input module (slot 1 to 14)</p> <ul style="list-style-type: none"> ▪ Empty pipe detection ▪ Low flow cut off <p>Diagnostics Input module (slot 1 to 14)</p> <ul style="list-style-type: none"> ▪ Last diagnostics ▪ Current diagnostics <p>Totalizer 1 to 3 (slot 15 to 17)</p> <ul style="list-style-type: none"> ▪ Mass flow ▪ Volume flow ▪ Corrected volume flow <p>Heartbeat Verification module (fixed assignment) Verification status (slot 23)</p> <p> The range of options increases if the measuring device has one or more application packages.</p>

<p>Input values (from automation system to measuring instrument)</p>	<p>Analog Output module (fixed assignment)</p> <ul style="list-style-type: none"> ▪ External pressure (slot 18) ▪ External temperature (slot 19) ▪ External reference density (slot 20) <p>Discrete Output module (fixed assignment)</p> <ul style="list-style-type: none"> ▪ Activate/deactivate positive zero return (slot 21) ▪ Perform zero adjustment (slot 22) <p>Totalizer 1 to 3 (slot 15 to 17)</p> <ul style="list-style-type: none"> ▪ Totalize ▪ Reset and hold ▪ Preset and hold ▪ Stop ▪ Operating mode configuration: <ul style="list-style-type: none"> ▪ Net flow total ▪ Forward flow total ▪ Reverse flow total <p>Heartbeat Verification module (fixed assignment) Start verification (slot 23)</p> <p> The range of options increases if the measuring device has one or more application packages.</p>
<p>Supported functions</p>	<ul style="list-style-type: none"> ▪ Identification & maintenance Simple device identification via: <ul style="list-style-type: none"> ▪ Control system ▪ Nameplate ▪ Measured value status The process variables are communicated with a measured value status ▪ Blinking feature via the local display for simple device identification and assignment

Administration of software options

Input/output value	Process variable	Category	Slot
Output value	Mass flow	Process variable	1...14
	Volume flow		
	Corrected volume flow		
	Density		
	Reference density		
	Temperature		
	Electronics temperature		
	Oscillation frequency		
	Frequency fluctuation		
	Oscillation damping		
	Oscillation frequency		
	Signal asymmetry		
	Exciter current		
	Empty pipe detection		
	Low flow cut off		
Output value	Target mass flow	Concentration ¹⁾	1...14
Output value	Carrier mass flow		
Output value	Concentration		
Output value	Oscillation damping 1	Heartbeat Technology ²⁾	1...14

Input/output value	Process variable	Category	Slot
	Oscillation frequency 1		
	Oscillation amplitude 0		
	Oscillation amplitude 1		
	Frequency fluctuation 1		
	Tube damping fluctuation 1		
	Exciter current 1		
Input value	External density	Process monitoring	18
	External temperature		19
	External reference density		20
	Flow override		21
	Zero adjustment		22
	Verification status	Heartbeat Verification	23

- 1) Only available with the "Concentration" application package.
- 2) Only available with the Heartbeat Technology application package.

Startup configuration

<p>Startup configuration (NSU)</p>	<p>If startup configuration is enabled, the configuration of the most important device parameters is taken from the automation system and used.</p> <p>The following configuration is taken from the automation system:</p> <ul style="list-style-type: none"> ▪ Management <ul style="list-style-type: none"> ▪ Software revision ▪ Write protection ▪ System units <ul style="list-style-type: none"> ▪ Mass flow ▪ Mass ▪ Volume flow ▪ Volume ▪ Corrected volume flow ▪ Corrected volume ▪ Density ▪ Reference density ▪ Temperature ▪ Pressure ▪ Concentration application package <ul style="list-style-type: none"> ▪ Coefficients A0 to A4 ▪ Coefficients B1 to B3 ▪ Sensor adjustment ▪ Process parameters <ul style="list-style-type: none"> ▪ Damping (flow, density, temperature) ▪ Flow override ▪ Low flow cut off <ul style="list-style-type: none"> ▪ Assign process variable ▪ Switch-on/switch-off point ▪ Pressure shock suppression ▪ Empty pipe detection <ul style="list-style-type: none"> ▪ Assign process variable ▪ Limit values ▪ Response time ▪ Max. damping ▪ Corrected volume flow calculation <ul style="list-style-type: none"> ▪ External reference density ▪ Fixed reference density ▪ Reference temperature ▪ Linear expansion coefficient ▪ Square expansion coefficient ▪ Measuring mode <ul style="list-style-type: none"> ▪ Medium ▪ Gas type ▪ Reference sound velocity ▪ Temperature coefficient sound velocity ▪ External compensation <ul style="list-style-type: none"> ▪ Pressure compensation ▪ Pressure value ▪ External pressure ▪ Diagnostic settings ▪ Diagnostic behavior for diverse diagnostic information
------------------------------------	--

Power supply

Terminal assignment

Overview: housing version and connection versions

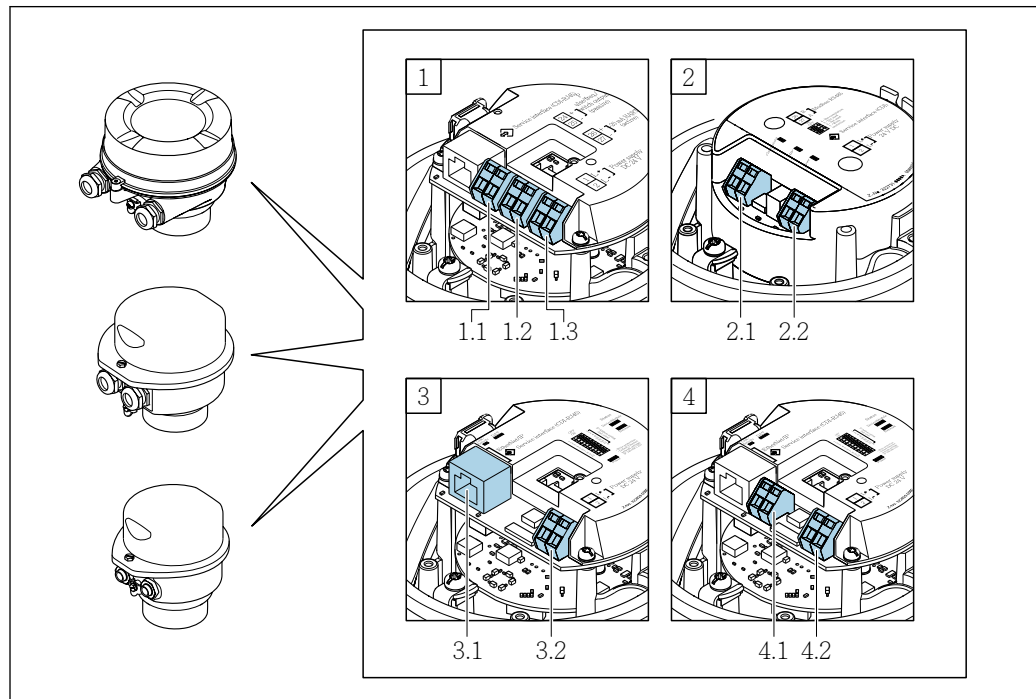

A0016770



- A Housing version: compact, aluminum coated
- B Housing version: compact, hygienic, stainless
- C Housing version: ultra-compact, hygienic, stainless
- 1 Connection version: 4-20 mA HART, pulse/frequency/switch output
- 1.1 Signal transmission: pulse/frequency/switch output
- 1.2 Signal transmission: 4-20 mA HART
- 1.3 Supply voltage
- 2 Connection version: Modbus RS485
- 2.1 Signal transmission
- 2.2 Supply voltage
- 3 Connection versions: EtherNet/IP and PROFINET
- 3.1 Signal transmission
- 3.2 Supply voltage
- 4 Connection version: PROFIBUS DP
- 4.1 Signal transmission
- 4.2 Supply voltage

Transmitter

Connection version 4-20 mA HART with pulse/frequency/switch output

Order code for "Output", option **B**

Depending on the housing version, the transmitters can be ordered with terminals or device plugs.

Order code for "Housing"	Connection methods available		Possible options for order code "Electrical connection"
	Outputs	Power supply	
Options A, B	Terminals	Terminals	<ul style="list-style-type: none"> ▪ Option A: coupling M20x1 ▪ Option B: thread M20x1 ▪ Option C: thread G ½" ▪ Option D: thread NPT ½"
Options A, B	Device plug →  32	Terminals	<ul style="list-style-type: none"> ▪ Option L: plug M12x1 + thread NPT ½" ▪ Option N: plug M12x1 + coupling M20 ▪ Option P: plug M12x1 + thread G ½" ▪ Option U: plug M12x1 + thread M20
Options A, B, C	Device plug →  32	Device plug →  32	Option Q: 2 x plug M12x1

Order code for "Housing":

- Option A: compact, coated aluminum
- Option B: compact, hygienic, stainless
- Option C: ultra-compact, hygienic, stainless

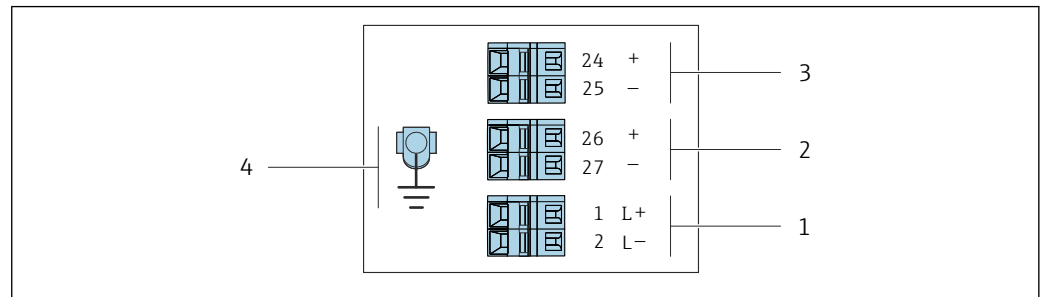

A0016888

 2 Terminal assignment 4-20 mA HART with pulse/frequency/switch output

- 1 Power supply: DC 24 V
- 2 Output 1: 4-20 mA HART (active)
- 3 Output 2: pulse/frequency/switch output (passive)
- 4 Connection for cable shield (IO signals) if present and/or protective ground from the supply voltage if present. Not for option C "Ultra-compact, hygienic, stainless".

Order code for "Output"	Terminal number					
	Power supply		Output 1		Output 2	
	2 (L-)	1 (L+)	27 (-)	26 (+)	25 (-)	24 (+)
Option B	DC 24 V		4-20 mA HART (active)		Pulse/frequency/switch output (passive)	



Order code for "Output":
Option B: 4-20 mA HART with pulse/frequency/switch output

PROFIBUS DP connection version

 For use in the non-hazardous area and Zone 2/Div. 2

Order code for "Output", option **L**

Depending on the housing version, the transmitters can be ordered with terminals or device plugs.

Order code for "Housing"	Connection methods available		Possible options for order code "Electrical connection"
	Output	Power supply	
Options A, B	Terminals	Terminals	<ul style="list-style-type: none"> ▪ Option A: coupling M20x1 ▪ Option B: thread M20x1 ▪ Option C: thread G ½" ▪ Option D: thread NPT ½"
Options A, B	Device plug →  32	Terminals	<ul style="list-style-type: none"> ▪ Option L: plug M12x1 + thread NPT ½" ▪ Option N: plug M12x1 + coupling M20 ▪ Option P: plug M12x1 + thread G ½" ▪ Option U: plug M12x1 + thread M20
Options A, B, C	Device plug →  32	Device plug →  32	Option Q : 2 x plug M12x1

Order code for "Housing":

- Option **A**: compact, coated aluminum
- Option **B**: compact, hygienic, stainless
- Option **C**: ultra-compact, hygienic, stainless

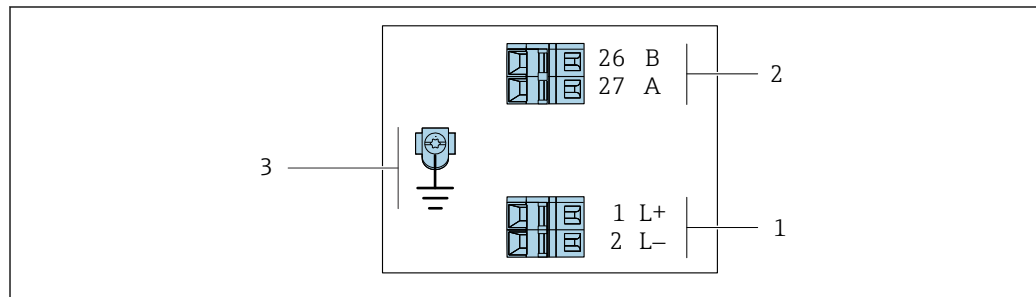

A0022716

 3 PROFIBUS DP terminal assignment

- 1 Power supply: DC 24 V
- 2 PROFIBUS DP
- 3 Connection for cable shield (IO signals) if present and/or protective ground from the supply voltage if present. Not for option C "Ultra-compact, hygienic, stainless".

Order code for "Output"	Terminal number			
	Power supply		Output	
	2 (L-)	1 (L+)	26 (RxD/TxD-P)	27 (RxD/TxD-N)
Option L	DC 24 V		B	A



Order code for "Output":
Option **L**: PROFIBUS DP, for use in non-hazardous areas and Zone 2/Div. 2

Modbus RS485 connection version

 For use in the non-hazardous area and Zone 2/Div. 2

Order code for "Output", option **M**

Depending on the housing version, the transmitters can be ordered with terminals or device plugs.

Order code for "Housing"	Connection methods available		Possible options for order code "Electrical connection"
	Output	Power supply	
Options A, B	Terminals	Terminals	<ul style="list-style-type: none"> ▪ Option A: coupling M20x1 ▪ Option B: thread M20x1 ▪ Option C: thread G ½" ▪ Option D: thread NPT ½"
Options A, B	Device plug →  32	Terminals	<ul style="list-style-type: none"> ▪ Option L: plug M12x1 + thread NPT ½" ▪ Option N: plug M12x1 + coupling M20 ▪ Option P: plug M12x1 + thread G ½" ▪ Option U: plug M12x1 + thread M20
Options A, B, C	Device plug →  32	Device plug →  32	Option Q : 2 x plug M12x1
Order code for "Housing": <ul style="list-style-type: none"> ▪ Option A: compact, coated aluminum ▪ Option B: compact, hygienic, stainless ▪ Option C: ultra-compact, hygienic, stainless 			

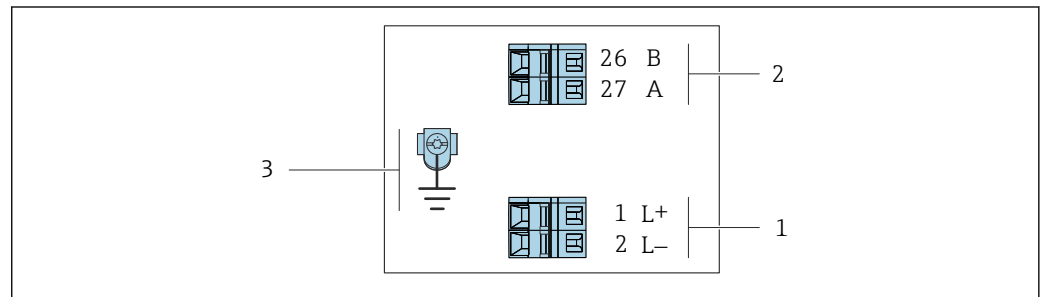

 4 Modbus RS485 terminal assignment, connection version for use in non-hazardous areas and Zone 2/Div. 2

- 1 Power supply: DC 24 V
- 2 Modbus RS485
- 3 Connection for cable shield (IO signals) if present and/or protective ground from the supply voltage if present. Not for option C "Ultra-compact, hygienic, stainless".

Order code for "Output"	Terminal number			
	Power supply		Output	
	1 (L+)	2 (L-)	26 (B)	27 (A)
Option M	DC 24 V		Modbus RS485	
Order code for "Output": Option M : Modbus RS485, for use in non-hazardous areas and Zone 2/Div. 2				

Modbus RS485 connection version

 For use in the intrinsically safe area. Connection via Safety Barrier Promass 100.

Order code for "Output", option **M**

Depending on the housing version, the transmitters can be ordered with terminals or device plugs.

Order code for "Housing"	Connection methods available		Possible options for order code "Electrical connection"
	Output	Power supply	
Options A, B	Terminals	Terminals	<ul style="list-style-type: none"> ▪ Option A: coupling M20x1 ▪ Option B: thread M20x1 ▪ Option C: thread G ½" ▪ Option D: thread NPT ½"
A, B, C	Device plug →  32		Option I: plug M12x1
Order code for "Housing": <ul style="list-style-type: none"> ▪ Option A: compact, coated aluminum ▪ Option B: compact, hygienic, stainless ▪ Option C: ultra-compact, hygienic, stainless 			

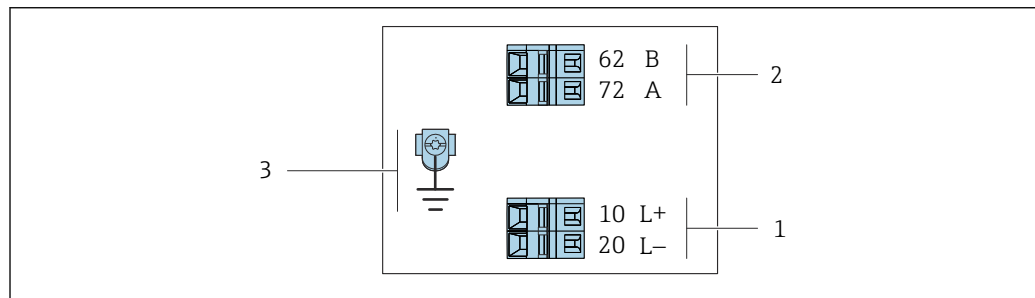

A0030219

 5 Modbus RS485 terminal assignment, connection version for use in intrinsically safe areas (connection via Safety Barrier Promass 100)



- 1 Intrinsically safe power supply
- 2 Modbus RS485
- 3 Connection for cable shield (IO signals) if present and/or protective ground from the supply voltage if present. Not for option C "Ultra-compact, hygienic, stainless".

Order code for "Output"	10 (L+)	20 (L-)	62 (B)	72 (A)
Option M	Intrinsically safe supply voltage		Modbus RS485, intrinsically safe	
Order code for "Output": Option M : Modbus RS485, for use in the intrinsically safe area (connection via Safety Barrier Promass 100)				

EtherNet/IP connection version

Order code for "Output", option **N**

Depending on the housing version, the transmitters can be ordered with terminals or device plugs.

Order code for "Housing"	Connection methods available		Possible options for order code "Electrical connection"
	Output	Power supply	
Options A, B	Device plug →  33	Terminals	<ul style="list-style-type: none"> ▪ Option L: plug M12x1 + thread NPT ½" ▪ Option N: plug M12x1 + coupling M20 ▪ Option P: plug M12x1 + thread G ½" ▪ Option U: plug M12x1 + thread M20
Options A, B, C	Device plug →  33	Device plug →  33	Option Q : 2 x plug M12x1
Order code for "Housing": <ul style="list-style-type: none"> ▪ Option A: compact, coated aluminum ▪ Option B: compact, hygienic, stainless ▪ Option C: ultra-compact, hygienic, stainless 			

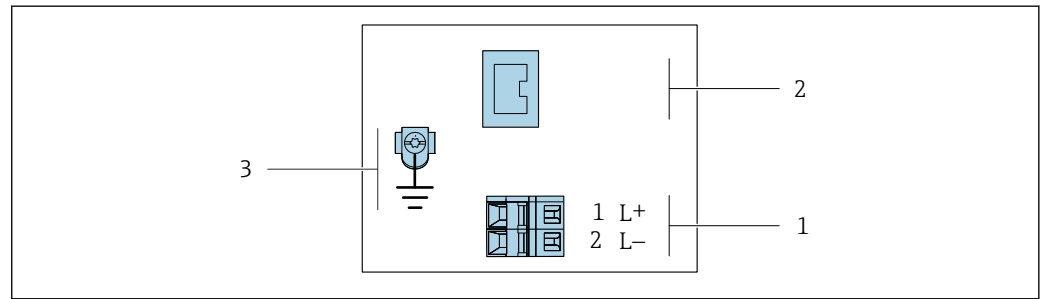

A0017054

 6 *EtherNet/IP terminal assignment*

- 1 Power supply: DC 24 V
- 2 EtherNet/IP
- 3 Connection for cable shield (IO signals) if present and/or protective ground from the supply voltage if present. Not for option C "Ultra-compact, hygienic, stainless".

Order code for "Output"	Terminal number		Output Device plug M12x1
	Power supply 2 (L-)	1 (L+)	
Option N	DC 24 V		EtherNet/IP
Order code for "Output": Option N : EtherNet/IP			

PROFINET connection version

Order code for "Output", option **R**

Depending on the housing version, the transmitters can be ordered with terminals or device plugs.

Order code for "Housing"	Connection methods available		Possible options for order code "Electrical connection"
	Output	Power supply	
Options A, B	Device plug → 31	Terminals	<ul style="list-style-type: none"> ▪ Option L: plug M12x1 + thread NPT ½" ▪ Option N: plug M12x1 + coupling M20 ▪ Option P: plug M12x1 + thread G ½" ▪ Option U: plug M12x1 + thread M20
Options A, B, C	Device plug → 31	Device plug → 31	Option Q : 2 x plug M12x1

Order code for "Housing":

- Option **A**: compact, coated aluminum
- Option **B**: compact, hygienic, stainless
- Option **C**: ultra-compact, hygienic, stainless

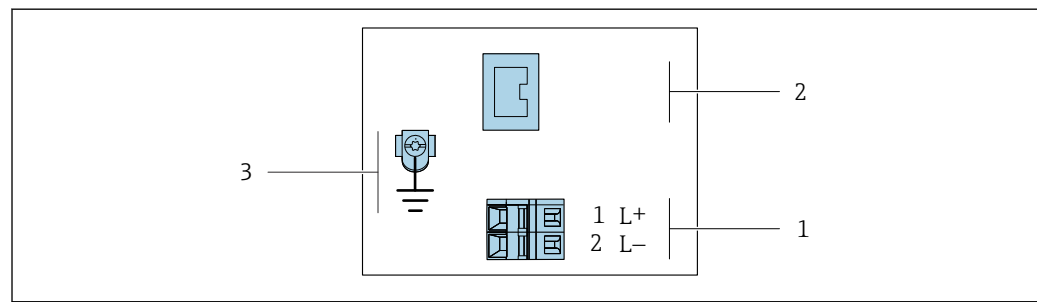

A0017054

7 *PROFINET terminal assignment*

- 1 Power supply: DC 24 V
- 2 PROFINET
- 3 Connection for cable shield (IO signals) if present and/or protective ground from the supply voltage if present. Not for option C "Ultra-compact, hygienic, stainless".

Order code for "Output"	Terminal number		Output Device plug M12x1
	Power supply 2 (L-)	1 (L+)	
Option R	DC 24 V		PROFINET

Order code for "Output":
Option **R**: PROFINET

Safety Barrier Promass 100

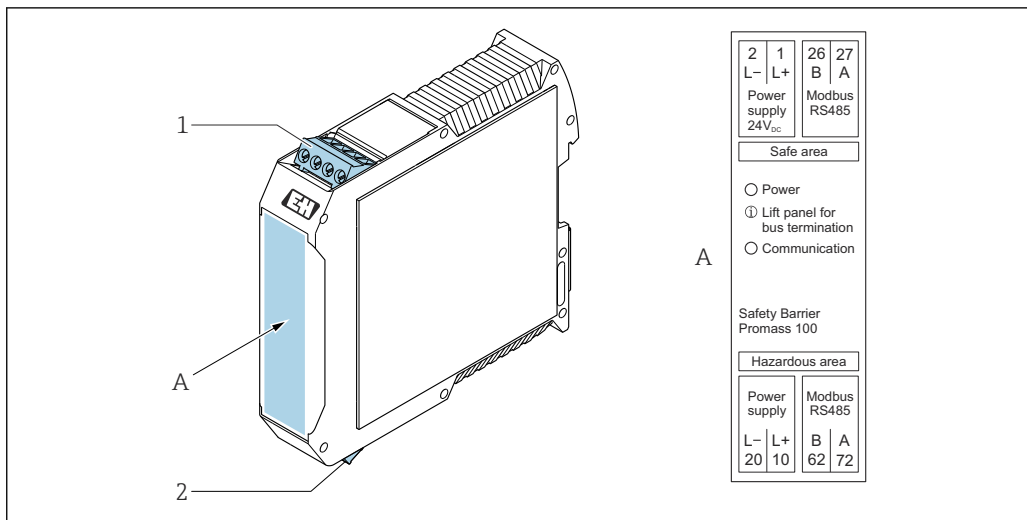

A0030220

8 Safety Barrier Promass 100 with terminals

- 1 Non-hazardous area: Zone 2; Class I, Division 2
- 2 Intrinsically safe area

Pin assignment, device plug

- i** Order codes for the M12x1 plugs, see the "Order code for **electrical connection**" column:
 - 4-20 mA HART, pulse/frequency/switch output → 24
 - PROFIBUS DP → 26
 - Modbus RS485 → 27
 - EtherNet/IP → 29
 - PROFINET → 30

Supply voltage

Intrinsically safe for all connection versions except MODBUS RS485, intrinsically safe (device side), male connection (plug)

- i** Device plug MODBUS RS485, intrinsically safe with supply voltage → 32

<p style="text-align: center; font-size: small;">A0029042</p>	Pin		Assignment	
	1	L+	DC 24 V	
	2		Not used	
	3		Not used	
	4	L-	DC 24 V	
	5		Grounding/shielding ¹⁾	
Coding		Plug/socket		
A		Plug		

1) Connection for protective ground and/or shielding from the supply voltage if present. Not for option C "Ultra-compact, hygienic, stainless". Note: There is a metallic connection between the union nut of the M12 cable and the transmitter housing.

- i** The following is recommended as a socket:
 - Binder, series 763, part no. 79 3440 35 05
 - Alternatively: Phoenix part no. 1682951 SAC-5P-5.0-PUR/M12FS SH
 - With the order code for "Output", option **B**: 4-20 mA HART, pulse/frequency/switch output
 - With the order code for "Output", option **N**: EtherNet/IP
 - When using the device in a hazardous location: Use a suitably certified socket.

4-20 mA HART with pulse/frequency/switch output

Device plug for signal transmission (device side), female connection

<p>A0016810</p>	Pin		Assignment
	1	+	4-20 mA HART (active)
	2	-	4-20 mA HART (active)
	3	+	Pulse/frequency/switch output (passive)
	4	-	Pulse/frequency/switch output (passive)
	5		Shielding ¹⁾
Coding		Plug/socket	
A		Socket	

1) Connection for cable shield (IO signals) if present. Not for option C "Ultra-compact, hygienic, stainless".
 Note: There is a metallic connection between the union nut of the M12 cable and the transmitter housing.

- Recommended plug: Binder, series 763, part no. 79 3439 12 05
- When using the device in a hazardous location, use a suitably certified plug.

PROFIBUS DP

For use in the non-hazardous area and Zone 2/Div. 2.

Device plug for signal transmission (device side)

<p>A0016811</p>	Pin		Assignment
	1		Not used
	2	A	PROFIBUS DP
	3		Not used
	4	B	PROFIBUS DP
	5		Shielding ¹⁾
Coding		Plug/socket	
B		Socket	

1) Connection for cable shield (IO signals) if present. Not for option C "Ultra-compact, hygienic, stainless".
 Note: There is a metallic connection between the union nut of the M12 cable and the transmitter housing.

- Recommended plug: Binder, series 763, part no. 79 4449 20 05
- When using the device in a hazardous location, use a suitably certified plug.

MODBUS RS485

Device plug for signal transmission with supply voltage (device side), MODBUS RS485 (intrinsically safe)

<p>A0029042</p>	Pin		Assignment
	1	L+	Supply voltage, intrinsically safe
	2	A	Modbus RS485, intrinsically safe
	3	B	
	4	L-	Supply voltage, intrinsically safe
	5		Grounding/shielding ¹⁾

	Coding	Plug/socket
	A	Plug

1) Connection for protective ground and/or shielding from the supply voltage if present. Not for option C "Ultra-compact, hygienic, stainless". Note: There is a metallic connection between the union nut of the M12 cable and the transmitter housing.

-  Recommended socket: Binder, series 763, part no. 79 3439 12 05
- When using the device in a hazardous location: Use a suitably certified socket.

Device plug for signal transmission (device side), MODBUS RS485 (not intrinsically safe)

-  For use in the non-hazardous area and Zone 2/Div. 2.

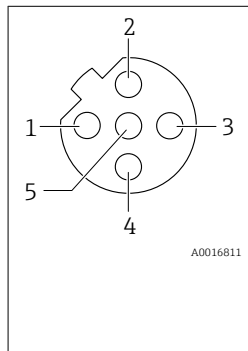
	Pin	Assignment	
	1		Not used
	2	A	Modbus RS485
	3		Not used
	4	B	Modbus RS485
	5		Shielding ¹⁾
	Coding	Plug/socket	
	B	Socket	

1) Connection for cable shield (IO signals) if present. Not for option C "Ultra-compact, hygienic, stainless". Note: There is a metallic connection between the union nut of the M12 cable and the transmitter housing.

-  Recommended plug: Binder, series 763, part no. 79 4449 20 05
- When using the device in a hazardous location, use a suitably certified plug.

EtherNet/IP

Device plug for signal transmission (device side)

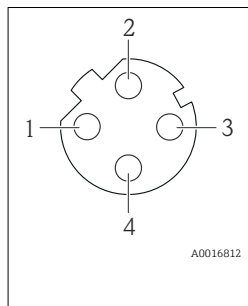
	Pin	Assignment	
	1	+	Tx
	2	+	Rx
	3	-	Tx
	4	-	Rx
		Coding	Plug/socket
	D	Socket	

-  There is a metallic connection between the union nut of the M12 cable and the transmitter housing.
- Recommended plug:
 - Binder, series 763, part no. 99 3729 810 04
 - Phoenix, part no. 1543223 SACC-M12MSD-4Q
 - When using the device in a hazardous location, use a suitably certified plug.

PROFINET

Device plug for signal transmission (device side)

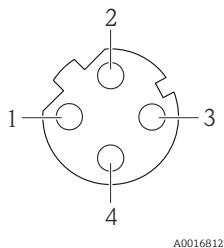
	Pin	Assignment	
	1	+	TD +
	2	+	RD +
	3	-	TD -
	4	-	RD -
	Coding		Plug/socket
D		Socket	

- i**
- There is a metallic connection between the union nut of the M12 cable and the transmitter housing.
 - Recommended plug:
 - Binder, series 763, part no. 99 3729 810 04
 - Phoenix, part no. 1543223 SACC-M12MSD-4Q
 - When using the device in a hazardous location, use a suitably certified plug.

Supply voltage

The power unit must be tested to ensure it meets safety requirements (e.g. PELV, SELV).

Transmitter

For device version with communication type:

- HART, PROFIBUS DP, EtherNet/IP: DC 20 to 30 V
- Modbus RS485, device version:
 - For use in the non-hazardous area and Zone 2/Div. 2: DC 20 to 30 V
 - For use in the intrinsically safe area: power supply via Safety Barrier Promass 100

Promass 100 safety barrier

DC 20 to 30 V

Power consumption**Transmitter**

Order code for "Output"	Maximum Power consumption
Option B : 4-20 mA HART with pulse/frequency/switch output	3.5 W
Option L : PROFIBUS DP	3.5 W
Option M Modbus RS485, for use in non-hazardous areas and Zone 2/Div. 2	3.5 W
Option M : Modbus RS485, for use in intrinsically safe areas	2.45 W
Option N : EtherNet/IP	3.5 W
Option R : PROFINET	3.5 W

Safety Barrier Promass 100

Order code for "Output"	Maximum Power consumption
Option M : Modbus RS485, for use in intrinsically safe areas	4.8 W

Current consumption**Transmitter**

Order code for "Output"	Maximum current consumption	Maximum switch-on current
Option B : 4-20mA HART, pul./freq./switch output	145 mA	18 A (< 0.125 ms)
Option L : PROFIBUS DP	145 mA	18 A (< 0.125 ms)

Order code for "Output"	Maximum current consumption	Maximum switch-on current
Option M Modbus RS485, for use in non-hazardous areas and Zone 2/Div. 2	90 mA	10 A (< 0.8 ms)
Option M : Modbus RS485, for use in intrinsically safe areas	145 mA	16 A (< 0.4 ms)
Option N : EtherNet/IP	145 mA	18 A (< 0.125 ms)
Option R : PROFINET	145 mA	18 A (< 0.125 ms)

Safety Barrier Promass 100

Order code for "Output"	Maximum current consumption	Maximum switch-on current
Option M : Modbus RS485, for use in intrinsically safe areas	230 mA	10 A (< 0.8 ms)

Device fuse Fine-wire fuse (slow-blow) T2A

Power supply failure

- Totalizers stop at the last value measured.
- Depending on the device version, the configuration is retained in the device memory or in the plug-in memory (HistoROM DAT).
- Error messages (incl. total operated hours) are stored.

Electrical connection Transmitter connection

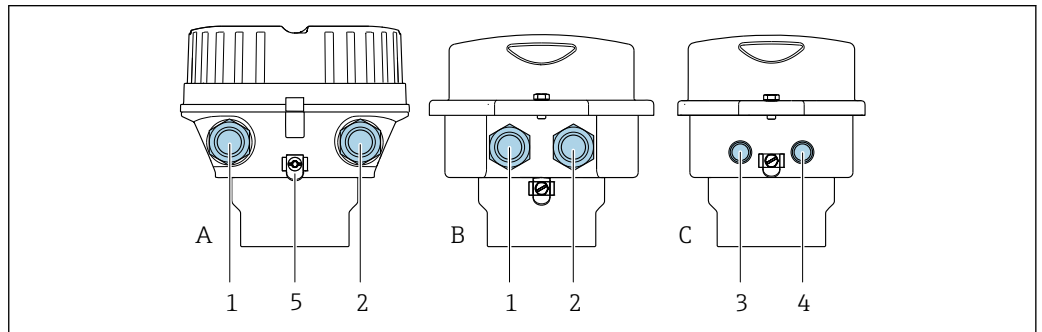

- A Housing version: compact, coated, aluminum
- B Housing version: compact, hygienic, stainless
- C Housing version: ultra-compact, hygienic, stainless, M12 device plug
- 1 Cable entry or device plug for signal transmission
- 2 Cable entry or device plug for supply voltage
- 3 Device plug for signal transmission
- 4 Device plug for supply voltage
- 5 Ground terminal. Cable lugs, pipe clips or ground disks are recommended for optimization of the grounding/shielding.

- Terminal assignment → 24
- Pin assignment, device plug → 31
- In the case of device versions with a connector, the transmitter housing does not need to be opened to connect the signal cable or power supply cable.

Connection examples

Pulse output/frequency output/switch output

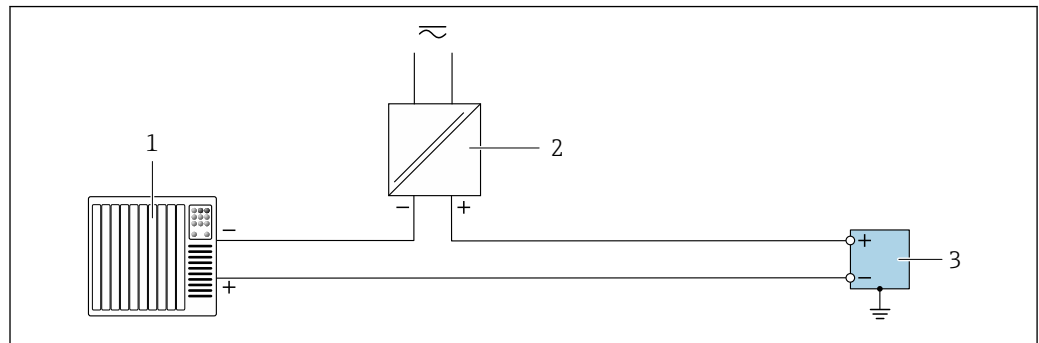

A0055855

9 Connection example for pulse output/frequency output/switch output (passive)

- 1 Automation system with pulse input/frequency input/switch input (e.g. PLC)
- 2 Power supply
- 3 Transmitter with pulse output/frequency output/switch output (passive)

Current output 4 to 20 mA HART

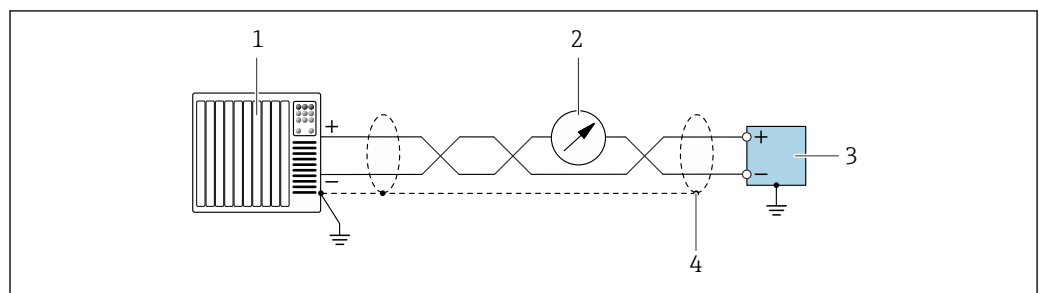

A0055862

10 Connection example for 4 to 20 mA current output with HART (active)

- 1 Automation system with 4 to 20 mA current input with HART (e.g. PLC)
- 2 Optional display unit: Note maximum load
- 3 Transmitter with 4 to 20 mA current output with HART (active)
- 4 Ground cable shield at one end. For installations in compliance with NAMUR NE 89, grounding of the cable shield on both sides is required.

Modbus RS485

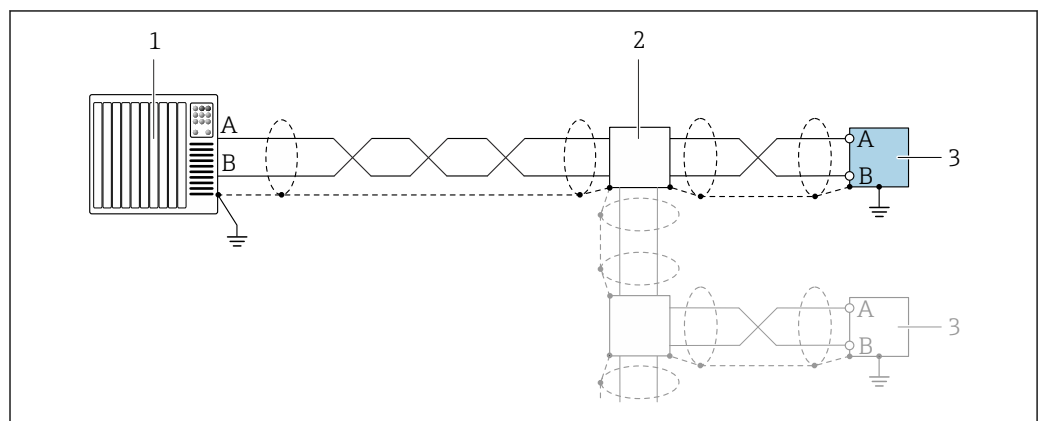

A0055863

11 Connection example for Modbus RS485

- 1 Automation system with Modbus master (e.g. PLC)
- 2 Optional distribution box
- 3 Transmitter with Modbus RS485

PROFIBUS DP



See <https://www.profibus.com> "PROFIBUS Installation Guidelines".

PROFINET



See <https://www.profibus.com> "PROFINET Planning guideline".

EtherNet/IP



See <https://www.odva.org> "EtherNet/IP Media Planning & Installation Manual".

Potential equalization

Requirements

For potential equalization:

- Pay attention to in-house grounding concepts
- Take account of operating conditions like the pipe material and grounding
- Connect the medium, sensor and transmitter to the same electric potential
- Use a ground cable with a minimum cross-section of 6 mm² (10 AWG) and a cable lug for potential equalization connections

Terminals

Transmitter

Spring terminals for wire cross-sections 0.5 to 2.5 mm² (20 to 14 AWG)

Promass 100 safety barrier

Plug-in screw terminals for wire cross-sections 0.5 to 2.5 mm² (20 to 14 AWG)

Cable entries

- Cable gland: M20 × 1.5 with cable Ø 6 to 12 mm (0.24 to 0.47 in)
- Thread for cable entry:
 - M20
 - G ½"
 - NPT ½"

Cable specification

Permitted temperature range

- The installation guidelines that apply in the country of installation must be observed.
- The cables must be suitable for the minimum and maximum temperatures to be expected.

Power supply cable (incl. conductor for the inner ground terminal)

Standard installation cable is sufficient.

Signal cable

Pulse/frequency/switch output

Standard installation cable is sufficient.

Current output 4 to 20 mA HART

Shielded twisted-pair cable.



See <https://www.fieldcommgroup.org> "HART PROTOCOL SPECIFICATIONS".

Modbus RS485

Shielded twisted-pair cable.



See <https://modbus.org> "MODBUS over Serial Line Specification and Implementation Guide".

PROFIBUS DP

Shielded twisted-pair cable. Cable type A is recommended.



See <https://www.profibus.com> "PROFIBUS Installation Guidelines".

PROFINET

Only PROFINET cables.



See <https://www.profibus.com> "PROFINET Planning guideline".

EtherNet/IP

Twisted-pair Ethernet CAT 5 or better.



See <https://www.odva.org> "EtherNet/IP Media Planning & Installation Manual".

Connecting cable between Safety Barrier Promass 100 and measuring device

Cable type	Shielded twisted-pair cable with 2x2 wires. When grounding the cable shield, observe the grounding concept of the plant.
Maximum cable resistance	2.5 Ω, one side



Comply with the maximum cable resistance specifications to ensure the operational reliability of the measuring device.

The maximum cable length for individual wire cross-sections is specified in the table below. Observe the maximum capacitance and inductance per unit length of the cable and connection values for hazardous areas .

Wire cross-section		Maximum cable length	
[mm ²]	[AWG]	[m]	[ft]
0.5	20	70	230
0.75	18	100	328
1.0	17	100	328
1.5	16	200	656
2.5	14	300	984

Performance characteristics

Reference operating conditions

- Error limits based on ISO 11631
- Water
 - +15 to +45 °C (+59 to +113 °F)
 - 2 to 6 bar (29 to 87 psi)
- Data as indicated in the calibration protocol
- Accuracy based on accredited calibration rigs according to ISO 17025



To obtain measured errors, use the *Applicator* sizing tool → 89

Maximum measurement error

o.r. = of reading; 1 g/cm³ = 1 kg/l; T = medium temperature

Base accuracy



Design fundamentals → 41

Mass flow and volume flow (liquids)

- ±0.15 % o.r.
- ±0.10 % o.r. (order code for "Calibration flow", option A, B, C)
- ±0.25 % o.r.

Mass flow (gases)

±0.50 % o.r.

Density (liquids)

Under reference conditions [g/cm ³]	Standard density calibration [g/cm ³]
±0.0005	±0.002

Temperature

±0.5 °C ± 0.005 · T °C (±0.9 °F ± 0.003 · (T - 32) °F)

Zero point stability

DN		Zero point stability	
[mm]	[in]	[kg/h]	[lb/min]
8	3/8	0.20	0.007
15	1/2	0.65	0.024
25	1	1.80	0.066
40	1 1/2	4.50	0.165
50	2	7.0	0.257
80	3	18.0	0.6615

Flow values

Flow values as turndown parameters depending on nominal diameter.

SI units

DN	1:1	1:10	1:20	1:50	1:100	1:500
[mm]	[kg/h]	[kg/h]	[kg/h]	[kg/h]	[kg/h]	[kg/h]
8	2000	200	100	40	20	4
15	6500	650	325	130	65	13
25	18000	1800	900	360	180	36
40	45000	4500	2250	900	450	90
50	70000	7000	3500	1400	700	140
80	180000	18000	9000	3600	1800	360

US units

DN	1:1	1:10	1:20	1:50	1:100	1:500
[inch]	[lb/min]	[lb/min]	[lb/min]	[lb/min]	[lb/min]	[lb/min]
3/8	73.50	7.350	3.675	1.470	0.735	0.147
1/2	238.9	23.89	11.95	4.778	2.389	0.478
1	661.5	66.15	33.08	13.23	6.615	1.323
1 1/2	1654	165.4	82.70	33.08	16.54	3.308
2	2573	257.3	128.7	51.46	25.73	5.146
3	6615	661.5	330.8	132.3	66.15	13.23

Accuracy of outputs

 The output accuracy must be factored into the measurement error if analog outputs are used; but can be ignored for fieldbus outputs (e.g. Modbus RS485, EtherNet/IP).

The outputs have the following base accuracy specifications:

Current output

Accuracy	Max. $\pm 5 \mu\text{A}$
-----------------	--------------------------

Pulse/frequency output



o.r. = of reading

Accuracy	Max. $\pm 50 \text{ ppm o.r.}$ (over the entire ambient temperature range)
-----------------	--

Repeatability

o.r. = of reading; $1 \text{ g/cm}^3 = 1 \text{ kg/l}$; T = medium temperature

Base repeatability

 Design fundamentals →  41

Mass flow and volume flow (liquids)

$\pm 0.075 \%$ o.r.

$\pm 0.05 \%$ o.r. (calibration option, for mass flow)

Mass flow (gases)

$\pm 0.25 \%$ o.r. (up to a Mach number of 0.2)

Density (liquids)

$\pm 0.00025 \text{ g/cm}^3$

Temperature

$\pm 0.25 \text{ }^\circ\text{C} \pm 0.0025 \cdot T \text{ }^\circ\text{C}$ ($\pm 0.45 \text{ }^\circ\text{F} \pm 0.0015 \cdot (T-32) \text{ }^\circ\text{F}$)

Response time

The response time depends on the configuration (damping).

Influence of ambient temperature**Current output**

o.r. = of reading

Temperature coefficient	Max. $\pm 0.005 \%$ o.r./ $^\circ\text{C}$
--------------------------------	--

Pulse/frequency output

Temperature coefficient	No additional effect. Included in accuracy.
--------------------------------	---

Influence of medium temperature**Mass flow**

o.f.s. = of full scale value

If there is a difference between the temperature during zero adjustment and the process temperature, the additional measurement error of the sensors is typically $\pm 0.0002 \%$ o.f.s./ $^\circ\text{C}$ ($\pm 0.0001 \%$ o. f.s./ $^\circ\text{F}$).

The influence is reduced when the zero adjustment is performed at process temperature.

Density

If there is a difference between the density calibration temperature and the process temperature, the measurement error of the sensors is typically $\pm 0.0001 \text{ g/cm}^3/^\circ\text{C}$ ($\pm 0.00005 \text{ g/cm}^3/^\circ\text{F}$). Field density adjustment is possible.

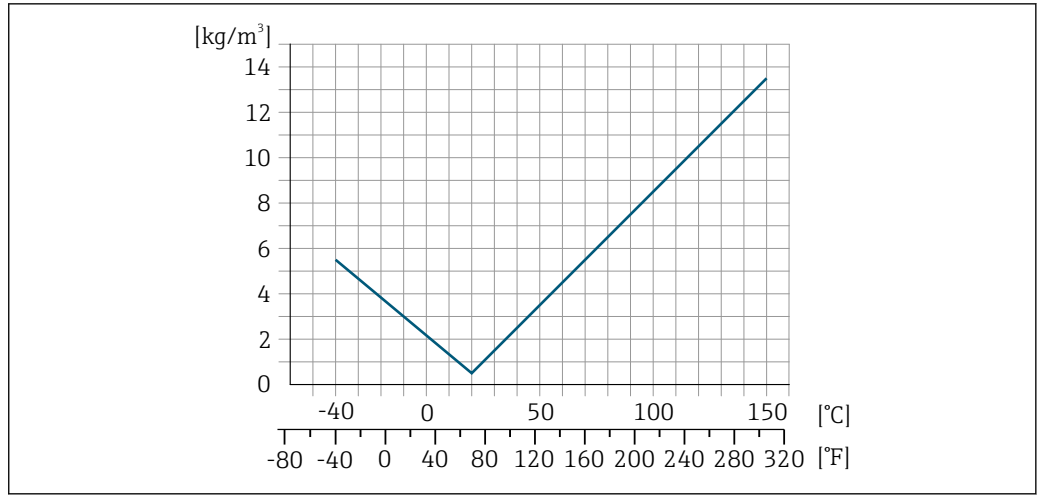

12 Field density adjustment, for example at +20 °C (+68 °F)

Temperature

$$\pm 0.005 \cdot T \text{ °C } (\pm 0.005 \cdot (T - 32) \text{ °F})$$

Influence of medium pressure

The following shows how the process pressure (gauge pressure) affects the accuracy of the mass flow.

o.r. = of reading



It is possible to compensate for the effect by:

- Reading in the current pressure measured value via the current input or a digital input.
- Specifying a fixed value for the pressure in the device parameters.



Operating Instructions → 90.

DN		[% o.r./bar]	[% o.r./psi]
[mm]	[in]		
8	3/8	no effect	
15	1/2	no effect	
25	1	no effect	
40	1 1/2	no effect	
50	2	-0.009	-0.0006
80	3	-0.020	-0.0014

Design fundamentals

o.r. = of reading, o.f.s. = of full scale value

BaseAccu = base accuracy in % o.r., BaseRepeat = base repeatability in % o.r.

MeasValue = measured value; ZeroPoint = zero point stability

Calculation of the maximum measured error as a function of the flow rate

Flow rate	Maximum measured error in % o.r.
$\geq \frac{\text{ZeroPoint}}{\text{BaseAccu}} \cdot 100$ <small>A0021332</small>	$\pm \text{BaseAccu}$ <small>A0021339</small>
$< \frac{\text{ZeroPoint}}{\text{BaseAccu}} \cdot 100$ <small>A0021333</small>	$\pm \frac{\text{ZeroPoint}}{\text{MeasValue}} \cdot 100$ <small>A0021334</small>

Calculation of the maximum repeatability as a function of the flow rate

Flow rate	Maximum repeatability in % o.r.
$\geq \frac{1/2 \cdot \text{ZeroPoint}}{\text{BaseRepeat}} \cdot 100$ <small>A0021335</small>	$\pm \text{BaseRepeat}$ <small>A0021340</small>
$< \frac{1/2 \cdot \text{ZeroPoint}}{\text{BaseRepeat}} \cdot 100$ <small>A0021336</small>	$\pm \frac{1}{2} \cdot \frac{\text{ZeroPoint}}{\text{MeasValue}} \cdot 100$ <small>A0021337</small>

Example of maximum measurement error

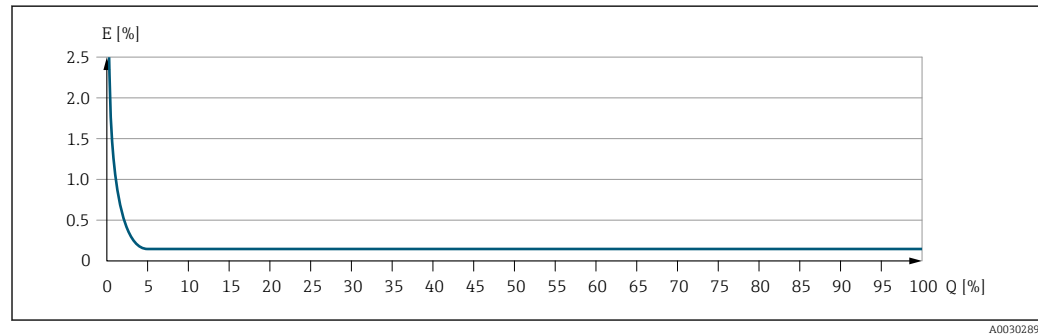

E Maximum measurement error in % o.r. (example)

Q Flow rate in % of maximum full scale value

Installation

Mounting location

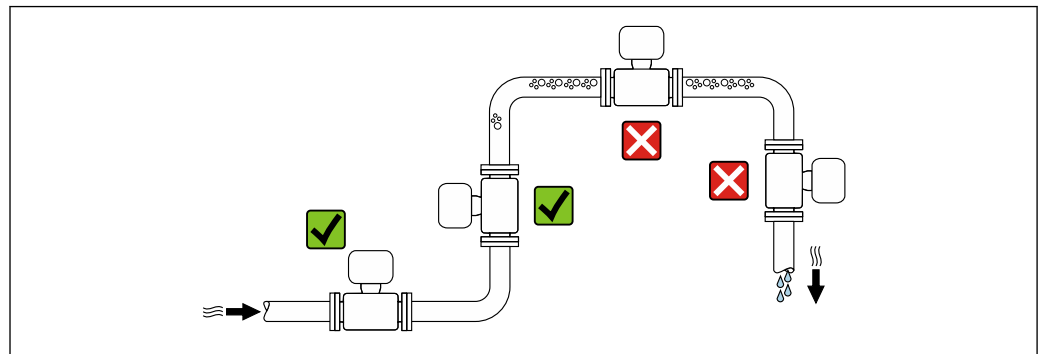

To avoid measurement errors caused by gas bubble formation in the measuring tube, avoid the following installation locations in the pipe:

- Highest point of a pipeline
- Directly upstream of a free pipe outlet in a down pipe

Installation in down pipes

However, the following installation suggestion allows for installation in an open vertical pipeline. Pipe restrictions or the use of an orifice with a smaller cross-section than the nominal diameter prevent the sensor running empty while measurement is in progress.

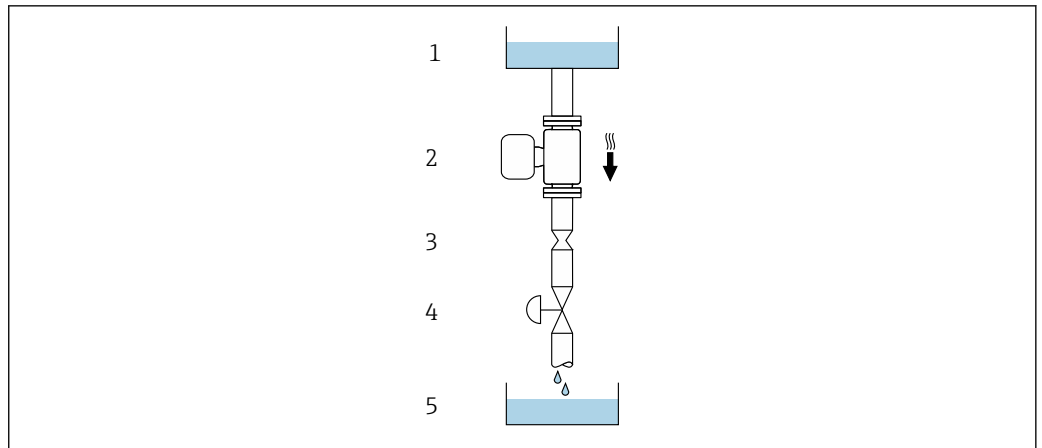

A0028773

13 Installation in a down pipe (e.g. for batching applications)

- 1 Supply tank
- 2 Sensor
- 3 Orifice plate, pipe restriction
- 4 Valve
- 5 Filling container

DN/NPS		Ø orifice plate, pipe restriction	
[mm]	[in]	[mm]	[in]
8	3/8	6	0.24
15	1/2	10	0.40
25	1	14	0.55
40	1 1/2	22	0.87
50	2	28	1.10
80	3	50	1.97

Orientation

The direction of the arrow on the sensor nameplate helps you to install the sensor according to the flow direction (direction of medium flow through the piping).

Orientation		Recommendation	
A	Vertical orientation	 A0015591	✓✓ ¹⁾
B	Horizontal orientation, transmitter at top	 A0015589	✓✓ ²⁾ Exception: → 14, 44
C	Horizontal orientation, transmitter at bottom	 A0015590	✓✓ ³⁾ Exception: → 14, 44
D	Horizontal orientation, transmitter at side	 A0015592	✗

- 1) This orientation is recommended to ensure self-draining.
- 2) Applications with low process temperatures may reduce the ambient temperature. To maintain the minimum ambient temperature for the transmitter, this orientation is recommended.
- 3) Applications with high process temperatures may increase the ambient temperature. To maintain the maximum ambient temperature for the transmitter, this orientation is recommended.

If a sensor is installed horizontally with a curved measuring tube, match the position of the sensor to the medium properties.

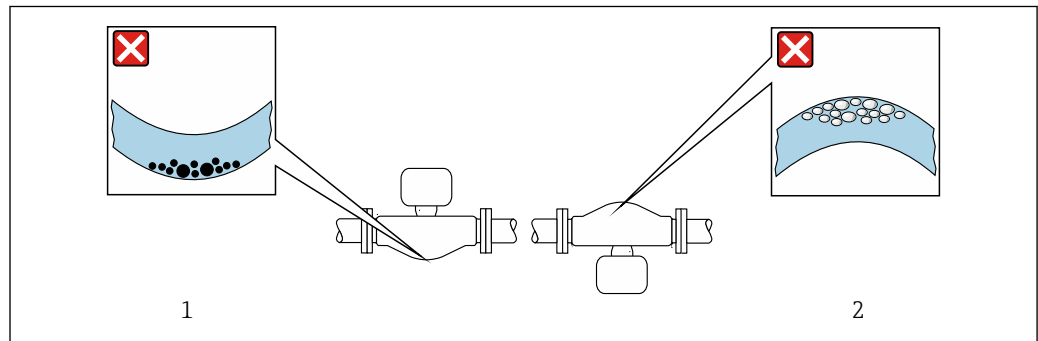

14 Orientation of sensor with curved measuring tube

- 1 Avoid this orientation for media with entrained solids: Risk of solids accumulating
- 2 Avoid this orientation for outgassing media: Risk of gas accumulating

Inlet and outlet runs

No special precautions need to be taken for fittings that create turbulence, such as valves, elbows or T-pieces, as long as no cavitation occurs → 52.

Special installation instructions

Drainability

When installed vertically, the measuring tubes can be drained completely and protected against buildup.

Hygienic compatibility

i When installing in hygienic applications, please refer to the information in the "Certificates and approvals/hygienic compatibility" section → 84

Rupture disk

Process-related information: → 52.

WARNING

Danger from medium escaping!

Medium escaping under pressure can cause injury or material damage.

- ▶ Take precautions to prevent danger to persons and damage if the rupture disk is actuated.
- ▶ Observe the information on the rupture disk sticker.
- ▶ Make sure that the function and operation of the rupture disk is not impeded through the installation of the device.
- ▶ Do not use a heating jacket.
- ▶ Do not remove or damage the rupture disk.

The position of the rupture disk is indicated on a sticker applied over it. If the rupture disk is triggered, the sticker is destroyed. The disk can therefore be visually monitored.

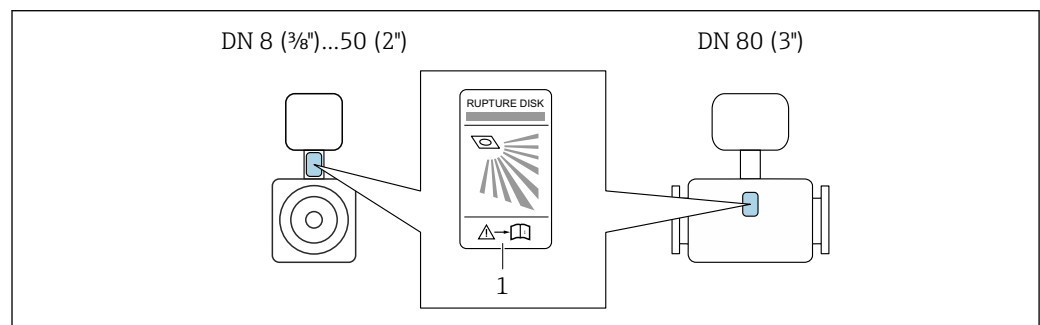

1 Rupture disk label

Zero point verification and zero adjustment

All measuring instruments are calibrated in accordance with state-of-the-art technology. Calibration takes place under reference conditions → 38. Therefore, a zero adjustment in the field is generally not required.

Experience shows that zero adjustment is advisable only in special cases:

- To achieve maximum measurement accuracy even with low flow rates.
- Under extreme process or operating conditions (e.g. very high process temperatures or very high-viscosity media).
- For gas applications with low pressure.

For information on checking the zero point and performing a zero adjustment, see the Operating Instructions for the device.

i To achieve the highest possible measurement accuracy at low flow rates, the installation must protect the sensor from mechanical stress during operation.

Installing the Safety Barrier Promass 100

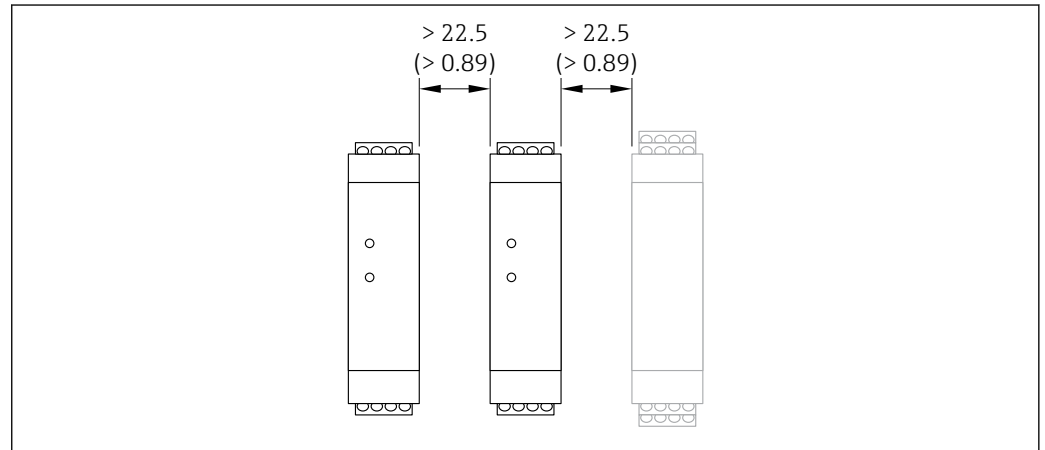

15 Minimum distance between additional Safety Barrier Promass 100 or other modules. Engineering unit mm (in)

Environment

Ambient temperature range

Measuring instrument	<ul style="list-style-type: none"> ■ -40 to +60 °C (-40 to +140 °F) ■ Order code for "Test, certificate", option JM: -50 to +60 °C (-58 to +140 °F)
Safety Barrier Promass 100	-40 to +60 °C (-40 to +140 °F)

- ▶ If operating outdoors:
Avoid direct sunlight, particularly in warm climatic regions.

Storage temperature

-40 to +80 °C (-40 to +176 °F), preferably at +20 °C (+68 °F)

Climate class

DIN EN 60068-2-38 (test Z/AD)

Degree of protection

Transmitter and sensor

- Standard: IP66/67, Type 4X enclosure, suitable for pollution degree 4
- With the order code for "Sensor options", option CM: IP69 can also be ordered
- When the housing is open: IP20, Type 1 enclosure, suitable for pollution degree 2
- Display module: IP20, Type 1 enclosure, suitable for pollution degree 2

Safety Barrier Promass 100
IP20

Vibration resistance and shock resistance**Sinusoidal vibration similar to IEC 60068-2-6**

- 2 to 8.4 Hz, 3.5 mm peak
- 8.4 to 2 000 Hz, 1 g peak

Broadband random vibration similar to IEC 60068-2-64

- 10 to 200 Hz, 0.003 g²/Hz
- 200 to 2 000 Hz, 0.001 g²/Hz
- Total: 1.54 g rms

Half-sine shocks similar to IEC 60068-2-27

6 ms 30 g

Rough handling shocks similar to IEC 60068-2-31**Electromagnetic compatibility (EMC)**

- As per IEC/EN 61326
- As per NAMUR Recommendation 21 (NE 21), NAMUR Recommendation 21 (NE 21) is fulfilled when the device is installed in accordance with NAMUR Recommendation 98 (NE 98).
- As per IEC/EN 61000-6-2 and IEC/EN 61000-6-4
- Complies with emission limits for industry as per EN 55011 (class A)
- Device version with PROFIBUS DP: Complies with emission limits for industry as per EN 50170 Volume 2, IEC 61784



The following applies for PROFIBUS DP: If baud rates > 1.5 MBaud, an EMC cable entry must be used and the cable shield must continue as far as the terminal wherever possible.



Details are provided in the Declaration of Conformity.



This unit is not intended for use in residential environments and cannot guarantee adequate protection of the radio reception in such environments.

Process**Medium temperature range**

-40 to +150 °C (-40 to +302 °F)

Dependency of ambient temperature on medium temperature

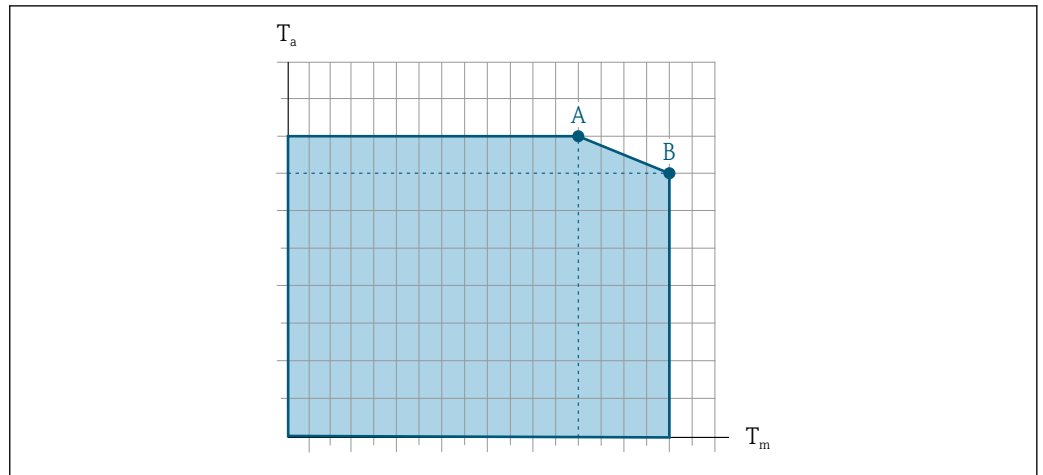

A0031121

16 Exemplary representation, values in the table below.

T_a Ambient temperature

T_m Medium temperature

A Maximum permitted medium temperature T_m at $T_{a\max} = 60\text{ °C (140 °F)}$; higher medium temperatures T_m require a reduction in the ambient temperature T_a

B Maximum permitted ambient temperature T_a for the maximum specified medium temperature T_m of the sensor



Values for devices that are used in the hazardous area:
Separate Ex documentation (XA) for the device .

Not insulated				Insulated			
A		B		A		B	
T_a	T_m	T_a	T_m	T_a	T_m	T_a	T_m
60 °C (140 °F)	150 °C (302 °F)	-	-	60 °C (140 °F)	110 °C (230 °F)	55 °C (131 °F)	150 °C (302 °F)

Medium density 0 to 5 000 kg/m³ (0 to 312 lb/cf)

Pressure/temperature ratings

The following pressure/temperature diagrams apply to all pressure-bearing parts of the device and not just the process connection. The diagrams show the maximum permissible medium pressure depending on the specific medium temperature.

Flange similar to EN 1092-1 (DIN 2501)

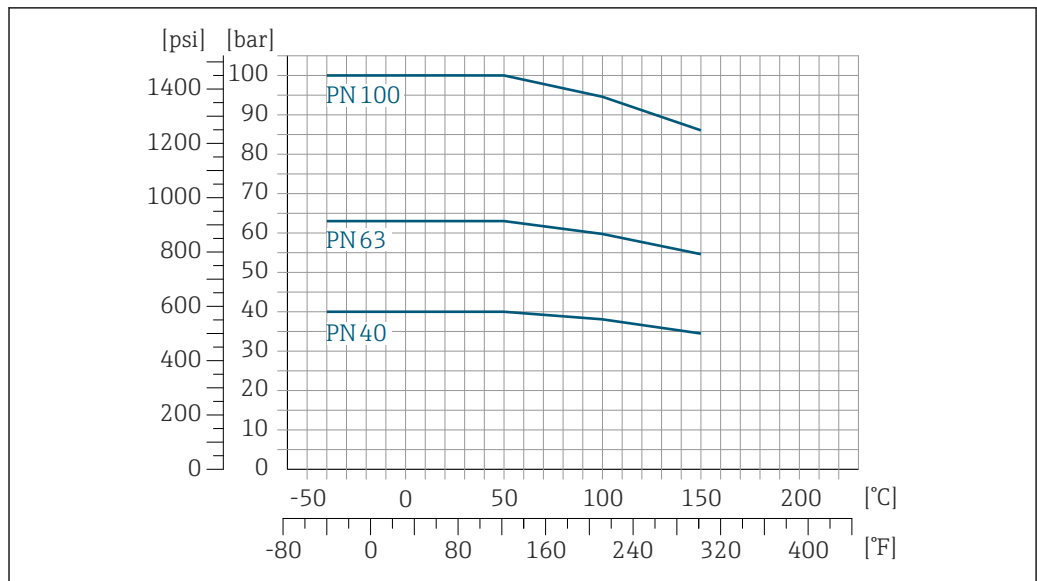

A0029832-EN

17 With flange material 1.4404 (F316/F316L)

Flange similar to ASME B16.5

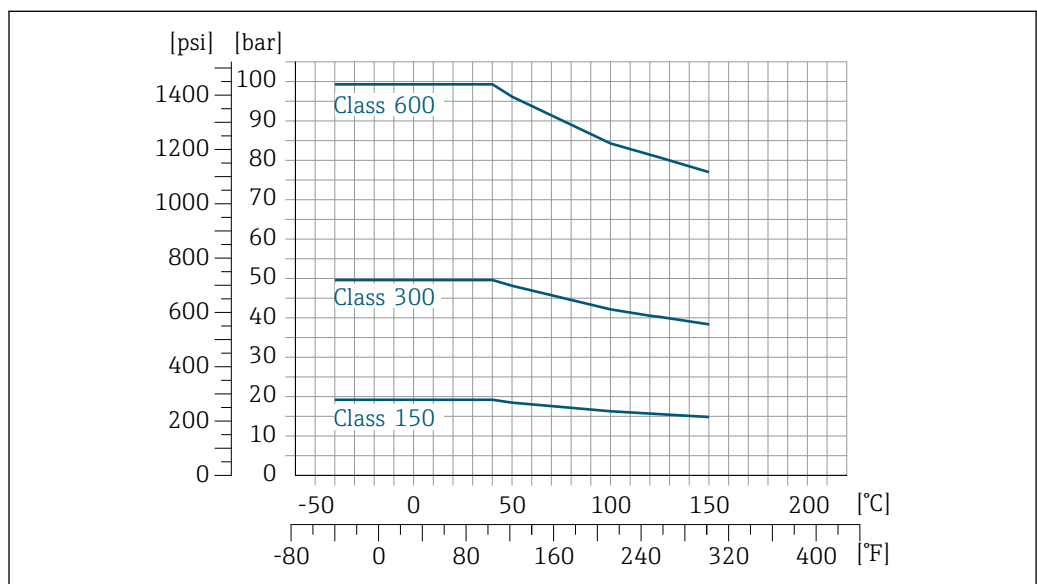

A0029833-EN

18 With flange material 1.4404 (F316/F316L)

Flange JIS B2220

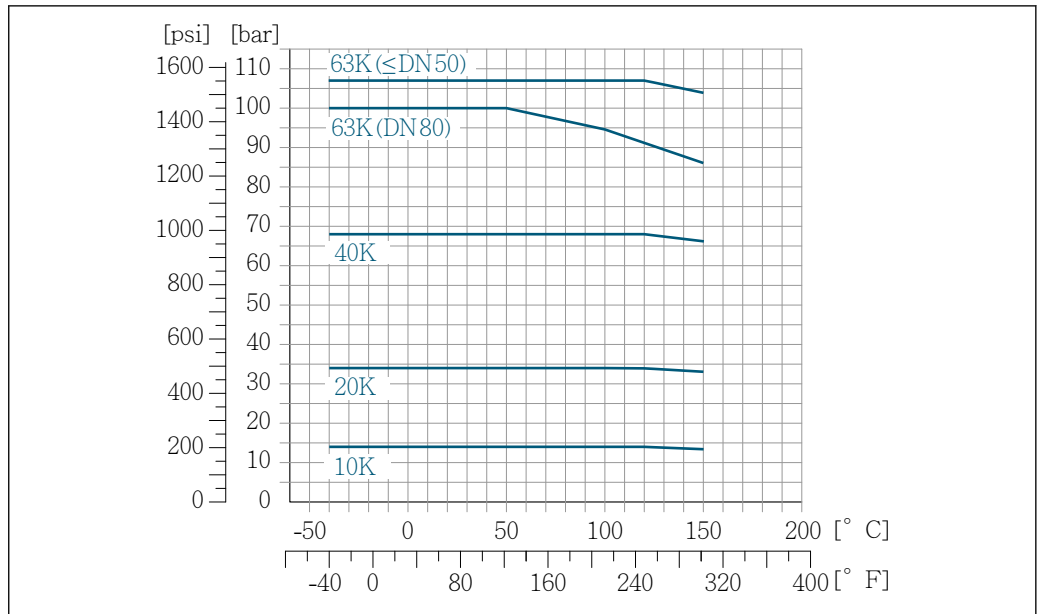

19 With flange material 1.4404 (F316/F316L)

Flange DIN 11864-2 Form A

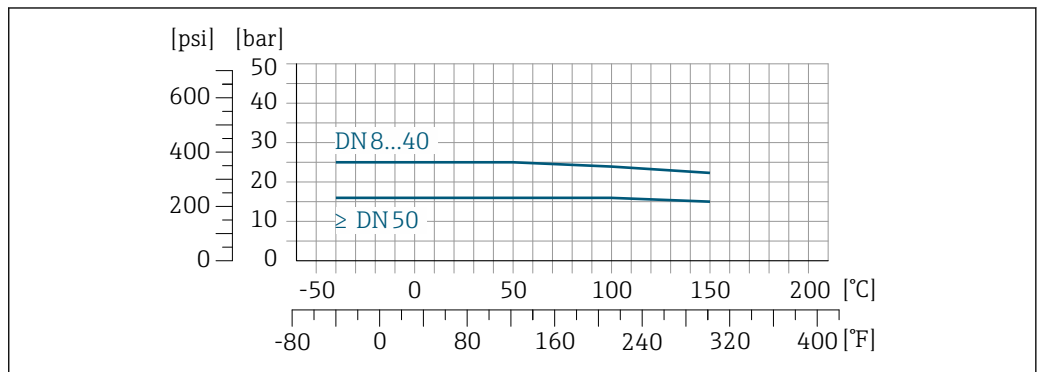

20 With flange material 1.4404 (316/316L)

Threaded adapter DIN 11851

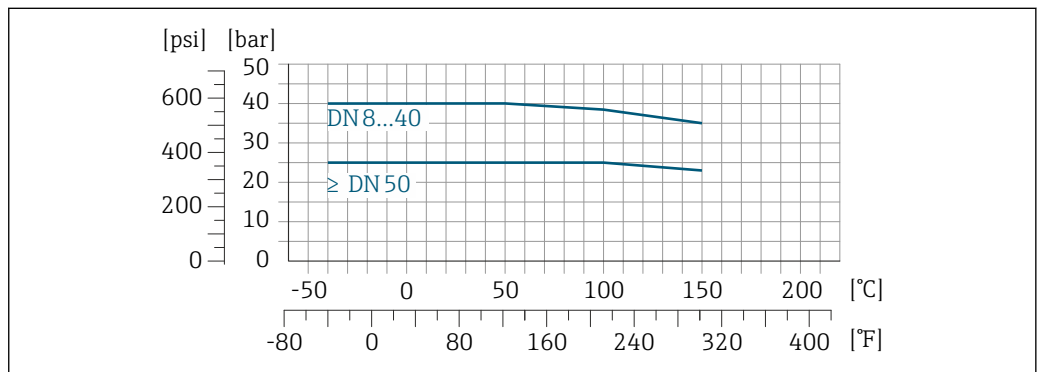

21 With connection material 1.4404 (316/316L)

DIN 11851 allows for applications up to +140 °C (+284 °F) if suitable sealing materials are used. Please take this into account when selecting seals and counterparts, as these components can limit the pressure and temperature range.

Threaded adapter DIN 11864-1 Form A

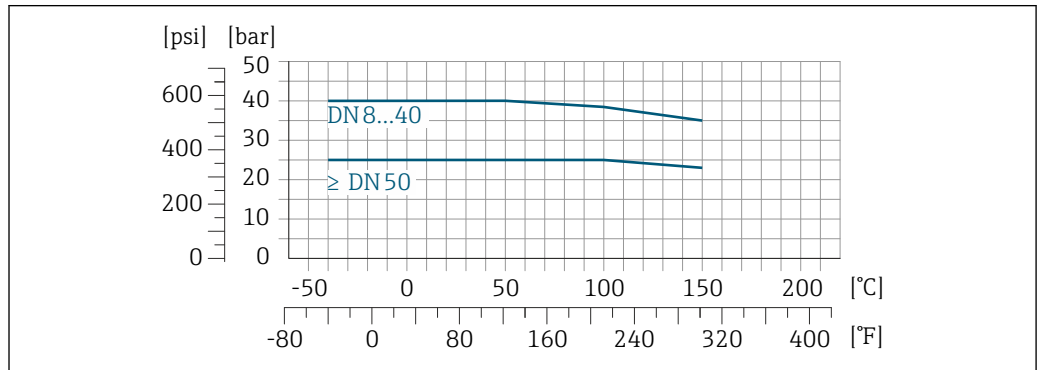

A0029848-EN

22 With connection material 1.4404 (316/316L)

Threaded adapter ISO 2853

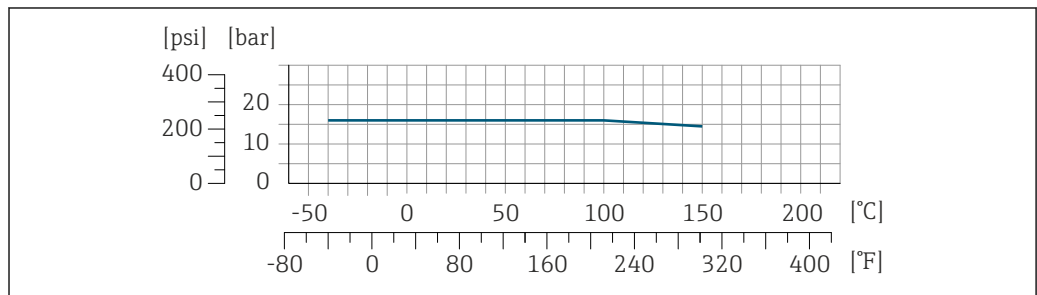

A0029853-EN

23 With connection material 1.4404 (316/316L)

Threaded adapter SMS 1145

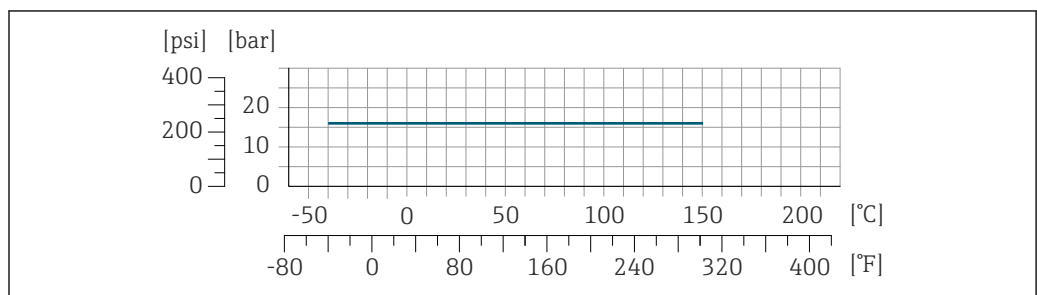

A0032218-EN

24 With connection material 1.4404 (316/316L)

VCO

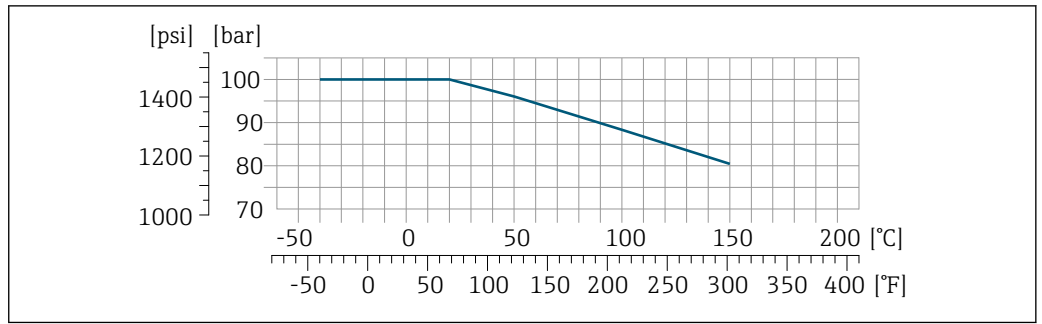

25 With connection material 1.4404 (316/316L)

Tri-Clamp

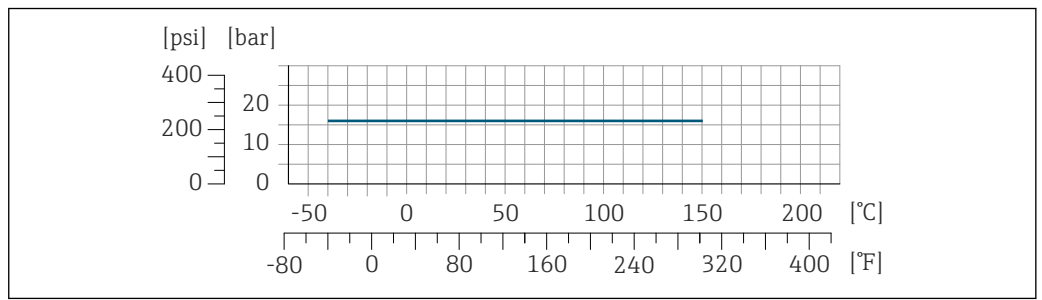

The clamp connections are suitable up to a maximum pressure of 16 bar (232 psi). Please observe the operating limits of the clamp and seal used as they can be over 16 bar (232 psi). The clamp and seal are not included in the scope of supply.

Sensor housing

The sensor housing is filled with dry nitrogen gas and protects the electronics and mechanics inside.

i If a measuring tube fails (e.g. due to process characteristics like corrosive or abrasive fluids), the fluid will initially be contained by the sensor housing.

In the event of a tube failure, the pressure level inside the sensor housing will rise according to the operating process pressure. If the user judges that the sensor housing burst pressure does not provide an adequate safety margin, the device can be fitted with a rupture disk. This prevents excessively high pressure from forming inside the sensor housing. Therefore, the use of a rupture disk is strongly recommended in applications involving high gas pressures, and particularly in applications in which the process pressure is greater than 2/3 of the sensor housing burst pressure.

Burst pressure of the sensor housing

If the device is fitted with a rupture disk (order code for "Sensor option", option CA "Rupture disk"), the rupture disk trigger pressure is decisive.

The sensor housing burst pressure refers to a typical internal pressure which is reached prior to mechanical failure of the sensor housing and which was determined during type testing. The corresponding type test declaration can be ordered with the device (order code for "Additional approval", option LN "Sensor housing burst pressure, type test").

DN		Sensor housing burst pressure	
[mm]	[in]	[bar]	[psi]
8	3/8	250	3 620
15	1/2	250	3 620
25	1	250	3 620
40	1 1/2	200	2 900

DN		Sensor housing burst pressure	
[mm]	[in]	[bar]	[psi]
50	2	180	2 610
80	3	120	1 740

For information on the dimensions: see the "Mechanical construction" section

Rupture disk

To increase the level of safety, a device version with a rupture disk with a trigger pressure of 10 to 15 bar (145 to 217.5 psi) can be used (order code for "Sensor option", option CA "rupture disk").

The use of rupture disks cannot be combined with the separately available heating jacket.

Internal cleaning

- CIP cleaning
- SIP cleaning



Options

Oil- and grease-free version for wetted parts, without declaration



Order code for "Service", option HA ¹⁾

Flow limit



Select the nominal diameter by optimizing between the required flow range and permissible pressure loss.

 For an overview of the full scale values for the measuring range, see the "Measuring range" section →  8

- The minimum recommended full scale value is approx. 1/20 of the maximum full scale value
- For the most common applications, 20 to 50 % of the maximum full scale value can be considered ideal
- A low full scale value must be selected for abrasive media (such as liquids with entrained solids): flow velocity < 1 m/s (< 3 ft/s).
- For gas measurement the following rules apply:
 - The flow velocity in the measuring tubes should not exceed half the speed of sound (0.5 Mach)
 - The maximum mass flow depends on the density of the gas: formula

 To calculate the flow limit, use the *Applicator* sizing tool →  89

Pressure loss

 To calculate the pressure loss, use the *Applicator* sizing tool →  89

Static pressure

It is important that cavitation does not occur, or that gases entrained in the liquids do not outgas. This is prevented by means of a sufficiently high static pressure.

For this reason, the following mounting locations are recommended:

- At the lowest point in a vertical pipe
- Downstream from pumps (no danger of vacuum)

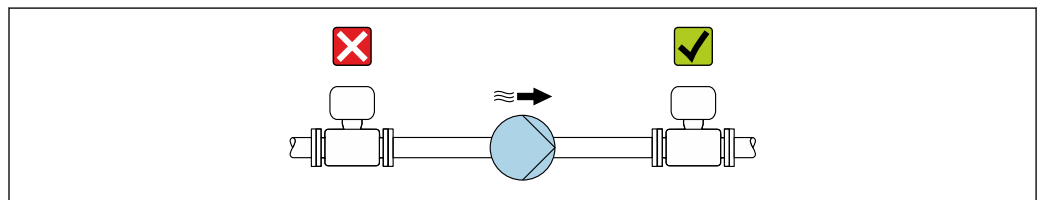

A0028777

Thermal insulation

In the case of some fluids, it is important to keep the heat radiated from the sensor to the transmitter to a low level. A wide range of materials can be used for the required insulation.

1) Cleaning only refers to the measuring instrument. Any accessories that have been supplied are not cleaned.

NOTICE**Electronics overheating on account of thermal insulation!**

- ▶ Recommended orientation: horizontal orientation, transmitter housing pointing downwards.
- ▶ Do not insulate the transmitter housing .
- ▶ Maximum permissible temperature at the lower end of the transmitter housing: 80 °C (176 °F)
- ▶ Thermal insulation with exposed extension neck: We recommend that you do not insulate the extension neck in order to ensure optimum dissipation of heat.

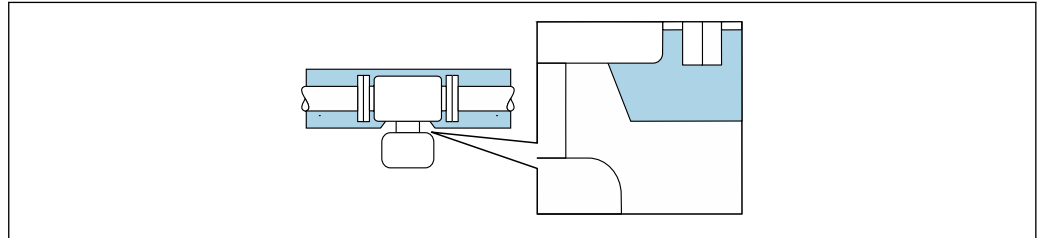

A0034391

26 Thermal insulation with exposed extension neck

Heating

Some media require suitable measures to avoid loss of heat at the sensor.

Heating options

- Electrical heating, e.g. with electric band heaters ²⁾
- Via pipes carrying hot water or steam
- Via heating jackets

i Heating jackets for the sensors can be ordered as accessories from Endress+Hauser → 88.

NOTICE**Danger of overheating when heating**

- ▶ Ensure that the temperature at the lower end of the transmitter housing does not exceed 80 °C (176 °F).
- ▶ Ensure that sufficient convection takes place at the transmitter neck.
- ▶ Ensure that a sufficiently large area of the transmitter neck remains exposed. The uncovered part serves as a radiator and protects the electronics from overheating and excessive cooling.
- ▶ When using in potentially explosive atmospheres, observe the information in the device-specific Ex documentation. For detailed information on the temperature tables, see the separate document entitled "Safety Instructions" (XA) for the device.
- ▶ Consider the behavior of the process diagnostics "830 Ambient temperature too high" and "832 Electronics temperature too high" if overheating cannot be avoided by a suitable system design.

Vibrations

The high oscillation frequency of the measuring tubes ensures that the correct operation of the measuring system is not influenced by plant vibrations.

2) The use of parallel electric band heaters is generally recommended (bidirectional electricity flow). Particular considerations must be made if a single-wire heating cable is to be used. Additional information is provided in the document EA01339D "Installation instructions for electrical trace heating systems" → 91

Mechanical construction

Dimensions in SI units

Compact version

Order code for "Housing", option A "Compact coated aluminum"

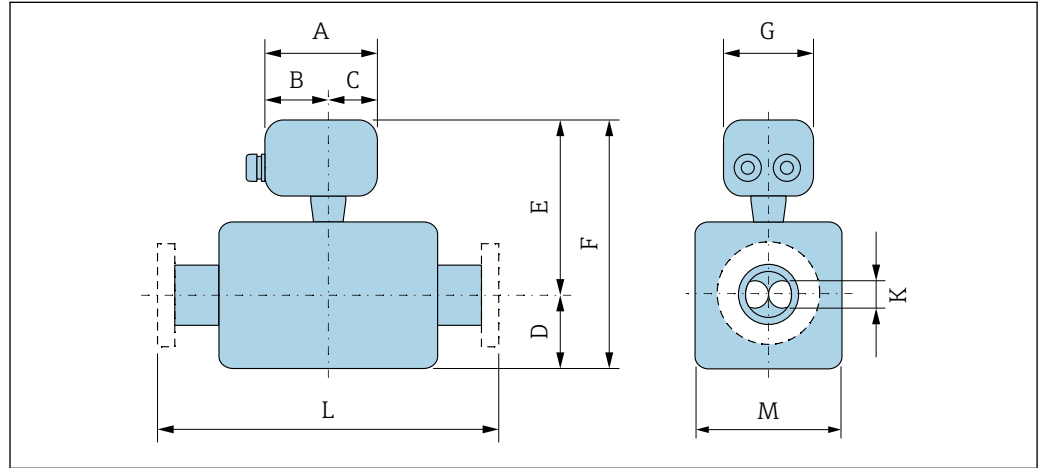

A0033787

DN [mm]	A [mm]	B [mm]	C [mm]	D [mm]	E ¹⁾ [mm]	F ¹⁾ [mm]	G [mm]	K [mm]	L [mm]	M [mm]
8	147.5	93.5	54	89.1	177.1	266.2	136	5.35	²⁾	44.9
15	147.5	93.5	54	100.1	177.1	277.2	136	8.30	²⁾	44.9
25	147.5	93.5	54	102.1	174.2	276.2	136	12.0	²⁾	51
40	147.5	93.5	54	120.7	180.2	300.8	136	17.6	²⁾	64.3
50	147.5	93.5	54	175.5	194.5	369.9	136	26.0	²⁾	91.1
80	147.5	93.5	54	205.3	210	415.3	136	40.5	²⁾	127

1) If using a display, order code for "Display; operation", option B: values +28 mm

2) Depends on the particular process connection

Order code for "Housing", option B "Compact, hygienic, stainless"

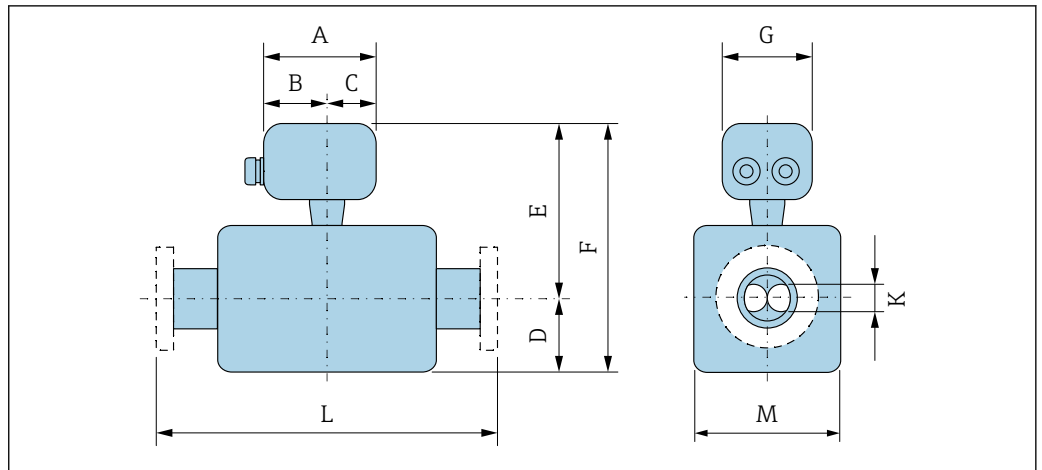

A0033787

DN [mm]	A [mm]	B [mm]	C [mm]	D [mm]	E ¹⁾ [mm]	F ¹⁾ [mm]	G [mm]	K [mm]	L [mm]	M [mm]
8	136.8	78	58.8	89.1	172.5	261.6	133.5	5.35	²⁾	44.9
15	136.8	78	58.8	100.1	172.5	272.6	133.5	8.30	²⁾	44.9
25	136.8	78	58.8	102.1	169.6	271.6	133.5	12.0	²⁾	51
40	136.8	78	58.8	120.7	175.6	296.2	133.5	17.6	²⁾	64.3
50	136.8	78	58.8	175.5	189.9	365.3	133.5	26.0	²⁾	91.1
80	136.8	78	58.8	205.3	205.4	410.8	133.5	40.5	²⁾	127

- 1) If using a display, order code for "Display; operation", option B: values +14 mm
 2) Depends on the particular process connection

Order code for "Housing", option C "Ultra compact hygienic, stainless"

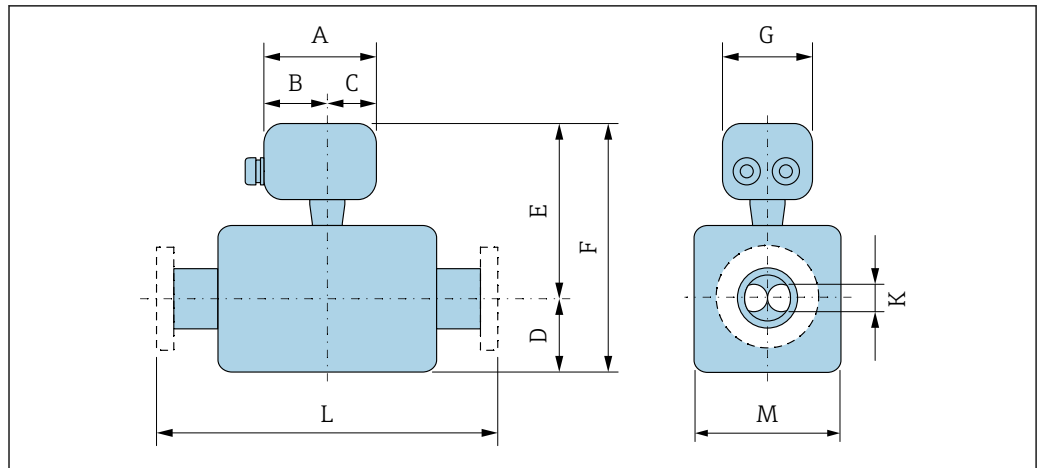

A0033787

DN [mm]	A [mm]	B [mm]	C [mm]	D [mm]	E ¹⁾ [mm]	F ¹⁾ [mm]	G [mm]	K [mm]	L [mm]	M [mm]
8	123.6	67.7	55.9	89.1	172.3	261.4	111.4	5.35	²⁾	44.9
15	123.6	67.7	55.9	100.1	172.3	272.4	111.4	8.30	²⁾	44.9
25	123.6	67.7	55.9	102.1	169.4	271.4	111.4	12.0	²⁾	51
40	123.6	67.7	55.9	120.7	175.4	296	111.4	17.6	²⁾	64.3
50	123.6	67.7	55.9	175.5	189.6	365	111.4	26.0	²⁾	91.1
80	123.6	67.7	55.9	205.3	205.2	410.5	111.4	40.5	²⁾	127

- 1) If using a display, order code for "Display; operation", option B: values +14 mm
 2) Depends on the particular process connection

Flange connections

Fixed flange EN 1092-1, ASME B16.5, JIS B2220

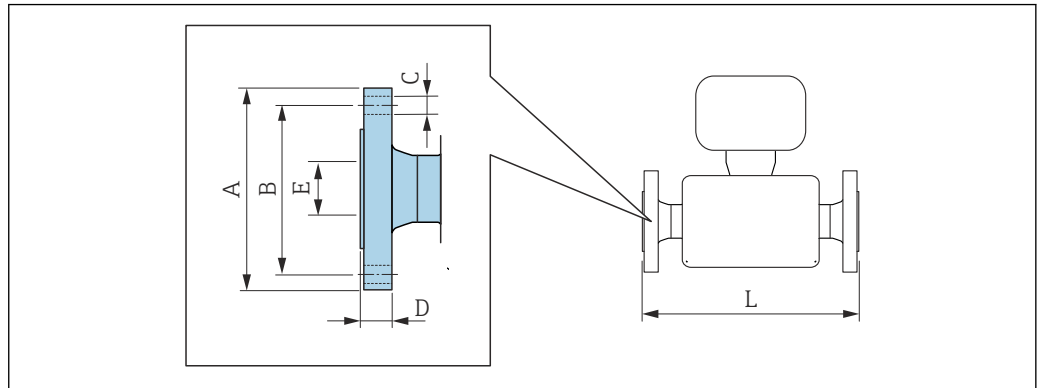

A0015621

i Length tolerance for dimension L in mm:
+1.5/-2.0

Flange similar to EN 1092-1 (DIN 2501/DIN 2512N), PN 40						
1.4404 (F316/F316L): order code for "Process connection", option D2S						
Flange with groove similar to EN 1092-1 Form D (DIN 2512N), PN 40						
1.4404 (F316/F316L): order code for "Process connection", option D6S						
DN [mm]	A [mm]	B [mm]	C [mm]	D [mm]	E [mm]	L [mm]
8 ¹⁾	95	65	4 × Ø14	16	17.3	232/510 ²⁾
15	95	65	4 × Ø14	16	17.3	279/510 ²⁾
25	115	85	4 × Ø14	18	28.5	329/600 ²⁾
40	150	110	4 × Ø18	18	43.1	445
50	165	125	4 × Ø18	20	54.5	556/715 ²⁾
80	200	160	8 × Ø18	24	82.5	611/915 ²⁾
Surface roughness (flange): EN 1092-1 Form B1 (DIN 2526 Form C), Ra 3.2 to 12.5 µm						

- 1) DN 8 with DN 15 flanges as standard
- 2) Installed length in accordance with NAMUR recommendation NE 132 optionally available (order code for "Process connection", option D2N or D6N (with groove))

Flange similar to EN 1092-1 (DIN 2501), PN 40 (with DN 25 flanges)						
1.4404 (F316/F316L)						
<i>Order code for "Process connection", option R2S</i>						
DN [mm]	A [mm]	B [mm]	C [mm]	D [mm]	E [mm]	L [mm]
8	115	85	4 × Ø14	18	28.5	329
15	115	85	4 × Ø14	18	28.5	329
Surface roughness (flange): EN 1092-1 Form B1 (DIN 2526 Form C), Ra 3.2 to 12.5 µm						

Flange similar to EN 1092-1 (DIN 2501/DIN 2512N), PN 63 1.4404 (F316/F316L): order code for "Process connection", option D3S						
Flange with groove similar to EN 1092-1 Form D (DIN 2512N), PN 63 1.4404 (F316/F316L): order code for "Process connection", option D7S						
DN [mm]	A [mm]	B [mm]	C [mm]	D [mm]	E [mm]	L [mm]
50	180	135	4 × Ø22	26	54.5	565
80	215	170	8 × Ø22	28	81.7	646
Surface roughness (flange): EN 1092-1 Form B2 (DIN 2526 Form E), Ra 0.8 to 3.2 µm						

Flange similar to EN 1092-1 (DIN 2501/DIN 2512N), PN 100 1.4404 (F316/F316L) Order code for "Process connection", option D4S						
Flange with groove similar to EN 1092-1 Form D (DIN 2512N) available, PN 100 1.4404 (F316/F316L) Order code for "Process connection", option D8S						
DN [mm]	A [mm]	B [mm]	C [mm]	D [mm]	E [mm]	L [mm]
8 ¹⁾	105	75	4 × Ø14	20	17.3	261
15	105	75	4 × Ø14	20	17.3	295
25	140	100	4 × Ø18	24	28.5	360
40	170	125	4 × Ø22	26	42.5	486
50	195	145	4 × Ø26	28	53.9	581
80	230	180	8 × Ø26	32	80.9	656
Surface roughness (flange): EN 1092-1 Form B2 (DIN 2526 Form E), Ra 0.8 to 3.2 µm						

1) DN 8 with DN 15 flanges as standard

Flange similar to ASME B16.5, Class 150 1.4404 (F316/F316L) Order code for "Process connection", option AAS						
DN [mm]	A [mm]	B [mm]	C [mm]	D [mm]	E [mm]	L [mm]
8 ¹⁾	90	60.3	4 × Ø15.7	11.2	15.7	232
15	90	60.3	4 × Ø15.7	11.2	15.7	279
25	110	79.4	4 × Ø15.7	14.2	26.7	329
40	125	98.4	4 × Ø15.7	17.5	40.9	445
50	150	120.7	4 × Ø19.1	19.1	52.6	556
80	190	152.4	4 × Ø19.1	23.9	78.0	611
Surface roughness (flange): Ra 3.2 to 6.3 µm						

1) DN 8 with DN 15 flanges as standard

Flange similar to ASME B16.5, Class 300 1.4404 (F316/F316L) Order code for "Process connection", option ABS						
DN [mm]	A [mm]	B [mm]	C [mm]	D [mm]	E [mm]	L [mm]
8 ¹⁾	95	66.7	4 × Ø15.7	14.2	15.7	232
15	95	66.7	4 × Ø15.7	14.2	15.7	279

Flange similar to ASME B16.5, Class 300						
1.4404 (F316/F316L)						
<i>Order code for "Process connection", option ABS</i>						
DN [mm]	A [mm]	B [mm]	C [mm]	D [mm]	E [mm]	L [mm]
25	125	88.9	4 × Ø19.0	17.5	26.7	329
40	155	114.3	4 × Ø22.3	20.6	40.9	445
50	165	127	8 × Ø19.0	22.3	52.6	556
80	210	168.3	8 × Ø22.3	28.4	78.0	611
Surface roughness (flange): Ra 3.2 to 6.3 µm						

1) DN 8 with DN 15 flanges as standard

Flange similar to ASME B16.5, Class 600						
1.4404 (F316/F316L)						
<i>Order code for "Process connection", option ACS</i>						
DN [mm]	A [mm]	B [mm]	C [mm]	D [mm]	E [mm]	L [mm]
8 ¹⁾	95	66.7	4 × Ø15.7	20.6	13.9	261
15	95	66.7	4 × Ø15.7	20.6	13.9	295
25	125	88.9	4 × Ø19.1	23.9	24.3	380
40	155	114.3	4 × Ø22.4	28.7	38.1	496
50	165	127	8 × Ø19.1	31.8	49.2	583
80	210	168.3	8 × Ø22.4	38.2	73.7	671
Surface roughness (flange): Ra 3.2 to 6.3 µm						

1) DN 8 with DN 15 flanges as standard

Flange JIS B2220, 10K						
1.4404 (F316/F316L)						
<i>Order code for "Process connection", option NDS</i>						
DN [mm]	A [mm]	B [mm]	C [mm]	D [mm]	E [mm]	L [mm]
50	155	120	4 × Ø19	16	50	556
80	185	150	8 × Ø19	18	80	603
Surface roughness (flange): Ra 3.2 to 6.3 µm						

Flange JIS B2220, 20K						
1.4404 (F316/F316L)						
<i>Order code for "Process connection", option NES</i>						
DN [mm]	A [mm]	B [mm]	C [mm]	D [mm]	E [mm]	L [mm]
8 ¹⁾	95	70	4 × Ø15	14	15	232
15	95	70	4 × Ø15	14	15	279
25	125	90	4 × Ø19	16	25	329
40	140	105	4 × Ø19	18	40	445
50	155	120	8 × Ø19	18	50	556

Flange JIS B2220, 20K 1.4404 (F316/F316L) <i>Order code for "Process connection", option NES</i>						
DN [mm]	A [mm]	B [mm]	C [mm]	D [mm]	E [mm]	L [mm]
80	200	160	8 × Ø23	22	80	603
Surface roughness (flange): Ra 3.2 to 6.3 µm						

- 1) DN 8 with DN 15 flanges as standard

Flange JIS B2220, 40K 1.4404 (F316/F316L) <i>Order code for "Process connection", option NGS</i>						
DN [mm]	A [mm]	B [mm]	C [mm]	D [mm]	E [mm]	L [mm]
8 ¹⁾	115	80	4 × Ø19	20	15	261
15	115	80	4 × Ø19	20	15	300
25	130	95	4 × Ø19	22	25	375
40	160	120	4 × Ø23	24	38	496
50	165	130	8 × Ø19	26	50	601
80	210	170	8 × Ø23	32	75	661
Surface roughness (flange): Ra 3.2 to 6.3 µm						

- 1) DN 8 with DN 15 flanges as standard

Flange JIS B2220, 63K 1.4404 (F316/F316L) <i>Order code for "Process connection", option NHS</i>						
DN [mm]	A [mm]	B [mm]	C [mm]	D [mm]	E [mm]	L [mm]
8 ¹⁾	120	85	4 × Ø19	23	12	282
15	120	85	4 × Ø19	23	12	315
25	140	100	4 × Ø23	27	22	383
40	175	130	4 × Ø25	32	35	515
50	185	145	4 × Ø23	34	48	616
80	230	185	4 × Ø25	40	73	686
Surface roughness (flange): Ra 3.2 to 6.3 µm						

- 1) DN 8 with DN 15 flanges as standard

Fixed flange DIN 11864-2

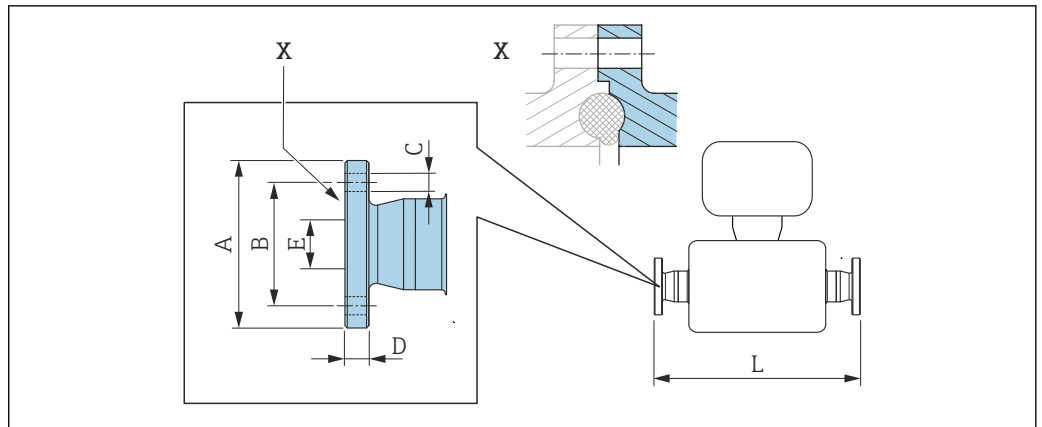

A0015627

27 Detail X: Asymmetrical process connection; the part shown in blue is provided by the supplier.

i Length tolerance for dimension L in mm:
+1.5/-2.0

Flange DIN11864-2 Form A, for pipe according to DIN11866 series A, flange with notch 1.4404 (316/316L)

Order code for "Process connection", option KCS

DN [mm]	A [mm]	B [mm]	C [mm]	D [mm]	E [mm]	L [mm]
8 ¹⁾	54	37	4 × Ø9	10	10	249
15	59	42	4 × Ø9	10	16	293
25	70	53	4 × Ø9	10	26	344
40	82	65	4 × Ø9	10	38	456
50	94	77	4 × Ø9	10	50	562
80	133	112	8 × Ø11	12	81	671

3-A version available: order code for "Additional approval", option LP in conjunction with
 Ra ≤ 0.76 µm: order code for "Measuring tube material", option SB, SJ
 Ra ≤ 0.38 µm: order code for "Measuring tube material", option SC, SK

1) DN 8 with DN 10 flanges as standard

Clamp connections

Tri-Clamp

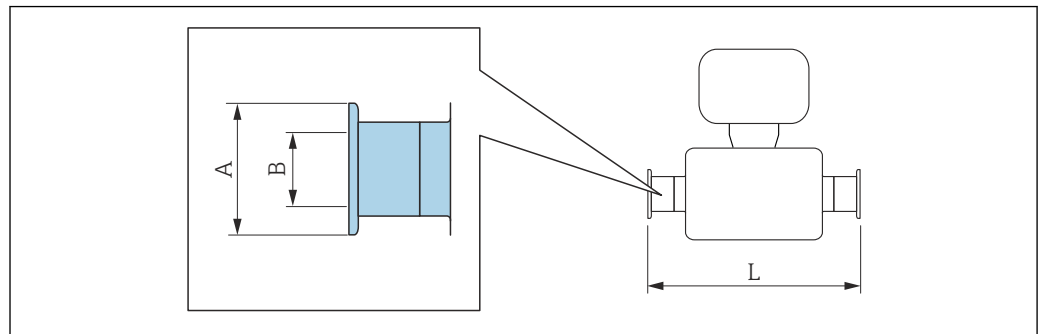

A0015625

i Length tolerance for dimension L in mm:
+1.5/-2.0

Tri-Clamp ($\frac{1}{2}$ "), for pipe according to DIN 11866 series C 1.4404 (316/316L)

Order code for "Process connection", option FDW

DN [mm]	Clamp [in]	A [mm]	B [mm]	L [mm]
8	$\frac{1}{2}$	25.0	9.5	229
15	$\frac{1}{2}$	25.0	9.5	273

3-A version available: order code for "Additional approval", option LP in conjunction with
 $Ra \leq 0.76 \mu\text{m}$: order code for "Measuring tube material", option SB, SJ
 $Ra \leq 0.38 \mu\text{m}$: order code for "Measuring tube material", option SC, SK

Tri-Clamp (≥ 1 "), for pipe according to DIN 11866 series C 1.4404 (316/316L)

Order code for "Process connection", option FTS

DN [mm]	Clamp [in]	A [mm]	B [mm]	L [mm]
8	1	50.4	22.1	229
15	1	50.4	22.1	273
25	1	50.4	22.1	324
40	$1\frac{1}{2}$	50.4	34.8	456
50	2	63.9	47.5	562
80	3	90.9	72.9	671

3-A version available: order code for "Additional approval", option LP in conjunction with
 $Ra \leq 0.76 \mu\text{m}$: order code for "Measuring tube material", option SB, SJ
 $Ra \leq 0.38 \mu\text{m}$: order code for "Measuring tube material", option SC, SK

Threaded couplings

Threaded adapter DIN 11851, DIN11864-1, SMS 1145

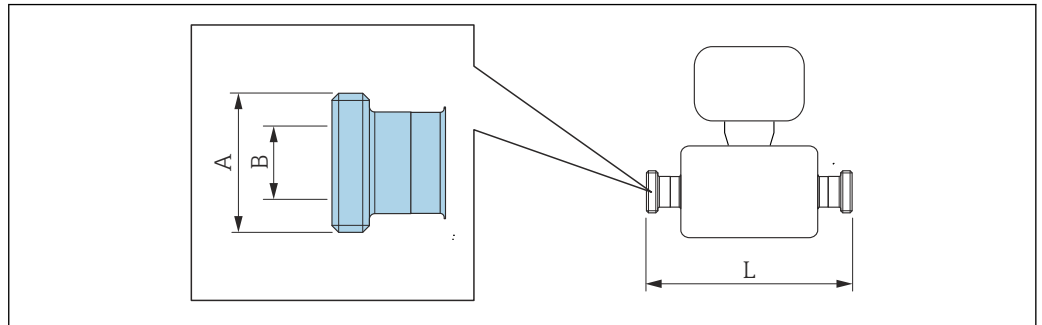

A0015628

i Length tolerance for dimension L in mm:
+1.5/-2.0

Threaded adapter DIN 11851, for pipe according to DIN11866 series A			
1.4404 (316/316L)			
<i>Order code for "Process connection", option FMW</i>			
DN [mm]	A [in]	B [mm]	L [mm]
8	Rd 34 × 1/8	16	229
15	Rd 34 × 1/8	16	273
25	Rd 52 × 1/6	26	324
40	Rd 65 × 1/6	38	456
50	Rd 78 × 1/6	50	562
80	Rd 110 × 1/4	81	671

3-A version available: order code for "Additional approval", option LP in conjunction with
 Ra ≤ 0.76 µm: order code for "Measuring tube material", option SB, SJ
 Ra ≤ 0.38 µm: order code for "Measuring tube material", option SC, SK

Threaded adapter DIN11864-1 Form A, for pipe according to DIN11866 series A			
1.4404 (316/316L)			
<i>Order code for "Process connection", option FLW</i>			
DN [mm]	A [in]	B [mm]	L [mm]
8	Rd 28 × 1/8	10	229
15	Rd 34 × 1/8	16	273
25	Rd 52 × 1/6	26	324
40	Rd 65 × 1/6	38	456
50	Rd 78 × 1/6	50	562
80	Rd 110 × 1/4	81	671

3-A version available: order code for "Additional approval", option LP in conjunction with
 Ra ≤ 0.76 µm: order code for "Measuring tube material", option SB, SJ
 Ra ≤ 0.38 µm: order code for "Measuring tube material", option SC, SK

Threaded adapter SMS 1145 1.4404 (316/316L) <i>Order code for "Process connection", option SCS</i>			
DN [mm]	A [in]	B [mm]	L [mm]
8	Rd 40 × 1/6	22.5	229
15	Rd 40 × 1/6	22.5	273
25	Rd 40 × 1/6	22.5	324
40	Rd 60 × 1/6	35.5	456
50	Rd 70 × 1/6	48.5	562
80	Rd 98 × 1/6	72.9	671
3-A version available: order code for "Additional approval", option LP in conjunction with Ra ≤ 0.76 µm: order code for "Measuring tube material", option SB, SJ Ra ≤ 0.38 µm: order code for "Measuring tube material", option SC, SK			

Threaded adapter ISO 2853

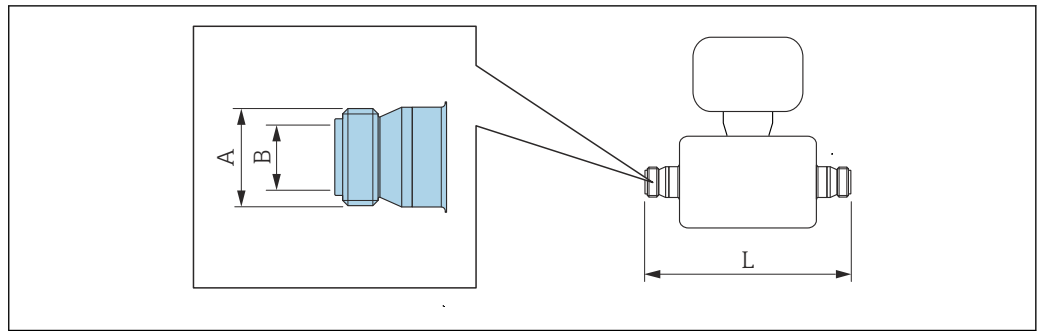

A0015623

 Length tolerance for dimension L in mm:
+1.5/-2.0

Threaded adapter ISO 2853, for pipe according to ISO 2037 1.4404 (316/316L) Order code for "Process connection", option JSF			
DN [mm]	A ¹⁾ [mm]	B [mm]	L [mm]
8	37.13	22.6	229
15	37.13	22.6	273
25	37.13	22.6	324
40	50.68	35.6	456
50	64.16	48.6	562
80	91.19	72.9	671

3-A version available: order code for "Additional approval", option LP in conjunction with
 Ra ≤ 0.76 µm: order code for "Measuring tube material", option SB, SJ
 Ra ≤ 0.38 µm: order code for "Measuring tube material", option SC, SK

1) Max. thread diameter according to ISO 2853 Annex A

VCO

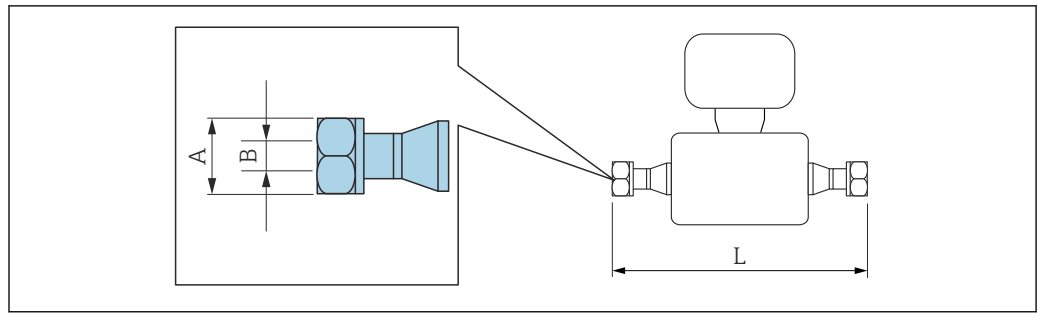

A0015624

i Length tolerance for dimension L in mm:
+1.5/-2.0

8-VCO-4 (1/2") 1.4404 (316/316L) Order code for "Process connection", option CVS			
DN [mm]	A [in]	B [mm]	L [mm]
8	AF 1	10.2	252

12-VCO-4 (3/4") 1.4404 (316/316L) Order code for "Process connection", option CWS			
DN [mm]	A [in]	B [mm]	L [mm]
15	AF 1½	15.7	305

Safety Barrier Promass 100

Top-hat rail EN 60715:

- TH 35 x 7.5
- TH 35 x 15

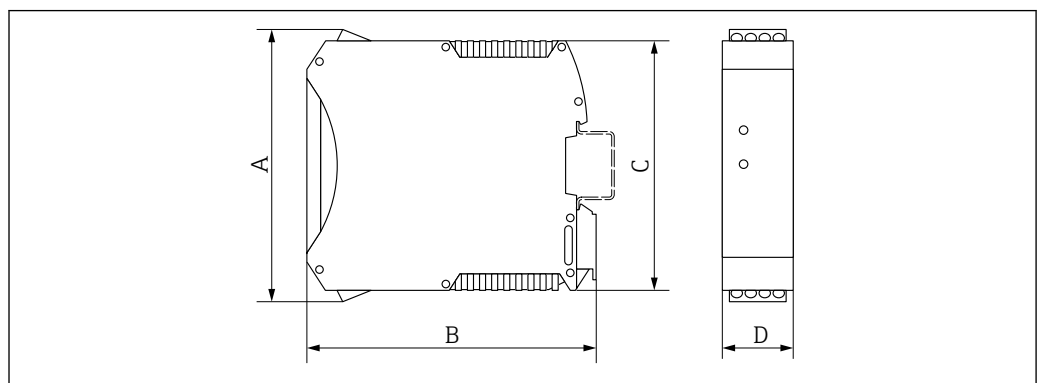

A0016777

A [mm]	B [mm]	C [mm]	D [mm]
108	114.5	99	22.5

Dimensions in US units

Compact version

Order code for "Housing", option A "Compact coated aluminum"

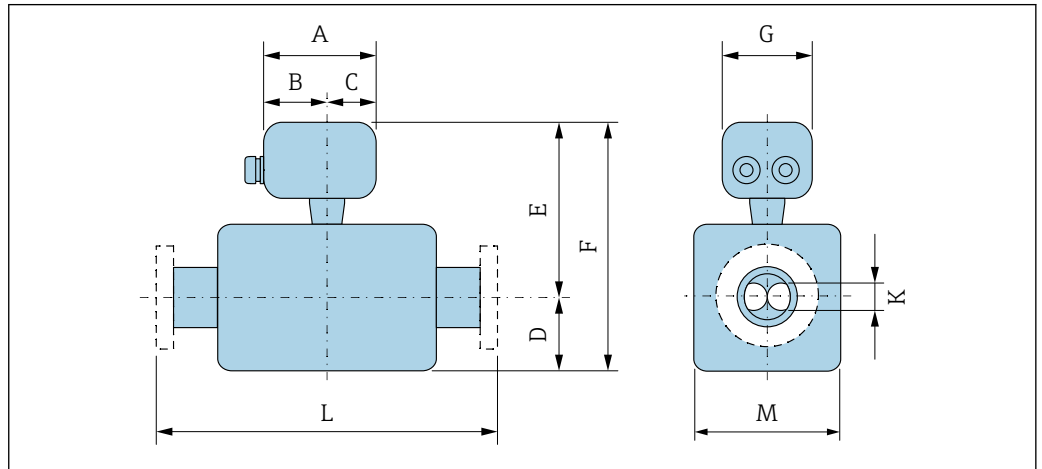

A0033787

DN [in]	A [in]	B [in]	C [in]	D [in]	E ¹⁾ [in]	F ¹⁾ [in]	G [in]	K [in]	L [in]	M [in]
3/8	5.81	3.68	2.13	3.66	7.05	10.71	5.35	0.21	²⁾	1.77
1/2	5.81	3.68	2.13	4.13	7.13	11.26	5.35	0.33	²⁾	1.77
1	5.81	3.68	2.13	4.17	7.32	11.5	5.35	0.47	²⁾	2.01
1 1/2	5.81	3.68	2.13	4.76	7.56	12.32	5.35	0.69	²⁾	2.53
2	5.81	3.68	2.13	6.67	8.19	14.86	5.35	1.02	²⁾	3.59
3	5.81	3.68	2.13	8.07	8.41	16.48	5.35	1.59	²⁾	5

- 1) If using a display, order code for "Display; operation", option B: values +1.1 in
- 2) Depends on the particular process connection

Order code for "Housing", option B "Compact, hygienic, stainless"

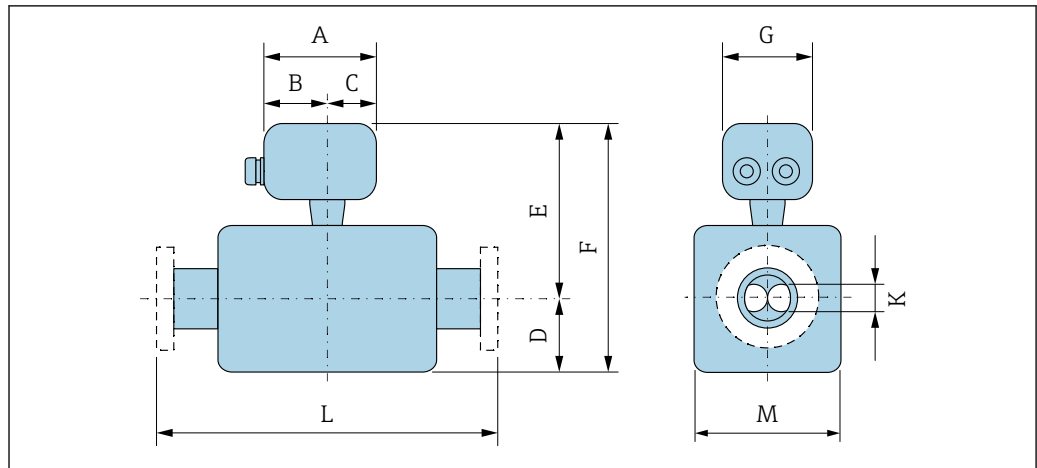

A0033787

DN [in]	A [in]	B [in]	C [in]	D [in]	E ¹⁾ [in]	F ¹⁾ [in]	G [in]	K [in]	L [in]	M [in]
3/8	5.39	3.07	2.31	3.66	6.85	10.51	5.26	0.21	²⁾	1.77
1/2	5.39	3.07	2.31	4.13	6.93	11.06	5.26	0.33	²⁾	1.77
1	5.39	3.07	2.31	4.17	7.13	11.3	5.26	0.47	²⁾	2.01
1½	5.39	3.07	2.31	4.76	7.36	12.13	5.26	0.69	²⁾	2.53
2	5.39	3.07	2.31	6.67	7.99	14.67	5.26	1.02	²⁾	3.59
3	5.39	3.07	2.31	8.07	8.21	16.28	5.26	1.59	²⁾	5

- 1) If using a display, order code for "Display; operation", option B: values +0.55 in
 2) Depends on the particular process connection

Order code for "Housing", option C "Ultra compact hygienic, stainless"

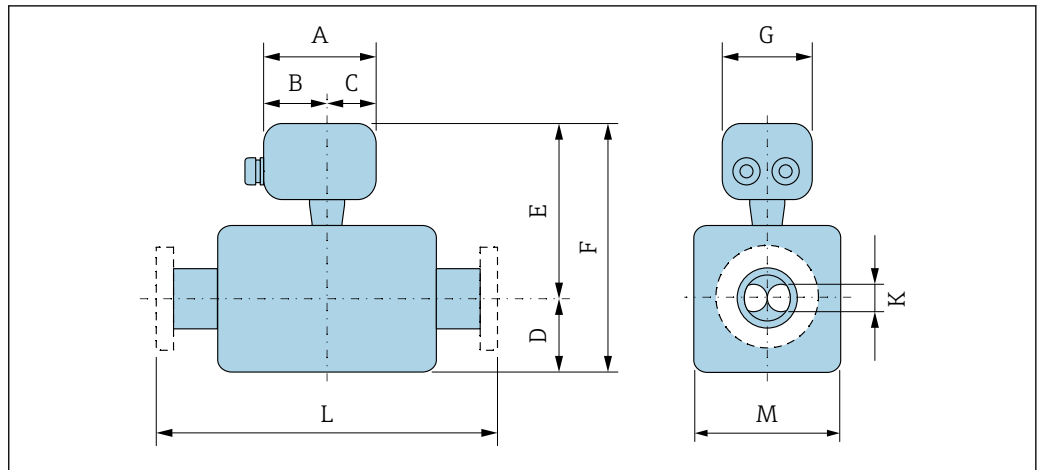

A0033787

DN [in]	A [in]	B [in]	C [in]	D [in]	E ¹⁾ [in]	F ¹⁾ [in]	G [in]	K [in]	L [in]	M [in]
3/8	4.87	2.67	2.2	3.66	6.85	10.51	4.39	0.21	²⁾	1.77
1/2	4.87	2.67	2.2	4.13	6.93	11.06	4.39	0.33	²⁾	1.77
1	4.87	2.67	2.2	4.17	7.13	11.3	4.39	0.47	²⁾	2.01
1 1/2	4.87	2.67	2.2	4.76	7.36	12.13	4.39	0.69	²⁾	2.53
2	4.87	2.67	2.2	6.67	7.99	14.67	4.39	1.02	²⁾	3.59
3	4.87	2.67	2.2	8.07	8.21	16.28	4.39	1.59	²⁾	5

- 1) If using a display, order code for "Display; operation", option B: values +0.55 in
- 2) Depends on the particular process connection

Flange connections

Fixed flange ASME B16.5

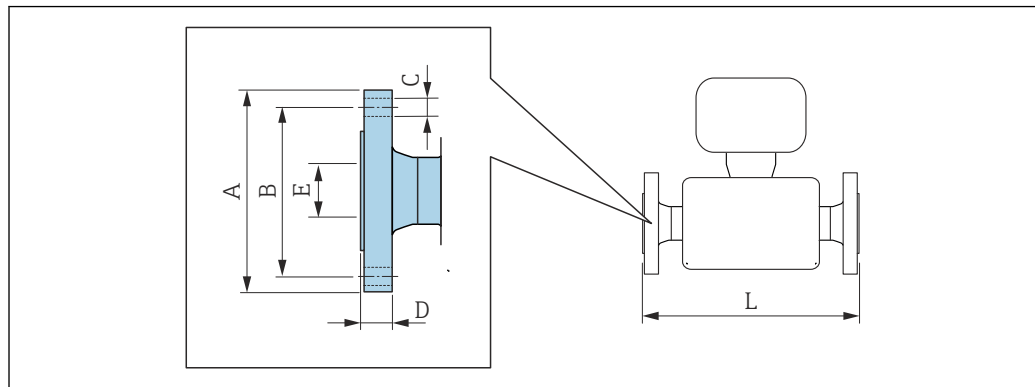

A0015621

i Length tolerance for dimension L in inches:
+0.06/-0.08

Flange similar to ASME B16.5, Cl 150 1.4404 (F316/F316L) Order code for "Process connection", option AAS						
DN [in]	A [in]	B [in]	C [in]	D [in]	E [in]	L [in]
$\frac{3}{8}$ ¹⁾	3.54	2.37	4 × Ø0.62	0.44	0.62	9.13
$\frac{1}{2}$	3.54	2.37	4 × Ø0.62	0.44	0.62	10.98
1	4.33	3.13	4 × Ø0.62	0.56	1.05	12.95
1½	4.92	3.87	4 × Ø0.62	0.69	1.61	17.52
2	5.91	4.75	4 × Ø0.75	0.75	2.07	21.89
3	7.48	6.00	4 × Ø0.75	0.94	3.07	24.06

Surface roughness (flange): Ra 126 to 248 µin

1) DN $\frac{3}{8}$ " with DN $\frac{1}{2}$ " flanges as standard

Flange similar to ASME B16.5, Class 300 1.4404 (F316/F316L) Order code for "Process connection", option ABS						
DN [in]	A [in]	B [in]	C [in]	D [in]	E [in]	L [in]
$\frac{3}{8}$ ¹⁾	3.74	2.63	4 × Ø0.62	0.56	0.62	9.13
$\frac{1}{2}$	3.74	2.63	4 × Ø0.62	0.56	0.62	10.98
1	4.92	3.50	4 × Ø0.75	0.69	1.05	12.95
1½	6.10	4.50	4 × Ø0.88	0.81	1.61	17.52
2	6.50	5.00	8 × Ø0.75	0.88	2.07	21.89
3	8.27	6.63	8 × Ø0.88	1.12	3.07	24.06

Surface roughness (flange): Ra 126 to 248 µin

1) DN $\frac{3}{8}$ " with DN $\frac{1}{2}$ " flanges as standard

Flange similar to ASME B16.5, Class 600 1.4404 (F316/F316L) <i>Order code for "Process connection", option ACS</i>						
DN [in]	A [in]	B [in]	C [in]	D [in]	E [in]	L [in]
$\frac{3}{8}$ ¹⁾	3.74	2.63	4 × Ø0.62	0.81	0.55	10.28
$\frac{1}{2}$	3.74	2.63	4 × Ø0.62	0.81	0.55	11.61
1	4.92	3.50	4 × Ø0.75	0.94	0.96	14.96
1½	6.10	4.50	4 × Ø0.88	1.13	1.50	19.53
2	6.50	5.00	8 × Ø0.75	1.25	1.94	22.95
3	8.27	6.63	8 × Ø0.88	1.50	2.9	26.42
Surface roughness (flange): Ra 126 to 248 µin						

1) DN $\frac{3}{8}$ " with DN $\frac{1}{2}$ " flanges as standard

Clamp connections

Tri-Clamp

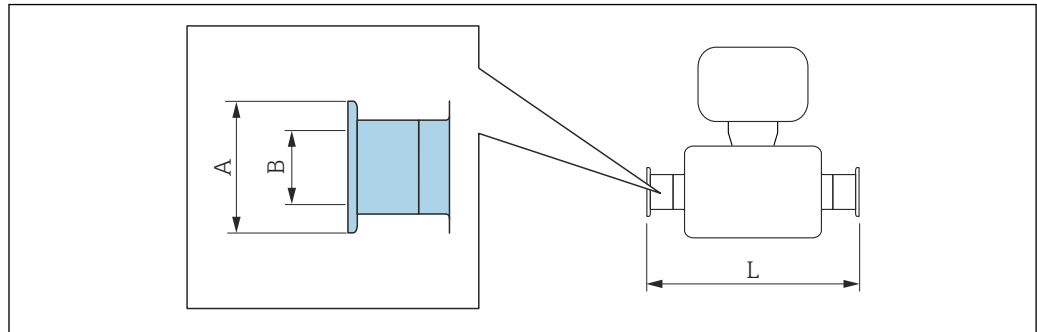

A0015625

i Length tolerance for dimension L in inches:
+0.06/-0.08

Tri-Clamp ($\frac{1}{2}$ "), DIN 11866 series C 1.4404 (316/316L)

Order code for "Process connection", option FDW

DN [in]	Clamp [in]	A [in]	B [in]	L [in]
$\frac{3}{8}$	$\frac{1}{2}$	0.98	0.37	9.02
$\frac{1}{2}$	$\frac{1}{2}$	0.98	0.37	10.75

3-A version available: order code for "Additional approval", option LP in conjunction with
 $R_a \leq 30 \mu\text{m}$: order code for "Measuring tube material", option SB, SJ
 $R_a \leq 15 \mu\text{m}$: order code for "Measuring tube material", option SC, SK

Tri-Clamp (≥ 1 "), DIN 11866 series C 1.4404 (316/316L)

Order code for "Process connection", option FTS

DN [in]	Clamp [in]	A [in]	B [in]	L [in]
$\frac{3}{8}$	1	1.98	0.87	9.02
$\frac{1}{2}$	1	1.98	0.87	10.75
1	1	1.98	0.87	12.76
$1\frac{1}{2}$	$1\frac{1}{2}$	1.98	1.37	17.95
2	2	2.52	1.87	22.13
3	3	3.58	2.87	26.42

3-A version available: order code for "Additional approval", option LP in conjunction with
 $R_a \leq 30 \mu\text{m}$: order code for "Measuring tube material", option SB, SJ
 $R_a \leq 15 \mu\text{m}$: order code for "Measuring tube material", option SC, SK

Threaded couplings

Threaded adapter SMS 1145

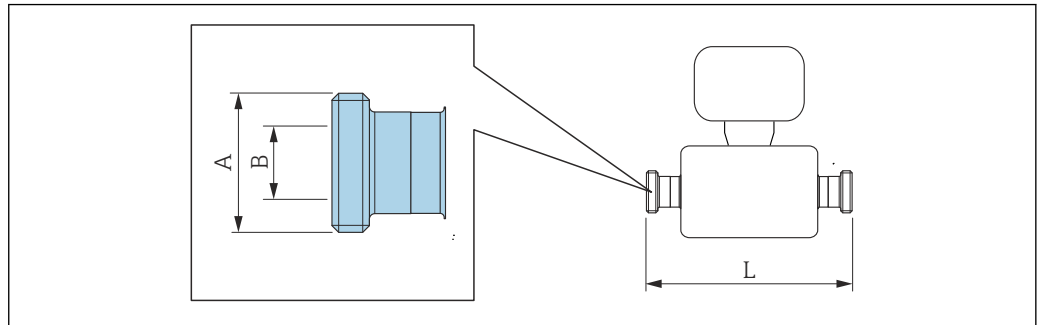

A0015628

i Length tolerance for dimension L in inches:
+0.06/-0.08

Threaded adapter SMS 1145 1.4404 (316/316L) <i>Order code for "Process connection", option SCS</i>			
DN [in]	A [in]	B [in]	L [in]
3/8	Rd 40 × 1/6	0.89	9.02
1/2	Rd 40 × 1/6	0.89	10.75
1	Rd 40 × 1/6	0.89	12.76
1 1/2	Rd 60 × 1/6	1.40	17.95
2	Rd 70 × 1/6	1.91	22.13
3	Rd 98 × 1/6	2.87	26.42

3-A version available: order code for "Additional approval", option LP in conjunction with
 Ra ≤ 30 µin: order code for "Measuring tube material", option SB, SJ
 Ra ≤ 15 µin: order code for "Measuring tube material", option SC, SK

VCO

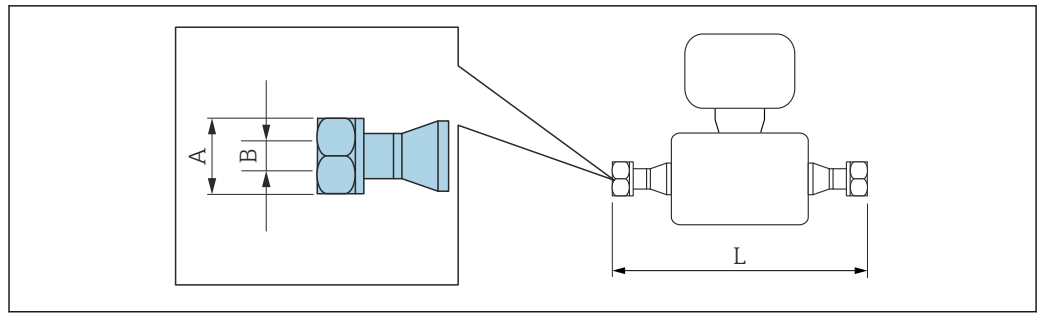

A0015624

i Length tolerance for dimension L in inches:
+0.06/-0.08

8-VCO-4 (1/2") 1.4404 (316/316L) Order code for "Process connection", option CVS			
DN [in]	A [in]	B [in]	L [in]
3/8	AF 1	0.40	9.92

12-VCO-4 (3/4") 1.4404 (316/316L) Order code for "Process connection", option CWS			
DN [in]	A [in]	B [in]	L [in]
1/2	AF 1 1/2	0.62	12.01

Safety Barrier Promass 100

Top-hat rail EN 60715:

- TH 35 x 7.5
- TH 35 x 15

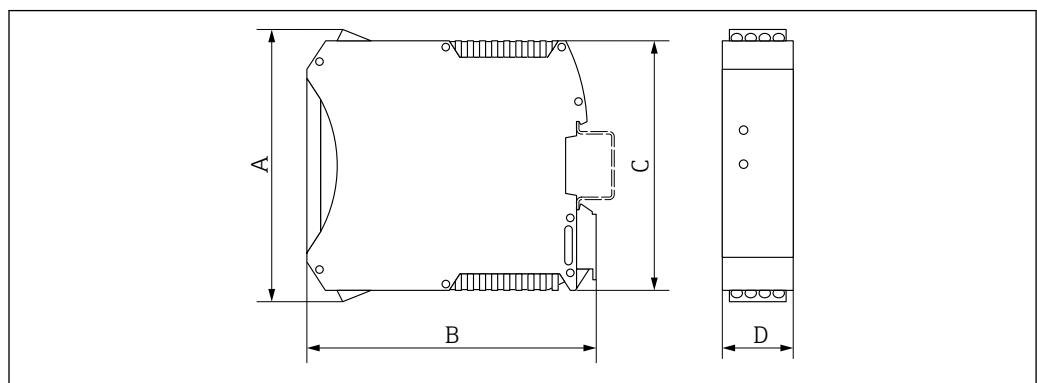

A0016777

A	B	C	D
[in]	[in]	[in]	[in]
4.25	4.51	3.9	0.89

Weight

All values (weight exclusive of packaging material) refer to devices with EN/DIN PN 40 flanges. Weight specifications including transmitter: order code for "Housing", option A "Compact, aluminum coated".

Weight in SI units

DN [mm]	Weight [kg]
8	4.5
15	4.8
25	6.4
40	10.4
50	15.5
80	29

Weight in US units

DN [in]	Weight [lbs]
3/8	10
1/2	11
1	14
1 1/2	23
2	34
3	64

Safety Barrier Promass 100

49 g (1.73 ounce)

Materials**Transmitter housing**

- Order code for "Housing", option **A** "Compact, aluminum coated":
Aluminum, AlSi10Mg, coated
- Order code for "Housing", option **B** "Compact, hygienic, stainless":
Hygienic version, stainless steel 1.4301 (304)
- Order code for "Housing", option **C** "Ultra-compact, hygienic, stainless":
Hygienic version, stainless steel 1.4301 (304)
- Window material for optional local display (→  78):
 - For order code for "Housing", option **A**: glass
 - For order code for "Housing", option **B** and **C**: plastic

Cable entries/cable glands

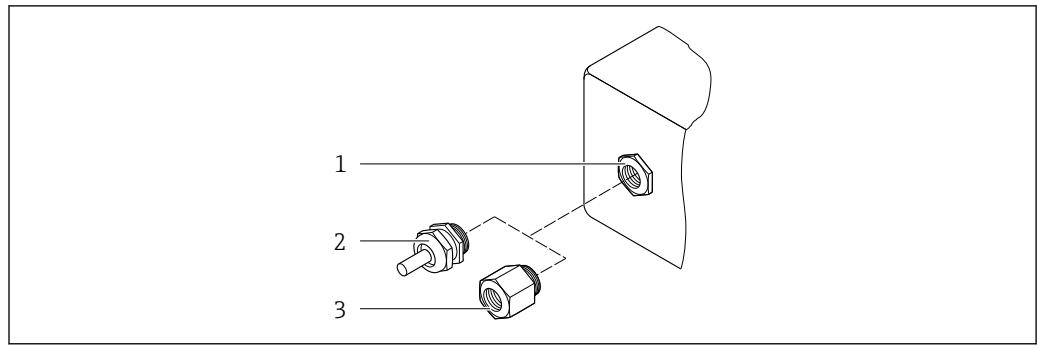

A0020640

28 Possible cable entries/cable glands

- 1 Internal thread M20 × 1.5
- 2 Cable gland M20 × 1.5
- 3 Adapter for cable entry with internal thread G ½" or NPT ½"

Order code for "Housing", option A "Compact, aluminum, coated"

The various cable entries are suitable for hazardous and non-hazardous areas.

Cable entry/cable gland	Material
Cable gland M20 × 1.5	Nickel-plated brass
Adapter for cable entry with female thread G ½"	
Adapter for cable entry with female thread NPT ½"	

Order code for "Housing", option B "Compact, hygienic, stainless"

The various cable entries are suitable for hazardous and non-hazardous areas.

Cable entry/cable gland	Material
Cable gland M20 × 1.5	Stainless steel, 1.4404 (316L)
Adapter for cable entry with female thread G ½"	
Adapter for cable entry with female thread NPT ½"	

Device plug

Electrical connection	Material
Plug M12x1	<ul style="list-style-type: none"> ▪ Socket: Stainless steel, 1.4404 (316L) ▪ Contact housing: Polyamide ▪ Contacts: Gold-plated brass

Sensor housing

- Acid and alkali-resistant outer surface
- Stainless steel 1.4301 (304)

Measuring tubes

Stainless steel, 1.4539 (904L); manifold: stainless steel, 1.4404 (316L)

Process connections

- Flanges similar to EN 1092-1 (DIN2501) / similar to ASME B 16.5 / as per JIS B2220: Stainless steel, 1.4404 (F316/F316L)
- All other process connections: Stainless steel, 1.4404 (316/316L)



Available process connections → 77

Seals

Welded process connections without internal seals

Accessories

Safety Barrier Promass 100

Housing: Polyamide

Process connections

- Fixed flange connections:
 - EN 1092-1 (DIN 2501) flange
 - EN 1092-1 (DIN 2512N) flange
 - NAMUR lengths in accordance with NE 132
 - ASME B16.5 flange
 - JIS B2220 flange
 - DIN 11864-2 Form A flange, DIN 11866 series A, flange with notch
- Clamp connections: Tri-Clamp (OD tubes), DIN 11866 series C
- Thread:
 - DIN 11851 thread, DIN 11866 series A
 - SMS 1145 thread
 - ISO 2853 thread, ISO 2037
 - DIN 11864-1 Form A thread, DIN 11866 series A
- VCO connections:
 - 8-VCO-4
 - 12-VCO-4



Process connection materials → 75

Surface roughness

All data relate to parts in contact with medium.

The following surface roughness categories can be ordered:

Category	Method	Option(s)/Order code "Measuring tube mat., wetted surface"
Not polished	–	SA
Ra ≤ 0.76 µm (30 µin) ¹⁾	Mechanically polished ²⁾	SB
Ra ≤ 0.76 µm (30 µin) ¹⁾	Mechanically polished ²⁾ , welds in as-welded condition	SJ
Ra ≤ 0.38 µm (15 µin) ¹⁾	Mechanically polished ²⁾	SC
Ra ≤ 0.38 µm (15 µin) ¹⁾	Mechanically polished ²⁾ , welds in as-welded condition	SK

1) Ra according to ISO 21920

2) Inaccessible weld seams between pipe and manifold are excluded

Operability

Operating concept

Operator-oriented menu structure for user-specific tasks

- Commissioning
- Operation
- Diagnostics
- Expert level

Fast and safe commissioning

- Individual menus for applications
- Menu guidance with brief descriptions of the individual parameter functions

Reliable operation

- Operation in the following languages:
 - Via "FieldCare", "DeviceCare" operating tool:
English, German, French, Spanish, Italian, Chinese, Japanese
 - Via integrated web browser (only available for device versions with HART, PROFIBUS DP, PROFINET and EtherNet/IP):
English, German, French, Spanish, Italian, Dutch, Portuguese, Polish, Russian, Turkish, Chinese, Japanese, Bahasa (Indonesian), Vietnamese, Czech, Swedish, Korean
- Uniform operating philosophy applied to operating tools and web browser
- If replacing the electronic module, transfer the device configuration via the plug-in memory (HistoROM DAT) which contains the process and measuring instrument data and the event logbook. No need to reconfigure.
For devices with Modbus RS485, the data recovery function is implemented without the plug-in memory (HistoROM DAT).

Efficient diagnostic behavior increases measurement reliability

- Remedial action can be called up via the operating tools and web browser
- Diverse simulation options
- Status indicated by several light emitting diodes (LEDs) on the electronic module in the housing compartment

Local display



A local display is only available for device versions with the following communication protocols: HART, PROFIBUS-DP, PROFINET, EtherNet/IP

The local display is only available with the following device order code:

Order code for "Display; operation", option **B**: 4-line; illuminated, via communication

Display element

- 4-line liquid crystal display with 16 characters per line.
- White background lighting; switches to red in event of device errors.
- Format for displaying measured variables and status variables can be individually configured.
- Permitted ambient temperature for the display: -20 to +60 °C (-4 to +140 °F). The readability of the display may be impaired at temperatures outside the temperature range.

Remote operation

Via HART protocol

This communication interface is available in device versions with a HART output.

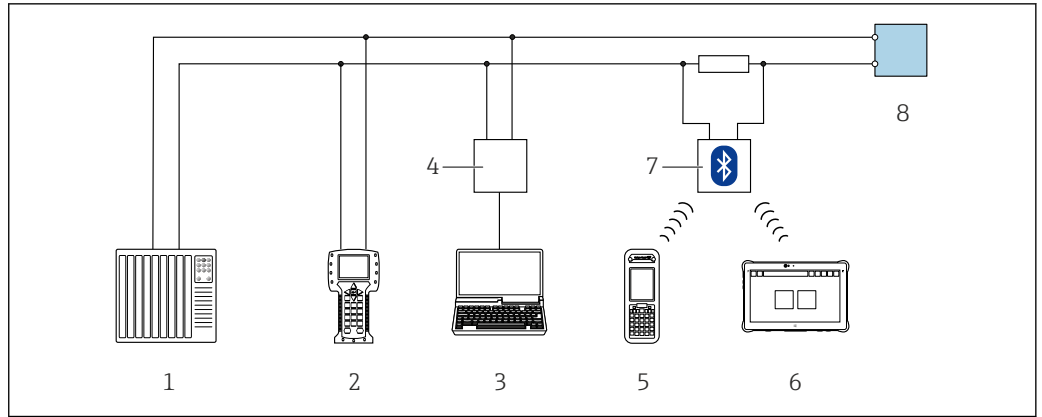

A0028747

29 Options for remote operation via HART protocol

- 1 Automation system (e.g. PLC)
- 2 Field Communicator 475
- 3 Computer with operating tool (e.g. FieldCare, AMS Device Manager, SIMATIC PDM)
- 4 Commubox FXA195 (USB)
- 5 Field Xpert SFX350 or SFX370
- 6 Field Xpert SMT70
- 7 VIATOR Bluetooth modem with connecting cable
- 8 Transmitter

Via PROFIBUS DP network

This communication interface is available in device versions with PROFIBUS DP.

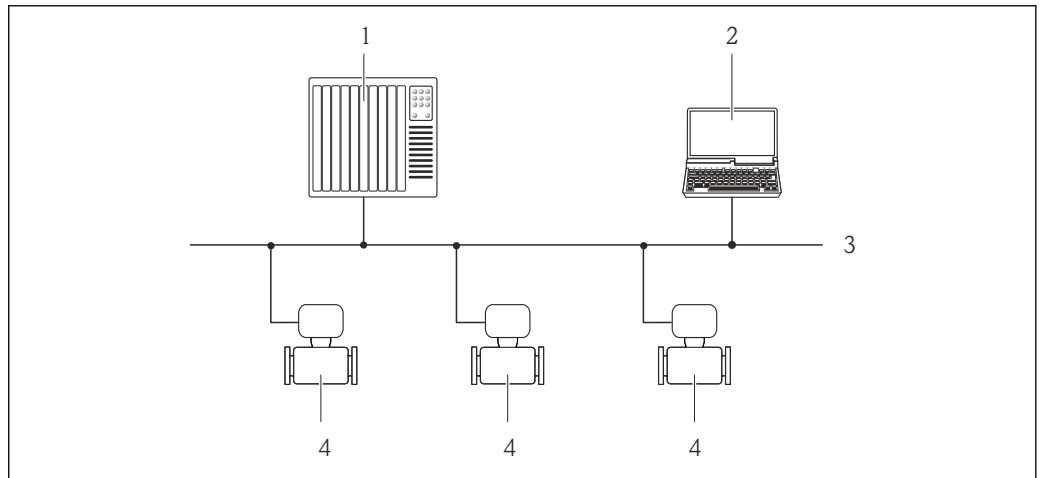

A0020903

30 Options for remote operation via PROFIBUS DP network

- 1 Automation system
- 2 Computer with PROFIBUS network card
- 3 PROFIBUS DP network
- 4 Measuring instrument

Via EtherNet/IP network

This communication interface is available in device versions with EtherNet/IP.

Star topology

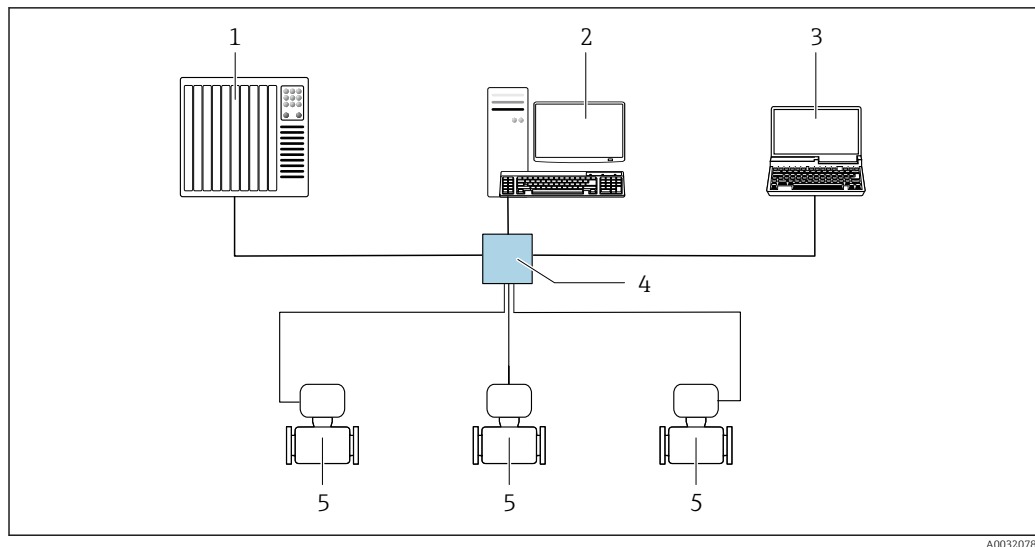

A0032078

31 Options for remote operation via Ethernet/IP network: star topology

- 1 Automation system, z. B. "RSLogix" (Rockwell Automation)
- 2 Workstation for measuring instrument operation: with Custom Add-On Profile for "RSLogix 5000" (Rockwell Automation) or with Electronic Data Sheet (EDS)
- 3 Computer with web browser for accessing the integrated web server or computer with operating tool (e.g. FieldCare, DeviceCare) with COM DTM "CDI Communication TCP/IP"
- 4 Standard Ethernet switch, e.g. Scalance X204 (Siemens)
- 5 Measuring instrument

Via PROFINET network

This communication interface is available in device versions with PROFINET.

Star topology

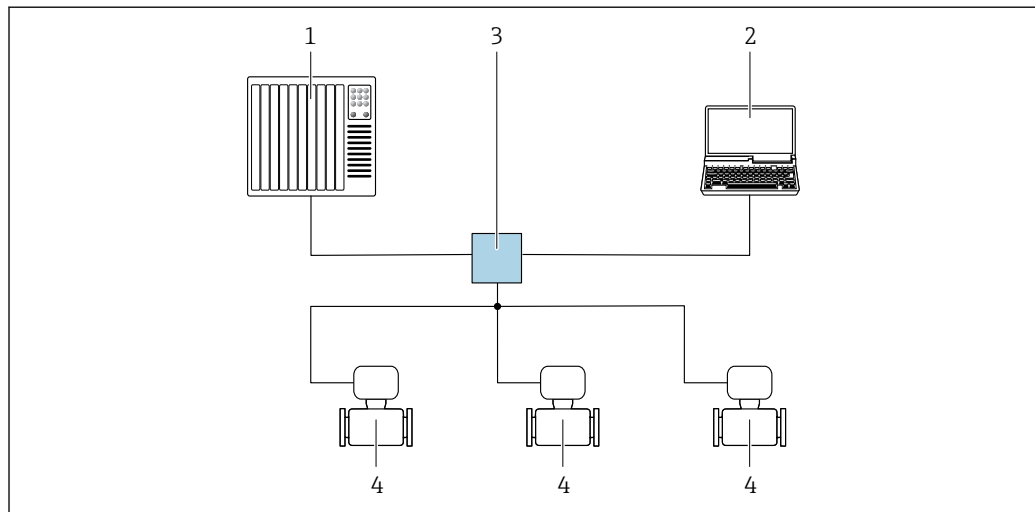

A0026545

32 Options for remote operation via PROFINET network: star topology

- 1 Automation system, e.g. Simatic S7 (Siemens)
- 2 Computer with web browser for accessing integrated web server or computer with operating tool (e.g. FieldCare, DeviceCare, SIMATIC PDM) with COM DTM "CDI Communication TCP/IP"
- 3 Standard Ethernet switch, e.g. Scalance X204 (Siemens)
- 4 Measuring instrument

Service interface

Via service interface (CDI-RJ45)

This communication interface is present in the following device version:

- Order code for "Output", option **B**: 4-20 mA HART, pulse/frequency/switch output
- Order code for "Output", option **L**: PROFIBUS DP
- Order code for "Output", option **N**: Ethernet/IP
- Order code for "Output", option **R**: PROFINET

HART

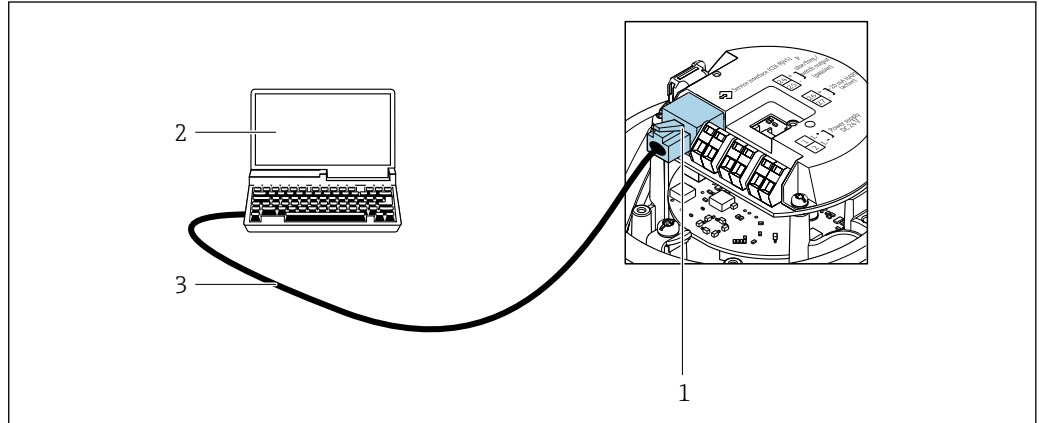

A0016926

33 Connection for the order code for "Output", option B: 4-20 mA HART, pulse/frequency/switch output

- 1 Service interface (CDI-RJ45) of the measuring instrument with access to the integrated web server
- 2 Computer with web browser for accessing the integrated web server or with FieldCare operating tool with COM DTM "CDI Communication TCP/IP"
- 3 Standard Ethernet connecting cable with RJ45 plug

PROFIBUS DP

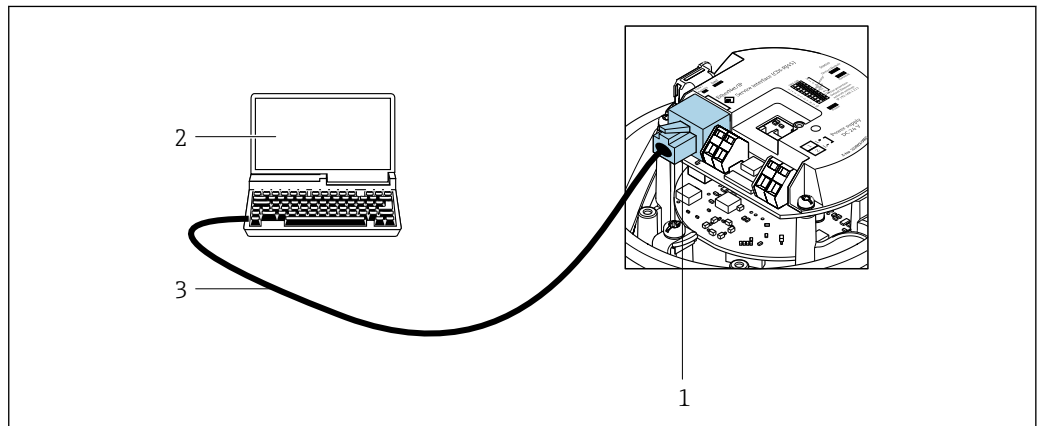

A0021270

34 Connection for order code for "Output", option L: PROFIBUS DP

- 1 Service interface (CDI-RJ45) of the measuring instrument with access to the integrated web server
- 2 Computer with web browser for accessing the integrated web server or with FieldCare operating tool with COM DTM "CDI Communication TCP/IP"
- 3 Standard Ethernet connecting cable with RJ45 plug

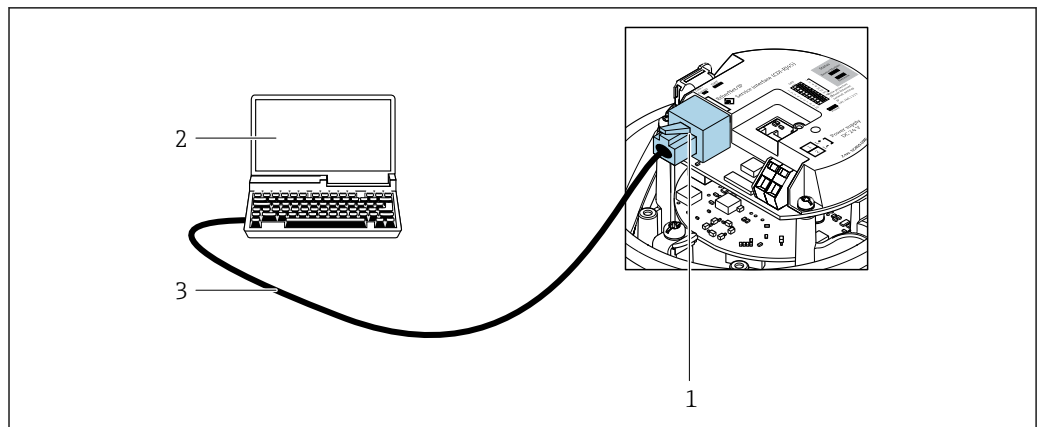
EtherNet/IP

A0016940

35 Connection for order code for "Output", option N: EtherNet/IP

- 1 Service interface (CDI-RJ45) and EtherNet/IP interface of the measuring instrument with access to the integrated web server
- 2 Computer with web browser for accessing the integrated web server or with FieldCare operating tool with COM DTM "CDI Communication TCP/IP"
- 3 Standard Ethernet connecting cable with RJ45 plug

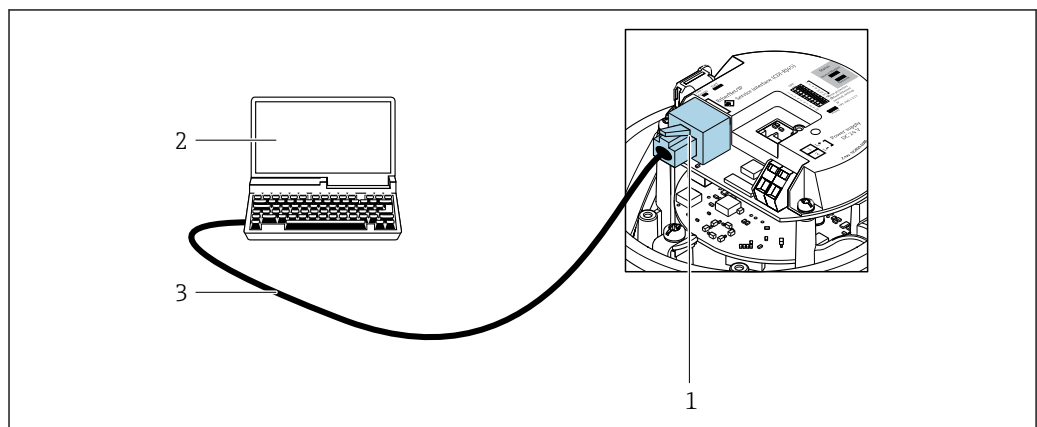
PROFINET

A0016940

36 Connection for order code for "Output", option R: PROFINET

- 1 Service interface (CDI-RJ45) and PROFINET interface of the measuring instrument with access to the integrated web server
- 2 Computer with web browser for accessing the integrated web server or with FieldCare operating tool with COM DTM "CDI Communication TCP/IP"
- 3 Standard Ethernet connecting cable with RJ45 plug

Via service interface (CDI)

This communication interface is present in the following device version:
 Order code for "Output", option **M**: Modbus RS485

Modbus RS485

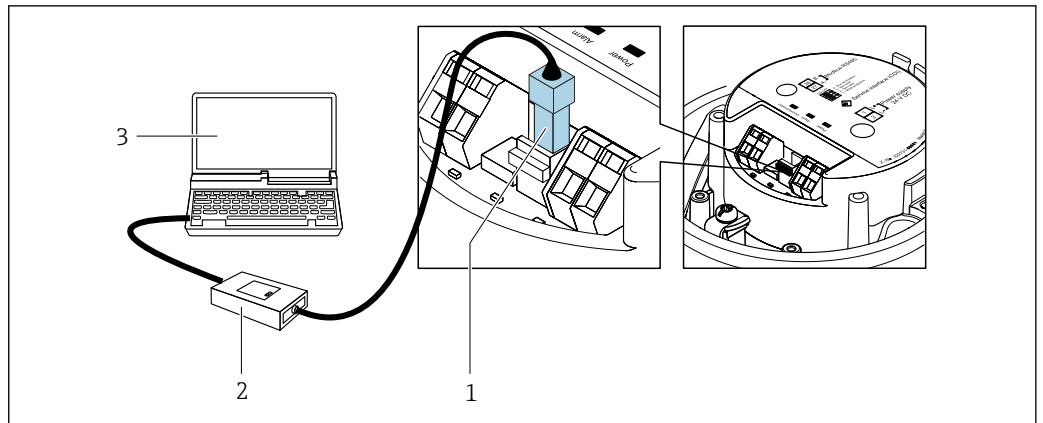

A0030216

- 1 Service interface (CDI) of the measuring instrument
- 2 Commubox FXA291
- 3 Computer with FieldCare operating tool with COM DTM "CDI Communication FXA291"

Certificates and approvals

Current certificates and approvals for the product are available at www.endress.com on the relevant product page:

1. Select the product using the filters and search field.
2. Open the product page.
3. Select **Downloads**.

CE mark

The device meets the legal requirements of the applicable EU Directives. These are listed in the corresponding EU Declaration of Conformity along with the standards applied.

Endress+Hauser confirms successful testing of the device by affixing to it the CE mark.

UKCA marking

The device meets the legal requirements of the applicable UK regulations (Statutory Instruments). These are listed in the UKCA Declaration of Conformity along with the designated standards. By selecting the order option for UKCA marking, Endress+Hauser confirms a successful evaluation and testing of the device by affixing the UKCA mark.

Contact address Endress+Hauser UK:

Endress+Hauser Ltd.
Floats Road
Manchester M23 9NF
United Kingdom
www.uk.endress.com

RCM marking

The measuring system meets the EMC requirements of the "Australian Communications and Media Authority (ACMA)".

Ex approval

The measuring device is certified for use in hazardous areas and the relevant safety instructions are provided in the separate "Safety Instructions" (XA) document. Reference is made to this document on the nameplate.



The separate Ex documentation (XA) containing all the relevant explosion protection data is available from your Endress+Hauser sales center.

Hygienic compatibility

- 3-A approval
 - Only measuring instruments with the order code for "Additional approval", option LP "3A" have 3-A approval.
 - The 3-A approval refers to the measuring instrument.
 - When installing the measuring instrument, ensure that no liquid can accumulate on the outside of the measuring instrument.
A remote display module must be installed in accordance with the 3-A Standard.
 - Accessories (e.g. heating jacket, weather protection cover, wall holder unit) must be installed in accordance with the 3-A Standard.
Each accessory can be cleaned. Disassembly may be necessary under certain circumstances.
- EHEDG-tested (Type EL Class I)
Only devices with the order code for "Additional approval", option LT "EHEDG" have been tested and meet the requirements of the EHEDG.
To meet the requirements for EHEDG certification, the device must be used with process connections in accordance with the EHEDG position paper entitled "Easy cleanable Pipe couplings and Process connections" (www.ehedg.org).
To meet the requirements for EHEDG certification, the orientation of the device must ensure drainability.
Test criteria for cleanability according to EHEDG is a flow velocity of 1.5 m/s in the process line. This speed must be ensured for EHEDG-compliant cleaning.
- FDA CFR 21
- Food Contact Materials Regulation (EC) 1935/2004
- Food Contact Materials Regulation GB 4806
- The requirements of the Food Contact Material regulations must be observed when selecting the material versions.



Observe special installation instructions

Pharmaceutical compatibility

- FDA 21 CFR 177
- USP <87>
- USP <88> Class VI 121 °C
- TSE/BSE Certificate of Suitability
- cGMP
Devices with the order code for "Test, certificate", option JG "Conformity with cGMP-derived requirements, declaration" comply with the requirements of cGMP with regard to the surfaces of parts in contact with the medium, design, FDA 21 CFR material conformity, USP Class VI tests and TSE/BSE conformity.
A serial number-specific declaration is generated.

HART certification**HART interface**

The measuring device is certified and registered by the FieldComm Group. The measuring system meets all the requirements of the following specifications:

- Certified according to HART 7
- The device can also be operated with certified devices of other manufacturers (interoperability)

Certification PROFIBUS**PROFIBUS interface**

The measuring device is certified and registered by the PNO (PROFIBUS Nutzerorganisation e.V./ PROFIBUS User Organization). The measuring system meets all the requirements of the following specifications:

- Certified according to PA Profile 3.02
- The device can also be operated with certified devices of other manufacturers (interoperability)

Certification PROFINET**PROFINET interface**

The measuring instrument is certified and registered by the PROFIBUS Nutzerorganisation e.V. (PNO). The measuring system meets all the requirements of the following specifications:

- Certified according to:
 - Test specification for PROFINET devices
 - PROFINET Netload Class 2 100 Mbit/s
- The device can also be operated with certified devices of other manufacturers (interoperability).
- The device supports PROFINET S2 system redundancy.

EtherNet/IP certification	<p>The measuring device is certified and registered by the ODVA (Open Device Vendor Association). The measuring system meets all the requirements of the following specifications:</p> <ul style="list-style-type: none"> ■ Certified in accordance with the ODVA Conformance Test ■ EtherNet/IP Performance Test ■ EtherNet/IP PlugFest compliance ■ The device can also be operated with certified devices of other manufacturers (interoperability)
Modbus RS485 certification	<p>The measuring instrument meets all the requirements of the MODBUS RS485 conformity test and has the "MODBUS RS485 Conformance Test Policy, Version 2.0". The measuring instrument has successfully passed all the test procedures carried out.</p>
Pressure Equipment Directive	<p>The measuring instruments can be ordered with or without PED or PESR. If a device with PED or PESR is required, this must be ordered explicitly. For devices with nominal diameters less than or equal to DN 25 (NPS 1"), this is neither possible nor necessary. A UK order option must be selected for PESR under the order code for "Approvals".</p> <ul style="list-style-type: none"> ■ With the marking <ul style="list-style-type: none"> a) PED/G1/x (x = category) or b) PESR/G1/x (x = category) <p>on the sensor nameplate, Endress+Hauser confirms compliance with the "Essential Safety Requirements"</p> <ul style="list-style-type: none"> a) specified in Annex I of the Pressure Equipment Directive 2014/68/EU or b) Schedule 2 of Statutory Instruments 2016 No. 1105. ■ Devices bearing this marking (PED or PESR) are suitable for the following types of medium: <ul style="list-style-type: none"> ■ Media in Group 1 and 2 with a vapor pressure greater than, or smaller and equal to 0.5 bar (7.3 psi) ■ Unstable gases ■ Devices not bearing this marking (without PED or PESR) are designed and manufactured according to sound engineering practice. They meet the requirements of <ul style="list-style-type: none"> a) Art. 4, Section 3 of the Pressure Equipment Directive 2014/68/EU or b) Part 1, Section 8 of Statutory Instruments 2016 No. 1105. <p>The scope of application is indicated</p> <ul style="list-style-type: none"> a) in diagrams 6 to 9 in Annex II of the Pressure Equipment Directive 2014/68/EU or b) in Schedule 3, Section 2 of Statutory Instruments 2016 No. 1105.
Additional certification	<p>CRN approval</p> <p>Some device versions have CRN approval. A CRN-approved process connection with a CSA approval must be ordered for a CRN-approved device.</p> <p>Tests and certificates</p> <ul style="list-style-type: none"> ■ EN10204-3.1 material certificate, wetted parts and sensor housing (order code for "Test, certificate", option JA) ■ Pressure test, internal process, test report (order code for "Test, certificate", option JB) ■ Surface roughness test ISO4287/Ra, (wetted parts), test report (option JE) ■ Compliance with requirements derived from cGMP, Declaration (option JG)
External standards and guidelines	<ul style="list-style-type: none"> ■ EN 60529 Degrees of protection provided by enclosure (IP code) ■ IEC/EN 60068-2-6 Environmental influences: Test procedure - Test Fc: vibrate (sinusoidal). ■ IEC/EN 60068-2-31 Environmental influences: Test procedure - Test Ec: shocks due to rough handling, primarily for devices. ■ EN 61010-1 Safety requirements for electrical equipment for measurement, control and laboratory use - general requirements ■ GB 30439.5 Safety requirements for industrial automation products - Part 5: Flowmeter safety requirements ■ EN 61326-1/-2-3 EMC requirements for electrical equipment for measurement, control and laboratory use ■ NAMUR NE 21 Electromagnetic compatibility (EMC) of industrial process and laboratory control equipment

- NAMUR NE 32
Data retention in the event of a power failure in field and control instruments with microprocessors
- NAMUR NE 43
Standardization of the signal level for the breakdown information of digital transmitters with analog output signal.
- NAMUR NE 53
Software of field devices and signal-processing devices with digital electronics
- NAMUR NE 80
The application of the pressure equipment directive to process control devices
- NAMUR NE 105
Specifications for integrating fieldbus devices in engineering tools for field devices
- NAMUR NE 107
Self-monitoring and diagnostics of field devices
- NAMUR NE 131
Requirements for field devices for standard applications
- NAMUR NE 132
Coriolis mass meter
- ETSI EN 300 328
Guidelines for 2.4 GHz radio components.
- EN 301489
Electromagnetic compatibility and radio spectrum matters (ERM).

Ordering information

Detailed ordering information is available from your nearest sales organization www.addresses.endress.com or in the Product Configurator at www.endress.com:

1. Select the product using the filters and search field.
2. Open the product page.
3. Select **Configuration**.

Product Configurator - the tool for individual product configuration

- Up-to-the-minute configuration data
- Depending on the device: direct input of information specific to the measuring point, such as the measuring range or operating language
- Automatic verification of exclusion criteria
- Automatic creation of the order code and its breakdown in PDF or Excel output format
- Ability to order directly in the Endress+Hauser Online Shop

Product generation index



Release date	Product root	Documentation
01.10.2017	8E1C	TI01351D

 More information is available from your Sales Center or at:
www.service.endress.com → Downloads

Application packages

Many different application packages are available to enhance the functionality of the device. Such packages might be needed to address safety aspects or specific application requirements.

The application packages can be ordered with the device or subsequently from Endress+Hauser. Detailed information on the order code in question is available from your local Endress+Hauser sales center or on the product page of the Endress+Hauser website: www.endress.com.

 Detailed information on the application packages:
Special Documentation →  90

Heartbeat Verification

Meets the requirement for traceable verification in accordance with DIN ISO 9001:2015 Clause 7.6 a) "Control of monitoring and measuring equipment".

- Functional testing in the installed state without interrupting the process.
- Traceable verification results on request, including a report.
- Simple testing process via local operation or other operating interfaces.
- Clear measuring point assessment (pass/fail) with high total test coverage within the framework of manufacturer specifications.
- Extension of calibration intervals according to operator's risk evaluation.

Heartbeat Monitoring

Continuously supplies data, which are characteristic of the measuring principle, to an external condition monitoring system for the purpose of preventive maintenance or process analysis. These data enable the operator to:

- Draw conclusions - using these data and other information - about the impact the process influences (e.g. corrosion, abrasion, deposit buildup etc.) have on measuring performance over time.
- Schedule servicing in time.
- Monitor the process or product quality, e.g. gas pockets.



Detailed information on Heartbeat Technology:
Special Documentation →  90

Concentration measurement

Order code for "Application package", option ED "Concentration"

Calculation and outputting of fluid concentrations.

The measured density is converted to the concentration of a substance of a binary mixture using the "Concentration" application package:

Concentration calculation from user-defined tables.

The measured values are output via the digital and analog outputs of the measuring instrument.



For detailed information, see the Special Documentation for the device.

Petroleum & locking function

Order code for "Application package", option EM "Petroleum & locking function"

The most important parameters for the Oil & Gas Industry can be calculated and displayed with this application package. It is also possible to lock the settings.

- Corrected volume flow and calculated reference density in accordance with the "API Manual of Petroleum Measurement Standards, Chapter 11.1"
- Water content, based on density measurement
- Weighted mean of the density and temperature



For detailed information, see the Special Documentation for the device.



Accessories

Various accessories, which can be ordered with the device or subsequently from Endress+Hauser, are available for the device. Detailed information on the order code in question is available from your local Endress+Hauser sales center or on the product page of the Endress+Hauser website:







www.endress.com.







Device-specific accessories

For the sensor



Accessories	Description
Heating jacket	<p>Is used to stabilize the temperature of the fluids in the sensor. Water, water vapor and other non-corrosive liquids are permitted for use as fluids.</p> <p> If using oil as a heating medium, please consult with Endress+Hauser.</p> <p>Heating jackets cannot be used with sensors fitted with a rupture disk.</p> <ul style="list-style-type: none"> ▪ If ordered together with the measuring device: Order code for "Accessory enclosed" <ul style="list-style-type: none"> ▪ Option RB "Heating jacket, G 1/2" female thread" ▪ Option RC "Heating jacket, G 3/4" female thread" ▪ Option RD "Heating jacket, NPT 1/2" female thread" ▪ Option RE "Heating jacket, NPT 3/4" female thread" ▪ If ordered subsequently: Use the order code with the product root DK8003. <p> Special Documentation SD02151D</p>

Communication-specific accessories



Accessories	Description
Commubox FXA195 HART	<p>For intrinsically safe HART communication with FieldCare via the USB interface.</p> <p> Technical Information TI00404F</p>
Commubox FXA291	<p>Connects Endress+Hauser field devices with a CDI interface (= Endress+Hauser Common Data Interface) and the USB port of a computer or laptop.</p> <p> Technical Information TI00405C</p>
HART loop converter HMX50	<p>Is used to evaluate and convert dynamic HART process variables to analog current signals or limit values.</p> <p> <ul style="list-style-type: none"> ▪ Technical Information TI00429F ▪ Operating Instructions BA00371F </p>
Wireless HART adapter SWA70	<p>Is used for the wireless connection of field devices. The WirelessHART adapter can be easily integrated into field devices and existing infrastructures, offers data protection and transmission safety and can be operated in parallel with other wireless networks with minimum cabling complexity.</p> <p> Operating Instructions BA00061S</p>
Fieldgate FXA42	<p>Transmission of the measured values of connected 4 to 20 mA analog measuring instruments, as well as digital measuring instruments</p> <p> <ul style="list-style-type: none"> ▪ Technical Information TI01297S ▪ Operating Instructions BA01778S ▪ Product page: www.endress.com/fxa42 </p>
Field Xpert SMT50	<p>The Field Xpert SMT50 tablet PC for device configuration enables mobile plant asset management in non-hazardous areas. It is suitable for commissioning and maintenance staff to manage field instruments with a digital communication interface and to record progress.</p> <p>This tablet PC is designed as an all-in-one solution with a preinstalled driver library and is an easy-to-use, touch-sensitive tool which can be used to manage field instruments throughout their entire life cycle.</p> <p> <ul style="list-style-type: none"> ▪ Technical Information TI01555S ▪ Operating Instructions BA02053S ▪ Product page: www.endress.com/smt50 </p>

Field Xpert SMT70	<p>The Field Xpert SMT70 tablet PC for device configuration enables mobile plant asset management in hazardous and non-hazardous areas. It is suitable for commissioning and maintenance staff to manage field instruments with a digital communication interface and to record progress.</p> <p>This tablet PC is designed as an all-in-one solution with a preinstalled driver library and is an easy-to-use, touch-sensitive tool which can be used to manage field instruments throughout their entire life cycle.</p> <ul style="list-style-type: none">  Technical Information TI01342S  Operating Instructions BA01709S  Product page: www.endress.com/smt70
Field Xpert SMT77	<p>The Field Xpert SMT77 tablet PC for device configuration enables mobile plant asset management in areas categorized as Ex Zone 1.</p> <ul style="list-style-type: none">  Technical Information TI01418S  Operating Instructions BA01923S  Product page: www.endress.com/smt77

Service-specific accessories

Accessory	Description
Applicator	<p>Software for selecting and sizing Endress+Hauser measuring instruments:</p> <ul style="list-style-type: none"> ▪ Choice of measuring instruments for industrial requirements ▪ Calculation of all the necessary data for identifying the optimum flowmeter: e.g. nominal diameter, pressure loss, flow velocity and measurement accuracy. ▪ Graphic display of the calculation results ▪ Determining the partial order code. Administration, documentation and access to all project-related data and parameters over the entire life cycle of a project. <p>Applicator is available: Via the Internet: https://portal.endress.com/webapp/applicator</p>
Netilion	<p>IIoT ecosystem: Unlock knowledge</p> <p>With the Netilion IIoT ecosystem, Endress+Hauser allows you to optimize your plant performance, digitize workflows, share knowledge, and enhance collaboration.</p> <p>Based on decades of experience in process automation, Endress+Hauser offers the process industry an IIoT ecosystem that enables you to gain useful insights from data. These insights can be used to optimize processes, leading to increased plant availability, efficiency, and reliability - ultimately resulting in a more profitable plant.</p> <p>www.netilion.endress.com</p>
FieldCare	<p>FDT-based plant asset management tool from Endress+Hauser. It can configure all intelligent field units in your system and helps you manage them. By using the status information, it is also a simple but effective way of checking their status and condition.</p> <ul style="list-style-type: none">  Operating Instructions BA00027S and BA00059S
DeviceCare	<p>Tool to connect and configure Endress+Hauser field devices.</p> <ul style="list-style-type: none">  Technical Information: TI01134S  Innovation brochure: IN01047S

System components

Accessories	Description
Memograph M graphic data manager	<p>The Memograph M graphic data manager provides information on all the relevant measured variables. Measured values are recorded correctly, limit values are monitored and measuring points analyzed. The data are stored in the 256 MB internal memory and also on a SD card or USB stick.</p> <ul style="list-style-type: none">  Technical Information TI00133R  Operating Instructions BA00247R
iTEMP	<p>The temperature transmitters can be used in all applications and are suitable for the measurement of gases, steam and liquids. They can be used to read in the medium temperature.</p> <ul style="list-style-type: none">  "Fields of Activity" document FA00006T

Documentation

-  For an overview of the scope of the associated Technical Documentation, refer to the following:
- *Device Viewer* (www.endress.com/deviceviewer): Enter the serial number from the nameplate
 - *Endress+Hauser Operations app*: Enter serial number from nameplate or scan matrix code on nameplate.

Standard documentation

-  Supplementary information on the semi-standard options is available in the relevant Special Documentation in the TSP database.

Brief Operating Instructions

Brief Operating Instructions for the sensor

Measuring instrument	Documentation code
Proline Promass E	KA01260D

Brief Operating Instructions for the transmitter

Measuring instrument	Documentation code				
	HART	PROFIBUS DP	Modbus RS485	EtherNet/IP	PROFINET
Proline Promass 100	KA01334D	KA01333D	KA01335D	KA01332D	KA01336D

Operating Instructions

Measuring device	Documentation code				
	HART	PROFIBUS DP	Modbus RS485	EtherNet/IP	PROFINET
Promass E 100	BA01713D	BA01714D	BA01711D	BA01712D	BA01715D

Description of Device Parameters

Measuring instrument	Documentation code				
	HART	PROFIBUS DP	Modbus RS485	EtherNet/IP	PROFINET
Promass 100	GP01033D	GP01034D	GP01035D	GP01036D	GP01037D

Supplementary device-dependent documentation

Safety Instructions

Content	Documentation code
ATEX/IECEX Ex i	XA00159D
ATEX/IECEX Ex nA	XA01029D
cCSAus IS	XA00160D
INMETRO Ex i	XA01219D
INMETRO Ex nA	XA01220D

Special Documentation

Contents	Documentation code
Information on the Pressure Equipment Directive	SD01614D
Concentration measurement Ethernet/IP, HART, Modbus RS485, PROFIBUS DP	SD01152D
Concentration measurement PROFINET	SD01503D

Contents	Documentation code
Heartbeat Technology EtherNet/IP, HART, Modbus RS485, PROFIBUS DP	SD01153D
Heartbeat Technology PROFINET	SD01493D
Web server HART	SD01820D
Web server PROFIBUS DP	SD01821D
Web server EtherNet/IP	SD01822D
Web server PROFINET	SD01823D

Installation Instructions

Contents	Note
Installation instructions for spare part sets and accessories	The corresponding documentation code is listed with the relevant accessory. →  88.

Registered trademarks

HART®

Registered trademark of the FieldComm Group, Austin, Texas USA

PROFIBUS®

Registered trademark of the PROFIBUS Nutzerorganisation e.V. (PROFIBUS User Organization), Karlsruhe, Germany

Modbus®

Registered trademark of SCHNEIDER AUTOMATION, INC.

Ethernet/IP™

Trademark of ODVA, Inc.

PROFINET®

Registered trademark of the PROFIBUS Nutzerorganisation e.V. (PROFIBUS User Organization), Karlsruhe, Germany

TRI-CLAMP®

Registered trademark of Ladish & Co., Inc., Kenosha, USA



www.addresses.endress.com
