

Operating Instructions

iTHERM TrustSens TM371

Metric RTD thermometer with self-calibration technology for hygienic applications



Table of contents

1	About this document	3	9	Commissioning	24
1.1	Document function	3	9.1	Function check	24
1.2	Symbols	3	9.2	Switching on the device	24
1.3	Documentation	6	9.3	Configuring the device	25
1.4	Change history	6	9.4	Creating a calibration report	27
2	Basic safety instructions	7	9.5	Protecting settings from unauthorized access .	29
2.1	Requirements for the personnel	7	9.6	Advanced settings	29
2.2	Intended use	7	10	Diagnostics and troubleshooting ...	35
2.3	Operational safety	7	10.1	Troubleshooting	35
2.4	Product safety	8	10.2	Diagnostic information via LEDs	36
2.5	IT security	8	10.3	Diagnostic information	36
3	Product description	8	10.4	Overview of diagnostics events	37
3.1	Product design	8	10.5	Diagnostic list	39
3.2	Equipment architecture	9	10.6	Event logbook	39
4	Incoming acceptance and product identification	9	11	Maintenance	40
4.1	Incoming acceptance	9	11.1	Maintenance work	40
4.2	Product identification	10	11.2	Cleaning	40
4.3	Storage and transport	10	12	Repair	40
4.4	Certificates and approvals	10	12.1	General notes	40
5	Installation	11	12.2	Spare parts	40
5.1	Installation requirements	11	12.3	Return	40
5.2	Installing the device	12	12.4	Disposal	41
5.3	Post-installation check	15	13	Accessories	41
6	Electrical connection	15	13.1	Device-specific accessories	42
6.1	Connection requirements	15	13.2	Service-specific accessories	44
6.2	Connecting the device	15	13.3	Communication-specific accessories	46
6.3	Ensuring the degree of protection	16	13.4	Online tools	46
6.4	Post-connection check	16	13.5	System components	46
7	Operation options	16	14	Technical data	47
7.1	Overview of operation options	16	14.1	Input	47
7.2	Structure and function of the operating menu	17	14.2	Output	47
7.3	Configuration of transmitter and HART® protocol	19	14.3	Electrical connection	48
7.4	Access to the operating menu via the operating tool	19	14.4	Performance characteristics	49
8	System integration	22	14.5	Environment	55
8.1	Overview of device description files	22	14.6	Mechanical construction	56
8.2	Measured variables via HART® protocol	22	14.7	Certificates and approvals	76
8.3	Supported HART® commands	22	15	Operating menu and parameter description	78
			15.1	Setup menu	82
			15.2	Calibration menu	83
			15.3	“Diagnostics” menu	87
			15.4	“Expert” menu	96

1 About this document

1.1 Document function

These Operating Instructions contain all the information required in the various life cycle phases of the device: from product identification, incoming acceptance and storage, to installation, connection, operation and commissioning, through to troubleshooting, maintenance and disposal.

The Brief Operating Instructions contain all the essential information from incoming acceptance to initial commissioning.

The document is part of the Operating Instructions and serves as a reference for parameters, providing a detailed explanation of each individual parameter of the operating menu.

The document serves as a reference for parameters, providing a detailed explanation of each individual parameter of the operating menu including service parameters.

The document provides basic information on application problems, how to identify and eliminate them as well as specific background knowledge on the devices and their functionalities.

This supplementary Safety Manual applies in addition to the Operating Instructions, Technical Information and ATEX Safety Instructions. Other applicable device documentation must be observed during installation, commissioning and operation. The requirements specific to the protection function are described in this safety manual.

 General information on functional safety (SIL) is available at: www.endress.com/SIL

1.2 Symbols

1.2.1 Safety symbols

DANGER

This symbol alerts you to a dangerous situation. Failure to avoid this situation will result in serious or fatal injury.

WARNING

This symbol alerts you to a potentially dangerous situation. Failure to avoid this situation can result in serious or fatal injury.



CAUTION

This symbol alerts you to a potentially dangerous situation. Failure to avoid this situation can result in minor or medium injury.

NOTICE

This symbol alerts you to a potentially harmful situation. Failure to avoid this situation can result in damage to the product or something in its vicinity.

1.2.2 Electrical symbols

Symbol	Meaning
	Direct current
	Alternating current
	Direct current and alternating current



Symbol	Meaning
	Ground connection A grounded terminal which, as far as the operator is concerned, is grounded via a grounding system.
	Potential equalization connection (PE: Protective earth) Ground terminals that must be connected to ground prior to establishing any other connections. The ground terminals are located on the interior and exterior of the device: <ul style="list-style-type: none"> ▪ Interior ground terminal: potential equalization connection is connected to the supply network. ▪ Exterior ground terminal: device is connected to the plant grounding system.











Symbol	Meaning	Symbol	Meaning
	Direct current		Alternating current
	Direct current and alternating current		Ground connection A grounded terminal which, as far as the operator is concerned, is grounded via a grounding system.

Symbol	Meaning
	Potential equalization connection (PE: Protective earth) Ground terminals that must be connected to ground prior to establishing any other connections. The ground terminals are located on the interior and exterior of the device: <ul style="list-style-type: none"> ▪ Interior ground terminal: potential equalization connection is connected to the supply network. ▪ Exterior ground terminal: device is connected to the plant grounding system.

1.2.3 Symbols for certain types of information



Symbol	Meaning
	Permitted Procedures, processes or actions that are permitted.
	Preferred Procedures, processes or actions that are preferred.
	Forbidden Procedures, processes or actions that are forbidden.
	Tip Indicates additional information.
	Reference to documentation
	Reference to page
	Reference to graphic
	Notice or individual step to be observed
	Series of steps
	Result of a step
	Help in the event of a problem
	Visual inspection

Symbol	Meaning
 A0028662	Operation via local display
 A0028663	Operation via operating tool
 A0028665	Write-protected parameter

Symbol	Meaning	Symbol	Meaning
	Permitted Procedures, processes or actions that are permitted.		Preferred Procedures, processes or actions that are preferred.
	Forbidden Procedures, processes or actions that are forbidden.		Tip Indicates additional information.
	Reference to documentation		Reference to page
	Reference to graphic		Series of steps
	Result of a step		Visual inspection

1.2.4 Symbols in graphics

Symbol	Meaning
1, 2, 3 ...	Item numbers
A, B, C, ...	Views
A-A, B-B, C-C, ...	Sections

Symbol	Meaning	Symbol	Meaning
1, 2, 3,...	Item numbers		Series of steps
A, B, C, ...	Views	A-A, B-B, C-C, ...	Sections
	Hazardous area		Safe area (non-hazardous area)

1.2.5 Tool symbols

Symbol	Meaning
 A0011222	Open-end wrench

1.3 Documentation

 For an overview of the scope of the associated Technical Documentation, refer to the following:

- *Device Viewer* (www.endress.com/deviceviewer): Enter the serial number from the nameplate
- *Endress+Hauser Operations app*: Enter serial number from nameplate or scan matrix code on nameplate.

The following document types are available in the Downloads area of the Endress+Hauser website (www.endress.com/downloads), depending on the product configuration:

Document type	Purpose and content of the document
Technical Information (TI)	Planning aid This document contains all the technical data on the product and provides an overview of everything that can be ordered with the product.
Brief Operating Instructions (KA)	Quick guide to obtaining the first measured value The Operating Instructions contain all the essential information about the product from incoming acceptance to initial commissioning.
Operating Instructions (BA)	Reference The Operating Instructions contain the information that is required in the various phases of the life cycle of the product: From product identification, incoming acceptance and storage, to mounting, connection, operation and commissioning through to troubleshooting, maintenance and disposal.
Description of Device Parameters (GP)	Reference for parameters The document contains detailed explanations of readable or configurable parameters in the product. The description is aimed at those who work with the product over its entire life cycle and perform specific configurations.
Safety Instructions (XA)	Safety Instructions for electrical equipment in hazardous areas are supplied with the product depending on the approval. These are an integral part of the Operating Instructions.  The nameplate indicates the Safety Instructions (XA) that are relevant to the product.
Supplementary device-dependent documentation (SD/FY)	Always comply strictly with the instructions in the relevant supplementary documentation. The supplementary documentation is an integral part of the product documentation.

1.4 Change history

The firmware version (FW) on the nameplate and in the Operating Instructions indicates the device release: XX.YY.ZZ (example 01.02.01).

- XX Change to main version. No longer compatible. Changes in the device and Operating Instructions.
- YY Change to functions and operation. Compatible. Changes in the Operating Instructions.
- ZZ Bug fixing. No changes to the Operating Instructions.

Documentation version	Firmware version	Changes
BA01581T_0117	01.00.zz	Original firmware
BA01581T_0218	01.00.zz	Updates; bug fixes
BA01581T_0318	01.00.zz	Updates to Heartbeat Technology; bug fixes
BA01581T_0421	01.00.zz	Updates; bug fixes
BA01581T_0522	01.00.zz	Updates; separation of TM371/TM372; bug fixes

Documentation version	Firmware version	Changes
BA01581T_0622	01.00.zz	Updates; bug fixes
BA01581T_0725	01.00.zz	Updates; bug fixes
BA01581T_0826	01.00.zz	Updates to 39 °C – self-calibration

2 Basic safety instructions

2.1 Requirements for the personnel

The personnel for installation, commissioning, diagnostics and maintenance must fulfill the following requirements:

- ▶ Trained, qualified specialists must have a relevant qualification for this specific function and task.
- ▶ Are authorized by the plant owner/operator.
- ▶ Are familiar with federal/national regulations.
- ▶ Before starting work, read and understand the instructions in the manual and supplementary documentation as well as the certificates (depending on the application).
- ▶ Follow instructions and comply with basic conditions.

The personnel must fulfill the following requirements for its tasks:

- ▶ Trained, qualified specialists must have a relevant qualification for this specific function and task.
- ▶ Are authorized by the plant owner/operator.
- ▶ Are familiar with federal/national regulations.
- ▶ Before starting work, read and understand the instructions in the manual and supplementary documentation as well as the certificates (depending on the application).
- ▶ Follow instructions and comply with basic conditions.

The operating personnel must fulfill the following requirements:

- ▶ Are instructed and authorized according to the requirements of the task by the facility's owner-operator.
- ▶ Follow the instructions in this manual.

2.2 Intended use

The device is a hygienic compact thermometer, which features an automatic self-calibration function. It is used for the acquisition and conversion of temperature input signals for industrial temperature measurement.

The manufacturer is not liable for harm caused by improper or non-designated use.

2.3 Operational safety

NOTICE

Operational safety

- ▶ Operate the device only if it is in proper technical condition, free from errors and faults.
- ▶ The operator is responsible for interference-free operation of the device.

Modifications to the device

Unauthorized modifications to the device are not permitted and can lead to unforeseeable dangers.

- ▶ If modifications are nevertheless required, consult Endress+Hauser.

Repair

Due to its design, the device cannot be repaired.

- ▶ However, it is possible to send the device in for examination.
- ▶ To ensure continued operational safety and reliability, use original spare parts and accessories from Endress+Hauser only.

2.4 Product safety

This state-of-the-art device is designed and tested in accordance with good engineering practice to meet operational safety standards. It left the factory in a condition in which it is safe to operate.

It meets general safety standards and legal requirements. It also complies with the EU directives listed in the device-specific EU declaration of conformity. The manufacturer confirms this by affixing the CE mark.

2.5 IT security

The manufacturer warranty is valid only if the product is installed and used as described in the Operating Instructions. The product is equipped with security mechanisms to protect it against any inadvertent changes to the settings.

IT security measures, which provide additional protection for the product and associated data transfer, must be implemented by the operators themselves in line with their security standards.

3 Product description

3.1 Product design

The iTHERM TrustSens thermometer incorporates a groundbreaking innovation – its self-calibration functionality. A standard Pt100 sensor element is used in normal operation. The Pt100 measurement is automatically calibrated at a specific process temperature with the help of an integrated, high-precision reference sensor. This eliminates the need to remove the thermometer for calibration purposes.

3.2 Equipment architecture

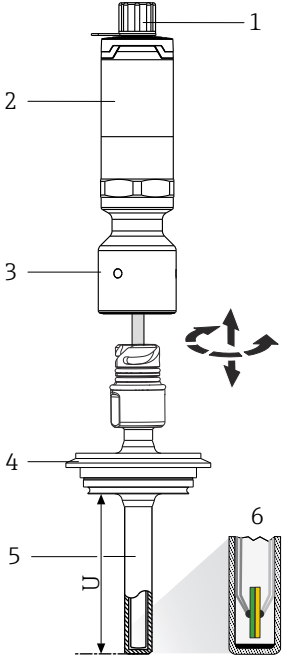
Structure	Options	
 <p style="text-align: right; font-size: small;">A0031106</p>	<p>1: Wiring, electrical connection, output signal 2: Transmitter housing</p>	<p>i Your benefits at a glance:</p> <ul style="list-style-type: none"> ▪ Optimum protection even with high-pressure cleaning: IP65/67 as standard, optional IP69 protection ▪ M12, 4-pin plug, reduced cost and effort, incorrect wiring is prevented ▪ Compact, built-in transmitter (4 to 20 mA, HART)
	<p>3: Extension neck</p>	<ul style="list-style-type: none"> ▪ Welded in place or removable ▪ Optional with iTHERM QuickNeck bayonet joint <p>i Your benefits at a glance:</p> <ul style="list-style-type: none"> ▪ iTHERM QuickNeck: tool-free removal of the compact thermometer ▪ IP69 protection: safety under extreme process conditions
	<p>4: Process connection → 66</p>	<p>More than 50 different versions.</p>
	<p>5: Thermowell</p>	<ul style="list-style-type: none"> ▪ Versions with and without thermowell (insert in direct contact with process) ▪ Various diameters ▪ Various tip shapes (straight or reduced)
	<p>6: Insert</p>	<p>Sensor model: thin-film Pt100 sensor (TF) with iTHERM TrustSens technology.</p> <p>i Your benefits at a glance:</p> <ul style="list-style-type: none"> ▪ Risk and cost reduction thanks to Heartbeat technology ▪ Fully automated, traceable, in situ self-calibration ▪ Automated documentation, memory for the last 350 calibration points ▪ Printable "audit-proof" calibration certificate ▪ No risk of non-compliance or undetected failures ▪ International certificates and approvals

4 Incoming acceptance and product identification

4.1 Incoming acceptance

On receipt of the delivery:

1. Check the packaging for damage.
 - ↳ Report all damage immediately to the manufacturer.
 - Do not install damaged components.
 2. Check the scope of delivery using the delivery note.
 3. Compare the data on the nameplate with the order specifications on the delivery note.
 4. Check the technical documentation and all other necessary documents, e.g. certificates, to ensure they are complete.
- i** If one of the conditions is not satisfied, contact the manufacturer.

4.2 Product identification

The following options are available for identification of the device:

- Nameplate specifications
- Enter the serial number from the nameplate into *Device Viewer* (www.endress.com/deviceviewer): all the information about the device and an overview of the technical documentation supplied with the device are displayed.
- Enter the serial number from the nameplate into the *Endress+Hauser Operations app* or scan the 2-D matrix code (QR code) on the nameplate with the *Endress+Hauser Operations app*: all the information about the device and the technical documentation pertaining to the device is displayed.

4.2.1 Nameplate

Do you have the correct device?

The nameplate provides you with the following information on the device:

- Manufacturer identification, device designation
- Order code
- Extended order code
- Serial number
- Tag name (TAG) (optional)
- Technical values such as supply voltage, current consumption, ambient temperature, communication-specific data (optional)
- Degree of protection
- Approvals with symbols
- Reference to Safety Instructions (XA) (optional)

► Compare the information on the nameplate with the order.

4.2.2 Name and address of manufacturer

Name of manufacturer:	Endress+Hauser Wetzler GmbH + Co. KG
Address of manufacturer:	Obere Wank 1, D-87484 Nesselwang or www.endress.com

4.3 Storage and transport

Storage temperature: -40 to +85 °C (-40 to +185 °F)

Maximum relative humidity: < 95 % as per IEC 60068-2-30

 Pack the device for storage and transportation in such a way that it is reliably protected against impact and external influences. The original packaging offers the best protection.

Avoid the following environmental influences during storage:

- Direct sunlight
- Proximity to hot objects
- Mechanical vibration
- Aggressive media

4.4 Certificates and approvals

Current certificates and approvals for the product are available at www.endress.com on the relevant product page:

1. Select the product using the filters and search field.
2. Open the product page.

3. Select **Downloads**.

5 Installation

5.1 Installation requirements

i For information on ambient conditions at the installation location, e.g., the ambient temperature, degree of protection, climate class etc.), and information on the device dimensions, see the 'Technical data' section →  47

i The immersion length of the thermometer can influence the measurement accuracy. If the immersion length is too small then measurement errors are caused by heat conduction via the process connection. If installing into a pipe then the immersion length should ideally be half of the pipe diameter. →  12

- Installation options: pipes, tanks or other plant components
- Orientation: no restrictions. However, self-draining in the process must be guaranteed. If there is an opening to detect leaks at the process connection, this opening must be at the lowest possible point.

5.1.1 Ambient temperature range

Ambient temperature T_a	-40 to +60 °C (-40 to +140 °F)
Maximum device temperature T	-40 to +85 °C (-40 to +185 °F)

5.1.2 Climate class

As per IEC 60654-1, Class Dx

5.1.3 Degree of protection

- IP65/67 for housing with LED status indication
- IP69 for housing without LED status indication and with connecting cable with M12x1 coupling

5.1.4 Shock and vibration resistance

Endress+Hauser temperature sensors meet the requirements of IEC 60751 which specify shock and vibration resistance of 3g in the range from 10 to 500 Hz. This also applies for the quick-fastening iTHERM QuickNeck.

5.1.5 Electromagnetic compatibility (EMC)

EMC to all relevant requirements of the IEC/EN 61326 series and NAMUR Recommendation EMC (NE21). For details, refer to the Declaration of Conformity. All tests were passed both with and without ongoing HART® communication.

All EMC measurements were performed with a turndown (TD) = 5:1. Maximum fluctuations during EMC tests: < 1% of the measuring span.

Interference immunity according to the IEC/EN 61326 series, industrial requirements.

Interference emission according to the IEC/EN 61326, Class B equipment.

5.2 Installing the device

Required tools for installing in an existing thermowell: open-end wrench or socket wrench AF 32

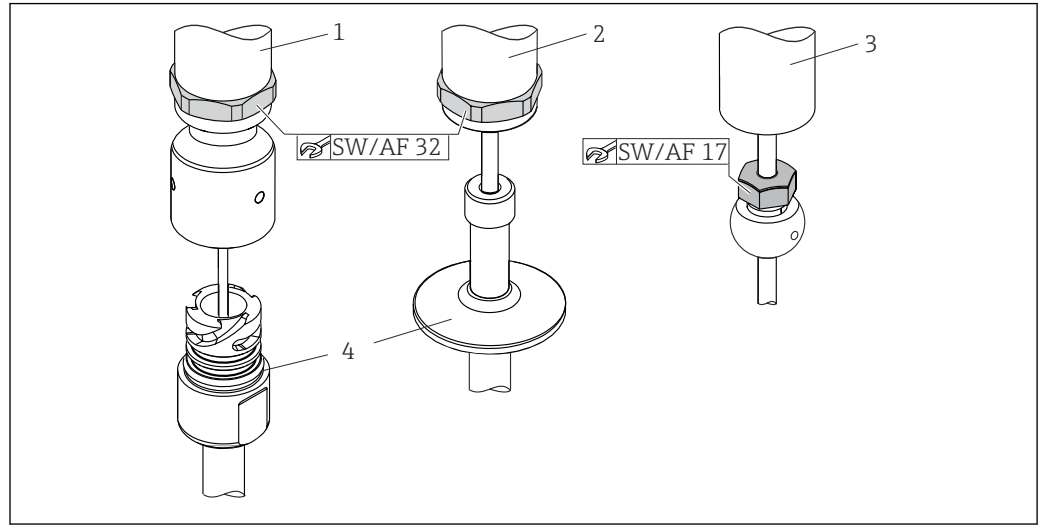

A0028639

1 Installing the compact thermometer

- 1 Installation of the iTHERM QuickNeck connection in existing thermowell with iTHERM QuickNeck bottom part: no tools required
- 2 Hexagonal head for installing in an existing thermowell for M24-, G3/8"-thread: open-end wrench AF 32
- 3 Adjustable compression fitting TK40, installation of the hexagonal screw: open-end wrench AF 17
- 4 Thermowell

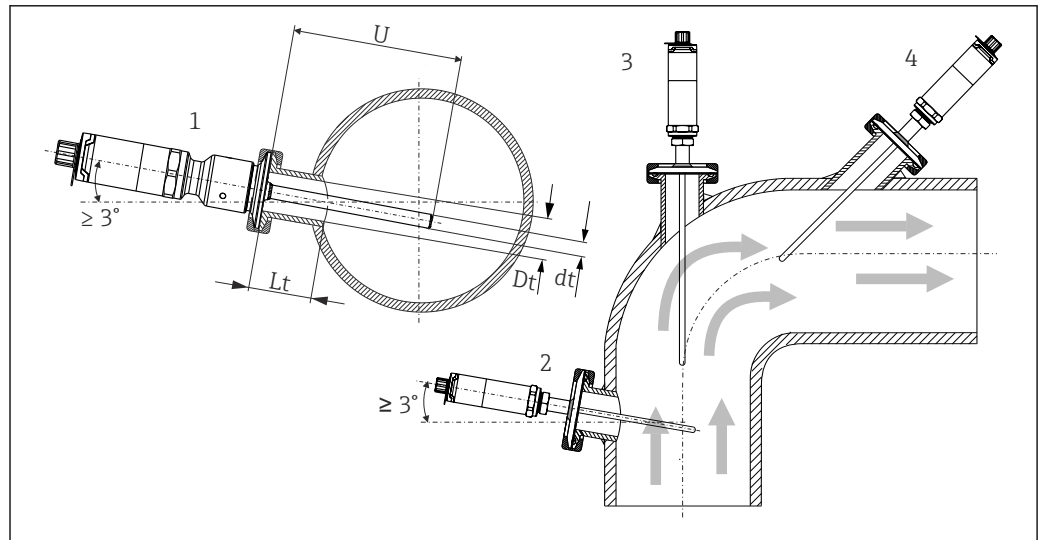

A0031007

2 Installation possibilities in the process

- 1, 2 Perpendicular to the flow direction, installed at a min. angle of 3° to ensure self-draining
- 3 On elbows
- 4 Inclined installation in pipes with a small nominal diameter
- U Immersion

i The requirements of the EHEDG and the 3-A Sanitary Standard must be adhered to.

Installation instructions EHEDG/cleanability: $L_t \leq (D_t - d_t)$

Installation instructions 3-A/cleanability: $L_t \leq 2(D_t - d_t)$

In the case of small nominal diameters, position the tip of the thermometer in such a way that it protrudes past the pipe axis into the medium. Installation at an angle (4) could be

another solution. When determining the immersion length or installation depth, all the parameters of the thermometer and of the medium to be measured must be taken into account (e.g. flow velocity, process pressure).

Maximum torque			
Thermowell version	TT411, $\phi 6$ mm (0.24 in) (1) TT411, $\phi 6$ mm (0.24 in) and extension neck TE411 (2)	TT411, $\phi 9$ mm (0.35 in) (3)	TT411, $\phi 12.7$ mm ($\frac{1}{2}$ in) (4) TT411, $\phi 12.7$ mm ($\frac{1}{2}$ in) and extension neck TE411 (5)
Torque M	3 to 5 Nm (2.2 to 3.7 lbf ft)	10 Nm (7.4 lbf ft)	3 to 5 Nm (2.2 to 3.7 lbf ft)

i When connecting the device with the thermowell: only tighten the hexagonal wrench flat on the bottom of the housing.

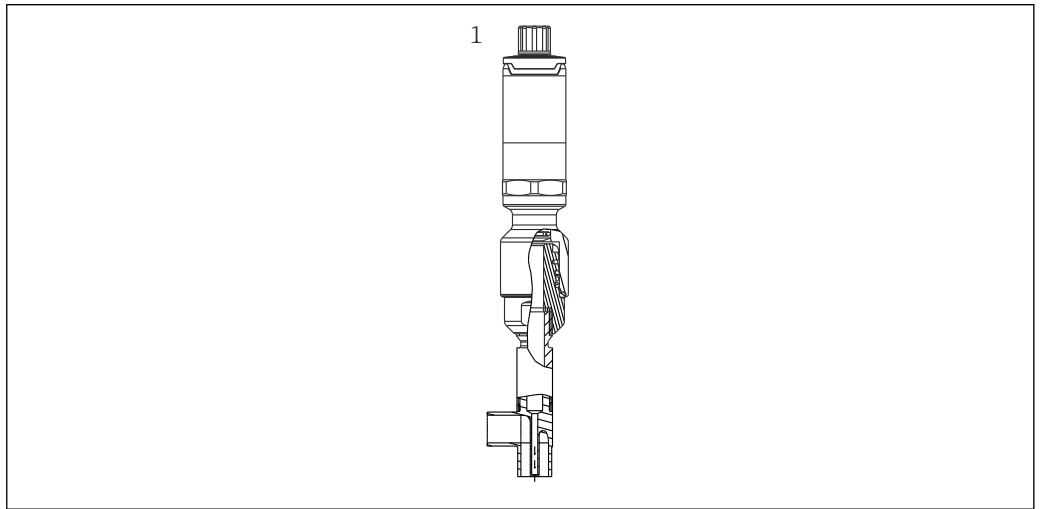

- 3** Process connections for thermometer installation in pipes with small nominal diameters
- 1** Elbow thermowell for weld-in as per DIN 11865/ASME BPE

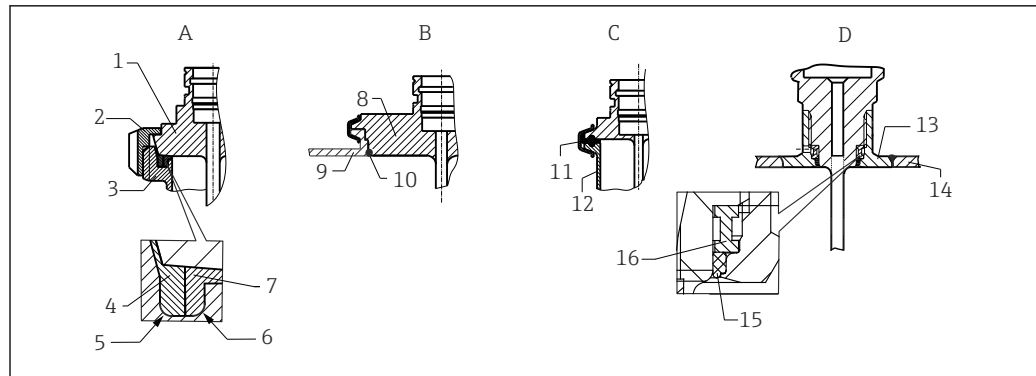

4 Detailed installation instructions for hygiene-compliant installation

- A Dairy fitting according to DIN 11851, only in conjunction with EHEDG-certified, self-centering sealing ring
- 1 Sensor with dairy fitting
- 2 Grooved union nut
- 3 Counterpart connection
- 4 Centering ring
- 5 RO.4
- 6 RO.4
- 7 Sealing ring
- B Varivent® process connection for VARINLINE® housing
- 8 Sensor with Varivent connection
- 9 Counterpart connection
- 10 O-ring
- C Clamp according to ISO 2852
- 11 Molded seal
- 12 Counterpart connection
- D Liquiphant M G1" process connection, horizontal installation
- 13 Weld-in adapter
- 14 Vessel wall
- 15 O-ring
- 16 Thrust collar

NOTICE

The following actions must be taken if a sealing ring (O-ring) or seal fails:

- ▶ The thermometer must be removed.
- ▶ The thread and the O-ring joint/sealing surface must be cleaned.
- ▶ The sealing ring and/or the seal must be replaced.
- ▶ CIP must be performed after installation.

The counterpieces for the process connections and the seals or sealing rings are not supplied with the thermometer. Liquiphant M weld-in adapters with associated seal kits are available as accessories, see corresponding Operating Instructions . → 41

In the case of weld-in connections, exercise care when performing the welding work on the process side:

1. Use suitable welding material.
 2. Flush-weld or weld with welding radius ≥ 3.2 mm (0.13 in).
 3. Avoid crevices, folds and gaps.
 4. Ensure the surface is honed and polished, $R_a \leq 0.76$ μm (30 μin).
1. Install the thermometers in such a way that their cleanability is not affected. Comply with the requirements of the 3-A Sanitary Standard.
 2. The Varivent®, Liquiphant M weld-in adapters and Ingold weld-in adapters enable flush-mounted installation.

5.3 Post-installation check

<input type="checkbox"/>	Is the device undamaged (visual inspection)?
<input type="checkbox"/>	Is the device correctly secured?
<input type="checkbox"/>	Does the device comply with the measurement point specifications, such as ambient temperature, etc.? → 47

6 Electrical connection

6.1 Connection requirements

i According to the 3-A Sanitary Standard and EHEDG, electrical connecting cables must be smooth, corrosion-resistant and easy to clean.

6.2 Connecting the device

NOTICE

To prevent damage to the device

- ▶ To prevent any kind of damage to the device electronics, leave pins 2 and 4 unconnected. They are reserved for the connection of the configuration cable.
- ▶ Do not overtighten the M12 plug as this could cause mechanical damage to the device. Tightening torque as per cable specification, typically 0.4 Nm.

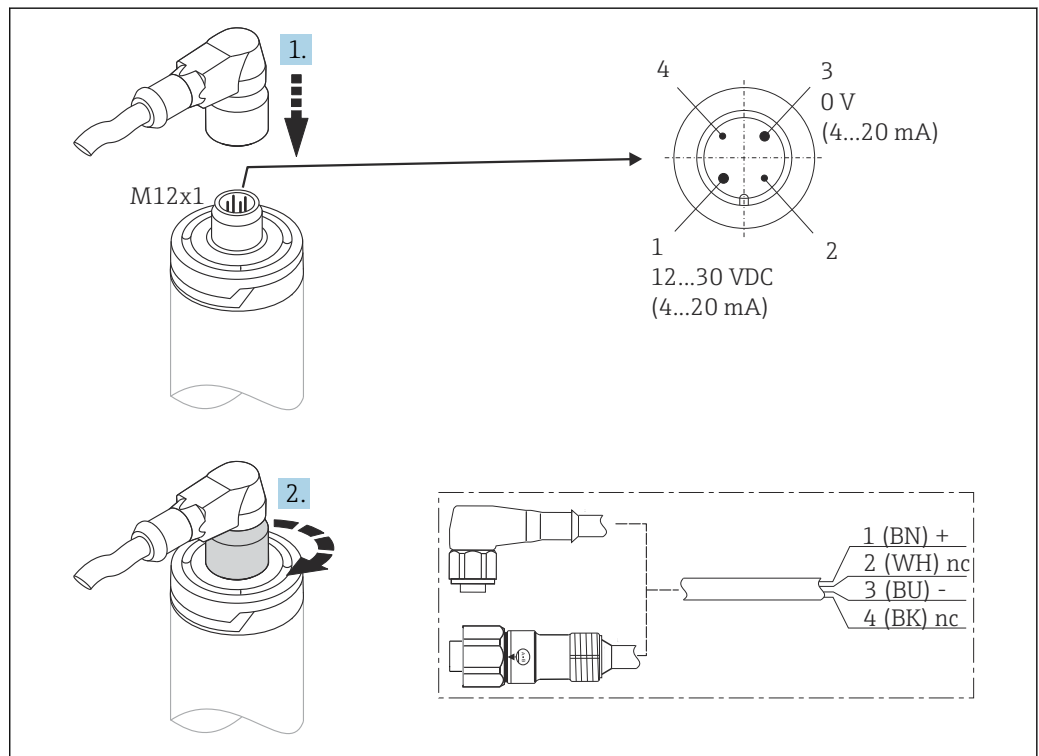

5 Cable plug M12x1 and PIN assignment of the connection socket at the device

A0028623

6.3 Ensuring the degree of protection

The specified degree of protection is ensured when the M12x1 cable plug is tightened according to specifications. In order to reach IP69 degree of protection, appropriate cord sets with straight or angle plugs are available as accessories.

6.4 Post-connection check

<input type="checkbox"/>	Are the device and cables free from damage (visual check)?
<input type="checkbox"/>	Are the mounted cables strain-relieved?
<input type="checkbox"/>	Does the supply voltage match the specifications on the nameplate?

7 Operation options

7.1 Overview of operation options

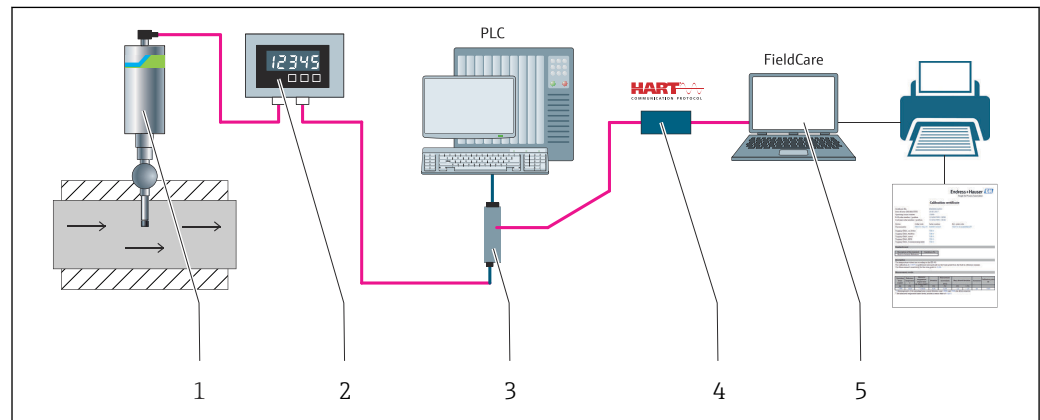

A0031089

6 Operating options of the device

- 1 Installed iTHERM compact thermometer with HART communication protocol
- 2 RIA15 loop-powered process indicator: The process indicator is integrated in the current loop and displays the measuring signal or HART process variables in digital form. The process indicator does not require an external power supply. It is powered directly from the current loop.
- 3 Active barrier RN42: The active barrier is used for transmission and galvanic isolation of 4-20 mA/HART signals and supplying loop-powered transmitters. The universal power supply works with an input supply voltage of 19.2 to 253 V AC/DC, 50/60 Hz, which means that it can be used in all international power grids.
- 4 Commubox FXA195 for intrinsically safe HART communication with FieldCare via the USB interface.
- 5 FieldCare is an FDT-based plant asset management tool from Endress+Hauser; for more details, see 'Accessories' section. The acquired self-calibration data are stored in the device (1) and can be read using FieldCare. This also allows you to create and print an auditable calibration certificate.

7.2 Structure and function of the operating menu

7.2.1 Structure of the operating menu

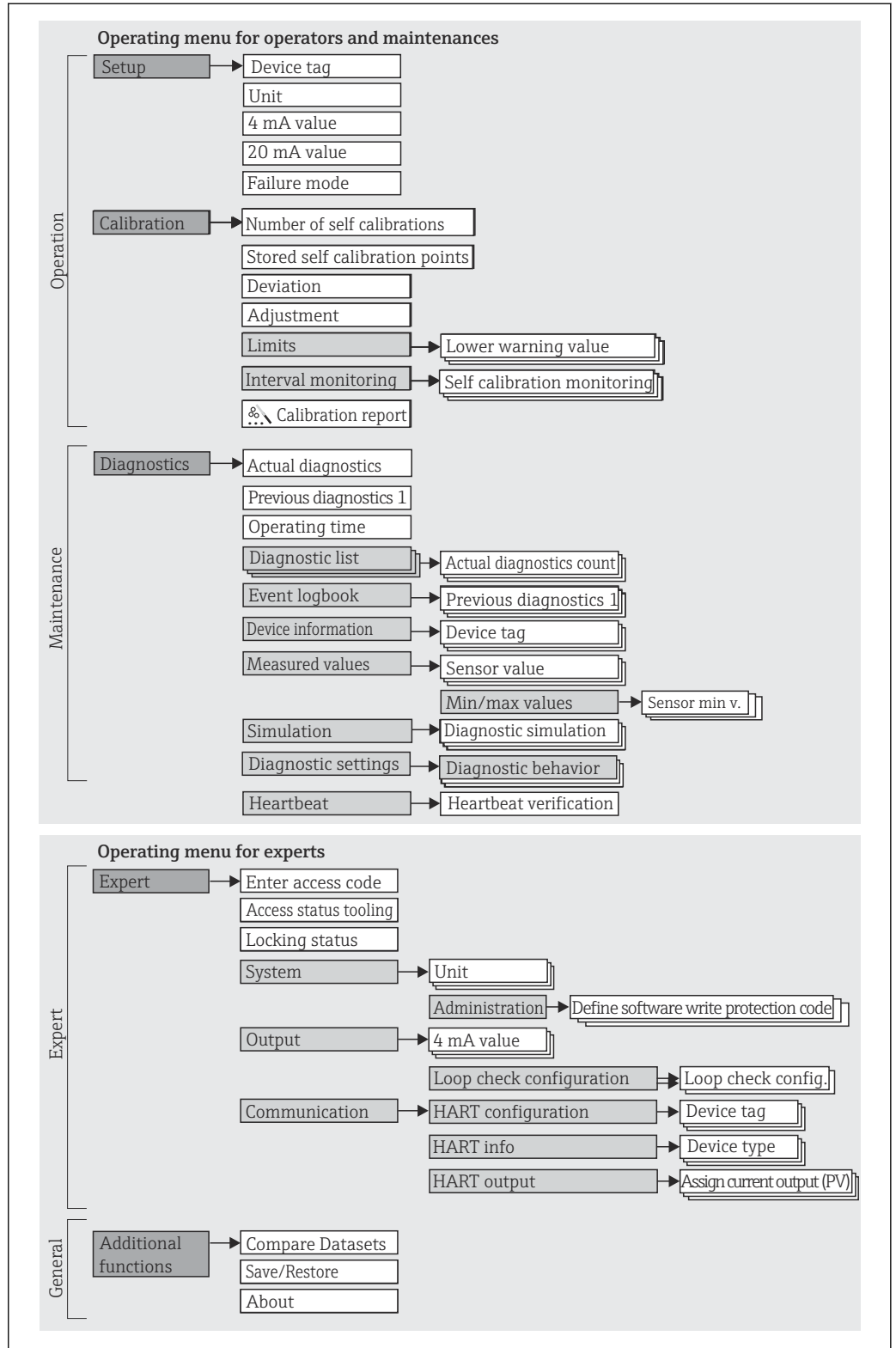

A0048654

Submenus and user roles

Certain parts of the menu are assigned to certain user roles. Each user role corresponds to typical tasks within the lifecycle of the device.

User role	Typical tasks	Menu	Content/meaning
Maintenance Operator	Commissioning: <ul style="list-style-type: none"> ▪ Configuration of the measurement. ▪ Configuration of measured value processing (measuring range, etc.). Reading measured values. Calibration: <ul style="list-style-type: none"> ▪ Configuration of the warning and alarm limit values as well as interval monitoring. ▪ Configuration and creation of a calibration report (wizard). 	"Setup" "Calibration"	Contains all parameters for commissioning and calibration: <ul style="list-style-type: none"> ▪ Setup parameters Once values have been set for these parameters, the measurement should usually be fully configured. ▪ Calibration parameters Contains all information and parameters for the self-calibration, including a wizard for creating a calibration report. This wizard is available as part of the online configuration.
	Fault elimination: <ul style="list-style-type: none"> ▪ Diagnosing and eliminating process errors. ▪ Interpretation of device error messages and correcting associated errors. 	"Diagnostics"	Contains all parameters for detecting and analyzing errors: <ul style="list-style-type: none"> ▪ Diagnostic list Contains up to 3 currently pending diagnostic messages. ▪ Event logbook Contains the last 5 diagnostic messages (no longer pending). ▪ "Device information" submenu Contains information for identifying the device. ▪ "Measured values" submenu Contains all current measured values. ▪ "Simulation" submenu Is used to simulate measured values or output values. ▪ Diagnostic settings Configuration of diagnostic behavior and status signal according to NE 107
	Heartbeat Technology: Creation of a Heartbeat Technology report (wizard)	"Heartbeat"	Contains a wizard for creating a Heartbeat Technology report. This wizard is available as part of the online configuration.
Expert	Tasks that require detailed knowledge of the device's functionality: <ul style="list-style-type: none"> ▪ Commissioning measurements under difficult conditions. ▪ Optimal adaptation of the measurement to difficult conditions. ▪ Detailed configuration of the communication interface. ▪ Error diagnostics in difficult cases. 	"Expert"	Contains all parameters of the device, including those that are already contained in one of the other menus. The structure of this menu is based on the function blocks of the device: <ul style="list-style-type: none"> ▪ "System" submenu Contains all higher-level device parameters that do not affect measurement or measured value communication. ▪ "Output" submenu Contains all parameters for configuring the analog current output and the loop check. ▪ "Communication" submenu Contains all parameters for configuring the digital communication interface.

7.3 Configuration of transmitter and HART® protocol

The compact thermometer is configured via the HART® protocol or CDI interface ¹⁾). The following operating tools are available for this purpose:

Operating tools

FieldCare, DeviceCare, Field Xpert (Endress+Hauser)	SIMATIC PDM (Siemens)
AMS Device Manager (Emerson Process Management)	Field Communicator 375, 475 (Emerson Process Management)

 The configuration of device-specific parameters is described in detail in the corresponding Operating Instructions.

7.4 Access to the operating menu via the operating tool

7.4.1 FieldCare

Function scope

FDT/DTM-based plant asset management tool from Endress+Hauser. It can be used to configure all intelligent field units in a plant and helps you manage them. By using the status information provided, it is also a simple but effective way of checking their status and condition. Access takes place via the HART protocol or CDI interface ¹⁾.

Typical functions:

- Configuring device parameters
- Loading and saving device data (upload/download)
- Documentation of the measuring point

 For iTHERM TrustSens thermometers, FieldCare provides convenient access to automatically created self-calibration reports.

For details, see Operating Instructions BA00027S and BA00065S in the downloads area on www.endress.com.

Source for device description files

See "System integration" section →  22

Establishing a connection

As example: via HART modem Commubox FXA191 (RS232) or FXA195 (USB)

1. Make sure to update the DTM library for all connected devices (e.g. FXA19x, iTHERM TrustSens TM371).
2. Start FieldCare and create a project.
3. Go to View --> Network: Right-click on **Host PC** Add device...
 - ↳ The **Add new device** window opens.
4. Select the **HART Communication** option from the list and press **OK** to confirm.
5. Double-click **HART communication** DTM instance.
 - ↳ Check whether the correct modem is connected to the serial interface connection and press **OK** to confirm.

1) Endress+Hauser Common Data Interface

6. Right-click **HART communication** and select the **Add device...** option in the context menu that opens.
7. Select the desired device from the list and press **OK** to confirm.
 - ↳ The device now appears in the network list.
8. Right-click the device and select the **Connect** option in the context menu.
 - ↳ The CommDTM is displayed in green.
9. Double-click the device in the network to establish the online connection to the device.
 - ↳ Online configuration is available.

User interface

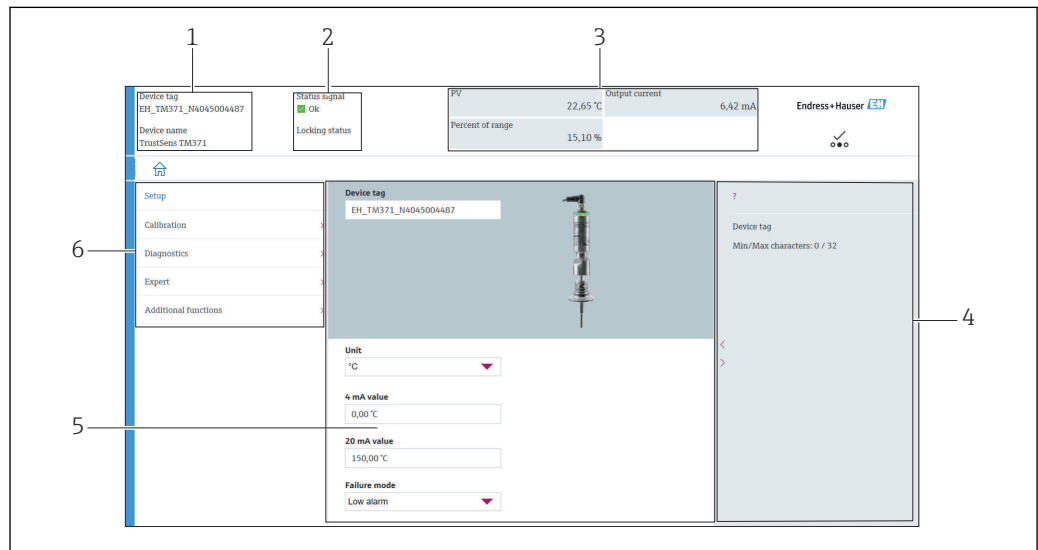

A0048541

7 User interface with device information via HART communication

- 1 Device tag and device name
- 2 Status area for the status signal
- 3 Measured values with general device information: PV, output current, percent of range
- 4 Help/additional information
- 5 Display and input area
- 6 Navigation area with operating menu structure

7.4.2 DeviceCare

Function scope

DeviceCare is a free configuration tool for Endress+Hauser devices. It supports devices with the following protocols, provided a suitable device driver (DTM) is installed: HART, PROFIBUS, FOUNDATION Fieldbus, Ethernet/IP, Modbus, CDI, ISS, IPC and PCP. The target group comprises customers without a digital network in plants and workshops as well as Endress+Hauser service technicians. The devices can be connected directly via a modem (point-to-point) or a bus system. DeviceCare is fast, easy and intuitive to use. It can run on a PC, laptop or tablet with a Windows operating system.

Source for device description files

See "System integration" section → 22

7.4.3 Field Xpert

Function scope

Field Xpert is an industrial PDA (personal digital assistant) with integrated touchscreen for commissioning and maintaining field devices in explosion hazardous and non-hazardous areas. It enables efficient configuration of FOUNDATION Fieldbus, HART and WirelessHART devices.

Source for device description files

See "System integration" section →  22

7.4.4 AMS Device Manager

Function scope

Program from Emerson Process Management for operating and configuring measuring instruments via the HART protocol.

Source for device description files

See "System integration" section →  22

7.4.5 SIMATIC PDM

Function scope

SIMATIC PDM is a standardized, manufacturer-independent program from Siemens for the operation, configuration, maintenance and diagnosis of intelligent field devices via the HART protocol.

Source for device description files

See "System integration" section →  22

7.4.6 Field Communicator 375/475

Function scope

Industrial handheld terminal from Emerson Process Management for remote configuration and measured value display via the HART protocol.

Source for device description files

See "System integration" section →  22

8 System integration

8.1 Overview of device description files

Version data for the device

Firmware version	01.00.zz	The firmware version can be found: <ul style="list-style-type: none"> ▪ on the nameplate ▪ in the operating menu: Diagnostics → Device information → Firmware version ▪  Please make sure to use the operating instructions valid for the device. The corresponding firmware versions for each set of operating instructions can be found on its title page.
Manufacturer ID	(17) 0x11	Operating menu: Diagnostics → Device information → Manufacturer ID
Device type	0x11CF	Operating menu: Expert → Communication → HART info → Device type
HART protocol revision	7	Operating menu: Expert → Communication → HART info → HART revision
Device revision	1	<ul style="list-style-type: none"> ▪ on the nameplate ▪ Operating menu: Expert → Communication → HART info → Device revision

The suitable device driver software (DD/DTM) for the individual operating tools can be obtained from different sources:

- www.endress.com --> Downloads --> Device driver (select type and product root)
- www.endress.com --> Products: Individual product page, e.g. TMTxy --> Downloads --> Device driver: Select type

Endress+Hauser supports all common operating tools from a variety of manufacturers (e.g. Emerson Process Management, ABB, Siemens, Yokogawa, Honeywell and many others). The Endress+Hauser FieldCare and DeviceCare operating tools are also available for download (www.software-products.endress.com).

8.2 Measured variables via HART® protocol

The measured values (device variables) are assigned to the device variables as follows:

Dynamic variable	Device variable
Primary value (PV)	Temperature
Secondary value (SV)	Device temperature
Tertiary value (TV)	Number of self-calibrations
Quaternary value (QV)	Calibration deviation

8.3 Supported HART® commands

 The HART® protocol enables the transfer of measurement data and device data between the HART® master and the field device. HART® masters such as the above listed operating tools require an appropriate device driver software (DD or DTM) to establish the data exchange. The data exchange is initiated via commands.

There are three different types of commands.

- **Universal commands:**

All HART® devices support and use universal commands. These are associated with the following functionalities for example:

- Detection of HART® devices
- Reading digital measured values

- **Common practice commands:**

Common practice commands offer functions which are supported and can be executed by many but not all field devices.

- **Device-specific commands:**

These commands allow access to device-specific functions which are not HART® standard. Such commands access individual field device information.



Command No.	Designation
Universal commands	
0, Cmd0	Read unique identifier
1, Cmd001	Read primary variable
2, Cmd002	Read loop current and percent of range
3, Cmd003	Read dynamic variables and loop current
6, Cmd006	Write polling address
7, Cmd007	Read loop configuration
8, Cmd008	Read dynamic variable classifications
9, Cmd009	Read device variables with status
11, Cmd011	Read unique identifier associated with TAG
12, Cmd012	Read message
13, Cmd013	Read TAG, descriptor, date
14, Cmd014	Read primary variable transducer information
15, Cmd015	Read device information
16, Cmd016	Read final assembly number
17, Cmd017	Write message
18, Cmd018	Write TAG, descriptor, date
19, Cmd019	Write final assembly number
20, Cmd020	Read long TAG (32-byte TAG)
21, Cmd021	Read unique identifier associated with long TAG
22, Cmd022	Write long TAG (32-byte TAG)
38, Cmd038	Reset configuration changed flag
48, Cmd048	Read additional device status
Common practice commands	
33, Cmd033	Read device variables
34, Cmd034	Write primary variable damping value
35, Cmd035	Write primary variable range values
40, Cmd040	Enter/Exit fixed current mode
42, Cmd042	Perform device reset
44, Cmd044	Write primary variable units
45, Cmd045	Trim loop current zero
46, Cmd046	Trim loop current gain
50, Cmd050	Read dynamic variable assignments

Command No.	Designation
54, Cmd054	Read device variable information
59, Cmd059	Write number of response preambles
95, Cmd095	Read Device Communication Statistics
100, Cmd100	Write Primary Variable Alarm Code
516, Cmd516	Read Device Location
517, Cmd517	Write Device Location
518, Cmd518	Read Location Description
519, Cmd519	Write Location Description
520, Cmd520	Read Process Unit Tag
521, Cmd521	Write Process Unit Tag
523, Cmd523	Read Condensed Status Mapping Array
524, Cmd524	Write Condensed Status Mapping Array
525, Cmd525	Reset Condensed Status Mapping Array
526, Cmd526	Write Simulation Mode
527, Cmd527	Simulate Status Bit

9 Commissioning

9.1 Function check

Before commissioning the device, make sure that all final checks have been carried out:

- "Post-mounting check" checklist, →  15
- "Post-connection check" checklist, →  16

9.2 Switching on the device

Once the final checks have been successfully completed, it is time to switch on the supply voltage. The device performs a number of internal test functions after it is powered up. This is indicated by a red LED flashing. The device is operational after 10 seconds approx. and is in normal operating mode. The LED on the device is lit green.

9.2.1 Display elements

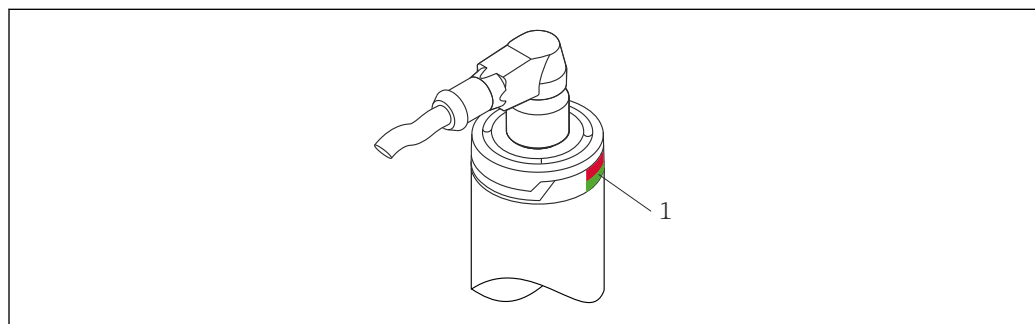



A0031589

1 LED signals for device status indication.

For diagnostic information on the various LED signals, see →  36

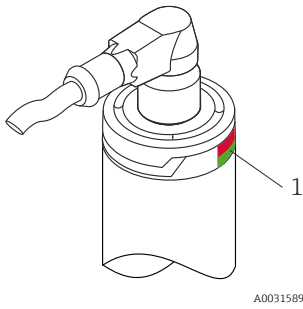
9.2.2 Display elements

Item	LEDs	Functional description
 <p>1 LED signals indicate different functions</p> <p>A0031589</p>	LED green (gn) Lit	Voltage supply is correct. The device is operational and the set limit values are met.
	LED green (gn) is flashing	At a frequency of 1 Hz: The device starts the self-calibration until detection has ended. At a frequency of 5 Hz for 5 s: Status OK, calibration point status OK detected.
	LED red (rd) and green (gn) are flashing alternately	At a frequency of 5 Hz: Status OK, calibration point status BAD detected.
	LED red (rd) is flashing	At a frequency of 1 Hz: It signals a diagnostic event (Warning). The device continues to measure. A diagnostic message is generated for the monitoring system.
	LED red (rd) is lit	It signals a diagnostic event (Alarm). Measurement is interrupted. The signal outputs take on the defined alarm condition. A diagnostic message is generated for the monitoring system.

 For detailed information, refer to Operating Instructions BA01581T.

9.3 Configuring the device

See "Operating menu and parameter description" →  78

9.3.1 Defining the measuring range

To configure the measuring range, enter the **4 mA value** and the **20 mA value**.

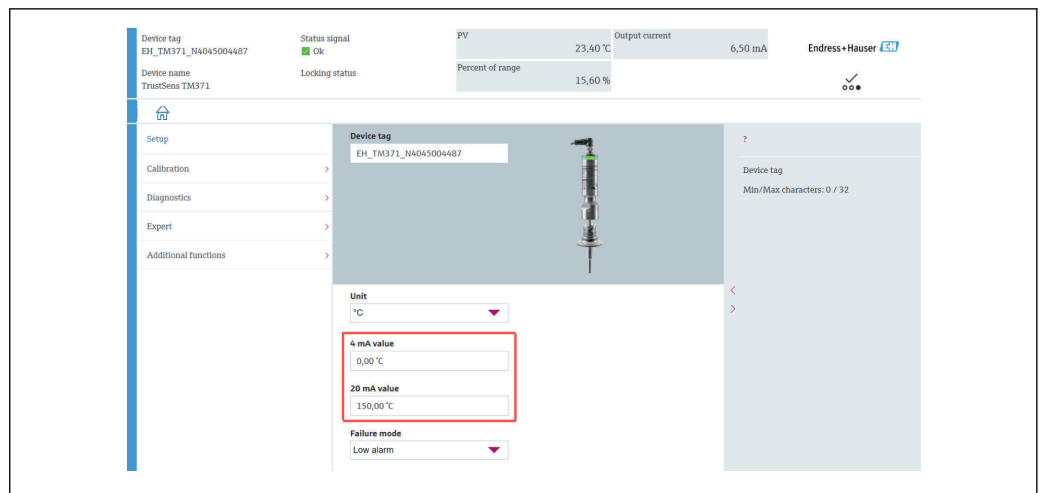

A0048542

Navigation

 "Setup" menu → 4 mA value

 "Setup" menu → 20 mA value

1. In the **4 mA value** input window, enter the lower range value of your measuring range and press ENTER to confirm.

2. In the **20 mA value** input window, enter the upper range value of your process measuring range and press ENTER to confirm.

9.3.2 Defining the intervention limits for self-calibration

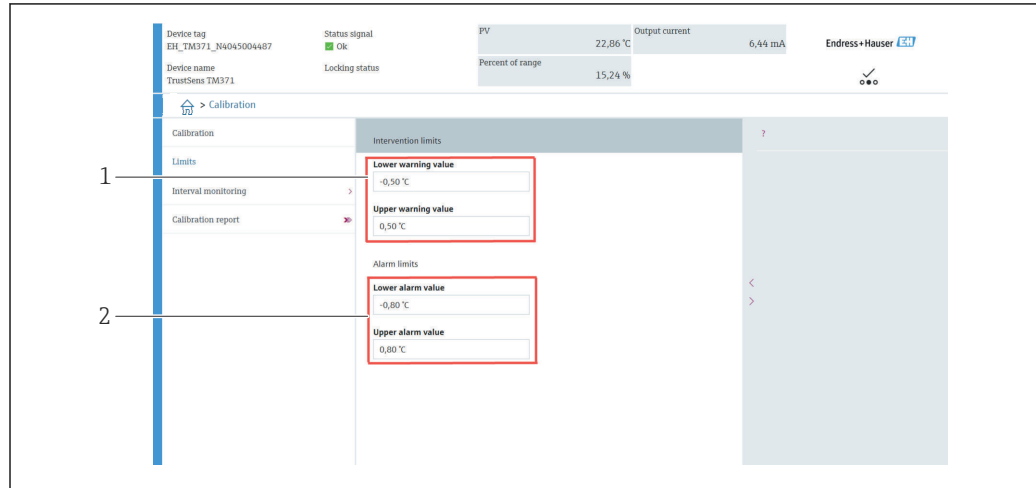

- 1 Values to be entered for the intervention limits
- 2 Values to be entered for the alarm limits

Use this function to define the lower and upper warning limit. The deviation between the reference sensor and the Pt100 sensor is determined as the result of each self-calibration. If this deviation exceeds the defined warning limit, the device transmits the defined status signal and shows the defined diagnostic behavior via the LED. (Factory setting = warning – red LED flashing, diagnostic number 144. Measured value status = Uncertain/Not limited).

Navigation

☰ "Calibration" menu → Limits → Intervention limits

1. In the **Lower warning value** input window, enter the lower warning limit for the self-calibration deviation and press ENTER to confirm.
2. In the **Upper warning value** input window, enter the upper warning limit for the self-calibration deviation and press ENTER to confirm.

9.3.3 Defining the alarm limits for the self-calibration

Use this function to define the lower and upper alarm limit. The deviation between the reference sensor and the Pt100 sensor is determined as the result of each self-calibration. If this deviation exceeds the defined alarm limit, the device transmits the defined status signal and shows the defined diagnostic behavior via the LED. (Factory setting = warning – red LED flashing, diagnostic number 143. Measured value status = Uncertain/Not limited.)

Navigation

☰ "Calibration" menu → Limits → Alarm limits

1. In the **Lower alarm value** input window, enter the lower limit for the self-calibration deviation and press ENTER to confirm.
2. In the **Upper alarm value** input window, enter the upper warning limit for the self-calibration deviation and press ENTER to confirm.

9.4 Creating a calibration report

The "Calibration report" wizard guides you systematically through the process for creating a calibration report for a pre-selected calibration point.

Navigation

☰ "Calibration" menu → Calibration report

i At least one stored self-calibration point must be in the device to start the online wizard.

Configuration and creation of a calibration report

1.

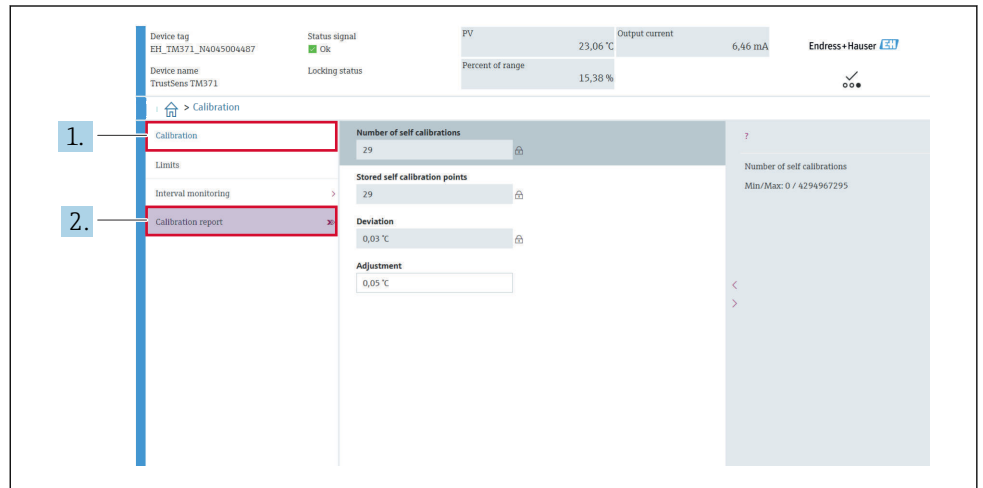

A0048544

Press **Calibration** to enter the calibration menu.

2.

Press **Calibration report** to open the calibration wizard.

3.

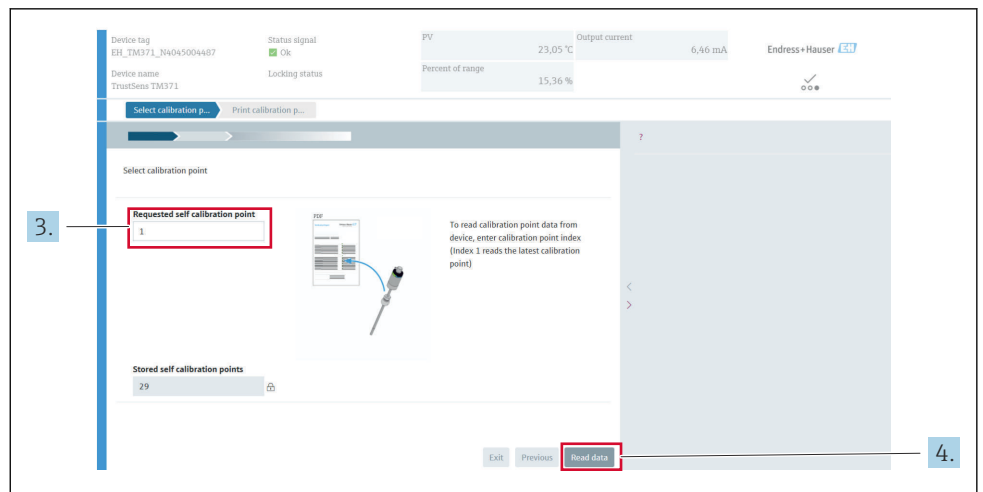

A0048545

To read the calibration point data from the device, enter the calibration point index. Index 1 reads the latest calibration point.

4.

Press **Read data** to confirm.

↳ An overview is displayed showing device information and calibration point data. See table below for detailed information.

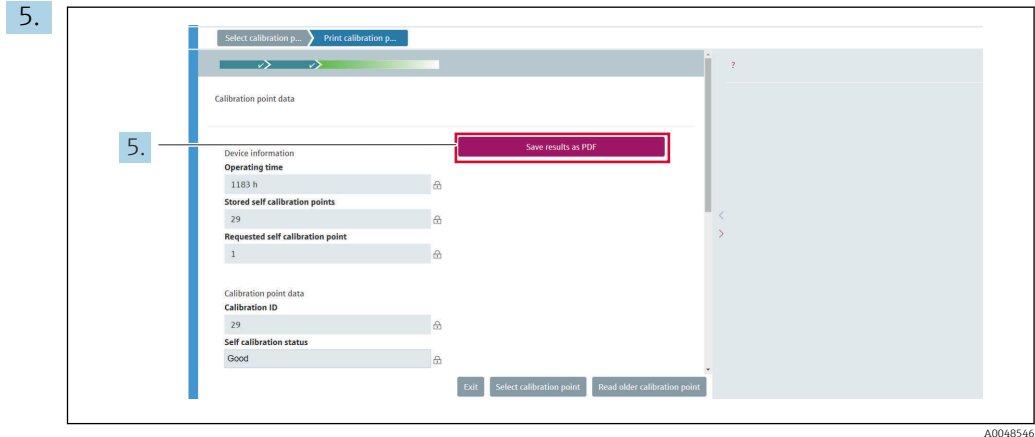

A0048546

Press **Save results as PDF** to confirm.

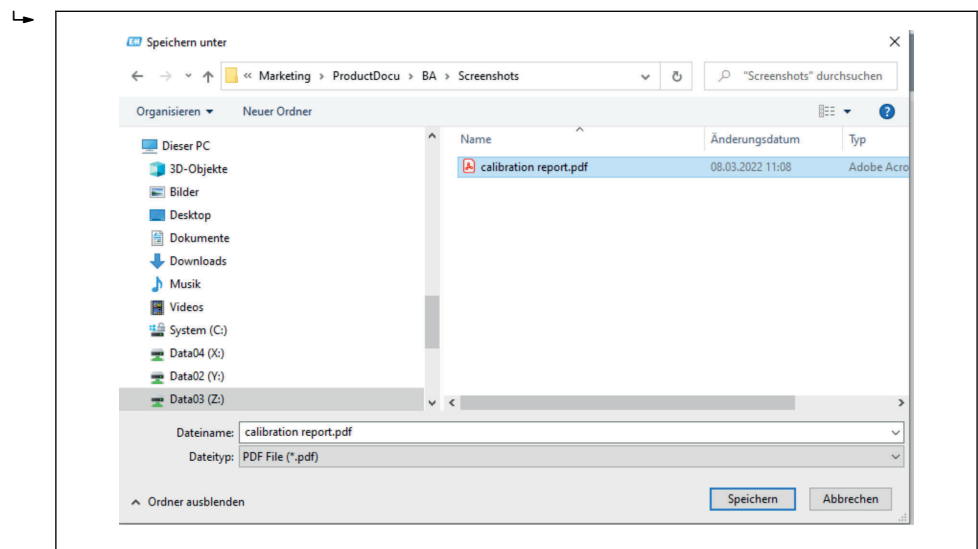

A0048547



Your file system explorer window appears. You are asked to save the calibration report as a PDF file.

6. Enter a file name for the calibration report and select a memory location in your file system.
 - ↳ The calibration report was thus saved in the file system.
7. Either press **Exit** to end the calibration report wizard, press **Select calibration point** to select another stored self-calibration point or press **Read older calibration point** to switch to the previous calibration point.

Creation of a self-calibration report is thus finished. The saved PDF file can be opened to read or to print the calibration report.

Self-calibration data relevant for report creation

Device information	
Operating time	Display of the total count of hours when the device was powered.
Stored self-calibration points	Displays the amount of all stored self-calibration points. This device can store up to 350 self-calibration points. As soon as the memory reaches its limit, the oldest self-calibration point is overwritten.
Requested self-calibration point	Enter the number of the requested self-calibration point. The latest self-calibration point always has the number "1".
Calibration point data	

Device information	
Calibration ID	Use this number to identify a self-calibration point. Each number is unique and is not editable.
Self-calibration status	This function shows the validity of the self-calibration point data.
Operating hours	This function displays the value of the operating hours counter of the self-calibration point shown.
Measured temperature value	This function displays the measured Pt100 temperature value at that specific time of the self-calibration.
Deviation	This function displays the measured Pt100 self-calibration deviation from the reference temperature. The deviation is calculated as follows: Self-calibration deviation = reference temperature - measured Pt100 temperature value + adjustment
Adjustment	This function displays the adjustment value added to the measured Pt100 value. This influences the self-calibration deviation. →  84 New adjustment = Adjustment - deviation of last self-calibration point
Measurement uncertainty	This function displays the maximum measurement uncertainty at the self-calibration temperature.
Lower alarm value	This function displays the defined lower alarm limit value. →  85
Upper alarm value	This function displays the defined upper alarm limit value. →  85
Device restart counter	Displays the device restarts between now and when the displayed self-calibration was executed.

9.5 Protecting settings from unauthorized access

This function protects the device from unwanted changes.

Navigation

 Expert menu → System → Administration → Define device write protection code

If the code is programmed into the device firmware, it is saved in the device and the operating tool displays the value **0** so that the defined write protection code is not openly displayed for viewing.

User entry: 0 to 9 999

Factory setting: 0 = write protection is not active.

Follow the steps below to activate write protection:

1. Define write protection in the **Enter access code** parameter.
2. Enter a code which does not correspond to the one which is defined in step 1.
 - ↳ The device is now write-protected.

Disabling write protection

- ▶ Enter the code defined in the **Enter access code** parameter.
 - ↳ The device is not write-protected.

 If the write protection code is forgotten, it can be deleted or overwritten by the service organization.

9.6 Advanced settings

This section contains descriptions of the additional parameters and technical data that are available with the **Heartbeat Verification** and **Heartbeat Monitoring** application packages.

9.6.1 Heartbeat Technology modules

Overview

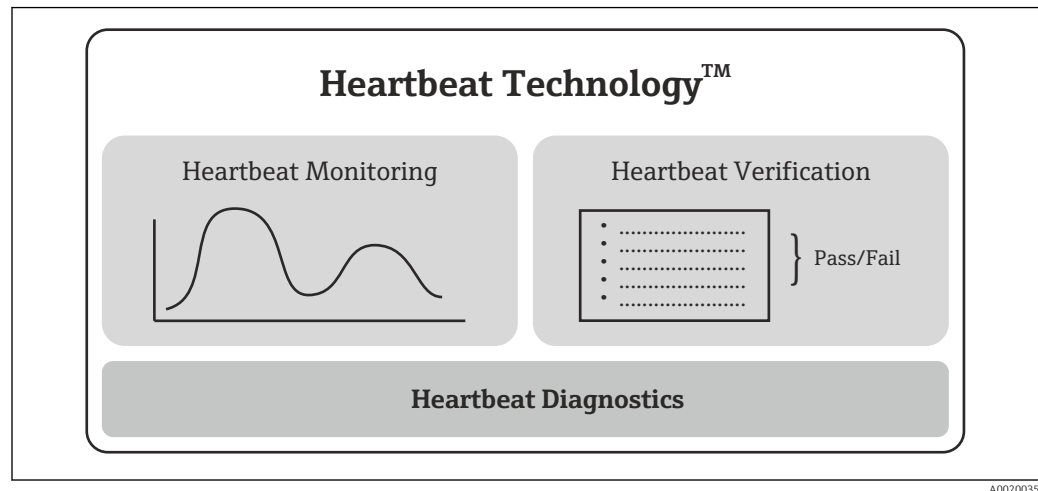

8 Heartbeat Technology modules

i The modules are available in all the device versions. The Heartbeat Technology functionality is available with the revised device driver software (DTM, version 1.11.zz and higher).

Short description of the modules

Heartbeat Diagnostics

Function

- Continuous self-monitoring of the device.
- Diagnostic messages output to
 - a local display, optional
 - an asset management system (e.g. FieldCare/DeviceCare)
 - an automation system (e.g. PLC)

Your benefits

- Device condition information is available immediately and processed in time.
- The status signals are classified in accordance with VDI/VDE 2650 and NAMUR Recommendation NE 107 and contain information about the cause of the error and remedial action.

Detailed description

→ 31

Heartbeat Verification

Device functionality checked on demand

- Verification of the correct functioning of the measuring instrument within specifications.
- The verification result provides information about the condition of the device: "Passed" or "Failed".
- The results are documented in a verification report.
- The automatically generated report supports the obligation to demonstrate compliance with internal and external regulations, laws and standards.
- Verification is possible without interrupting the process.

Your benefits

- No onsite access to the measuring instrument in the field is required to use the function.
- The DTM²⁾ triggers verification in the device and interprets the results. No specific knowledge is required on the part of the user.
- The verification report can be used to prove quality measures to a third party.
- **Heartbeat Verification** can replace other maintenance tasks (e.g. periodic check) or extend the test intervals.

Detailed description

→ 32

Heartbeat Monitoring

Function

Calibration information is logged in addition to the verification parameters. 350 calibration points are saved in the device (FIFO memory).

Your benefits

- Early detection of changes (trends) to ensure plant availability and product quality.
- Use of information for the proactive planning of measures (e.g. maintenance).

Detailed description

→ 34

9.6.2 Heartbeat Diagnostics

Device diagnostic messages, along with remedial measures, are displayed in the operating tool (FieldCare/DeviceCare).

For information on using the diagnostic messages, see the "Diagnostics and troubleshooting" section. → 35

Diagnostic message in the operating tool

1. Navigate to the **"Diagnostics"** menu.
 - ↳ The diagnostic event, along with the event text, is displayed in the **Actual diagnostics** parameter.
2. In the display area, hover the cursor over the **"Actual diagnostics"** parameter.

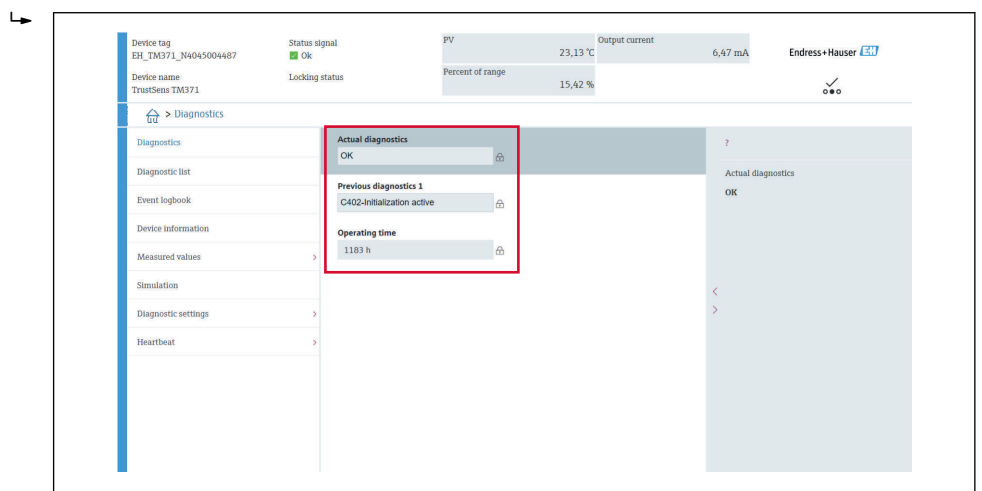

A0048549

2) DTM: Device Type Manager; controls device operation via DeviceCare, FieldCare, PACTware or a DTM-based control system.

9.6.3 Heartbeat Verification

Verification report

Creating the verification report using the wizard

i The wizard to create a verification report is only available if the device is operated via FieldCare, DeviceCare, PACTware or a DTM-based control system.

Navigation

Menu "Diagnostics → Heartbeat" → Heartbeat Verification

1.

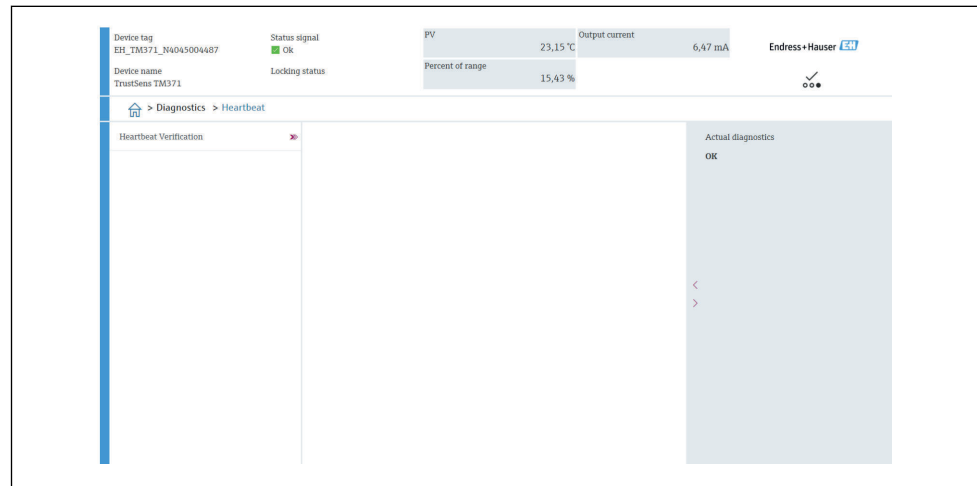

A0048550

Press the **Heartbeat Verification** button.

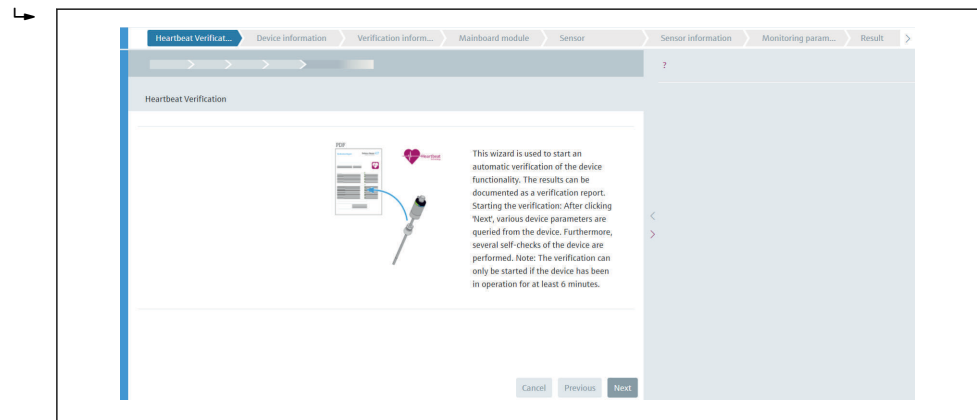

A0048551

The user-guided wizard appears.

2. Follow the instructions given by the wizard.

↳ The wizard guides you through the entire process of creating the verification report. The verification report can be saved in PDF and XML format.

i The device must be in operation for at least 6 minutes before a verification can be performed.

Content of the verification report

The verification report contains the results of the test objects: **Passed** or **Failed** is indicated as the result.

Verification report: general information

Parameter	Description/comments
Device information	
System operator	Name of the system operator; is defined when the verification report is created.
Location	Location of the device within the plant; is defined when the verification report is created.
Tag name	Unique name for the measuring point so it can be identified quickly within the plant. Is defined when commissioning the device.
Device name	Displays the device name. It can also be found on the nameplate. It cannot be changed.
Serial number	Displays the serial number of the device. It can also be found on the nameplate. It cannot be changed.
Order code	Displays the order code of the device. It can also be found on the nameplate. It cannot be changed.
Firmware version	Displays the device firmware version that is installed. It cannot be changed.
Verification information	
Operating time	Indicates how long the device has been in operation up to this point.
Date/time	Displays the current computer system time.
Comments	Allows the user to enter optional comments, which appear in the verification report.
Verification results	
The test result for all the test objects is given on the subsequent pages. The following results are possible:	<ul style="list-style-type: none"> ▪ <input checked="" type="checkbox"/>: Passed ▪ <input type="checkbox"/>: Failed

Test criteria for the test objects

Test object	Verification criterion
Mainboard module	
Electronics	Checks the correct functioning of the electronics.
Memory content	Checks the correct functioning of the data memory.
Guppy voltage	Checks the permitted supply voltage range.
Electronics temperature	Checks the permitted electronics temperature range or device temperature range.

Test object	Verification criterion
Sensor module	
Sensor	Checks whether the sensor works as per the specifications.
Reference temperature	Checks whether the reference sensor works as per the specifications.
Sensor drift warning limit exceeded	Checks whether the configured warning limits are exceeded.
Sensor drift alarm limit exceeded	Checks whether the configured alarm limits are exceeded.
Sensor information	
Number of self-calibrations	Displays all the self-calibrations executed up to now. This value cannot be reset.
Deviation	Displays the deviation of the measured value from the reference temperature.
Adjustment of the measurement	Displays the adjustment of the calibration deviation.
Monitoring parameters	
Device temperature min:	Displays the minimum electronics temperature measured in the past (minimum indicator).
Device temperature max:	Displays the maximum electronics temperature measured in the past (maximum indicator).
Sensor min value:	Displays the minimum temperature measured in the past at the sensor input (minimum indicator).
Sensor max. value:	Displays the maximum temperature measured in the past at the sensor input (maximum indicator).

Summary of results

Overall results	<p>Displays the overall result of the verification. The verification report can be saved in PDF and XML format. To save the report, click the Save results as PDF button or the Save results as XML button.</p> <p> If the verification fails, try again or contact the Service Organization.</p>
------------------------	--

9.6.4 Heartbeat Monitoring

Calibration information is logged in addition to the verification parameters.

HART variable	Output	Unit
PV	Temperature	°C/°F
SV	Device temperature	°C/°F
TV	Calibration counter	-
QV	Calibration deviation	°C/°F

Heartbeat Monitoring information can be read out and analyzed as described below:



A higher-level controller is configured in such a way that calibration deviations and the calibration counter are saved when the calibration counter changes. This type of function is supported by Endress+Hauser's Advanced Data Manager Memograph M RSG45, for example. The following table provides a sample overview of the monitoring analysis using the Field Data Manager software MS20:

Time stamp	Device name	Category	Text
25.07.2018	TrustSens 1 (example)	Self-calibration	EH_TM371_M7041504487: self-calibration (ID=183) Serial number: M7041504487 Device name: iTHERM TM371/372 Operating hours: 1626 h Reference temperature: 118.67 °C Measured temperature value: 118.68 °C Deviation: 0.01 °C Measurement uncertainty (k=2): 0.35 °C Max. permitted deviation: -0.80 / +0.80 °C Assessment
...

10 Diagnostics and troubleshooting

10.1 Troubleshooting

Always start troubleshooting with the checklists below if errors occur after start up or during operation. This takes you directly (via various queries) to the cause of the problem and the appropriate remedial action.

 Due to its design, the device cannot be repaired. However, it is possible to send the device back for examination. See the information in the “Return” section. →  40

General errors

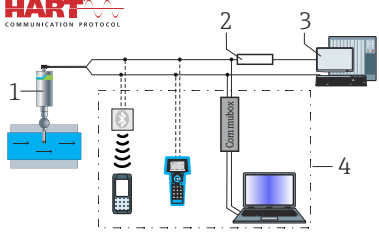
Error	Possible cause	Remedy
Device does not respond.	Supply voltage range does not match that specified on the nameplate.	Apply correct voltage, see nameplate.
	M12 plug is not connected correctly, wrong cable wiring.	Check cabling.
Output current < 3.6 mA	Device is defective.	Replace the device.
HART communication is not working.	Missing or incorrectly installed communication resistor.	Install the communication resistor (250 Ω) correctly.  <p style="text-align: right; font-size: small;">A0032326</p> <ol style="list-style-type: none"> 1 iTHERM TrustSens Compact thermometer 2 HART® communication resistor, $R \geq 250 \Omega$ 3 PLC/process control system 4 Configuration examples: FieldCare with Commubox, HART® handheld communicator as well as via Field Xpert SFX350/370
	Commubox is connected incorrectly.	Connect Commubox correctly.



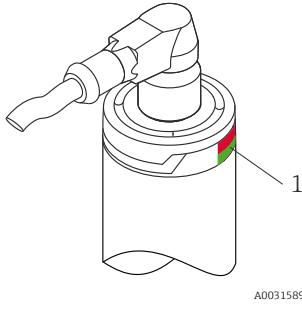

10.2 Diagnostic information via LEDs

Position	LEDs	Functional description
 <p>1 LED for device status indication</p> <p>A0031589</p>	LED green (gn) lit	Power supply is correct. The measuring device is operational and the set limit values are met.
	Green (gn) LED flashing	With a frequency of 1 Hz: self-calibration currently being performed. With a frequency of 5 Hz for 5 s: self-calibration finished and valid, all process criteria were within specifications. Calibration data stored.
	Red (rd) and green (gn) LEDs flashing alternately	Self-calibration is complete but not valid. Violation of the necessary process criteria. Calibration data not stored.
	Red (rd) LED flashing	Presence of a diagnostic event: "Warning"
	Red (rd) LED lit	Presence of a diagnostic event: "Alarm"

10.3 Diagnostic information

 Status signal and diagnostic behavior can be configured manually.

Status signal: Digital information available via HART® communication

Letter/symbol	Status signal	Meaning of the status signal ¹⁾
F 	Failure	The device or its peripheral behaves in such a way that the measured value is no longer valid. This includes errors/failures which are caused by the process being measured, but have an impact on the ability to perform a measurement. Example: "No process signal" detected.
C 	Function check	The device is deliberately serviced, configured, parameterized or is in simulation mode. A situation exists where the output signal does not represent the process value and is therefore not valid.
S 	Out of specification	The device is operating outside of its technical specifications or internal diagnostic functions indicate that the current process conditions increase the measurement uncertainty (i.e. during plant start-up or cleaning processes).
M 	Maintenance required	Deviation from normal operation, the device still works, but should be attended to soon to ensure continued operation, e.g. build-up, corrosion, zero point adjustment not possible or memory for data storage almost full.

1) Valid for the default mappings to the diagnostic numbers

Diagnostic behavior: Analog information via current output and LED

Diagnostic behavior	Meaning of the behavior
Alarm	Measurement is interrupted. Mostly the measured data is invalid and the configured failure current is set. A diagnostic message is generated.
Warning	Usually, the device continues to measure. A diagnostic message is generated.
Disabled	The diagnostic event is completely suppressed even if the device is not working properly.

Diagnostic event and event text

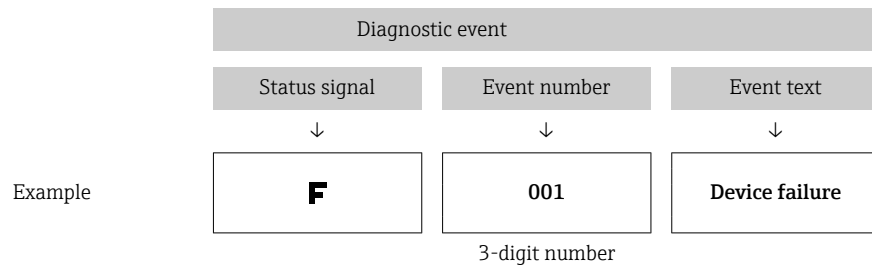

The error can be identified by means of the diagnostic event. The event text helps you by providing information about the error.

10.4 Overview of diagnostics events



Diagnostic events are assigned to a certain diagnostic number and a status signal. The user can change this assignment for certain diagnostic events.

Example:

Configuration example	Diagnostic number	Settings		Device behavior			
		Status signal	Diagnostic behavior (settings)	Status signal (output via HART® protocol)	Output current	PV, status	LED
Default setting	143	S	Warning	S	Measured value	Measured value, UNCERTAIN	Red is flashing
Manual configuration: Status signal S is switched to F	143	F	Warning	F	Measured value	Measured value, UNCERTAIN	Red is flashing
Manual configuration: diagnostic behavior Warning is switched to Alarm	143	S	Alarm	S	Configured failure current	Measured value, BAD	Red is illuminated
Manual configuration: Warning is switched to Disabled	143	S ¹⁾	Disabled	- ²⁾	Last valid measured value ³⁾	Last valid measured value, GOOD	Green is illuminated

- 1) Setting is not relevant.
- 2) Status signal is not indicated.
- 3) If there is no valid measured value, it is set to the failure current

Diagnostic number	Priority	Short text	Remedy	Status signal (factory default)	 Configurable ¹⁾	Diagnostic behavior from the factory	 Configurable ²⁾
					 Not configurable		 Not configurable
Diagnostics							
001	1	Device failure	1. Restart device. 2. Replace electronics.	F		Alarm	
004	2	Sensor defective	Replace device.	F		Alarm	

Diagnostic number	Priority	Short text	Remedy	Status signal (factory default)		Diagnostic behavior from the factory	
					Configurable ¹⁾		Configurable ²⁾
							
					Not configurable		
047	22	Sensor limit reached	1. Check sensor. 2. Check process conditions.	S		Warning	
105	26	Manual calibration interval expired	1. Execute calibration and reset calibration interval. 2. Switch off calibration counter	M		Warning	
143	21	Sensordrift Alarm limit exceeded	1. Check self calibration alarm limits. 2. Check value of adjustment. 3. Replace device	S		Warning	
144	27	Sensordrift warning limit exceeded	1. Check self calibration warning limits. 2. Check value of adjustment. 3. Replace device	M		Warning	
221	29	Reference sensor defective ³⁾	Replace device.	M		Warning	
401	15	Factory reset active	Factory reset in progress, please wait.	C		Warning	
402	16	Initialization active	Initialization in progress, please wait.	C		Warning	
410	3	Data transfer failed	1. Check connection. 2. Repeat data transfer.	F		Alarm	
411	17	Up-/download active	Up-/download in progress, please wait.	C		Warning	
435	5	Linearization faulty	Check linearization.	F		Alarm	
437	4	Configuration incompatible	Execute factory reset.	F		Alarm	
438	30	Dataset different	1. Check data set file. 2. Check device parameterization. 3. Download new device parameterization.	M		Warning	
485	18	Process variable simulation active-Sensor	Deactivate simulation.	C		Warning	
491	19	Output simulation - current output	Deactivate simulation.	C		Warning	
495	20	Diagnostic event simulation active	Deactivate simulation.	C		Warning	
501	6	Wiring error ⁴⁾	Check wiring.	F		Alarm	
531	6	Factory adjustment missing	1. Contact service organization. 2. Replace device.	F		Alarm	
	8	Factory adjustment missing-Sensor					
	9	Factory adjustment missing-Reference sensor					

Diagnostic number	Priority	Short text	Remedy	Status signal (factory default)	Configurable ¹⁾	Diagnostic behavior from the factory	Configurable ²⁾
					Not configurable		Not configurable
	10	Factory adjustment missing-Current output					
537	11	Configuration	1. Check device configuration 2. Up- and download new configuration	F		Alarm	
	12	Configuration-Sensor	1. Check sensor configuration. 2. Check device configuration.				
	13	Configuration-Reference sensor					
	14	Configuration-Current output	1. Check application 2. Check the current output parameterization				
801	23	Supply voltage too low	Increase supply voltage.	S		Alarm	
825	24	Operating temperature	1. Check ambient temperature. 2. Check process temperature.	S		Warning	
844	25	Process value out of specification	1. Check process value. 2. Check application. 3. Check sensor.	S		Warning	
905	28	Self calibration interval expired	1. Initiate self-calibration. 2. Deactivate self-calibration interval monitoring. 3. Replace device	M		Warning	

- 1) F, C, S, M, N can be configured
- 2) 'Alarm', 'Warning' and 'Disabled' can be configured
- 3) Reference sensor defective if temperature range of -45 to +200 °C (-49 to +392 °F) is exceeded. Temperature measurement continues, but self-calibration is permanently disabled.
- 4) Leading error cause: CDI modem and loop are connected simultaneously, based on wrong connection (CDI modem or loop only) or defective cable plug.

10.5 Diagnostic list

If more than three diagnostic events occur simultaneously, only the messages with the highest priorities are shown in the **Diagnostic list**. → 88

The characteristic feature of the displayed priority is the status signal, whereby the following sequence is observed: F, C, S, M. If there are several diagnostic events with the same status signal, the priority values from the table above are used to order the diagnostic events, e.g.: F001 is displayed in the first position, F501 in the second position and S047 in the last position.

10.6 Event logbook

Diagnostic events that are no longer pending are shown in the **Event logbook** submenu. → 89

11 Maintenance

11.1 Maintenance work

In general, no specific maintenance is required for this device.

11.2 Cleaning

11.2.1 Cleaning of surfaces not in contact with the medium

- Recommendation: Use a lint-free cloth that is either dry or slightly dampened using water.
- Do not use any sharp objects or aggressive cleaning agents that corrode the surfaces (e.g. displays, housing) and seals.
- Do not use high-pressure steam.
- Observe the degree of protection of the device.

 The cleaning agent used must be compatible with the materials of the device configuration. Do not use cleaning agents with concentrated mineral acids, bases or organic solvents.

11.2.2 Cleaning of surfaces in contact with the medium

Note the following for cleaning and sterilization in place (CIP/SIP):

- Use only cleaning agents to which the materials in contact with the medium are sufficiently resistant.
- Observe the permitted maximum medium temperature.

12 Repair

12.1 General notes

Due to its design, the device cannot be repaired.

12.2 Spare parts

Product spare parts that are currently available can be found online at: www.endress.com/onlinetools

12.3 Return

The requirements for safe device return can vary depending on the device type and national legislation.

1. Refer to the web page for information: <https://www.endress.com>
2. If returning the device, pack the device in such a way that it is reliably protected against impact and external influences. The original packaging offers the best protection.

12.4 Disposal



If required by the Directive 2012/19/EU on waste electrical and electronic equipment (WEEE), the product is marked with the depicted symbol in order to minimize the disposal of WEEE as unsorted municipal waste. Do not dispose of products bearing this marking as unsorted municipal waste. Instead, return them to the manufacturer for disposal under the applicable conditions.

13 Accessories

The accessories currently available for the product can be selected at www.endress.com:

1. Select the product using the filters and search field.
2. Open the product page.
3. Select **Spare parts & Accessories**.

13.1 Device-specific accessories

Device-specific accessories

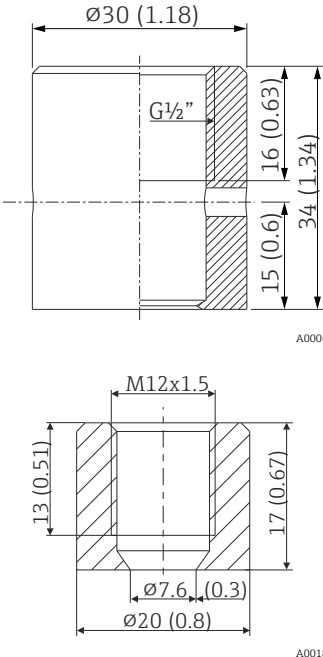
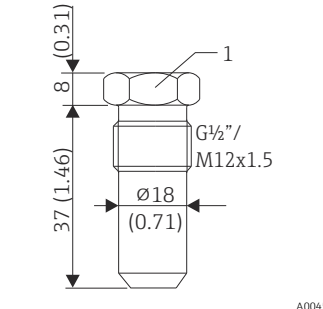
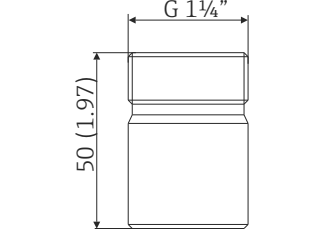
Accessory	Description
<p>Welding boss with sealing taper (metal - metal)</p>  <p>A0006621</p>	<p>Welding boss for G$\frac{1}{2}$" and M12x1.5 thread Metal-sealing; conical Material of wetted parts: 316L/1.4435 Max. process pressure 16 bar (232 PSI)</p> <p>Order number:</p> <ul style="list-style-type: none"> ■ 71424800 (G$\frac{1}{2}$") ■ 71405560 (M12x1.5)
<p>Dummy plug</p>  <p>1 Size across flats AF22</p> <p>A0045726</p>	<p>Dummy plug for G$\frac{1}{2}$" or M12x1.5 conical metal-sealing welding boss Material: SS 316L/1.4435</p> <p>Order number:</p> <ul style="list-style-type: none"> ■ 60022519 (G$\frac{1}{2}$") ■ 60021194 (M12x1.5)
<p>Weld-in adapter for Ingold process connection (OD 25 mm (0.98 in) x 50 mm (1.97 in)</p>  <p>A0008956</p>	<p>Material of wetted parts: 316L/1.4435 Weight: 0.32 kg (0.7 lb)</p> <p>Order numbers:</p> <ul style="list-style-type: none"> ■ 71531585 - with 3.1 material certificate ■ 71531588 <p>O-ring seal set</p> <ul style="list-style-type: none"> ■ Silicone O-ring in accordance with FDA CFR 21 ■ Maximum temperature: 230 °C (446 °F) ■ Order number: 60018911

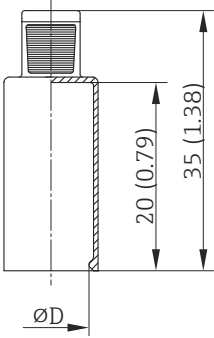
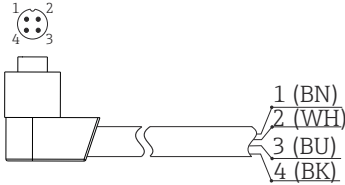
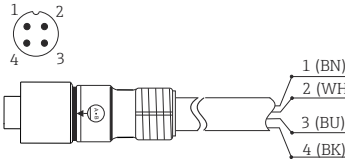
<p>Flexible handle cap to cover the iTHERM QuickNeck bottom part</p>  <p style="text-align: right;">A0027201</p>	<p>Diameter ØD: 24 to 26 mm (0.94 to 1.02 in) Material: Thermoplastic polyolefin - elastomer (TPE), free from plasticizers Maximum temperature: +150 °C (+302 °F) Order number: 71275424</p>
<p>M12x1 cable set, angle plug</p>  <p style="text-align: right;">A0020723</p>	<p>PVC cable, 4 x 0.34 mm² (22 AWG) with M12x1 coupling; angle plug; screw plug; length 5 m (16.4 ft); IP69K Order number: 71589963</p> <p>Wire colors:</p> <ul style="list-style-type: none"> ■ 1 = BN brown (+) ■ 2 = WH white (nc) ■ 3 = BU blue (-) ■ 4 = BK black (nc)
<p>M12x1 cable set, straight</p>  <p style="text-align: right;">A0020725</p>	<p>PVC cable, 4 x 0.34 mm² (22 AWG) with M12x1 coupling nut made of epoxy coated zinc; straight female connector type; screw plug; length 5 m (16.4 ft); IP69K Order number: 71217708</p> <p>Wire colors:</p> <ul style="list-style-type: none"> ■ 1 = BN brown (+) ■ 2 = WH white (nc) ■ 3 = BU blue (-) ■ 4 = BK black (nc)

13.1.1 Weld-in adapter

 For detailed information about the order code and hygienic compliance of the adapters and spare parts, see the Technical Information (TI00426F).

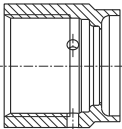
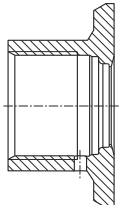
Weld-in adapter	Material	Roughness µm (µin) process side
 <p style="text-align: right;">A0008246</p> <p>G ¾, d=29 pipe-mounting</p>	316L (1.4435)	≤1.5 (59.1)
 <p style="text-align: right;">A0008251</p> <p>G ¾, d=50 vessel-mounting</p>	316L (1.4435)	≤0.8 (31.5)

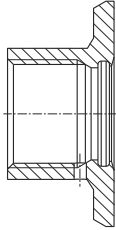
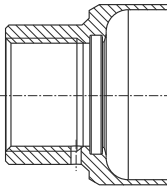
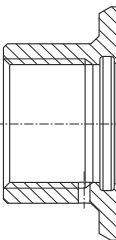
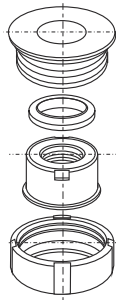
 <p style="text-align: right; font-size: small;">A0008256</p> <p style="text-align: center;">G 3/4", d=55, with flange</p>	316L (1.4435)	≤0.8 (31.5)
 <p style="text-align: right; font-size: small;">A0011924</p> <p style="text-align: center;">G 1", d=53, without flange</p>	316L (1.4435)	≤0.8 (31.5)
 <p style="text-align: right; font-size: small;">A0008248</p> <p style="text-align: center;">G 1", d=60, with flange</p>	316L (1.4435)	≤0.8 (31.5)
 <p style="text-align: right; font-size: small;">A0008253</p> <p style="text-align: center;">G 1" adjustable</p>	316L (1.4435)	≤0.8 (31.5)

- i** Maximum process pressure for the weld-in adapters:
- 25 bar (362 PSI) at maximum 150 °C (302 °F)
 - 40 bar (580 PSI) at maximum 100 °C (212 °F)

13.2 Service-specific accessories

13.2.1 Modems/Edge devices

Commubox FXA195 USB/HART modem

Connects intrinsically safe 'smart transmitters' with a HART protocol to the USB interface of a laptop/PC. This enables the remote operation of the transmitters with FieldCare.

 Technical Information TI00404F

www.endress.com/fxa195

13.2.2 Software

DeviceCare SFE100

DeviceCare is an Endress+Hauser configuration tool for field devices using the following communication protocols: HART, PROFIBUS DP/PA, FOUNDATION Fieldbus, IO/Link, Modbus, CDI and Endress+Hauser Common Data Interfaces.

 Technical Information TI01134S
www.endress.com/sfe100

FieldCare SFE500

FieldCare is a configuration tool for Endress+Hauser and third-party field devices based on DTM technology.

The following communication protocols are supported: HART, WirelessHART, PROFIBUS, FOUNDATION Fieldbus, Modbus, IO-Link, EtherNet/IP, PROFINET and PROFINET APL.

 Technical Information TI00028S
www.endress.com/sfe500

Netilion

With the Netilion IIoT ecosystem, Endress+Hauser enables the optimization of plant performance, digitization of workflows, sharing of knowledge and improved collaboration. Drawing upon decades of experience in process automation, Endress+Hauser offers the process industry an IIoT ecosystem designed to effortlessly extract insights from data. These insights allow process optimization, leading to increased plant availability, efficiency, reliability and ultimately a more profitable plant.

 www.netilion.endress.com

Field Xpert SMT50

Universal, high-performance tablet PC for device configuration.

 Technical Information TI01555S
www.endress.com/smt50

Field Xpert SMT77 via WLAN

Universal, high-performance tablet PC for device configuration in Ex Zone 1 areas.

 Technical Information TI01418S
www.endress.com/smt77

SmartBlue app

SmartBlue from Endress+Hauser allows easy wireless field device configuration via Bluetooth® or WLAN. By providing mobile access to diagnostic and process information, SmartBlue saves time, even in hazardous and difficult-to-access environments.

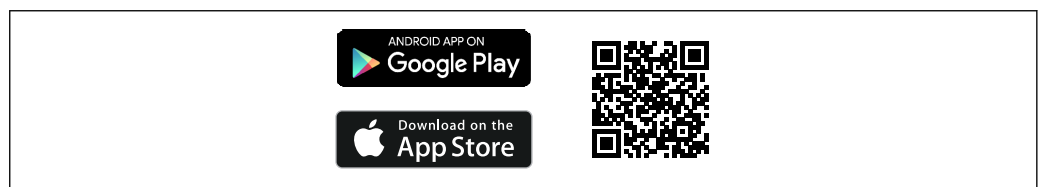

A0033202

 9 QR code for free Endress+Hauser SmartBlue app

13.3 Communication-specific accessories

Field Data Manager (FDM) analysis software MS20, MS21

- Field Data Manager (FDM) is a software which provides central data management and visualization. This enables the continuous, tamper-free archiving of process data, e.g. measured values and diagnostic events. "Live data" from connected devices is available. FDM saves the data in an SQL database.
- Supported databases: PostgreSQL (included in the delivery), Oracle or Microsoft SQL server.
- MS20 single-user license: Installing the software on a computer.
- MS21 multi-user license: Several simultaneous users, dependent on the number of available licenses.



Technical Information TI01022R

www.endress.com/ms20

www.endress.com/ms21

OPC DA server RXO20

The OPC DA server transmits process data such as instantaneous values or totalizers from connected Endress+Hauser field devices and provides them to the OPC clients in real time. These data can be visualized with OPC client software. Communication takes place via an RS232/RS485 interface or a TCP/IP connection. OPC is used in systems of various sizes in factory and process automation.



Technical Information TI00122R

www.endress.com/rxo20

Configuration kit TXU10

Configuration kit for PC-programmable transmitter - FDT/DTM-based plant asset management tool, FieldCare/DeviceCare, and interface cable (4-pin connector) for PC with USB port.

For more information, please refer to: www.endress.com

13.4 Online tools

Product information about the entire life cycle of the device is available at:

www.endress.com/onlinetools

13.5 System components

Data Manager of the RSG product family

Data Managers are flexible and powerful systems to organize process values. Up to 20 universal inputs and up to 14 digital inputs for direct connection of sensors, optionally with HART, are available as an option. The measured process values are clearly presented on the display and logged safely, monitored for limit values and analyzed. The values can be forwarded via common communication protocols to higher-level systems and connected to one another via individual plant modules.

For more information, please refer to: www.endress.com

Process indicators from the RIA product family

Easily readable process indicators with various functions: loop-powered indicators for displaying 4-20 mA values, display of up to four HART variables, process indicators with control units, limit value monitoring, sensor power supply, and galvanic isolation.

Universal application thanks to international hazardous area approvals, suitable for panel mounting or field installation..

For more information, please refer to: www.endress.com

RN series active barrier

Single- or two-channel active barrier for safe separation of 0/4 to -20 mA standard signal circuits with bidirectional HART transmission. In the signal duplicator option, the input signal is transmitted to two galvanically isolated outputs. The device has one active and one passive current input; the outputs can be operated actively or passively.

For more information, please refer to: www.endress.com

14 Technical data

14.1 Input

Measuring range	Pt100 thin-film (TF): <ul style="list-style-type: none"> ■ -40 to +160 °C (-40 to +320 °F) ■ Optional -40 to +190 °C (-40 to +374 °F)
-----------------	---

14.2 Output

Output signal	Analog output	4 to 20 mA
	Digital output	HART protocol (revision 7)

Failure information as per NAMUR NE43:
 Failure information is created if the measuring information is missing or not valid. A complete list of all the errors occurring in the measuring system is created.

Underranging	Linear decrease from 4.0 to 3.8 mA
Overranging	Linear increase from 20.0 to 20.5 mA
Failure, e.g. sensor breakage, sensor short-circuit	≤ 3.6 mA ("low") or ≥ 21.5 mA ("high"), can be selected The "high" alarm setting can be set between 21.5 mA and 23 mA, thus providing the flexibility needed to meet the requirements of various control systems.

Load Maximum possible HART communication resistance

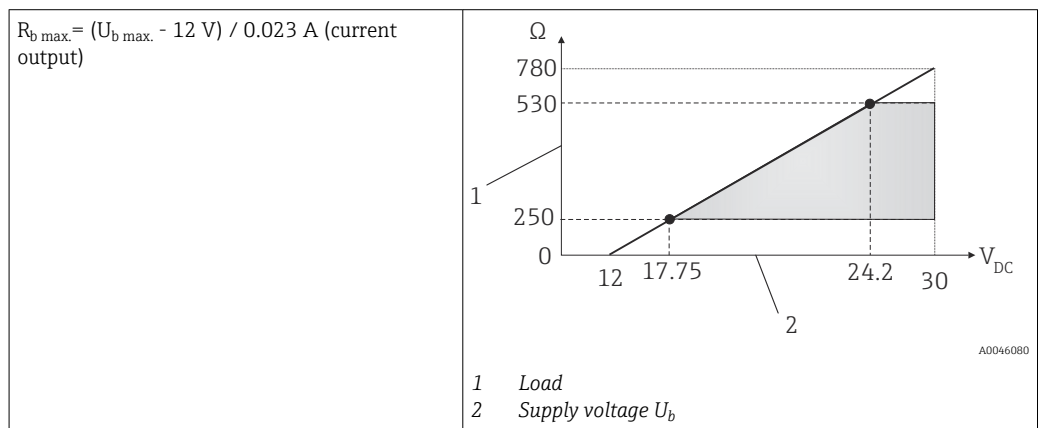

Linearization/transmission behavior Temperature-linear

Filter 1st order digital filter: 0 to 120 s, factory setting: 0 s (PV)

Protocol-specific data

HART

Manufacturer ID	17 (0x11)
Device type ID	0x11CF
HART revision	7
Device description files (DTM, DD)	Information and files at: <ul style="list-style-type: none"> ▪ www.endress.com/downloads ▪ www.fieldcommgroup.org
HART load	Min. 250 Ω
HART device variables	<p>Measured value for PV (primary value) Temperature</p> <p>Measured values for SV, TV, QV (secondary, tertiary and quaternary variable)</p> <ul style="list-style-type: none"> ▪ SV: Device temperature ▪ TV: Calibration counter ▪ QV: Calibration deviation
Supported functions	<ul style="list-style-type: none"> ▪ Additional transmitter status ▪ NE107 diagnostics

Startup behavior / wireless HART data

Minimum start-up voltage	12 V _{DC}
Start-up current	3.58 mA
Start-up time	< 7 s, until the first valid measured value signal is present at the current output
Minimum operating voltage	12 V _{DC}
Multidrop current	4 mA
Lead time	0 s

14.3 Electrical connection

 According to the 3-A Sanitary Standard and EHEDG, electrical connecting cables must be smooth, corrosion-resistant and easy to clean.

Supply voltage U_b = 12 to 30 V_{DC}

 The device may only be powered by a power supply unit with a limited energy electric circuit in accordance with UL/EN/IEC 61010-1 chapter 9.4 or Class 2 according to UL 1310, "SELV or Class 2 circuit".

Current consumption

- I = 3.58 to 23 mA
- Minimum current consumption: I = 3.58 mA Multidrop, multi-drop mode I = 4 mA
- Maximum current consumption: I ≤ 23 mA

Electrical connection

- i** To prevent any kind of damage to the device electronics, leave pins 2 and 4 unconnected. They are reserved for the connection of the configuration cable.
- Do not tighten the M12 plug too much, in order to prevent damage to the device.
Maximum torque: 0.4 Nm (M12 knurl)

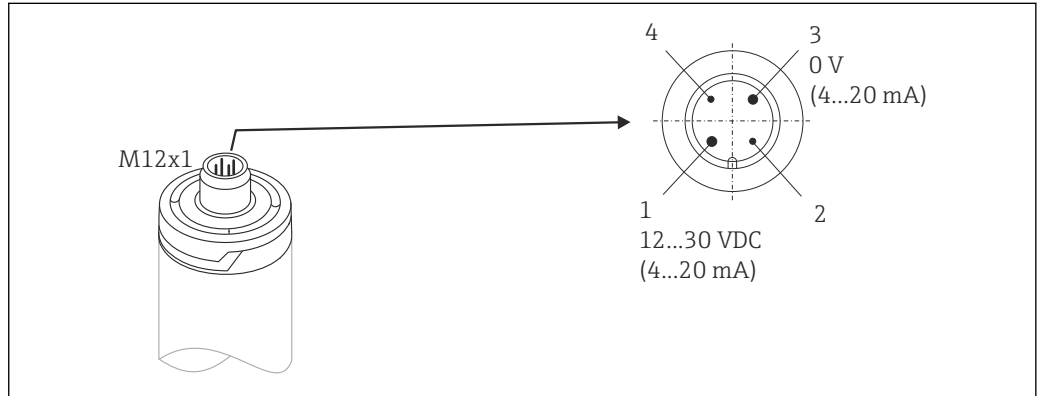

A0030963

10 Pin assignment of the device connecting socket

- 1 Power supply 12 to 30 V_{DC}; current output 4 to 20 mA
- 2 Reserved for configuration cable
- 3 Power supply 0 V_{DC}; current output 4 to 20 mA
- 4 Reserved for configuration cable

Device plug connection

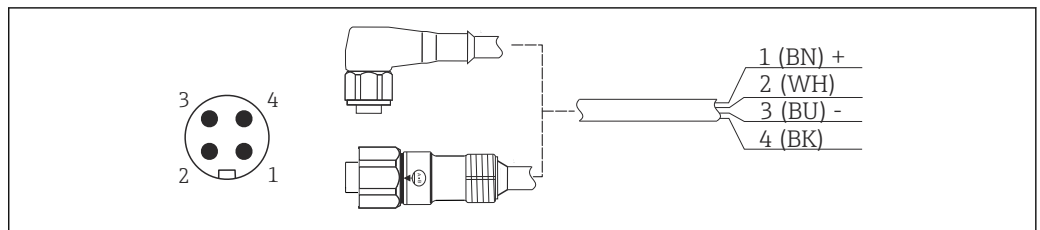

A0030965

11 Pin assignment of the plug connector

- 1 Power supply +, wire color brown = BN
- 2 Connection of PC configuration cable, wire color white = WH
- 3 Power supply -, wire color blue = BU
- 4 Connection of PC configuration cable, wire color black = BK

- i** Appropriate cord sets with straight or angle plugs are available as accessories.

Overvoltage protection

To protect against overvoltage in the power supply and signal/communication cables for the thermometer electronics, Endress+Hauser offers the HAW562 surge arrester for DIN rail mounting.

- i** For more information, see the Technical Information 'HAW562 Surge arrester' TI01012K

14.4 Performance characteristics

Reference operating conditions

- Ambient temperature: 25 °C ± 5 °C (77 °F ± 9 °F)
- Supply voltage: 24 V_{DC}

Internal calibration points

Calibration point	Tolerance	Lowest possible calibration point	Highest possible calibration point
118 °C (244.4 °F)	+1.2 K / -1.7 K	Lowest possible calibration point = 116.3 °C (241.3 °F)	Highest possible calibration point = 119.2 °C (246.6 °F)
39 °C (102.2 °F)	±2 K	Lowest possible calibration point = 37 °C (98.6 °F)	Highest possible calibration point = 41 °C (105.8 °F)

i The individual calibration point of each iTHERM TrustSens device is indicated in the calibration certificate supplied ex works.

Measurement uncertainty

The given uncertainty values include non-linearity and non-repeatability and correspond to ±2 σ (95% confidence level according to the Gaussian distribution curve).

i Each device is calibrated and matched by default before shipment to guarantee the given accuracy.

Calibration point ¹⁾	Uncertainty of self-calibration	Uncertainty
118 °C (244.4 °F)	Excellent	< 0.35 K (0.63 °F)
	Standard	< 0.55 K (0.99 °F)
39 °C (102.2 °F)	Standard	< 0.49 K (0.88 °F)

1) The uncertainty of the self-calibration can be compared with the uncertainty of manual on-site calibration using a mobile dry block calibrator. Depending on the equipment used and the qualification of the person who is performing the calibration, an uncertainty of > 0.3 K (0.54 °F) is standard.

Uncertainty of the temperature sensor including digital output (HART value) at reference conditions as delivered to the customer:	
Process temperature:	
+20 to +135 °C (+68 to +275 °F)	< 0.22 K (0.4 °F)
+135 to +160 °C (+275 to +320 °F)	< 0.38 K (0.68 °F)
+160 to +170 °C (+320 to +338 °F)	< 0.5 K (0.90 °F)
+170 to +180 °C (+338 to +356 °F)	< 0.6 K (1.08 °F)
+180 to +190 °C (+356 to +374 °F)	< 0.8 K (1.44 °F)
0 to +20 °C (+32 to +68 °F)	< 0.27 K (0.49 °F)
-20 to 0 °C (-4 to +32 °F)	< 0.46 K (0.83 °F)
-40 to -20 °C (-40 to -4 °F)	< 0.8 K (1.44 °F)
Uncertainty of D/A converter (analog output current)	0.03 % of the measuring range

Long-term drift

Pt100 sensing element	< 1000 ppm/1000 h ¹⁾
A/D converter (digital output - HART)	< 500 ppm/1000 h ¹⁾
D/A converter (analog output - current)	< 100 ppm/1000 h

1) This is detected by the self-calibration

i Long-term drift decreases at an exponential rate over time. This means that it may not be extrapolated in a linear way for time spans longer than the values specified above.

Ambient temperature effect	A/D converter (digital output - HART) at typical operating conditions	< 0.05 K (0.09 °F)
	A/D converter (digital output - HART) at maximum operating conditions	< 0.15 K (0.27 °F)
	D/A converter (analog output - current)	≤ 30 ppm/°C (2σ), related to the deviation from the reference temperature

Typical operating conditions

- Ambient temperature: 0 to +40 °C (+32 to +104 °F)
- Process temperature: 0 to +140 °C (+32 to +284 °F)
- Power supply: 18 to 24 V_{DC}

Influence of supply voltage	<i>According to IEC 61298-2:</i>	
	A/D converter (digital output - HART) at typical operating conditions	< 15 ppm/V ¹⁾
	D/A converter (analog output - current)	< 10 ppm/V ¹⁾

1) Related to the deviation from the reference supply voltage

Sample calculation with Pt100, measuring range +20 to +135 °C (+68 to +275 °F), ambient temperature +25 °C (+77 °F), supply voltage 24 V:

Measured error digital	0.220 K (0.396 °F)
Measured error D/A = 0.03 % x 150 °C (302 °F)	0.045 K (0.081 °F)
Measured error digital value (HART):	0.220 K (0.396 °F)
Measured error analog value (current output): $\sqrt{(\text{Measured error digital}^2 + \text{Measured error D/A}^2)}$	0.225 K (0.405 °F)

Sample calculation with Pt100, measuring range +20 to +135 °C (+68 to +275 °F), ambient temperature +35 °C (+95 °F), supply voltage 30 V:

Measured error digital	0.220 K (0.396 °F)
Measured error D/A = 0.03 % x 150 °C (302 °F)	0.045 K (0.081 °F)
Influence of ambient temperature (digital)	0.050 K (0.090 °F)
Influence of ambient temperature (D/A) = (35 °C - 25 °C) x (30 ppm/°C x 150 °C)	0.045 K (0.081 °F)
Influence of supply voltage (digital) = (30 V - 24 V) x 15 ppm/V x 150 °C	0.014 K (0.025 °F)
Influence of supply voltage (D/A) = (30 V - 24 V) x 10 ppm/V x 150 °C	0.009 K (0.016 °F)
Measured error digital value (HART): $\sqrt{(\text{Measured error digital}^2 + \text{Influence of ambient temperature (digital)}^2 + \text{Influence of supply voltage (digital)}^2)}$	0.226 K (0.407 °F)
Measured error analog value (current output): $\sqrt{(\text{Measured error digital}^2 + \text{Measured error D/A}^2 + \text{Influence of ambient temperature (digital)}^2 + \text{Influence of ambient temperature (D/A)}^2 + \text{Influence of supply voltage (digital)}^2 + \text{Influence of supply voltage (D/A)}^2)}$	0.235 K (0.423 °F)

Response time Tests in water at 0.4 m/s (1.3 ft/s), according to IEC 60751; 10 K temperature step change. t_{63} / t_{90} are defined as the time that passes until the instrument output reaches 63% / 90% of the new value.

Response time with heat transfer paste ¹⁾

Protection tube	Shape of tip	Insert	t_{63}	t_{90}
∅6 mm (0.24 in)	Reduced 4.3 mm (0.17 in) x 20 mm (0.79 in)	∅3 mm (0.12 in)	2.9 s	5.4 s
∅9 mm (0.35 in)	Straight	∅6 mm (0.24 in)	9.1 s	17.9 s
	Reduced 5.3 mm (0.21 in) x 20 mm (0.79 in)	∅3 mm (0.12 in)	2.9 s	5.4 s
∅12.7 mm (½ in)	Straight	∅6 mm (0.24 in)	10.9 s	24.2 s
	Reduced 5.3 mm (0.21 in) x 20 mm (0.79 in)	∅3 mm (0.12 in)	2.9 s	5.4 s
	Reduced 8 mm (0.31 in) x 32 mm (1.26 in)	∅6 mm (0.24 in)	10.9 s	24.2 s

1) Between the insert and the protection tube.

Response time without heat transfer paste

Protection tube	Shape of tip	Insert	t_{63}	t_{90}
Without protection tube	-	∅6 mm (0.24 in)	5.3 s	10.4 s
∅6 mm (0.24 in)	Reduced 4.3 mm (0.17 in) x 20 mm (0.79 in)	∅3 mm (0.12 in)	7.4 s	17.3 s
∅9 mm (0.35 in)	Straight	∅6 mm (0.24 in)	24.4 s	54.1 s
	Reduced 5.3 mm (0.21 in) x 20 mm (0.79 in)	∅3 mm (0.12 in)	7.4 s	17.3 s
∅12.7 mm (½ in)	Straight	∅6 mm (0.24 in)	30.7 s	74.5 s
	Reduced 5.3 mm (0.21 in) x 20 mm (0.79 in)	∅3 mm (0.12 in)	7.4 s	17.3 s
	Reduced 8 mm (0.31 in) x 32 mm (1.26 in)	∅6 mm (0.24 in)	30.7 s	74.5 s

Calibration

Calibration of thermometers

Calibration refers to the comparison between the display of a piece of measuring equipment and the true value of a variable provided by the calibration standard under defined conditions. The aim is to determine the deviation or measurement errors of the UUT's measured values from the true value of the measured variable. Two different methods are used for thermometers:

- Calibration at fixed points, e.g. at the freezing point, the solidification point, of water at 0 °C
- Comparison method using a precise reference thermometer

The thermometer to be calibrated must display the fixed point temperature or the temperature of the reference thermometer as accurately as possible. Temperature-controlled calibration baths or special calibration furnaces with homogeneous distribution of temperature are typically used for thermometer calibrations. The unit under test (UUT) and the reference thermometer are placed closely together into the bath or furnace at a sufficient depth.

The measurement uncertainty can increase due to heat conduction errors and short immersion lengths. The existing measurement uncertainty is listed on the individual calibration certificate.

For accredited calibrations according to IEC/ISO 17025, the measurement uncertainty must not be twice as high as the accredited measurement uncertainty of the laboratory. If the limit value is exceeded, only a factory calibration can be carried out.

 For manual calibration in calibration baths, the maximum immersion length of the device ranges from the sensor tip to the lower part of the electronic housing.

Do not immerse the housing in the calibration bath.

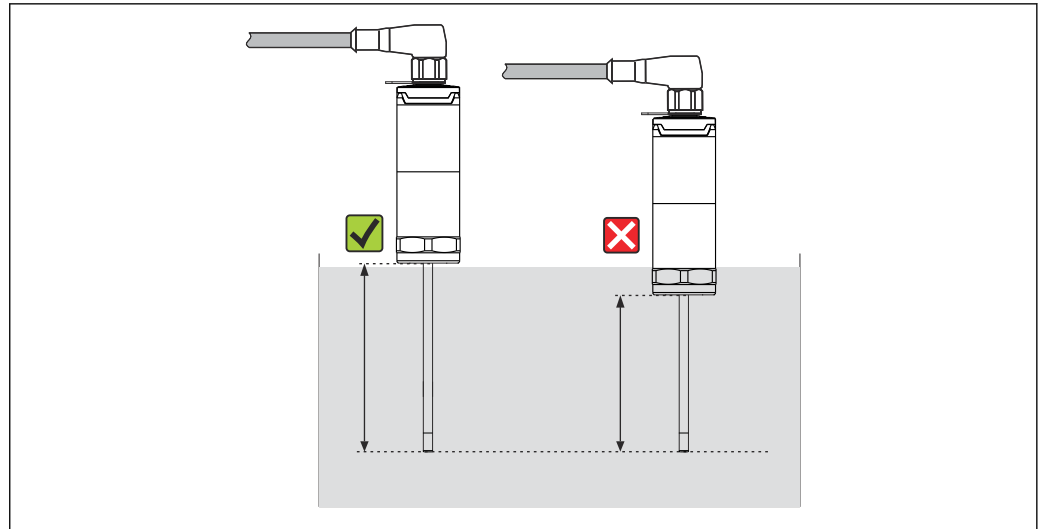

Self-calibration

The self-calibration procedure uses the Curie temperature (T_c) of a reference material as a built-in temperature reference. A self-calibration is performed automatically when the process temperature (T_p) falls below the nominal Curie Temperature (T_c) of the device. At the Curie temperature, a phase change of the reference material takes place, which is associated with a change in its electrical properties. The electronics unit detects this change automatically and simultaneously calculates the deviation of the measured Pt100 temperature from the known Curie temperature, which is a physical fixed point. The iTHERM TrustSens thermometer is calibrated. A green flashing LED light indicates the ongoing self-calibration process. Subsequently the thermometer electronics stores the results of this calibration. The calibration data can be read via an asset management software such as FieldCare or DeviceCare. A self-calibration certificate can be created automatically. This in situ self-calibration makes it possible to continuously and repeatedly monitor changes to the properties of the Pt100 sensor and the electronics unit. As the in situ calibration is being performed under real ambient or process conditions (e.g. heating of electronics), the result is closer to reality than a sensor calibration under laboratory conditions.

Process criteria for self-calibration

To ensure a valid self-calibration within the given measurement accuracy, the process temperature characteristics must fulfill the criteria, which are checked by the device

automatically. Based on this, the device is ready to perform a self-calibration under the following conditions:

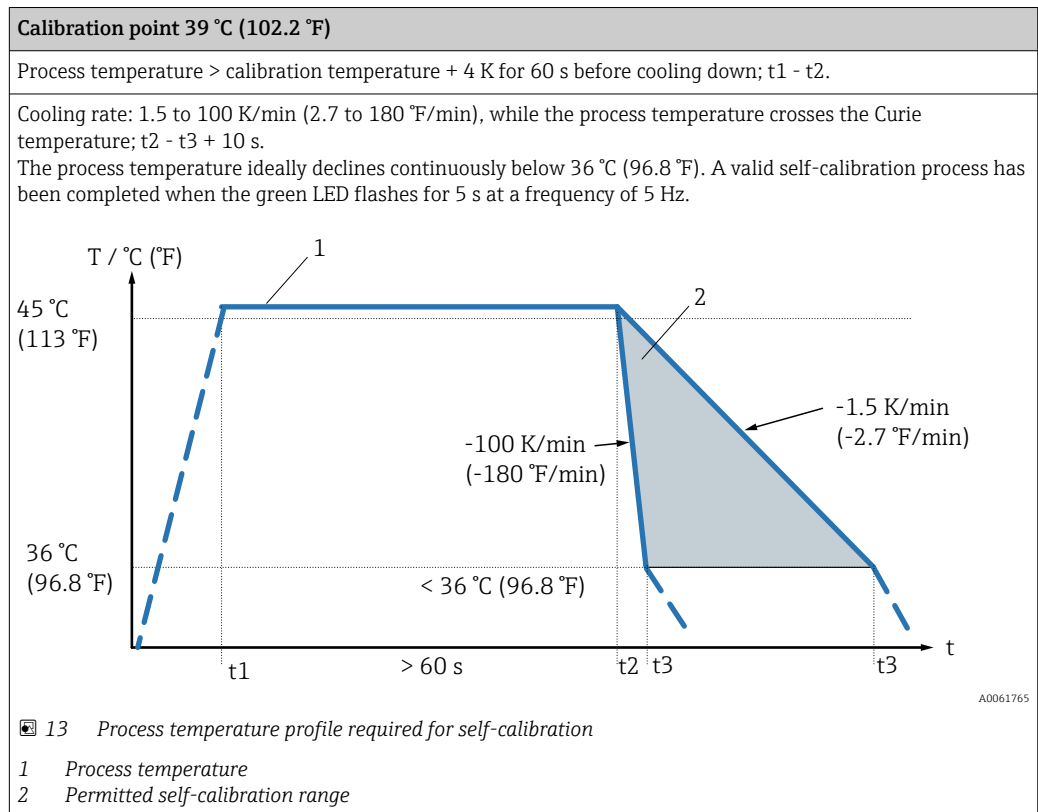
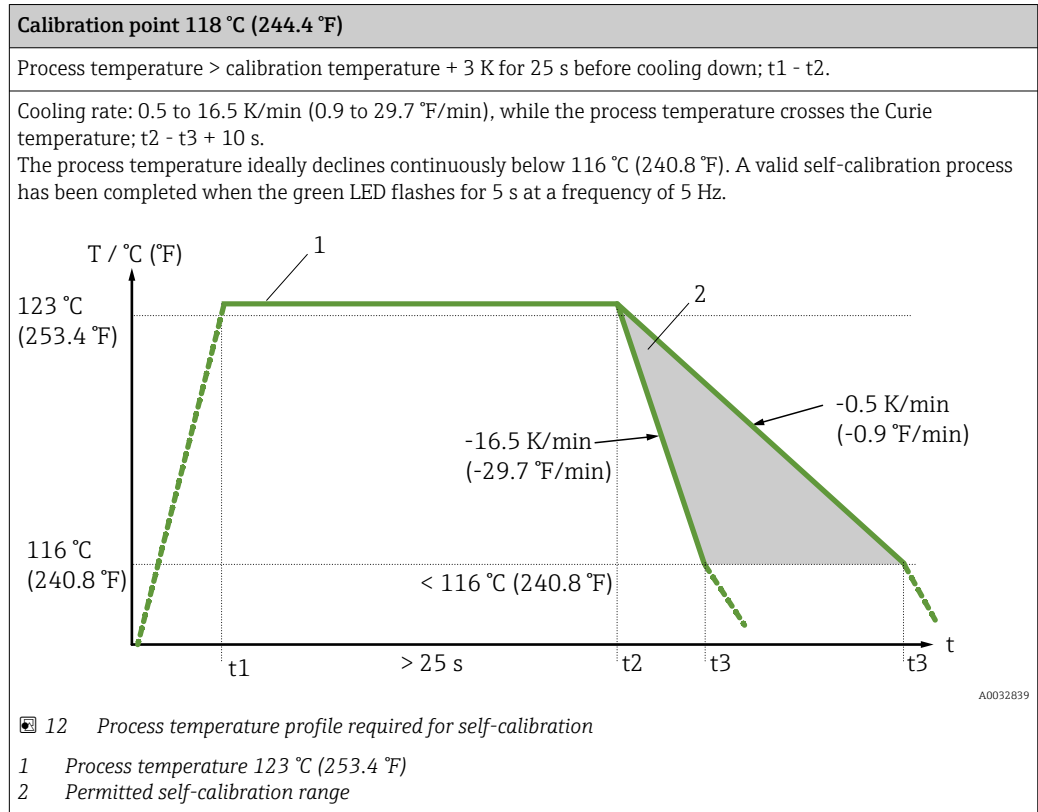

Calibration monitoring

Available in conjunction with the Advanced Data Manager Memograph M (RSG45).

Application package:

- Up to 20 devices can be monitored via the HART interface
- Self-calibration data displayed on screen or via the web server
- Generation of a calibration history
- Creation of a calibration certificate as an RTF file directly at the RSG45
- Evaluation, analysis and further processing of the calibration data using "Field Data Manager" (FDM) analysis software

Insulation resistance Insulation resistance $\geq 100 \text{ M}\Omega$ at ambient temperature, measured between the terminals and the outer jacket with a minimum voltage of $100 \text{ V}_{\text{DC}}$.

14.5 Environment

Ambient temperature range	Ambient temperature T_a	-40 to +60 °C (-40 to +140 °F)
	Maximum electronics temperature T	-40 to +85 °C (-40 to +185 °F)

Storage temperature range -40 to +85 °C (-40 to +185 °F)

Climate class As per IEC 60654-1, Class Dx

Degree of protection

- IP54 for the version without thermowell provided for installation in an existing thermowell
- IP65/67 for housing with LED status indication
- IP69 for housing without LED status indication and only if appropriate cord sets with M12x1 coupling are connected.

 The specified IP65/67 or IP69 rating for the compact thermometer is only guaranteed if an approved M12 connector with a suitable IP rating is installed according to the instructions in this manual.

Shock and vibration resistance Endress+Hauser temperature sensors meet the requirements of IEC 60751 which specify shock and vibration resistance of 3g in the range of 10 to 500 Hz. This also applies to the quick-fastening iTHERM QuickNeck.

Electromagnetic compatibility (EMC) EMC as per all relevant requirements of the IEC/EN 61326 series and NAMUR Recommendation EMC (NE21). For details, refer to the Declaration of Conformity. All tests were passed both with and without ongoing digital HART® communication.

All EMC measurements were performed with a turndown (TD) = 5:1. Maximum fluctuations during the EMC tests : < 1% of the measuring span.

Interference immunity according to the IEC/EN 61326 series, industrial requirements.

Interference emission according to the IEC/EN 61326 series, electrical equipment Class B.

14.6 Mechanical construction

Design, dimensions

All dimensions in mm (inches). The design of the thermometer depends on the thermowell version used:

- Thermometer without a thermowell
- Diameter 6 mm (0.24 in)
- Diameter 9 mm (0.35 in)
- Diameter 12.7 mm (½ in)
- Tee thermowell and elbow thermowell version for welding in as per DIN 11865/ASME BPE

 Various dimensions, such as immersion length U for instance, are variable values and are therefore shown as items in the following dimensional drawings.

Variable dimensions:

Item	Description
E	Extension neck length, variable depending on the configuration or predefined for the version with iTHERM QuickNeck
L	Thermowell length (U+T)
B	Thermowell base thickness: Predefined, depends on thermowell version (see also the individual table data)
T	Length of thermowell lagging: Variable or predefined, depends on thermowell version (see also the individual table data)
U	Immersion length: Variable, depending on the configuration
ØID	Insert diameter 6 mm (0.24 in) or 3 mm (0.12 in)

Without thermowell

For installation with compression fitting TK40 as process connection and insert in direct contact with the process or in an existing thermowell.

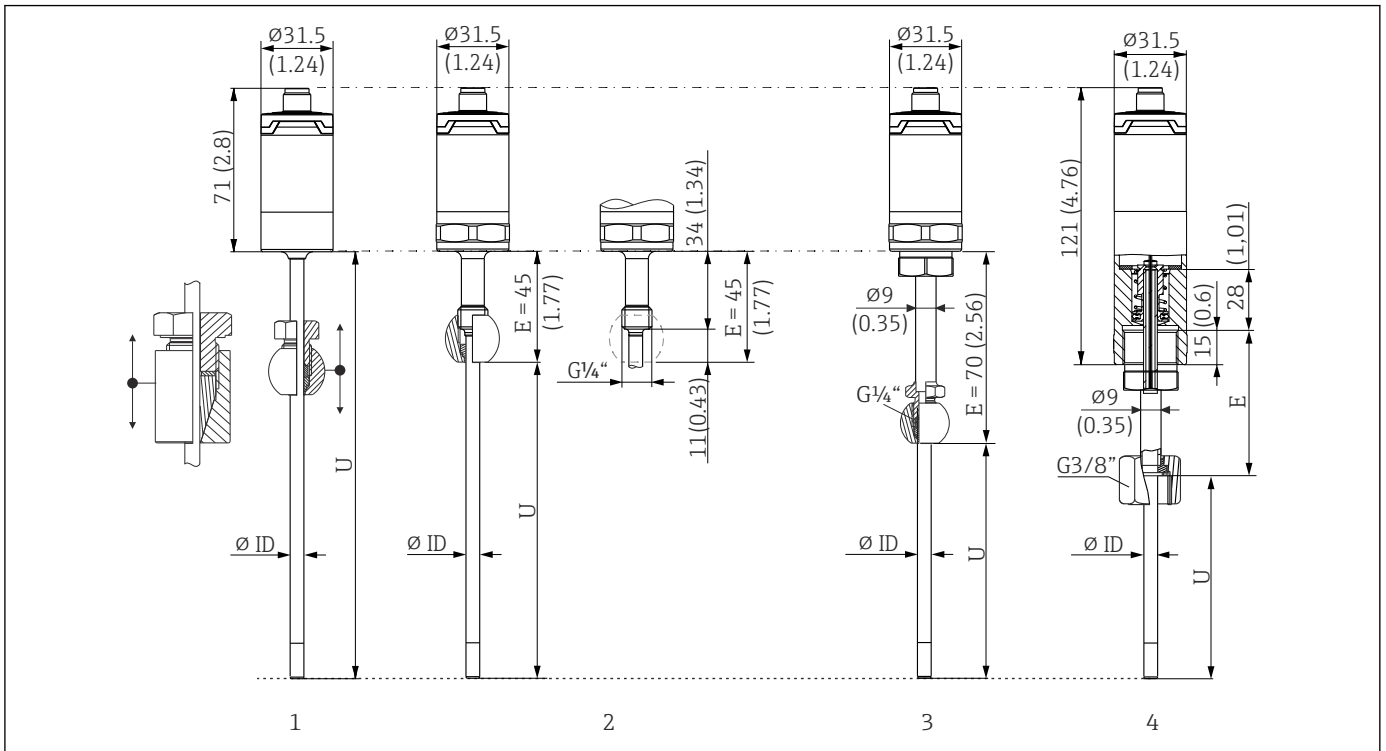

- 1 Thermometer without extension neck, for mounting with adjustable compression fitting TK40, spherically and cylindrically, $\varnothing ID = 6$ mm only
- 2 Thermometer with extension neck, for mounting with or in on-site existing compression fitting TK40 in fixed position, $\varnothing ID = 6$ mm only
- 3 Thermometer with compression fitting TK40, fixed by extension neck, connection thread M24x1.5, $\varnothing ID = 6$ mm
- 4 Thermometer with extension neck TE411, G3/8" union nut, female thread, spring-loaded version for thermowell connection, e.g., TT411, $\varnothing ID = 3$ mm or 6 mm

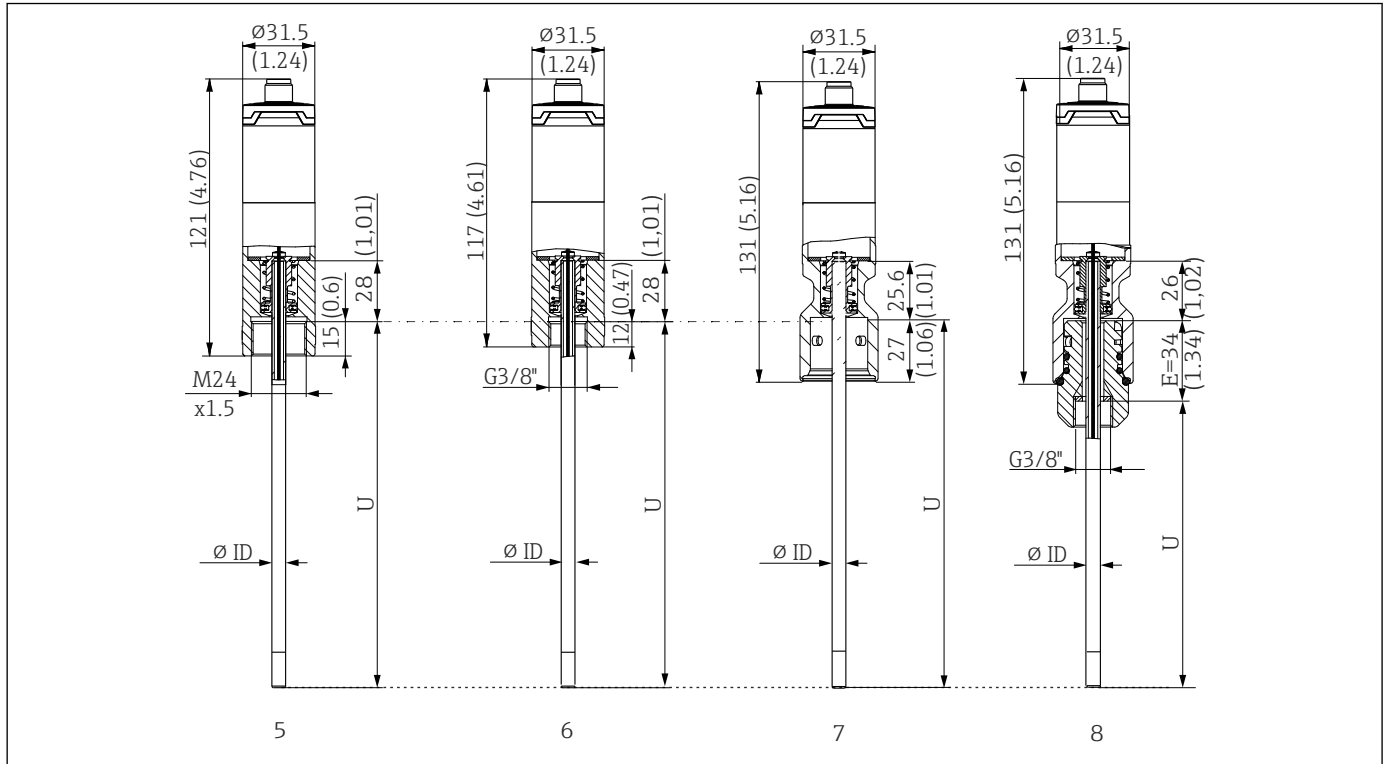

A0044742

- 5 Thermometer with M24x1.5 female thread, spring-loaded version for thermowell connection, e.g., TT411, $\varnothing ID = 3 \text{ mm}$ or 6 mm
- 6 Thermometer with G3/8" female thread, spring-loaded version for thermowell connection, e.g. TT411, $\varnothing ID = 3 \text{ mm}$ or 6 mm
- 7 Thermometer with iTHERM QuickNeck top part, spring-loaded version for thermowell with iTHERM QuickNeck connection, $\varnothing ID = 3 \text{ mm}$ or 6 mm
- 8 Thermometer with iTHERM QuickNeck, spring-loaded for installation in an existing thermowell with G3/8" female thread

Item	Description
$U_{(\text{thermowell})}$	Immersion length of the thermowell available at point of installation
$T_{(\text{thermowell})}$	Shaft length of thermowell available at point of installation
E	Length of the extension neck at point of installation (provided one is available)
$B_{(\text{thermowell})}$	Base thickness of thermowell

Pay attention to the following equations when calculating the immersion length U for immersion into an existing thermowell TT411:

Version 5 and 7	$U = U_{(\text{thermowell})} + T_{(\text{thermowell})} + E + 3 \text{ mm} - B_{(\text{thermowell})}$
Version 3, 4 and 6	$U = U_{(\text{thermowell})} + T_{(\text{thermowell})} + 3 \text{ mm} - B_{(\text{thermowell})}$

With thermowell diameter 6 mm (0.24 in)

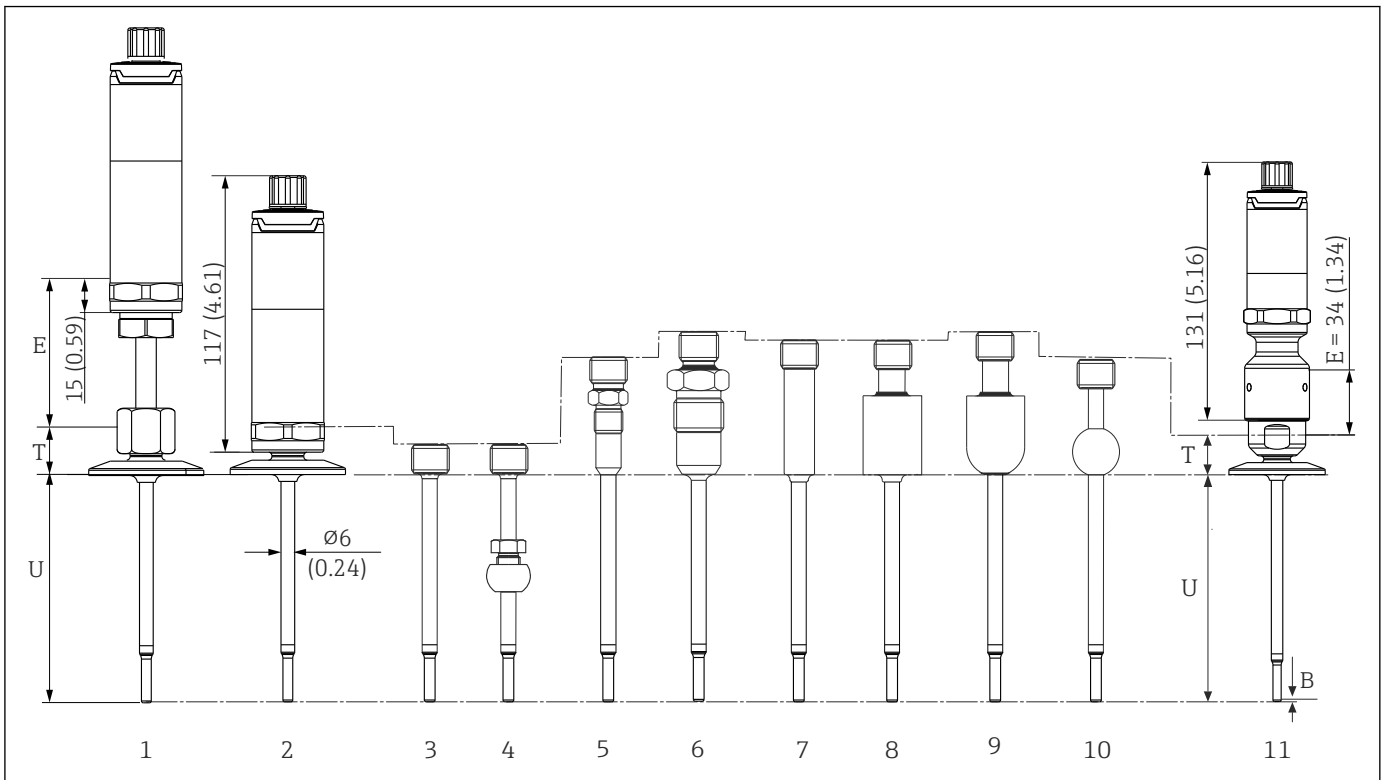

A0031254

- 1 Thermometer with extension neck and process connection as clamp version
- 2 Thermometer without extension neck and process connection as clamp version
- 3 Without process connection
- 4 Process connection version as spherical compression fitting TK40
- 5 Process connection version as metal sealing system M12x1
- 6 Process connection version as metal sealing system G½"
- 7 Process connection version as cylindrical weld-in adapter Ø12 x 40 mm
- 8 Process connection version as cylindrical weld-in adapter Ø30 x 40 mm
- 9 Process connection version as spherical-cylindrical weld-in adapter Ø30 x 40 mm
- 10 Process connection version as spherical weld-in adapter Ø25 x mm
- 11 Thermometer with quick-fastening iTHERM QuickNeck and process connection as sanitary connection (clamp version)

G3/8" thread for thermowell connection

Item	Version	Length
Extension neck E	Without extension neck	-
	Replaceable extension neck, Ø9 mm (0.35 in)	Variable, depending on the configuration
	iTHERM QuickNeck	34 mm (1.34 in)
Thermowell shaft length T ¹⁾	Clamp DN12 according to ISO 2852	24 mm (0.94 in)
	Clamp DN25/DN40 according to ISO 2852	21 mm (0.83 in)
	Without process connection (only G3/8" thread), where necessary with compression fitting TK40	12 mm (0.47 in)
	Metal sealing system M12x1	46 mm (1.81 in)
	Metal sealing system G½"	60 mm (2.36 in)
	Cylindrical weld-in adapter Ø12 mm (0.47 in)	55 mm (2.17 in)
Cylindrical weld-in adapter Ø30 mm (1.18 in)	55 mm (2.17 in)	
Spherical-cylindrical weld-in adapter	58 mm (2.28 in)	

Item	Version	Length
	Spherical weld-in adapter	47 mm (1.85 in)
	Tri-clamp (0.5"-0.75")	24 mm (0.94 in)
	Microclamp (DN8-18)	23 mm (0.91 in)
	Dairy fitting DN25/DN32/DN40 according to DIN 11851	29 mm (1.14 in)
Immersion length U	Independent of the version	Variable, depending on the configuration
Bottom thickness B	Reduced tip \varnothing 4.3 mm (0.17 in)	3 mm (0.12 in)

1) Variable, depending on the configuration

With thermowell diameter 9 mm (0.35 in)

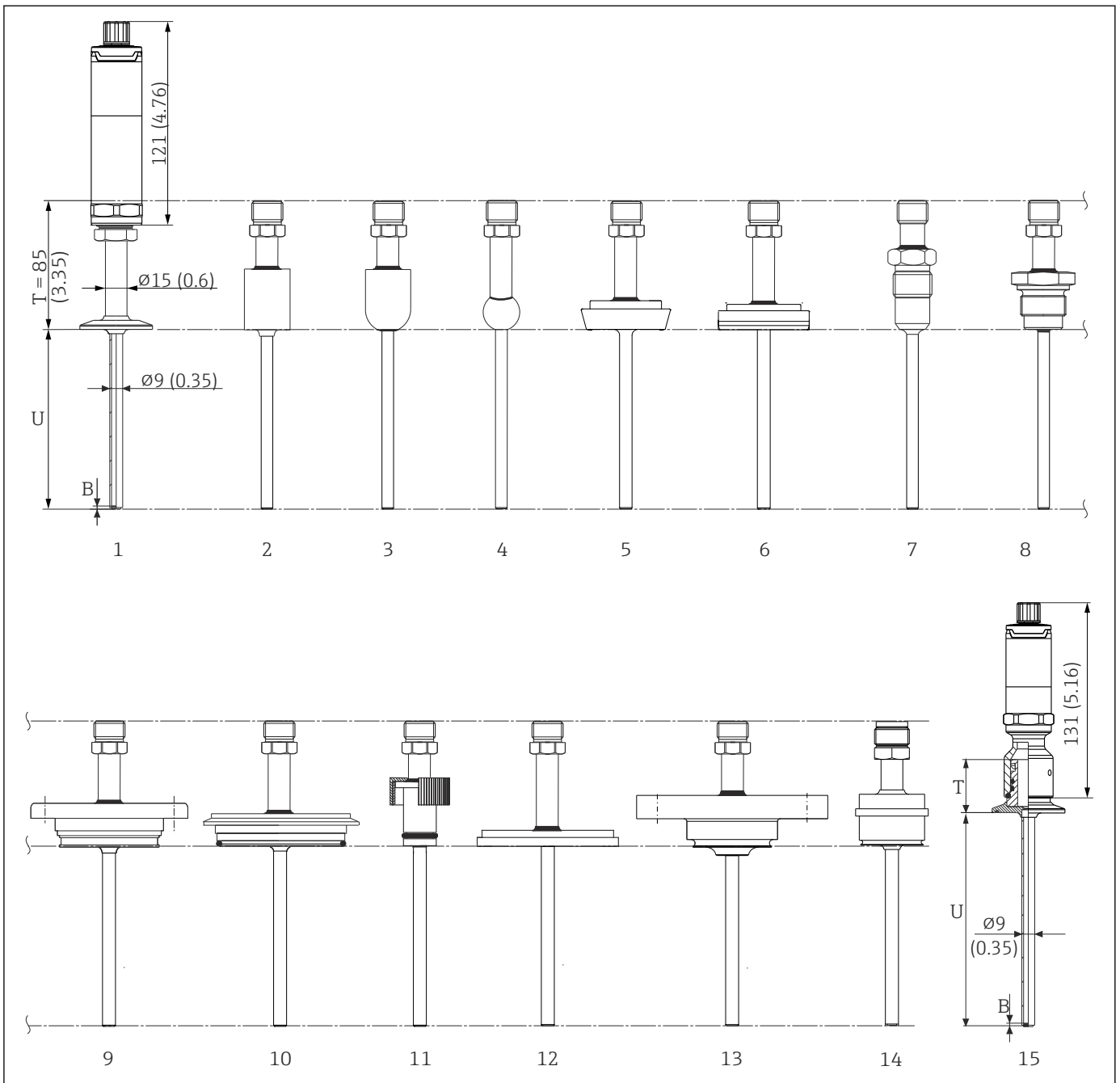

A0031343

- 1 Thermometer with extension neck, process connection as clamp version
- 2 Process connection version as cylindrical weld-in adapter $\varnothing 30 \times 40$ mm
- 3 Process connection version as spherical-cylindrical weld-in adapter $\varnothing 30 \times 40$ mm
- 4 Process connection version as spherical weld-in adapter $\varnothing 25 \times$ mm
- 5 Process connection version as dairy fitting according to DIN 11851
- 6 Process connection version as aseptic pipe union according to DIN 11864-1 Form A
- 7 Process connection version as metal sealing system $G\frac{1}{2}$ "
- 8 Process connection version as thread according to ISO 228 for Liquiphant weld-in adapter
- 9 Process connection version APV Inline
- 10 Process connection version Varivent®
- 11 Process connection version Ingold connection
- 12 Process connection version SMS 1147
- 13 Process connection version Neumo Biocontrol
- 14 Process adapter D45
- 15 Thermometer with quick-fastening iTHERM QuickNeck and process connection, as clamp version for example

Item	Version	Length
Extension neck E	No separate extension neck available	-
Length of thermowell lagging T	Without quick-fastening iTHERM QuickNeck, independent of the process connection	85 mm (3.35 in)
	Without quick-fastening iTHERM QuickNeck, in combination with Ingold connection Ø25 mm (0.98 in) x 46 mm (1.81 in)	100 mm (3.94 in)
	With iTHERM QuickNeck, depending on the process connection:	
	SMS 1147, DN25	40 mm (1.57 in)
	SMS 1147, DN38	41 mm (1.61 in)
	SMS 1147, DN51	42 mm (1.65 in)
	Varivent, type F, D = 50 mm (1.97 in) Varivent, type F, D = 68 mm (2.67 in)	52 mm (2.05 in)
	Varivent, type B, D = 31 mm (1.22 in)	56 mm (2.2 in)
	Thread G1" according to ISO 228 for Liquiphant weld-in adapter	77 mm (3.03 in)
	Spherical-cylindrical weld-in adapter	70 mm (2.76 in)
	Cylindrical weld-in adapter	67 mm (2.64 in)
	Aseptic pipe union according to DIN11864-A, DN25	45 mm (1.77 in)
	Aseptic pipe union according to DIN11864-A, DN40	
	Dairy fitting according to DIN 11851, DN32	47 mm (1.85 in)
	Dairy fitting according to DIN 11851, DN40	
	Dairy fitting according to DIN 11851, DN50	48 mm (1.89 in)
	Clamp according to ISO 2852, DN12	
	Clamp according to ISO 2852, DN25	39 mm (1.54 in)
	Clamp according to ISO 2852, DN40	
	Clamp according to ISO 2852, DN63.5	
	Clamp according to ISO 2852, DN70	
	Microclamp (DN18)	47 mm (1.85 in)
	Tri-clamp (0.75")	46 mm (1.81 in)
Ingold connection Ø25 mm (0.98 in) x 30 mm (1.18 in)	78 mm (3.07 in)	
Ingold connection Ø25 mm (0.98 in) x 46 mm (1.81 in)	94 mm (3.7 in)	
Metal sealing system G½"	77 mm (3.03 in)	
APV Inline, DN50	51 mm (2.01 in)	
Immersion length U	Independent of the version	Variable, depending on the configuration
Bottom thickness B	Reduced tip Ø5.3 mm (0.21 in)x 20 mm (0.79 in)	3 mm (0.12 in)
	Straight tip	2 mm (0.08 in)

With thermowell diameter 12.7 mm (½ in)

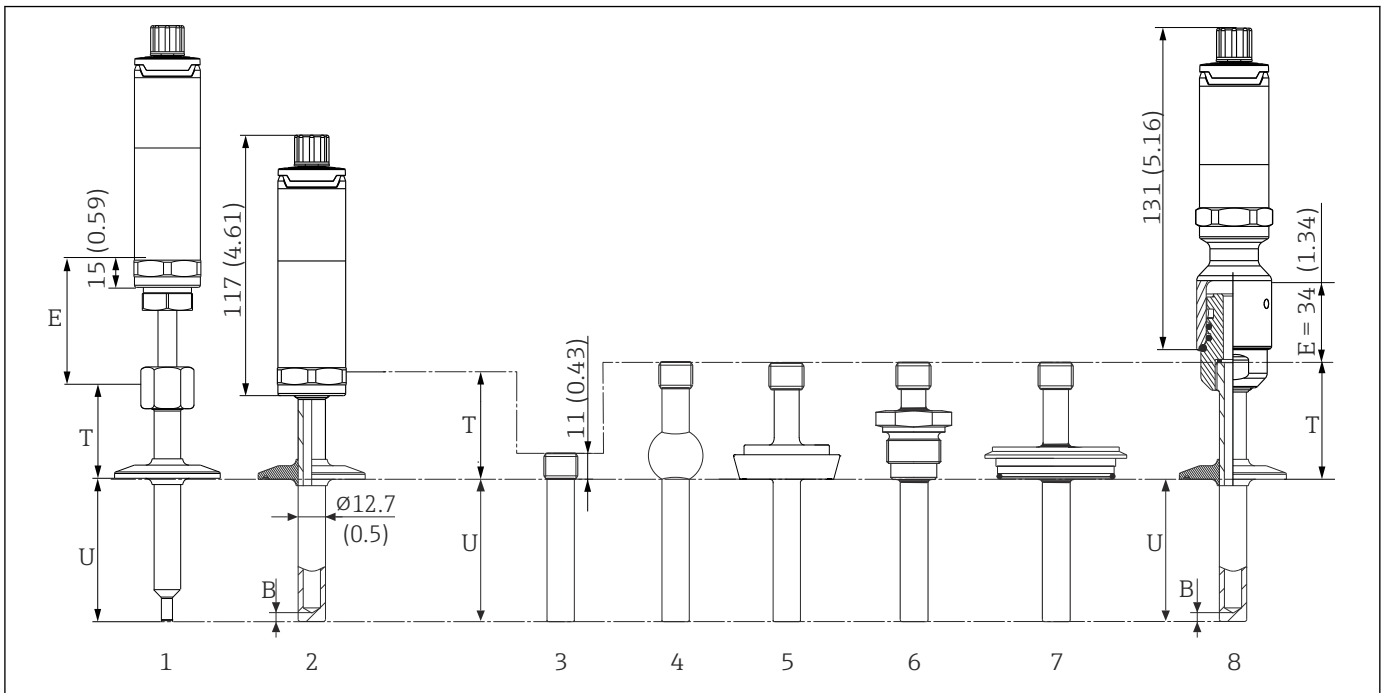

A0031372

- 1 Thermometer with standard extension neck, thread and process connection as clamp version
- 2 Thermometer with extension neck and process connection as clamp version
- 3 Process connection version as cylindrical weld-in adapter $\varnothing 12.7$ mm (½ in)
- 4 Process connection version as spherical weld-in adapter $\varnothing 25$ mm (1 in)
- 5 Process connection version as dairy fitting according to DIN 11851
- 6 Thread according to ISO 228 for Liquiphant weld-in adapter
- 7 Process connection version Varivent
- 8 Thermometer with quick-fastening iTHERM QuickNeck and process connection, as clamp version for example

- G3/8" thread for thermowell connection
- Thermowell made from solid bar stock drilled for $L \leq 200$ mm (7.87 in)
- Welded thermowell for $L > 200$ mm (7.87 in)

Item	Version	Length
Extension neck E	Without extension neck	-
	Replaceable extension neck, $\varnothing 9$ mm (0.35 in)	Variable, depending on the configuration
	iTHERM QuickNeck	34 mm (1.34 in)
Length of thermowell lagging T	Weld-in adapter, cylindrical, $\varnothing 12.7$ mm (½ in)	12 mm (0.47 in)
	All other process connections	65 mm (2.56 in)
Immersion length U	Independent of the process connection	Variable, depending on the configuration
Bottom thickness B	Reduced tip $\varnothing 5.3$ mm (0.21 in) x 20 mm (0.79 in)	3 mm (0.12 in)
	Reduced tip $\varnothing 8$ mm (0.31 in) x 32 mm (1.26 in)	4 mm (0.16 in)
	Straight tip	6 mm (0.24 in)

With tee or elbow thermowell version

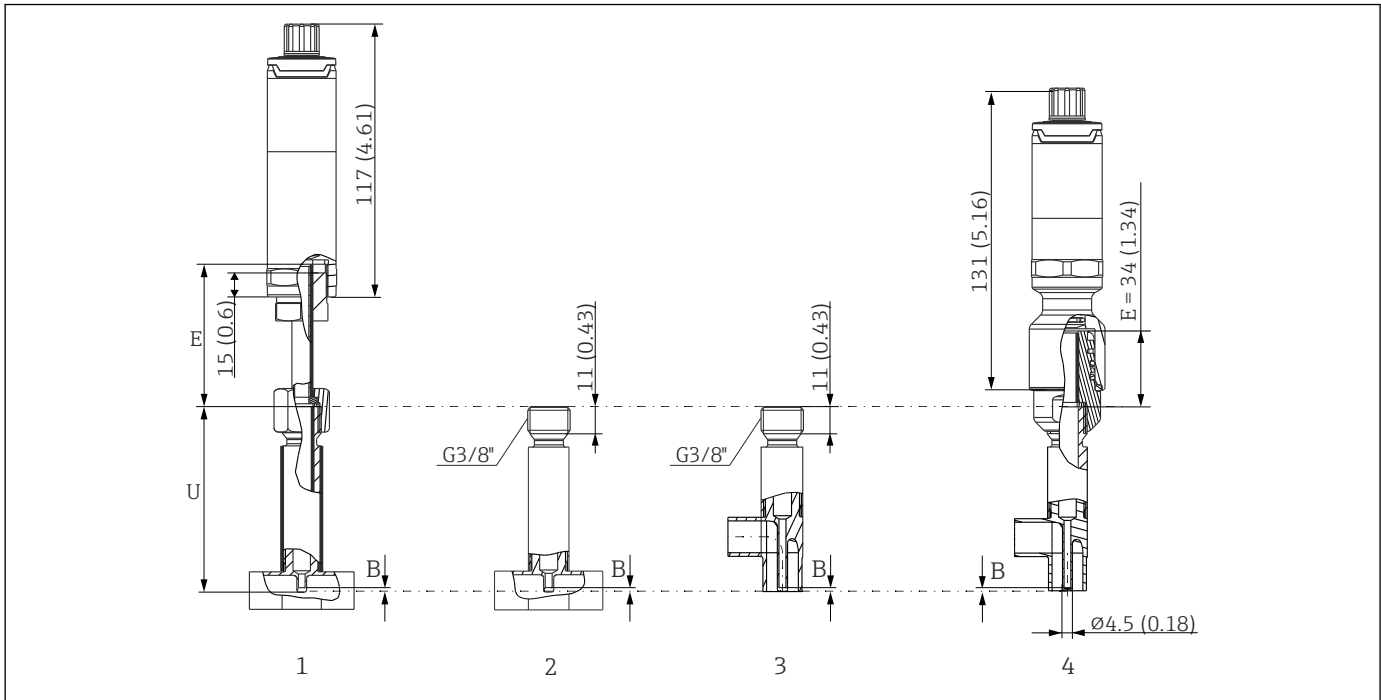

A0031515

- 1 Thermometer with extension neck and tee thermowell
- 2 Version with tee thermowell
- 3 Version with elbow thermowell
- 4 Thermometer with quick-fastening iTHERM QuickNeck and elbow thermowell

Item	Version	Length
Extension neck E	Without extension neck	-
	Replaceable extension neck, $\varnothing 9$ mm (0.35 in)	Variable, depending on the configuration
	iTHERM QuickNeck	34 mm (1.34 in) 71.05 mm (2.79 in)
Bottom thickness B	Independent of the version	0.7 mm (0.03 in)
Immersion length U	G3/8" connection	85 mm (3.35 in)
	QuickNeck connection	119 mm (4.7 in)

- Pipe sizes according to DIN11865 series A (DIN), B (ISO) and C (ASME BPE)
- Nominal diameters > DN25, with 3-A symbol
- IP69 protection

- Material 1.4435+316L, delta ferrite content < 0.5%
- Temperature measurement range: -60 to +200 °C (-76 to +392 °F)
- Pressure range: PN25 according to DIN11865

i As a general rule, the longer the immersion length U, the better the measurement accuracy. For small pipe diameters, it is advisable to use elbow thermowells to enable a maximum immersion length U.

Suitable immersion lengths for the following thermometers with G3/8" thermometer connection:

- TMR35: 83 mm (3.27 in)
- iTHERM TM411: 85 mm (3.35 in)
- iTHERM TM311: 85 mm (3.35 in)
- iTHERM TrustSens TM371: 85 mm (3.35 in)

Suitable immersion lengths for the following thermometers with iTHERM QuickNeck thermometer connection:

- TMR35: 117 mm (4.6 in)
- iTHERM TM411: 119 mm (4.68 in)
- iTHERM TM311: 119 mm (4.68 in)
- iTHERM TrustSens TM371: 119 mm (4.68 in)

Weight 0.2 to 2.5 kg (0.44 to 5.5 lbs) for standard options.

Materials The temperatures for continuous operation specified in the following table are only intended as reference values for use of the various materials in air and without any significant compressive load. The maximum operating temperatures can be reduced considerably in cases where abnormal conditions such as high mechanical load occur or in aggressive media.

Name	Short formula	Recommended max. temperature for continuous use in air	Properties
AISI 316L (corresponds to 1.4404 or 1.4435)	X2CrNiMo17-13-2, X2CrNiMo18-14-3	650 °C (1202 °F) ¹⁾	<ul style="list-style-type: none"> ■ Austenitic stainless steel ■ High corrosion resistance in general ■ Particularly high corrosion resistance in chlorine-based and acidic, non-oxidizing atmospheres through the addition of molybdenum (e.g. phosphoric and sulfuric acids, acetic and tartaric acids with a low concentration) ■ Increased resistance to intergranular corrosion and pitting ■ The wetted part is a thermowell made of 316L or 1.4435+316L passivated with 3% sulfuric acid.
1.4435+316L, delta ferrite < 1% or < 0.5%	With regard to analytical limits, the specifications of both materials (1.4435 and 316L) are met simultaneously. In addition, the delta ferrite content of the parts in contact with the process is limited to <1% or <0.5%. ≤3% for weld seams (in accordance with Basel Standard II)		

1) Can be used to a limited extent up to 800 °C (1472 °F) for low compressive loads and in non-corrosive media. Contact your Endress+Hauser sales team for further information.

Surface roughness

Specifications for product wetted parts in accordance with EN ISO 21920:

Standard surface, mechanically polished ¹⁾	$R_a \leq 0.76 \mu\text{m}$ (30 μin)
Mechanically polished ¹⁾ , buffed ²⁾	$R_a \leq 0.38 \mu\text{m}$ (15 μin) ³⁾
Mechanically polished ¹⁾ , buffed and electropolished	$R_a \leq 0.38 \mu\text{m}$ (15 μin) ³⁾ + electropolished

- 1) Or equivalent treatment that guarantees R_a max.
- 2) Not compliant with ASME BPE
- 3) T16% for direct-contact measuring inserts without thermowell, not compliant with ASME BPE

Thermowell

Process connections

All dimensions in mm (inches).

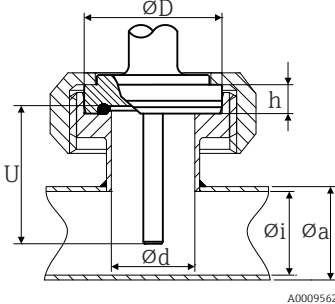
Type	Version	Dimensions					Technical properties
		ϕd	ϕD	ϕi	ϕa	h	
Aseptic pipe union according to DIN 11864-1, Form A 	DN25	26 mm (1.02 in)	42.9 mm (1.7 in)	26 mm (1.02 in)	29 mm (1.14 in)	9 mm (0.35 in)	<ul style="list-style-type: none"> ■ $P_{max.} = 40$ bar (580 psi) ■ 3-A marked and EHEDG certified ■ ASME BPE compliance
	DN40	38 mm (1.5 in)	54.9 mm (2.16 in)	38 mm (1.5 in)	41 mm (1.61 in)	10 mm (0.39 in)	

Weld-in

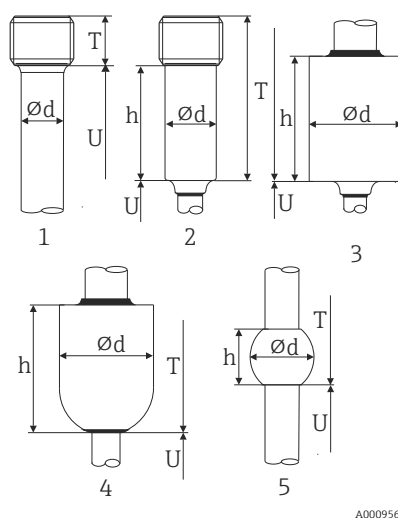
Model	Type of fitting ¹⁾	Dimensions	Technical properties
Weld-in adapter 	1: Cylindrical ²⁾	$\phi d = 12.7$ mm ($\frac{1}{2}$ in), U = immersion length from lower edge of thread, T = 12 mm (0.47 in)	<ul style="list-style-type: none"> ■ $P_{max.}$ depends on the weld-in process ■ With 3-A symbol and EHEDG certification ■ ASME BPE compliance
	2: Cylindrical ³⁾	$\phi d \times h = 12$ mm (0.47 in) x 40 mm (1.57 in), T = 55 mm (2.17 in)	
	3: Cylindrical	$\phi d \times h = 30$ mm (1.18 in) x 40 mm (1.57 in)	
	4: Spherical-cylindrical	$\phi d \times h = 30$ mm (1.18 in) x 40 mm (1.57 in)	
	5: Spherical	$\phi d = 25$ mm (0.98 in) h = 24 mm (0.94 in)	

- 1) Options depend on product and configuration
- 2) For thermowell $\phi 12.7$ mm ($\frac{1}{2}$ in)
- 3) For thermowell $\phi 6$ mm ($\frac{1}{4}$ in)

Releasable process connection

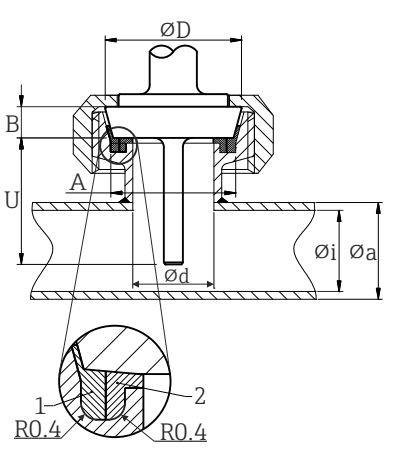



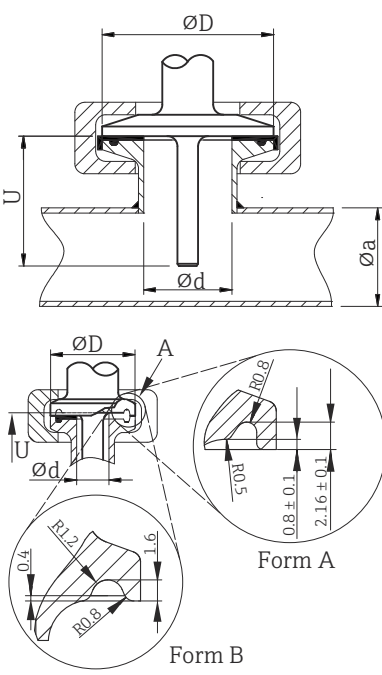

Type		Technical properties				
Sanitary connection according to DIN 11851  <p>1 Centering ring 2 Sealing ring</p>		<ul style="list-style-type: none"> 3-A marked and EHEDG certified (only with EHEDG-certified and self-centering sealing ring). ASME BPE compliance 				
Version ¹⁾	Dimensions					P _{max.}
	ØD	A	B	Øi	Øa	
DN25	44 mm (1.73 in)	30 mm (1.18 in)	10 mm (0.39 in)	26 mm (1.02 in)	29 mm (1.14 in)	40 bar (580 psi)
DN32	50 mm (1.97 in)	36 mm (1.42 in)	10 mm (0.39 in)	32 mm (1.26 in)	35 mm (1.38 in)	40 bar (580 psi)
DN40	56 mm (2.2 in)	42 mm (1.65 in)	10 mm (0.39 in)	38 mm (1.5 in)	41 mm (1.61 in)	40 bar (580 psi)
DN50	68 mm (2.68 in)	54 mm (2.13 in)	11 mm (0.43 in)	50 mm (1.97 in)	53 mm (2.1 in)	25 bar (363 psi)

1) Pipes in accordance with DIN 11850

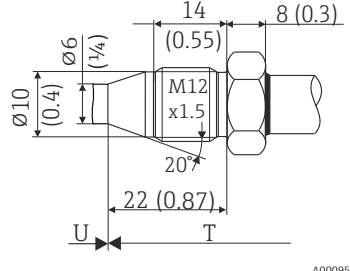
Removable process connection clamp

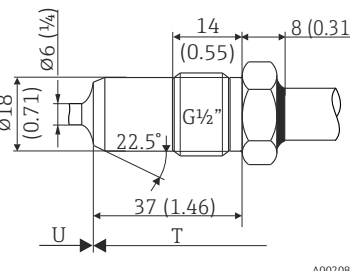
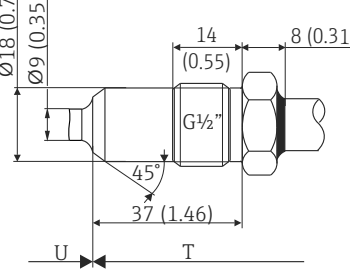
Type	Version ¹⁾	Dimensions		Technical properties	Conformity
	ϕd ²⁾	ϕD	ϕa		
<p>Clamp according to DIN 32676 ³⁾</p>  <p>Form A: In compliance with ASME BPE Type A Form B: In compliance with ASME BPE Type B and DIN 32676</p>	Microclamp ⁴⁾ DN8 (0.5"), Form A	25 mm (0.98 in)	-	<ul style="list-style-type: none"> ■ P_{max.} = 16 bar (232 psi), depends on clamp ring and suitable seal ■ With 3-A symbol 	-
	Tri-clamp DN8 (0.5"), Form B		-		DIN 32676 ⁵⁾
	Clamp DN10-20, Form B	34 mm (1.34 in)	16 to 25.3 mm (0.63 to 0.99 in)		DIN 32676
	Clamp DN25-40 (1"-1.5"), Form B	50.5 mm (1.99 in)	29 to 42.4 mm (1.14 to 1.67 in)	<ul style="list-style-type: none"> ■ P_{max.} = 16 bar (232 psi), depends on clamp ring and suitable seal ■ 3-A marked and EHEDG certified (in connection with Combifit seal) ■ Can be used with 'Novaseptic Connect (NA Connect)' which enables flush-mount installation 	ASME BPE Type B; DIN 32676
	Clamp DN50 (2"), Form B	64 mm (2.52 in)	44.8 to 55.8 mm (1.76 to 2.2 in)		ASME BPE Type B; DIN 32676
	Clamp DN63.5 (2.5"), Form B	77.5 mm (3.05 in)	68.9 to 75.8 mm (2.71 to 2.98 in)		ASME BPE Type B; ISO 2852
	Clamp DN70-76.5 (3"), Form B	91 mm (3.58 in)	> 75.8 mm (2.98 in)		ASME BPE Type B; DIN 32676

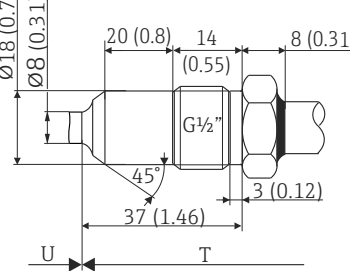
- 1) Options depend on product and configuration
- 2) Pipes in accordance with ISO 2037 and BS 4825 Part 1
- 3) replaces ISO 2852
- 4) Microclamp (not contained in DIN 32676); no standard pipes
- 5) Groove diameter = 20 mm

Type	Version ¹⁾	Technical properties
<p style="text-align: center;">Metal sealing system</p>  <p>14 M12x1.5</p> <p style="text-align: right;">A0009574</p>	<p style="text-align: center;">Thermowell diameter 6 mm (1/4 in)</p>	<p>$P_{max.} = 16 \text{ bar (232 psi)}$</p> <p> Maximum torque = 10 Nm (7.38 lbf ft)</p>
 <p>15 G1/2"</p> <p style="text-align: right;">A0020856</p>		
 <p style="text-align: right;">A0009571</p>	<p style="text-align: center;">Thermowell diameter 9 mm (0.35 in)</p>	<p>$P_{max.} = 16 \text{ bar (232 psi)}$</p> <p> Maximum torque = 10 Nm (7.38 lbf ft)</p>
 <p style="text-align: right;">A0022326</p>	<p style="text-align: center;">Thermowell diameter 8 mm (0.31 in)</p>	<p>$P_{max.} = 16 \text{ bar (232 psi)}$</p> <p> Maximum torque = 10 Nm (7.38 lbf ft)</p>

1) Options depend on product and configuration

Type	Version	Technical properties
<p>Process adapter</p> <p>Unit of measurement mm (in)</p>	D45	

Removable process connection for Liquiphant weld-in adapter (ISO 228)

Type	Version G	Dimensions			Technical properties
		L1 thread length	A	1 (SW/AF)	
<p>Thread according to ISO 228 (for Liquiphant weld-in adapter)</p>	G $\frac{3}{4}$ " for FTL20/31/33 adapter	16 mm (0.63 in)	25.5 mm (1 in)	32	<ul style="list-style-type: none"> ■ P_{max.} = 25 bar (362 psi) at max. 150 °C (302 °F) ■ P_{max.} = 40 bar (580 psi) at max. 100 °C (212 °F) ■ For more information about hygienic compliance in conjunction with FTL31/33/50 adapters, see Technical Information TI00426F.
	G $\frac{3}{4}$ " for FTL50 adapter				
	G1" for FTL50 adapter	18.6 mm (0.73 in)	29.5 mm (1.16 in)	41	

Type	Version	Dimensions					Technical properties
		ϕ d	ϕ A	ϕ B	M	h	
<p>APV Inline</p>	DN50	69 mm (2.72 in)	99.5 mm (3.92 in)	82 mm (3.23 in)	2xM8	19 mm (0.75 in)	<ul style="list-style-type: none"> ■ P_{max.} = 25 bar (362 psi) ■ 3-A marked and EHEDG certified ■ ASME BPE compliance

Removable process connection Varivent®

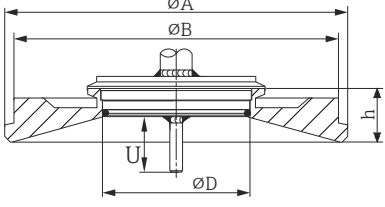
Type	Version ¹⁾	Dimensions				Technical properties	
		ØD	ØA	ØB	h	P _{max.}	
 <p>A0021307</p>	Type B	31 mm (1.22 in)	105 mm (4.13 in)	-	22 mm (0.87 in)	10 bar (145 psi)	<ul style="list-style-type: none"> With 3-A symbol and EHEDG certification ASME BPE compliance
	Type F	50 mm (1.97 in)	145 mm (5.71 in)	135 mm (5.31 in)	24 mm (0.95 in)		
	Type N	68 mm (2.67 in)	165 mm (6.5 in)	155 mm (6.1 in)	24.5 mm (0.96 in)		
<p>i The VARINLINE® housing connection flange is suitable for welding into the conical or torispherical head in tanks or containers with a small diameter (≤ 1.6 m (5.25 ft)) and up to a wall thickness of 8 mm (0.31 in). Varivent® Type F cannot be used for installations in pipes in combination with the VARINLINE® housing connection flange.</p>							

1) Options depend on product and configuration

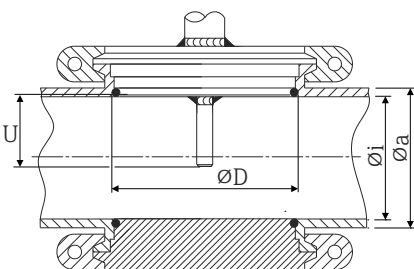
Type	Dimensions			Technical properties
Varivent® for VARINLINE® housing for installation in pipes  <p>A0009564</p>				<ul style="list-style-type: none"> With 3-A symbol and EHEDG certification ASME BPE compliance
Version ¹⁾	ØD	Øi	Øa	P _{max.}
Type N, according to DIN 11866, series A	68 mm (2.67 in)	DN40: 38 mm (1.5 in)	DN40: 41 mm (1.61 in)	DN40 to DN65: 16 bar (232 psi)
		DN50: 50 mm (1.97 in)	DN50: 53 mm (2.1 in)	
		DN65: 66 mm (2.6 in)	DN65: 70 mm (2.76 in)	
		DN80 to DN150: 10 bar (145 psi)	DN80: 81 mm (3.2 in)	DN80: 85 mm (3.35 in)
			DN100: 100 mm (3.94 in)	DN100: 104 mm (4.1 in)
			DN125: 125 mm (4.92 in)	DN125: 129 mm (5.08 in)
Type N, according to EN ISO 1127, series B	68 mm (2.67 in)	38.4 mm (1.51 in)	42.4 mm (1.67 in)	42.4 mm (1.67 in) to 60.3 mm (2.37 in): 16 bar (232 psi)
		44.3 mm (1.75 in)	48.3 mm (1.9 in)	
		56.3 mm (2.22 in)	60.3 mm (2.37 in)	
		76.1 mm (3 in) to 114.3 mm (4.5 in): 10 bar (145 psi)	72.1 mm (2.84 in)	76.1 mm (3 in)
			82.9 mm (3.26 in)	42.4 mm (3.5 in)
			108.3 mm (4.26 in)	114.3 mm (4.5 in)
Type N, according to DIN 11866, series C	68 mm (2.67 in)	OD 1½": 34.9 mm (1.37 in)	OD 1½": 38.1 mm (1.5 in)	OD 1½" to OD 2½": 16 bar (232 psi)
		OD 2": 47.2 mm (1.86 in)	OD 2": 50.8 mm (2 in)	
		OD 2½": 60.2 mm (2.37 in)	OD 2½": 63.5 mm (2.5 in)	

Type				Technical properties
Type N, according to DIN 11866, series C	68 mm (2.67 in)	OD 3": 73 mm (2.87 in)	OD 3": 76.2 mm (3 in)	OD 3" to OD 4": 10 bar (145 psi)
		OD 4": 97.6 mm (3.84 in)	OD 4": 101.6 mm (4 in)	
Type F, according to DIN 11866, series C	50 mm (1.97 in)	OD 1": 22.2 mm (0.87 in)	OD 1": 25.4 mm (1 in)	16 bar (232 psi)

1) Options depend on product and configuration

Tee thermowell, optimized (no welding, no dead legs)

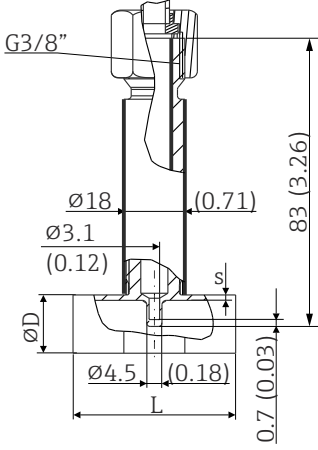
Model	Type of fitting ¹⁾		Dimensions in mm (in)			Technical properties
			ØD	L	s ²⁾	
Tee thermowell for welding in as per DIN 11865 (series A, B and C)  A0035898	Series A	DN10 PN25	13 mm (0.51 in)	48 mm (1.89 in)	1.5 mm (0.06 in)	<ul style="list-style-type: none"> ■ P_{max.} = 25 bar (362 psi) ■ 3-A marked ³⁾ and EHEDG certified ³⁾ ■ ASME BPE compliance ³⁾
		DN15 PN25	19 mm (0.75 in)			
		DN20 PN25	23 mm (0.91 in)			
		DN25 PN25	29 mm (1.14 in)			
		DN32 PN25	32 mm (1.26 in)			
	Series B	DN13.5 PN25	13.5 mm (0.53 in)		1.6 mm (0.063 in)	
		DN17.2 PN25	17.2 mm (0.68 in)			
		DN21.3 PN25	21.3 mm (0.84 in)			
		DN26.9 PN25	26.9 mm (1.06 in)			
		DN33.7 PN25	33.7 mm (1.33 in)			
	Series C	DN12.7 PN25 (½")	12.7 mm (0.5 in)		1.65 mm (0.065 in)	
		DN19.05 PN25 (¾")	19.05 mm (0.75 in)			
		DN25.4 PN25 (1")	25.4 mm (1 in)			
		DN38.1 PN25 (1½")	38.1 mm (1.5 in)			

1) Options depend on product and configuration

2) Wall thickness

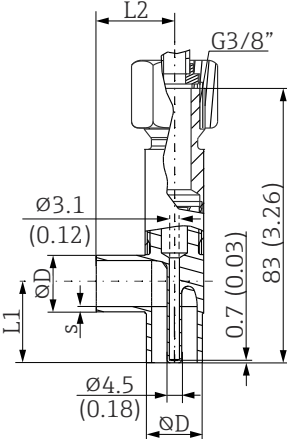

3) Applies to ≥ DN25. The radius ≥ 3.2 mm (1/8 in) cannot be maintained for smaller nominal diameters.

Elbow thermowell, optimized (no welding, no dead legs)

Type	Version ¹⁾		Dimensions				Technical properties
			ØD	L1	L2	s ²⁾	
Elbow thermowell for welding in as per DIN 11865 (series A, B and C) 	Series A	DN10 PN25	13 mm (0.51 in)	22 mm (0.87 in)	24 mm (0.95 in)	1.5 mm (0.06 in)	<ul style="list-style-type: none"> ■ P_{max.} = 25 bar (362 psi) ■ 3-A marked ³⁾ and EHEDG certified ³⁾ ■ ASME BPE compliance ³⁾
		DN15 PN25	19 mm (0.75 in)	25 mm (0.98 in)			
		DN20 PN25	23 mm (0.91 in)	27 mm (1.06 in)			
		DN25 PN25	29 mm (1.14 in)	30 mm (1.18 in)			
		DN32 PN25	35 mm (1.38 in)	33 mm (1.3 in)			
	Series B	DN13.5 PN25	13.5 mm (0.53 in)	22 mm (0.87 in)	24 mm (0.95 in)	1.6 mm (0.063 in)	
		DN17.2 PN25	17.2 mm (0.68 in)	24 mm (0.95 in)			
		DN21.3 PN25	21.3 mm (0.84 in)	26 mm (1.02 in)			
		DN26.9 PN25	26.9 mm (1.06 in)	29 mm (1.14 in)			
		DN33.7 PN25	33.7 mm (1.33 in)	32 mm (1.26 in)	32 mm (1.26 in)	2.0 mm (0.08 in)	
	Series C	DN12.7 PN25 (½")	12.7 mm (0.5 in)	22 mm (0.87 in)	24 mm (0.95 in)	1.65 mm (0.065 in)	
		DN19.05 PN25 (¾")	19.05 mm (0.75 in)	25 mm (0.98 in)			
		DN25.4 PN25 (1")	25.4 mm (1 in)	28 mm (1.1 in)			
		DN38.1 PN25 (1½")	38.1 mm (1.5 in)	35 mm (1.38 in)			

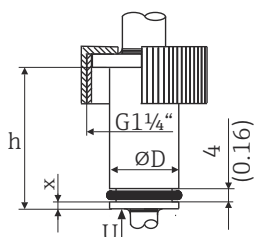
- 1) Options depend on product and configuration
- 2) Wall thickness
- 3) Applies to ≥ DN25. The radius ≥ 3.2 mm (1/8 in) cannot be maintained for smaller nominal diameters.

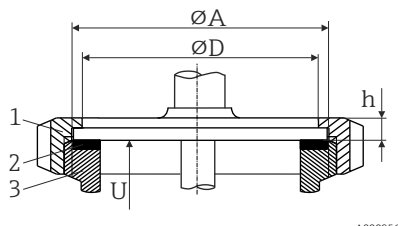
Type	Version, dimensions ØD x h	Technical properties
Ingold connection 	Ø25 mm (0.98 in) x 30 mm (1.18 in) x = 1.5 mm (0.06 in)	P _{max.} = 25 bar (362 psi) A seal is included in the scope of delivery. V75SR material: Complies with FDA, 3-A Sanitary Standard 18-03 Class 1 and USP Class VI
	Ø25 mm (0.98 in) x 46 mm (1.81 in) x = 6 mm (0.24 in)	

Model	Type of fitting	Dimensions			Technical properties
		ϕD	ϕA	h	
SMS 1147  1 Cap nut 2 Sealing ring 3 Counterpart connection A0009568	DN25	32 mm (1.26 in)	35.5 mm (1.4 in)	7 mm (0.28 in)	$P_{max.} = 6 \text{ bar (87 psi)}$
	DN38	48 mm (1.89 in)	55 mm (2.17 in)	8 mm (0.31 in)	
	DN51	60 mm (2.36 in)	65 mm (2.56 in)	9 mm (0.35 in)	
 The counterpart connection must fit the sealing ring and fix it in place.					

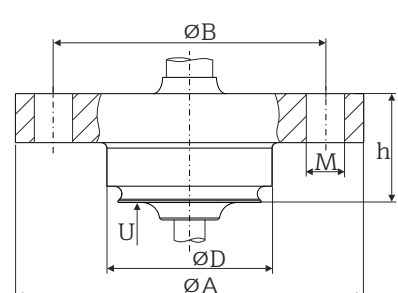
Type	Version	Dimensions					Technical properties
		ϕA	ϕB	ϕD	ϕd	h	
NEUMO BioControl  A0018497	D25 PN16	64 mm (2.52 in)	50 mm (1.97 in)	30.4 mm (1.2 in)	7 mm (0.28 in)	20 mm (0.79 in)	<ul style="list-style-type: none"> ■ $P_{max.} = 16 \text{ bar (232 psi)}$ ■ With 3-A symbol
	D50 PN16	90 mm (3.54 in)	70 mm (2.76 in)	49.9 mm (1.97 in)	9 mm (0.35 in)	27 mm (1.06 in)	
	D65 PN25	120 mm (4.72 in)	95 mm (3.74 in)	67.9 mm (2.67 in)	11 mm (0.43 in)		

 The 316L compression fittings can only be used once due to deformation. This applies to all the compression fitting components. A replacement compression fitting must be secured at another point (grooves in thermowell).

PEEK compression fittings must never be used at a temperature that is lower than the temperature present when the compression fitting is secured. This is because the fitting would no longer be leak-tight as a result of heat contraction of the PEEK material.

SWAGELOK or similar fittings are strongly recommended for higher requirements.

TK40

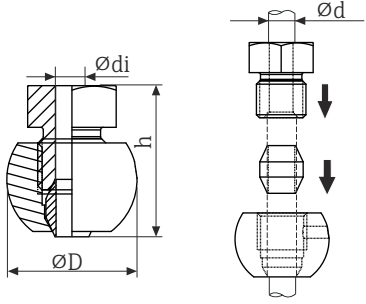
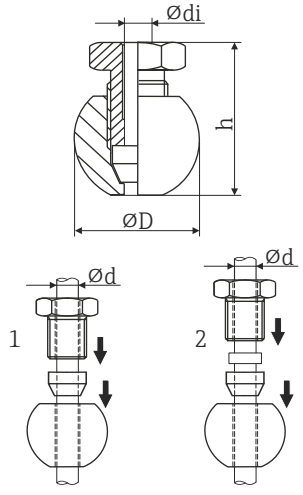
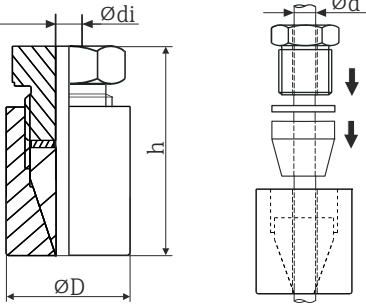
Type	Version ¹⁾	Dimensions			Technical properties ²⁾
	Spherical or cylindrical	ϕdi	ϕD	h	
 <p style="text-align: right; font-size: small;">A0058214</p>	Spherical Sealing taper material 316L	6.3 mm (0.25 in) ³⁾	25 mm (0.98 in)	33 mm (1.3 in)	<ul style="list-style-type: none"> ▪ $P_{max.} = 50$ bar (725 psi) ▪ $T_{max.}$ for 316L sealing taper = +200 °C (+392 °F), tightening torque = 40 Nm
<p>Compression fitting TK40 for weld-in</p>  <p style="text-align: right; font-size: small;">A0018912</p> <p>1 Movable 2 Fixed</p>	Spherical Sealing taper material PEEK Thread G $\frac{1}{4}$ "	6.3 mm (0.25 in) ³⁾	25 mm (0.98 in)	33 mm (1.3 in)	<ul style="list-style-type: none"> ▪ $P_{max.} = 10$ bar (145 psi) ▪ $T_{max.}$ for PEEK sealing taper = +200 °C (+392 °F), tightening torque = 10 Nm ▪ The TK40 PEEK sealing taper is EHEDG tested and 3-A marked
 <p style="text-align: right; font-size: small;">A0058543</p>	Cylindrical Material of sealing taper ELASTOSIL® Thread G $\frac{1}{2}$ "	6.2 mm (0.24 in) ³⁾	30 mm (1.18 in)	57 mm (2.24 in)	<ul style="list-style-type: none"> ▪ $P_{max.} = 10$ bar (145 psi) ▪ $T_{max.}$ for ELASTOSIL® sealing taper = +200 °C (+392 °F), tightening torque = 5 Nm ▪ The ELASTOSIL® compression fitting is EHEDG tested and 3-A marked
		9.2 mm (0.36 in)			

- 1) Options depend on product and configuration
- 2) All the pressure specifications apply for cyclic temperature load
- 3) For insert or thermowell diameter $\phi d = 6$ mm (0.236 in).

Shape of tip

The thermal response time, the reduction of the flow cross-section and the mechanical load that occurs in the process are the criteria that matter when selecting the shape of the tip. Advantages of using reduced or tapered thermometer tips:

- A smaller tip shape has less impact on the flow characteristics of the pipe carrying the medium.
- The flow characteristics are optimized, thereby increasing the stability of the thermowell.
- Endress+Hauser offers users a range of thermowell tips to meet every requirement:
 - Reduced tip with $\varnothing 4.3$ mm (0.17 in) and $\varnothing 5.3$ mm (0.21 in): Walls of lower thickness significantly reduce the response times of the overall measuring point.
 - Reduced tip with $\varnothing 8$ mm (0.31 in): Walls of greater thickness are particularly well suited to applications with a higher degree of mechanical load or wear (e.g. pitting, abrasion etc.).

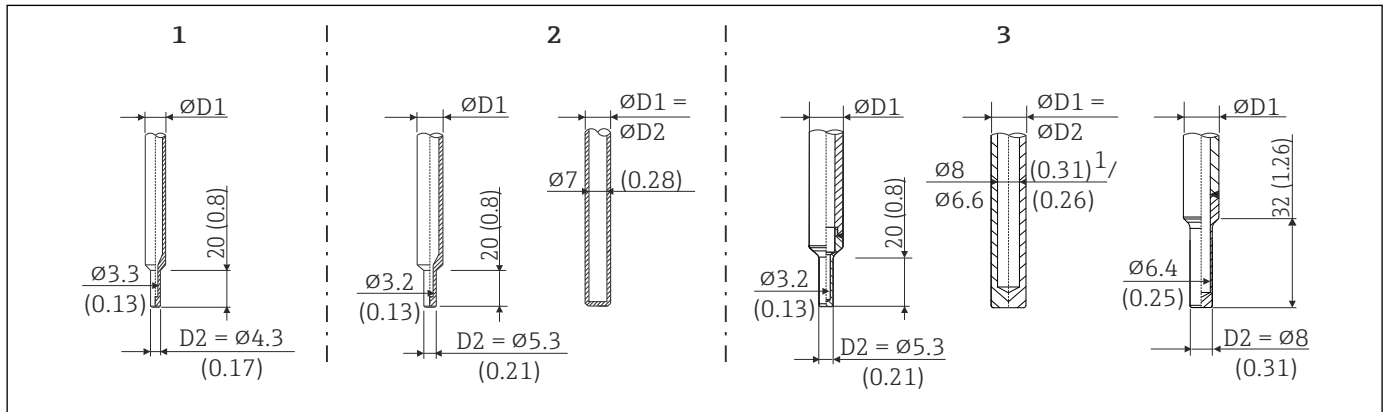

16 Thermowell tips available (reduced, straight or tapered)

Item no.	Thermowell ($\varnothing D1$)	Tip ($\varnothing D2$)	Insert ($\varnothing ID$)
1	$\varnothing 6$ mm ($\frac{1}{4}$ in)	Reduced tip with $\varnothing 4.3$ mm (0.17 in)	$\varnothing 3$ mm ($\frac{1}{8}$ in)
2	$\varnothing 9$ mm (0.35 in)	<ul style="list-style-type: none"> ■ Reduced tip with $\varnothing 5.3$ mm (0.21 in) ■ Straight tip: $\varnothing D1 = \varnothing D2$ 	<ul style="list-style-type: none"> ■ $\varnothing 3$ mm ($\frac{1}{8}$ in) ■ $\varnothing 6$ mm ($\frac{1}{4}$ in) ■ $\varnothing 3$ mm ($\frac{1}{8}$ in)
3	$\varnothing 12.7$ mm ($\frac{1}{2}$ in)	<ul style="list-style-type: none"> ■ Reduced tip with $\varnothing 5.3$ mm (0.21 in) ■ Straight tip: $\varnothing D1 = \varnothing D2$ ■ Reduced tip with $\varnothing 8$ mm (0.31 in) 	<ul style="list-style-type: none"> ■ $\varnothing 3$ mm ($\frac{1}{8}$ in) ■ $\varnothing 6$ mm ($\frac{1}{4}$ in) ■ $\varnothing 6$ mm ($\frac{1}{4}$ in)

i It is possible to check the mechanical loading capacity as a function of the installation and process conditions online using the Sizing Thermowell calculation tool in the Endress+Hauser Applicator software. <https://portal.endress.com/webapp/applicator>

14.7 Certificates and approvals

Current certificates and approvals for the product are available at www.endress.com on the relevant product page:

1. Select the product using the filters and search field.
2. Open the product page.
3. Select **Downloads**.

Hygiene standard	<ul style="list-style-type: none"> ■ EHEDG certification, type EL CLASS I. EHEDG-certified/tested process connections. ■ 3-A authorization no. 1144, 3-A Sanitary Standard 74-07. Listed process connections. ■ ASME BPE (latest edition), certificate of conformity can be ordered for indicated options ■ FDA-compliant ■ All surfaces in contact with the medium are free of animal derived ingredients (ADI/TSE) and do not contain any materials derived from bovine or animal sources.
Materials in contact with food/product (FCM)	<p>The process contact parts (FCM) are in conformity with the following European Regulations:</p> <ul style="list-style-type: none"> ■ Regulation (EC) No 1935/2004, on materials and articles intended to come into contact with food, article 3, paragraph 1, article 5 and 17. ■ Regulation (EC) No 2023/2006 on good manufacturing practice for materials and articles intended to come into contact with food. ■ Regulation (EU) No 10/2011 on plastic materials and articles intended to come into contact with food.
CRN approval	<p>The CRN approval is only available for certain thermowell versions. These versions are identified and displayed accordingly during the configuration of the device.</p> <p>Detailed ordering information is available for your nearest sales organization www.addresses.endress.com or in the Download Area under www.endress.com :</p> <ol style="list-style-type: none"> 1. Select the country 2. Select Downloads 3. In the search area: select Approvals/approval type 4. Enter the product code or device 5. Start the search
Surface purity	<ul style="list-style-type: none"> ■ Free from oil and grease for O₂ applications, optional ■ PWIS-free (PWIS = paint-wetting impairment substances as per DIL0301), optional
Material resistance	<p>Material resistance - including resistance of housing - to the following Ecolab cleaning/disinfection agents:</p> <ul style="list-style-type: none"> ■ P3-topax 66 ■ P3-topactive 200 ■ P3-topactive 500 ■ P3-topactive OKTO ■ And demineralized water





15 Operating menu and parameter description





 The following tables list all the parameters in the “Setup”, “Calibration”, “Diagnostics” and “Expert” operating menus. The page number refers to where a description of the parameter can be found.



Depending on the parameter configuration, not all submenus and parameters are available in every device. Information on this can be found in the parameter description under “Prerequisite”.

This symbol  indicates how to navigate to the parameter using operating tools (e.g. FieldCare).

Setup →	Tag name	→  82
	Unit	→  82
	4 mA value	→  82
	20 mA value	→  83
	Failure mode	→  83



Calibration →	Number of self-calibrations	→  83
	Perf. Self-calibrations	→  83
	Deviation	→  84
	Adjustment	→  84



Calibration →	Limits →	Lower warning value	→  84
		Upper warning value	→  84
		Lower alarm value	→  85
		Upper alarm value	→  85

Calibration →	Interval monitoring ¹⁾ →	Controller	→  86
		Start value	→  86
		Count value	→  86

1) Same parameter settings both for self calibration monitoring and manual calibration reminder

Calibration →	Calibration report	→  87
	 Online wizard	

Diagnostics →	Current diagnostics	→  87
	Previous diagnostics 1	→  87
	Operating time	→  88

Diagnostics →	Diagnostic list →	Number of current diagnostic messages	→  88
		Current diagnostics	→  88
		Current diag (n) channel ¹⁾	→  88

1) n = 2, 3; diagnostic messages with the highest priority to the third-highest priority

Diagnostics →	Event logbook →	Previous diagnostics n ¹⁾	→ 89
		Previous diag (n) channel	→ 89

1) n = Number of diagnostic messages (n = 1 to 5)

Diagnostics →	Device information →	Tag name	→ 82
		Measuring point (TAG)	→ 89
		Serial number	→ 90
		Firmware version	→ 90
		Device name	→ 90
		Order code	→ 90
		Extended order code (2, 3)	→ 91
		Manufacturer ID	→ 91
		Manufacturer	→ 91
		Hardware revision	→ 91
		Configuration counter	→ 92

Diagnostics →	Measured values →	Sensor value	→ 92
		Sensor raw value	→ 92
		Device temperature	→ 92

Diagnostics →	Measured values →	Min/max values →	Sensor min value	→ 93
			Sensor max value	→ 93
			Reset sensor min/max values	→ 93
			Device temperature min.	→ 93
			Device temperature max.	→ 93
			Reset device temp. min/max values	→ 94

Diagnostics →	Simulation →	Diagnostic simulation	→ 94
		Current output simulation	→ 94
		Current output value	→ 94
		Sensor simulation	→ 95
		Simulation value sensor	→ 95

Diagnostics →	Diagnostic settings →	Diagnostic behavior	→ 95
----------------------	------------------------------	---------------------	-------

Diagnostics →	Diagnostic settings →	Status signal	→ 96
----------------------	------------------------------	---------------	-------

Diagnostics →	Heartbeat Technology →	Heartbeat verification	→ 96
		Online wizard	

Expert →	Enter access code		→ 96
	Operating software access rights		→ 97
	Locking status		→ 97

Expert →	System →	Unit	→ 82
		Damping	→ 98

Expert →	System →	Administration →	Define device write protection code	→ 98
			Device reset	→ 99









Expert →	Output →	4 mA value	→ 82
		20 mA value	→ 83
		Failure mode	→ 99
		Failure current	→ 100
		Current trimming 4 mA	→ 100
		Current trimming 20 mA	→ 101

Expert →	Output →	Current loop test configuration →	Current loop test configuration	→ 101
			Simulation value 1	→ 102
			Simulation value 2	→ 102
			Simulation value 3	→ 102
			Current loop test interval	→ 101

Expert →	Communication →	HART configuration →	Tag name	→ 82
			HART short tag	→ 103
			HART address	→ 103
			No. of preambles	→ 104
			Configuration changed	→ 104





Expert →	Communication →	HART info →	Device type	→ 104
			Device revision	→ 105
			Device ID	→ 105
			Manufacturer ID	→ 105
			HART revision	→ 105
			HART descriptor	→ 105
			HART message	→ 106
			Hardware revision	→ 106
			Software revision	→ 106
			HART date	→ 106
			Process unit TAG	→ 106
			Location Description	→ 107
			Longitude	→ 107

	Latitude	→  107
	Altitude	→  107
	Location method	→  108

Expert →	Communication →	HART output →	Assign current output (PV)	→  108
			PV	→  108
			Assign SV	→  108
			SV	→  109
			Assign TV	→  109
			TV	→  109
			Assign QV	→  109
			QV	→  109

15.1 Setup menu

This menu contains all the parameters that are needed to configure the basic settings of the device. The thermometer can be put into operation with this limited parameter set.

Device tag	
Navigation	 Setup → Device tag Diagnostics → Device information → Device tag Expert → Communication → HART configuration → Device tag
Description	Use this function to enter a unique name for the measuring point so it can be identified quickly within the plant.
User entry	Max. 32 characters, such as letters, numbers or special characters (e.g. @, %, /)
Factory setting	Depends on the product root and the serial number
Unit	
Navigation	 Setup → Unit Expert → System → Unit
Description	Use this function to select the engineering unit for all the measured values.
Options	<ul style="list-style-type: none"> ■ °C ■ °F ■ K ■ °R
Factory setting	°C
Additional information	 Please note that if the factory setting (°C) is switched to another unit, all the temperature value settings will be converted to fit to the setted temperature unit. Example: Upper range value is set to 150 °C. After the unit was switched to °F, the new converted upper range value = 302 °F.
4 mA value	
Navigation	 Setup → Lower range value Expert → Output → 4 mA value
Description	Use this function to assign a measured value to the current value 4 mA.
Factory setting	0 °C

20 mA value

Navigation	 Setup → Upper range value Expert → Output → 20 mA value
Description	Use this function to assign a measured value to the current value 20 mA.
Factory setting	150 °C

Failure mode

Navigation	 Setup → Failure mode Expert → Output → Failure mode
Description	Use this function to select the signal on alarm level of the current output in an event of an error.
Options	<ul style="list-style-type: none"> ■ High alarm ■ Low alarm
Factory setting	Low alarm

15.2 Calibration menu

 All the information that describes the self-calibration procedure as well as the online wizard creating a calibration report.

Number of self-calibrations

Navigation	 Calibration → Number of self-calibrations
Description	This counter displays the amount of all executed self-calibrations. It cannot be reset.

Stored self-calibration points

Navigation	 Calibration → Stored self-calibration points
Description	Displays the amount of all stored self-calibration points. This device is able to store 350 self-calibration points. As soon as the memory would reach its limit, the oldest self-calibration point will be overwritten.
Display	0 to 350

Deviation

Navigation	 Calibration → Deviation
Description	This function displays the measured Pt100 self-calibration deviation from the reference temperature. The deviation is calculated as follows: Self-calibration deviation = reference temperature - measured Pt100 temperature value + adjustment
Display	_.__ °C
Factory setting	0

Adjustment

Navigation	 Calibration → Adjustment
Description	Use this function to adjust the measured Pt100 value. This value will be added to the measured Pt100 value and therefore influences also the self-calibration deviation. Self-calibration deviation = reference temperature - measured Pt100 temperature value + adjustment
User entry	$-1.0 \cdot 10^{20}$ to $+1.0 \cdot 10^{20}$
Factory setting	0.000

15.2.1 "Limits" submenu

Lower warning value

Navigation	 Calibration → Limits → Lower warning value
Description	Enter the lower warning limit for the self-calibration deviation.
User entry	$-1.0 \cdot 10^{20}$ to -0.5 °C
Factory setting	-0.5 °C
Additional information	Use this function to define the lower warning limit. If the self-calibration deviation exceeds the defined limit, the device will transmit the defined status signal and shows the defined diagnostic behavior via the LED (diagnostic event 144). (Factory setting = Warning - LED red flashes).

Upper warning value

Navigation	 Calibration → Limits → Upper warning value
Description	Enter the upper warning limit for the self calibration deviation.
User entry	+0.5 to +1.0 · 10 ²⁰ °C
Factory setting	+0.5 °C
Additional information	Use this function to define the upper warning limit. If the self-calibration deviation exceeds the defined limit, the device will transmit the defined status signal and shows the defined diagnostic behavior via the LED. (Factory setting = Warning - LED red flashes).

Lower alarm value

Navigation	 Calibration → Limits → Lower alarm value
Description	Enter the lower alarm limit for the self-calibration deviation.
User entry	-1.0 · 10 ²⁰ to -0.8 °C
Factory setting	-0.8 °C
Additional information	Use this function to define the lower alarm limit. If the self-calibration deviation exceeds the defined limit, the device will transmit the defined status signal and show the defined diagnostic behavior via the LED (diagnostic event 143). (Factory setting = Warning - LED red flashes).

Upper alarm value

Navigation	 Calibration → Limits → Upper alarm value
Description	Enter the upper alarm limit for the self-calibration deviation.
User entry	+0.8 to +1.0 · 10 ²⁰ °C
Factory setting	+0.8 °C
Additional information	Use this function to define the upper alarm limit. If the self-calibration deviation exceeds the defined limit, the device will transmit the defined status signal and shows the defined diagnostic behavior via the LED. (Factory setting = Warning - LED red flashes).

15.2.2 "Interval monitoring" submenu

-  The parameter configuration in this submenu is allocated into two calibration items:
- Self-calibration monitoring:** Monitoring function for the start of the next self-calibration.
 - Manual calibration reminder:** This function signalizes when the next manual calibration has to be performed.

Control

Navigation

 Calibration → Interval monitoring → Self-calibration monitoring / Manual calibration reminder → Control

Description

Self-calibration monitoring: Use this function to activate the self-calibration countdown. This counter will count down from its start value until the next self-calibration is executed. A successful self-calibration will set the counter to its start value. If the calibration counter value reaches zero, the device will transmit the defined status signal and shows the defined diagnostic behavior via the LED (Factory default = Alarm - red).

Manual calibration reminder: Use this function to set the start value for the calibration counter.

Options

- **Off:** Stops the calibration counter
- **On:** Starts the calibration counter
- **Reset + run:** Resets the calibration counter to the set start value and starts the calibration counter

Factory setting

Off

Start value

Navigation

 Calibration → Interval monitoring → Self-calibration monitoring / Manual calibration reminder → Start value

Description

Self-calibration monitoring: Enter the maximum days until a self-calibration must be initiated. This function can be used to monitor the self-calibration interval (e.g. 1 year self-calibration interval corresponds to a start value of 365 days).

Manual calibration reminder: Use this function to set the start value for the calibration counter.

User entry

0 to 1826 d (days)

Factory setting

1826 d

Countdown value

Navigation

 Calibration → Interval monitoring → Self-calibration monitoring / Manual calibration reminder → Countdown value

Description **Self-calibration monitoring:** Displays the remaining time in days until a self-calibration must be initiated. A successful self-calibration will set the counter to its start value. If the countdown value reaches zero, the device will transmit the defined status signal and show the defined diagnostic behavior via the LED, Factory default = Alarm - LED red illuminated
Manual calibration reminder: Indication of the remaining time up to the next calibration.

Display Remaining time in days, from max. 1826 d to 0 d.

Additional information Use this function to view the time remaining until the next calibration. The countdown of the calibration counter is only running if the device is switched on.
Example: The calibration counter is set to 365 days on January 1st, 2011. If the device will be switched off for 100 days, the calibration counter alarm is displayed on April 10th, 2012.

Online wizard 'Calibration report'

Calibration report

Navigation  Calibration → Calibration report

Description Online wizard for creating a calibration report.

Additional information For a detailed procedure description see →  27

15.3 “Diagnostics” menu

Current diagnostics

Navigation  Diagnostics → Current diagnostics

Description Displays the current diagnostic message. If several messages occur simultaneously, the message with the highest priority is shown on the display.

Additional information Example for display format:
F001-Device failure

Previous diagnostics 1

Navigation  Diagnostics → Previous diagnostics 1

Description Displays the last diagnostic message with the highest priority.

Additional information Example for display format:
F001-Device failure

Operating time

Navigation	 Diagnostics → Operating time
Description	Displays the length of time the device has been in operation.
Display	Hours (h)

15.3.1 “Diagnostic list” submenu

Up to three diagnostic messages currently pending are displayed in this submenu. If more than three messages are pending, the messages with the highest priority are shown on the display. Overview of all the diagnostic messages and remedial actions →  37.

Number of current diagnostic messages

Navigation	 Diagnostics → Diagnostic list → Number of current diagnostic messages
Description	Displays the number of diagnostic messages currently pending in the device.

Current diagnostics

Navigation	 Diagnostics → Diagnostic list → Current diagnostics
Description	Use this function to display the current diagnostic messages with the highest priority to the third-highest priority.
Additional information	Example for display format: F001-Device failure

Current diagnostics channel

Navigation	 Diagnostics → Diagnostic list → Current diagnostics channel
Description	Indication of the sensor input to which this diagnostic message refers. Displays the current diagnostic message. If several messages occur simultaneously, the message with the highest priority is shown on the display.
Display	<ul style="list-style-type: none"> ■ ----- ■ Sensor ■ Device temperature ■ Reference sensor ■ Current output

15.3.2 “Event logbook” submenu

Previous diagnostics n

 n = Number of diagnostic messages (n = 1 to 5)

Navigation

 Diagnostics → Event logbook → Previous diagnostics n

Description

Display of past diagnostic messages.
Display of diagnostic messages that appeared in the past. The last five messages are listed in chronological order.

Additional information

Example for display format:
S844-Process value out of specification

Previous diag channel

Navigation

 Diagnostics → Event logbook → Previous diag channel

Description

Indication of the sensor input to which this diagnostic message refers.
Use this function to display the possible sensor input to which the diagnostic message refers.

Display

- -----
- Sensor
- Device temperature
- Reference sensor
- Current output

15.3.3 “Device information” submenu

Device tag → 82

Navigation

 Setup → Device tag
Diagnostics → Device information → Device tag
Expert → Communication → HART configuration → Device tag



Tagging (TAG), metal/RFID

Navigation

 Diagnostics → Device information → Tagging (TAG), metal/RFID

Description	Use this function to enter a unique name for the measuring point so it can be identified quickly within the plant.
User input	Max. 32 characters, such as letters, numbers or special characters (e.g. @, %, /)
Factory setting	-none-

Serial number

Navigation	 Diagnostics → Device information → Serial number
Description	Displays the serial number of the device. It can also be found on the nameplate.  Uses of the serial number <ul style="list-style-type: none">■ To identify the measuring instrument quickly, e.g. when contacting Endress +Hauser.■ To obtain specific information on the measuring instrument using the Device Viewer: www.endress.com/deviceviewer
Display	Max. 11-digit character string comprising letters and numbers.

Firmware version

Navigation	 Diagnostics → Device information → Firmware version
Description	Displays the device firmware version installed.
Display	Max. 6-digit character string in xx.yy.zz format

Device name



Navigation	 Diagnostics → Device information → Device name
Description	Displays the device name. It can also be found on the nameplate.

Order code

Navigation	 Diagnostics → Device information → Order code
-------------------	---

Description	<p>Displays the order code of the device. It can also be found on the nameplate. The order code is reversibly generated from the extended order code, which defines all the device features of the product structure. In contrast, the device features cannot be read directly from the order code.</p> <p> Useful applications of the order code</p> <ul style="list-style-type: none"> ▪ To order an identical replacement device. ▪ To identify the measuring instrument quickly and easily, e.g. when contacting Endress+Hauser.
--------------------	--

Extended order code (n)

	<p> n = Number of parts of the extended order code (n = 1 to 3)</p>
Navigation	<p> Diagnostics → Device information → Extended order code n</p>
Description	<p>Displays the first, second and/or third part of the extended order code. On account of length restrictions, the extended order code is split into a maximum of three parameters. The extended order code indicates the version of all the features of the product structure for the device and thus uniquely identifies the device. It can also be found on the nameplate.</p> <ul style="list-style-type: none"> ▪ Uses of the extended order code ▪ To order an identical replacement device. ▪ To check the ordered device features using the delivery note.

Manufacturer ID

Navigation	<p> Diagnostics → Device information → Manufacturer ID Expert → Communication → HART info → Manufacturer ID</p>
Description	<p>Use this function to view the manufacturer ID with which the device is registered with the HART FieldComm Group.</p>
Display	<p>2-digit hexadecimal number</p>
Factory setting	<p>0x11</p>

Manufacturer

Navigation	<p> Diagnostics → Device information → Manufacturer</p>
Description	<p>Displays the name of the manufacturer.</p>

Hardware revision

Navigation  Diagnostics → Device information → Hardware revision

Description Indication of the hardware revision of the device.

Configuration counter

Navigation  Diagnostics → Device information → Configuration counter

Description Displays the counter reading for changes to device parameters.



Static parameters, whose values change during optimization or configuration, cause this parameter to increment by 1. This supports parameter version management. If several parameters change, e. g. due to loading of parameters from FieldCare, etc. in the device, the counter can show a higher value. The counter cannot be reset and is also not reset to the default value when the device is reset. If the counter overflows, (16 bit), it starts again at 1.

15.3.4 “Measured values” submenu

Sensor value

Navigation  Diagnostics → Measured values → Sensor value

Description Displays the current measured value at the sensor input.

Sensor raw value

Navigation  Diagnostics → Measured values → Sensor raw value

Description Displays the non-linearized mV/Ohm value at the specific sensor input.

Device temperature

Navigation  Diagnostics → Measured values → Device temperature

Description Displays the current electronics temperature.

“Min/Max values” submenu

Sensor min value

Navigation  Diagnostics → Measured values → Min/max values → Sensor min value

Description Displays the minimum temperature measured in the past at the sensor input (minimum indicator).

Sensor max value

Navigation  Diagnostics → Measured values → Min/max values → Sensor max value

Description Displays the maximum temperature measured in the past at the sensor input (maximum indicator).

Reset sensor min/max values

Navigation  Diagnostics → Measured values → Min/max values → Reset sensor min/max values

Description Resets the min/max values of the sensor to their default values.

User input Clicking the **Reset sensor min/max values** button activates the reset function. As a result of this action, the min/max values of the sensor only display the reset, temporary values.

Device temperature min.

Navigation  Diagnostics → Measured values → Min/max values → Device temperature min.

Description Displays the minimum electronics temperature measured in the past (minimum indicator).

Device temperature max.

Navigation  Diagnostics → Measured values → Min/max values → Device temperature max.



Description Displays the maximum electronics temperature measured in the past (peakhold indicator).

Reset device temp. min/max values

Navigation	 Diagnostics → Measured values → Min/max values → Reset device temp. min/max values
Description	Resets the peakhold indicators for the minimum and maximum electronic temperatures measured.
User input	Clicking the Reset device temperature min/max values button activates the reset function. As a result of this action, the min/max values for the device temperature only display the reset, temporary values.

15.3.5 “Simulation” submenu

Diagnostic simulation

Navigation	 Diagnostics → Simulation → Diagnostic simulation
Description	Switches diagnostic simulation on and off.
Selection	Enter one of the diagnostic events using the dropdown menu →  37. In the simulation mode, the assigned status signals and diagnostic behaviors are applied. Example: x001-Device failure
Factory setting	Off

Current output simulation

Navigation	 Diagnostics → Simulation → Current output simulation
Description	Use this function to switch simulation of the current output on and off. The status signal indicates a category “C” diagnostic message (“function check”) while the simulation is running.
Selection	<ul style="list-style-type: none"> ■ Off ■ On
Factory setting	Off

Value current output

Navigation	 Diagnostics → Simulation → Value current output
-------------------	---

Description	Use this function to set a current value for the simulation. In this way, users can verify the correct adjustment of the current output and the correct function of downstream evaluation units.
User input	3.58 to 23 mA
Factory setting	3.58 mA

Sensor simulation



Navigation	 Diagnostics → Simulation → Sensor simulation
Description	Use this function to switch simulation of the sensor temperature on and off. The status signal indicates a category “C” diagnostic message (“function check”) while the simulation is running.
Selection	<ul style="list-style-type: none"> ■ Off ■ On
Factory setting	Off

Sensor simulation value

Navigation	 Diagnostics → Simulation → Sensor simulation value
Description	Use this function to set a sensor temperature for the simulation. In this way, users can verify the correct adjustment of the sensor temperature limits and the correct function of downstream switching units.
User input	$-1.0 \cdot 10^{20}$ to $+1.0 \cdot 10^{20}$ °C
Factory setting	0.00 °C

15.3.6 “Diagnostic settings” submenu

Diagnostic behavior

Navigation	 Diagnostics → Diagnostic settings → Diagnostic behavior
Description	Each diagnostic event is assigned a certain diagnostic behavior. The user can change this assignment for certain diagnostic events. →  37
Selection	<ul style="list-style-type: none"> ■ Alarm ■ Warning ■ Disabled

Factory setting See the list of diagnostic events →  37

Status signal

Navigation  Diagnostics → Diagnostic settings → Status signal

Description Each diagnostic event is assigned to a certain status signal ¹⁾ from the factory. The user can change this assignment for certain diagnostic events. →  37

1) Digital information available via HART® communication

Selection

- Failure (F)
- Function check (C)
- Out of specification (S)
- Maintenance required (M)
- No effect (N)

Factory setting See the list of diagnostic events →  37

15.3.7 “Heartbeat Technology” submenu

“Heartbeat Verification” online wizard

Heartbeat Verification

Navigation  Diagnostics → Heartbeat Technology → Heartbeat Verification

Description Online wizard for creating a Heartbeat Verification report.

Additional information For a detailed procedure description: →  32

15.4 “Expert” menu

Enter access code

Navigation  Expert → Enter access code

Description Use this function to enable the service parameters via the operating tool. If an incorrect access code is entered, users retain their current access authorization.

 If a value is entered that is not to equal to the access code, the parameter is automatically set to **0**. The service parameters should only be modified by the service organization.

Additional information	<p>Software device write protection is also switched on and off with this parameter.</p> <p>Software device write protection in conjunction with download from an operating tool with offline capabilities</p> <ul style="list-style-type: none"> ■ Download, the device does not have a defined write protection code: The download is performed as normal. ■ Download, defined write protection code, device is not locked. <ul style="list-style-type: none"> ■ The Enter access code parameter (offline) contains the correct write protection code: the download is carried out, and the device is not locked following the download. The write protection code in the Enter access code parameter is set to 0. ■ The Enter access code parameter (offline) does not contain the correct write protection code: the download is carried out, and the device is locked following the download. The write protection code in the Enter access code parameter is reset to 0. ■ Download, defined write protection code, device is locked. <ul style="list-style-type: none"> ■ The Enter access code parameter (offline) contains the correct write protection code: the download is carried out, and the device is locked following the download. The write protection code in the Enter access code parameter is reset to 0. ■ The Enter access code parameter (offline) does not contain the correct write protection code: the download is not carried out. No values are changed in the device. The value of the Enter access code parameter (offline) also remains unchanged.
User input	0 to 9999
Factory setting	0

Operating software access rights

Navigation	 Expert → Operating software access rights
Description	Displays the access authorization to the parameters.
Additional information	If an additional write protection is active, this restricts the current access authorization even further. The write protection status can be viewed via the Locking status parameter.
Selection	<ul style="list-style-type: none"> ■ Operator ■ Service
Factory setting	Operator

Locking status

Navigation	 Expert → Locking status
Description	Displays the device locking status. When write protection is activated, write access to the parameters is disabled.
Display	Activated or deactivated box: Write protected by software

15.4.1 “System” submenu

Unit →  82

Navigation  Setup → Unit
Expert → System → Unit

Damping

Navigation  Expert → System → Damping

Description Use this function to set the time constant of the measured value.

User input 0 to 120 s

Factory setting 0 s

Additional information The current output responds to fluctuations in the measured value with an exponential delay. The time constant of this delay is defined by this parameter. If a low time constant is entered, the current output responds quickly to the measured value. On the other hand, if a high time constant is entered, the current output reaction is delayed.

“Administration” submenu

Define device write protection code

Navigation  Expert → System → Administration → Define device write protection code

Description Use this function to set a write protection code for the device.

 If the code is programmed into the device firmware, it is saved in the device and the operating tool displays the value **0** so that the defined write protection code is not openly displayed for viewing.

User input 0 to 9999

Factory setting 0

 If the device is delivered with this factory setting, the device write protection is not active.

Additional information

- Activating device write protection: A value must be entered in the **Enter access code** parameter, which does not correspond to this defined device write protection code.
- Deactivating device write protection: if device write protection is activated, enter the defined write protection code in the **Enter access code** parameter.
- Once the device has been reset to the factory setting or the order configuration, the defined write protection code is no longer valid. The code adopts the factory setting (= 0).



If the device write protection code was forgotten, it can be deleted or overwritten by the service organization.

Device reset

Navigation

Expert → System → Administration → Device reset

Description

Use this function to reset the device configuration - either entirely or in part - to a defined state.

Selection

- **Restart device**

The device is restarted but the device configuration remains unchanged.

- **To delivery settings**

All the parameters are reset to the order configuration. The order configuration can differ from the factory setting if customer-specific parameter values were defined when the device was ordered.

- **To factory defaults**

All the parameters are reset to the factory setting.

15.4.2 “Output” submenu

4 mA value → 82

Navigation

Setup → Lower range value
Expert → Output → 4 mA value

20 mA value → 83

Navigation

Setup → 20 mA value
Expert → Output → 20 mA value

Failure mode → 83

Navigation

Setup → Failure mode
Expert → Output → Failure mode

Failure current

Navigation  Expert → Output → Failure current

Prerequisite The **High alarm** option is enabled in the “Failure mode” parameter.

Description Use this function to set the value the current output adopts in the event of an error.

User input 21.5 to 23 mA

Factory setting 22.5

Adjustment of the analog output (4 and 20 mA current trimming)

Current trimming is used to compensate the analog output (D/A conversion). Here, the output current of the transmitter can be adapted so that it suits the value expected at the higher-level system.

 Current trimming does not affect the digital HART® value. This can cause the measured value shown on the locally installed display to differ marginally from the value displayed in the higher-level system.

Procedure

1. Start
↓
2. Install an accurate ammeter (more accurate than the transmitter) in the current loop.
↓
3. Switch on current output simulation and set the simulation value to 4 mA.
↓
4. Measure the loop current with the ammeter and make a note of the value.
↓
5. Set the simulation value to 20 mA.
↓
6. Measure the loop current with the ammeter and make a note of the value.
↓
7. Enter the current values determined as adjustment values in the Current trimming 4 mA / 20 mA parameters
↓
8. End

Current trimming 4 mA

Navigation  Expert → Output → Current trimming 4 mA

Description Use this function to set the correction value for the current output at the start of the measuring range at 4 mA.

User input	3.5 to 4.25 mA
Factory setting	4 mA
Additional information	The trimming only affects the current loop values from 3.8 to 20.5 mA. The failure mode with Low Alarm and High Alarm current values is not subject to trimming.

Current trimming 20 mA

Navigation	 Expert → Output → Current trimming 20 mA
Description	Use this function to set the correction value for the current output at the end of the measuring range at 20 mA.
User input	19.50 to 20.5 mA
Factory setting	20,000 mA
Additional information	The trimming only affects the current loop values from 3.8 to 20.5 mA. The failure mode with Low Alarm and High Alarm current values is not subject to trimming.

“Current loop test configuration” submenu

Current loop test configuration

Navigation	 Expert → Output → Current loop test configuration → Current loop test configuration
Description	<p>This function is active when there is at least one value defined. The current loop test function will run at each restart (power up) of the device. Measure the loop current with the ammeter. If the measured values deviate from the simulation values, these current output values must be adjusted.</p> <p>To activate the current loop test, define and activate at least one of the following values.</p>

Additional information

After the device has been started up, the current loop test starts and the activated simulation values will be checked. These loop current values can be measured with an accurate ammeter. If the measured values deviate from the set simulation values, it is recommended to adjust these current output values. For **current trimming 4 mA/20 mA** see description above.

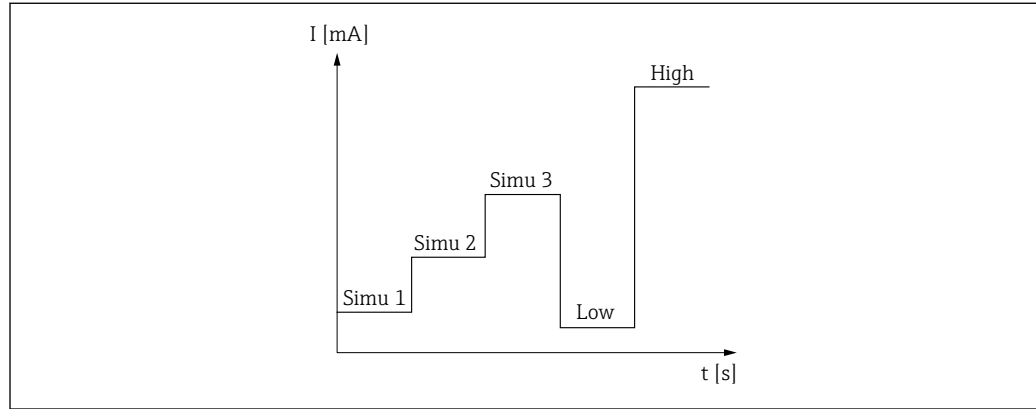

A0039636

 17 Current loop test curve

 If one of the following diagnostic events is active during the startup process, the device cannot perform a current loop test: 001, 401, 411, 437, 501, 531 (channel “-----“ or “Current output”), 537 (channel “-----“ or “Current output”), 801, 825. If the device is operating in the multidrop mode, the current loop test cannot be performed.

Selection

Activation of the check values:

- **Simulation value 1**
- **Simulation value 2**
- **Simulation value 3**
- **Low alarm**
- **High alarm**

Simulation value n

 n = number of simulation values (1 to 3)

Navigation

 Expert → Output → Current loop test configuration → Simulation value n

Description

Use this function to adjust the first, second or third value which will be simulated after each restart to check the current loop.

Selection

Enter the current values to check the loop

- **Simulation value 1**
User input: 3.58 to 23 mA
- **Simulation value 2**
User input: 3.58 to 23 mA
- **Simulation value 3**
User input: 3.58 to 23 mA

Factory setting	<ul style="list-style-type: none"> ■ Simulation value 1: 4.00 mA, not activated ■ Simulation value 2: 12.00 mA, not activated ■ Simulation value 3: 20.00 mA, not activated ■ Low alarm and High alarm not activated
------------------------	---

Current loop test interval

Navigation	 Expert → Output → Current loop test configuration → Current loop test interval
Description	Displays the duration for which each individual value is simulated.
User input	4 to 255 s
Factory setting	4 s

15.4.3 “Communication” submenu

“HART configuration” submenu

Device tag → 82

Navigation	 Setup → Device tag Expert → Communication → HART configuration → Device tag
-------------------	--

HART short tag

Navigation	 Expert → Communication → HART configuration → HART short tag
Description	Use this function to define a short tag for the measuring point.
User input	Up to eight alphanumeric characters (letters, numbers and special characters).
Factory setting	8 x '?'

HART address

Navigation	 Expert → Communication → HART configuration → HART address
Description	Use this function to define the HART address of the device.
User input	0 to 63

Factory setting 0

Additional information The measured value can only be transmitted via the current value if the address is set to "0". The current is fixed at 4.0 mA for all other addresses (Multidrop mode).

No. of preambles

Navigation  Expert → Communication → HART configuration → No. of preambles

Description Use this function to define the number of preambles in the HART telegram.

User input 5 to 20

Factory setting 5

Configuration changed

Navigation  Expert → Communication → HART configuration → Configuration changed

Description Indicates whether the configuration of the device has been changed by a master (primary or secondary).

"HART info" submenu

Device type

Navigation  Expert → Communication → HART info → Device type

Description Use this function to view the device type with which the device is registered with the HART FieldComm Group. The device type is specified by the manufacturer. It is needed to assign the appropriate device description file (DD) to the device.

Display 4-digit hexadecimal number

Factory setting 0x11CF

Device revision

Navigation  Expert → Communication → HART info → Device revision

Description	Use this function to view the device revision with which the device is registered with the HART® FieldComm Group. It is needed to assign the appropriate device description file (DD) to the device.
Display	2-digit hexadecimal number
Factory setting	0x01

Device ID

Navigation	 Expert → Communication → HART info → Device ID
Description	A unique HART identifier is saved in the device ID and used by the control systems to identify the device. The device ID is also transmitted in command 0. The device ID is determined unambiguously from the serial number of the device.
Display	ID generated for specific serial number

Manufacturer ID → 89

Navigation	 Diagnostics → Device information → Manufacturer ID Expert → Communication → HART info → Manufacturer ID
-------------------	--

HART revision

Navigation	 Expert → Communication → HART info → HART revision
Description	Displays the HART revision of the device.

HART descriptor

Navigation	 Expert → Communication → HART info → HART descriptor
Description	Definition of a description for the measuring point.
User input	Up to 16 alphanumeric characters (letters, numbers and special characters)
Factory setting	16 x '?'

HART message

Navigation	 Expert → Communication → HART info → HART message
Description	Use this function to define a HART message which is sent via the HART protocol when requested by the master.
User input	Up to 32 alphanumeric characters (letters, numbers and special characters)
Factory setting	32 x '?'

Hardware revision

Navigation	 Expert → Communication → HART info → Hardware revision
Description	Displays the hardware revision of the device.

Software revision

Navigation	 Expert → Communication → HART info → Software revision
Description	Displays the software revision of the device.

HART date

Navigation	 Expert → Communication → HART info → HART date
Description	Definition of date information for individual use.
User input	Date in year-month-day (YYYY-MM-DD) format
Factory setting	2010-01-01

Process unit tag

Navigation	 Expert → Communication → HART info → Process unit tag
Description	Definition of a tag description for the process unit.
User input	Up to 32 alphanumeric characters (letters, numbers and special characters)

Factory setting 32 x '?'

Location Description

Navigation  Expert → Communication → HART info → Location Description

Description Enter the location description to find the device in the plant.

User input Up to 32 alphanumeric characters (letters, numbers and special characters)

Factory setting 32 x '?'

Longitude

Navigation  Expert → Communication → HART info → Longitude

Description Use this function to enter the longitude coordinates that describe the device location.

User input -180.000 to +180.000 °

Factory setting 0

Latitude

Navigation  Expert → Communication → HART info → Latitude

Description Use this function to enter the latitude coordinates that describe the device location.

User input -90.000 to +90.000 °

Factory setting 0

Altitude

Navigation  Expert → Communication → HART info → Altitude

Description Use this function to enter the altitude data that describes the device location.

User input $-1.0 \cdot 10^{+20}$ to $+1.0 \cdot 10^{+20}$ m

Factory setting 0 m

Location method

Navigation	 Expert → Communication → HART info → Location method
Description	Use this function to select the data format for specifying the geographic location. The codes for specifying the location are based on the US National Marine Electronics Association (NMEA) Standard NMEA 0183.
Selection	<ul style="list-style-type: none"> ■ No fix ■ GPS or Standard Positioning Service (SPS) fix ■ Differential PGS fix ■ Precise positioning service (PPS) ■ Real Time Kinetic (RTK) fixed solution ■ Real Time Kinetic (RTK) float solution ■ Estimated dead reckoning ■ Manual input mode ■ Simulation mode
Factory setting	Manual input mode

“HART output” submenu

Assign current output (PV)

Navigation	 Expert → Communication → HART output → Assign current output (PV)
Description	Use this function to assign the measured variables to the primary HART® value (PV).
Display	Temperature
Factory setting	Temperature (fixed assignment)

PV

Navigation	 Expert → Communication → HART output → PV
Description	Use this function to display the primary HART value

Assign SV

Navigation	 Expert → Communication → HART output → Assign SV
Description	Use this function to assign the measured variable to the secondary HART value (SV).

Display Device temperature (fixed assignment)

SV

Navigation  Expert → Communication → HART output → SV

Description Use this function to display the secondary HART value

Assign TV

Navigation  Expert → Communication → HART output → Assign TV

Description Use this function to assign the measured variable to the tertiary HART value (TV).

Display Number of self-calibrations (fixed assignment)

TV

Navigation  Expert → Communication → HART output → TV

Description Use this function to display the tertiary HART value

Assign QV

Navigation  Expert → Communication → HART output → Assign QV

Description Use this function to assign the measured variable to the quaternary (fourth) HART value (QV).

Display Deviation (fixed assignment)

QV

Navigation  Expert → Communication → HART output → QV

Description Use this function to display the quaternary HART value



www.addresses.endress.com
