

# FLAWSIC550

## Gas flow meters

### High pressure gas flow meter for natural gas distribution

- Ultimate measurement certainty and safety of continuous gas supply
- Simple installation, compatible with turbine gas meters
- Reduction of installation costs due to integrated volume correction
- Easy Commissioning and data reading via FLOWgate™
- Minimal operating costs due to being nearly maintenance-free
- Reliable even when the gas flow fluctuates (on/off applications)
- Self-sufficient operation

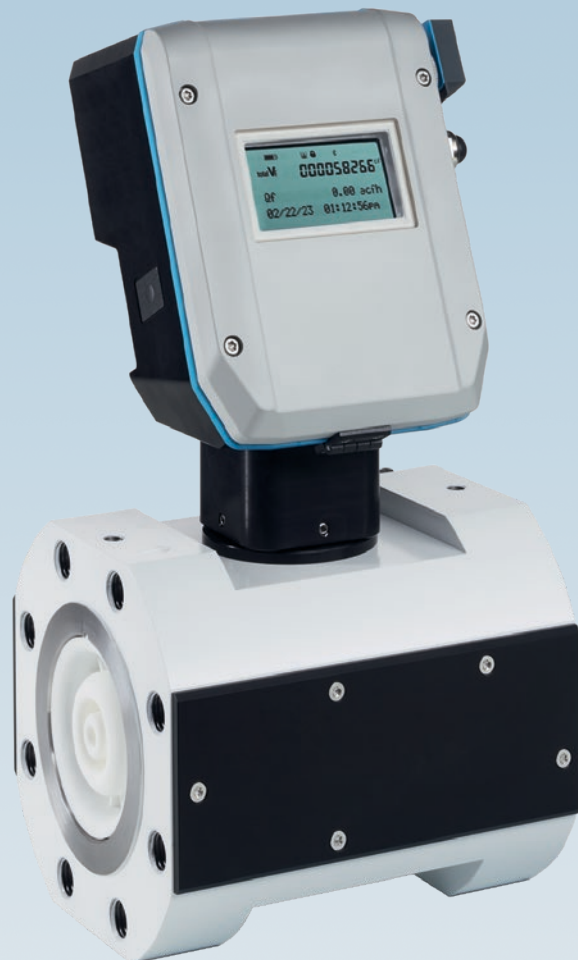

# Ready for the future: with cutting-edge technology for natural gas measurement

Benefit from the latest technology for the ultimate in measurement accuracy: In 2012 we introduced the first ultrasonic gas flow meter for natural gas distribution. Now, thousands of installations later, we present the FLOWSIC550 – the new ultrasonic gas meter dedicated to high-pressure applications in natural gas distribution and midstream measurement systems. With the FLOWSIC550, we now expand our portfolio of ultrasonic gas flow meters and offers a suitable solution for small nominal diameters in the high-pressure range.

## **FLOWSIC550: Simple, cost-effective installation and integration**

The FLOWSIC550 is easy to install, requiring only 3D straight upstream and 2D straight downstream piping. The integrated and patented flow conditioner allows the use in most compact installations and fullfills accuracy requirements for Class 1, according to OIML R 137. Therefore, it can easily be integrated in existing measuring installations.

Gas flow measurement and volume correction have the same goal: providing a precise measurement of the quantity of gas supplied. The FLOWSIC550 combines all functions into one device, thereby helping to save on installation costs and reducing the number of interfaces. The integrated volume corrector supports all typical correction algorithms, such as SGERG88, AGA 8 options e.g. DC92 Gross 1 & Gross 2, and AGA NX-19.



# Replacing mechanical flow meters with modern ultrasonic technology

To replace high pressure turbine meters with smart ultrasonic technology is now as easy as never before. Finally, the next step for the digitalization and modernization of the gas grid can be made. FLOWSIC550 adds digital connectivity, with RS485 Modbus and self-diagnostic capabilities, enabling remote access and condition-based maintenance. This saves operational efforts and increases measurement availability and reduces loss of unaccounted gas (LAUF). FLOWSIC550 makes a 1:1 replacement of mechanical high pressure gas flow meters in existing installations possible.

The design of new metering stations can benefit by leveraging the high turn down ratio of FLOWSIC550. Where before two meters had to be installed, now only one ultrasonic flow meter can do the job.

FLOWSIC550 with its integrated flow conditioners provides a solution for compact meter stations where other high pressure ultrasonic meters could not be installed up to now. Another key feature of the device is that it can be either battery powered to up to five years, or line-powered.

## Four nominal diameters – all easy to operate

Thanks to the use of ultrasound technology and the absence of mechanical components, the FLOWSIC550 offers a competitive advantage over turbine and rotary displacement meters.

The FLOWSIC550 operates either in an energy self-sufficient configuration or with external power supply. When utilized in transfer and measuring stations, FLOWSIC550 ensures a continuous and blockage-free gas supply.

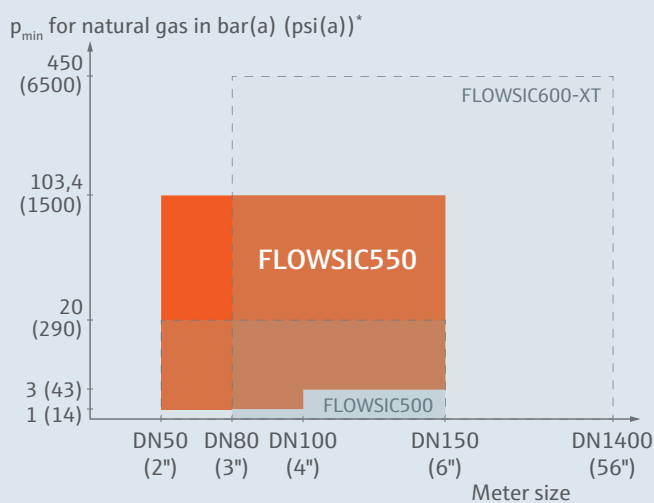

\* Operation with air at ambient pressure possible



# Unique Meter Design

## The design of FLOWSIC550 is unique

The core elements of the FLOWSIC550 is the patented flow conditioner in combination with a compact path layout, using reflective path technology. The design leads to 40% less material usage for the meter and the metering line and additionally the pressure drop could be reduced by 20% compared to with the FLOWSIC500.

## Increasing efficiency in gas distribution

- Gas measurement of low volume applications at high pressures
- Custody transfer: gas distribution and transmission systems
- Town border stations and city gate stations
- Compressor fuel gas measurement
- High pressure industrial gas measurement
- Applications where a continuous gas supply must be ensured



# Simple integration via FLOWgate™ software

- Bluetooth® or wired: always well connected. In addition to the standardized interfaces for data communication, FLOWSIC550 is equipped with a dedicated commissioning and service interface: Equipped with the Bluetooth® compatible adapter, wireless connections of up to 30 m are possible with Bluetooth® enabled end devices. Alternatively, a wired adapter with USB-C interface is also available.
- The FLOWgate™ user software offers a user friendly and results-oriented solution for all life cycle management tasks of the FLOWSIC550.
- FLOWgate™, with its wizards for calibration, commissioning and device diagnostics, supports the almost maintenance-free operation of the gas flow meter and can also be used to remotely monitor the gas flow meter.
- The Device Manager shows all registered devices, and offers device grouping and a convenient data backup function. Thanks to the integrated database you can access the stored data anytime offline or online.
- The intuitive operation and multi-language support of FLOWgate™ makes the FLOWSIC550 gas flow meter easy to use.



Device Manager

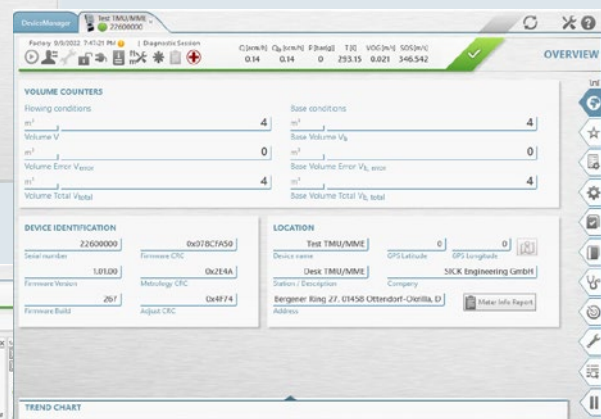

Overview

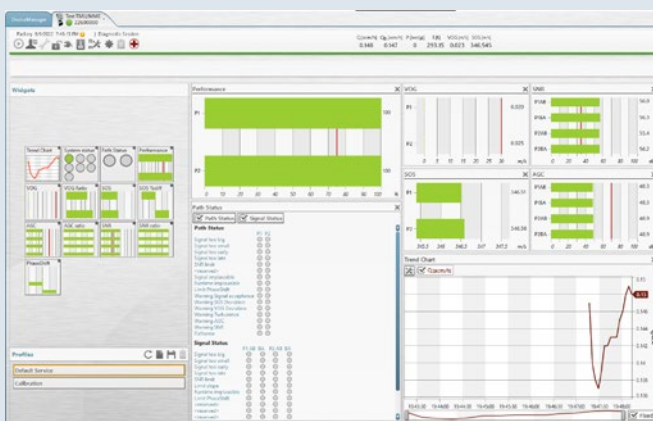

Meter values

# FLOWSIC550: High pressure gas flow meter for natural gas distribution



## Product description

The cutting-edge technology for natural gas measurement: The new FLOWSIC550 ultrasonic compact gas meter ensures highly accurate metering for low volumes at high pressures in gas distribution - a perfect addition to FLOWSIC500. In absence of mechanical moving parts, the FLOWSIC550 is a robust, fail-safe and low-maintenance device – allowing for a significant reduction in operating

costs. It is overload-proof, accurate and is monitored by an intelligent diagnostics system. FLOWSIC550 can easily be integrated into existing measuring stations. The FLOWSIC550 operates either in an energy self-sufficient configuration or in network operation. When utilized in transfer and measuring stations, FLOWSIC550 ensures a continuous and blockage free gas supply.

## At a glance

- Rugged and time-proven ultrasound technology
- Diagnostics and permanent operational self-monitoring
- Durable and reliable without moving parts
- Compact meter installations
- Integrated volume correction
- Battery or intrinsically safe power supply
- Bluetooth Low Energy (BLE)

## Your benefits

- Ultimate measurement certainty and safety of continuous gas supply
- Simple installation, compatible with turbine gas meters
- Reduction of installation costs due to integrated volume correction
- Easy Commissioning and data reading via FLOWgate™
- Minimal operating costs due to being nearly maintenance-free
- Reliable even when the gas flow fluctuates (on/off applications)
- Self-sufficient operation

## Fields of application

- Gas Measurement of low volume applications at high pressures
- Custody transfer: gas distribution, uni-directional storage, and transmission systems
- Town border stations and city gate stations
- High pressure industrial gas measurement
- Compressor fuel gas measurement
- Critical applications where continuous gas supply must be ensured



## More Information online

For more information, enter the link or scan the QR code to get direct access to technical data, operating instructions, software, application examples, and much more.

[www.endress.com/flowsic550](http://www.endress.com/flowsic550)



# Technical data

The exact device specifications and performance data of the product may deviate from the information provided here, and depend on the application in which the product is being used and the relevant customer specifications.

## FLAWSIC550

Measured values	Volume a.c., volume flow a.c., gas velocity In addition, for integrated volume correction: volume s.c., volume flow s.c.
Measurement principle	Ultrasonic transit time difference measurement
Measuring medium	Natural gas (dry, odorized), air
Measuring ranges	
	DN50 / 2"
	2.5 m <sup>3</sup> /h ... 160 m <sup>3</sup> /h at p <sub>min</sub> 0.8 bar(a) (88 cf/h ... 5,650 cf/h at p <sub>min</sub> 12 psi(a))
	DN80 / 3"
	4.0 m <sup>3</sup> /h ... 400 m <sup>3</sup> /h at p <sub>min</sub> 0.8 bar(a) (141 cf/h ... 14,125 cf/h at p <sub>min</sub> 12 psi(a))
	DN100 / 4"
	22 m <sup>3</sup> /h ... 650 m <sup>3</sup> /h at p <sub>min</sub> 3 bar(a) (777 cf/h ... 22,955 cf/h at p <sub>min</sub> 44 psi(a)) 6.5 m <sup>3</sup> /h ... 650 m <sup>3</sup> /h at p <sub>min</sub> 10 bar(a) (229 cf/h ... 22,955 cf/h at p <sub>min</sub> 145 psi(a))
	DN150 / 6"
	53 m <sup>3</sup> /h ... 1,600 m <sup>3</sup> /h at p <sub>min</sub> 3 bar(a) (1,872 cf/h ... 56,503 cf/h bei p <sub>min</sub> 44 psi(a)) 16 m <sup>3</sup> /h ... 1,600 m <sup>3</sup> /h at p <sub>min</sub> 10 bar(a) (565 cf/h ... 56,503 cf/h at p <sub>min</sub> 145 psi(a))
	Pressure ranges valid for natural gas, meter operation possible at ambient pressure for air
Repeatability	≤ 0.1%
Accuracy	Accuracy class 1; typical error limits: Q <sub>min</sub> up to Q <sub>max</sub> : ≤ ±1%
	Accuracy class 1; maximum allowed error limits: Q <sub>min</sub> up to 0.1 Q <sub>max</sub> : ≤ ±2% 0.1 Q <sub>max</sub> up to Q <sub>max</sub> : ≤ ±1%
	After high pressure flow calibration: ±0.2% at test pressure, otherw. ±0.5%
Diagnostic functions	Permanent monitoring of measured values
Gas temperature	-40 °C ... +70 °C (-40 °F ... +158 °F)
Operating pressure	
	ANSI300 (ASME B16.5)
	up to 48.6 bar(g) for -40 °C ... +70 °C (up to 706 psi(g) for -40 °F ... +158 °F)
	ANSI600 (ASME B16.5)
	up to 97.2 bar(g) for -40 °C ... +70 °C (up to 1,410 psi(g) for -40 °F ... +158 °F)
	PN40 (EN 1092-1)
	up to 40 bar(g) for -40 °C ... +70 °C (up to 580 psi(g) for -40 °F ... +158 °F)
	PN63 (EN 1092-1)
	up to 63 bar(g) for -40 °C ... +70 °C (914 psi(g) for -40 °F ... +158 °F)
Ambient temperature	-40 °C ... +70 °C (-40 °F ... +158 °F)
Conformities	MID: 2014/32/EU OIML R 137-1&2:2012 EN 12405:2018 (for integrated volume correction) AGA 9, 2022

Ex approvals	
	ATEX II 2 (1)G Ex ia [ia Ga] T4 IIB Gb
	IECEX Ex ia [ia Ga] T4 IIB Gb
	NEC/CEC (US/CA) Class I Division 1, Groups C, D T4 Ex ia [ia Ga] IIB T4 Gb Class I, Zone 1, AEx ia [ia Ga] IIB T4 Gb
Enclosure rating	IP66 Type 3R
Digital outputs	2x pulse and status (HF with fmax = 2 kHz, LF with fmax = 10 Hz) 2x RS485, external powered Encoder
RS485 protocol	Modbus RTU, Modbus ASCII, ISO 17089-1
Interface	Wired M12/USB Adapter or wireless adapter (BLE)
Material in contact with media	Low Temperature Carbon Steel
Mounting	Horizontal or vertical installation Min. piping requirements depending on predisturbance: Mild: 3D straight inlet/2D straight outlet Severe: 5D straight inlet/2D straight outlet
Electrical connection	Intrinsically safe supply 8 V DC ... 16 V DC, max. 50 mA Battery powered (optional), life time 5 years
Dimensions	see dimensional drawings
Weight	
	DN50/2" 26 kg (57 lbs)
	DN80/3" 46 kg (101 lbs)
	DN100/4" 87 kg (192 lbs)
	DN150/6" 207 kg (456 lbs)

### Volume Correction

Accuracy	
	Conversion factor C Accuracy class 0.5 Maximum permitted error limits of $\leq \pm 0.5\%$ (at reference conditions)
Correction method	PTZ
Compressibility	SGERG88; AGA 8 Gross method 1; AGA 8 Gross method 2 AGA 8 DC92; AGA NX-19; AGA NX-19 mod.; ERG91; Fixed value
Data archives	Measurement period archive (6,000 entries) Daily archive (600 entries) Monthly archive (25 entries) Diagnostic archive (6,000 entries)
Log books	Event log book (1,000 entries) Parameter log book (250 entries) Metrology log book (100 entries) Gas parameter log book (150 entries)
Pressure sensor	
	Absolute pressure 0.8 bar(a) ... 20 bar(a) (12 psi(a) ... 290 psi(a)) 7 bar(a) ... 35 bar (a) (102 psi(a) ... 508 psi(a)) 14 bar(a) ... 70 bar(a) (203 psi(a) ... 1,015 psi(a)) 25 bar(a) ... 130 bar(a) (363 psi(a) ... 1,885 psi(a))
	Gauge pressure 0 bar(g) ... 70 bar(g) (0 psi(g) ... 1,015 psi(g)) 0 bar(g) ... 103,46 bar(g) (0 psi(g) ... 1,500 psi(g))
Temperature sensor	-40 °C ... +70 °C (-40 °F ... +158 °F) (PT1000 class A)

## Sizing Chart

Corrected Capacity at Metering Pressure in MSCFH at Various Operating Pressures [psi(g)]

Meter size	2"	3"	4"	6"
Model	5.5 M	14 M	23 M	56 M
Rating (ACFH)	5600	14000	23000	56000
1	6	14.9	-	-
5	7.5	18.7	-	-
10	9.4	23.4	-	-
15	11.3	28.2	-	-
20	13.2	32.9	-	-
25	15.0	37.6	-	-
50	24.5	61.2	100.6	244.8
75	33.9	84.7	139.2	338.8
100	43.2	108.1	177.6	432.5
125	52.6	131.4	215.9	525.7
150	61.9	154.7	254.1	618.7
175	71.1	177.8	292.1	711.3
200	80.3	200.9	330.0	803.5
275	107.8	269.5	442.7	1078.0
285	111.4	278.6	457.7	1114.3
300	116.9	292.2	480.0	1168.7
400	152.8	382.0	627.5	1527.9
500	188.1	470.2	772.5	1880.8
600	222.7	556.8	914.7	2227.2
700	256.7	641.7	1054.2	2566.9
800	290.0	724.9	1190.9	2899.6
900	322.5	806.3	1324.7	3225.3
1000	354.3	885.3	1455.3	3543.4
1100	385.4	963.6	1583.1	3854.5
1200	415.9	1039.8	1708.2	4159.1
1300	445.6	1114.0	1830.1	4456.0
1400	474.6	1186.5	1949.3	4746.1

# Ordering information

Our regional sales organization will help you to select the optimum device configuration.

## Dimensional drawings

Pressure and temperature sensor (dimensions in mm (inch))

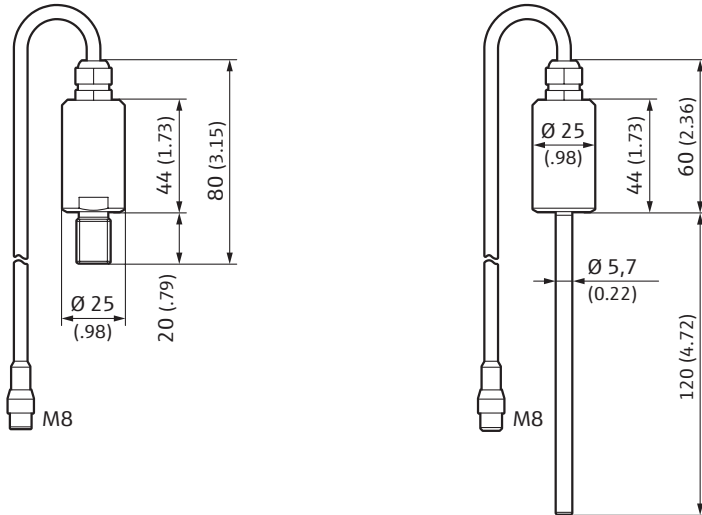

FLOWSIC550 (dimensions in mm (inch))

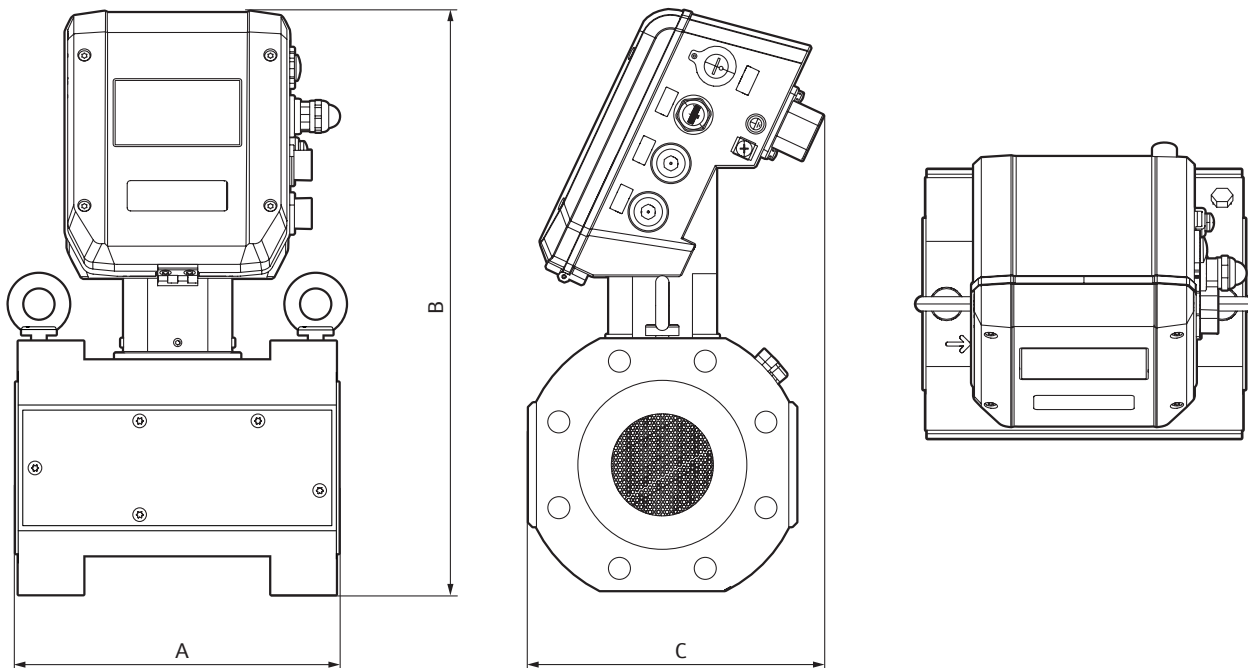

Nominal size	Dimensions [mm (inch)]		
	A	B	C
DN50/2"	150 (5.91")	425 (16.73")	220 (8.66")
DN80/3"	240 (9.45")	425 (16.73")	220 (8.66")
DN100/4"	300 (11.81")	500 (19.69")	250 (9.84")
DN150/6"	450 (17.72")	560 (22.05")	300 (11.81")

# Application areas

## Pressure loss

FLAWSIC550 causes a typical pressure loss of:

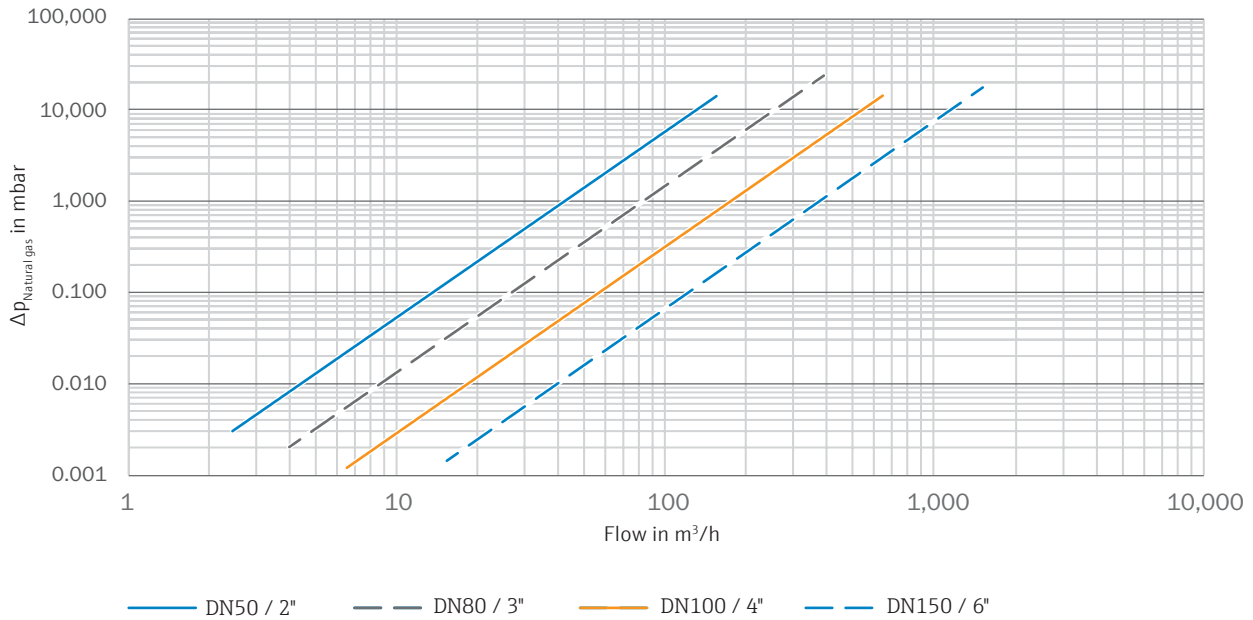

Reference density natural gas:  $\rho = 0.83 \text{ kg/m}^3$

FLAWSIC550 causes a typical pressure loss of:

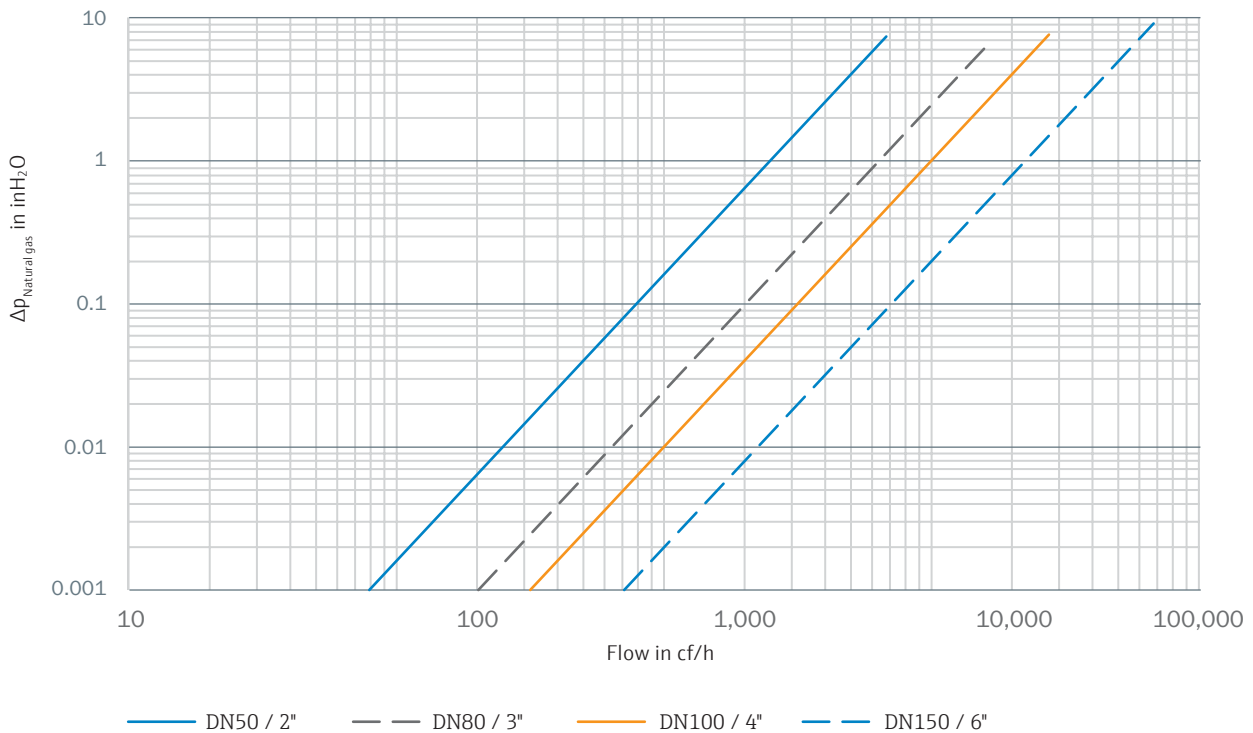

Reference density natural gas:  $\rho = 0.052 \text{ lb/cf}$

[www.addresses.endress.com](http://www.addresses.endress.com)

---

Eco-friendly produced and printed on paper  
from sustainable forestry.

IND1385D/90/EN/04.26-00  
(8029942 / EN / V2-5)