

Brief Operating Instructions

LNGmass

Coriolis flowmeter

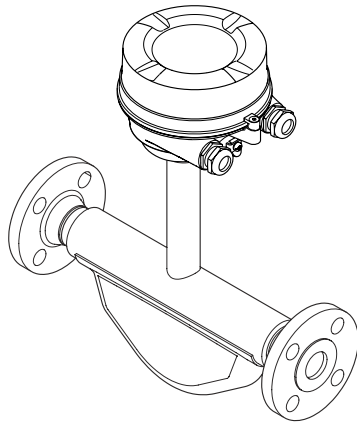

These Brief Operating Instructions are **not** a substitute for the Operating Instructions pertaining to the device.

Brief Operating Instructions Part 1 of 2: Sensor

Contain information about the sensor.

Brief Operating Instructions Part 2 of 2: Transmitter .



A0023555





Table of contents

1	Document information	4
1.1	Symbols used	4
2	Basic safety instructions	6
2.1	Requirements for the personnel	6
2.2	Designated use	6
2.3	Workplace safety	7
2.4	Operational safety	7
2.5	Product safety	7
2.6	IT security	8
3	Product description	9
3.1	Product design	9
4	Incoming acceptance and product identification	10
4.1	Incoming acceptance	10
4.2	Product identification	11
5	Storage and transport	12
5.1	Storage conditions	12
5.2	Transporting the product	12
6	Installation	14
6.1	Installation conditions	14
6.2	Mounting the measuring device	16
6.3	Post-installation check	17
7	Electrical connection	18
7.1	Connection conditions	18
7.2	Connecting the measuring device	22
7.3	Hardware settings	24
7.4	Ensuring the degree of protection	25
7.5	Post-connection check	26
8	Operation options	27
8.1	Structure and function of the operating menu	27
8.2	Access to the operating menu via the operating tool	27
9	System integration	29
10	Commissioning	29
10.1	Function check	29
10.2	Establishing a connection via FieldCare	29
10.3	Configuring the measuring device	29
10.4	Defining the tag name	29
10.5	Protecting settings from unauthorized access	29
11	Diagnostic information	30







1 Document information

1.1 Symbols used



1.1.1 Safety symbols

Symbol	Meaning
 A0011189-EN	DANGER! This symbol alerts you to a dangerous situation. Failure to avoid this situation will result in serious or fatal injury.
 A0011190-EN	WARNING! This symbol alerts you to a dangerous situation. Failure to avoid this situation can result in serious or fatal injury.
 A0011191-EN	CAUTION! This symbol alerts you to a dangerous situation. Failure to avoid this situation can result in minor or medium injury.
 A0011192-EN	NOTICE! This symbol contains information on procedures and other facts which do not result in personal injury.









1.1.2 Electrical symbols

Symbol	Meaning
 A0011197	Direct current A terminal to which DC voltage is applied or through which direct current flows.
 A0011198	Alternating current A terminal to which alternating voltage is applied or through which alternating current flows.
 A0017381	Direct current and alternating current <ul style="list-style-type: none"> ▪ A terminal to which alternating voltage or DC voltage is applied. ▪ A terminal through which alternating current or direct current flows.
 A0011200	Ground connection A grounded terminal which, as far as the operator is concerned, is grounded via a grounding system.
 A0011199	Protective ground connection A terminal which must be connected to ground prior to establishing any other connections.
 A0011201	Equipotential connection A connection that has to be connected to the plant grounding system: This may be a potential equalization line or a star grounding system depending on national or company codes of practice.

1.1.3 Tool symbols



Symbol	Meaning
 A0011221	Allen key
 A0011222	Open-ended wrench

1.1.4 Symbols for certain types of information

Symbol	Meaning
 A0011182	Allowed Indicates procedures, processes or actions that are allowed.
 A0011183	Preferred Indicates procedures, processes or actions that are preferred.
 A0011184	Forbidden Indicates procedures, processes or actions that are forbidden.
 A0011193	Tip Indicates additional information.
 A0011194	Reference to documentation Refers to the corresponding device documentation.
 A0011195	Reference to page Refers to the corresponding page number.
 A0011196	Reference to graphic Refers to the corresponding graphic number and page number.
	Series of steps
	Result of a sequence of actions

1.1.5 Symbols in graphics

Symbol	Meaning
1, 2, 3,...	Item numbers
1, 2, 3,...	Series of steps
A, B, C, ...	Views
A-A, B-B, C-C, ...	Sections

Symbol	Meaning
 <small>A0013441</small>	Flow direction
 <small>A0011187</small>	Hazardous area Indicates a hazardous area.
 <small>A0011188</small>	Safe area (non-hazardous area) Indicates a non-hazardous area.

2 Basic safety instructions

2.1 Requirements for the personnel

The personnel must fulfill the following requirements for its tasks:

- ▶ Trained, qualified specialists must have a relevant qualification for this specific function and task.
- ▶ Are authorized by the plant owner/operator.
- ▶ Are familiar with federal/national regulations.
- ▶ Before starting work, read and understand the instructions in the manual and supplementary documentation as well as the certificates (depending on the application).
- ▶ Follow instructions and comply with basic conditions.

2.2 Designated use

Application and media

The measuring device described in these Brief Operating Instructions is intended only for flow measurement of liquids and gases.

Depending on the version ordered, the measuring device can also measure potentially explosive, flammable, poisonous and oxidizing media.

Measuring devices for use in hazardous areas, in hygienic applications or where there is an increased risk due to process pressure, are labeled accordingly on the nameplate.

To ensure that the measuring device remains in proper condition for the operation time:

- ▶ Keep within the specified pressure and temperature range.
- ▶ Only use the measuring device in full compliance with the data on the nameplate and the general conditions listed in the Operating Instructions and supplementary documentation.
- ▶ Based on the nameplate, check whether the ordered device is permitted for the intended use in the hazardous area (e.g. explosion protection, pressure vessel safety).
- ▶ Use the measuring device only for media to which the process-wetted materials are sufficiently resistant.
- ▶ If the measuring device is not operated at atmospheric temperature, compliance with the relevant basic conditions specified in the associated device documentation is absolutely essential: "Documentation" section.

- ▶ Protect the measuring device permanently against corrosion from environmental influences.

Incorrect use

Non-designated use can compromise safety. The manufacturer is not liable for damage caused by improper or non-designated use.

WARNING

Danger of breakage due to corrosive or abrasive fluids!

- ▶ Verify the compatibility of the process fluid with the sensor material.
- ▶ Ensure the resistance of all fluid-wetted materials in the process.
- ▶ Keep within the specified pressure and temperature range.

NOTICE

Verification for borderline cases:

- ▶ For special fluids and fluids for cleaning, Endress+Hauser is glad to provide assistance in verifying the corrosion resistance of fluid-wetted materials, but does not accept any warranty or liability as minute changes in the temperature, concentration or level of contamination in the process can alter the corrosion resistance properties.

Residual risks

WARNING

The electronics and the medium may cause the surfaces to heat up. This presents a burn hazard!

- ▶ For elevated fluid temperatures, ensure protection against contact to prevent burns.

2.3 Workplace safety

For work on and with the device:

- ▶ Wear the required personal protective equipment according to federal/national regulations.

For welding work on the piping:

- ▶ Do not ground the welding unit via the measuring device.

If working on and with the device with wet hands:

- ▶ Due to the increased risk of electric shock, gloves must be worn.

2.4 Operational safety

Risk of injury!

- ▶ Operate the device in proper technical condition and fail-safe condition only.
- ▶ The operator is responsible for interference-free operation of the device.

2.5 Product safety

This measuring device is designed in accordance with good engineering practice to meet state-of-the-art safety requirements, has been tested, and left the factory in a condition in which it is safe to operate.

It meets general safety standards and legal requirements. It also complies with the EU directives listed in the device-specific EU Declaration of Conformity. Endress+Hauser confirms this by affixing the CE mark to the device.

2.6 IT security

We only provide a warranty if the device is installed and used as described in the Operating Instructions. The device is equipped with security mechanisms to protect it against any inadvertent changes to the device settings.

IT security measures in line with operators' security standards and designed to provide additional protection for the device and device data transfer must be implemented by the operators themselves.

3 Product description

3.1 Product design

3.1.1 Device version with Modbus communication types

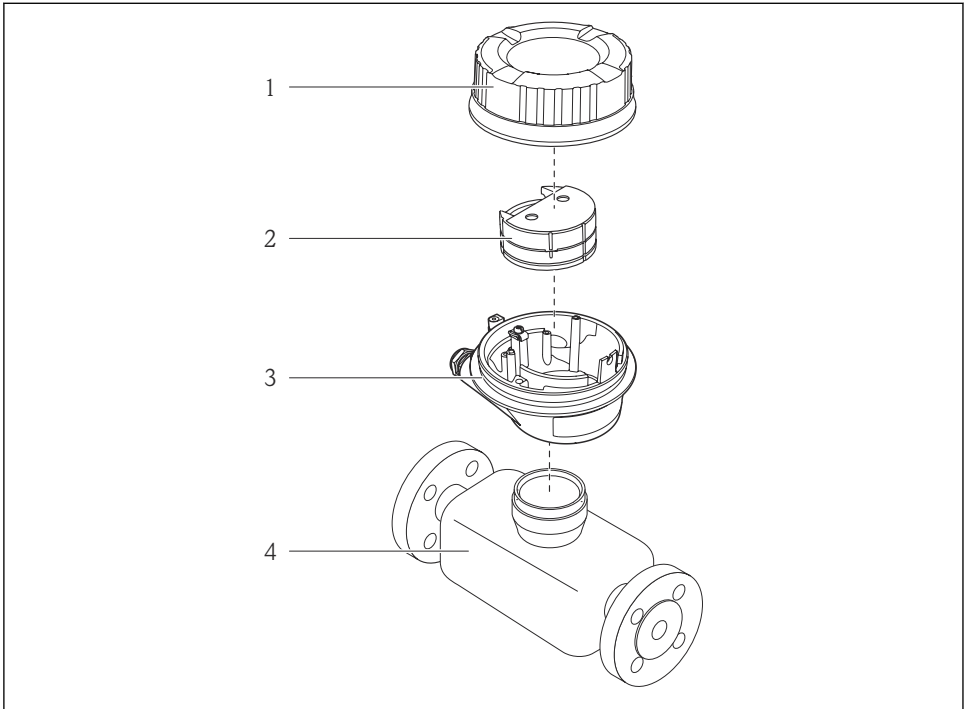

A0017609

1 Important components of a measuring device

- 1 Transmitter housing cover
- 2 Main electronics module
- 3 Transmitter housing
- 4 Sensor



In the case of the device version with Modbus RS485 intrinsically safe, the Safety Barrier Promass 100 forms part of the scope of supply.

4 Incoming acceptance and product identification

4.1 Incoming acceptance



A0015502

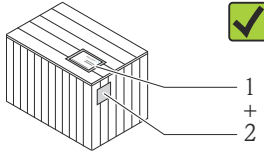
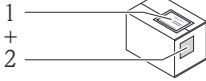

A0013843

Are the order codes on the delivery note (1) and the product sticker (2) identical?

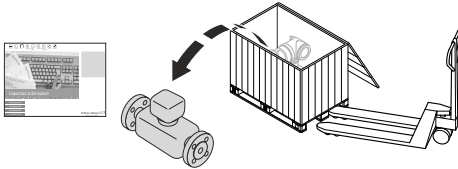

A0013695



A0015502

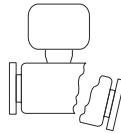
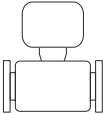

Are the goods undamaged?

A0013698



A0015502

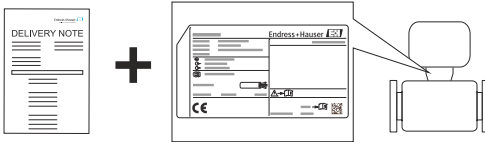

A0013699

Do the nameplate data match the ordering information on the delivery note?





A0015502



A0013697

Is the CD-ROM with the Technical Documentation (depends on device version) and documents present?

-  If one of the conditions is not satisfied, contact your Endress+Hauser Sales Center.
- Depending on the device version, the CD-ROM might not be part of the delivery! In such cases, the technical documentation is available via the Internet or via the *Endress+Hauser Operations App*, see the "Device documentation" section →  11.

4.2 Product identification

The following options are available for identification of the measuring device:

- Nameplate specifications
- Order code with breakdown of the device features on the delivery note
- Enter serial numbers from nameplates in *W@M Device Viewer* (www.endress.com/deviceviewer): All information about the measuring device is displayed.
- Enter the serial number from the nameplates into the *Endress+Hauser Operations App* or scan the 2-D matrix code (QR code) on the nameplate with the *Endress+Hauser Operations App*: all the information for the measuring device is displayed.

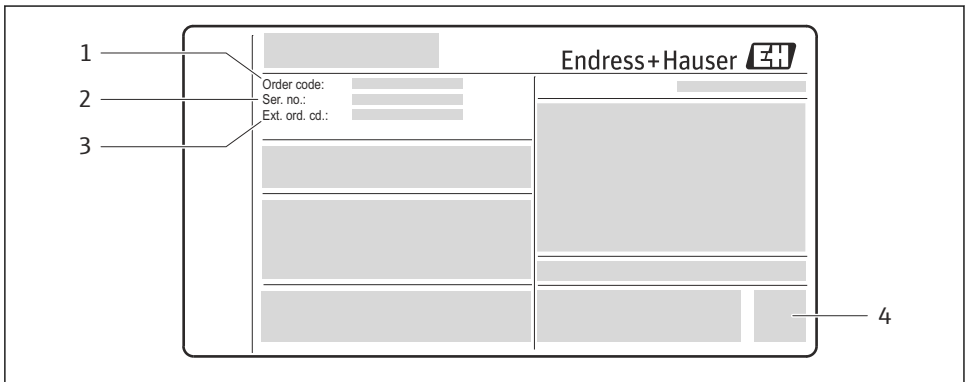

A0021952

 2 Example of a nameplate

- 1 Order code
- 2 Serial number (Ser. no.)
- 3 Extended order code (Ext. ord. cd.)
- 4 2-D matrix code (QR code)



For detailed information on the breakdown of the specifications on the nameplate, see the Operating Instructions for the device →  11.

4.2.1 Device documentation



All devices are supplied with Brief Operating Instructions. These Brief Operating Instructions are not a substitute for the Operating Instructions pertaining to the device!



Detailed information about the device can be found in the Operating Instructions and the other documentation:

- On the CD-ROM supplied (is not included in the delivery for all device versions).
- Available for all device versions via:
 - Internet: www.endress.com/deviceviewer
 - Smart phone/tablet: *Endress+Hauser Operations App*

The information required to retrieve the documentation can be found on the nameplate of the device →  2,  11.

 Technical documentation can also be downloaded from the Download Area of the Endress+Hauser web site: www.endress.com → Download. However this technical documentation applies to a particular instrument family and is not assigned to a specific device.



W@M Device Viewer

1. Launch the W@M Device Viewer: www.endress.com/deviceviewer
2. Enter the serial number (Ser. no.) of the device: see nameplate →  2,  11.
 - ↳ All the associated documentation is displayed.



Endress+Hauser Operations App

 The *Endress+Hauser Operations App* is available both for android smart phones (Google Play store) and for iPhones and iPads (App Store).

Via the serial number:

1. Launch the *Endress+Hauser Operations App*.
2. Enter the serial number (Ser. no.) of the device: see nameplate →  2,  11.
 - ↳ All the associated documentation is displayed.

Via the 2-D matrix code (QR code):

1. Launch the *Endress+Hauser Operations App*.
2. Scan the 2-D matrix code (QR code) on the nameplate →  2,  11.
 - ↳ All the associated documentation is displayed.

5 Storage and transport

5.1 Storage conditions

Observe the following notes for storage:

- ▶ Store in the original packaging to ensure protection from shock.
- ▶ Do not remove protective covers or protective caps installed on process connections. They prevent mechanical damage to the sealing surfaces and contamination in the measuring tube.
- ▶ Protect from direct sunlight to avoid unacceptably high surface temperatures.
- ▶ Store in a dry and dust-free place.
- ▶ Do not store outdoors.

5.2 Transporting the product

Transport the measuring device to the measuring point in the original packaging.

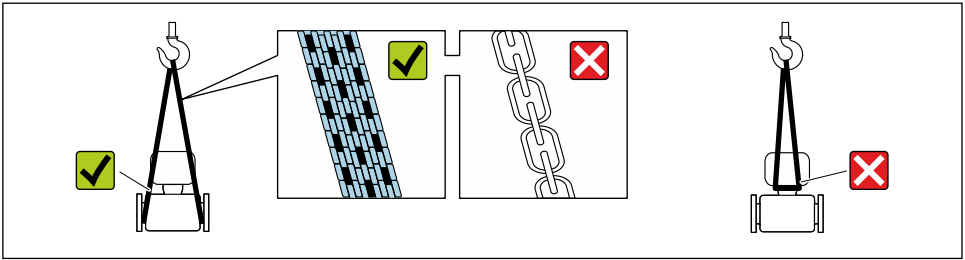

A0029252

i Do not remove protective covers or caps installed on process connections. They prevent mechanical damage to the sealing surfaces and contamination in the measuring tube.

5.2.1 Measuring devices without lifting lugs

⚠ WARNING

Center of gravity of the measuring device is higher than the suspension points of the webbing slings.

Risk of injury if the measuring device slips.

- ▶ Secure the measuring device against slipping or turning.
- ▶ Observe the weight specified on the packaging (stick-on label).

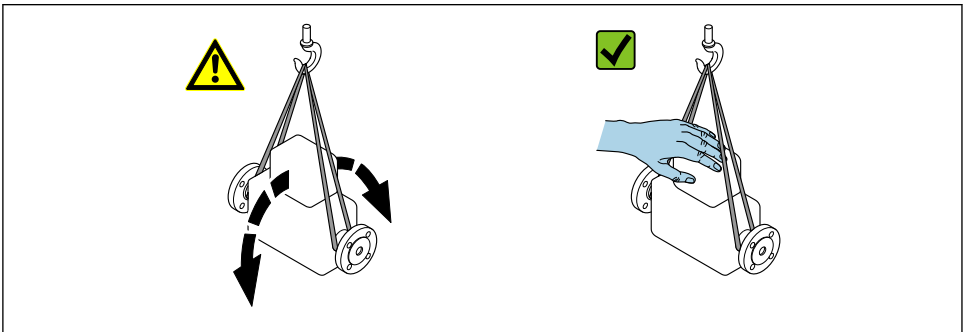

A0029214

5.2.2 Measuring devices with lifting lugs

⚠ CAUTION

Special transportation instructions for devices with lifting lugs

- ▶ Only use the lifting lugs fitted on the device or flanges to transport the device.
- ▶ The device must always be secured at two lifting lugs at least.

5.2.3 Transporting with a fork lift

If transporting in wood crates, the floor structure enables the crates to be lifted lengthwise or at both sides using a forklift.

6 Installation

6.1 Installation conditions

No special measures such as supports are necessary. External forces are absorbed by the construction of the device.

6.1.1 Mounting position

Mounting location

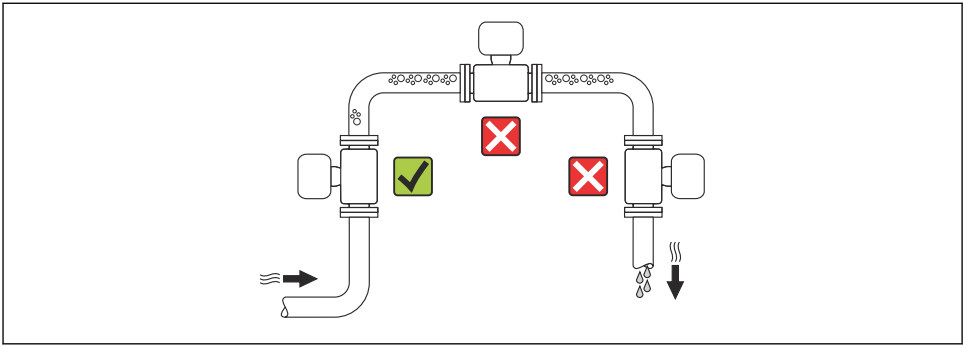



A0015595

Orientation

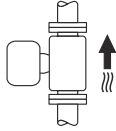
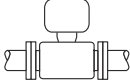
The direction of the arrow on the sensor nameplate helps you to install the sensor according to the flow direction.

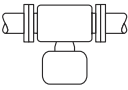
Orientation		Recommendation
A	Vertical orientation	 A0015591 ✓✓
B	Horizontal orientation, transmitter head up	 A0015589 ✓✓ ¹⁾ Exception:

Orientation		Recommendation
C	Horizontal orientation, transmitter head down	 A0015590 ✓✓ ²⁾ Exception:
D	Horizontal orientation, transmitter head at side	 A0015592 ✗

- 1) Applications with low process temperatures may reduce the ambient temperature. To maintain the minimum ambient temperature for the transmitter, this orientation is recommended.
- 2) Applications with high process temperatures may increase the ambient temperature. To maintain the maximum ambient temperature for the transmitter, this orientation is recommended.

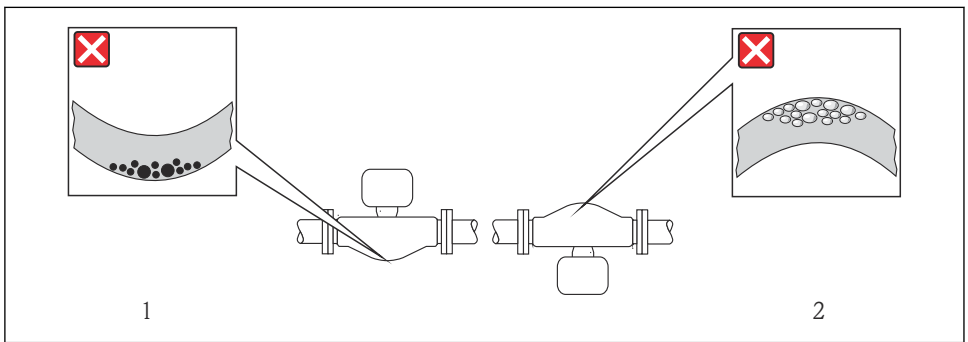

A0014057

Inlet and outlet runs

No special precautions need to be taken for fittings which create turbulence, such as valves, elbows or T-pieces, as long as no cavitation occurs → 16.

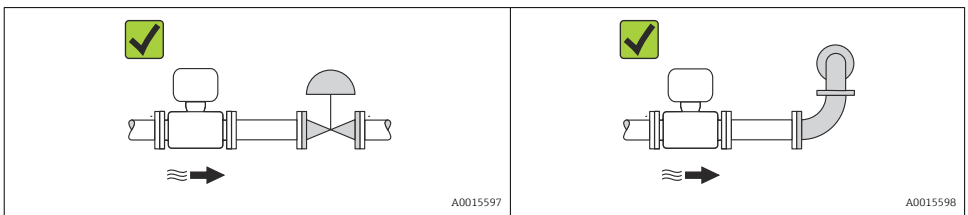

A0015597

A0015598

 For the dimensions and installation lengths of the device, see the "Technical Information" document, "Mechanical construction" section

6.1.2 Requirements from environment and process

Ambient temperature range

Measuring device	-40 to +60 °C (-40 to +140 °F)
Safety Barrier Promass 100	-40 to +60 °C (-40 to +140 °F)

- ▶ If operating outdoors:
Avoid direct sunlight, particularly in warm climatic regions.

System pressure

For this reason, the following mounting locations are recommended:

- At the lowest point in a vertical pipe
- Downstream from pumps (no danger of vacuum)

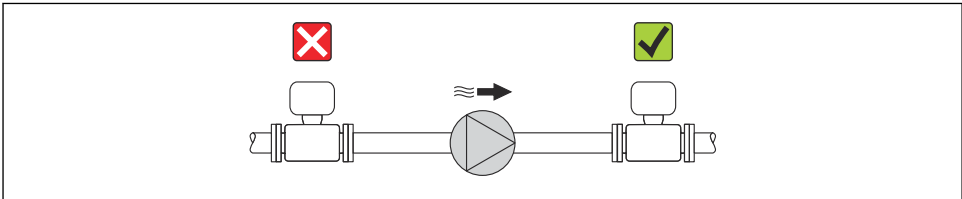

A0015594

Vibrations

The high oscillation frequency of the measuring tubes ensures that the correct operation of the measuring system is not influenced by plant vibrations.

6.1.3 Special mounting instructions

Zero point adjustment

All measuring devices are calibrated in accordance with state-of-the-art technology. Calibration takes place under reference conditions. Therefore, a zero point adjustment in the field is generally not required.

Experience shows that zero point adjustment is advisable only in special cases:

- To achieve maximum measuring accuracy even with low flow rates
- Under extreme process or operating conditions (e.g. very high process temperatures or very high-viscosity fluids).

6.2 Mounting the measuring device

6.2.1 Required tools

For sensor

For flanges and other process connections: Corresponding mounting tools

6.2.2 Preparing the measuring device

1. Remove all remaining transport packaging.
2. Remove any protective covers or protective caps present from the sensor.
3. Remove stick-on label on the electronics compartment cover.

6.2.3 Mounting the measuring device

⚠ WARNING

Danger due to improper process sealing!

- ▶ Ensure that the inside diameters of the gaskets are greater than or equal to that of the process connections and piping.
- ▶ Ensure that the gaskets are clean and undamaged.
- ▶ Install the gaskets correctly.

1. Ensure that the direction of the arrow on the nameplate of the sensor matches the flow direction of the fluid.
2. Install the measuring device or turn the transmitter housing so that the cable entries do not point upwards.

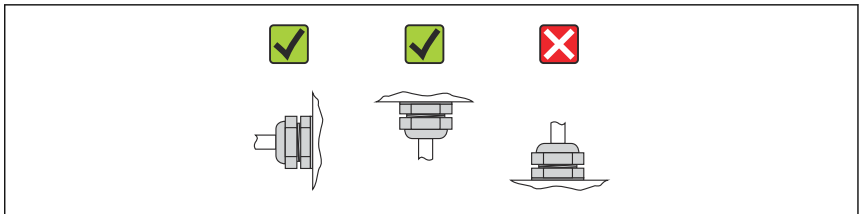

A0013964

6.3 Post-installation check

Is the device undamaged (visual inspection)?	<input type="checkbox"/>
Does the measuring device conform to the measuring point specifications? For example: <ul style="list-style-type: none"> ▪ Process temperature ▪ Process pressure (refer to the chapter on "Material load curves" of the "Technical Information" document on the CD-ROM provided) ▪ Ambient temperature → 16 ▪ Measuring range 	<input type="checkbox"/>
Has the correct orientation for the sensor been selected ? <ul style="list-style-type: none"> ▪ According to sensor type ▪ According to medium temperature ▪ According to medium properties (outgassing, with entrained solids) 	<input type="checkbox"/>
Does the arrow on the sensor nameplate match the direction of flow of the fluid through the piping → 14?	<input type="checkbox"/>
Are the measuring point identification and labeling correct (visual inspection)?	<input type="checkbox"/>
Is the device adequately protected from precipitation and direct sunlight?	<input type="checkbox"/>
Are the securing screw and securing clamp tightened securely?	<input type="checkbox"/>

7 Electrical connection



The measuring device does not have an internal circuit breaker. For this reason, assign the measuring device a switch or power-circuit breaker so that the power supply line can be easily disconnected from the mains.

7.1 Connection conditions

7.1.1 Required tools

- For cable entries: Use corresponding tools
- For securing clamp (on aluminum housing): Allen screw 3 mm
- For securing screw (for stainless steel housing): open-ended wrench 8 mm
- Wire stripper
- When using stranded cables: crimping tool for ferrule

7.1.2 Requirements for connecting cable

The connecting cables provided by the customer must fulfill the following requirements.

Electrical safety

In accordance with applicable federal/national regulations.

Permitted temperature range

- -40 °C (-40 °F) to $+80\text{ °C}$ ($+176\text{ °F}$)
- Minimum requirement: cable temperature range \geq ambient temperature $+20\text{ K}$

Power supply cable

Standard installation cable is sufficient.

Signal cable

Modbus RS485

The EIA/TIA-485 standard specifies two types of cable (A and B) for the bus line which can be used for every transmission rate. Cable type A is recommended.

Cable type	A
Characteristic impedance	135 to 165 Ω at a measuring frequency of 3 to 20 MHz
Cable capacitance	$<30\text{ pF/m}$
Wire cross-section	$>0.34\text{ mm}^2$ (22 AWG)
Cable type	Twisted pairs
Loop resistance	$\leq 110\text{ }\Omega/\text{km}$
Signal damping	Max. 9 dB over the entire length of the cable cross-section
Shielding	Copper braided shielding or braided shielding with foil shield. When grounding the cable shield, observe the grounding concept of the plant.

Connecting cable between Safety Barrier Promass 100 and measuring device

Cable type	Shielded twisted-pair cable with 2x2 wires. When grounding the cable shield, observe the grounding concept of the plant.
Maximum cable resistance	2.5 Ω , one side

- ▶ Comply with the maximum cable resistance specifications to ensure the operational reliability of the measuring device.

Wire cross-section		Maximum cable length	
[mm ²]	[AWG]	[m]	[ft]
0.5	20	70	230
0.75	18	100	328
1.0	17	100	328
1.5	16	200	656
2.5	14	300	984

Cable diameter

- Cable glands supplied:
M20 × 1.5 with cable ϕ 6 to 12 mm (0.24 to 0.47 in)
- Spring terminals:
Wire cross-sections 0.5 to 2.5 mm² (20 to 14 AWG)
- With Safety Barrier Promass 100:
Plug-in screw terminals for wire cross-sections 0.5 to 2.5 mm² (20 to 14 AWG)

7.1.3 Terminal assignment

Transmitter

Modbus RS485 connection version, for use in intrinsically safe areas

Order code for "Output", option **M** (connection via Safety Barrier Promass 100)

Order code for "Housing"	Connection methods available		Possible options for order code "Electrical connection"
	Output	Power supply	
Options A	Terminals	Terminals	<ul style="list-style-type: none"> ■ Option B: thread M20x1 ■ Option C: thread G ½" ■ Option D: thread NPT ½"
Order code for "Housing": Option A : compact, coated aluminum			

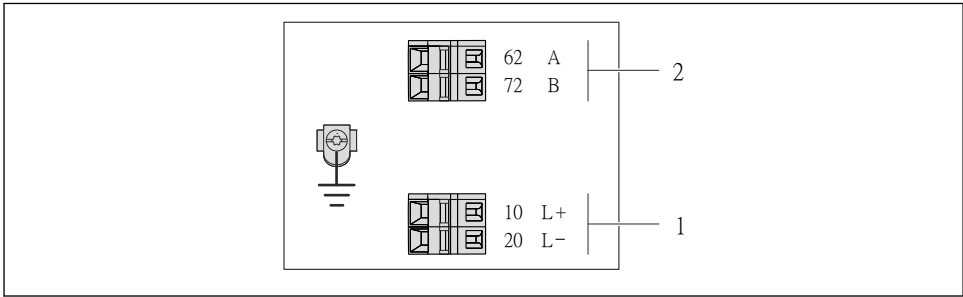

A0017053

3 Modbus RS485 terminal assignment, connection version for use in intrinsically safe areas (connection via Safety Barrier Promass 100)

- 1 Intrinsically safe power supply
- 2 Modbus RS485

Order code for "Output"	20 (L-)	10 (L+)	72 (B)	62 (A)
Option M	Intrinsically safe supply voltage		Modbus RS485 intrinsically safe	
Order code for "Output": Option M : Modbus RS485, for use in intrinsically safe areas (connection via Safety Barrier Promass 100)				

Safety Barrier Promass 100

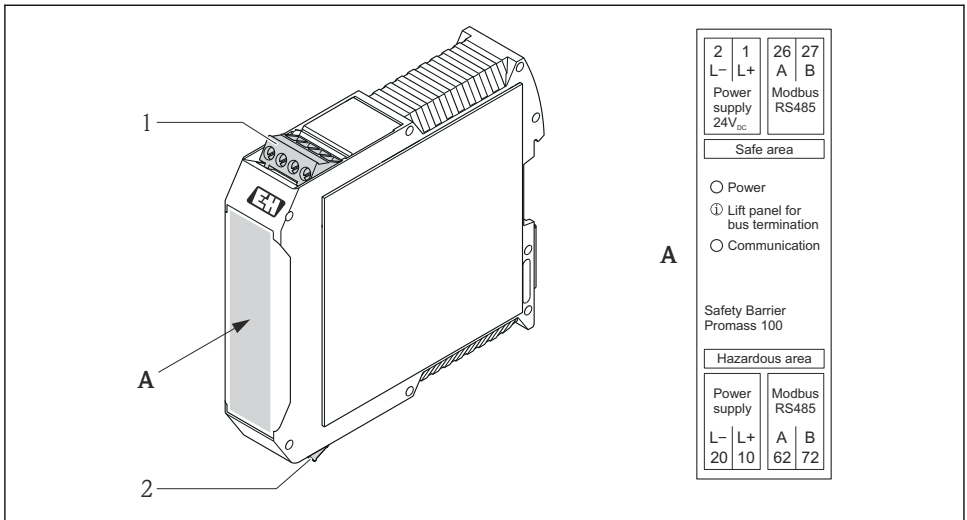

A0016922

4 Safety Barrier Promass 100 with terminals

- 1 Non-hazardous area and Zone 2/Div. 2
- 2 Intrinsically safe area

7.1.4 Shielding and grounding

The shielding and grounding concept requires compliance with the following:

- Electromagnetic compatibility (EMC)
- Explosion protection
- Personal protection equipment
- National installation regulations and guidelines
- Observe cable specification → 18.
- Keep the stripped and twisted lengths of cable shield to the ground terminal as short as possible.
- Seamless cable shielding.

Grounding of the cable shield

To comply with EMC requirements:

- Ensure the cable shield is grounded to the potential matching line at multiple points.
- Connect every local ground terminal to the potential matching line.

NOTICE

In systems without potential matching, the multiple grounding of the cable shield causes mains frequency equalizing currents!

Damage to the bus cable shield.

- ▶ Only ground the bus cable shield to either the local ground or the protective ground at one end.

7.1.5 Preparing the measuring device

1. Remove dummy plug if present.

2. **NOTICE**

Insufficient sealing of the housing!

Operational reliability of the measuring device could be compromised.

► Use suitable cable glands corresponding to the degree of protection.

If measuring device is delivered without cable glands:

Provide suitable cable gland for corresponding connecting cable →  18.

3. If measuring device is delivered with cable glands:

Observe cable specification →  18.

7.2 Connecting the measuring device

NOTICE

Limitation of electrical safety due to incorrect connection!

► For use in potentially explosive atmospheres, observe the information in the device-specific Ex documentation.

7.2.1 Connecting the transmitter

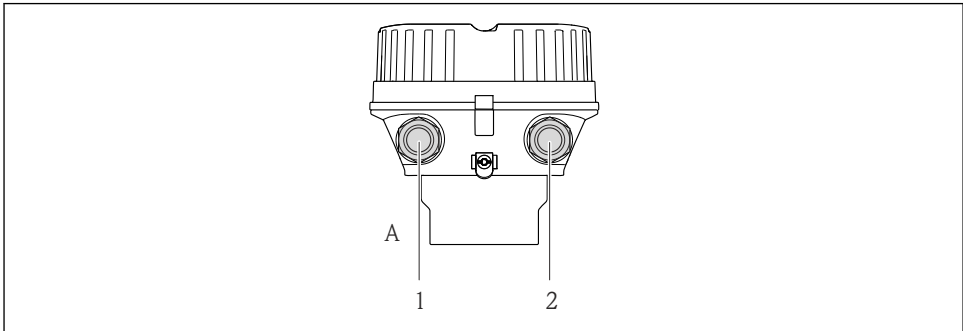

A0019824

 5 *Device versions and connection versions*

A *Housing version: compact, aluminum coated*

1 *Cable entry for signal transmission*

2 *Cable entry for supply voltage*

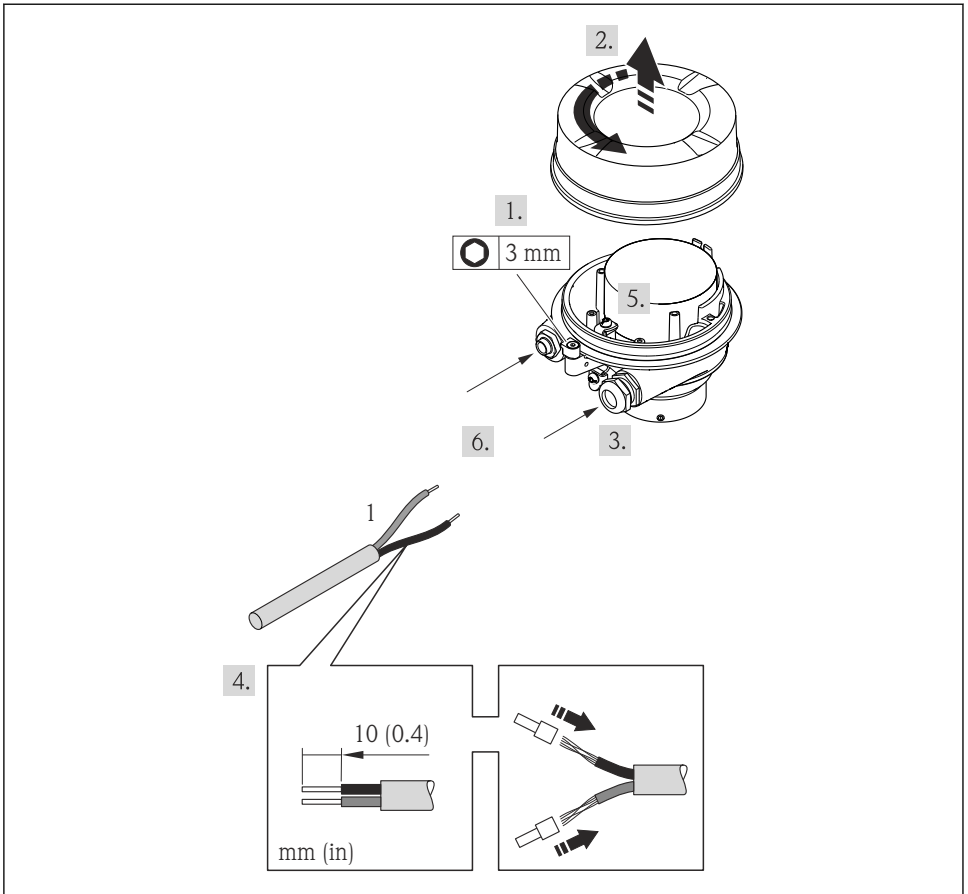

A0021923

6 Device versions with connection example

1 Cable

► Connect the cable in accordance with the terminal assignment .

7.2.2 Connecting the Safety Barrier Promass 100

In the case of the device version with Modbus RS485 intrinsically safe, the transmitter must be connected to the Safety Barrier Promass 100.

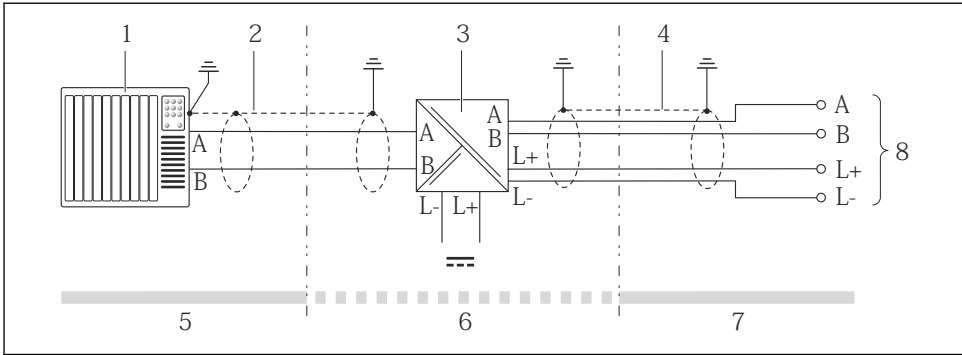

A0016804

7 Electrical connection between the transmitter and Safety Barrier Promass 100

- 1 Control system (e.g. PLC)
- 2 Observe cable specification
- 3 Safety Barrier Promass 100: terminal assignment → 21
- 4 Observe cable specification → 18
- 5 Non-hazardous area
- 6 Non-hazardous area and Zone 2/Div. 2
- 7 Intrinsically safe area
- 8 Transmitter: terminal assignment

7.3 Hardware settings

7.3.1 Enabling the terminating resistor

Modbus RS485

To avoid incorrect communication transmission caused by impedance mismatch, terminate the Modbus RS485 cable correctly at the start and end of the bus segment.

If the transmitter is used in the intrinsically safe area

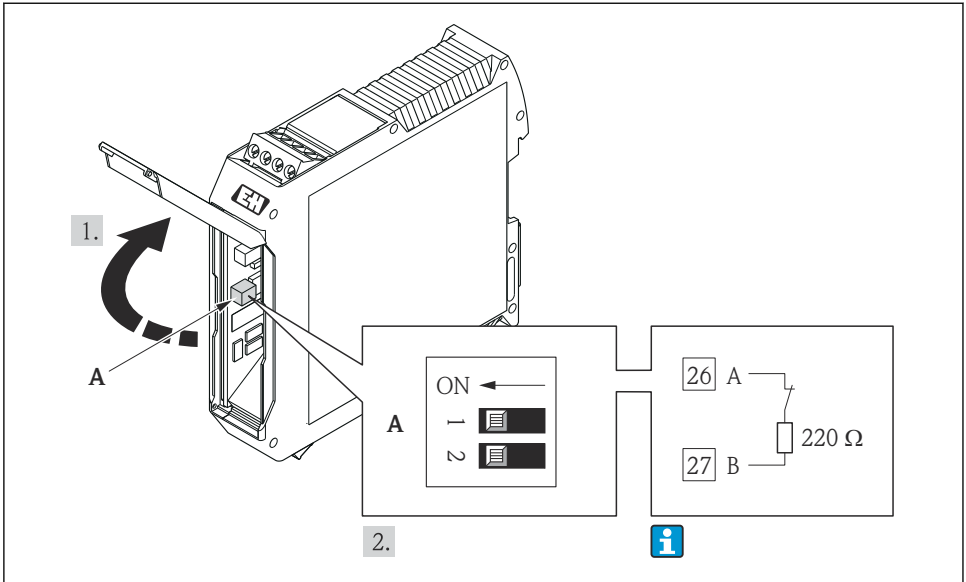

A0017791

8 Terminating resistor can be enabled via DIP switch in the Safety Barrier Promass 100

7.4 Ensuring the degree of protection

The measuring device fulfills all the requirements for the IP66/67 degree of protection, Type 4X enclosure.

To guarantee IP66/67 degree of protection, Type 4X enclosure, carry out the following steps after the electrical connection:

1. Check that the housing seals are clean and fitted correctly. Dry, clean or replace the seals if necessary.
2. Tighten all housing screws and screw covers.
3. Firmly tighten the cable glands.

4. To ensure that moisture does not enter the cable entry, route the cable so that it loops down before the cable entry ("water trap").

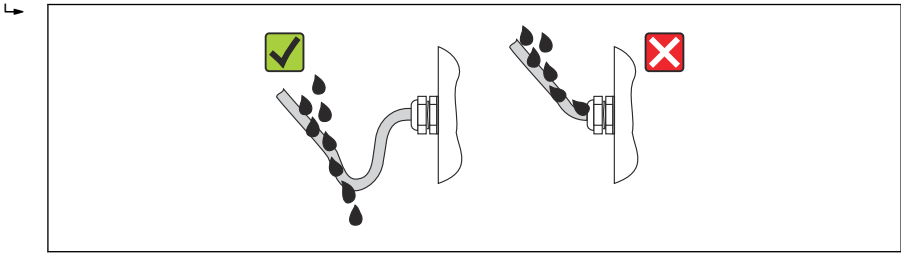

A0013960

5. Insert dummy plugs into unused cable entries.

7.5 Post-connection check

Are cables or the device undamaged (visual inspection)?	<input type="checkbox"/>
Do the cables comply with the requirements → 18?	<input type="checkbox"/>
Do the cables have adequate strain relief?	<input type="checkbox"/>
Are all the cable glands installed, firmly tightened and leak-tight? Cable run with "water trap" → 25 ?	<input type="checkbox"/>
<ul style="list-style-type: none"> ▪ Does the supply voltage match the specifications on the transmitter nameplate ? ▪ For device version with Modbus RS485 intrinsically safe: does the supply voltage match the specifications on the nameplate of the Safety Barrier Promass 100 ? 	<input type="checkbox"/>
Is the terminal assignment correct?	<input type="checkbox"/>
<ul style="list-style-type: none"> ▪ If supply voltage is present, is the power LED on the electronics module of the transmitter lit green → 9? ▪ For device version with Modbus RS485 intrinsically safe, if supply voltage is present, is the power LED on the Safety Barrier Promass 100 lit → 9? 	<input type="checkbox"/>
Depending on the device version, is the securing clamp or fixing screw firmly tightened?	<input type="checkbox"/>

8 Operation options

8.1 Structure and function of the operating menu

8.1.1 Structure of the operating menu

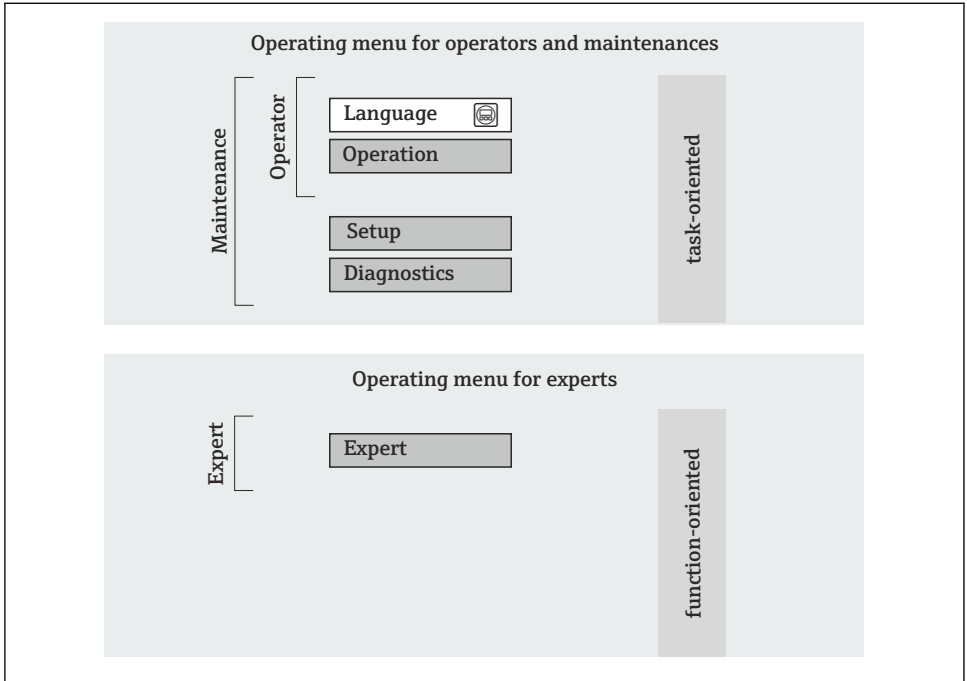

A0014058-EN



9 Schematic structure of the operating menu

8.1.2 Operating philosophy

The individual parts of the operating menu are assigned to certain user roles. Each user role corresponds to typical tasks within the device lifecycle.

 For detailed information about the operating philosophy of the device, see the Operating Instructions for the device →  11.

8.2 Access to the operating menu via the operating tool

 For detailed information about access to the operating menu via operating tool, refer to the Operating Instructions for the device →  11.

8.2.1 Via service interface (CDI)

This communication interface is present in the following device version:
Order code for "Output", option **M**: Modbus RS485

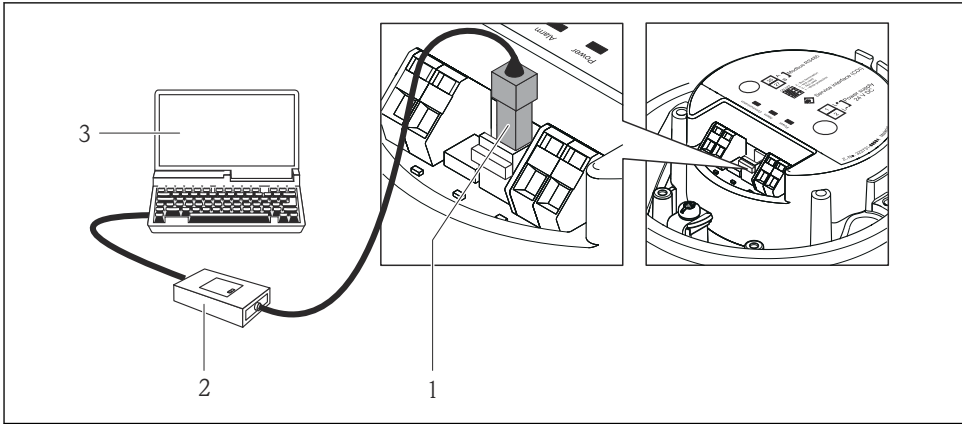

A0016925

- 1 Service interface (CDI) of the measuring device
- 2 Commubox FXA291
- 3 Computer with "FieldCare" operating tool with COM DTM "CDI Communication FXA291"

8.2.2 Establishing a connection

For device version with Modbus RS485 communication type

Via service interface (CDI) and "FieldCare" operating tool

1. Start FieldCare and launch the project.
2. In the network: Add a device.
 - ↳ The **Add device** window opens.
3. Select the **CDI Communication FXA291** option from the list and press **OK** to confirm.
4. Right-click **CDI Communication FXA291** and select the **Add device** option in the context menu that opens.
5. Select the desired device from the list and press **OK** to confirm.
6. Establish the online connection to the device.



For details, see Operating Instructions BA00027S and BA00059S

9 System integration



For information on system integration, see the Operating Instructions for the device → 11.

10 Commissioning

10.1 Function check

Before commissioning the device, make sure that the post-installation and post-connection checks have been performed.

- "Post-installation check" checklist → 17
- "Post-connection check" checklist → 26

10.2 Establishing a connection via FieldCare

- For FieldCare connection → 27
- For establishing a connection via FieldCare → 28

10.3 Configuring the measuring device

The **Setup** menu with its submenus is used for fast commissioning of the measuring device. The submenus contain all the parameters required for configuration, such as parameters for measurement or communication.

Submenu	Meaning
System units	Configuring the units for all measured values
Medium selection	Defining the medium
Communication	Configuration of the digital communication interface
Low flow cut off	Configuring the low flow cut off
Partial filled pipe detection	Configuring the monitoring of partial and empty pipe detection

10.4 Defining the tag name

To enable fast identification of the measuring point within the system, you can enter a unique designation using the **Device tag** parameter and thus change the factory setting.

10.5 Protecting settings from unauthorized access

10.5.1 Write protection via write protection switch

The write protection switch makes it possible to block write access to the entire operating menu with the exception of the following parameters:

- External pressure
- External temperature
- Reference density
- All parameters for configuring the totalizer

The parameter values are now read only and cannot be edited any more:

- Via service interface (CDI)
- Via Modbus RS485

For device version with Modbus RS485 communication types

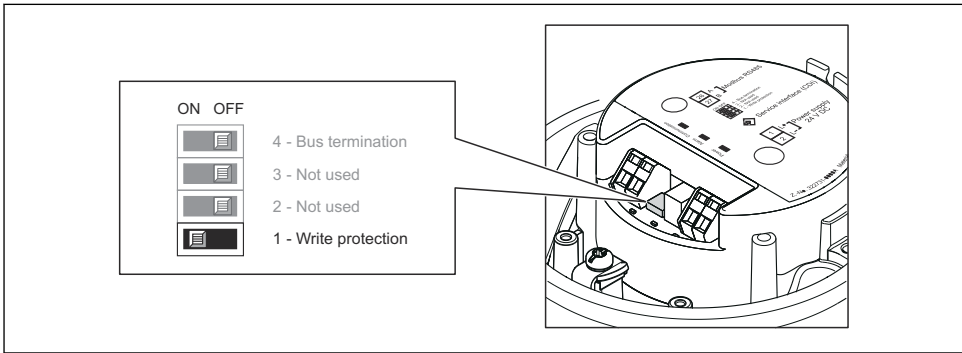

A0017954

- ▶ Setting the write protection switch on the electronics module to the ON position enables the hardware write protection.
 - ↳ If hardware write protection is enabled, the **Hardware locked** option is displayed in the **Locking status** parameter.

11 Diagnostic information

Any faults detected by the measuring device are displayed as a diagnostic message in the operating tool once the connection has been established and on the home page of the web browser once the user has logged on.

Remedial measures are provided for each diagnostic message to ensure that problems can be rectified quickly.

In FieldCare: Remedial measures are displayed on the home page in a separate field below the diagnostic message.

The screenshot displays the LNGmass diagnostic interface. At the top, a status bar (labeled 1) shows device information: Device name: XXXXXXX, Device tag: XXXXXXX, Status signal: (refresh icon), and Function check (C) (warning icon). On the right, flow rates are listed: Mass flow: 12.34 kg/h and Volume flow: 12.34 m³/h. Below this is a navigation tree (labeled 2) with folders for Diagnostics 1, Remedy information, Access status tooling, Operation, Setup, Diagnostics, and Expert. The Diagnostics 1 folder is expanded, showing C485 Simulation, Deactivate Simulation, and Maintenance. The main panel (labeled 3) is titled 'Instrument health status' and lists: Failure (F), Function check (C) (warning icon), Out of specification (S), and Maintenance required (M). Under Function check (C), there are two dropdown menus: 'Diagnostics 1:' with 'C485 Simulation measured vari...' and 'Remedy information:' with 'Deactivate Simulation (Service...'. Lines 1, 2, and 3 point to these respective areas.

A0021799-EN

- 1 Status area with status signal
- 2 Diagnostic information
- 3 Remedy information with Service ID

► Perform the remedial measure displayed.



71756708

www.addresses.endress.com
