

Technical Information

Proline Promass E 500

Coriolis flowmeter



Mid-range Coriolis flowmeter as remote version with up to 4 I/Os

Application

- Measuring principle operates independently of physical fluid properties such as viscosity or density
- Accurate measurement of liquids and gases for a wide range of standard applications

Device properties

- Compact dual-tube sensor
- Medium temperature up to +150 °C (+302 °F)
- Process pressure up to 100 bar (1450 psi)
- Remote version with up to 4 I/Os
- Backlit display with touch control and WLAN access
- Standard cable between sensor and transmitter

Your benefits

- Cost-effective – multipurpose device; an alternative to conventional volumetric flowmeters
- Fewer process measuring points – multivariable measurement (flow, density, temperature)
- Space-saving installation – no in-/outlet run needs
- Full access to process and diagnostic information – numerous, freely combinable I/Os and Ethernet
- Reduced complexity and variety – freely configurable I/O functionality
- Integrated verification – Heartbeat Technology

Table of contents





About this document	4	Special installation instructions	69
Symbols	4		
Function and system design	5	Environment	71
Measuring principle	5	Ambient temperature range	71
Measuring system	7	Storage temperature	71
Equipment architecture	8	Climate class	71
Reliability	9	Relative humidity	71
		Operating height	71
		Degree of protection	71
		Vibration resistance and shock resistance	72
		Mechanical load	72
		Electromagnetic compatibility (EMC)	72
Input	12	Process	72
Measured variable	12	Medium temperature range	72
Measuring range	12	Medium density	73
Operable flow range	13	Pressure/temperature ratings	73
Input signal	13	Sensor housing	77
		Rupture disk	78
		Internal cleaning	78
		Flow limit	78
		Pressure loss	78
		Static pressure	78
		Thermal insulation	78
		Heating	79
		Vibrations	79
Output	15	Mechanical construction	80
Output and input variants	15	Dimensions in SI units	80
Output signal	17	Dimensions in US units	95
Signal on alarm	24	Weight	105
Load	26	Materials	105
Ex connection data	27	Process connections	108
Low flow cut off	31	Surface roughness	108
Galvanic isolation	31		
Protocol-specific data	32	Operability	108
		Operation concept	108
		Languages	109
		Onsite operation	109
		Remote operation	109
		Service interface	116
		Network integration	118
		Supported operating tools	119
		HistoROM data management	120
Power supply	39	Certificates and approvals	122
Terminal assignment	39	CE mark	122
Available device plugs Proline 500	41	UKCA marking	122
Available device plugs Proline 500 digital	43	RCM marking	122
Pin assignment, device plug	44	Ex approval	122
Supply voltage	46	Hygienic compatibility	123
Power consumption	47	Pharmaceutical compatibility	123
Current consumption	47	Functional safety	123
Power supply failure	47	HART certification	123
Overcurrent protection element	47	FOUNDATION Fieldbus certification	124
Electrical connection	47	Certification PROFIBUS	124
Potential equalization	55	EtherNet/IP certification	124
Terminals	55	Certification PROFINET	124
Cable entries	56		
Cable specification	56		
Overvoltage protection	61		
Performance characteristics	61		
Reference operating conditions	61		
Maximum measurement error	61		
Repeatability	63		
Response time	63		
Influence of ambient temperature	63		
Influence of medium temperature	63		
Influence of medium pressure	64		
Design fundamentals	64		
Installation	65		
Mounting location	65		
Orientation	66		
Inlet and outlet runs	67		
Installing the transmitter housing	68		

PROFINET over Ethernet-APL certification	124
Pressure Equipment Directive	124
Radio approval	125
Additional certification	125
External standards and guidelines	125
Ordering information	126
Application packages	126
Diagnostic functionality	126
Heartbeat Technology	127
Concentration measurement	127
Petroleum	127
Petroleum & locking function	127
OPC-UA Server	128
Accessories	128
Device-specific accessories	128
Communication-specific accessories	129
Service-specific accessories	130
System components	131
Documentation	131
Standard documentation	131
Device-dependent additional documentation	132
Registered trademarks	133





About this document

Symbols









Electrical symbols

Symbol	Meaning
	Direct current
	Alternating current
	Direct current and alternating current
	Ground connection A grounded terminal which, as far as the operator is concerned, is grounded via a grounding system.
	Protective earth (PE) Ground terminals that must be connected to ground prior to establishing any other connections. The ground terminals are located on the interior and exterior of the device: <ul style="list-style-type: none"> ▪ Interior ground terminal: protective earth is connected to the mains supply. ▪ Exterior ground terminal: device is connected to the plant grounding system.



Communication-specific symbols

Symbol	Meaning
	Wireless Local Area Network (WLAN) Communication via a wireless, local area network
	LED LED is off.
	LED LED is on.
	LED LED flashing.

Symbols for certain types of information

Symbol	Meaning
	Permitted Procedures, processes or actions that are permitted.
	Preferred Procedures, processes or actions that are preferred.
	Forbidden Procedures, processes or actions that are forbidden.
	Tip Indicates additional information.
	Reference to documentation
	Reference to page
	Reference to graphic
	Visual inspection

Symbols in graphics

Symbol	Meaning
1, 2, 3, ...	Item numbers
1, 2, 3, ...	Series of steps
A, B, C, ...	Views
A-A, B-B, C-C, ...	Sections
	Hazardous area
	Safe area (non-hazardous area)
	Flow direction

Function and system design

Measuring principle

The measuring principle is based on the controlled generation of Coriolis forces. These forces are always present in a system when both translational and rotational movements are superimposed.

$$F_c = 2 \cdot \Delta m (v \cdot \omega)$$

F_c = Coriolis force

Δm = moving mass

ω = rotational velocity

v = radial velocity in rotating or oscillating system

The amplitude of the Coriolis force depends on the moving mass Δm , its velocity v in the system and thus on the mass flow. Instead of a constant rotational velocity ω , the sensor uses oscillation.

In the sensor, two parallel measuring tubes containing flowing medium oscillate in antiphase, acting like a vibrating fork. The Coriolis forces produced at the measuring tubes cause a phase shift in the tube oscillations (see illustration):

- At zero flow (when the medium is at a standstill) the two tubes oscillate in phase (1).
- Mass flow causes deceleration of the oscillation at the inlet of the tubes (2) and acceleration at the outlet (3).

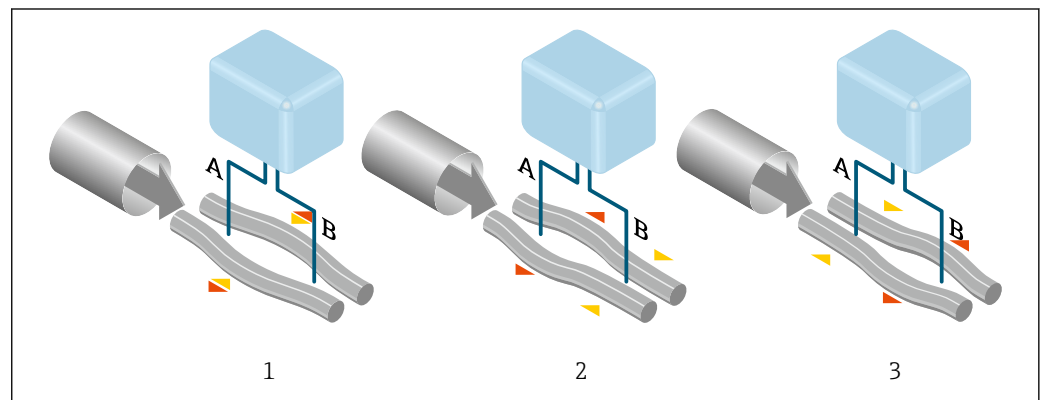

A0028850

The phase shift (A-B) increases with increasing mass flow. Electrodynamic sensors register the tube oscillations at the inlet and outlet. System balance is ensured by the antiphase oscillation of the two measuring tubes. The measuring principle operates independently of temperature, pressure, viscosity, conductivity and flow profile.

Density measurement

The measuring tube is continuously excited at its resonance frequency. A change in the mass and thus the density of the oscillating system (comprising measuring tube and medium) results in a corresponding, automatic adjustment in the oscillation frequency. The resonance frequency is thus a function of the medium density. The microprocessor utilizes this relationship to obtain a density signal.

Volume measurement

Together with the measured mass flow, this is used to calculate the volume flow.

Temperature measurement

The temperature of the measuring tube is determined in order to calculate the compensation factor due to temperature effects. This signal corresponds to the process temperature and is also available as an output signal.

Gas Fraction Handler (GFH)

The Gas Fraction Handler is a Promass software function that improves measurement stability and repeatability. The function continuously checks for the presence of disturbances in single-phase flow, i.e. gas bubbles in liquids. In the presence of the second phase, flow and density become increasingly unstable. The Gas Fraction Handler function improves measurement stability with respect to the severity of the disturbances, without any effect under single-phase flow conditions.



The Gas Fraction Handler is only available for device versions with HART, Modbus RS485, PROFINET, PROFINET over Ethernet-APL and Modbus TCP over Ethernet-APL.



For more detailed information on the Gas Fraction Handler, see the "Gas Fraction Handler" Special Documentation →  133

Measuring system

The measuring system consists of a transmitter and a sensor. The transmitter and sensor are mounted in physically separate locations. They are interconnected by connecting cables.

Transmitter

Two versions of the transmitter are available.

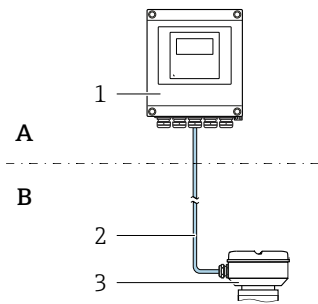
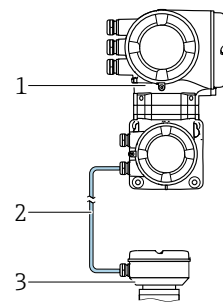
Proline 500 – digital	Proline 500
<p>For use in applications not required to meet special requirements due to ambient or operating conditions.</p>  <p>A B</p> <p>1 Transmitter 2 Connecting cable: cable, separate, standard 3 Sensor connection housing with integrated ISEM</p> <ul style="list-style-type: none"> ▪ Flexible and cost-effective separate installation. ▪ A standard cable can be used as the connecting cable. ▪ Electronics in the transmitter housing, ISEM (intelligent sensor electronics module) in the sensor connection housing ▪ Signal transmission: digital Order code for "Integrated ISEM electronics", option A "Sensor" 	<p>For use in applications required to meet special requirements due to ambient or operating conditions.</p>  <p>1 Transmitter with integrated ISEM 2 Connecting cable: cable, separate 3 Sensor connection housing</p> <p>Non-hazardous area or Zone 2; Class I, Division 2 or Zone 1; Class I, Division 1</p> <p>Application examples for sensors without electronics: In the case of strong vibrations on the sensor.</p> <ul style="list-style-type: none"> ▪ Electronics and ISEM (intelligent sensor electronics module) in the transmitter housing ▪ Signal transmission: analog Order code for "Integrated ISEM electronics", option B "Transmitter"
<p>Connecting cable (can be ordered in various lengths → 128)</p>	
<ul style="list-style-type: none"> ▪ Length: <ul style="list-style-type: none"> ▪ Zone 2; Class I, Division 2: max. 300 m (1 000 ft) ▪ Zone 1; Class I, Division 1: max. 150 m (500 ft) ▪ Standard cable with common shield (pair-stranded) 	<ul style="list-style-type: none"> ▪ Length: max. 20 m (65 ft) ▪ Cable with a common shield and individual shielded cores (3 pairs)
<p>Hazardous area</p>	
<p>Use in: Zone 2; Class I, Division 2</p> <p>Mixed installation is possible:</p> <ul style="list-style-type: none"> ▪ Sensor: Zone 1; Class I, Division 1 ▪ Transmitter: Zone 2; Class I, Division 2 	<p>Use in: Zone 1; Class I, Division 1 or Zone 2; Class I, Division 2</p>
<p>Housing versions and materials</p>	
<ul style="list-style-type: none"> ▪ Transmitter housing <ul style="list-style-type: none"> ▪ Aluminum, coated: aluminum, AlSi10Mg, coated ▪ Material: polycarbonate ▪ Material of window in transmitter housing <ul style="list-style-type: none"> ▪ Aluminum, coated: glass ▪ Polycarbonate: plastic 	<ul style="list-style-type: none"> ▪ Transmitter housing <ul style="list-style-type: none"> Aluminum, coated: aluminum, AlSi10Mg, coated ▪ Window material: glass
<p>Configuration</p>	
<ul style="list-style-type: none"> ▪ External operation via 4-line, illuminated graphic local display (LCD) with touch control and guided menus ("Make-it-run" wizards) for application-specific commissioning. ▪ Via service interface or WLAN interface: <ul style="list-style-type: none"> ▪ Operating tools (e.g. FieldCare, DeviceCare) ▪ Web server (access via web browser) 	

Sensor connection housing

Different versions of the connection housing are available.

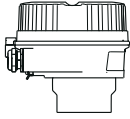
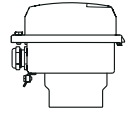
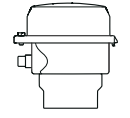
	<p>Order code for "Sensor connection housing", option A, "Aluminum, coated": Aluminum, AISi10Mg, coated</p> <p>i This device version is only available in conjunction with the Proline 500 – digital transmitter.</p>
	<p>Order code for "Sensor connection housing", option B, "Stainless":</p> <ul style="list-style-type: none"> ▪ Hygienic version, stainless steel 1.4301 (304) ▪ Optional: order code for "Sensor feature", option CC "Hygienic version, for maximum corrosion resistance": stainless steel 1.4404 (316L)
	<p>Order code for "Sensor connection housing", option C, "Ultra-compact hygienic, stainless":</p> <ul style="list-style-type: none"> ▪ Hygienic version, stainless steel 1.4301 (304) ▪ Optional: order code for "Sensor feature", option CC "Hygienic version, for maximum corrosion resistance": stainless steel 1.4404 (316L) <p>i This device version is only available in conjunction with the Proline 500 – digital transmitter.</p>

Sensor

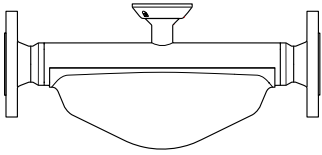
<p>Promass E</p>  <p>A0026712</p>	<ul style="list-style-type: none"> ▪ Bent dual-tube system ▪ For standard applications where stable and reliable measurements are required ▪ Simultaneous measurement of flow, volume flow, density and temperature (multivariable) ▪ Immune to process influences ▪ Nominal diameter range: DN 8 to 80 (3/8 to 3") ▪ Materials: <ul style="list-style-type: none"> ▪ Sensor: stainless steel, 1.4301 (304) ▪ Measuring tubes: stainless steel, 1.4539 (904L) ▪ Process connections: stainless steel, 1.4404 (316/316L)
--	---

Equipment architecture

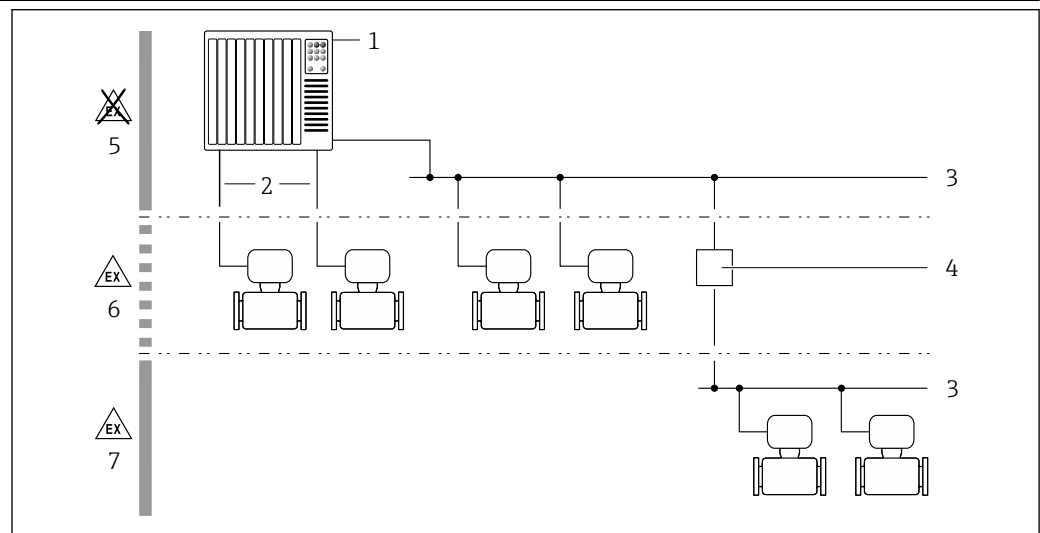

1 Possibilities for integrating measuring instruments into a system

- 1 Automation system (e.g. PLC)
- 2 Connection cable (0/4 to 20 mA HART etc.)
- 3 Fieldbus
- 4 Coupler
- 5 Non-hazardous area
- 6 Hazardous area: Zone 2; Class I, Division 2
- 7 Hazardous area: Zone 1; Class I, Division 1

Reliability**IT security**

The manufacturer warranty is valid only if the product is installed and used as described in the Operating Instructions. The product is equipped with security mechanisms to protect it against any inadvertent changes to the settings.

IT security measures, which provide additional protection for the product and associated data transfer, must be implemented by the operators themselves in line with their security standards.

Device-specific IT security

The device offers a range of specific functions to support protective measures on the operator's side. These functions can be configured by the user and guarantee greater in-operation safety if used correctly. The following list provides an overview of the most important functions:

Function/interface	Factory setting	Recommendation
Write protection via hardware write protection switch → 9	Not enabled	On an individual basis following risk assessment
Access code (also applies to web server login or FieldCare connection) → 9	Not enabled (0000)	Assign a customized access code during commissioning
WLAN (order option in display module)	Enabled	On an individual basis following risk assessment
WLAN security mode	Enabled (WPA2-PSK)	Do not change
WLAN passphrase (Password) → 10	Serial number	Assign an individual WLAN passphrase during commissioning
WLAN mode	Access point	On an individual basis following risk assessment
Web server → 10	Enabled	On an individual basis following risk assessment
Service interface CDI-RJ45 → 10	Enabled	-

Protecting access via hardware write protection

Write access to the parameters of the device via the local display, web browser or operating tool (e.g. FieldCare, DeviceCare) can be disabled via a write protection switch (DIP switch on the main electronics module). When hardware write protection is enabled, only read access to the parameters is possible.

Hardware write protection is disabled when the device is delivered.

Protecting access via a password

Different passwords are available to protect write access to the device parameters or access to the device via the WLAN interface.

- **User-specific access code**
Protect write access to the device parameters via the local display, web browser or operating tool (e.g. FieldCare, DeviceCare). Access authorization is clearly regulated through the use of a user-specific access code.
- **WLAN passphrase**
The network key protects a connection between an operating unit (e.g. notebook or tablet) and the device via the WLAN interface which can be ordered as an option.
- **Infrastructure mode**
When the device is operated in infrastructure mode, the WLAN passphrase corresponds to the WLAN passphrase configured on the operator side.

User-specific access code

Local display, web browser and operating tool (e.g. FieldCare, DeviceCare)

- Write access to the device parameters via the local display, web browser or operating tool (e.g. FieldCare, DeviceCare) can be protected by the modifiable, user-specific access code.
- When delivered, the device does not have an access code; the default value is 0000 (open).

WLAN passphrase: Operation as WLAN access point

A connection between an operating unit (e.g. notebook or tablet) and the device via the WLAN interface, which can be ordered as an optional extra, is protected by the network key. The WLAN authentication of the network key complies with the IEEE 802.11 standard.

When the device is delivered, the network key is pre-defined depending on the device. It can be changed via the **WLAN settings** submenu in the **WLAN passphrase** parameter.

Infrastructure mode

A connection between the device and WLAN access point is protected by means of an SSID and passphrase on the system side. Please contact the relevant system administrator for access.

General notes on the use of passwords

- The access code and network key supplied with the device should be changed during commissioning for security reasons.
- Follow the general rules for generating a secure password when defining and managing the access code or network key.
- The user is responsible for the management and careful handling of the access code and network key.

Access via web server

The integrated web server can be used to operate and configure the device via a web browser. The connection is established via the service interface (CDI-RJ45) or WLAN interface. For device versions with the Ethernet/IP and PROFINET communication protocols, the connection can also be established via the terminal connection for signal transmission with Ethernet/IP, PROFINET (RJ45 plug), PROFINET over Ethernet-APL (two-wire) or Modbus TCP over Ethernet-APL.

The web server is enabled when the device is delivered. The web server can be disabled if necessary via the **Web server functionality** parameter (e.g., after commissioning).

The device and status information can be hidden on the login page. This prevents unauthorized access to the information.



For detailed information on device parameters, see: Description of Device Parameters.

Access via OPC UA

The "OPC UA Server" application package is available in the device version with the HART communication protocol → 128.

The device can communicate with OPC UA clients using the "OPC UA Server" application package.

The OPC UA server integrated in the device can be accessed via the WLAN access point using the WLAN interface - which can be ordered as an optional extra - or the service interface (CDI-RJ45) via Ethernet network. Access rights and authorization as per separate configuration.

The following Security Modes are supported as per the OPC UA Specification (IEC 62541):

- Without
- Basic128Rsa15 – signed
- Basic128Rsa15 – signed and encrypted

Access via service interface (port 2): CDI-RJ45

The device can be connected to a network via the service interface. Device-specific functions guarantee the secure operation of the device in a network.

The use of relevant industrial standards and guidelines that have been defined by national and international safety committees, such as IEC/ISA62443 or the IEEE, is recommended. This includes organizational security measures such as the assignment of access authorization as well as technical measures such as network segmentation.



PROFINET, Ethernet/IP:

The device can be integrated into a ring topology. The device is integrated via the terminal connection for signal transmission, output 1 (port 1) and the terminal connection to the service interface (port 2) → 116.



For detailed information on connecting transmitters with an Ex de approval, see separate document "Safety instructions" (XA) for the device.

Advanced safety requirements

If the specified requirements for measures cannot be met, alternative measures may need to be put in place. This may involve, for example, mechanical protection of the product against tampering, the cabling, or organizational measures. The Proline measuring instruments can be used in the open field for example. Measures to combat physical tampering of the Proline measuring instruments must be arranged by the customer.

Additional analysis is required if Proline measuring instruments are integrated into a different system. Please note the following:

- The fieldbus network (OT) and company network (IT) must be strictly separated.
- Endress+Hauser recommends the segmentation of the fieldbus networks according to DIN IEC 62443-3-3.

Network

Pay particular attention to the network components used, the router and switches for example. The operator must guarantee the integrity of the components. Access to the network must be restricted by the operator, if necessary.

FDI Packages

Signed FDI Packages can be obtained via www.endress.com for the configuration of the field device.

User training

Depending on the application scenario, users who are not specialized in this area may come in contact with the instrument. We recommend that these users be trained in the safe use of the relevant terminals, components and/or interfaces and be made aware of security issues.

Input

Measured variable

Direct measured variables

- Mass flow
- Density
- Temperature

Calculated measured variables

- Volume flow
- Corrected volume flow
- Reference density

Measuring range

Measuring range for liquids

DN		Measuring range full scale values $\dot{m}_{\min(F)}$ to $\dot{m}_{\max(F)}$	
[mm]	[in]	[kg/h]	[lb/min]
8	$\frac{3}{8}$	0 to 2 000	0 to 73.50
15	$\frac{1}{2}$	0 to 6 500	0 to 238.9
25	1	0 to 18 000	0 to 661.5
40	$1\frac{1}{2}$	0 to 45 000	0 to 1 654
50	2	0 to 70 000	0 to 2 573
80	3	0 to 180 000	0 to 6 615

Measuring range for gases



The full scale value depends on the density and the speed of sound of the gas used. The full scale value can be calculated with the following formulas:

$$\dot{m}_{\max(G)} = \text{minimum of } (\dot{m}_{\max(F)} \cdot \rho_G \cdot x) \text{ and } (\rho_G \cdot (c_G/2) \cdot d_i^2 \cdot (\pi/4) \cdot 3600 \cdot n)$$

$\dot{m}_{\max(G)}$	Maximum full scale value for gas [kg/h]
$\dot{m}_{\max(F)}$	Maximum full scale value for liquid [kg/h]
$\dot{m}_{\max(G)} < \dot{m}_{\max(F)}$	$\dot{m}_{\max(G)}$ can never be greater than $\dot{m}_{\max(F)}$
ρ_G	Gas density in [kg/m ³] at operating conditions
x	Limitation constant for max. gas flow [kg/m ³]
c_G	Speed of sound (gas) [m/s]
d_i	Measuring tube internal diameter [m]
π	Pi
$n = 2$	Number of measuring tubes

DN		x
[mm]	[in]	[kg/m ³]
8	$\frac{3}{8}$	85
15	$\frac{1}{2}$	110
25	1	125
40	$1\frac{1}{2}$	125



DN		x
[mm]	[in]	[kg/m ³]
50	2	125
80	3	155

 To calculate the measuring range, use the *Applicator* sizing tool →  130

If calculating the full scale value using the two formulas:

1. Calculate the full scale value with both formulas.
2. The smaller value is the value that must be used.

Recommended measuring range

 Flow limit →  78

Operable flow range

Over 1000 : 1.

Flow rates above the preset full scale value do not override the electronics unit, with the result that the totalizer values are registered correctly.

Input signal

Output and input variants

→  15

External measured values

To increase the measurement accuracy of certain measured variables or to calculate the corrected volume flow for gases, the automation system can continuously write different measured values to the measuring instrument:

- Operating pressure to increase measurement accuracy (Endress+Hauser recommends the use of a pressure measuring instrument for absolute pressure, e.g. Cerabar M or Cerabar S)
- Medium temperature to increase measurement accuracy (e.g. iTEMP)
- Reference density for calculating the corrected volume flow for gases

 Various pressure and temperature measuring devices can be ordered from Endress+Hauser: see "Accessories" section →  131

It is recommended to read in external measured values to calculate the corrected volume flow.

HART protocol

The measured values are written from the automation system to the measuring device via the HART protocol. The pressure transmitter must support the following protocol-specific functions:

- HART protocol
- Burst mode

Current input

The measured values are written from the automation system to the measuring device via the current input →  14.

Digital communication

The measured values can be written by the automation system via:

- FOUNDATION Fieldbus
- PROFIBUS DP
- PROFIBUS PA
- Modbus RS485
- Modbus TCP over Ethernet-APL
- EtherNet/IP
- PROFINET
- PROFINET over Ethernet-APL

Current input 0/4 to 20 mA

Current input	0/4 to 20 mA (active/passive)
Current span	<ul style="list-style-type: none"> ▪ 4 to 20 mA (active) ▪ 0/4 to 20 mA (passive)
Resolution	1 μ A
Voltage drop	Typically: 0.6 to 2 V for 3.6 to 22 mA (passive)
Maximum input voltage	≤ 30 V (passive)
Open-circuit voltage	≤ 28.8 V (active)
Possible input variables	<ul style="list-style-type: none"> ▪ Pressure ▪ Temperature ▪ Density

Status input

Maximum input values	<ul style="list-style-type: none"> ▪ DC -3 to 30 V ▪ If status input is active (ON): $R_i > 3$ kΩ
Response time	Configurable: 5 to 200 ms
Input signal level	<ul style="list-style-type: none"> ▪ Low signal: DC -3 to +5 V ▪ High signal: DC 12 to 30 V
Assignable functions	<ul style="list-style-type: none"> ▪ Off ▪ Reset the individual totalizers separately ▪ Reset all totalizers ▪ Flow override



Output

Output and input variants

Depending on the option selected for output/input 1, different options are available for the other outputs and inputs. Only one option can be selected for each output/input 1 to 4. The following tables must be read vertically (↓).

Example: If the option BA "4–20 mA HART" was selected for output/input 1, one of the options A, B, D, E, F, H, I or J is available for output 2 and one of the options A, B, D, E, F, H, I or J is available for output 3 and 4.

Output/input 1 and options for output/input 2

 Options for output/input 3 and 4 →  16

Order code for "Output; input 1" (020) →	Possible options														
Current output 4 to 20 mA HART	BA														
Current output 4 to 20 mA HART Ex i passive	↓ CA														
Current output 4 to 20 mA HART Ex i active		↓ CC													
FOUNDATION fieldbus			↓ SA												
FOUNDATION fieldbus Ex i				↓ TA											
PROFIBUS DP					↓ LA										
PROFIBUS PA						↓ GA									
PROFIBUS PA Ex i							↓ HA								
Modbus RS485								↓ MA							
Ethernet/IP 2-port switch integrated									↓ NA						
PROFINET 2-port switch integrated										↓ RA					
PROFINET over Ethernet-APL											↓ RB				
PROFINET over Ethernet-APL Ex i												↓ RC			
Modbus TCP over Ethernet-APL 10 Mbit/s, SPE 10 Mbit/s, Ethernet 100 Mbit/s													↓ MB		
Modbus TCP over Ethernet-APL, Ex i, 10 Mbit/s, Ethernet 100 Mbit/s														↓ MC	
Order code for "Output; input 2" (021) →	↓	↓	↓	↓	↓	↓	↓	↓	↓	↓	↓	↓	↓	↓	↓
Not used	A	A	A	A	A	A	A	A	A	A	A	A	A	A	A
Current output 4 to 20 mA	B			B		B	B		B	B	B	B		B	
Current output 4 to 20 mA Ex i passive		C	C		C			C					C		C
User-configurable input/output ¹⁾	D			D		D	D		D	D	D	D		D	
Pulse/frequency/switch output	E			E		E	E		E	E	E	E		E	
Double pulse output ²⁾	F								F						
Pulse/frequency/switch output Ex i passive		G	G		G			G					G		G
Relay output	H			H		H	H		H	H	H	H		H	
Current input 0/4 to 20 mA	I			I		I	I		I	I	I	I		I	
Status input	J			J		J	J		J	J	J	J		J	

- 1) A specific input or output can be assigned to a user-configurable input/output →  24.
- 2) If double pulse output (F) is selected for output/input 2 (021), only the double pulse output (F) option is available for selection for output/input 3 (022).

Output/input 1 and options for output/input 3 and 4

 Options for output/input 2 →  15

Order code for "Output; input 1" (020) →	Possible options														
Current output 4 to 20 mA HART	BA														
Current output 4 to 20 mA HART Ex i passive	↓	CA													
Current output 4 to 20 mA HART Ex i active		↓	CC												
FOUNDATION fieldbus			↓	SA											
FOUNDATION fieldbus Ex i				↓	TA										
PROFIBUS DP					↓	LA									
PROFIBUS PA						↓	GA								
PROFIBUS PA Ex i							↓	HA							
Modbus RS485								↓	MA						
Ethernet/IP 2-port switch integrated									↓	NA					
PROFINET 2-port switch integrated										↓	RA				
PROFINET over Ethernet-APL 10 Mbit/s, 2-wire											↓	RB			
PROFINET over Ethernet-APL Ex i, 10 Mbit/s, 2-wire												↓	RC		
Modbus TCP over Ethernet-APL 10 Mbit/s, SPE 10 Mbit/s, Ethernet 100 Mbit/s													↓	MB	
Modbus TCP over Ethernet-APL, Ex i, 10 Mbit/s, Ethernet 100 Mbit/s														↓	MC
Order code for "Output; input 3" (022), "Output; input 4" (023) ¹⁾ →	↓	↓	↓	↓	↓	↓	↓	↓	↓	↓	↓	↓	↓	↓	↓
Not used	A	A	A	A	A	A	A	A	A	A	A	A	A	A	A
Current output 4 to 20 mA	B					B			B	B	B	B		B	
Current output 4 to 20 mA Ex i passive ²⁾		C	C												
User-configurable input/output	D					D			D	D	D	D		D	
Pulse/frequency/switch output	E					E			E	E	E	E		E	
Double pulse output (slave) ³⁾	F								F						
Pulse/frequency/switch output Ex i passive ⁴⁾		G	G												
Relay output	H					H			H	H	H	H		H	
Current input 0/4 to 20 mA	I					I			I	I	I	I		I	
Status input	J					J			J	J	J	J		J	

- 1) The order code for "Output; input 4" (023) is only available for the Proline 500-digital transmitter, order code for "Integrated ISEM electronics", option A.
- 2) The current output 4 to 20 mA Ex i passive (C) option is not available for input/output 4.
- 3) The double pulse output (F) option is not available for input/output 4.
- 4) The pulse/frequency/switch output Ex i passive (G) option is not available for input/output 4.

Output signal

Current output 4 to 20 mA HART

Order code	"Output; input 1" (20): Option BA: current output 4 to 20 mA HART
Signal mode	Can be set to: <ul style="list-style-type: none"> ■ Active ■ Passive
Current range	Can be set to: <ul style="list-style-type: none"> ■ 4 to 20 mA NAMUR ■ 4 to 20 mA US ■ 4 to 20 mA ■ 0 to 20 mA (only if the signal mode is active) ■ Fixed current
Open-circuit voltage	DC 28.8 V (active)
Maximum input voltage	DC 30 V (passive)
Load	250 to 700 Ω
Resolution	0.38 μ A
Damping	Configurable: 0 to 999.9 s
Assignable measured variables	<ul style="list-style-type: none"> ■ Mass flow ■ Volume flow ■ Corrected volume flow ■ Density ■ Reference density ■ Temperature ■ Electronics temperature ■ Oscillation frequency 0 ■ Oscillation damping 0 ■ Signal asymmetry ■ Exciter current 0 <p> The range of options increases if the measuring device has one or more application packages.</p>

Current output 4 to 20 mA HART Ex i

Order code	"Output; input 1" (20) choose from: <ul style="list-style-type: none"> ■ Option CA: current output 4 to 20 mA HART Ex i passive ■ Option CC: current output 4 to 20 mA HART Ex i active
Signal mode	Depends on the selected order version.
Current range	Can be set to: <ul style="list-style-type: none"> ■ 4 to 20 mA NAMUR ■ 4 to 20 mA US ■ 4 to 20 mA ■ 0 to 20 mA (only if the signal mode is active) ■ Fixed current
Open-circuit voltage	DC 21.8 V (active)
Maximum input voltage	DC 30 V (passive)
Load	<ul style="list-style-type: none"> ■ 250 to 400 Ω (active) ■ 250 to 700 Ω (passive)
Resolution	0.38 μ A

Damping	Configurable: 0 to 999.9 s
Assignable measured variables	<ul style="list-style-type: none"> ▪ Mass flow ▪ Volume flow ▪ Corrected volume flow ▪ Density ▪ Reference density ▪ Temperature ▪ Electronics temperature ▪ Oscillation frequency 0 ▪ Oscillation damping 0 ▪ Signal asymmetry ▪ Exciter current 0 <p> The range of options increases if the measuring device has one or more application packages.</p>

FOUNDATION Fieldbus

FOUNDATION Fieldbus	H1, IEC 61158-2, galvanically isolated
Data transfer	31.25 kbit/s
Current consumption	10 mA
Permitted supply voltage	9 to 32 V
Bus connection	With integrated reverse polarity protection

PROFIBUS DP

Signal encoding	NRZ code
Data transfer	9.6 kBaud...12 MBaud
Terminating resistor	Integrated, can be activated via DIP switches

PROFIBUS PA

PROFIBUS PA	In accordance with EN 50170 Volume 2, IEC 61158-2 (MBP), galvanically isolated
Data transmission	31.25 kbit/s
Current consumption	10 mA
Permitted supply voltage	9 to 32 V
Bus connection	With integrated reverse polarity protection

Modbus RS485

Physical interface	RS485 in accordance with EIA/TIA-485 standard
Terminating resistor	Integrated, can be activated via DIP switches

Modbus TCP over Ethernet-APL

Port 1: Modbus TCP over Ethernet-APL 10 Mbit/s	
Device usage	<p>Device connection to an APL field switch (terminal 26/27) The device may only be operated according to the following APL port classifications:</p> <ul style="list-style-type: none"> ▪ If used in hazardous areas: SLAA or SLAC ¹⁾ ▪ If used in non-hazardous areas: SLAX <p>Connection values of APL field switch (corresponds to APL port classification SPCC or SPAA, for instance):</p> <ul style="list-style-type: none"> ▪ Maximum input voltage: 15 V_{DC} ▪ Minimum output values: 0.54 W <p>Device connection to an SPE switch</p> <ul style="list-style-type: none"> ▪ In non-hazardous areas, the device can be used with an appropriate SPE switch: <ul style="list-style-type: none"> ▪ Maximum output voltage: 30 V_{DC} ▪ Minimum output power: 1.85 W ▪ The SPE switch must support the 10BASE-T1L standard and PoDL power classes 10, 11 or 12 and have a function to disable power class detection.
Standards	According to IEEE 802.3cg, APL port profile specification v1.0, galvanically isolated
Data transfer	Full-duplex (APL/SPE)
Current consumption	Terminal 26/27 max. approx. 45 mA
Permitted supply voltage	9 to 30 V
Bus connection	Terminal 26/27 with integrated reverse polarity protection

1) For more information on using the device in the hazardous area, see the Ex-specific Safety Instructions

Port 2: Modbus TCP over Ethernet 100 Mbit/s	
Device usage	<p>Device connection to a Fast Ethernet (RJ45) switch In non-hazardous areas, the Ethernet switch must support the standard 100BASE-TX.</p>
Standards	In accordance with IEEE 802.3u
Data transfer	Half-duplex, full-duplex
Current consumption	-
Permitted supply voltage	-
Bus connection	Service interface (RJ45)

EtherNet/IP

Standards	In accordance with IEEE 802.3
------------------	-------------------------------

PROFINET

Standards	In accordance with IEEE 802.3
------------------	-------------------------------

PROFINET over Ethernet-APL

Device use	<p>Device connection to an APL field switch The device may only be operated according to the following APL port classifications:</p> <ul style="list-style-type: none"> ▪ If used in hazardous areas: SLAA or SLAC ¹⁾ ▪ If used in non-hazardous areas: SLAX <p>Connection values of APL field switch (corresponds to APL port classification SPCC or SPAA, for instance):</p> <ul style="list-style-type: none"> ▪ Maximum input voltage: 15 V_{DC} ▪ Minimum output values: 0.54 W <p>Device connection to an SPE switch</p> <ul style="list-style-type: none"> ▪ In non-hazardous areas, the device can be used with an appropriate SPE switch: The device can be connected to an SPE switch with a maximum voltage of 30 V_{DC} and a minimum output power of 1.85 W connected. ▪ The SPE switch must support the 10BASE-T1L standard and PoDL power classes 10, 11 or 12 and have a function to disable power class detection.
PROFINET	According to IEC 61158 and IEC 61784
Ethernet-APL	According to IEEE 802.3cg, APL port profile specification v1.0, galvanically isolated
Data transfer	10 Mbit/s
Current consumption	<p>Transmitter</p> <ul style="list-style-type: none"> ▪ Max. 400 mA (24 V) ▪ Max. 200 mA (110 V, 50/60 Hz; 230 V, 50/60 Hz)
Permitted supply voltage	9 to 30 V
Network connection	With integrated reverse polarity protection

1) For more information on using the device in the hazardous area, see the Ex-specific Safety Instructions

Current output 4 to 20 mA

Order code	"Output; input 2" (21), "Output; input 3" (022) or "Output; input 4" (023): Option B: current output 4 to 20 mA
Signal mode	Can be set to: <ul style="list-style-type: none"> ▪ Active ▪ Passive
Current range	Can be set to: <ul style="list-style-type: none"> ▪ 4 to 20 mA NAMUR ▪ 4 to 20 mA US ▪ 4 to 20 mA ▪ 0 to 20 mA (only if the signal mode is active) ▪ Fixed current
Maximum output values	22.5 mA
Open-circuit voltage	DC 28.8 V (active)
Maximum input voltage	DC 30 V (passive)
Load	0 to 700 Ω
Resolution	0.38 μA



Damping	Configurable: 0 to 999.9 s
Assignable measured variables	<ul style="list-style-type: none"> ▪ Mass flow ▪ Volume flow ▪ Corrected volume flow ▪ Density ▪ Reference density ▪ Temperature ▪ Electronics temperature ▪ Oscillation frequency 0 ▪ Oscillation damping 0 ▪ Signal asymmetry ▪ Exciter current 0 <p> The range of options increases if the measuring device has one or more application packages.</p>

Current output 4 to 20 mA Ex i passive

Order code	"Output; input 2" (21), "Output; input 3" (022): Option C: current output 4 to 20 mA Ex i passive
Signal mode	Passive
Current range	Can be set to: <ul style="list-style-type: none"> ▪ 4 to 20 mA NAMUR ▪ 4 to 20 mA US ▪ 4 to 20 mA ▪ Fixed current
Maximum output values	22.5 mA
Maximum input voltage	DC 30 V
Load	0 to 700 Ω
Resolution	0.38 μA
Damping	Configurable: 0 to 999 s
Assignable measured variables	<ul style="list-style-type: none"> ▪ Mass flow ▪ Volume flow ▪ Corrected volume flow ▪ Density ▪ Reference density ▪ Temperature ▪ Electronics temperature ▪ Oscillation frequency 0 ▪ Oscillation damping 0 ▪ Signal asymmetry ▪ Exciter current 0 <p> The range of options increases if the measuring device has one or more application packages.</p>

Pulse/frequency/switch output

Function	Can be configured as pulse, frequency or switch output
Version	Open collector Can be set to: <ul style="list-style-type: none"> ▪ Active ▪ Passive ▪ Passive NAMUR <p> Ex-i, passive</p>
Maximum input values	DC 30 V, 250 mA (passive)
Open-circuit voltage	DC 28.8 V (active)
Voltage drop	For 22.5 mA: ≤ DC 2 V

Pulse output	
Maximum input values	DC 30 V, 250 mA (passive)
Maximum output current	22.5 mA (active)
Open-circuit voltage	DC 28.8 V (active)
Pulse width	Configurable: 0.05 to 2 000 ms
Maximum pulse rate	10 000 Impulse/s
Pulse value	Configurable
Assignable measured variables	<ul style="list-style-type: none"> ▪ Mass flow ▪ Volume flow ▪ Corrected volume flow  The range of options increases if the measuring device has one or more application packages.
Frequency output	
Maximum input values	DC 30 V, 250 mA (passive)
Maximum output current	22.5 mA (active)
Open-circuit voltage	DC 28.8 V (active)
Output frequency	Configurable: end value frequency 2 to 10 000 Hz ($f_{max} = 12\,500$ Hz)
Damping	Configurable: 0 to 999.9 s
Pulse/pause ratio	1:1
Assignable measured variables	<ul style="list-style-type: none"> ▪ Mass flow ▪ Volume flow ▪ Corrected volume flow ▪ Density ▪ Reference density ▪ Temperature ▪ Electronics temperature ▪ Oscillation frequency 0 ▪ Oscillation damping 0 ▪ Signal asymmetry ▪ Exciter current 0  The range of options increases if the measuring device has one or more application packages.
Switch output	
Maximum input values	DC 30 V, 250 mA (passive)
Open-circuit voltage	DC 28.8 V (active)
Switching behavior	Binary, conductive or non-conductive
Switching delay	Configurable: 0 to 100 s

Number of switching cycles	Unlimited
Assignable functions	<ul style="list-style-type: none"> ▪ Disable ▪ On ▪ Diagnostic behavior ▪ Limit <ul style="list-style-type: none"> ▪ Mass flow ▪ Volume flow ▪ Corrected volume flow ▪ Density ▪ Reference density ▪ Temperature ▪ Totalizer 1-3 ▪ Flow direction monitoring ▪ Status <ul style="list-style-type: none"> ▪ Partially filled pipe detection ▪ Low flow cut off <p> The range of options increases if the measuring device has one or more application packages.</p>

Double pulse output

Function	Double pulse
Version	Open collector Can be set to: <ul style="list-style-type: none"> ▪ Active ▪ Passive ▪ Passive NAMUR
Maximum input values	DC 30 V, 250 mA (passive)
Open-circuit voltage	DC 28.8 V (active)
Voltage drop	For 22.5 mA: ≤ DC 2 V
Output frequency	Configurable: 0 to 1000 Hz
Damping	Configurable: 0 to 999 s
Pulse/pause ratio	1:1
Assignable measured variables	<ul style="list-style-type: none"> ▪ Mass flow ▪ Volume flow ▪ Corrected volume flow ▪ Density ▪ Reference density ▪ Temperature <p> The range of options increases if the measuring device has one or more application packages.</p>

Relay output

Function	Switch output
Version	Relay output, galvanically isolated
Switching behavior	Can be set to: <ul style="list-style-type: none"> ▪ NO (normally open), factory setting ▪ NC (normally closed)

Maximum switching capacity (passive)	<ul style="list-style-type: none"> ▪ DC 30 V, 0.1 A ▪ AC 30 V, 0.5 A
Assignable functions	<ul style="list-style-type: none"> ▪ Disable ▪ On ▪ Diagnostic behavior ▪ Limit <ul style="list-style-type: none"> ▪ Mass flow ▪ Volume flow ▪ Corrected volume flow ▪ Density ▪ Reference density ▪ Temperature ▪ Totalizer 1-3 ▪ Flow direction monitoring ▪ Status <ul style="list-style-type: none"> ▪ Partially filled pipe detection ▪ Low flow cut off <p> The range of options increases if the measuring device has one or more application packages.</p>

User-configurable input/output

One specific input or output is assigned to a user-configurable input/output (configurable I/O) during device commissioning.

The following inputs and outputs are available for assignment:

- Choice of current output: 4 to 20 mA (active), 0/4 to 20 mA (passive)
- Pulse/frequency/switch output
- Choice of current input: 4 to 20 mA (active), 0/4 to 20 mA (passive)
- Status input

The technical values correspond to those of the inputs and outputs described in this section.

Signal on alarm

Depending on the interface, failure information is displayed as follows:

HART current output

Device diagnostics	Device condition can be read out via HART Command 48
---------------------------	--

PROFIBUS PA

Status and alarm messages	Diagnostics in accordance with PROFIBUS PA Profile 3.02
Failure current FDE (Fault Disconnection Electronic)	0 mA

PROFIBUS DP

Status and alarm messages	Diagnostics in accordance with PROFIBUS PA Profile 3.02
----------------------------------	---

EtherNet/IP

Device diagnostics	Device condition can be read out in Input Assembly
---------------------------	--

PROFINET

Device diagnostics	According to "Application Layer protocol for decentralized periphery", Version 2.3
---------------------------	--

PROFINET over Ethernet-APL

Device diagnostics	Diagnostics according to PROFINET PA Profile 4.02
--------------------	---

FOUNDATION Fieldbus

Status and alarm messages	Diagnostics in accordance with FF-891
Failure current FDE (Fault Disconnection Electronic)	0 mA

Modbus RS485

Failure mode	Choose from: <ul style="list-style-type: none"> ▪ NaN value instead of current value ▪ Last valid value
--------------	---

Modbus TCP over Ethernet-APL/SPE/Fast Ethernet

Failure mode	Choose from: <ul style="list-style-type: none"> ▪ NaN value instead of current value ▪ Last valid value
--------------	---

Current output

Current output 4-20 mA	
Failure mode	Configurable: <ul style="list-style-type: none"> ▪ 4 to 20 mA in accordance with NAMUR recommendation NE 43 ▪ 4 to 20 mA in accordance with US ▪ Min. value: 3.59 mA ▪ Max. value: 22.5 mA ▪ Definable value between: 3.59 to 22.5 mA ▪ Actual value ▪ Last valid value
Current output 4-20 mA	
Failure mode	Configurable: <ul style="list-style-type: none"> ▪ Maximum alarm: 22 mA ▪ Definable value between: 0 to 20.5 mA

Pulse/frequency/switch output

Pulse output	
Failure mode	Configurable: <ul style="list-style-type: none"> ▪ Actual value ▪ No pulses
Frequency output	
Failure mode	Configurable: <ul style="list-style-type: none"> ▪ Actual value ▪ 0 Hz ▪ Definable value between: 2 to 12 500 Hz
Switch output	
Failure mode	Configurable: <ul style="list-style-type: none"> ▪ Current status ▪ Open ▪ Closed

Relay output

Failure mode	Choose from: <ul style="list-style-type: none"> ■ Current status ■ Open ■ Closed
---------------------	---

Local display

Plain text display	With information on cause and remedial measures
Backlight	Red lighting indicates a device error.



Status signal as per NAMUR recommendation NE 107

Interface/protocol

- Via digital communication:
 - HART protocol
 - FOUNDATION Fieldbus
 - PROFIBUS PA
 - PROFIBUS DP
 - Modbus RS485
 - Modbus TCP over Ethernet-APL
 - EtherNet/IP
 - PROFINET
 - PROFINET over Ethernet-APL
- Via service interface
 - Service interface CDI-RJ45
 - Via service interface/port 2: (RJ45)
 - WLAN interface
- Plain text display
 - With information on cause and remedial actions
 - Modbus TCP



Additional information on remote operation → 109

Web browser

Plain text display	With information on cause and remedial measures
---------------------------	---

LEDs

Status information	Status indicated by various LEDs The following information is displayed depending on the device version: <ul style="list-style-type: none"> ■ Supply voltage active ■ Data transmission active ■ Device alarm/error has occurred ■ Network available ¹⁾ ■ Connection established ¹⁾ ■ Diagnostic status ²⁾ ■ PROFINET blinking feature ³⁾
---------------------------	---

1) Only available for PROFINET, PROFINET over Ethernet-APL, Modbus over Ethernet-APL, Ethernet/IP

2) Only available for Modbus over Ethernet-APL

3) Only available for PROFINET, PROFINET over Ethernet-APL,

Load

Output signal → 17

Ex connection data

Safety-related values

Order code for "Output; input 1"	Output type	Safety-related values	
		Output; input 1 (Port 1)	Service interface (Port 2)
Option BA	Current output 4-20 mA HART	$U_N = 30 V_{DC}$ $U_M = 250 V_{AC}$	$U_N = 3.3 V_{AC}$ $U_M = 250 V_{AC}$
Option GA	PROFIBUS PA	$U_N = 32 V_{DC}$ $U_M = 250 V_{AC}$	$U_N = 3.3 V_{AC}$ $U_M = 250 V_{AC}$
Option LA	PROFIBUS DP	$U_N = 5 V$ $U_M = 250 V_{AC}$	$U_N = 3.3 V_{AC}$ $U_M = 250 V_{AC}$
Option MA	Modbus RS485	$U_N = 5 V$ $U_M = 250 V_{AC}$	$U_N = 3.3 V_{AC}$ $U_M = 250 V_{AC}$
Option MB	Modbus TCP over Ethernet-APL 10 Mbit/s, SPE 10 Mbit/s, Ethernet 100 Mbit/s	APL port profile SLAX SPE PoDL classes 10, 11, 12 $U_N = 30 V_{DC}$ $U_M = 250 V_{AC}$	$U_N = 3.3 V_{AC}$ $U_M = 250 V_{AC}$
Option NA	EtherNet/IP	$U_N = 3.3 V_{AC}$ $U_M = 250 V_{AC}$	$U_N = 3.3 V_{AC}$ $U_M = 250 V_{AC}$
Option RA	PROFINET	$U_N = 3.3 V_{AC}$ $U_M = 250 V_{AC}$	$U_N = 3.3 V_{AC}$ $U_M = 250 V_{AC}$
Option RB	PROFINET over Ethernet-APL/SPE, 10Mbit/s	APL port profile SLAX SPE PoDL classes 10, 11, 12 $U_N = 30 V_{DC}$ $U_M = 250 V_{AC}$	$U_N = 3.3 V_{AC}$ $U_M = 250 V_{AC}$
Option SA	FOUNDATION Fieldbus	$U_N = 32 V_{DC}$ $U_M = 250 V_{AC}$	$U_N = 3.3 V_{AC}$ $U_M = 250 V_{AC}$

The specifications for U_M only apply to devices with Ex i circuits. Zone 1; Class I, Division 1 devices; Zone 2; Class I Division 2 devices with Ex i sensor.

Order code for "Output; input 2" "Output; input 3" "Output; input 4"	Output type	Safety-related values		
		Output; input 2	Output; input 3	Output; input 4
Option B	Current output 4-20 mA	$U_N = 30 V_{DC}$ $U_M = 250 V_{AC}$		
Option D	Configurable I/O initial setting off	$U_N = 30 V_{DC}$ $U_M = 250 V_{AC}$		
Option E	Pulse/frequency/switch output	$U_N = 30 V_{DC}$ $U_M = 250 V_{AC}$		
Option F	Double pulse output	$U_N = 30 V_{DC}$ $U_M = 250 V_{AC}$		
Option H	Relay output	$U_N = 30 V_{DC}$ $I_N = 100 mA_{DC}/500 mA_{AC}$ $U_M = 250 V_{AC}$		
Option I	Current input 4-20 mA	$U_N = 30 V_{DC}$ $U_M = 250 V_{AC}$		
Option J	Status input	$U_N = 30 V_{DC}$ $U_M = 250 V_{AC}$		

Intrinsically safe values

Zone 1, Zone 21			
Order code for "Output; input 1"	Output type	Intrinsically safe values	
		Output; input 1 (Port 1)	Service interface (Port 2)
Option CA	Current output 4-20mA HART Ex-i passive	Ex ic $U_i = 30 \text{ V}$ $I_i = 100 \text{ mA}$ $P_i = 1.25 \text{ W}$ $L_i = 0 \text{ } \mu\text{H}$ $C_i = 6 \text{ nF}$	Ex ia $U_i = 10 \text{ V}$ $I_i = \text{n. a.}$ $P_i = \text{n. a.}$ $L_i = 0 \text{ } \mu\text{H}$ $C_i = 200 \text{ nF}$
		Ex ic ¹⁾ Ex ic (NIFW) ²⁾ $U_i = 30 \text{ V}$ $I_i = 100 \text{ mA}$ $P_i = 1.25 \text{ W}$ $L_i = 0 \text{ } \mu\text{H}$ $C_i = 6 \text{ nF}$	Non-intrinsically safe ³⁾
Option CC	Current output 4-20mA HART Ex-i active	Ex ia $U_0 = 21.8 \text{ V}$ $I_0 = 90 \text{ mA}$ $P_0 = 491 \text{ mW}$ $L_0 = 4.1 \text{ mH(IIC)}/15 \text{ mH(IIB)}$ $C_0 = 160 \text{ nF(IIC)}/1160 \text{ nF(IIB)}$ $U_i = 30 \text{ V}$ $I_i = 10 \text{ mA}$ $P_i = 0.3 \text{ W}$ $L_i = 5 \text{ } \mu\text{H}$ $L_i = 4.1 \text{ } \mu\text{H}$ $C_i = 6 \text{ nF}$	Ex ia $U_i = 10 \text{ V}$ $I_i = \text{n. a.}$ $P_i = \text{n. a.}$ $L_i = 0 \text{ } \mu\text{H}$ $C_i = 200 \text{ nF}$
		Ex ic ¹⁾ Ex ic (NIFW) ²⁾ $U_0 = 21.8 \text{ V}$ $I_0 = 90 \text{ mA}$ $P_i = 491 \text{ mW}$ $L_0 = 9 \text{ mH(IIC)}/39 \text{ mH(IIB)}$ $C_0 = 600 \text{ nF(IIC)}/4000 \text{ nF(IIB)}$ $U_i = 30 \text{ V}$ $I_i = 10 \text{ mA}$ $P_i = 0.3 \text{ W}$ $L_i = 5 \text{ } \mu\text{H}$ $L_i = 4.1 \text{ } \mu\text{H}$ $C_i = 6 \text{ nF}$	Non-intrinsically safe ³⁾
Option HA	PROFIBUS PA Ex i (STANDARD + FISCO)	Ex ia $U_i = 30 \text{ V}$ $I_i = 570 \text{ mA}$ $P_i = 8.5 \text{ W}$ $L_i = 10 \text{ } \mu\text{H}$ $C_i = 5 \text{ nF}$	Ex ia $U_i = 10 \text{ V}$ $I_i = \text{n. a.}$ $P_i = \text{n. a.}$ $L_i = 0 \text{ } \mu\text{H}$ $C_i = 200 \text{ nF}$
		Ex ic ¹⁾ Ex ic (NIFW) ²⁾ $U_i = 32 \text{ V}$ $I_i = 570 \text{ mA}$ $P_i = 8.5 \text{ W}$ $L_i = 10 \text{ } \mu\text{H}$ $C_i = 5 \text{ nF}$	Non-intrinsically safe ³⁾

Zone 1, Zone 21			
Order code for "Output; input 1"	Output type	Intrinsically safe values	
		Output; input 1 (Port 1)	Service interface (Port 2)
Option MC	Modbus TCP over Ethernet-APL, Ex-i, 10Mbit/s	2-WISE power load, APL port profile SLAA⁴⁾ Ex ia $U_i = 17.5\text{ V}$ $I_i = 380\text{ mA}$ $P_i = 5.32\text{ W}$ $L_i = 10\text{ }\mu\text{H}$ $C_i = 5\text{ nF}$ Cable specifications according to 2-WISE: $R_c = 15\text{ to }150\text{ }\Omega/\text{km}$ $L_c = 0.4\text{ to }1\text{ mH}/\text{km}$ $C_c = 45\text{ to }200\text{ nF}/\text{km}$ $C_c = C_c\text{ line}/\text{line} + 0,5\text{ }C_c\text{ line}/\text{screen}$, if both lines are floating, or $C_c = C_c\text{ line}/\text{line} + C_c\text{ line}/\text{screen}$, if the screen is connected to one line Length of cable (not including cable stubs): $\leq 200\text{ m}$ (656.2 ft) Length of cable stubs: $\leq 1\text{ m}$ (3.3 ft)	Ex ia $U_i = 10\text{ V}$ $I_i = \text{n. a.}$ $P_i = \text{n. a.}$ $L_i = 0\text{ }\mu\text{H}$ $C_i = 200\text{ nF}$
		2-WISE power load, APL port profile SLAC⁴⁾ Ex ic¹⁾ Ex ic (NIFW)²⁾ $U_i = 17.5\text{ V}$ $I_i = 380\text{ mA}$ $P_i = 5.32\text{ W}$ $L_i = 10\text{ }\mu\text{H}$ $C_i = 5\text{ nF}$ Cable specifications according to 2-WISE: $R_c = 15\text{ to }150\text{ }\Omega/\text{km}$ $L_c = 0.4\text{ to }1\text{ mH}/\text{km}$ $C_c = 45\text{ to }200\text{ nF}/\text{km}$ $C_c = C_c\text{ line}/\text{line} + 0,5\text{ }C_c\text{ line}/\text{screen}$, if both lines are floating, or $C_c = C_c\text{ line}/\text{line} + C_c\text{ line}/\text{screen}$, if the screen is connected to one line Length of cable (not including cable stubs): $\leq 200\text{ m}$ (656.2 ft) Length of cable stubs: $\leq 1\text{ m}$ (3.3 ft)	Non-intrinsically safe ³⁾
Option RC	PROFINET over Ethernet-APL, Ex-i, 10Mbit/s	2-WISE power load, APL port profile SLAA⁴⁾ Ex ia $U_i = 17.5\text{ V}$ $I_i = 380\text{ mA}$ $P_i = 5.32\text{ W}$ $L_i = 10\text{ }\mu\text{H}$ $C_i = 5\text{ nF}$ Cable specifications according to 2-WISE: $R_c = 15\text{ to }150\text{ }\Omega/\text{km}$ $L_c = 0.4\text{ to }1\text{ mH}/\text{km}$ $C_c = 45\text{ to }200\text{ nF}/\text{km}$ $C_c = C_c\text{ line}/\text{line} + 0,5\text{ }C_c\text{ line}/\text{screen}$, if both lines are floating, or $C_c = C_c\text{ line}/\text{line} + C_c\text{ line}/\text{screen}$, if the screen is connected to one line Length of cable (not including cable stubs): $\leq 200\text{ m}$ (656.2 ft) Length of cable stubs: $\leq 1\text{ m}$ (3.3 ft)	Ex ia $U_i = 10\text{ V}$ $I_i = \text{n. a.}$ $P_i = \text{n. a.}$ $L_i = 0\text{ }\mu\text{H}$ $C_i = 200\text{ nF}$

Zone 1, Zone 21			
Order code for "Output; input 1"	Output type	Intrinsically safe values	
		Output; input 1 (Port 1)	Service interface (Port 2)
		2-WISE power load, APL port profile SLAC⁴⁾ Ex ic¹⁾ Ex ic (NIFW)²⁾ $U_i = 17.5 \text{ V}$ $I_i = 380 \text{ mA}$ $P_i = 5.32 \text{ W}$ $L_i = 10 \text{ } \mu\text{H}$ $C_i = 5 \text{ nF}$ Cable specifications according to 2-WISE: $R_c = 15 \text{ to } 150 \text{ } \Omega/\text{km}$ $L_c = 0.4 \text{ to } 1 \text{ mH/km}$ $C_c = 45 \text{ to } 200 \text{ nF/km}$ $C_c = C_c \text{ line/line} + 0,5 C_c \text{ line/screen}$, if both lines are floating, or $C_c = C_c \text{ line/line} + C_c \text{ line/screen}$, if the screen is connected to one line Length of cable (not including cable stubs): $\leq 200 \text{ m (656.2 ft)}$ Length of cable stubs: $\leq 1 \text{ m (3.3 ft)}$	Non-intrinsically safe ³⁾
Option TA	FOUNDATION Fieldbus Ex i (STANDARD + FISCO)	Ex ia $U_i = 30 \text{ V}$ $I_i = 570 \text{ mA}$ $P_i = 8.5 \text{ W}$ $L_i = 10 \text{ } \mu\text{H}$ $C_i = 5 \text{ nF}$	Ex ia $U_i = 10 \text{ V}$ $I_i = \text{n. a.}$ $P_i = \text{n. a.}$ $L_i = 0 \text{ } \mu\text{H}$ $C_i = 2.00 \text{ nF}$
		Ex ic¹⁾ Ex ic (NIFW)²⁾ $U_i = 32 \text{ V}$ $I_i = 570 \text{ mA}$ $P_i = 8.5 \text{ W}$ $L_i = 10 \text{ } \mu\text{H}$ $C_i = 5 \text{ nF}$	Non-intrinsically safe ³⁾

- 1) For approved options only: See separate document "Safety Instructions" (XA) for the device.
- 2) For approved options only: See separate document "Safety Instructions" (XA) for the device.
- 3) Connection to or operation with Service interface (Port 2) is not permitted in potentially explosive atmospheres.
- 4) For further options see Ethernet-APL Installation Drawing HE_01622.

Zone 2		
Order code for "Output; input 1"	Output type	Intrinsically safe values or NIFW values Output; input 1 (Port 1)
Option HA	PROFIBUS PA Ex i (STANDARD + FISCO)	Ex ic AEx ic, Ex ic, NIFW $U_i = 32\text{ V}$ $I_i = 570\text{ mA}$ $P_i = 8.5\text{ W}$ $L_i = 10\text{ }\mu\text{H}$ $C_i = 5\text{ nF}$
Option MC	Modbus TCP over Ethernet-APL, Ex-i, 10Mbit/s	2-WISE power load, APL port profile SLAC ¹⁾ Ex ic AEx ic, Ex ic, NIFW $U_i = 17.5\text{ V}$ $I_i = 380\text{ mA}$ $P_i = 5.32\text{ W}$ $L_i = 10\text{ }\mu\text{H}$ $C_i = 5\text{ nF}$ Cable specifications according to 2-WISE: $R_c = 15\text{ to }150\text{ }\Omega/\text{km}$ $L_c = 0.4\text{ to }1\text{ mH}/\text{km}$ $C_c = 45\text{ to }200\text{ nF}/\text{km}$ $C_c = C_c\text{ line}/\text{line} + 0.5\text{ }C_c\text{ line}/\text{screen}$, if both lines are floating, or $C_c = C_c\text{ line}/\text{line} + C_c\text{ line}/\text{screen}$, if the screen is connected to one line Length of cable (not including cable stubs): $\leq 200\text{ m}$ (656.2 ft) Length of cable stubs: $\leq 1\text{ m}$ (3.3 ft)
Option RC	PROFINET over Ethernet-APL, Ex-i, 10Mbit/s	Ex ic AEx ic, Ex ic, NIFW $U_i = 17.5\text{ V}$ $I_i = 380\text{ mA}$ $P_i = 5.32\text{ W}$ $L_i = 10\text{ }\mu\text{H}$ $C_i = 5\text{ nF}$ Cable specifications according to 2-WISE: $R_c = 15\text{ to }150\text{ }\Omega/\text{km}$ $L_c = 0.4\text{ to }1\text{ mH}/\text{km}$ $C_c = 45\text{ to }200\text{ nF}/\text{km}$ $C_c = C_c\text{ line}/\text{line} + 0.5\text{ }C_c\text{ line}/\text{screen}$, if both lines are floating, or $C_c = C_c\text{ line}/\text{line} + C_c\text{ line}/\text{screen}$, if the screen is connected to one line Length of cable (not including cable stubs): $\leq 200\text{ m}$ (656.2 ft) Length of cable stubs: $\leq 1\text{ m}$ (3.3 ft)
Option TA	FOUNDATION Fieldbus Ex i (STANDARD + FISCO)	Ex ic AEx ic, Ex ic, NIFW $U_i = 32\text{ V}$ $I_i = 570\text{ mA}$ $P_i = 8.5\text{ W}$ $L_i = 10\text{ }\mu\text{H}$ $C_i = 5\text{ nF}$

1) For further options see Ethernet-APL Installation Drawing HE_01622.

Order code for "Output; input 2" "Output; input 3" "Output; input 4"	Output type	Intrinsically safe values or NIFW values		
		Output; input 2	Output; input 3	Output; input 4
Option C	Current output 4-20mA Ex-i passive	Ex ia or Ex ic (NIFW) Ex ic AEx ic, Ex ic, NIFW $U_i = 30\text{ V}$ $I_i = 100\text{ mA}$ $P_i = 1.25\text{ W}$ $L_i = 0$ $C_i = 0$		
Option G	Pulse/frequency/switch output Ex-i passive	Ex ia or Ex ic (NIFW) Ex ic AEx ic, Ex ic, NIFW $U_i = 30\text{ V}$ $I_i = 100\text{ mA}$ $P_i = 1.25\text{ W}$ $L_i = 0$ $C_i = 0$		

Low flow cut off The switch points for low flow cut off are user-selectable.

Galvanic isolation The outputs are galvanically isolated:

- from the power supply
- from one another
- from the protective ground connection (PE)

Protocol-specific data

HART



Manufacturer ID	0x11
Device type ID	0x3B
HART protocol revision	7
Device description files (DTM, DD)	Information and files under: www.endress.com
HART load	Min. 250 Ω
System integration	Information on system integration: Operating Instructions →  132. <ul style="list-style-type: none"> ▪ Measured variables via HART protocol ▪ Burst Mode functionality

FOUNDATION Fieldbus

Manufacturer ID	0x452B48 (hex)
Ident number	0x103B (hex)
Device revision	1
DD revision	Information and files under:
CFF revision	<ul style="list-style-type: none"> ▪ www.endress.com ▪ www.fieldcommgroup.org
Interoperability Test Kit (ITK)	Version 6.2.0
ITK Test Campaign Number	Information: <ul style="list-style-type: none"> ▪ www.endress.com ▪ www.fieldcommgroup.org
Link Master capability (LAS)	Yes
Choice of "Link Master" and "Basic Device"	Yes Factory setting: Basic Device
Node address	Factory setting: 247 (0xF7)
Supported functions	The following methods are supported: <ul style="list-style-type: none"> ▪ Restart ▪ ENP Restart ▪ Diagnostic ▪ Set to OOS ▪ Set to AUTO ▪ Read trend data ▪ Read event logbook
Virtual Communication Relationships (VCRs)	
Number of VCRs	44
Number of link objects in VFD	50
Permanent entries	1
Client VCRs	0
Server VCRs	10
Source VCRs	43
Sink VCRs	0
Subscriber VCRs	43
Publisher VCRs	43
Device Link Capabilities	
Slot time	4
Min. delay between PDU	8



Max. response delay	16
System integration	Information regarding system integration: Operating Instructions →  132. <ul style="list-style-type: none"> ▪ Cyclic data transmission ▪ Description of the modules ▪ Execution times ▪ Methods

PROFIBUS DP

Manufacturer ID	0x11
Ident number	0x156F
Profile version	3.02
Device description files (GSD, DTM, DD)	Information and files under: <ul style="list-style-type: none"> ▪ https://www.endress.com/download On the device product page: PRODUCTS → Product Finder → Links ▪ https://www.profibus.com
Supported functions	<ul style="list-style-type: none"> ▪ Identification & Maintenance Simplest device identification on the part of the control system and nameplate ▪ PROFIBUS upload/download Reading and writing parameters is up to ten times faster with PROFIBUS upload/download ▪ Condensed status Simplest and self-explanatory diagnostic information by categorizing diagnostic messages that occur
Configuration of the device address	<ul style="list-style-type: none"> ▪ DIP switches on the I/O electronics module ▪ Via operating tools (e.g. FieldCare)
Compatibility with earlier model	<p>If the device is replaced, the measuring device Promass 500 supports the compatibility of the cyclic data with previous models. It is not necessary to adjust the engineering parameters of the PROFIBUS network with the Promass 500 GSD file.</p> <p>Previous model: Promass 83 PROFIBUS DP</p> <ul style="list-style-type: none"> ▪ ID No.: 1529 (hex) ▪ Extended GSD file: EH3x1529.gsd ▪ Standard GSD file: EH3_1529.gsd <p> Description of the function scope of compatibility: Operating Instructions →  132.</p>
System integration	Information regarding system integration: Operating Instructions →  132. <ul style="list-style-type: none"> ▪ Cyclic data transmission ▪ Block model ▪ Description of the modules





PROFIBUS PA

Manufacturer ID	0x11
Ident number	0x156D
Profile version	3.02
Device description files (GSD, DTM, DD)	Information and files under: <ul style="list-style-type: none"> ▪ https://www.endress.com/download On the device product page: PRODUCTS → Product Finder → Links ▪ https://www.profibus.com

Supported functions	<ul style="list-style-type: none"> ▪ Identification & Maintenance Simplest device identification on the part of the control system and nameplate ▪ PROFIBUS upload/download Reading and writing parameters is up to ten times faster with PROFIBUS upload/download ▪ Condensed status Simplest and self-explanatory diagnostic information by categorizing diagnostic messages that occur
Configuration of the device address	<ul style="list-style-type: none"> ▪ DIP switches on the I/O electronics module ▪ Local display ▪ Via operating tools (e.g. FieldCare)
Compatibility with earlier model	<p>If the device is replaced, the measuring device Promass 500 supports the compatibility of the cyclic data with previous models. It is not necessary to adjust the engineering parameters of the PROFIBUS network with the Promass 500 GSD file.</p> <p>Earlier models:</p> <ul style="list-style-type: none"> ▪ Promass 80 PROFIBUS PA <ul style="list-style-type: none"> ▪ ID No.: 1528 (hex) ▪ Extended GSD file: EH3x1528.gsd ▪ Standard GSD file: EH3_1528.gsd ▪ Promass 83 PROFIBUS PA <ul style="list-style-type: none"> ▪ ID No.: 152A (hex) ▪ Extended GSD file: EH3x152A.gsd ▪ Standard GSD file: EH3_152A.gsd <p> Description of the function scope of compatibility: Operating Instructions →  132.</p>
System integration	<p>Information regarding system integration: Operating Instructions →  132.</p> <ul style="list-style-type: none"> ▪ Cyclic data transmission ▪ Block model ▪ Description of the modules

Modbus RS485

Protocol	Modbus Applications Protocol Specification V1.1
Response times	<ul style="list-style-type: none"> ▪ Direct data access: typically 25 to 50 ms ▪ Auto-scan buffer (data range): typically 3 to 5 ms
Device type	Slave
Slave address range	1 to 247
Broadcast address range	0
Function codes	<ul style="list-style-type: none"> ▪ 03: Read holding register ▪ 04: Read input register ▪ 06: Write single registers ▪ 08: Diagnostics ▪ 16: Write multiple registers ▪ 23: Read/write multiple registers
Broadcast messages	<p>Supported by the following function codes:</p> <ul style="list-style-type: none"> ▪ 06: Write single registers ▪ 16: Write multiple registers ▪ 23: Read/write multiple registers
Supported baud rate	<ul style="list-style-type: none"> ▪ 1 200 BAUD ▪ 2 400 BAUD ▪ 4 800 BAUD ▪ 9 600 BAUD ▪ 19 200 BAUD ▪ 38 400 BAUD ▪ 57 600 BAUD ▪ 115 200 BAUD
Data transmission mode	<ul style="list-style-type: none"> ▪ ASCII ▪ RTU

Data access	Each device parameter can be accessed via Modbus RS485.  For Modbus register information
Compatibility with earlier model	If the device is replaced, the measuring instrument Promass 500 supports the compatibility of the Modbus registers for the process variables and the diagnostic information with the previous model Promass 83. It is not necessary to change the engineering parameters in the automation system.  Description of the function scope of compatibility: Operating Instructions →  132.
System integration	Information regarding system integration: Operating Instructions →  132. <ul style="list-style-type: none"> ▪ Modbus RS485 information ▪ Function codes ▪ Register information ▪ Response time ▪ Modbus data map

Modbus TCP over Ethernet-APL

Port 1: Modbus TCP over Ethernet-APL 10 Mbit/s, SPE 10 Mbit/s	
Protocol	<ul style="list-style-type: none"> ▪ Modbus application protocol V1.1 ▪ TCP
Response times	On Modbus client request: Typically 3 to 5 ms
TCP port	502
Modbus TCP connections	Maximum 4
Communication type	Ethernet Advanced Physical Layer 10BASE-T1L
Data transfer	Full-duplex
Polarity	Automatic correction of crossed "APL signal +" and "APL signal -" signal lines
Device type	Address
Device type ID	0xC43B
Function codes	<ul style="list-style-type: none"> ▪ 03: Read holding register ▪ 04: Read input register ▪ 06: Write single registers ▪ 16: Write multiple registers ▪ 23: Read/write multiple registers ▪ 43: Read device identification
Broadcast support for function codes	<ul style="list-style-type: none"> ▪ 06: Write single registers ▪ 16: Write multiple registers ▪ 23: Read/write multiple registers ▪ 43: Read device identification
Supported transfer speed	10 Mbit/s (Ethernet-APL)
Supported features	Address can be configured using DHCP, web server or software
Device description files (FDI)	Information and files available at: www.endress.com → Downloads area
Configuration options for measuring instrument	<ul style="list-style-type: none"> ▪ Asset management software (FieldCare, DeviceCare, Field Expert) ▪ Integrated web server via web browser and IP address ▪ Onsite operation

Supported functions	<ul style="list-style-type: none"> ▪ Device identification using: Nameplate ▪ Measured value status The process variables are communicated with a measured value status ▪ Blinking feature via the local display for simple device identification and assignment ▪ Device operation via asset management software (e.g. FieldCare, DeviceCare)
System integration	<p>Information regarding system integration: Operating Instructions →  132.</p> <ul style="list-style-type: none"> ▪ Overview and description of the supported function codes ▪ Status coding ▪ Factory setting

Port 2: Modbus TCP over Ethernet 100 Mbit/s	
Protocol	<ul style="list-style-type: none"> ▪ Modbus application protocol V1.1 ▪ TCP
Response times	On Modbus client request: Typically 3 to 5 ms
TCP port	502
Modbus TCP connections	Maximum 4
Communication type	<ul style="list-style-type: none"> ▪ 10BASE-T ▪ 100BASE-TX
Data transfer	Half-duplex, full-duplex
Polarity	Auto-MDIX
Device type	Address
Device type ID	0xC43B
Function codes	<ul style="list-style-type: none"> ▪ 03: Read holding register ▪ 04: Read input register ▪ 06: Write single registers ▪ 16: Write multiple registers ▪ 23: Read/write multiple registers ▪ 43: Read device identification
Broadcast support for function codes	<ul style="list-style-type: none"> ▪ 06: Write single registers ▪ 16: Write multiple registers ▪ 23: Read/write multiple registers ▪ 43: Read device identification
Supported transfer speed	<ul style="list-style-type: none"> ▪ 10 Mbit/s ▪ 100 Mbit/s (Fast-Ethernet)
Supported features	Address can be configured using DHCP, web server or software
Device description files (FDI)	Information and files available at: www.endress.com → Downloads area
Configuration options for measuring instrument	<ul style="list-style-type: none"> ▪ Asset management software (FieldCare, DeviceCare, Field Expert) ▪ Integrated web server via web browser and IP address ▪ Onsite operation
Supported functions	<ul style="list-style-type: none"> ▪ Device identification using: Nameplate ▪ Measured value status The process variables are communicated with a measured value status ▪ Device operation via asset management software (e.g. FieldCare, DeviceCare)
System integration	<p>Information regarding system integration: Operating Instructions →  132.</p> <ul style="list-style-type: none"> ▪ Overview and description of the supported function codes ▪ Status coding ▪ Factory setting

EtherNet/IP

Protocol	<ul style="list-style-type: none"> ■ The CIP Networks Library Volume 1: Common Industrial Protocol ■ The CIP Networks Library Volume 2: EtherNet/IP Adaptation of CIP
Communication type	<ul style="list-style-type: none"> ■ 10Base-T ■ 100Base-TX
Device profile	Generic device (product type: 0x2B)
Manufacturer ID	0x000049E
Device type ID	0x103B
Baud rates	Automatic 10 ¹⁰⁰ Mbit with half-duplex and full-duplex detection
Polarity	Auto-polarity for automatic correction of crossed TxD and RxD pairs
Supported CIP connections	Max. 3 connections
Explicit connections	Max. 6 connections
I/O connections	Max. 6 connections (scanner)
Configuration options for measuring device	<ul style="list-style-type: none"> ■ DIP switches on the electronics module for IP addressing ■ Manufacturer-specific software (FieldCare) ■ Add-on Profile Level 3 for Rockwell Automation control systems ■ Web browser ■ Electronic Data Sheet (EDS) integrated in the measuring device
Configuration of the Ethernet interface	<ul style="list-style-type: none"> ■ Speed: 10 MBit, 100 MBit, auto (factory setting) ■ Duplex: half-duplex, full-duplex, auto (factory setting)
Configuration of the device address	<ul style="list-style-type: none"> ■ DIP switches on the electronics module for IP addressing (last octet) ■ DHCP ■ Manufacturer-specific software (FieldCare) ■ Add-on Profile Level 3 for Rockwell Automation control systems ■ Web browser ■ EtherNet/IP tools, e.g. RSLinx (Rockwell Automation)
Device Level Ring (DLR)	Yes
System integration	<p>Information regarding system integration: Operating Instructions →  132.</p> <ul style="list-style-type: none"> ■ Cyclic data transmission ■ Block model ■ Input and output groups

PROFINET

Protocol	Application layer protocol for decentral device periphery and distributed automation, Version 2.3
Communication type	100 Mbit/s
Conformity class	Conformance class B
Netload Class	Netload Class 2 100 Mbit/s
Baud rates	Automatic 100 Mbit/s with full-duplex detection
Periods	From 8 ms
Polarity	Auto-polarity for automatic correction of crossed TxD and RxD pairs
Media Redundancy Protocol (MRP)	Yes
System redundancy support	System redundancy S2 (2 AR with 1 NAP)
Device profile	Application interface identifier 0xF600 Generic device
Manufacturer ID	0x11
Device type ID	0x843B

Device description files (GSD, DTM, DD)	Information and files available at: <ul style="list-style-type: none"> ▪ www.endress.com On the product page for the device: Documents/Software → Device drivers ▪ www.profibus.com
Supported connections	<ul style="list-style-type: none"> ▪ 2 x AR (IO Controller AR) ▪ 1 x AR (IO-Supervisor Device AR connection allowed) ▪ 1 x Input CR (Communication Relation) ▪ 1 x Output CR (Communication Relation) ▪ 1 x Alarm CR (Communication Relation)
Configuration options for measuring instrument	<ul style="list-style-type: none"> ▪ DIP switches on the electronics module, for device name assignment (last part) ▪ Asset management software (FieldCare, DeviceCare, Field Xpert) ▪ Integrated web server via web browser and IP address ▪ Device master file (GSD), can be read out via the integrated web server of the measuring instrument. ▪ Onsite operation
Configuration of the device name	<ul style="list-style-type: none"> ▪ DIP switches on the electronics module, for device name assignment (last part) ▪ DCP protocol ▪ Asset management software (FieldCare, DeviceCare, Field Xpert) ▪ Integrated web server
Supported functions	<ul style="list-style-type: none"> ▪ Identification & Maintenance, simple device identifier via: <ul style="list-style-type: none"> ▪ Control system ▪ Nameplate ▪ Measured value status The process variables are communicated with a measured value status ▪ Blinking feature via the local display for simple device identification and assignment ▪ Device operation via asset management software (e.g. FieldCare, DeviceCare, SIMATIC PDM)
System integration	Information regarding system integration: Operating Instructions →  132. <ul style="list-style-type: none"> ▪ Cyclic data transmission ▪ Overview and description of the modules ▪ Status coding ▪ Startup configuration ▪ Factory setting

PROFINET over Ethernet-APL

Protocol	Application layer protocol for decentral device periphery and distributed automation, Version 2.43
Communication type	Ethernet Advanced Physical Layer 10BASE-T1L
Conformance Class	Conformance Class B (PA)
Netload Class	PROFINET Netload Robustness Class 2 10 Mbit/s
Data transfer	10 Mbit/s Full-duplex
Cycle times	64 ms
Polarity	Automatic correction of crossed "APL signal +" and "APL signal -" signal lines
Media Redundancy Protocol (MRP)	Not possible (point-to-point connection to APL field switch)
System redundancy support	System redundancy S2 (2 AR with 1 NAP)
Device profile	PROFINET PA profile 4.02 (Application interface identifier API: 0x9700)
Manufacturer ID	17
Device type ID	0xA43B
Device description files (GSD, DTM, FDI)	Information and files available at: <ul style="list-style-type: none"> ▪ www.endress.com → Downloads area ▪ www.profibus.com

Supported connections	<ul style="list-style-type: none"> 2x AR (IO Controller AR) 2x AR (IO Supervisor Device AR connection allowed)
Configuration options for measuring instrument	<ul style="list-style-type: none"> DIP switches on the electronics module, for device name assignment (last part) Asset management software (FieldCare, DeviceCare, Field Xpert) Integrated Web server via Web browser and IP address Device master file (GSD), can be read out via the integrated Web server of the measuring instrument. Onsite operation
Configuration of the device name	<ul style="list-style-type: none"> DIP switches on the electronics module, for device name assignment (last part) DCP protocol Asset management software (FieldCare, DeviceCare, Field Xpert) Integrated web server
Supported functions	<ul style="list-style-type: none"> Identification & Maintenance, simple device identifier via: <ul style="list-style-type: none"> Control system Nameplate Measured value status The process variables are communicated with a measured value status Blinking feature via the local display for simple device identification and assignment Device operation via asset management software (e.g. FieldCare, DeviceCare, SIMATIC PDM with FDI package)
System integration	<p>Information regarding system integration: Operating Instructions → 132.</p> <ul style="list-style-type: none"> Cyclic data transmission Overview and description of the modules Status coding Factory setting

Power supply

Terminal assignment

Transmitter: supply voltage, input/outputs

HART

Supply voltage		Input/output 1 (port 1)		Input/output 2		Input/output 3		Input/output 4 ¹⁾		Service interface (Port 2)
1 (+)	2 (-)	26 (+)	27 (-)	24 (+)	25 (-)	22 (+)	23 (-)	20 (+)	21 (-)	CDI-RJ45
The terminal assignment depends on the specific device version ordered → 15.										

1) Input/output only available for Proline 500 - digital.

FOUNDATION fieldbus

Supply voltage		Input/output 1 (port 1)		Input/output 2		Input/output 3		Input/output 4 ¹⁾		Service interface (Port 2)
1 (+)	2 (-)	26 (A)	27 (B)	24 (+)	25 (-)	22 (+)	23 (-)	20 (+)	21 (-)	CDI-RJ45
The terminal assignment depends on the specific device version ordered → 15.										

1) Input/output only available for Proline 500 - digital.

PROFIBUS DP

Supply voltage		Input/output 1 (port 1)		Input/output 2		Input/output 3		Input/output 4 ¹⁾		Service interface (Port 2)
1 (+)	2 (-)	26 (B)	27 (A)	24 (+)	25 (-)	22 (+)	23 (-)	20 (+)	21 (-)	CDI-RJ45
The terminal assignment depends on the specific device version ordered →  15.										

1) Input/output only available for Proline 500 - digital.

PROFIBUS PA

Supply voltage		Input/output 1 (port 1)		Input/output 2		Input/output 3		Input/output 4 ¹⁾		Service interface (Port 2)
1 (+)	2 (-)	26 (B)	27 (A)	24 (+)	25 (-)	22 (+)	23 (-)	20 (+)	21 (-)	CDI-RJ45
The terminal assignment depends on the specific device version ordered →  15.										

1) Input/output only available for Proline 500 - digital.

Modbus RS485

Supply voltage		Input/output 1 (port 1)		Input/output 2		Input/output 3		Input/output 4 ¹⁾		Service interface (Port 2)
1 (+)	2 (-)	26 (B)	27 (A)	24 (+)	25 (-)	22 (+)	23 (-)	20 (+)	21 (-)	CDI-RJ45
The terminal assignment depends on the specific device version ordered →  15.										

1) Input/output only available for Proline 500 - digital.

Modbus TCP

Supply voltage		Input/output 1 (Port 1) ¹⁾		Input/output 2		Input/output 3		Input/output 4 ²⁾		Service interface (Port 2) ¹⁾
1 (+)	2 (-)	26 (+)	27 (-)	24 (+)	25 (-)	22 (+)	23 (-)	20 (+)	21 (-)	CDI-RJ45
The terminal assignment depends on the specific device version ordered →  15.										

1) For Modbus TCP communication, either port 1 OR port 2 can be used.

2) Input/output only available for Proline 500 - digital.

PROFINET

Supply voltage		Input/output 1 (Port 1) ¹⁾		Input/output 2		Input/output 3		Input/output 4 ²⁾		Service interface (Port 2) ¹⁾
1 (+)	2 (-)	RJ45		24 (+)	25 (-)	22 (+)	23 (-)	20 (+)	21 (-)	CDI-RJ45
The terminal assignment depends on the specific device version ordered →  15.										

1) Port can be used for communication or as a service interface (CDI-RJ45).

2) Input/output only available for Proline 500 - digital.

PROFINET over Ethernet-APL

Supply voltage		Input/output 1 (Port 1)		Input/output 2		Input/output 3		Input/output 4 ¹⁾		Service interface (Port 2 ²⁾)
1 (+)	2 (-)	26 (+)	27 (-)	24 (+)	25 (-)	22 (+)	23 (-)	20 (+)	21 (-)	CDI-RJ45
The terminal assignment depends on the specific device version ordered → 15.										

- 1) Input/output only available for Proline 500 - digital.
- 2) No PROFINET communication available on port 2

Ethernet/IP

Supply voltage		Input/output 1 (Port 1) ¹⁾	Input/output 2		Input/output 3		Input/output 4 ²⁾		Service interface (Port 2) ¹⁾
1 (+)	2 (-)	RJ45	24 (+)	25 (-)	22 (+)	23 (-)	20 (+)	21 (-)	CDI-RJ45
The terminal assignment depends on the specific device version ordered → 15.									

- 1) Port can be used for communication or as a service interface (CDI-RJ45).
- 2) Input/output only available for Proline 500 - digital.

Transmitter and sensor connection housing: connecting cable

The sensor and transmitter, which are mounted in separate locations, are interconnected by a connecting cable. The cable is connected via the sensor connection housing and the transmitter housing.

Terminal assignment and connection of the connecting cable:

- Proline 500 – digital → 47
- Proline 500 → 48

Available device plugs Proline 500

Device plugs may not be used in hazardous areas!

Device plugs for Proline 500:

Order code for "Input; output 1"

- Option **SA** "FOUNDATION Fieldbus" → 41
- Option **GA** "PROFIBUS PA" → 41
- Option **NA** "EtherNet/IP" → 42
- Option **RA** "PROFINET" → 42
- Option **RB** "PROFINET over Ethernet-APL" → 42
- Option **MB** "Modbus TCP" → 42

Device plug for connecting to the service interface:

Order code for "Accessory mounted"

Option **NB**, RJ45 M12 adapter (service interface) → 46

Order code for "Input; output 1", option SA "FOUNDATION fieldbus"

Order code for	Cable entry/connection → 48	
"Electrical connection"	2	3
M, 3, 4, 5	7/8" plug	-

Order code for "Input; output 1", option GA "PROFIBUS PA"

Order code for	Cable entry/connection → 48	
"Electrical connection"	2	3
L, N, P, U	Connector M12×1	-

Order code for "Input; output 1", option NA "EtherNet/IP"

Order code for "Electrical connection"	Cable entry/connection → 48	
	2	3
L, N, P, U	Connector M12×1	-
R ^{1) 2)} , S ^{1) 2)} , T ^{1) 2)} , V ^{1) 2)}	Connector M12×1	Connector M12×1

- 1) Not compatible with an external WLAN antenna (order code for "Accessory enclosed", option P8), an RJ45 M12 adapter for the service interface (order code for "Accessory mounted", option NB)
- 2) Suitable for integrating the device into a ring topology.

Order code for "Input; output 1", option RA "PROFINET"

Order code for "Electrical connection"	Cable entry/connection → 48	
	2	3
L, N, P, U	Connector M12×1	-
R ^{1) 2)} , S ^{1) 2)} , T ^{1) 2)} , V ^{1) 2)}	Connector M12×1	Connector M12×1

- 1) Not compatible with an external WLAN antenna (order code for "Accessory enclosed", option P8), an RJ45 M12 adapter for the service interface (order code for "Accessory mounted", option NB)
- 2) Suitable for integrating the device into a ring topology.

Order code for "Input; output 1", option RB "PROFINET over Ethernet-APL"

Order code for "Electrical connection"	Cable entry/connection → 48	
	2	3
L, N, P, U	Connector M12×1	-

Order code for "Input; output 1", option MB "Modbus TCP over Ethernet-APL"

Order code for "Electrical connection"	Accessories	Cable entry/connection → 48	
		2	3
L, N, P, U	-	Connector M12×1 A-coded	-
L, N, P, U	NB ¹⁾	Connector M12×1 A-coded	Connector M12×1 ¹⁾ D-coded
1 ²⁾ , 2 ²⁾ , 7 ²⁾ , 8 ²⁾	-	-	Connector M12×1 D-coded

- 1) Cannot be used as a Modbus TCP port.
- 2) Not compatible with an external WLAN antenna (order code for "Accessory enclosed", option P8), an RJ45 M12 adapter for the service interface (order code for "Accessory mounted", option NB)

Order code for "Accessory mounted", option NB: "Adapter RJ45 M12 (service interface)"

Order code for "Accessory mounted"	Cable entry/connection → 48	
	Cable entry 2	Cable entry 3
NB ¹⁾	-	Connector M12×1

- 1) Not compatible with electrical connection option 1, 2, 7, 8

**Available device plugs
Proline 500 digital**

Device plugs for Proline 500 digital:

Order code for "Input; output 1"

- Option **SA** "FOUNDATION Fieldbus" → 41
- Option **GA** "PROFIBUS PA" → 41
- Option **NA** "Ethernet/IP" → 42
- Option **RA** "PROFINET" → 42
- Option **RB** "PROFINET over Ethernet-APL" → 42
- Option **MB** "Modbus TCP over Ethernet-APL"

Device plug for connecting to the service interface:

Order code for "Accessory mounted"

Option **NB**, RJ45 M12 adapter (service interface) → 46

Order code for "Input; output 1", option SA "FOUNDATION fieldbus"

Order code for "Electrical connection"	Cable entry/connection → 48			
	2	3	4	5
M, 3, 4, 5	-	7/8" connector	-	-

Order code for "Input; output 1", option GA "PROFIBUS PA"

Order code for "Electrical connection"	Cable entry/connection → 48			
	2	3	4	5
L, N, P, U	-	Connector M12×1	-	-

Order code for "Input; output 1", option NA "Ethernet/IP"

Order code for "Electrical connection"	Cable entry/connection → 48			
	2	3	4	5
L, N, P, U	Connector M12×1	-	-	-
R ^{1) 2)} , S ^{1) 2)} , T ^{1) 2)} , V ^{1) 2)}	Connector M12×1	-	-	Connector M12×1

- 1) Not compatible with an external WLAN antenna (order code for "Accessory enclosed", option P8), an RJ45 M12 adapter for the service interface (order code for "Accessory mounted", option NB)
- 2) Suitable for integrating the device into a ring topology.

Order code for "Input; output 1", option RA "PROFINET"

Order code for "Electrical connection"	Cable entry/connection → 48			
	2	3	4	5
L, N, P, U	Connector M12×1	-	-	-
R ^{1) 2)} , S ^{1) 2)} , T ^{1) 2)} , V ^{1) 2)}	Connector M12×1	-	-	Connector M12×1

- 1) Not compatible with an external WLAN antenna (order code for "Accessory enclosed", option P8), an RJ45 M12 adapter for the service interface (order code for "Accessory mounted", option NB)
- 2) Suitable for integrating the device into a ring topology.

Order code for "Input; output 1", option RB "PROFINET over Ethernet-APL"

Order code for "Electrical connection"	Cable entry/connection → 48			
	2	3	4	5
L, N, P, U	-	Connector M12×1 A-coded	-	-

Order code for "Input; output 1", option MB "Modbus TCP over Ethernet-APL"

Order code for "Electrical connection"	Accessories	Cable entry/connection → 48			
		2	3	4	5
L, N, P, U	-	-	Connector M12×1 A-coded	-	-
L, N, P, U	NB ¹⁾	-	Connector M12×1 A-coded	-	Connector M12×1 ¹⁾ D-coded
1 ²⁾ , 2 ²⁾ , 7 ²⁾ , 8 ²⁾	-	-	-	-	Connector M12×1 D-coded

- 1) Cannot be used as a Modbus TCP port.
- 2) Not compatible with an external WLAN antenna (order code for "Accessory enclosed", option P8, an RJ45 M12 adapter for the service interface (order code for "Accessory mounted", option NB)

Order code for "Accessory mounted", option NB: "Adapter RJ45 M12 (service interface)"

Order code for "Electrical connection"	Cable entry/connection → 48			
	2	3	4	5
NB ¹⁾	-	-	-	M12x1 plug D-coded

- 1) Not compatible with electrical connection option 1, 2, 7, 8

Pin assignment, device plug

FOUNDATION Fieldbus

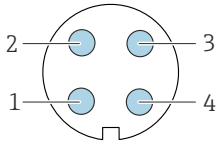
	Pin	Assignment	Coding	Plug/socket	
	1	+	Signal +	A	Plug
	2	-	Signal -		
	3		Cable shield ¹⁾		
	4		Not used		
Metal plug housing		Cable shield			
¹⁾ If a cable shield is used					

PROFIBUS PA

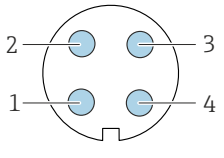
	Pin	Assignment	Coding	Plug/socket	
	1	+	PROFIBUS PA +	A	Plug
	2		Grounding		
	3	-	PROFIBUS PA -		

	4		Not used		
	Met al plug housing		Cable shield		

- i** Recommended plug:
- Binder, series 713, part no. 99 1430 814 04
 - Phoenix, part no. 1413934 SACC-FS-4QO SH PBPA SCO

PROFINET

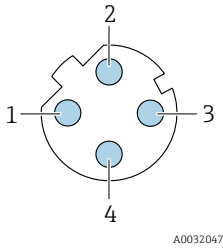
	Pin	Assignment		Coding	Plug/socket
	1	+	TD +	D	Socket
	2	+	RD +		
	3	-	TD -		
	4	-	RD -		
	Met al plug housing		Cable shield		

- i** Recommended plug:
- Binder, series 825, part no. 99 3729 810 04
 - Phoenix, part no. 1543223 SACC-M12MSD-4Q

PROFINET over Ethernet-APL

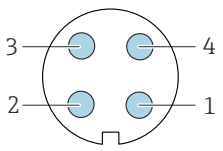
	Pin	Assignment	Coding	Plug/socket
	1	Ethernet-APL signal -	A	Socket
	2	Ethernet-APL signal +		
	3	Cable shield ¹		
	4	Not used		
Met al plug housing		Cable shield		
¹ If a cable shield is used				

- i** Recommended plug:
- Binder, series 713, part no. 99 1430 814 04
 - Phoenix, part no. 1413934 SACC-FS-4QO SH PBPA SCO

Modbus TCP over Ethernet-APL 10 Mbit/s

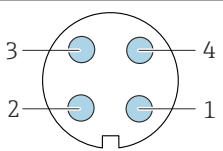
	Pin	Assignment	Coding	Plug/socket
	1	Ethernet-APL signal -	A	Socket
	2	Ethernet-APL signal +		
	3	Cable shield ¹		
	4	Not used		
Met al plug housing		Cable shield		
¹ If a cable shield is used				

- i** Recommended plug:
- Binder, series 713, part no. 99 1430 814 04
 - Phoenix, part no. 1413934 SACC-FS-4QO SH PBPA SCO

Modbus TCP over Ethernet 100 Mbit/s

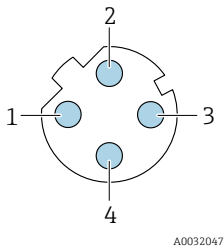
 <p style="text-align: center; font-size: small;">A0032047</p>	Pin	Assignment		Coding	Plug/socket
	1	+	Tx	D	Socket
	2	+	Rx		
	3	-	Tx		
4	-	Rx			

EtherNet/IP

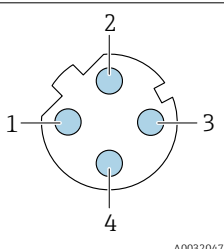
 <p style="text-align: center; font-size: small;">A0032047</p>	Pin	Assignment		Coding	Plug/socket	
	1	+	Tx	D	Socket	
	2	+	Rx			
	3	-	Tx			
4	-	Rx				
	Met al plug hous ing		Cable shield			

- i** Recommended plug:
- Binder, series 825, part no. 99 3729 810 04
 - Phoenix, part no. 1543223 SACC-M12MSD-4Q

Service interface

Order code for "Accessory mounted", option **NB**: "Adapter RJ45 M12 (service interface)"

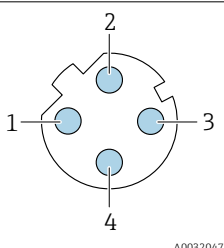
 <p style="text-align: center; font-size: small;">A0032047</p>	Pin	Assignment		Coding	Plug/socket
	1	+	Tx	D	Socket
	2	+	Rx		
	3	-	Tx		
4	-	Rx			

- i** Recommended plug:
- Binder, series 825, part no. 99 3729 810 04
 - Phoenix, part no. 1543223 SACC-M12MSD-4Q

Supply voltage

Order code for "Power supply"	Terminal voltage		Frequency range
Option D	DC 24 V	±20%	-
Option E	AC 100 to 240 V	-15 to 10%	50/60 Hz
Option I	DC 24 V	±20%	-
	AC 100 to 240 V	-15 to 10%	50/60 Hz

Power consumption

Transmitter

Max. 10 W (active power)

switch-on current	Max. 36 A (<5 ms) as per NAMUR Recommendation NE 21
--------------------------	---

Current consumption

Transmitter

- Max. 400 mA (24 V)
- Max. 200 mA (110 V, 50/60 Hz; 230 V, 50/60 Hz)

Power supply failure

- Totalizers stop at the last value measured.
- Depending on the device version, the configuration is retained in the device memory or in the plug-in memory (HistoROM DAT).
- Error messages (incl. total operated hours) are stored.

Overcurrent protection element

The device must be operated with a dedicated circuit breaker, as it does not have an ON/OFF switch of its own.

- The circuit breaker must be easy to reach and labeled accordingly.
- Permitted nominal current of the circuit breaker: 2 A up to maximum 10 A.

Electrical connection

Connection of connecting cable: Proline 500 – digital

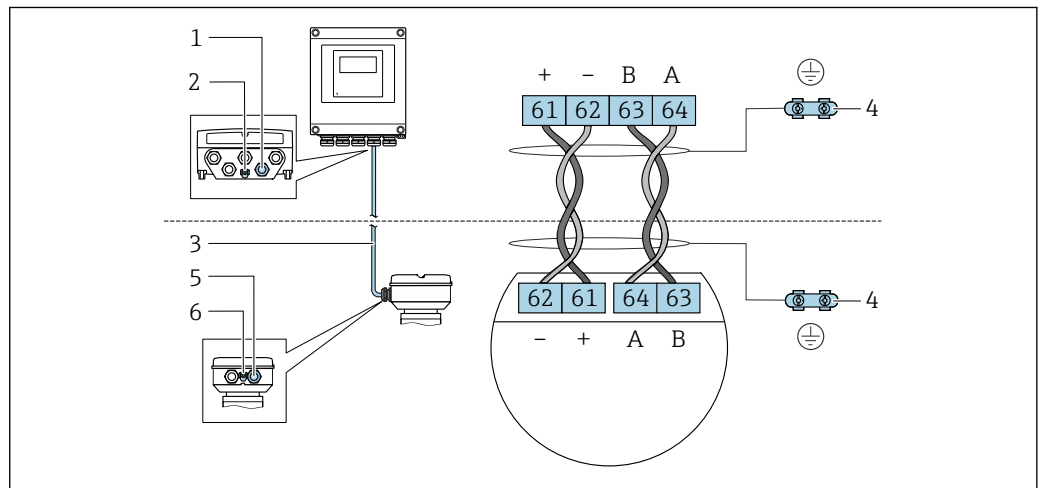

A0028198

- 1 Cable entry for cable on transmitter housing
- 2 Protective ground connection (PE)
- 3 Connecting cable ISEM communication
- 4 Grounding via ground connection; in the version with a device plug, grounding is ensured through the plug itself
- 5 Cable entry for cable or connection of device plug on sensor connection housing
- 6 Protective ground connection (PE)

Depending on the device version of the sensor connection housing, the connecting cable is connected via terminals or device plugs.

Sensor connection housing Order code for "Housing"	Connection to sensor connection housing via	Connection to transmitter housing via
Option A: aluminum coated	Terminals	Terminals
Option B: stainless	Terminals	Terminals
Option C: ultra-compact, hygienic, stainless	Device plug	Terminals

Pin assignment, device plug

Device plugs are only available for device version, order code for "Housing":

Option C: ultra-compact, hygienic, stainless

For connection to sensor connection housing.

Pin	Color ¹⁾	Assignment		Connection to terminal
		+	-	
1	Brown	+	Supply voltage	61
2	White	A	ISEM communication	64
3	Blue	B		63
4	Black	-	Supply voltage	62
5	-		-	-
Coding		Plug/socket		
A		Plug		

1) Cable colors of connecting cable

i A connecting cable with a device plug is optionally available.

Connection of the connecting cable: Proline 500

The connecting cable is connected via terminals.

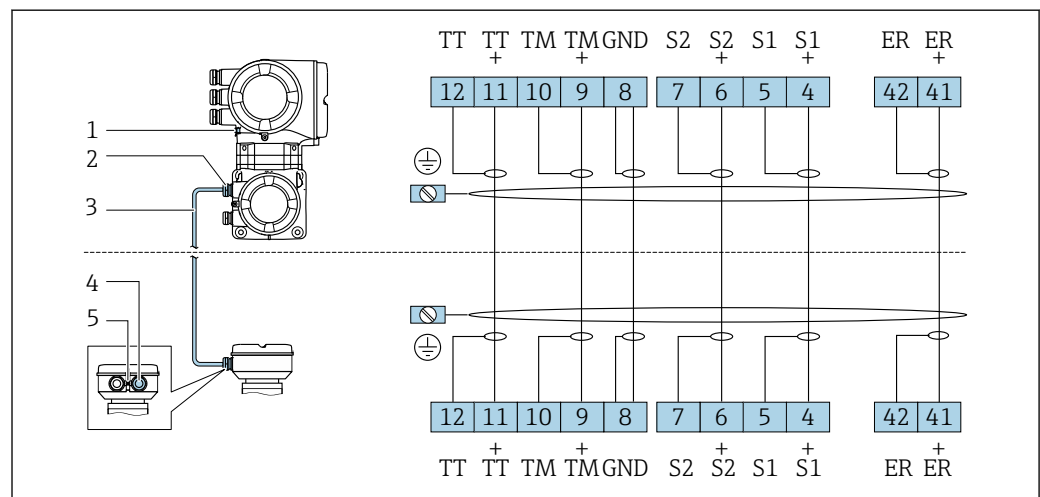

A0028197

- 1 Protective ground connection (PE)
- 2 Cable entry for connecting cable on transmitter connection housing
- 3 Connecting cable
- 4 Cable entry for connecting cable on sensor connection housing
- 5 Protective ground connection (PE)

Transmitter connection

- i** ■ Terminal assignment → 39
- Device plug pin assignment → 44

Transmitter connection: Proline 500 – digital

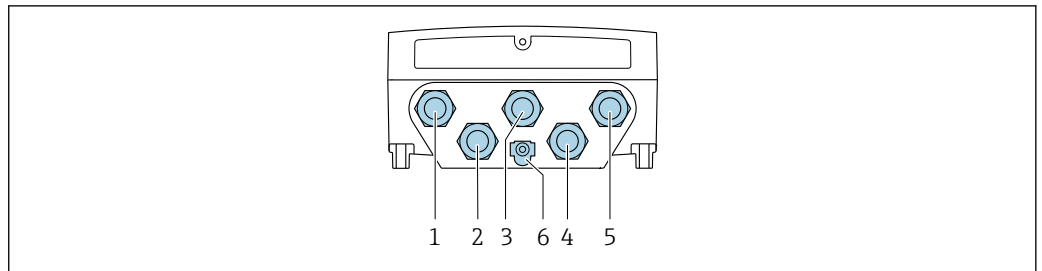

A0028200

- 1 Terminal connection for supply voltage
- 2 Terminal connection for signal transmission, input/output
- 3 Terminal connection for signal transmission, input/output
- 4 Terminal connection for connecting cable between sensor and transmitter
- 5 Terminal connection for signal transmission, input/output or terminal for network connection (DHCP client) via service interface (CDI-RJ45); optional: terminal connection for external WLAN antenna
- 6 Protective ground connection (PE)

i An adapter for the RJ45 to the M12 plug is optionally available:
 Order code for "Accessories", option **NB**: "Adapter RJ45 M12 (service interface)"
 The adapter connects the service interface (CDI-RJ45) to an M12 plug mounted in the cable entry. The connection to the service interface can be established via an M12 plug without opening the device.

i Network connection (DHCP client) via service interface (CDI-RJ45) → 116

Connecting the transmitter: Proline 500

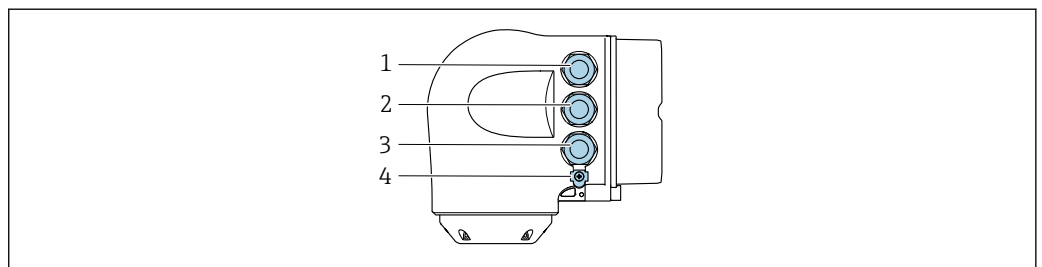

A0026781

- 1 Terminal connection for supply voltage
- 2 Terminal connection for signal transmission, input/output
- 3 Terminal connection for signal transmission, input/output or terminal for network connection (DHCP client) via service interface (CDI-RJ45); optional: terminal connection for external WLAN antenna
- 4 Protective ground connection (PE)

i An adapter for the RJ45 to the M12 plug is optionally available:
 Order code for "Accessories", option **NB**: "Adapter RJ45 M12 (service interface)"
 The adapter connects the service interface (CDI-RJ45) to an M12 plug mounted in the cable entry. The connection to the service interface can be established via an M12 plug without opening the device.

i Network connection (DHCP client) via service interface (CDI-RJ45) → 116

Connecting in a ring topology

Device versions with EtherNet/IP and PROFINET communication protocols can be integrated into a ring topology. The device is integrated via the terminal connection for signal transmission (output 1) and the connection to the service interface (CDI-RJ45).

 For detailed information on connecting transmitters with an Ex de approval, see separate document "Safety instructions" (XA) for the device.

 Integrating the transmitter into a ring topology:

- EtherNet/IP
- PROFINET

Transmitter: Proline 500 – digital

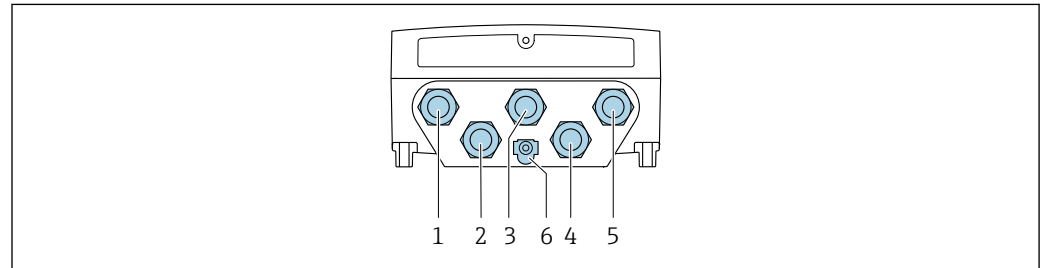

A0028200

- 1 Terminal connection for supply voltage
- 2 Terminal connection for signal transmission, input/output
- 2 Terminal connection for signal transmission: PROFINET or Ethernet/IP (RJ45 plug)
- 4 Terminal connection for connecting cable between sensor and transmitter
- 5 Connection to service interface (CDI-RJ45)
- 6 Protective ground connection (PE)

Transmitter: Proline 500

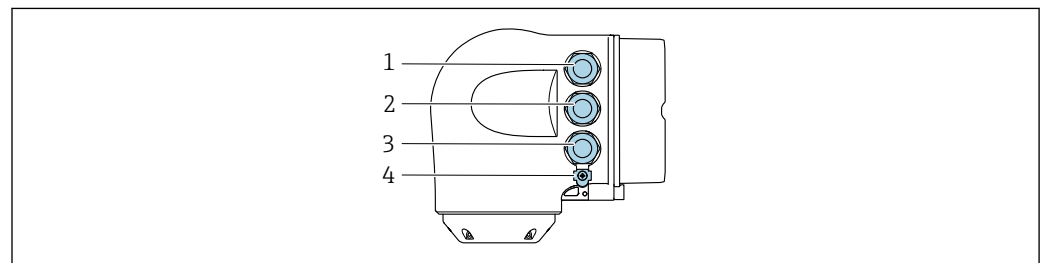

A0026781

- 1 Terminal connection for supply voltage
- 2 Terminal connection for signal transmission: PROFINET or Ethernet/IP (RJ45 plug)
- 3 Connection to service interface (CDI-RJ45)
- 4 Protective ground connection (PE)

 If the device has additional inputs/outputs, these are routed in parallel via the cable entry for connection to the service interface (CDI-RJ45).

Connection examples

Current output 4 to 20 mA (without HART)

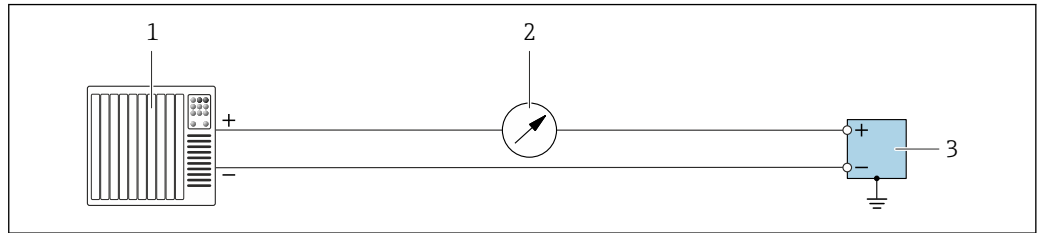

A0055851

2 Connection example for 4 to 20 mA current output (active)

- 1 Automation system with current input (e.g. PLC)
- 2 Optional additional display unit: Observe maximum load
- 3 Flowmeter with current output (active)

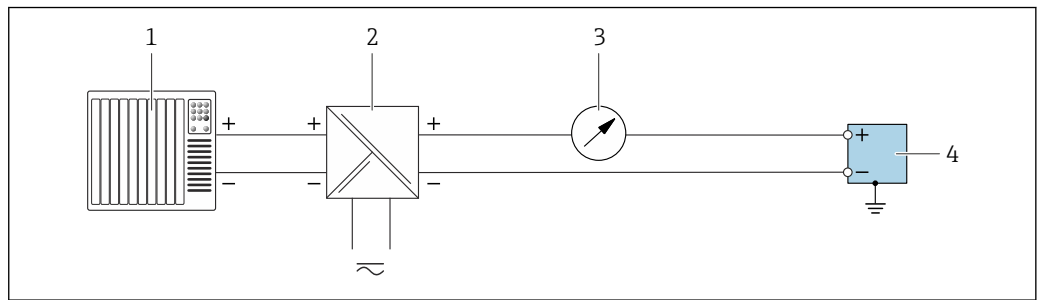

A0055852

3 Connection example for 4 to 20 mA current output (passive)

- 1 Automation system with current input (e.g. PLC)
- 2 Power supply
- 3 Optional additional display unit: Observe maximum load
- 4 Transmitter with current output (passive)

Current input 4 to 20 mA

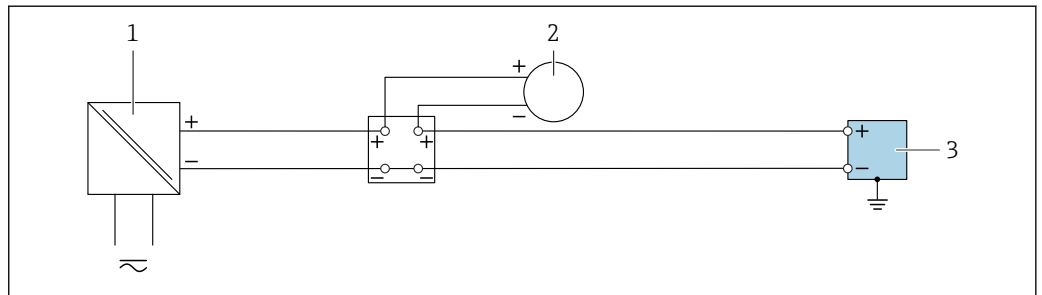

A0055853

4 Connection example for 4 to 20 mA current input

- 1 Power supply
- 2 External measuring instrument with 4 to 20 mA passive current output. e.g. pressure or temperature)
- 3 Transmitter with 4 to 20 mA current input

Pulse output/frequency output/switch output

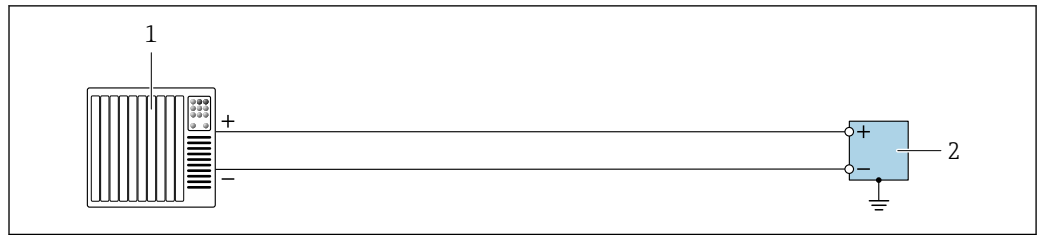

A0055856

5 Connection example for pulse output/frequency output/switch output (active)

- 1 Automation system with pulse input/frequency input/switch input (e.g. PLC)
- 2 Transmitter with pulse output/frequency output/switch output (active)

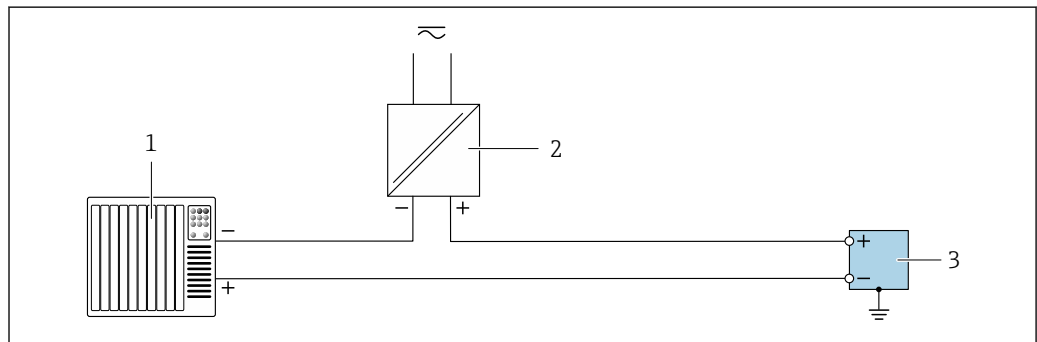

A0055855

6 Connection example for pulse output/frequency output/switch output (passive)

- 1 Automation system with pulse input/frequency input/switch input (e.g. PLC)
- 2 Power supply
- 3 Transmitter with pulse output/frequency output/switch output (passive)

Relay output

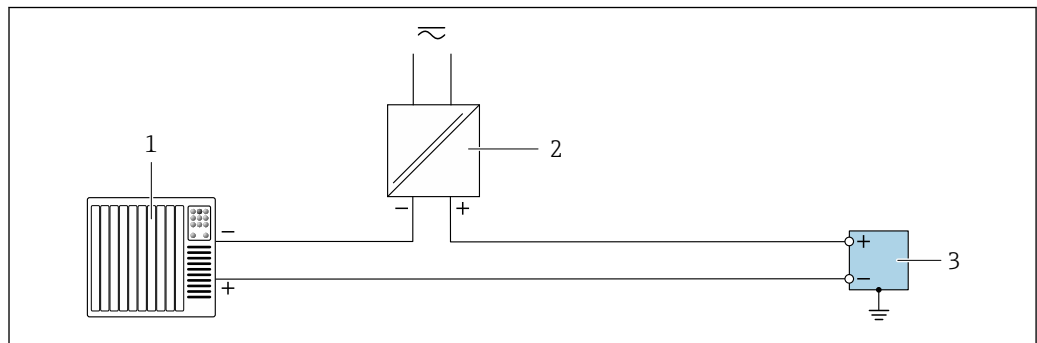

A0055859

7 Connection example for relay output

- 1 Automation system with switch input (e.g. PLC)
- 2 Power supply
- 3 Transmitter with relay output

Status input

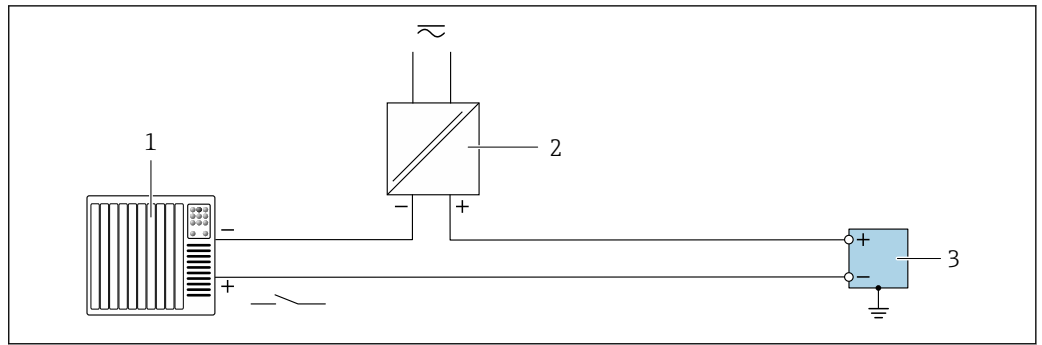

A0055860

8 Connection example for status input

- 1 Automation system with switch output passive e.g. PLC)
- 2 Power supply
- 3 Transmitter with status input

Current output 4 to 20 mA HART

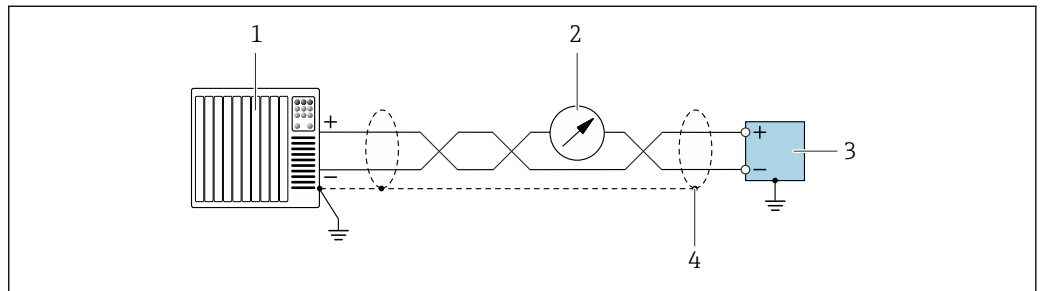

A0055862

9 Connection example for 4 to 20 mA current output with HART (active)

- 1 Automation system with 4 to 20 mA current input with HART (e.g. PLC)
- 2 Optional display unit: Note maximum load
- 3 Transmitter with 4 to 20 mA current output with HART (active)
- 4 Ground cable shield at one end. For installations in compliance with NAMUR NE 89, grounding of the cable shield on both sides is required.

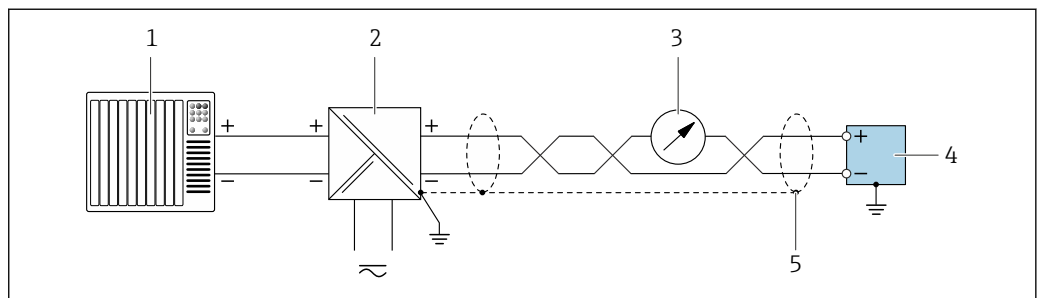

A0055861

10 Connection example for 4 to 20 mA current output with HART (passive)

- 1 Automation system with 4 to 20 mA current input with HART (e.g. PLC)
- 2 Power supply
- 3 Optional display unit: Note maximum load
- 4 Transmitter with 4 to 20 mA current output with HART (passive)
- 5 Ground cable shield at one end. For installations in compliance with NAMUR NE 89, grounding of the cable shield on both sides is required.

Modbus RS485

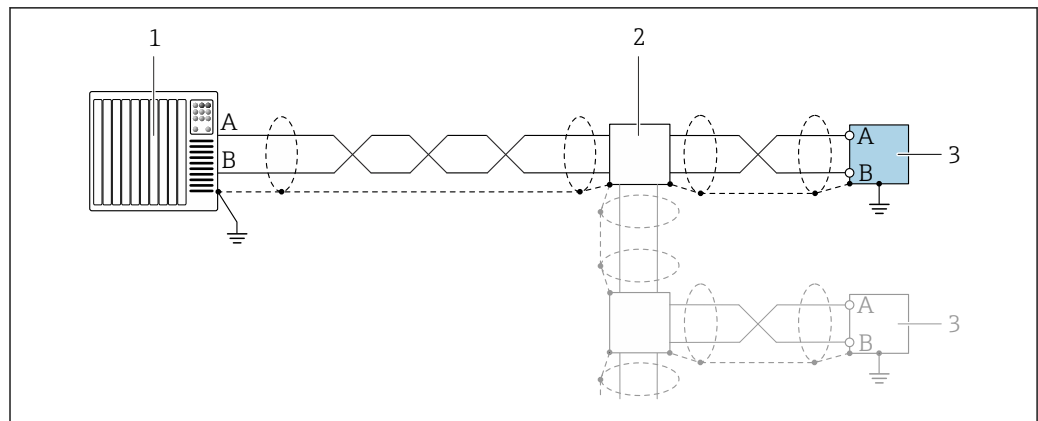

A0055863

11 Connection example for Modbus RS485

- 1 Automation system with Modbus master (e.g. PLC)
- 2 Optional distribution box
- 3 Transmitter with Modbus RS485

PROFIBUS PA

See <https://www.profibus.com> "PROFIBUS Installation Guidelines".

PROFIBUS DP

See <https://www.profibus.com> "PROFIBUS Installation Guidelines".

FOUNDATION Fieldbus

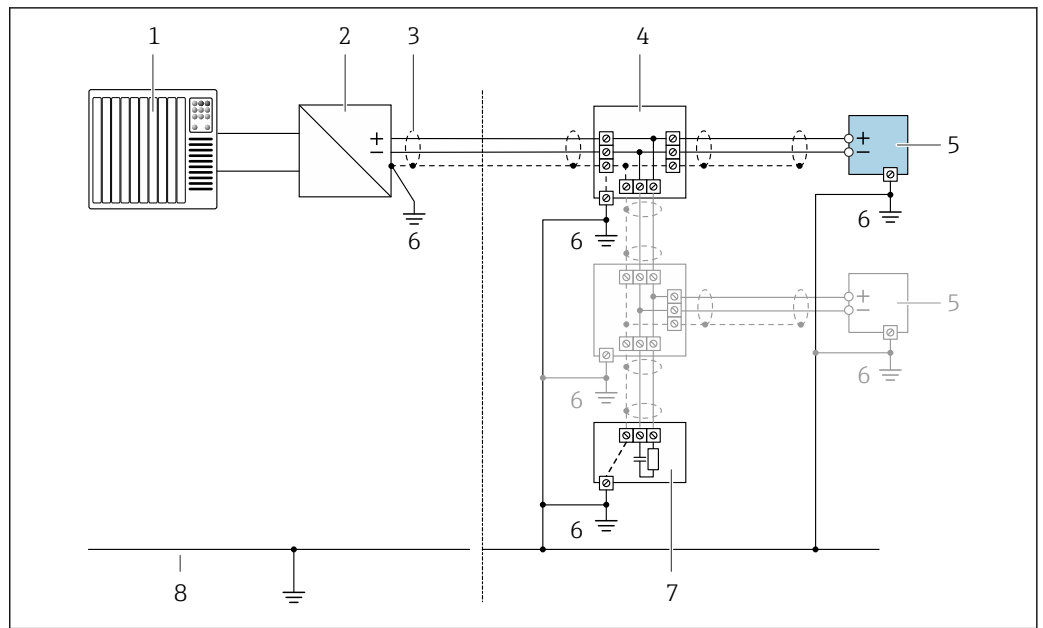

12 Connection example for FOUNDATION Fieldbus

- 1 Automation system (e.g. PLC)
- 2 Power Conditioner (FOUNDATION Fieldbus)
- 3 Cable shield provided at one end. The cable shield must be grounded at both ends to comply with EMC requirements; observe cable specifications
- 4 T-box
- 5 Measuring instrument
- 6 Local grounding
- 7 Bus terminator
- 8 Potential equalization conductor

PROFINET

See <https://www.profibus.com> "PROFINET Planning guideline".

EtherNet/IP

See <https://www.odva.org> "EtherNet/IP Media Planning & Installation Manual".

Ethernet-APL

See <https://www.profibus.com> "Ethernet-APL White Paper"

Potential equalization

Requirements

For potential equalization:

- Pay attention to in-house grounding concepts
- Take account of operating conditions like the pipe material and grounding
- Connect the medium, sensor and transmitter to the same electric potential
- Use a ground cable with a minimum cross-section of 6 mm² (10 AWG) and a cable lug for potential equalization connections

Terminals

Spring-loaded terminals: Suitable for strands and strands with ferrules.
Conductor cross-section 0.2 to 2.5 mm² (24 to 12 AWG).

Cable entries

- Cable gland: M20 × 1.5 with cable \varnothing 6 to 12 mm (0.24 to 0.47 in)
- Thread for cable entry:
 - NPT ½"
 - G ½"
 - M20
- Device plug for digital communication: M12
Only available for certain device versions →  41.
- Device plug for connecting cable: M12
A device plug is always used for the device version with the order code for "Sensor connection housing", option C "Ultra-compact, hygienic, stainless".

Cable specification**Permitted temperature range**

- The installation guidelines that apply in the country of installation must be observed.
- The cables must be suitable for the minimum and maximum temperatures to be expected.

Power supply cable (incl. conductor for the inner ground terminal)

Standard installation cable is sufficient.

Protective grounding cable for the outer ground terminal

Conductor cross-section < 6 mm² (10 AWG)

Larger cross-sections can be connected using a cable lug.

The grounding impedance must be less than 2 Ω.

Signal cable

4 to 20 mA current input

Standard installation cable is sufficient.

Pulse/frequency/switch output

Standard installation cable is sufficient.

Relay output

Standard installation cable is sufficient.

Status input

Standard installation cable is sufficient.

Current output 4 to 20 mA HART

Shielded twisted-pair cable.



See <https://www.fieldcommgroup.org> "HART PROTOCOL SPECIFICATIONS".

Modbus RS485

Shielded twisted-pair cable.



See <https://modbus.org> "MODBUS over Serial Line Specification and Implementation Guide".

PROFIBUS PA

Shielded twisted-pair cable. Cable type A is recommended.



See <https://www.profibus.com> "PROFIBUS Installation Guidelines".

PROFIBUS DP

Shielded twisted-pair cable. Cable type A is recommended.



See <https://www.profibus.com> "PROFIBUS Installation Guidelines".

PROFINET

Only PROFINET cables.



See <https://www.profibus.com> "PROFINET Planning guideline".

EtherNet/IP

Twisted-pair Ethernet CAT 5 or better.



See <https://www.odva.org> "EtherNet/IP Media Planning & Installation Manual".

Ethernet-APL

Shielded twisted-pair cable. Cable type A is recommended.



See <https://www.profibus.com> Ethernet-APL White Paper "

FOUNDATION Fieldbus

Twisted, shielded two-wire cable.



For further information on planning and installing FOUNDATION Fieldbus networks see:

- Operating Instructions for "FOUNDATION Fieldbus Overview" (BA00013S)
- FOUNDATION Fieldbus Guideline
- IEC 61158-2 (MBP)

Choice of connecting cable between the transmitter and sensor

Depends on the type of transmitter and the installation zones

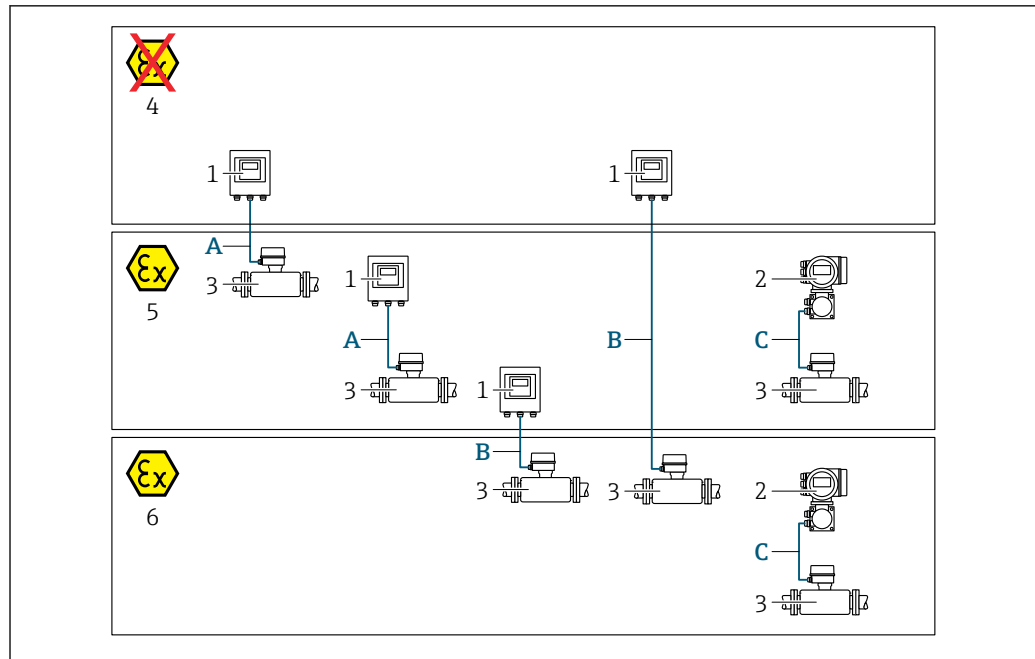

A0032476

- 1 Proline 500 digital transmitter
- 2 Proline 500 transmitter
- 3 Sensor Promass
- 4 Non-hazardous area
- 5 Hazardous area: Zone 2; Class I, Division 2
- 6 Hazardous area: Zone 1; Class I, Division 1
- A Standard cable to 500 digital transmitter → 58
Transmitter installed in the non-hazardous area or hazardous area: Zone 2; Class I, Division 2/sensor installed in the hazardous area: Zone 2; Class I, Division 2
- B Standard cable to 500 digital transmitter → 59
Transmitter installed in the hazardous area: Zone 2; Class I, Division 2/sensor installed in the hazardous area: Zone 1; Class I, Division 1
- C Signal cable to 500 transmitter → 61
Transmitter and sensor installed in the hazardous area: Zone 2; Class I, Division 2 or Zone 1; Class I, Division 1

A: Connecting cable between sensor and transmitter: Proline 500 – digital

Standard cable

A standard cable with the following specifications can be used as the connecting cable.

Design	4 cores (2 pairs); uninsulated stranded CU wires; pair-stranded with common shield
Shield	Tin-plated copper braid, optical cover ≥ 85 %
Loop resistance	Power supply line (+, -): maximum 10 Ω
Cable length	Maximum 300 m (900 ft), see the following table.
Device plug, side 1	M12 socket, 5-pin, A-coded.
Device plug, side 2	M12 plug, 5-pin, A-coded.
Pins 1+2	Connected cores as twisted pair.
Pins 3+4	Connected cores as twisted pair.

Cross-section	Cable length [max.]
0.34 mm ² (AWG 22)	80 m (240 ft)
0.50 mm ² (AWG 20)	120 m (360 ft)
0.75 mm ² (AWG 18)	180 m (540 ft)

Cross-section	Cable length [max.]
1.00 mm ² (AWG 17)	240 m (720 ft)
1.50 mm ² (AWG 15)	300 m (900 ft)

Optionally available connecting cable

Design	2 × 2 × 0.34 mm ² (AWG 22) PVC cable ¹⁾ with common shield (2 pairs, uninsulated stranded CU wires; pair-stranded)
Flame resistance	According to DIN EN 60332-1-2
Oil resistance	According to DIN EN 60811-2-1
Shield	Tin-plated copper braid, optical cover ≥ 85 %
Continuous operating temperature	When mounted in a fixed position: -50 to +105 °C (-58 to +221 °F); when cable can move freely: -25 to +105 °C (-13 to +221 °F)
Available cable length	Fixed: 20 m (60 ft); variable: up to maximum 50 m (150 ft)

1) UV radiation can impair the cable outer sheath. Protect the cable from direct sunshine where possible.

B: Connecting cable between sensor and transmitter: Proline 500 - digital

Standard cable

A standard cable with the following specifications can be used as the connecting cable.

Design	4, 6, 8 cores (2, 3, 4 pairs); uninsulated stranded CU wires; pair-stranded with common shield
Shielding	Tin-plated copper braid, optical cover ≥ 85 %
Capacitance C	Maximum 760 nF IIC, maximum 4.2 µF IIB
Inductance L	Maximum 26 µH IIC, maximum 104 µH IIB
Inductance/resistance ratio (L/R)	Maximum 8.9 µH/Ω IIC, maximum 35.6 µH/Ω IIB (e.g. according to IEC 60079-25)
Loop resistance	Power supply line (+, -): maximum 5 Ω
Cable length	Maximum 150 m (450 ft), see the following table.

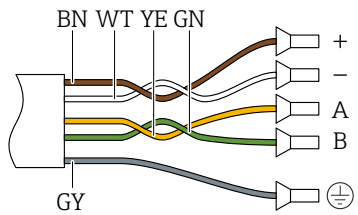
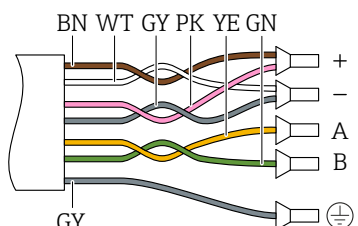
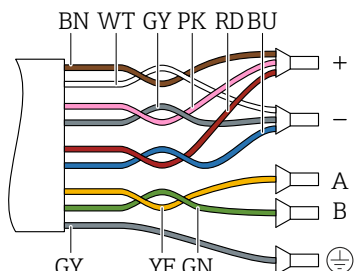
Cross-section	Cable length [max.]	Termination
2 x 2 x 0.50 mm ² (AWG 20)	50 m (150 ft)	2 x 2 x 0.50 mm ² (AWG 20)  <ul style="list-style-type: none"> ■ +, - = 0.5 mm² ■ A, B = 0.5 mm²
3 x 2 x 0.50 mm ² (AWG 20)	100 m (300 ft)	3 x 2 x 0.50 mm ² (AWG 20)  <ul style="list-style-type: none"> ■ +, - = 1.0 mm² ■ A, B = 0.5 mm²
4 x 2 x 0.50 mm ² (AWG 20)	150 m (450 ft)	4 x 2 x 0.50 mm ² (AWG 20)  <ul style="list-style-type: none"> ■ +, - = 1.5 mm² ■ A, B = 0.5 mm²

Optionally available connecting cable

Connecting cable for	Zone 1; Class I, Division 1
Standard cable	2 × 2 × 0.5 mm ² (AWG 20) PVC cable ¹⁾ with common shield (2 pairs, pair-stranded)
Flame resistance	According to DIN EN 60332-1-2
Oil-resistance	According to DIN EN 60811-2-1
Shielding	Tin-plated copper braid, optical cover ≥ 85 %
Operating temperature	When mounted in a fixed position: -50 to +105 °C (-58 to +221 °F); when cable can move freely: -25 to +105 °C (-13 to +221 °F)
Available cable length	Fixed: 20 m (60 ft); variable: up to maximum 50 m (150 ft)

1) UV radiation can impair the cable outer sheath. Protect the cable from direct sunshine where possible.

C: Connecting cable between sensor and transmitter: Proline 500

Design	6 × 0.38 mm ² PVC cable ¹⁾ with individual shielded cores and common copper shield
Conductor resistance	≤ 50 Ω/km (0.015 Ω/ft)
Capacitance: core/shield	≤ 420 pF/m (128 pF/ft)
Cable length (max.)	20 m (60 ft)
Cable lengths (available for order)	5 m (15 ft), 10 m (30 ft), 20 m (60 ft)
Cable diameter	11 mm (0.43 in) ± 0.5 mm (0.02 in)
Continuous operating temperature	Max. 105 °C (221 °F)

1) UV radiation can impair the cable outer sheath. Protect the cable from direct sunshine where possible.

Overvoltage protection

Mains voltage fluctuations	→ ⓘ 46
Overvoltage category	Overvoltage category II
Short-term, temporary overvoltage	Between cable and ground up to 1200 V, for max. 5 s
Long-term, temporary overvoltage	Between cable and ground up to 500 V

Performance characteristics

Reference operating conditions

- Error limits based on ISO 11631
 - Water
 - +15 to +45 °C (+59 to +113 °F)
 - 2 to 6 bar (29 to 87 psi)
 - Data as indicated in the calibration protocol
 - Accuracy based on accredited calibration rigs according to ISO 17025
-  To obtain measured errors, use the *Applicator* sizing tool → ⓘ 130

Maximum measurement error

o.r. = of reading; 1 g/cm³ = 1 kg/l; T = medium temperature

Base accuracy

 Design fundamentals → ⓘ 64

Mass flow and volume flow (liquids)

±0.15 % o.r.
 ±0.10 % o.r. (order code for "Calibration flow", option A, B, C)

Mass flow (gases)

±0.50 % o.r.

Density (liquids)

Under reference conditions [g/cm ³]	Standard density calibration [g/cm ³]
±0.0005	±0.002

Temperature

±0.5 °C ± 0.005 · T °C (±0.9 °F ± 0.003 · (T - 32) °F)

Zero point stability

DN		Zero point stability	
[mm]	[in]	[kg/h]	[lb/min]
8	$\frac{3}{8}$	0.20	0.007
15	$\frac{1}{2}$	0.65	0.024
25	1	1.80	0.066
40	$1\frac{1}{2}$	4.50	0.165
50	2	7.0	0.257
80	3	18.0	0.6615

Flow values

Flow values as turndown parameters depending on nominal diameter.

SI units

DN [mm]	1:1	1:10	1:20	1:50	1:100	1:500
	[kg/h]	[kg/h]	[kg/h]	[kg/h]	[kg/h]	[kg/h]
8	2 000	200	100	40	20	4
15	6 500	650	325	130	65	13
25	18 000	1 800	900	360	180	36
40	45 000	4 500	2 250	900	450	90
50	70 000	7 000	3 500	1 400	700	140
80	180 000	18 000	9 000	3 600	1 800	360

US units

DN [inch]	1:1	1:10	1:20	1:50	1:100	1:500
	[lb/min]	[lb/min]	[lb/min]	[lb/min]	[lb/min]	[lb/min]
$\frac{3}{8}$	73.50	7.350	3.675	1.470	0.735	0.147
$\frac{1}{2}$	238.9	23.89	11.95	4.778	2.389	0.478
1	661.5	66.15	33.08	13.23	6.615	1.323
$1\frac{1}{2}$	1 654	165.4	82.70	33.08	16.54	3.308
2	2 573	257.3	128.7	51.46	25.73	5.146
3	6 615	661.5	330.8	132.3	66.15	13.23

Accuracy of outputs

The outputs have the following base accuracy specifications:

Current output

Accuracy	±5 µA
-----------------	-------

Pulse/frequency output

o.r. = of reading

Accuracy	Max. ±50 ppm o.r. (over the entire ambient temperature range)
-----------------	---

Repeatability

o.r. = of reading; 1 g/cm³ = 1 kg/l; T = medium temperature

Base repeatability

 Design fundamentals →  64

Mass flow and volume flow (liquids)

±0.075 % o.r.
 ±0.05 % o.r. (calibration option, for mass flow)

Mass flow (gases)

±0.25 % o.r. (up to a Mach number of 0.2)

Density (liquids)

±0.00025 g/cm³

Temperature

±0.25 °C ± 0.0025 · T °C (±0.45 °F ± 0.0015 · (T-32) °F)

Response time

The response time depends on the configuration (damping).

Influence of ambient temperature

Current output

Temperature coefficient	Max. 1 µA/°C
--------------------------------	--------------

Pulse/frequency output

Temperature coefficient	No additional effect. Included in accuracy.
--------------------------------	---

Influence of medium temperature

Mass flow

o.f.s. = of full scale value

If there is a difference between the temperature during zero adjustment and the process temperature, the additional measurement error of the sensors is typically ±0.0002 %o.f.s./°C (±0.0001 % o. f.s./°F).

The influence is reduced when the zero adjustment is performed at process temperature.

Density

If there is a difference between the density calibration temperature and the process temperature, the measurement error of the sensors is typically ±0.0001 g/cm³/°C (±0.00005 g/cm³/°F). Field density adjustment is possible.

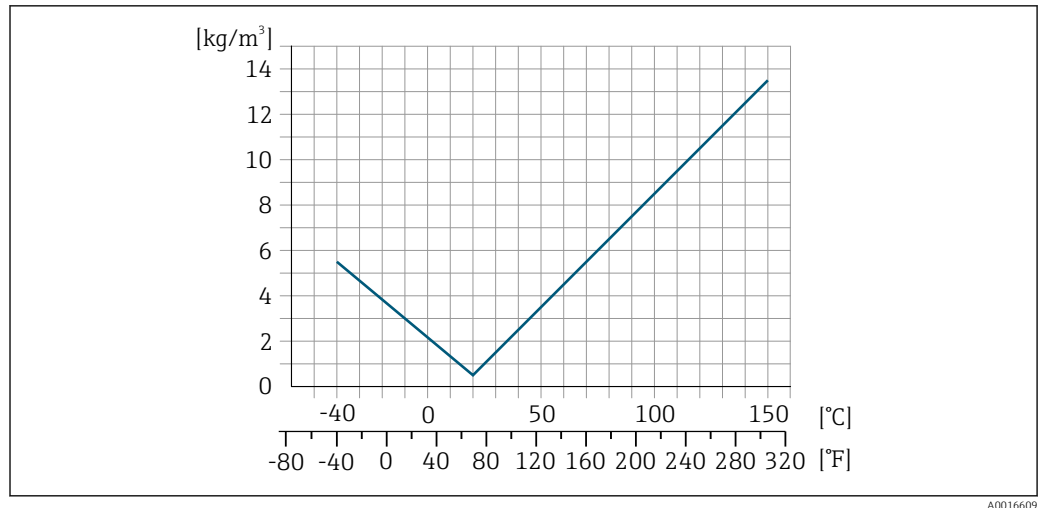

13 Field density adjustment, for example at +20 °C (+68 °F)

Temperature

$\pm 0.005 \cdot T \text{ } ^\circ\text{C}$ ($\pm 0.005 \cdot (T - 32) \text{ } ^\circ\text{F}$)

Influence of medium pressure

The following shows how the process pressure (gauge pressure) affects the accuracy of the mass flow.

o.r. = of reading



It is possible to compensate for the effect by:

- Reading in the current pressure measured value via the current input or a digital input.
- Specifying a fixed value for the pressure in the device parameters.



Operating Instructions → 132.

DN		[% o.r./bar]	[% o.r./psi]
[mm]	[in]		
8	3/8	no effect	
15	1/2	no effect	
25	1	no effect	
40	1 1/2	no effect	
50	2	-0.009	-0.0006
80	3	-0.020	-0.0014

Design fundamentals

o.r. = of reading, o.f.s. = of full scale value

BaseAccu = base accuracy in % o.r., BaseRepeat = base repeatability in % o.r.

MeasValue = measured value; ZeroPoint = zero point stability

Calculation of the maximum measured error as a function of the flow rate

Flow rate	Maximum measured error in % o.r.
$\geq \frac{\text{ZeroPoint}}{\text{BaseAccu}} \cdot 100$ <small>A0021332</small>	$\pm \text{BaseAccu}$ <small>A0021339</small>
$< \frac{\text{ZeroPoint}}{\text{BaseAccu}} \cdot 100$ <small>A0021333</small>	$\pm \frac{\text{ZeroPoint}}{\text{MeasValue}} \cdot 100$ <small>A0021334</small>

Calculation of the maximum repeatability as a function of the flow rate

Flow rate	Maximum repeatability in % o.r.
$\geq \frac{1/2 \cdot \text{ZeroPoint}}{\text{BaseRepeat}} \cdot 100$ <small>A0021335</small>	$\pm \text{BaseRepeat}$ <small>A0021340</small>
$< \frac{1/2 \cdot \text{ZeroPoint}}{\text{BaseRepeat}} \cdot 100$ <small>A0021336</small>	$\pm 1/2 \cdot \frac{\text{ZeroPoint}}{\text{MeasValue}} \cdot 100$ <small>A0021337</small>

Example of maximum measurement error

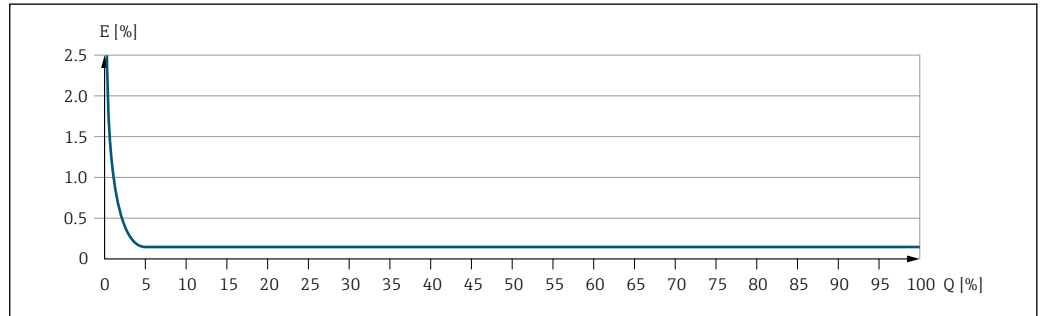

E Maximum measurement error in % o.r. (example)
 Q Flow rate in % of maximum full scale value

Installation

Mounting location

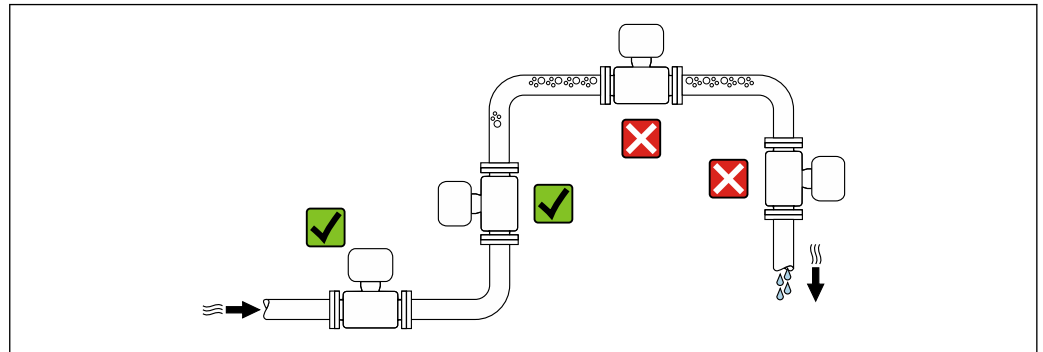

To avoid measurement errors caused by gas bubble formation in the measuring tube, avoid the following installation locations in the pipe:

- Highest point of a pipeline
- Directly upstream of a free pipe outlet in a down pipe

Installation in down pipes

However, the following installation suggestion allows for installation in an open vertical pipeline. Pipe restrictions or the use of an orifice with a smaller cross-section than the nominal diameter prevent the sensor running empty while measurement is in progress.

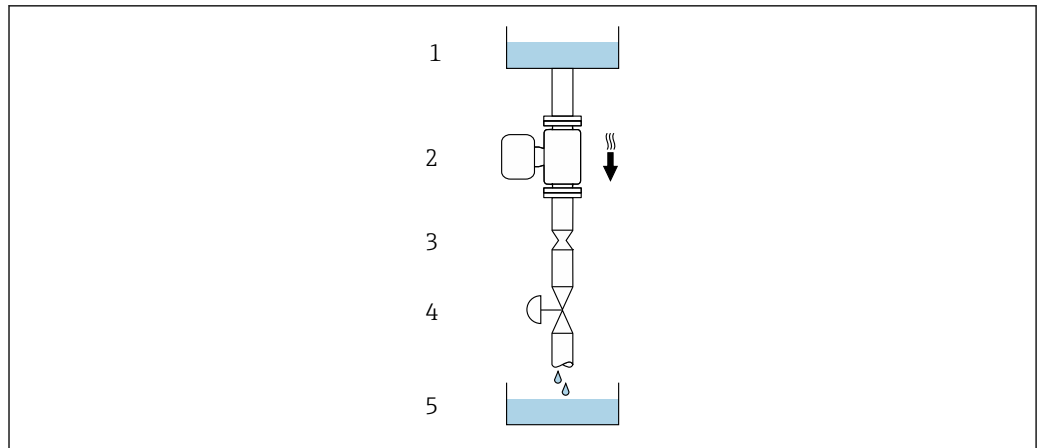

A0028773

14 Installation in a down pipe (e.g. for batching applications)

- 1 Supply tank
- 2 Sensor
- 3 Orifice plate, pipe restriction
- 4 Valve
- 5 Filling container

DN/NPS		Ø orifice plate, pipe restriction	
[mm]	[in]	[mm]	[in]
8	3/8	6	0.24
15	1/2	10	0.40
25	1	14	0.55
40	1 1/2	22	0.87
50	2	28	1.10
80	3	50	1.97

Orientation

The direction of the arrow on the sensor nameplate helps you to install the sensor according to the flow direction (direction of medium flow through the piping).

Orientation			Recommendation
A	Vertical orientation	 A0015591	☑☑ ¹⁾
B	Horizontal orientation, transmitter at top	 A0015589	☑☑ ²⁾ Exception: → ☑ 15, ☑ 67
C	Horizontal orientation, transmitter at bottom	 A0015590	☑☑ ³⁾ Exception: → ☑ 15, ☑ 67
D	Horizontal orientation, transmitter at side	 A0015592	☒

- 1) This orientation is recommended to ensure self-draining.
- 2) Applications with low process temperatures may reduce the ambient temperature. To maintain the minimum ambient temperature for the transmitter, this orientation is recommended.
- 3) Applications with high process temperatures may increase the ambient temperature. To maintain the maximum ambient temperature for the transmitter, this orientation is recommended.

If a sensor is installed horizontally with a curved measuring tube, match the position of the sensor to the medium properties.

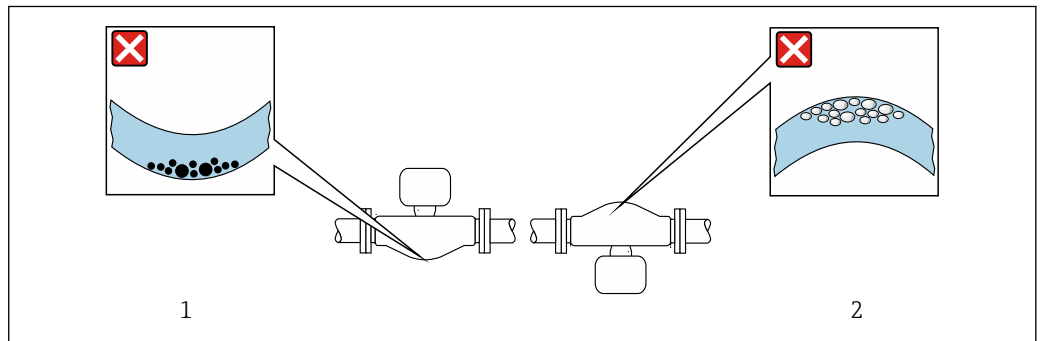

15 Orientation of sensor with curved measuring tube

- 1 Avoid this orientation for media with entrained solids: Risk of solids accumulating
- 2 Avoid this orientation for outgassing media: Risk of gas accumulating

Inlet and outlet runs

No special precautions need to be taken for fittings that create turbulence, such as valves, elbows or T-pieces, as long as no cavitation occurs → 78.

Installing the transmitter housing

Proline 500 – digital transmitter

Pipe mounting

Required tools:

- Open-ended wrench AF 10
- Torx screwdriver TX 25

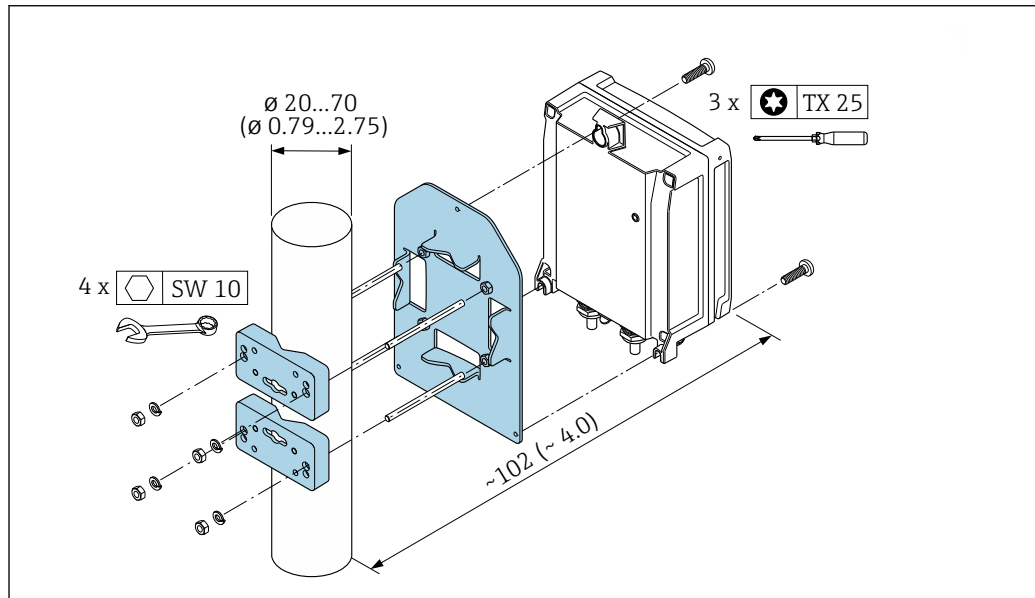

A0029051

16 Unit mm (in)

Wall mounting

Required tools:

Drill with drill bit $\varnothing 6.0$ mm

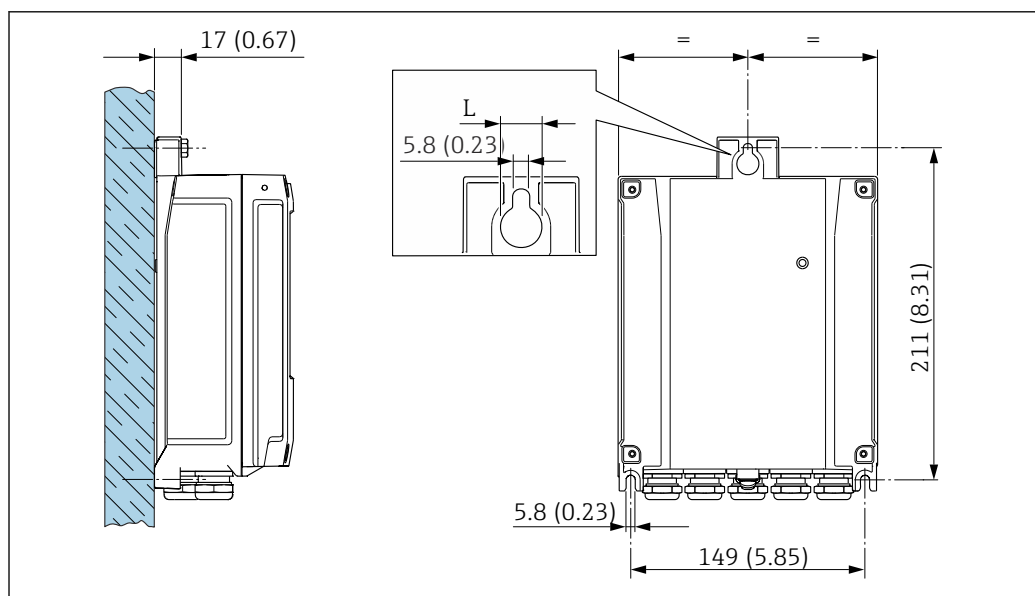

A0029054

17 Unit mm (in)

L Depends on order code for "Transmitter housing"

Order code for "Transmitter housing"

- Option A, aluminum, coated: L = 14 mm (0.55 in)
- Option D, polycarbonate: L = 13 mm (0.51 in)

Proline 500 transmitter

Pipe mounting

Required tools
Open-ended wrench AF 13

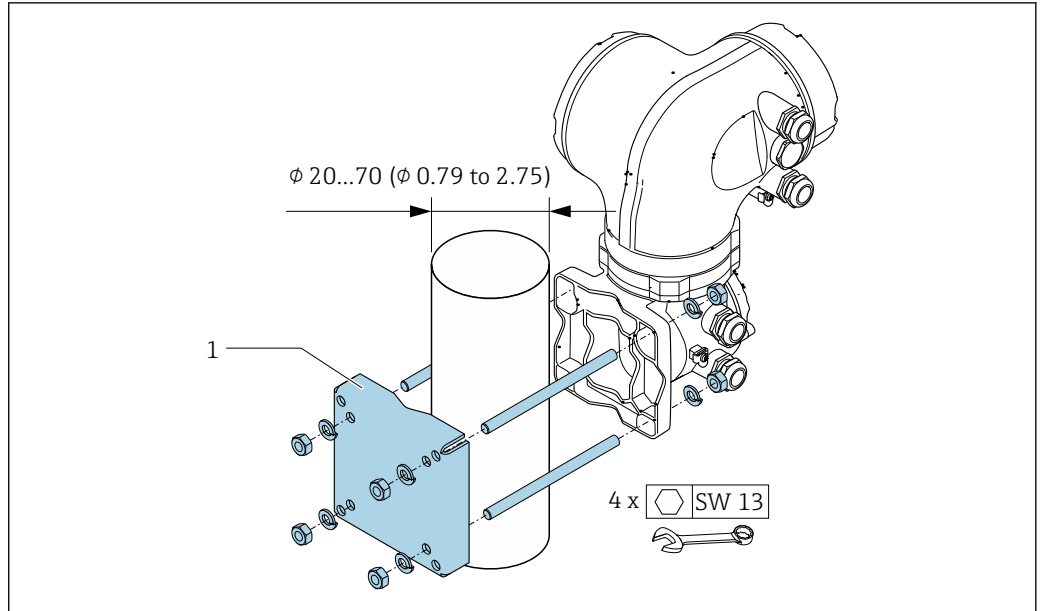

A0029057

18 Unit mm (in)

Wall mounting

Required tools
Drill with drill bit $\phi 6.0$ mm

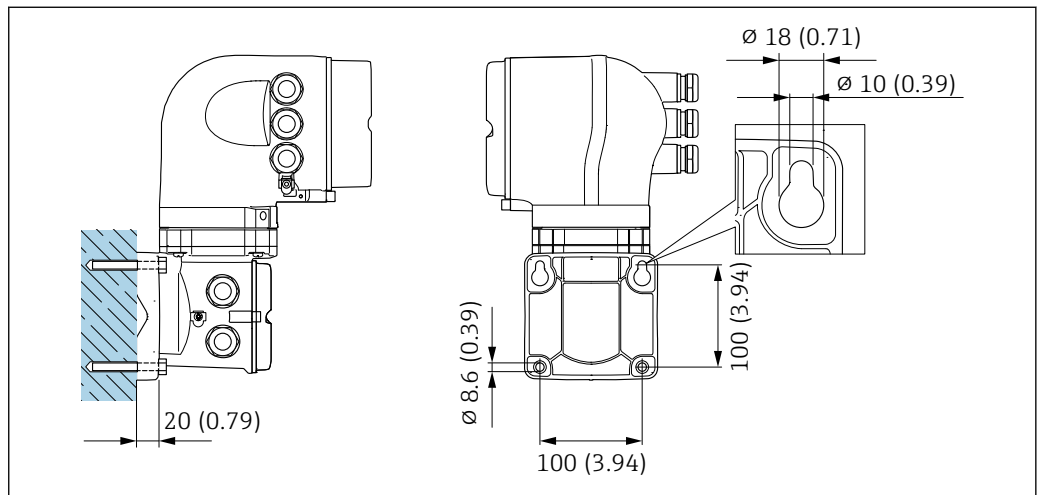

A0029068

19 Unit mm (in)

Special installation instructions

Drainability

When installed vertically, the measuring tubes can be drained completely and protected against buildup.

Hygienic compatibility

 When installing in hygienic applications, please refer to the information in the "Certificates and approvals/hygienic compatibility" section → 123

Rupture disk

Process-related information: → 78.

⚠ WARNING

Danger from medium escaping!

Medium escaping under pressure can cause injury or material damage.

- ▶ Take precautions to prevent danger to persons and damage if the rupture disk is actuated.
- ▶ Observe the information on the rupture disk sticker.
- ▶ Make sure that the function and operation of the rupture disk is not impeded through the installation of the device.
- ▶ Do not use a heating jacket.
- ▶ Do not remove or damage the rupture disk.

The position of the rupture disk is indicated on a sticker applied over it. If the rupture disk is triggered, the sticker is destroyed. The disk can therefore be visually monitored.

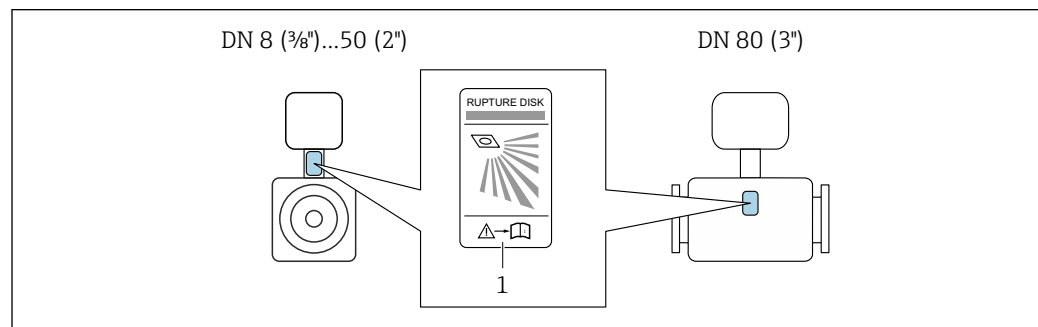

A0029956

1 Rupture disk label

Zero point verification and zero adjustment

All measuring instruments are calibrated in accordance with state-of-the-art technology. Calibration takes place under reference conditions → 61. Therefore, a zero adjustment in the field is generally not required.

Experience shows that zero adjustment is advisable only in special cases:

- To achieve maximum measurement accuracy even with low flow rates.
- Under extreme process or operating conditions (e.g. very high process temperatures or very high-viscosity media).
- For gas applications with low pressure.

For information on checking the zero point and performing a zero adjustment, see the Operating Instructions for the device.

i To achieve the highest possible measurement accuracy at low flow rates, the installation must protect the sensor from mechanical stress during operation.

Protective cover

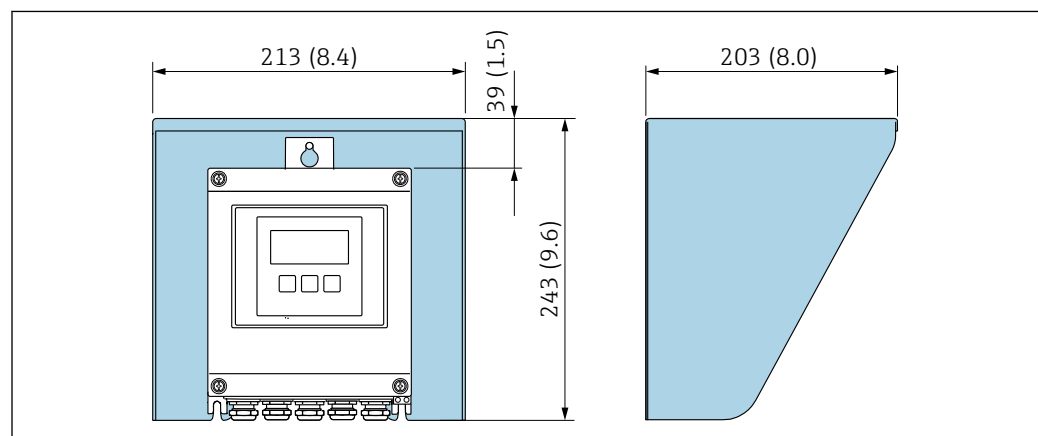

A0029552

20 Weather protection cover for Proline 500 – digital; unit mm (in)

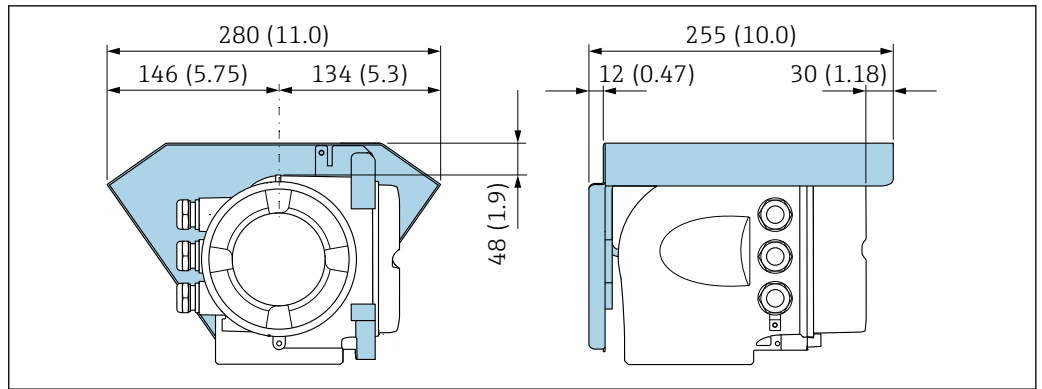

21 Weather protection cover for Proline 500 – unit mm (in)

Environment

Ambient temperature range	Measuring instrument	<ul style="list-style-type: none"> ■ -40 to +60 °C (-40 to +140 °F) ■ Order code for "Test, certificate", option JP: -50 to +60 °C (-58 to +140 °F)
	Readability of the local display	-20 to +60 °C (-4 to +140 °F) The readability of the display may be impaired at temperatures outside the temperature range.

i Dependency of ambient temperature on medium temperature → 72

- ▶ If operating outdoors:
Avoid direct sunlight, particularly in warm climatic regions.

i You can order a weather protection cover from Endress+Hauser. → 128.

Storage temperature	-50 to +80 °C (-58 to +176 °F)
Climate class	DIN EN 60068-2-38 (test Z/AD)
Relative humidity	The device is suitable for use in outdoor and indoor areas with a relative humidity of 4 to 95%.
Operating height	According to EN 61010-1 ≤ 2 000 m (6 562 ft)
Degree of protection	<p>Transmitter</p> <ul style="list-style-type: none"> ■ IP66/67, Type 4X enclosure, suitable for pollution degree 4 ■ When the housing is open: IP20, Type 1 enclosure, suitable for pollution degree 2 ■ Display module: IP20, Type 1 enclosure, suitable for pollution degree 2 <p>Sensor</p> <ul style="list-style-type: none"> ■ IP66/67, Type 4X enclosure, suitable for pollution degree 4 ■ When the housing is open: IP20, Type 1 enclosure, suitable for pollution degree 2 <p><i>Optional</i></p> <p>Order code for "Sensor options", option CM "IP69"</p> <p>External WLAN antenna</p> <p>IP66/67, type 4X enclosure</p>

Vibration resistance and shock resistance**Sinusoidal vibration similar to IEC 60068-2-6**

Sensor

- 2 to 8.4 Hz, 3.5 mm peak
- 8.4 to 2 000 Hz, 1 g peak

Transmitter

- 2 to 8.4 Hz, 7.5 mm peak
- 8.4 to 2 000 Hz, 2 g peak

Broadband random vibration similar to IEC 60068-2-64

Sensor

- 10 to 200 Hz, 0.003 g²/Hz
- 200 to 2 000 Hz, 0.001 g²/Hz
- Total: 1.54 g rms

Transmitter

- 10 to 200 Hz, 0.01 g²/Hz
- 200 to 2 000 Hz, 0.003 g²/Hz
- Total: 2.70 g rms

Half-sine shocks similar to IEC 60068-2-27

- Sensor
6 ms 30 g
- Transmitter
6 ms 50 g

Rough handling shocks similar to IEC 60068-2-31**Mechanical load**

Transmitter housing and sensor connection housing:

- Protect against mechanical effects, such as shock or impact
- Do not use as a ladder or climbing aid

Electromagnetic compatibility (EMC)

- As per IEC/EN 61326 and NAMUR Recommendation 21 (NE 21), NAMUR Recommendation 21 (NE 21) is fulfilled when the device is installed in accordance with NAMUR Recommendation 98 (NE 98).
- As per IEC/EN 61000-6-2 and IEC/EN 61000-6-4
- Device version with PROFIBUS DP: Complies with emission limits for industry as per EN 50170 Volume 2, IEC 61784



The following applies for PROFIBUS DP: If baud rates > 1.5 MBaud, an EMC cable entry must be used and the cable shield must continue as far as the terminal wherever possible.



Details are provided in the Declaration of Conformity.



This unit is not intended for use in residential environments and cannot guarantee adequate protection of the radio reception in such environments.

Process**Medium temperature range**

-40 to +150 °C (-40 to +302 °F)

Dependency of ambient temperature on medium temperature

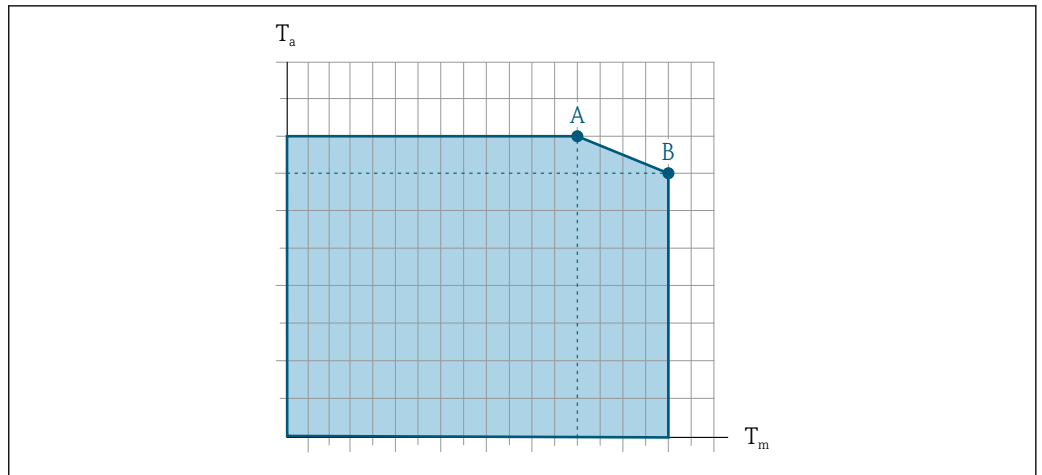

A0031121

22 Exemplary representation, values in the table below.

T_a Ambient temperature

T_m Medium temperature

A Maximum permitted medium temperature T_m at $T_{a\max} = 60\text{ °C}$ (140 °F); higher medium temperatures T_m require a reduction in the ambient temperature T_a

B Maximum permitted ambient temperature T_a for the maximum specified medium temperature T_m of the sensor



Values for devices that are used in the hazardous area:
Separate Ex documentation (XA) for the device → 132.

Version	Not insulated				Insulated			
	A		B		A		B	
	T_a	T_m	T_a	T_m	T_a	T_m	T_a	T_m
Promass E 500 – digital	60 °C (140 °F)	150 °C (302 °F)	–	–	60 °C (140 °F)	150 °C (302 °F)	–	–
Promass E 500								

Medium density 0 to 5 000 kg/m³ (0 to 312 lb/cf)

Pressure/temperature ratings The following pressure/temperature diagrams apply to all pressure-bearing parts of the device and not just the process connection. The diagrams show the maximum permissible medium pressure depending on the specific medium temperature.

Flange similar to EN 1092-1 (DIN 2501)

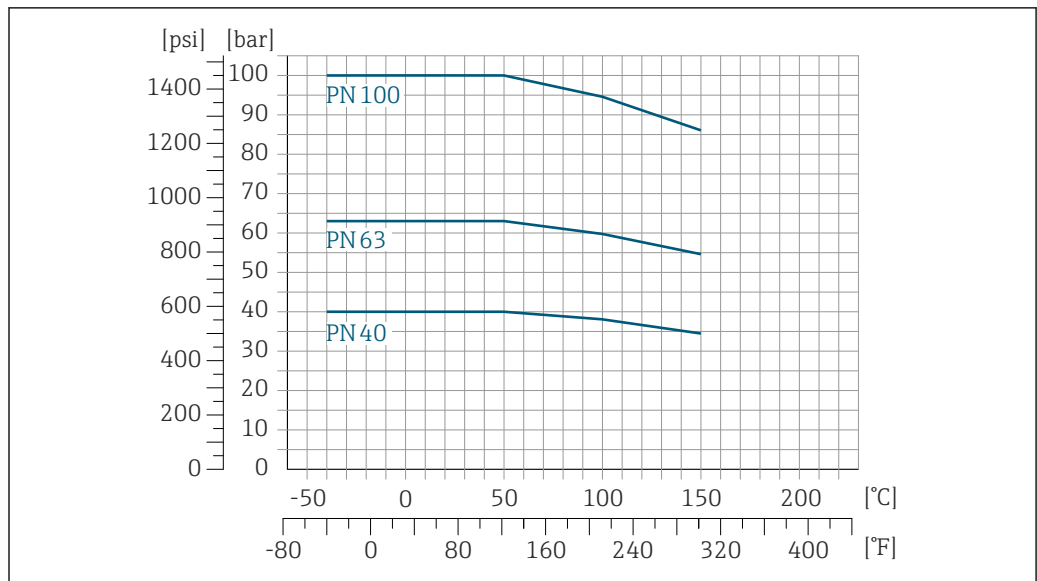

A0029832-EN

23 With flange material 1.4404 (F316/F316L)

Flange similar to ASME B16.5

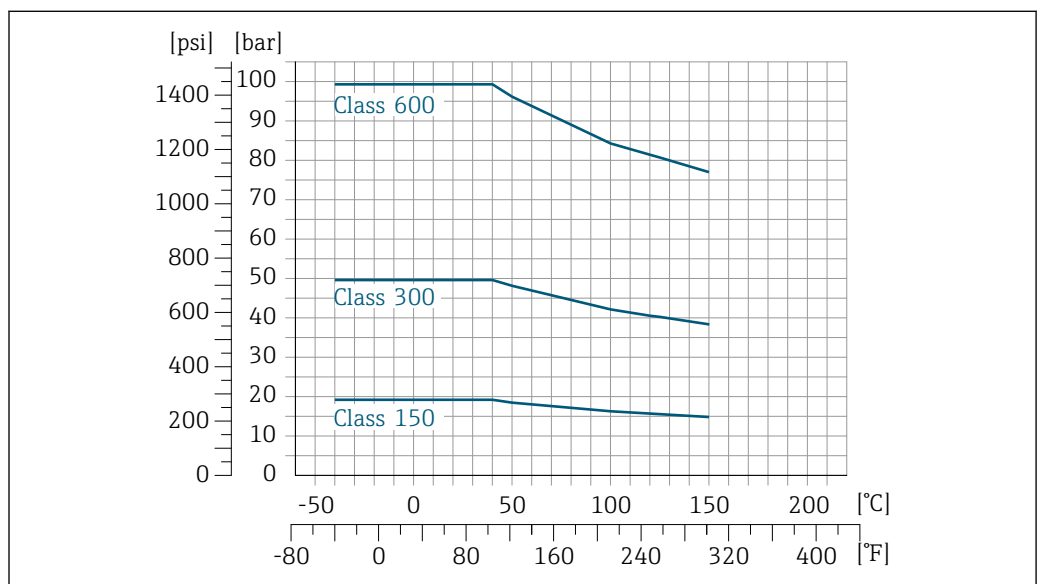

A0029833-EN

24 With flange material 1.4404 (F316/F316L)

Flange JIS B2220

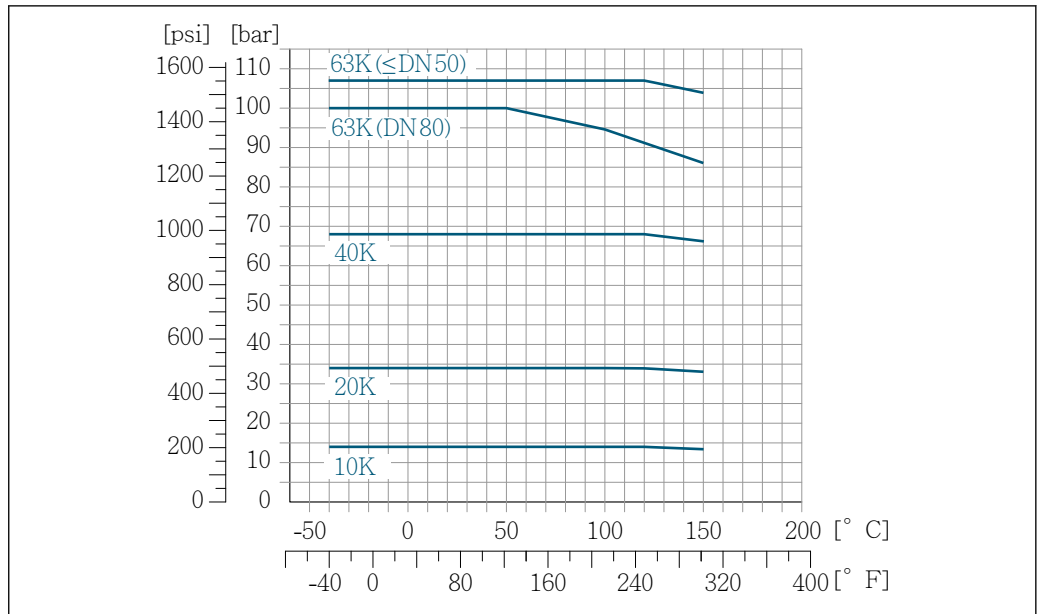

25 With flange material 1.4404 (F316/F316L)

Flange DIN 11864-2 Form A

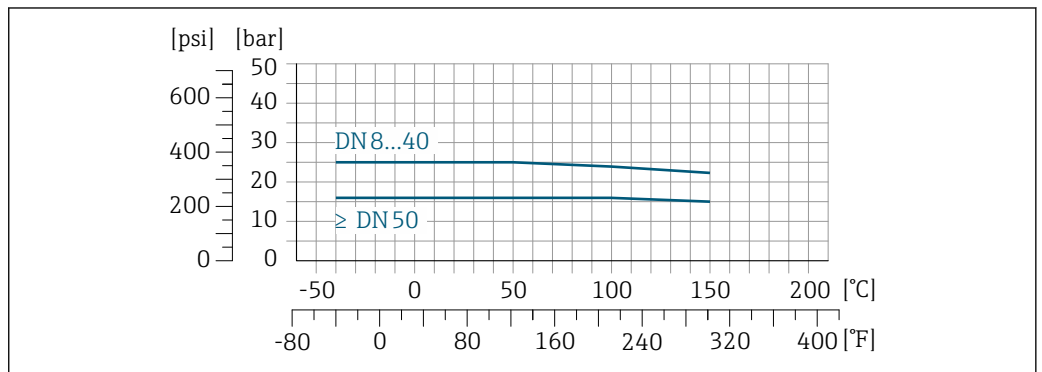

26 With flange material 1.4404 (316/316L)

Threaded adapter DIN 11851

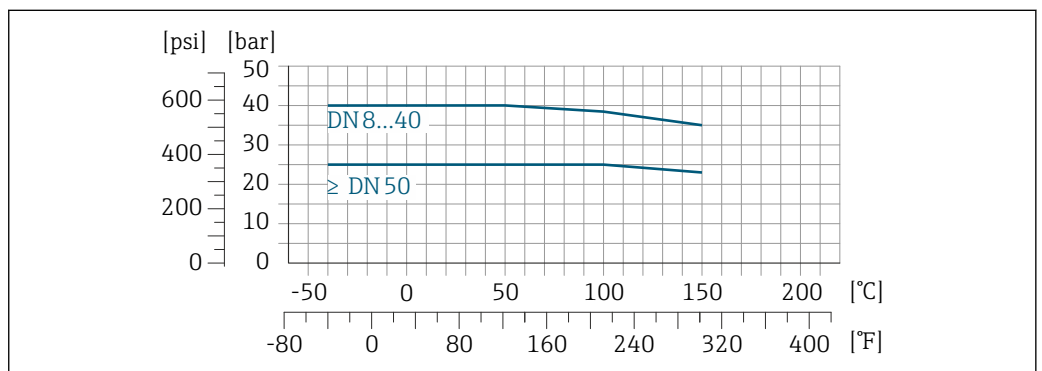

27 With connection material 1.4404 (316/316L)

DIN 11851 allows for applications up to +140 °C (+284 °F) if suitable sealing materials are used. Please take this into account when selecting seals and counterparts, as these components can limit the pressure and temperature range.

Threaded adapter DIN 11864-1 Form A

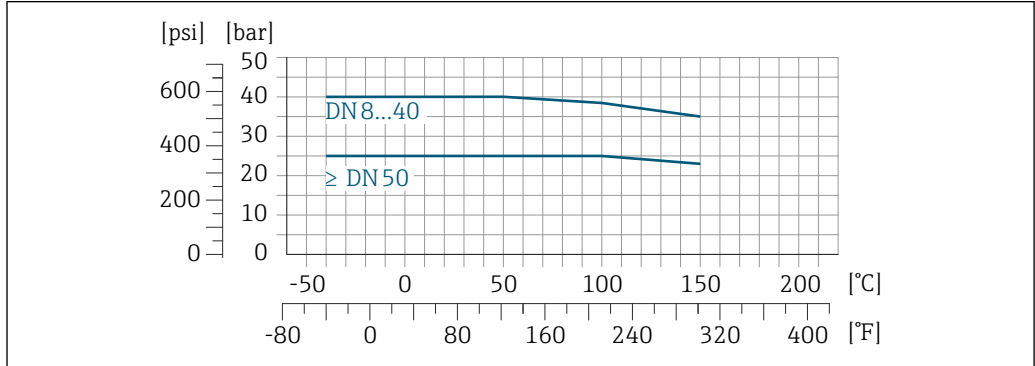

A0029848-EN

28 With connection material 1.4404 (316/316L)

Threaded adapter ISO 2853

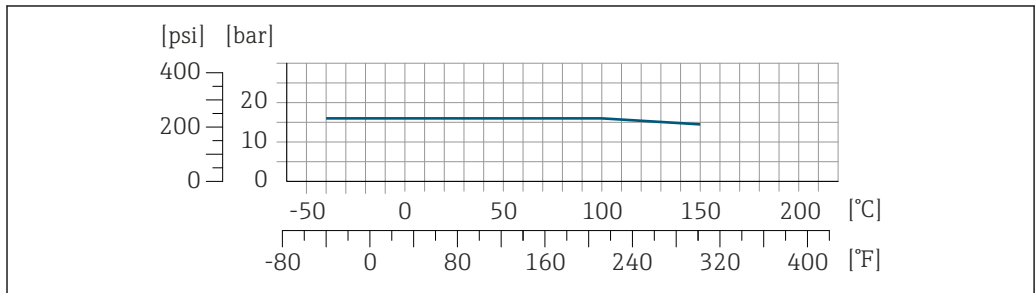

A0029853-EN

29 With connection material 1.4404 (316/316L)

Threaded adapter SMS 1145

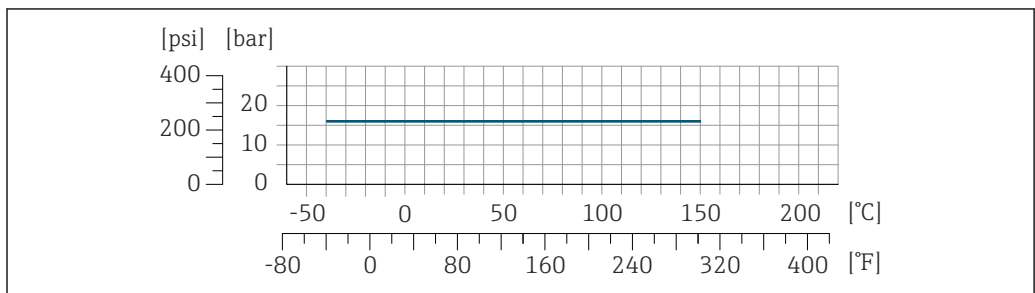

A0032218-EN

30 With connection material 1.4404 (316/316L)

VCO

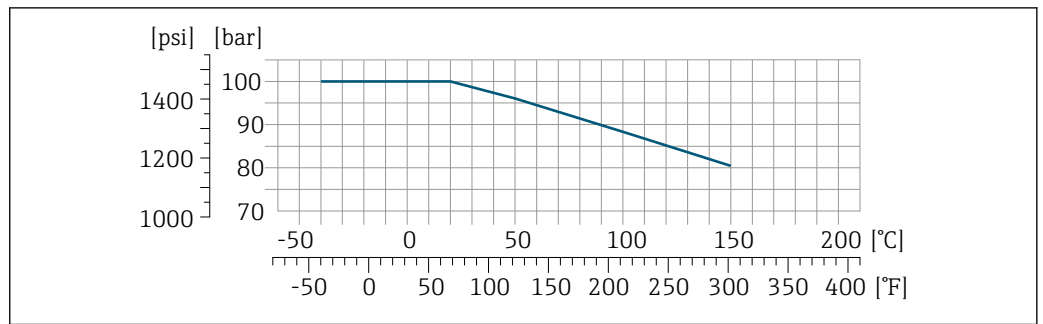

31 With connection material 1.4404 (316/316L)

A0029863-EN

Tri-Clamp

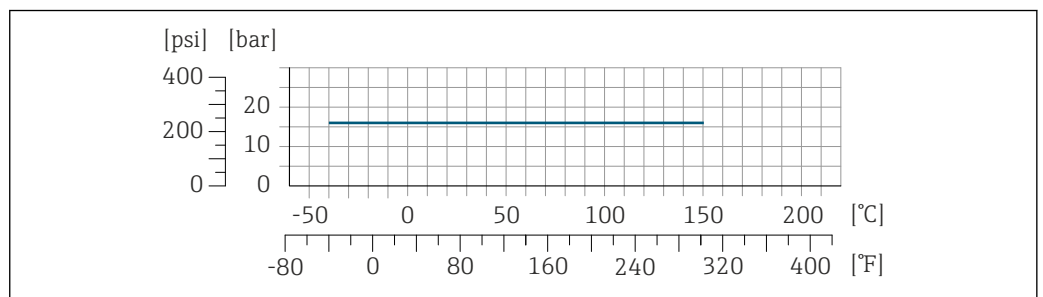

A0032218-EN

The clamp connections are suitable up to a maximum pressure of 16 bar (232 psi). Please observe the operating limits of the clamp and seal used as they can be over 16 bar (232 psi). The clamp and seal are not included in the scope of supply.

Sensor housing

The sensor housing is filled with dry nitrogen gas and protects the electronics and mechanics inside.

i If a measuring tube fails (e.g. due to process characteristics like corrosive or abrasive fluids), the fluid will initially be contained by the sensor housing.

In the event of a tube failure, the pressure level inside the sensor housing will rise according to the operating process pressure. If the user judges that the sensor housing burst pressure does not provide an adequate safety margin, the device can be fitted with a rupture disk. This prevents excessively high pressure from forming inside the sensor housing. Therefore, the use of a rupture disk is strongly recommended in applications involving high gas pressures, and particularly in applications in which the process pressure is greater than 2/3 of the sensor housing burst pressure.

Burst pressure of the sensor housing

If the device is fitted with a rupture disk (order code for "Sensor option", option CA "Rupture disk"), the rupture disk trigger pressure is decisive.

The sensor housing burst pressure refers to a typical internal pressure which is reached prior to mechanical failure of the sensor housing and which was determined during type testing. The corresponding type test declaration can be ordered with the device (order code for "Additional approval", option LN "Sensor housing burst pressure, type test").

DN		Sensor housing burst pressure	
[mm]	[in]	[bar]	[psi]
8	3/8	250	3 620
15	1/2	250	3 620
25	1	250	3 620
40	1 1/2	200	2 900

DN		Sensor housing burst pressure	
[mm]	[in]	[bar]	[psi]
50	2	180	2 610
80	3	120	1 740

For information on the dimensions: see the "Mechanical construction" section →  80

Rupture disk

To increase the level of safety, a device version with a rupture disk with a trigger pressure of 10 to 15 bar (145 to 217.5 psi) can be used (order code for "Sensor option", option CA "rupture disk").

The use of rupture disks cannot be combined with the separately available heating jacket.

Internal cleaning

- CIP cleaning
- SIP cleaning



Options

Oil- and grease-free version for wetted parts, without declaration



Order code for "Service", option HA ¹⁾

Flow limit



Select the nominal diameter by optimizing between the required flow range and permissible pressure loss.

 For an overview of the full scale values for the measuring range, see the "Measuring range" section →  12

- The minimum recommended full scale value is approx. 1/20 of the maximum full scale value
- For the most common applications, 20 to 50 % of the maximum full scale value can be considered ideal
- A low full scale value must be selected for abrasive media (such as liquids with entrained solids): flow velocity < 1 m/s (< 3 ft/s).
- For gas measurement the following rules apply:
 - The flow velocity in the measuring tubes should not exceed half the speed of sound (0.5 Mach)
 - The maximum mass flow depends on the density of the gas: formula

 To calculate the flow limit, use the *Applicator* sizing tool →  130

Pressure loss

 To calculate the pressure loss, use the *Applicator* sizing tool →  130

Static pressure

It is important that cavitation does not occur, or that gases entrained in the liquids do not outgas. This is prevented by means of a sufficiently high static pressure.

For this reason, the following mounting locations are recommended:

- At the lowest point in a vertical pipe
- Downstream from pumps (no danger of vacuum)

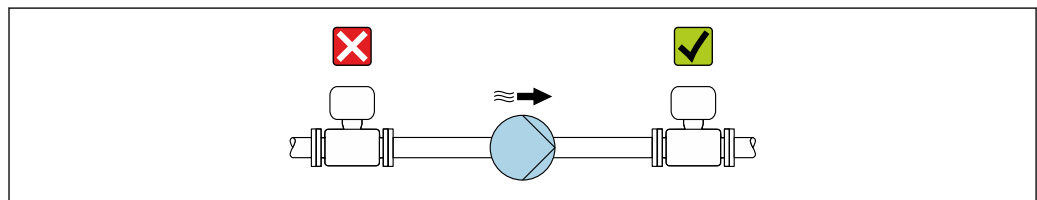

A0028777

Thermal insulation

In the case of some fluids, it is important to keep the heat radiated from the sensor to the transmitter to a low level. A wide range of materials can be used for the required insulation.

1) Cleaning only refers to the measuring instrument. Any accessories that have been supplied are not cleaned.

NOTICE**Electronics overheating on account of thermal insulation!**

- ▶ Recommended orientation: horizontal orientation, sensor connection housing pointing downwards.
- ▶ Do not insulate the sensor connection housing.
- ▶ Maximum permissible temperature at the lower end of the sensor connection housing: 80 °C (176 °F)
- ▶ Thermal insulation with exposed extension neck: We recommend that you do not insulate the extension neck in order to ensure optimum dissipation of heat.

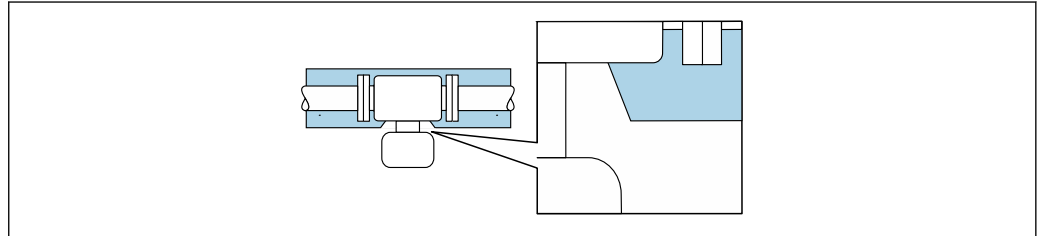

A0034391

 32 Thermal insulation with exposed extension neck

Heating

Some media require suitable measures to avoid loss of heat at the sensor.

Heating options

- Electrical heating, e.g. with electric band heaters ²⁾
- Via pipes carrying hot water or steam
- Via heating jackets



Heating jackets for the sensors can be ordered as accessories from Endress+Hauser →  129.

NOTICE**Danger of overheating when heating**

- ▶ Ensure that the temperature at the lower end of the transmitter housing does not exceed 80 °C (176 °F).
- ▶ Ensure that sufficient convection takes place at the transmitter neck.
- ▶ Ensure that a sufficiently large area of the transmitter neck remains exposed. The uncovered part serves as a radiator and protects the electronics from overheating and excessive cooling.
- ▶ When using in potentially explosive atmospheres, observe the information in the device-specific Ex documentation. For detailed information on the temperature tables, see the separate document entitled "Safety Instructions" (XA) for the device.
- ▶ Consider the behavior of the process diagnostics "830 Ambient temperature too high" and "832 Electronics temperature too high" if overheating cannot be avoided by a suitable system design.

Vibrations

The high oscillation frequency of the measuring tubes ensures that the correct operation of the measuring system is not influenced by plant vibrations.

2) The use of parallel electric band heaters is generally recommended (bidirectional electricity flow). Particular considerations must be made if a single-wire heating cable is to be used. Additional information is provided in the document EA01339D "Installation instructions for electrical trace heating systems" →  133

Mechanical construction

Dimensions in SI units

Housing of Proline 500 – digital transmitter

Non-hazardous area or hazardous area: Zone 2; Class I, Division 2

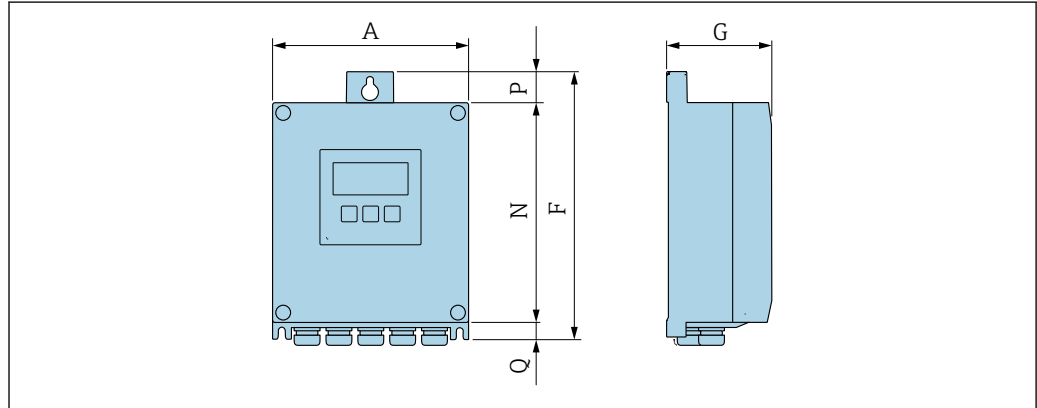

A0033789

Order code for "Transmitter housing", option A "Aluminum, coated" and order code for "Integrated ISEM electronics", option A "Sensor"

A [mm]	F [mm]	G [mm]	N [mm]	P [mm]	Q [mm]
167	232	89	187	24	21

Order code for "Transmitter housing", option D "Polycarbonate" and order code for "Integrated ISEM electronics", option A "Sensor"

A [mm]	F [mm]	G [mm]	N [mm]	P [mm]	Q [mm]
177	234	89	197	17	22

Housing of Proline 500 transmitter

Hazardous area: Zone 2; Class I, Division 2 or Zone 1; Class I, Division 1

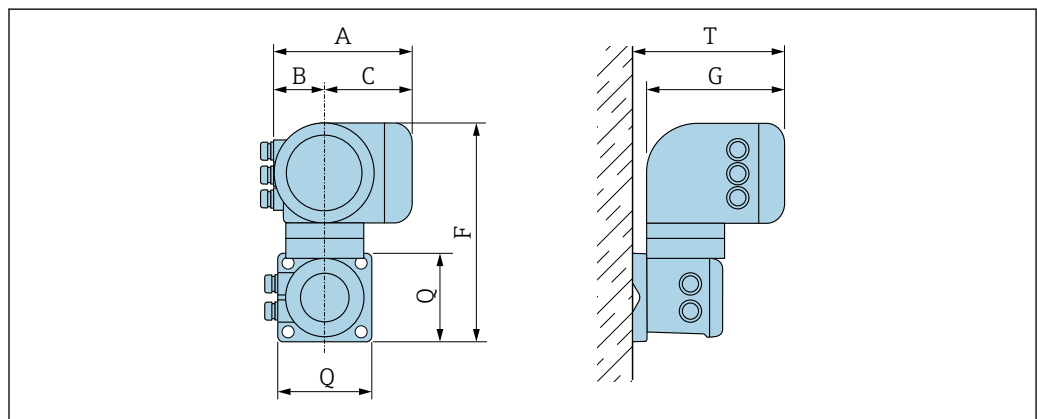

A0033788

Order code for "Transmitter housing", option A "Aluminum, coated" and order code for "Integrated ISEM electronics", option B "Transmitter"

A [mm]	B [mm]	C [mm]	F [mm]	G [mm]	Q [mm]	T [mm]
188	85	103	318	217	130	239

Sensor connection housing

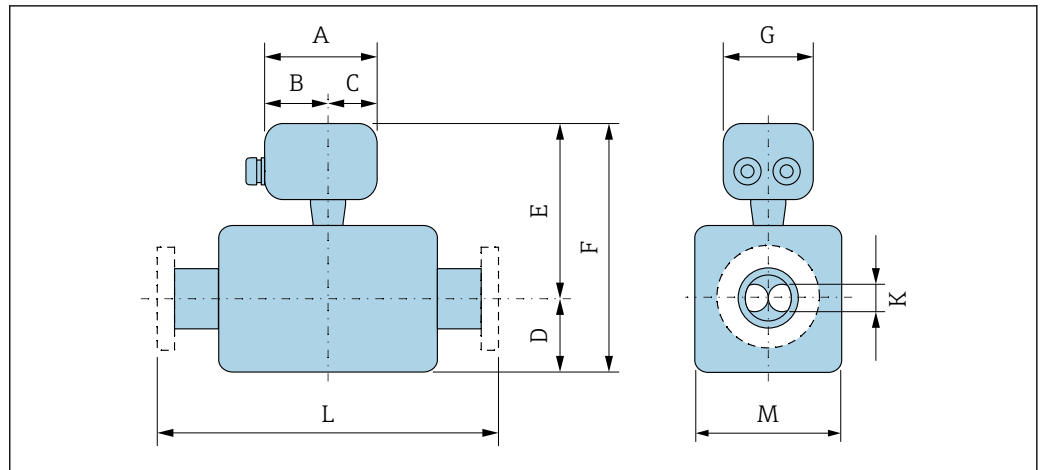

Order code for "Sensor connection housing", option A "Aluminum, coated"

DN	A ¹⁾	B	C	D	E	F	G	K	L	M
[mm]	[mm]	[mm]	[mm]	[mm]	[mm]	[mm]	[mm]	[mm]	[mm]	[mm]
8	148	94	54	89	177	266	136	5.35	²⁾	45
15	148	94	54	100	177	277	136	8.30	²⁾	45
25	148	94	54	102	174	276	136	12.0	²⁾	51
40	148	94	54	121	180	301	136	17.6	²⁾	65
50	148	94	54	175.5	194.5	370	136	26.0	²⁾	95
80	148	94	54	205	213.5	418.5	136	40.5	²⁾	127

- 1) Depending on the cable gland used: values up to + 30 mm
- 2) Depending on the process connection

Order code for "Sensor connection housing", option B "Stainless"

DN	A ¹⁾	B	C	D	E	F	G	K	L	M
[mm]	[mm]	[mm]	[mm]	[mm]	[mm]	[mm]	[mm]	[mm]	[mm]	[mm]
8	137	78	59	89	172.5	261.5	134	5.35	²⁾	45
15	137	78	59	100	172.5	272.5	134	8.30	²⁾	45
25	137	78	59	102	169.5	271.5	134	12.0	²⁾	51
40	137	78	59	121	175.5	295.5	134	17.6	²⁾	65
50	137	78	59	175.5	190	265.5	134	26.0	²⁾	95
80	137	78	59	205	208.5	413.5	134	40.5	²⁾	127

- 1) Depending on the cable gland used: values up to + 30 mm
- 2) Depending on the process connection

Order code for "Sensor connection housing", option C "Ultra-compact hygienic, stainless"

DN	A ¹⁾	B	C	D	E	F	G	K	L	M
[mm]	[mm]	[mm]	[mm]	[mm]	[mm]	[mm]	[mm]	[mm]	[mm]	[mm]
8	124	68	56	89	172.5	261.5	112	5.35	²⁾	45
15	124	68	56	100	172.5	272.5	112	8.30	²⁾	45
25	124	68	56	102	169.5	271.5	112	12.0	²⁾	51

DN [mm]	A ¹⁾ [mm]	B [mm]	C [mm]	D [mm]	E [mm]	F [mm]	G [mm]	K [mm]	L [mm]	M [mm]
40	124	68	56	121	175.5	295.5	112	17.6	²⁾	65
50	124	68	56	175.5	190	265.5	112	26.0	²⁾	95
80	124	68	56	205	208.5	413.5	112	40.5	²⁾	127

1) Depending on the cable gland used: values up to + 30 mm

2) Depending on the process connection

Flange connections

Fixed flange EN 1092-1, ASME B16.5, JIS B2220

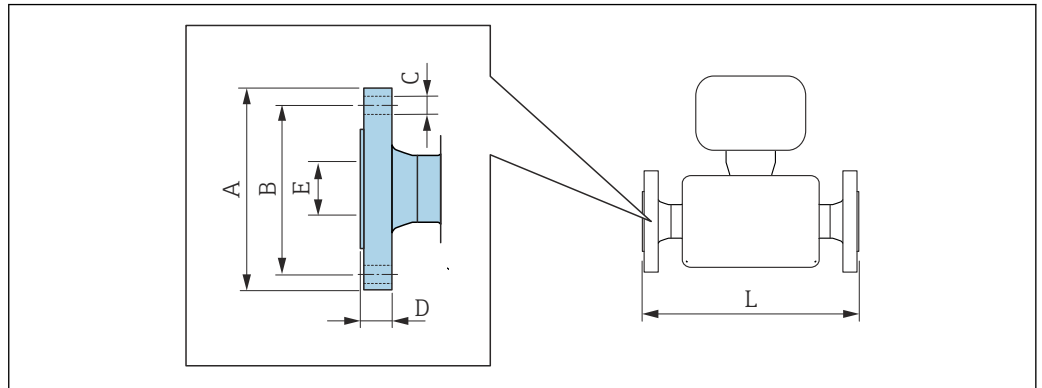

A0015621

i Length tolerance for dimension L in mm:
+1.5/-2.0

Flange similar to EN 1092-1 (DIN 2501/DIN 2512N), PN 40						
1.4404 (F316/F316L): order code for "Process connection", option D2S						
Flange with groove similar to EN 1092-1 Form D (DIN 2512N), PN 40						
1.4404 (F316/F316L): order code for "Process connection", option D6S						
DN [mm]	A [mm]	B [mm]	C [mm]	D [mm]	E [mm]	L [mm]
8 ¹⁾	95	65	4 × Ø14	16	17.3	232/510 ²⁾
15	95	65	4 × Ø14	16	17.3	279/510 ²⁾
25	115	85	4 × Ø14	18	28.5	329/600 ²⁾
40	150	110	4 × Ø18	18	43.1	445
50	165	125	4 × Ø18	20	54.5	556/715 ²⁾
80	200	160	8 × Ø18	24	82.5	611/915 ²⁾

Surface roughness (flange): EN 1092-1 Form B1 (DIN 2526 Form C), Ra 3.2 to 12.5 µm

- 1) DN 8 with DN 15 flanges as standard
- 2) Installed length in accordance with NAMUR recommendation NE 132 optionally available (order code for "Process connection", option D2N or D6N (with groove))

Flange similar to EN 1092-1 (DIN 2501), PN 40 (with DN 25 flanges)						
1.4404 (F316/F316L)						
<i>Order code for "Process connection", option R2S</i>						
DN [mm]	A [mm]	B [mm]	C [mm]	D [mm]	E [mm]	L [mm]
8	115	85	4 × Ø14	18	28.5	329
15	115	85	4 × Ø14	18	28.5	329

Surface roughness (flange): EN 1092-1 Form B1 (DIN 2526 Form C), Ra 3.2 to 12.5 µm

Flange similar to EN 1092-1 (DIN 2501/DIN 2512N), PN 63 1.4404 (F316/F316L): order code for "Process connection", option D3S						
Flange with groove similar to EN 1092-1 Form D (DIN 2512N), PN 63 1.4404 (F316/F316L): order code for "Process connection", option D7S						
DN [mm]	A [mm]	B [mm]	C [mm]	D [mm]	E [mm]	L [mm]
50	180	135	4 × Ø22	26	54.5	565
80	215	170	8 × Ø22	28	81.7	646
Surface roughness (flange): EN 1092-1 Form B2 (DIN 2526 Form E), Ra 0.8 to 3.2 µm						

Flange similar to EN 1092-1 (DIN 2501/DIN 2512N), PN 100 1.4404 (F316/F316L) Order code for "Process connection", option D4S						
Flange with groove similar to EN 1092-1 Form D (DIN 2512N) available, PN 100 1.4404 (F316/F316L) Order code for "Process connection", option D8S						
DN [mm]	A [mm]	B [mm]	C [mm]	D [mm]	E [mm]	L [mm]
8 ¹⁾	105	75	4 × Ø14	20	17.3	261
15	105	75	4 × Ø14	20	17.3	295
25	140	100	4 × Ø18	24	28.5	360
40	170	125	4 × Ø22	26	42.5	486
50	195	145	4 × Ø26	28	53.9	581
80	230	180	8 × Ø26	32	80.9	656
Surface roughness (flange): EN 1092-1 Form B2 (DIN 2526 Form E), Ra 0.8 to 3.2 µm						

1) DN 8 with DN 15 flanges as standard

Flange similar to ASME B16.5, Class 150 1.4404 (F316/F316L) Order code for "Process connection", option AAS						
DN [mm]	A [mm]	B [mm]	C [mm]	D [mm]	E [mm]	L [mm]
8 ¹⁾	90	60.3	4 × Ø15.7	11.2	15.7	232
15	90	60.3	4 × Ø15.7	11.2	15.7	279
25	110	79.4	4 × Ø15.7	14.2	26.7	329
40	125	98.4	4 × Ø15.7	17.5	40.9	445
50	150	120.7	4 × Ø19.1	19.1	52.6	556
80	190	152.4	4 × Ø19.1	23.9	78.0	611
Surface roughness (flange): Ra 3.2 to 6.3 µm						

1) DN 8 with DN 15 flanges as standard

Flange similar to ASME B16.5, Class 300 1.4404 (F316/F316L) Order code for "Process connection", option ABS						
DN [mm]	A [mm]	B [mm]	C [mm]	D [mm]	E [mm]	L [mm]
8 ¹⁾	95	66.7	4 × Ø15.7	14.2	15.7	232
15	95	66.7	4 × Ø15.7	14.2	15.7	279

Flange similar to ASME B16.5, Class 300						
1.4404 (F316/F316L)						
<i>Order code for "Process connection", option ABS</i>						
DN [mm]	A [mm]	B [mm]	C [mm]	D [mm]	E [mm]	L [mm]
25	125	88.9	4 × Ø19.0	17.5	26.7	329
40	155	114.3	4 × Ø22.3	20.6	40.9	445
50	165	127	8 × Ø19.0	22.3	52.6	556
80	210	168.3	8 × Ø22.3	28.4	78.0	611
Surface roughness (flange): Ra 3.2 to 6.3 µm						

1) DN 8 with DN 15 flanges as standard

Flange similar to ASME B16.5, Class 600						
1.4404 (F316/F316L)						
<i>Order code for "Process connection", option ACS</i>						
DN [mm]	A [mm]	B [mm]	C [mm]	D [mm]	E [mm]	L [mm]
8 ¹⁾	95	66.7	4 × Ø15.7	20.6	13.9	261
15	95	66.7	4 × Ø15.7	20.6	13.9	295
25	125	88.9	4 × Ø19.1	23.9	24.3	380
40	155	114.3	4 × Ø22.4	28.7	38.1	496
50	165	127	8 × Ø19.1	31.8	49.2	583
80	210	168.3	8 × Ø22.4	38.2	73.7	671
Surface roughness (flange): Ra 3.2 to 6.3 µm						

1) DN 8 with DN 15 flanges as standard

Flange JIS B2220, 10K						
1.4404 (F316/F316L)						
<i>Order code for "Process connection", option NDS</i>						
DN [mm]	A [mm]	B [mm]	C [mm]	D [mm]	E [mm]	L [mm]
50	155	120	4 × Ø19	16	50	556
80	185	150	8 × Ø19	18	80	603
Surface roughness (flange): Ra 3.2 to 6.3 µm						

Flange JIS B2220, 20K						
1.4404 (F316/F316L)						
<i>Order code for "Process connection", option NES</i>						
DN [mm]	A [mm]	B [mm]	C [mm]	D [mm]	E [mm]	L [mm]
8 ¹⁾	95	70	4 × Ø15	14	15	232
15	95	70	4 × Ø15	14	15	279
25	125	90	4 × Ø19	16	25	329
40	140	105	4 × Ø19	18	40	445
50	155	120	8 × Ø19	18	50	556

Flange JIS B2220, 20K 1.4404 (F316/F316L) <i>Order code for "Process connection", option NES</i>						
DN [mm]	A [mm]	B [mm]	C [mm]	D [mm]	E [mm]	L [mm]
80	200	160	8 × Ø23	22	80	603
Surface roughness (flange): Ra 3.2 to 6.3 µm						

- 1) DN 8 with DN 15 flanges as standard

Flange JIS B2220, 40K 1.4404 (F316/F316L) <i>Order code for "Process connection", option NGS</i>						
DN [mm]	A [mm]	B [mm]	C [mm]	D [mm]	E [mm]	L [mm]
8 ¹⁾	115	80	4 × Ø19	20	15	261
15	115	80	4 × Ø19	20	15	300
25	130	95	4 × Ø19	22	25	375
40	160	120	4 × Ø23	24	38	496
50	165	130	8 × Ø19	26	50	601
80	210	170	8 × Ø23	32	75	661
Surface roughness (flange): Ra 3.2 to 6.3 µm						

- 1) DN 8 with DN 15 flanges as standard

Flange JIS B2220, 63K 1.4404 (F316/F316L) <i>Order code for "Process connection", option NHS</i>						
DN [mm]	A [mm]	B [mm]	C [mm]	D [mm]	E [mm]	L [mm]
8 ¹⁾	120	85	4 × Ø19	23	12	282
15	120	85	4 × Ø19	23	12	315
25	140	100	4 × Ø23	27	22	383
40	175	130	4 × Ø25	32	35	515
50	185	145	4 × Ø23	34	48	616
80	230	185	4 × Ø25	40	73	686
Surface roughness (flange): Ra 3.2 to 6.3 µm						

- 1) DN 8 with DN 15 flanges as standard

Fixed flange DIN 11864-2

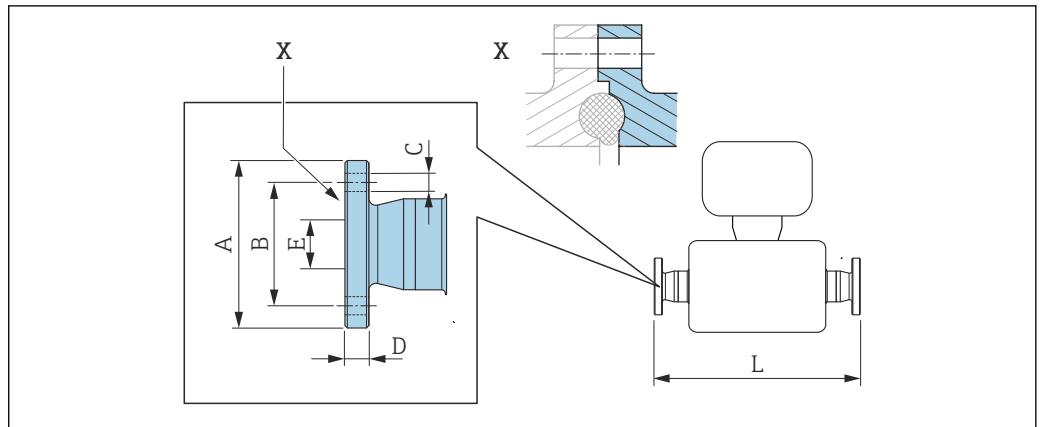

A0015627

33 Detail X: Asymmetrical process connection; the part shown in blue is provided by the supplier.

i Length tolerance for dimension L in mm:
+1.5/-2.0

Flange DIN11864-2 Form A, for pipe according to DIN11866 series A, flange with notch 1.4404 (316/316L) Order code for "Process connection", option KCS						
DN [mm]	A [mm]	B [mm]	C [mm]	D [mm]	E [mm]	L [mm]
8 ¹⁾	54	37	4 × Ø9	10	10	249
15	59	42	4 × Ø9	10	16	293
25	70	53	4 × Ø9	10	26	344
40	82	65	4 × Ø9	10	38	456
50	94	77	4 × Ø9	10	50	562
80	133	112	8 × Ø11	12	81	671

3-A version available: order code for "Additional approval", option LP in conjunction with
 Ra ≤ 0.76 µm: order code for "Measuring tube material", option SB, SJ
 Ra ≤ 0.38 µm: order code for "Measuring tube material", option SC, SK

1) DN 8 with DN 10 flanges as standard

Clamp connections

Tri-Clamp

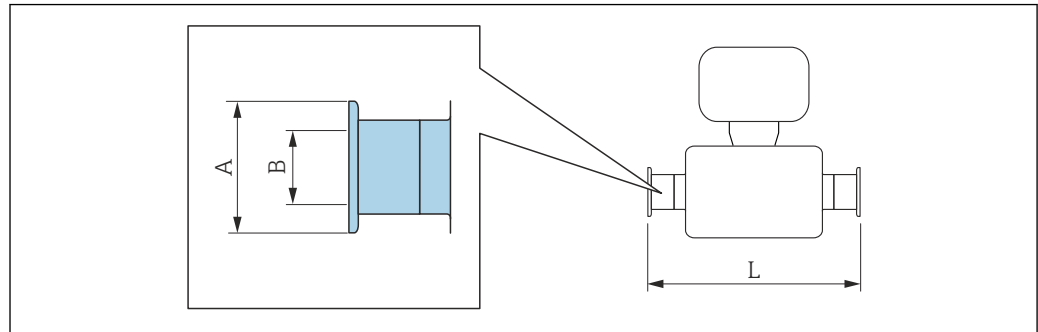

A0015625

i Length tolerance for dimension L in mm:
+1.5/-2.0

Tri-Clamp ($\frac{1}{2}$ "), for pipe according to DIN 11866 series C 1.4404 (316/316L)

Order code for "Process connection", option FDW

DN [mm]	Clamp [in]	A [mm]	B [mm]	L [mm]
8	$\frac{1}{2}$	25.0	9.5	229
15	$\frac{1}{2}$	25.0	9.5	273

3-A version available: order code for "Additional approval", option LP in conjunction with
 $Ra \leq 0.76 \mu\text{m}$: order code for "Measuring tube material", option SB, SJ
 $Ra \leq 0.38 \mu\text{m}$: order code for "Measuring tube material", option SC, SK

Tri-Clamp (≥ 1 "), for pipe according to DIN 11866 series C 1.4404 (316/316L)

Order code for "Process connection", option FTS

DN [mm]	Clamp [in]	A [mm]	B [mm]	L [mm]
8	1	50.4	22.1	229
15	1	50.4	22.1	273
25	1	50.4	22.1	324
40	$1\frac{1}{2}$	50.4	34.8	456
50	2	63.9	47.5	562
80	3	90.9	72.9	671

3-A version available: order code for "Additional approval", option LP in conjunction with
 $Ra \leq 0.76 \mu\text{m}$: order code for "Measuring tube material", option SB, SJ
 $Ra \leq 0.38 \mu\text{m}$: order code for "Measuring tube material", option SC, SK

Threaded couplings

Threaded adapter DIN 11851, DIN11864-1, SMS 1145

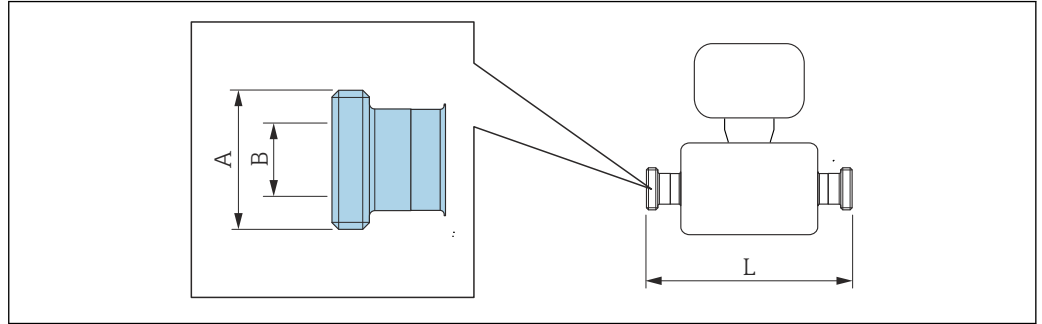

A0015628

i Length tolerance for dimension L in mm:
+1.5/-2.0

Threaded adapter DIN 11851, for pipe according to DIN11866 series A			
1.4404 (316/316L)			
<i>Order code for "Process connection", option FMW</i>			
DN [mm]	A [in]	B [mm]	L [mm]
8	Rd 34 × 1/8	16	229
15	Rd 34 × 1/8	16	273
25	Rd 52 × 1/6	26	324
40	Rd 65 × 1/6	38	456
50	Rd 78 × 1/6	50	562
80	Rd 110 × 1/4	81	671

3-A version available: order code for "Additional approval", option LP in conjunction with
 Ra ≤ 0.76 µm: order code for "Measuring tube material", option SB, SJ
 Ra ≤ 0.38 µm: order code for "Measuring tube material", option SC, SK

Threaded adapter DIN11864-1 Form A, for pipe according to DIN11866 series A			
1.4404 (316/316L)			
<i>Order code for "Process connection", option FLW</i>			
DN [mm]	A [in]	B [mm]	L [mm]
8	Rd 28 × 1/8	10	229
15	Rd 34 × 1/8	16	273
25	Rd 52 × 1/6	26	324
40	Rd 65 × 1/6	38	456
50	Rd 78 × 1/6	50	562
80	Rd 110 × 1/4	81	671

3-A version available: order code for "Additional approval", option LP in conjunction with
 Ra ≤ 0.76 µm: order code for "Measuring tube material", option SB, SJ
 Ra ≤ 0.38 µm: order code for "Measuring tube material", option SC, SK

Threaded adapter SMS 1145 1.4404 (316/316L) <i>Order code for "Process connection", option SCS</i>			
DN [mm]	A [in]	B [mm]	L [mm]
8	Rd 40 × 1/6	22.5	229
15	Rd 40 × 1/6	22.5	273
25	Rd 40 × 1/6	22.5	324
40	Rd 60 × 1/6	35.5	456
50	Rd 70 × 1/6	48.5	562
80	Rd 98 × 1/6	72.9	671

3-A version available: order code for "Additional approval", option LP in conjunction with
Ra ≤ 0.76 µm: order code for "Measuring tube material", option SB, SJ
Ra ≤ 0.38 µm: order code for "Measuring tube material", option SC, SK

Threaded adapter ISO 2853

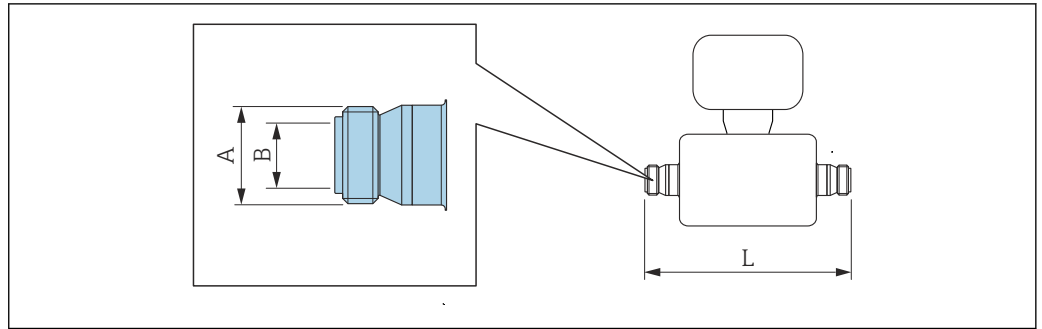

A0015623

 Length tolerance for dimension L in mm:
+1.5/-2.0

**Threaded adapter ISO 2853, for pipe according to ISO 2037
1.4404 (316/316L)**

Order code for "Process connection", option JSF

DN [mm]	A ¹⁾ [mm]	B [mm]	L [mm]
8	37.13	22.6	229
15	37.13	22.6	273
25	37.13	22.6	324
40	50.68	35.6	456
50	64.16	48.6	562
80	91.19	72.9	671

3-A version available: order code for "Additional approval", option LP in conjunction with
 Ra ≤ 0.76 µm: order code for "Measuring tube material", option SB, SJ
 Ra ≤ 0.38 µm: order code for "Measuring tube material", option SC, SK

1) Max. thread diameter according to ISO 2853 Annex A

VCO

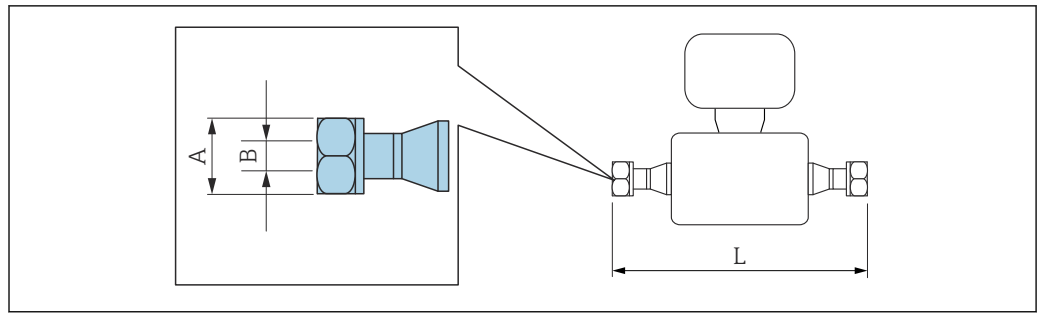

A0015624

i Length tolerance for dimension L in mm:
+1.5/-2.0

8-VCO-4 (1/2") 1.4404 (316/316L) Order code for "Process connection", option CVS			
DN [mm]	A [in]	B [mm]	L [mm]
8	AF 1	10.2	252

12-VCO-4 (3/4") 1.4404 (316/316L) Order code for "Process connection", option CWS			
DN [mm]	A [in]	B [mm]	L [mm]
15	AF 1½	15.7	305

Accessories

Protective cover

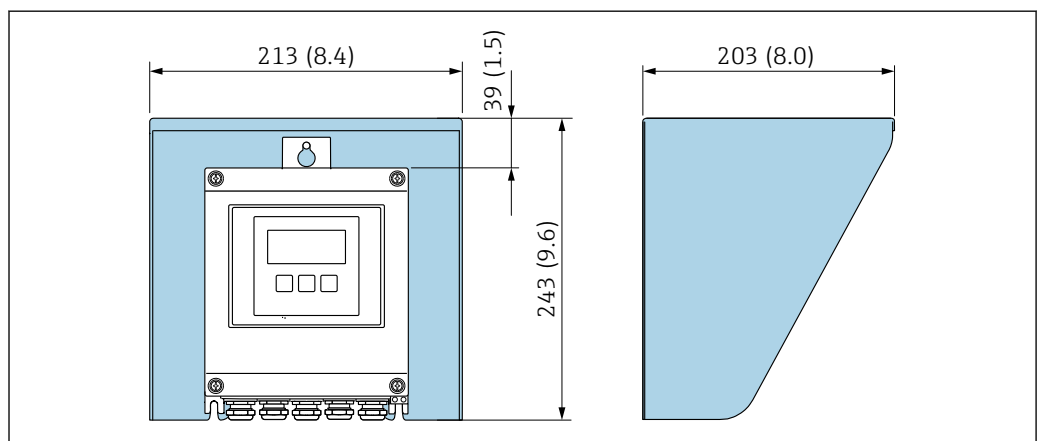

A0029552

34 Weather protection cover for Proline 500 – digital; unit mm (in)

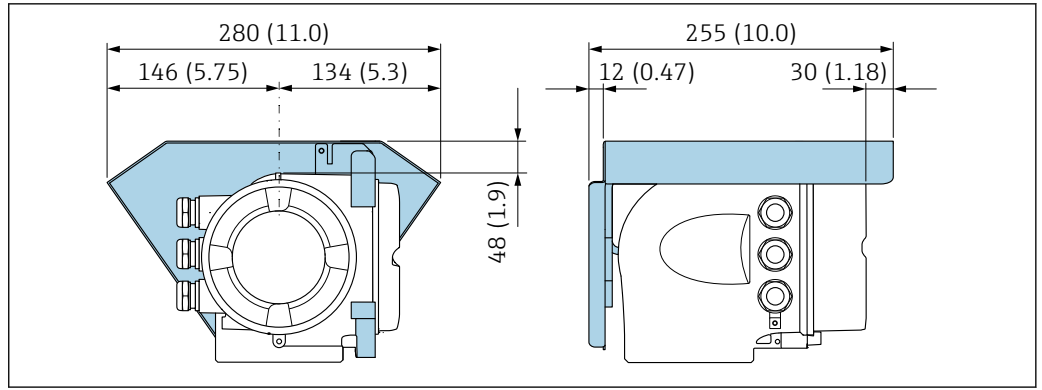

A0029553

35 Weather protection cover for Proline 500 – unit mm (in)

External WLAN antenna

i The external WLAN antenna is not suitable for use in hygienic applications.

Proline 500 – digital

External WLAN antenna mounted on device

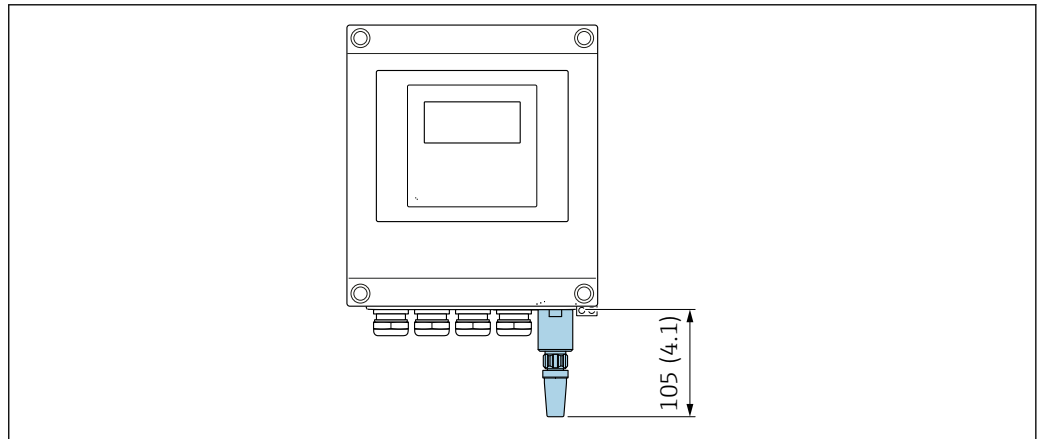

A0033607

36 Unit mm (in)

External WLAN antenna mounted with cable

The external WLAN antenna can be mounted separately from the transmitter if the transmission/reception conditions at the transmitter mounting location are poor.

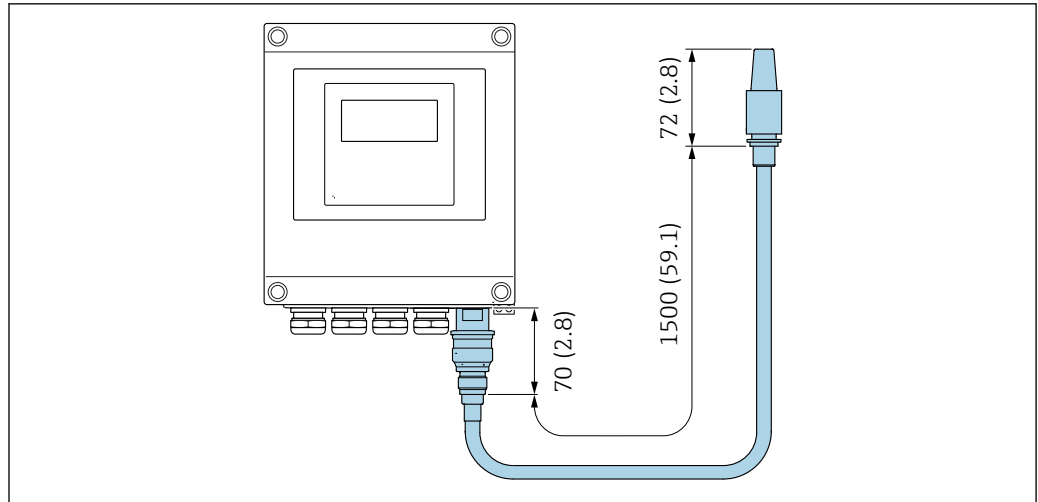

A0033606

37 Unit mm (in)

Proline 500

External WLAN antenna mounted on device

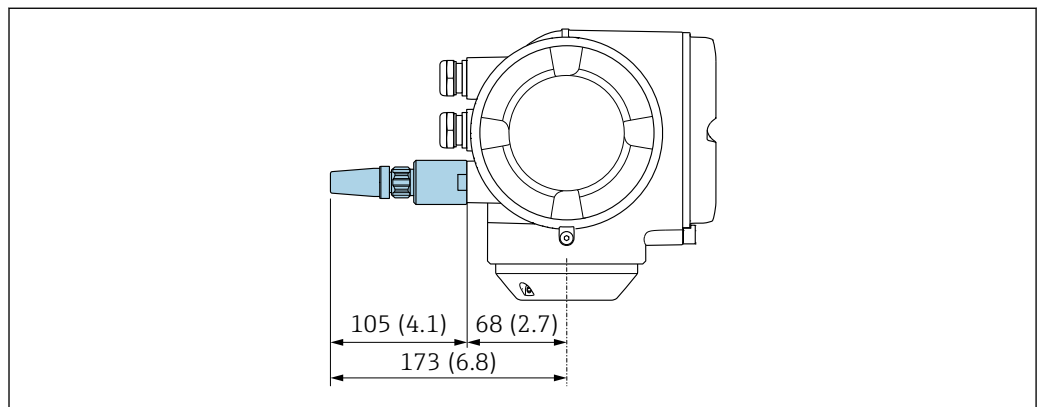

A0028923

38 Unit mm (in)

External WLAN antenna mounted with cable

The external WLAN antenna can be mounted separately from the transmitter if the transmission/reception conditions at the transmitter mounting location are poor.

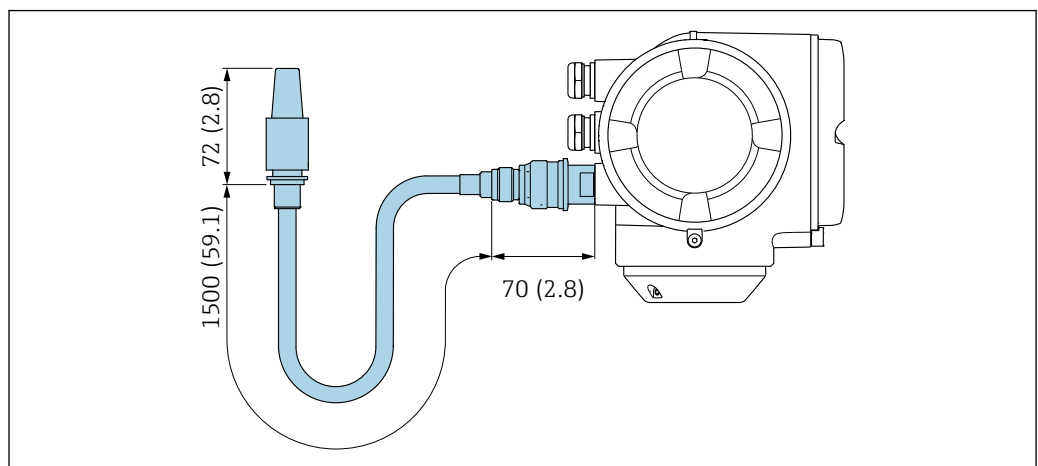

A0033597

39 Unit mm (in)

Dimensions in US units

Housing of Proline 500 – digital transmitter

Non-hazardous area or hazardous area: Zone 2; Class I, Division 2

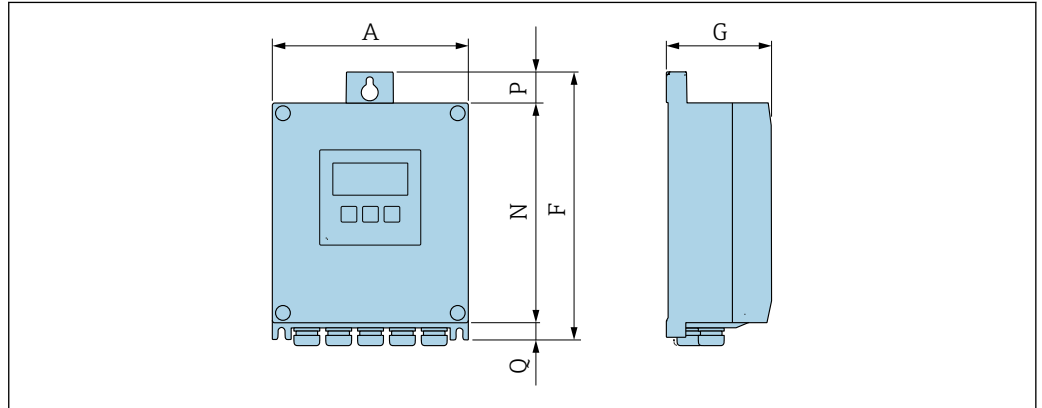

A0033789

Order code for "Transmitter housing", option A "Aluminum, coated" and order code for "Integrated ISEM electronics", option A "Sensor"

A [in]	F [in]	G [in]	N [in]	P [in]	Q [in]
6.57	9.13	3.50	7.36	0.94	0.83

Order code for "Transmitter housing", option D "Polycarbonate" and order code for "Integrated ISEM electronics", option A "Sensor"

A [in]	F [in]	G [in]	N [in]	P [in]	Q [in]
6.97	9.21	3.50	7.76	0.67	0.87

Housing of Proline 500 transmitter

Hazardous area: Zone 2; Class I, Division 2 or Zone 1; Class I, Division 1

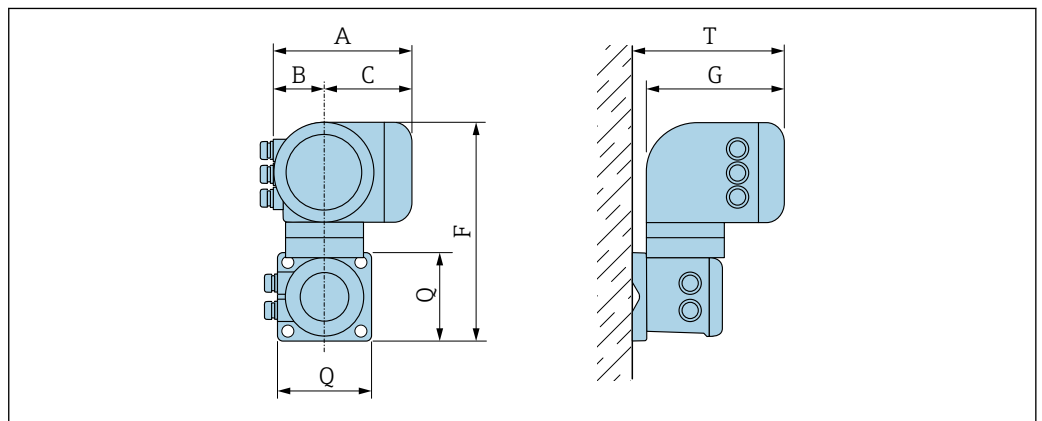

A0033788

Order code for "Transmitter housing", option A "Aluminum, coated" and order code for "Integrated ISEM electronics", option B "Transmitter"

A [in]	B [in]	C [in]	F [in]	G [in]	Q [in]	T [in]
7.40	3.35	4.06	12.5	8.54	5.12	9.41

Sensor connection housing

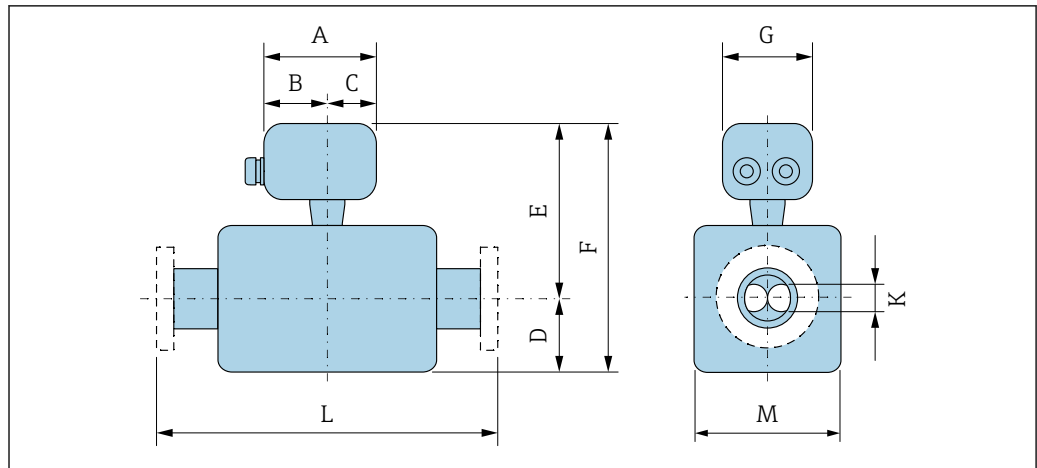

A0033787

Order code for "Sensor connection housing", option A "Aluminum, coated"

DN [in]	A ¹⁾ [in]	B ¹⁾ [in]	C [in]	D [in]	E [in]	F [in]	G [in]	K [in]	L [in]	M [in]
3/8	5.83	3.70	2.13	3.5	6.97	10.47	5.35	0.21	²⁾	1.77
1/2	5.83	3.70	2.13	3.94	6.97	10.91	5.35	0.33	²⁾	1.77
1	5.83	3.70	2.13	4.02	6.85	10.87	5.35	0.47	²⁾	2.01
1 1/2	5.83	3.70	2.13	4.76	7.09	11.85	5.35	0.69	²⁾	2.56
2	5.83	3.70	2.13	6.91	7.66	14.57	5.35	1.02	²⁾	3.74
3	5.83	3.70	2.13	8.07	8.41	16.48	5.35	1.59	²⁾	5.00

- 1) Depending on the cable gland used: values up to +1.18 in
- 2) Depending on the process connection

Order code for "Sensor connection housing", option B "Stainless"

DN [in]	A ¹⁾ [in]	B [in]	C [in]	D [in]	E [in]	F [in]	G [in]	K [in]	L [in]	M [in]
3/8	5.39	3.07	2.32	3.5	6.79	10.3	5.28	0.21	²⁾	1.77
1/2	5.39	3.07	2.32	3.94	6.79	10.73	5.28	0.33	²⁾	1.77
1	5.39	3.07	2.32	4.02	6.67	10.69	5.28	0.47	²⁾	2.01
1 1/2	5.39	3.07	2.32	4.76	6.91	11.63	5.28	0.69	²⁾	2.56
2	5.39	3.07	2.32	6.91	7.48	10.45	5.28	1.02	²⁾	3.74
3	5.39	3.07	2.32	8.07	8.21	16.28	5.28	1.59	²⁾	5.00

- 1) Depending on the cable gland used: values up to +1.18 in
- 2) Depending on the process connection

Order code for "Sensor connection housing", option C "Ultra-compact hygienic, stainless"

DN [in]	A ¹⁾ [in]	B [in]	C [in]	D [in]	E [in]	F [in]	G [in]	K [in]	L [in]	M [in]
3/8	4.88	2.68	2.20	3.5	6.79	10.3	4.41	0.21	²⁾	1.77
1/2	4.88	2.68	2.20	3.94	6.79	10.73	4.41	0.33	²⁾	1.77
1	4.88	2.68	2.20	4.02	6.67	10.69	4.41	0.47	²⁾	2.01

DN [in]	A ¹⁾ [in]	B [in]	C [in]	D [in]	E [in]	F [in]	G [in]	K [in]	L [in]	M [in]
1½	4.88	2.68	2.20	4.76	6.91	11.63	4.41	0.69	²⁾	2.56
2	4.88	2.68	2.20	6.91	7.48	10.45	4.41	1.02	²⁾	3.74
3	4.88	2.68	2.20	8.07	8.21	16.28	4.41	1.59	²⁾	5.00

- 1) Depending on the cable gland used: values up to +1.18 in
 2) Depending on the process connection

Flange connections

Fixed flange ASME B16.5

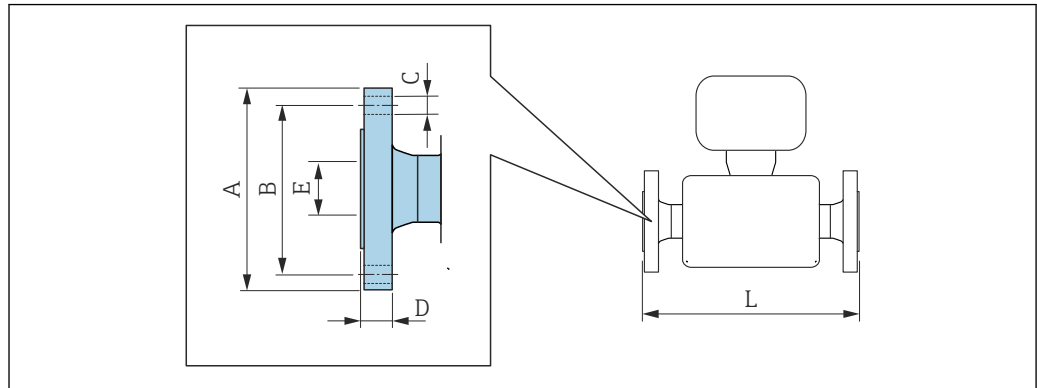

A0015621

i Length tolerance for dimension L in inches:
+0.06/-0.08

Flange similar to ASME B16.5, Cl 150 1.4404 (F316/F316L) Order code for "Process connection", option AAS						
DN [in]	A [in]	B [in]	C [in]	D [in]	E [in]	L [in]
$\frac{3}{8}$ ¹⁾	3.54	2.37	4 × Ø0.62	0.44	0.62	9.13
$\frac{1}{2}$	3.54	2.37	4 × Ø0.62	0.44	0.62	10.98
1	4.33	3.13	4 × Ø0.62	0.56	1.05	12.95
1½	4.92	3.87	4 × Ø0.62	0.69	1.61	17.52
2	5.91	4.75	4 × Ø0.75	0.75	2.07	21.89
3	7.48	6.00	4 × Ø0.75	0.94	3.07	24.06

Surface roughness (flange): Ra 126 to 248 µin

1) DN $\frac{3}{8}$ " with DN $\frac{1}{2}$ " flanges as standard

Flange similar to ASME B16.5, Class 300 1.4404 (F316/F316L) Order code for "Process connection", option ABS						
DN [in]	A [in]	B [in]	C [in]	D [in]	E [in]	L [in]
$\frac{3}{8}$ ¹⁾	3.74	2.63	4 × Ø0.62	0.56	0.62	9.13
$\frac{1}{2}$	3.74	2.63	4 × Ø0.62	0.56	0.62	10.98
1	4.92	3.50	4 × Ø0.75	0.69	1.05	12.95
1½	6.10	4.50	4 × Ø0.88	0.81	1.61	17.52
2	6.50	5.00	8 × Ø0.75	0.88	2.07	21.89
3	8.27	6.63	8 × Ø0.88	1.12	3.07	24.06

Surface roughness (flange): Ra 126 to 248 µin

1) DN $\frac{3}{8}$ " with DN $\frac{1}{2}$ " flanges as standard

Flange similar to ASME B16.5, Class 600 1.4404 (F316/F316L) <i>Order code for "Process connection", option ACS</i>						
DN [in]	A [in]	B [in]	C [in]	D [in]	E [in]	L [in]
$\frac{3}{8}$ ¹⁾	3.74	2.63	4 × Ø0.62	0.81	0.55	10.28
$\frac{1}{2}$	3.74	2.63	4 × Ø0.62	0.81	0.55	11.61
1	4.92	3.50	4 × Ø0.75	0.94	0.96	14.96
1½	6.10	4.50	4 × Ø0.88	1.13	1.50	19.53
2	6.50	5.00	8 × Ø0.75	1.25	1.94	22.95
3	8.27	6.63	8 × Ø0.88	1.50	2.9	26.42
Surface roughness (flange): Ra 126 to 248 µin						

1) DN $\frac{3}{8}$ " with DN $\frac{1}{2}$ " flanges as standard

Clamp connections

Tri-Clamp

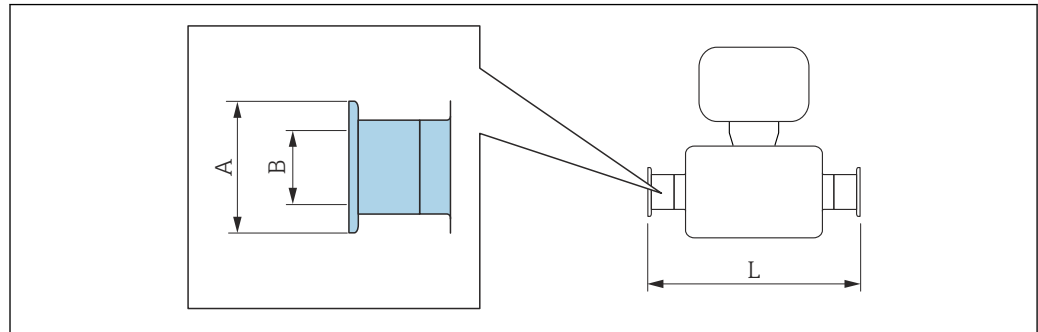

A0015625

i Length tolerance for dimension L in inches:
+0.06/-0.08

Tri-Clamp (½"), DIN 11866 series C 1.4404 (316/316L) Order code for "Process connection", option FDW				
DN [in]	Clamp [in]	A [in]	B [in]	L [in]
3/8	1/2	0.98	0.37	9.02
1/2	1/2	0.98	0.37	10.75

3-A version available: order code for "Additional approval", option LP in conjunction with
 Ra ≤ 30 µin: order code for "Measuring tube material", option SB, SJ
 Ra ≤ 15 µin: order code for "Measuring tube material", option SC, SK

Tri-Clamp (≥ 1"), DIN 11866 series C 1.4404 (316/316L) Order code for "Process connection", option FTS				
DN [in]	Clamp [in]	A [in]	B [in]	L [in]
3/8	1	1.98	0.87	9.02
1/2	1	1.98	0.87	10.75
1	1	1.98	0.87	12.76
1½	1½	1.98	1.37	17.95
2	2	2.52	1.87	22.13
3	3	3.58	2.87	26.42

3-A version available: order code for "Additional approval", option LP in conjunction with
 Ra ≤ 30 µin: order code for "Measuring tube material", option SB, SJ
 Ra ≤ 15 µin: order code for "Measuring tube material", option SC, SK

Threaded couplings

Threaded adapter SMS 1145

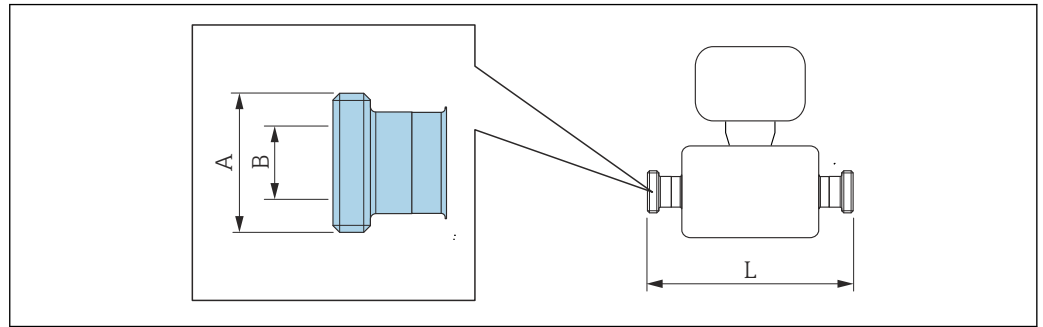

A0015628

i Length tolerance for dimension L in inches:
+0.06/-0.08

Threaded adapter SMS 1145			
1.4404 (316/316L)			
<i>Order code for "Process connection", option SCS</i>			
DN [in]	A [in]	B [in]	L [in]
3/8	Rd 40 × 1/6	0.89	9.02
1/2	Rd 40 × 1/6	0.89	10.75
1	Rd 40 × 1/6	0.89	12.76
1 1/2	Rd 60 × 1/6	1.40	17.95
2	Rd 70 × 1/6	1.91	22.13
3	Rd 98 × 1/6	2.87	26.42

3-A version available: order code for "Additional approval", option LP in conjunction with
 Ra ≤ 30 µin: order code for "Measuring tube material", option SB, SJ
 Ra ≤ 15 µin: order code for "Measuring tube material", option SC, SK

VCO

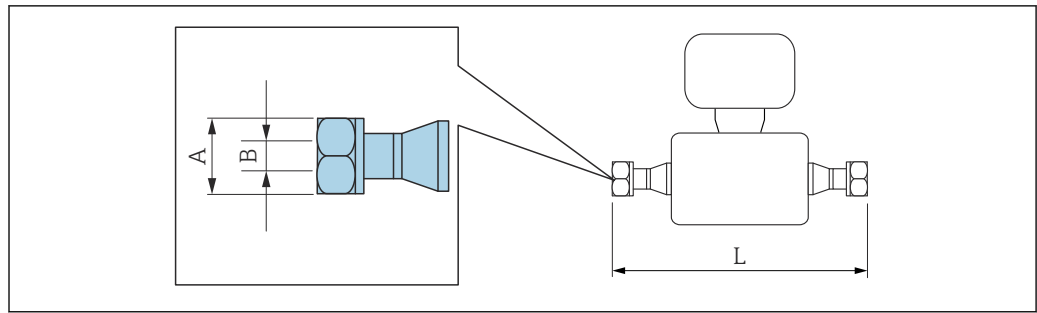

A0015624

i Length tolerance for dimension L in inches:
+0.06/-0.08

8-VCO-4 (1/2") 1.4404 (316/316L) Order code for "Process connection", option CVS			
DN [in]	A [in]	B [in]	L [in]
3/8	AF 1	0.40	9.92

12-VCO-4 (3/4") 1.4404 (316/316L) Order code for "Process connection", option CWS			
DN [in]	A [in]	B [in]	L [in]
1/2	AF 1 1/2	0.62	12.01

Accessories

Protective cover

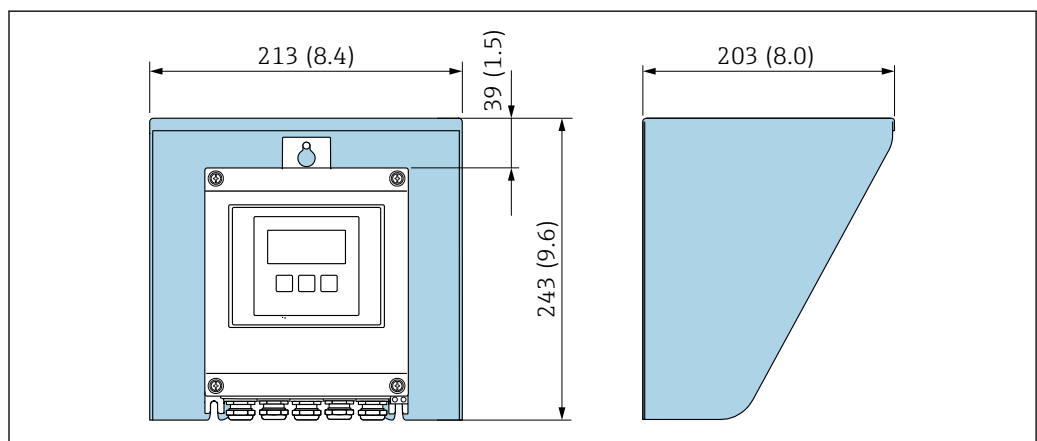

A0029552

40 Weather protection cover for Proline 500 – digital; unit mm (in)

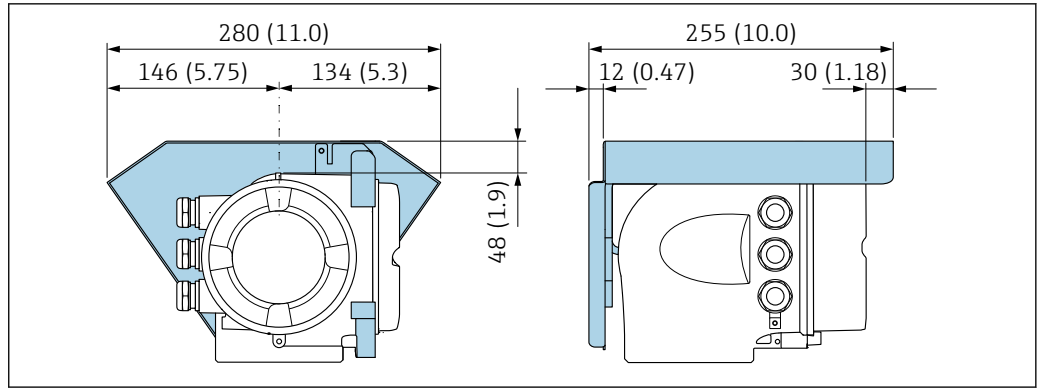

A0029553

41 Weather protection cover for Proline 500 – unit mm (in)

External WLAN antenna

i The external WLAN antenna is not suitable for use in hygienic applications.

Proline 500 – digital

External WLAN antenna mounted on device

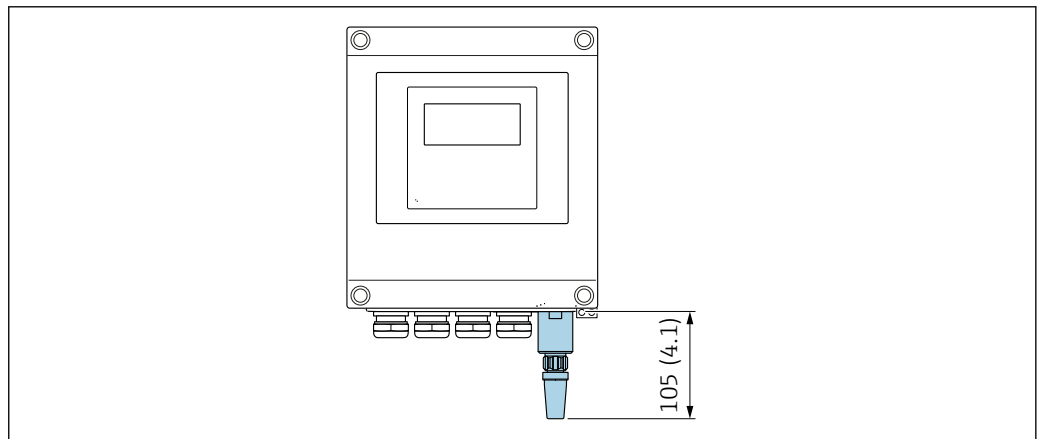

A0033607

42 Unit mm (in)

External WLAN antenna mounted with cable

The external WLAN antenna can be mounted separately from the transmitter if the transmission/reception conditions at the transmitter mounting location are poor.

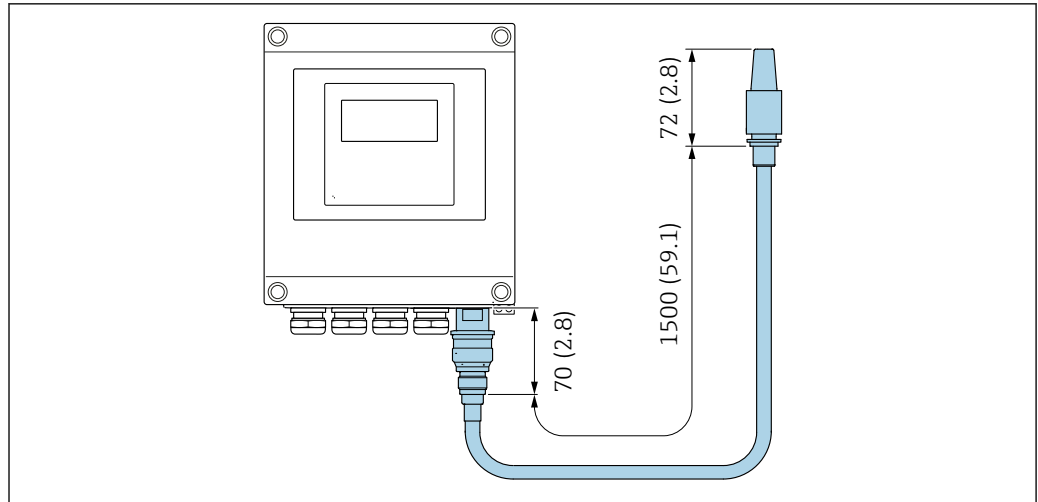

A0033606

43 Unit mm (in)

Proline 500

External WLAN antenna mounted on device

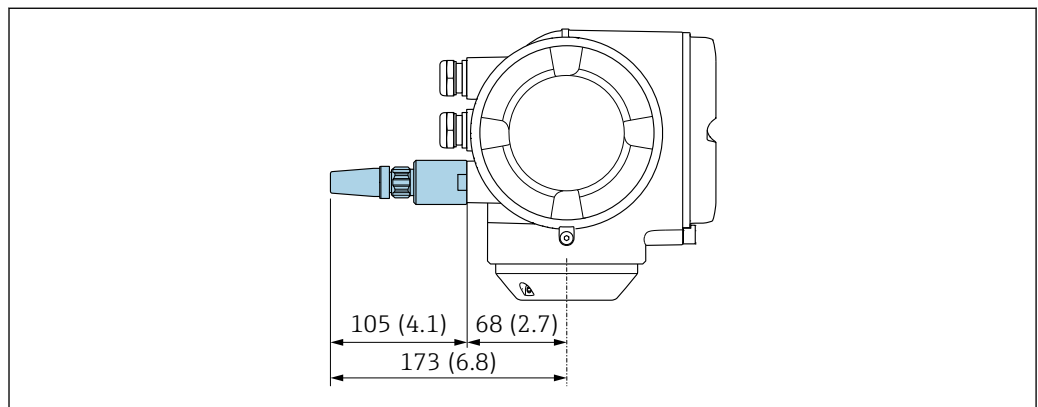

A0028923

44 Unit mm (in)

External WLAN antenna mounted with cable

The external WLAN antenna can be mounted separately from the transmitter if the transmission/reception conditions at the transmitter mounting location are poor.

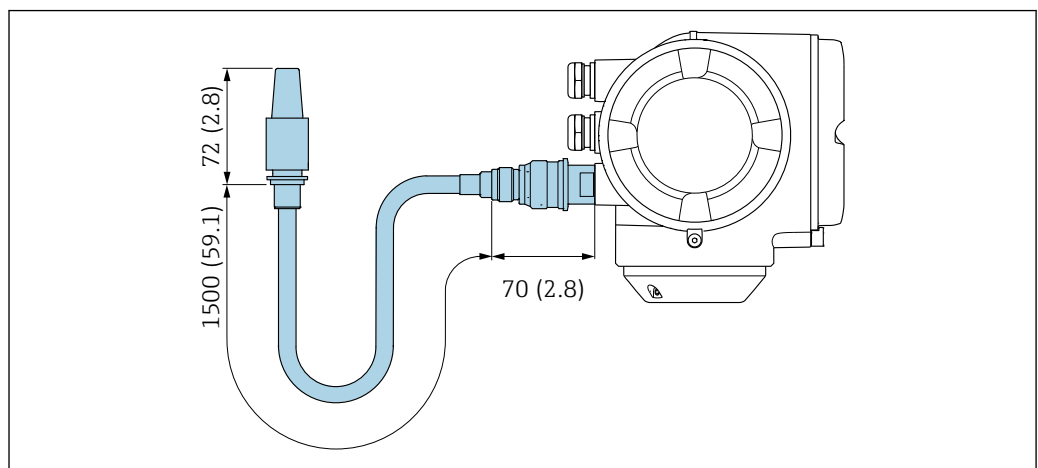

A0033597

45 Unit mm (in)

Weight

All values (weight exclusive of packaging material) refer to devices with EN/DIN PN 40 flanges.

Transmitter

- Proline 500 – digital polycarbonate: 1.4 kg (3.1 lbs)
- Proline 500 – digital aluminum: 2.4 kg (5.3 lbs)
- Proline 500 aluminum: 6.5 kg (14.3 lbs)

Sensor

Sensor with aluminum connection housing version:

Weight in SI units

DN [mm]	Weight [kg]
8	4
15	4
25	6
40	10
50	15
80	29

Weight in US units

DN [in]	Weight [lbs]
3/8	9
1/2	9
1	13
1 1/2	22
2	33
3	64

Materials

Transmitter housing

Housing of Proline 500 – digital transmitter

Order code for "Transmitter housing":

- Option **A** "Aluminum coated": aluminum, AlSi10Mg, coated
- Option **D** "Polycarbonate": polycarbonate

Housing of Proline 500 transmitter

Order code for "Transmitter housing":

Option **A** "Aluminum coated": aluminum, AlSi10Mg, coated

Window material

Order code for "Transmitter housing":

- Option **A** "Aluminum, coated": glass
- Option **D** "Polycarbonate": plastic

Fixing components for pipe mounting

- Screws, threaded bolts, washers, nuts: stainless A2 (chrome-nickel steel)
- Metal plates: stainless steel, 1.4301 (304)

Sensor connection housing

Order code for "Sensor connection housing":

- Option **A** "Aluminum coated": aluminum, AlSi10Mg, coated
- Option **B** "Stainless":
 - Stainless steel 1.4301 (304)
 - Optional: Order code for "Sensor feature", option **CC** "Hygienic version, for maximum corrosion resistance": stainless steel, 1.4404 (316L)
- Option **C** "Ultra-compact, stainless":
 - Stainless steel 1.4301 (304)
 - Optional: Order code for "Sensor feature", option **CC** "Hygienic version, for maximum corrosion resistance": stainless steel, 1.4404 (316L)

Cable entries/cable glands

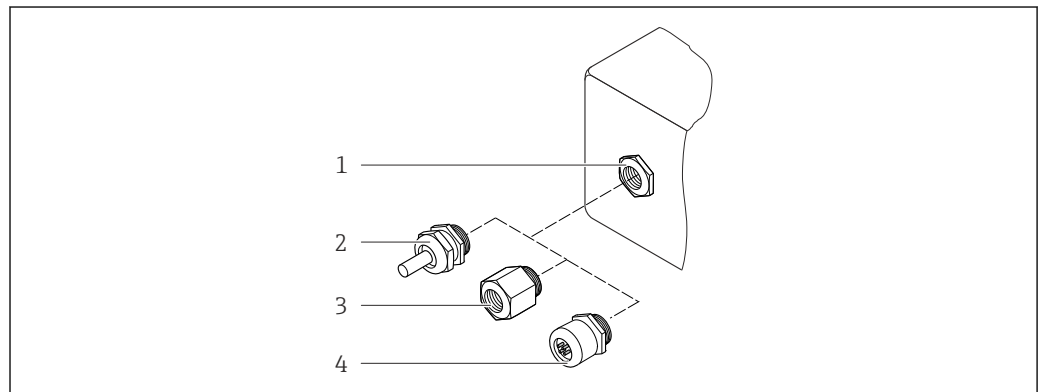

A0028352

46 Possible cable entries/cable glands

- 1 Internal thread M20 × 1.5
- 2 Cable gland M20 × 1.5
- 3 Adapter for cable entry with internal thread G ½" or NPT ½"
- 4 Device plug

Cable entries and adapters	Material
Cable gland M20 × 1.5	Plastic
<ul style="list-style-type: none"> ▪ Adapter for cable entry with female thread G ½" ▪ Adapter for cable entry with female thread NPT ½" <p>i Only available for certain device versions:</p> <ul style="list-style-type: none"> ▪ Order code for "Transmitter housing": <ul style="list-style-type: none"> ▪ Option A "Aluminum, coated" ▪ Option D "Polycarbonate" ▪ Order code for "Sensor connection housing": <ul style="list-style-type: none"> ▪ Proline 500 – digital: <ul style="list-style-type: none"> Option A "Aluminum coated" Option B "Stainless" ▪ Proline 500: <ul style="list-style-type: none"> Option B "Stainless" 	Nickel-plated brass
<p>Adapter for device plug</p> <p>i</p> <ul style="list-style-type: none"> ▪ Device plug for digital communication: Only available for certain device versions → 41. ▪ Device plug for connecting cable: A device plug is always used for the device version, order code for "Sensor connection housing", option C (ultra-compact, hygienic, stainless). 	Stainless steel, 1.4404 (316L)

Device plug

Electrical connection	Material
Plug M12x1	<ul style="list-style-type: none"> ▪ Socket: Stainless steel, 1.4404 (316L) ▪ Contact housing: Polyamide ▪ Contacts: Gold-plated brass

Connecting cable

 UV radiation can impair the cable outer sheath. Protect the cable from exposure to sun as much as possible.

Connecting cable for sensor - Proline 500 – digital transmitter

PVC cable with copper shield

Connecting cable for sensor - Proline 500 transmitter

PVC cable with copper shield

Sensor housing



- Acid and alkali-resistant outer surface
- Stainless steel 1.4301 (304)

Measuring tubes

Stainless steel, 1.4539 (904L); manifold: stainless steel, 1.4404 (316L)

Process connections

- Flanges similar to EN 1092-1 (DIN2501) / similar to ASME B 16.5 / as per JIS B2220: Stainless steel, 1.4404 (F316/F316L)
- All other process connections: Stainless steel, 1.4404 (316/316L)

 Available process connections →  108

Seals

Welded process connections without internal seals

Accessories

Protective cover

Stainless steel, 1.4404 (316L)

External WLAN antenna

- Antenna: ASA plastic (acrylonitrile styrene acrylate) and nickel-plated brass
- Adapter: Stainless steel and nickel-plated brass
- Cable: Polyethylene
- Plug: Nickel-plated brass
- Angle bracket: Stainless steel

Process connections

- Fixed flange connections:
 - EN 1092-1 (DIN 2501) flange
 - EN 1092-1 (DIN 2512N) flange
 - NAMUR lengths in accordance with NE 132
 - ASME B16.5 flange
 - JIS B2220 flange
 - DIN 11864-2 Form A flange, DIN 11866 series A, flange with notch
- Clamp connections:
 - Tri-Clamp (OD tubes), DIN 11866 series C
- Thread:
 - DIN 11851 thread, DIN 11866 series A
 - SMS 1145 thread
 - ISO 2853 thread, ISO 2037
 - DIN 11864-1 Form A thread, DIN 11866 series A
- VCO connections:
 - 8-VCO-4
 - 12-VCO-4



Process connection materials → 107

Surface roughness

All data relate to parts in contact with medium.

The following surface roughness categories can be ordered:

Category	Method	Option(s)/Order code "Measuring tube mat., wetted surface"
Not polished	–	SA
$Ra \leq 0.76 \mu\text{m}$ (30 μin) ¹⁾	Mechanically polished ²⁾	SB
$Ra \leq 0.76 \mu\text{m}$ (30 μin) ¹⁾	Mechanically polished ²⁾ , welds in as-welded condition	SJ
$Ra \leq 0.38 \mu\text{m}$ (15 μin) ¹⁾	Mechanically polished ²⁾	SC
$Ra \leq 0.38 \mu\text{m}$ (15 μin) ¹⁾	Mechanically polished ²⁾ , welds in as-welded condition	SK

1) Ra according to ISO 21920

2) Inaccessible weld seams between pipe and manifold are excluded

Operability

Operation concept**Operator-oriented menu structure for user-specific tasks**

- Commissioning
- Operation
- Diagnosis
- Expert level

Quick and safe commissioning

- Guided menus ("Make-it-run" wizards) for applications
- Menu guidance with brief descriptions of the individual parameter functions
- Access to the device via web server
- WLAN access to the device via mobile handheld terminal, tablet or smart phone

Reliable operation

- Operation in local language
- Uniform operating philosophy applied to device and operating tools
- If replacing electronic modules, transfer the device configuration via the integrated memory (HistoROM backup) which contains the process and measuring device data and the event logbook. No need to reconfigure.

Efficient diagnostics increase measurement reliability

- Troubleshooting measures can be called up via the device and in the operating tools
- Diverse simulation options, logbook for events that occur and optional line recorder functions

Languages

Can be operated in the following languages:

- Via local operation
English, German, French, Spanish, Italian, Dutch, Portuguese, Polish, Russian, Turkish, Chinese, Japanese, Korean, Vietnamese, Czech, Swedish
- Via web browser
English, German, French, Spanish, Italian, Dutch, Portuguese, Polish, Russian, Turkish, Chinese, Japanese, Vietnamese, Czech, Swedish
- Via "FieldCare", "DeviceCare" operating tool: English, German, French, Spanish, Italian, Chinese, Japanese

Onsite operation

Via display module

Equipment level:

- Order code for "Display; operation", option F "4-line, illuminated, graphic display; touch control"
- Order code for "Display; operation", option G "4-line, illuminated, graphic display; touch control + WLAN"

 Information about WLAN interface →  117

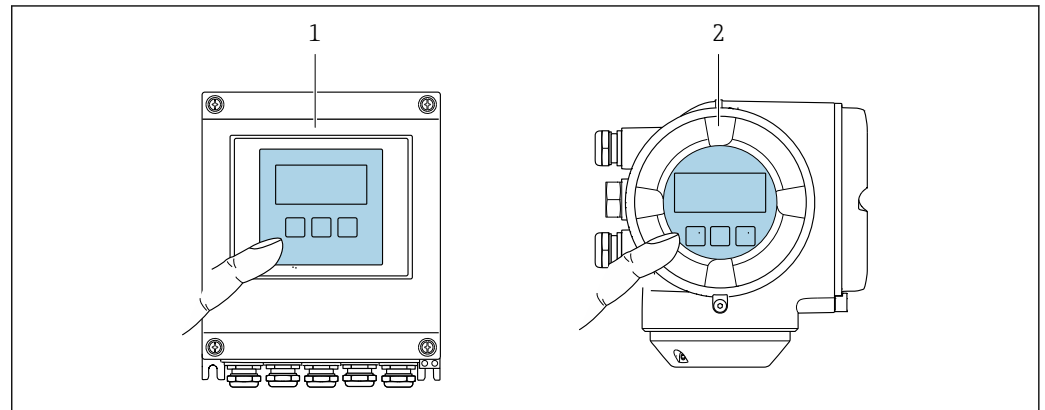

 47 Operation with touch control

- 1 Proline 500 – digital
- 2 Proline 500

Display elements

- 4-line, illuminated, graphic display
- White background lighting; switches to red in event of device errors
- Format for displaying measured variables and status variables can be individually configured

Operating elements

- External operation via touch control (3 optical keys) without opening the housing:  ,  , 
- Operating elements also accessible in the various zones of the hazardous area

Remote operation

Via HART protocol

This communication interface is available in device versions with a HART output.

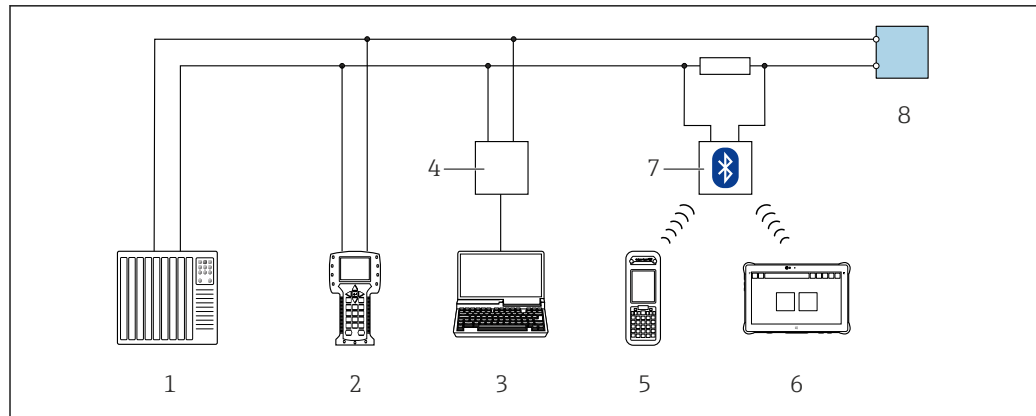

A0028747

48 Options for remote operation via HART protocol (active)

- 1 Automation system (e.g. PLC)
- 2 Field Communicator 475
- 3 Computer with web browser for accessing the integrated device web server or computer with operating tool (e.g. FieldCare, DeviceCare, AMS Device Manager, SIMATIC PDM) with COM DTM "CDI Communication TCP/IP"
- 4 Commubox FXA195 (USB)
- 5 Field Xpert SFX350 or SFX370
- 6 Field Xpert SMT70
- 7 VIATOR Bluetooth modem with connection cable
- 8 Transmitter

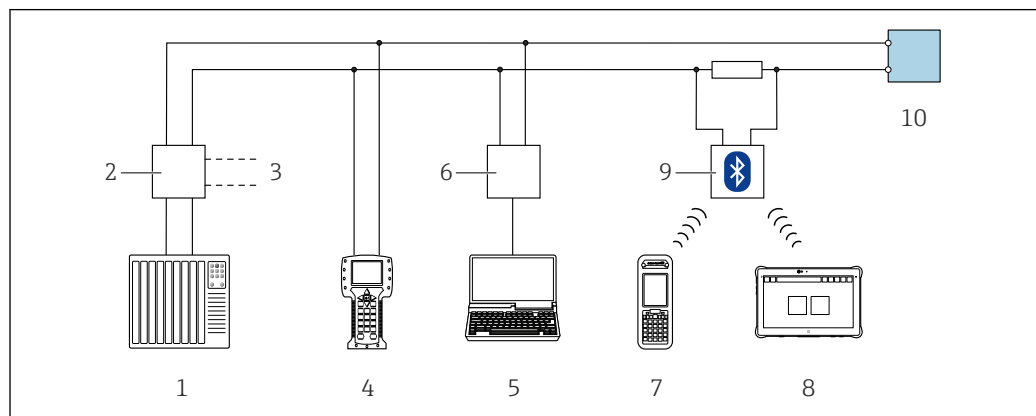

A0028746

49 Options for remote operation via HART protocol (passive)

- 1 Automation system (e.g. PLC)
- 2 Transmitter power supply unit, e.g. RN221N (with communication resistor)
- 3 Connection for Commubox FXA195 and Field Communicator 475
- 4 Field Communicator 475
- 5 Computer with web browser for accessing the integrated device web server or computer with operating tool (e.g. FieldCare, DeviceCare, AMS Device Manager, SIMATIC PDM) with COM DTM "CDI Communication TCP/IP"
- 6 Commubox FXA195 (USB)
- 7 Field Xpert SFX350 or SFX370
- 8 Field Xpert SMT70
- 9 VIATOR Bluetooth modem with connection cable
- 10 Transmitter

Via FOUNDATION Fieldbus network

This communication interface is available in device versions with FOUNDATION Fieldbus.

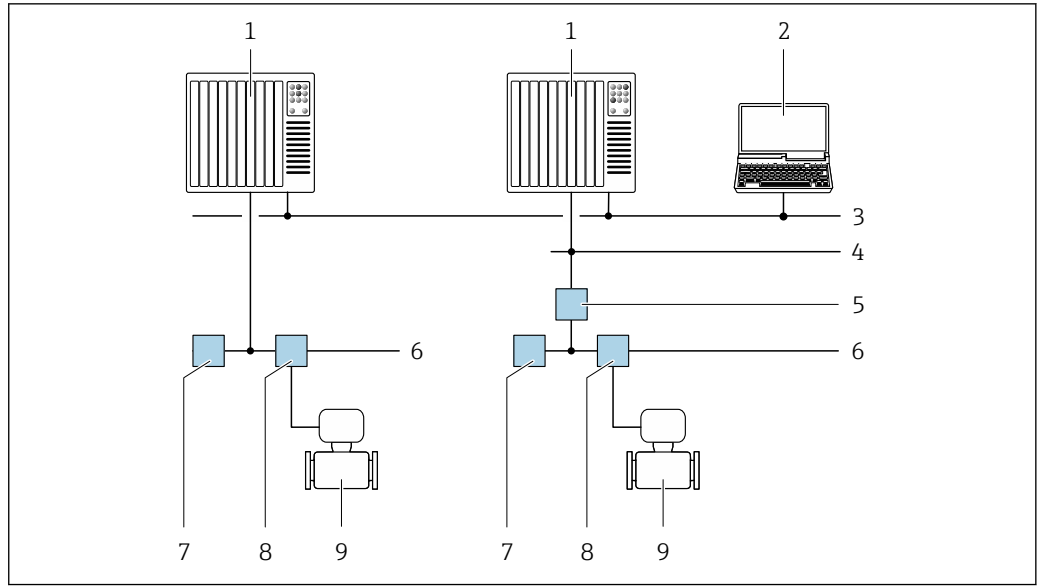

A0028837

50 Options for remote operation via FOUNDATION Fieldbus network

- 1 Automation system
- 2 Computer with FOUNDATION Fieldbus network card
- 3 Industry network
- 4 High Speed Ethernet FF-HSE network
- 5 Segment coupler FF-HSE/FF-H1
- 6 FOUNDATION Fieldbus FF-H1 network
- 7 Power supply FF-H1 network
- 8 T-box
- 9 Measuring instrument

Via PROFIBUS DP network

This communication interface is available in device versions with PROFIBUS DP.

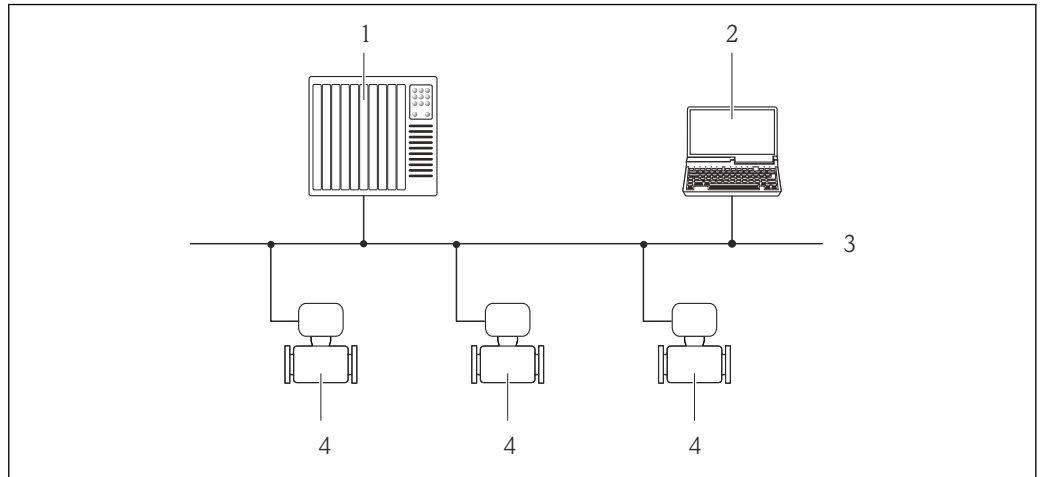

A0020903

51 Options for remote operation via PROFIBUS DP network

- 1 Automation system
- 2 Computer with PROFIBUS network card
- 3 PROFIBUS DP network
- 4 Measuring instrument

Via PROFIBUS PA network

This communication interface is available in device versions with PROFIBUS PA.

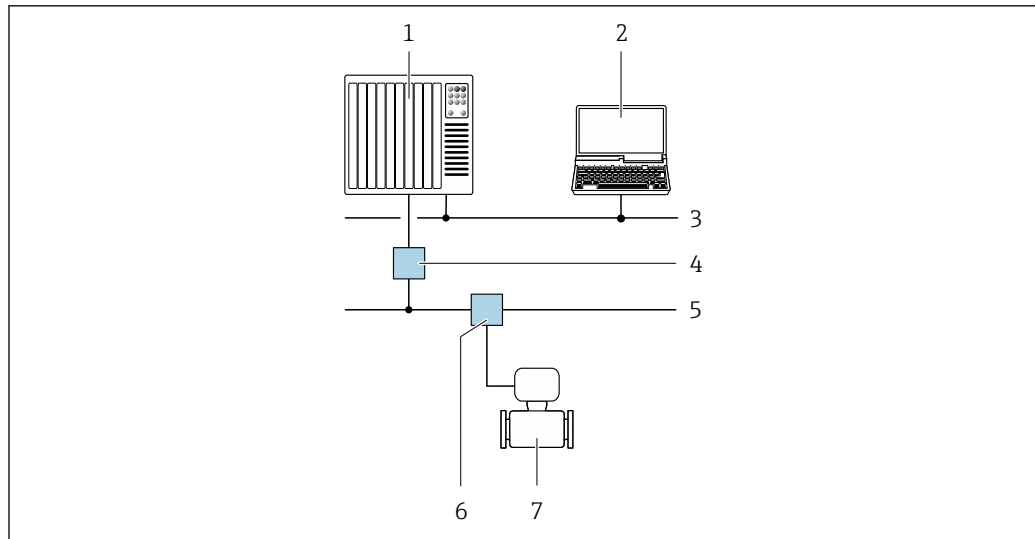

A0028838

52 Options for remote operation via PROFIBUS PA network

- 1 Automation system
- 2 Computer with PROFIBUS network card
- 3 PROFIBUS DP network
- 4 Segment coupler PROFIBUS DP/PA
- 5 PROFIBUS PA network
- 6 T-box
- 7 Measuring instrument

Via Modbus RS485 protocol

This communication interface is available in device versions with a Modbus RS485 output.

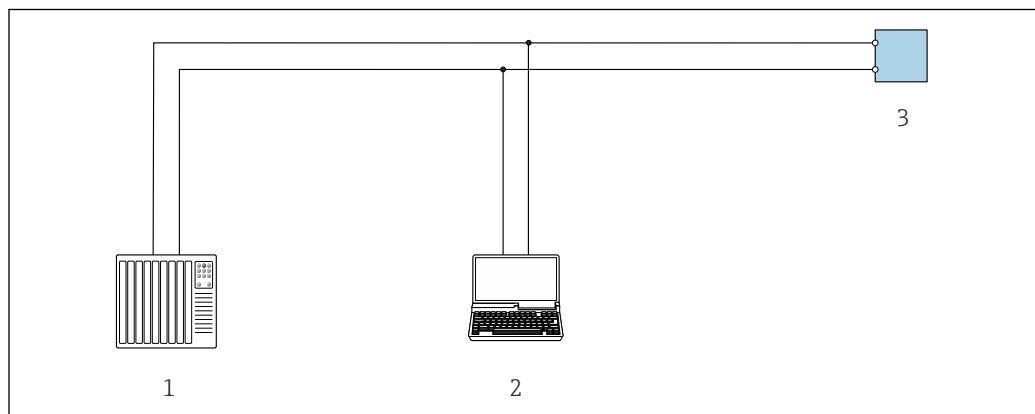

A0029437

53 Options for remote operation via Modbus RS485 protocol (active)

- 1 Automation system (e.g. PLC)
- 2 Computer with web browser for accessing the integrated device web server or with operating tool (e.g. FieldCare, DeviceCare) with COM DTM "CDI Communication TCP/IP" or Modbus DTM
- 3 Transmitter

Via EtherNet/IP network

This communication interface is available in device versions with EtherNet/IP.

Star topology

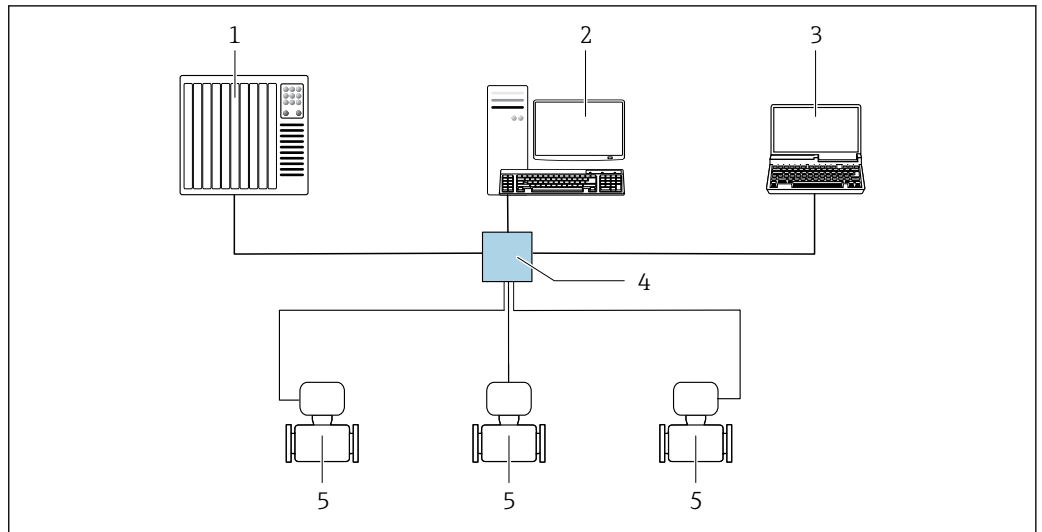

A0032078

54 Options for remote operation via Ethernet/IP network: star topology

- 1 Automation system, z. B. "RSLogix" (Rockwell Automation)
- 2 Workstation for measuring instrument operation: with Custom Add-On Profile for "RSLogix 5000" (Rockwell Automation) or with Electronic Data Sheet (EDS)
- 3 Computer with web browser for accessing the integrated web server or computer with operating tool (e.g. FieldCare, DeviceCare) with COM DTM "CDI Communication TCP/IP"
- 4 Standard Ethernet switch, e.g. Scalance X204 (Siemens)
- 5 Measuring instrument

Ring topology

The device is integrated via the terminal connection for signal transmission (output 1) and the service interface (CDI-RJ45).

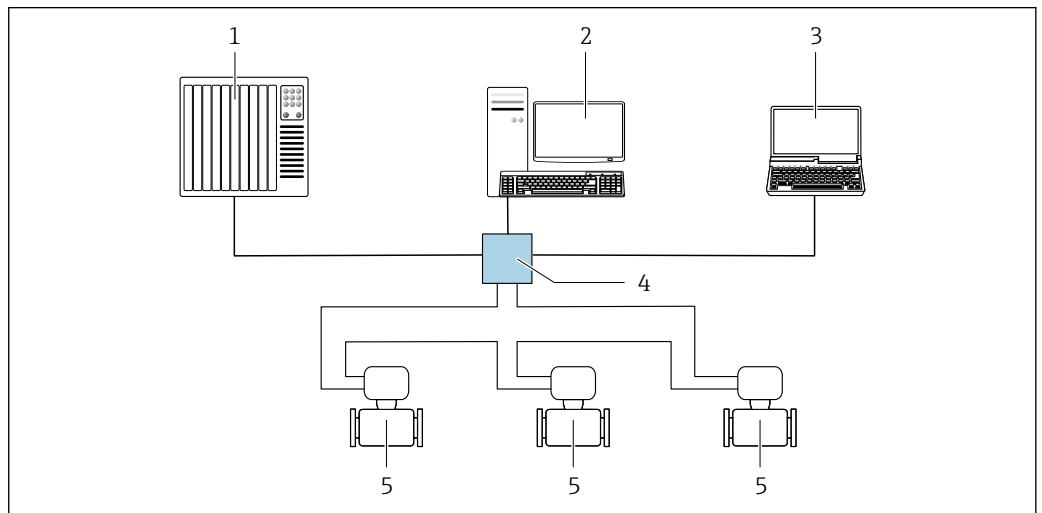

A0033725

55 Options for remote operation via EtherNet/IP network: ring topology

- 1 Automation system, z. B. "RSLogix" (Rockwell Automation)
- 2 Workstation for measuring instrument operation: with Custom Add-On Profile for RSLogix 5000 (Rockwell Automation) or with Electronic Data Sheet (EDS)
- 3 Computer with web browser for accessing the integrated web server or computer with operating tool (e.g. FieldCare, DeviceCare) with COM DTM "CDI Communication TCP/IP"
- 4 Standard Ethernet switch, e.g. Scalance X204 (Siemens)
- 5 Measuring instrument

Via PROFINET network

This communication interface is available in device versions with PROFINET.

Star topology

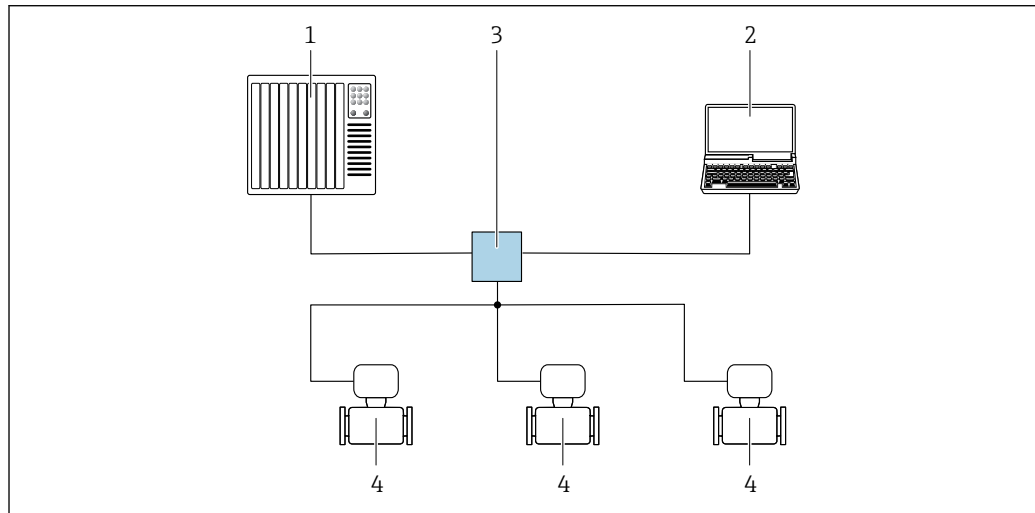

A0026545

56 Options for remote operation via PROFINET network: star topology

- 1 Automation system, e.g. Simatic S7 (Siemens)
- 2 Computer with web browser for accessing integrated web server or computer with operating tool (e.g. FieldCare, DeviceCare, SIMATIC PDM) with COM DTM "CDI Communication TCP/IP"
- 3 Standard Ethernet switch, e.g. Scalance X204 (Siemens)
- 4 Measuring instrument

Ring topology

The device is integrated via the terminal connection for signal transmission (output 1) and the service interface (CDI-RJ45).

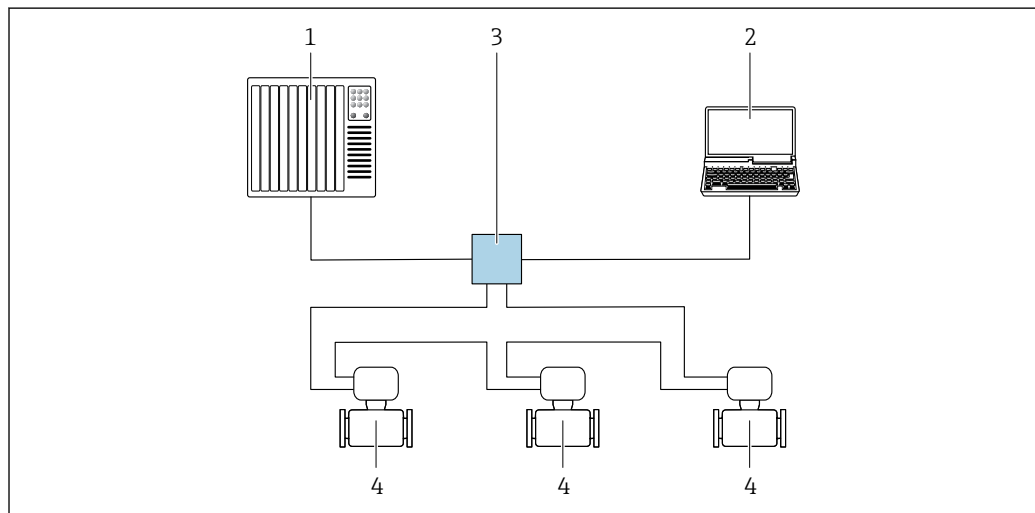

A0033719

57 Options for remote operation via PROFINET network: ring topology

- 1 Automation system, e.g., Simatic S7 (Siemens)
- 2 Computer with web browser for accessing integrated web server or computer with operating tool (e.g. FieldCare, DeviceCare, SIMATIC PDM) with COM DTM "CDI Communication TCP/IP"
- 3 Standard Ethernet switch, e.g. Scalance X204 (Siemens)
- 4 Measuring instrument

Via Modbus TCP over Ethernet-APL 10 Mbit/s, SPE 10 Mbit/s

This communication interface is available on port 1 in device versions with a Modbus TCP over Ethernet-APL output.

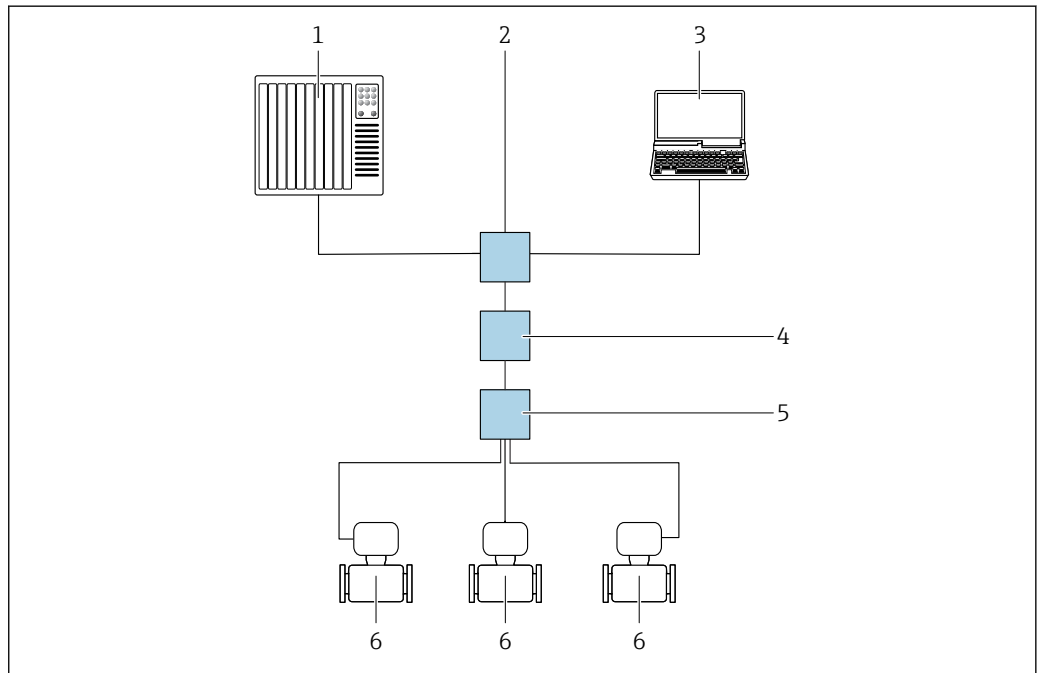

A0046117

58 Options for remote operation via Modbus TCP over Ethernet-APL protocol (active)

- 1 Automation system, e.g. Simatic S7 (Siemens)
- 2 Ethernet switch, e.g. Scalance X204 (Siemens)
- 3 Computer with web browser or operating tool
- 4 APL power switch/SPE power switch (optional)
- 5 APL field switch/SPE field switch
- 6 Measuring instrument/communication via port 1 (terminal 26 + 27)

Via Modbus TCP over Ethernet 100 Mbit/s

This communication interface is available on port 2 in device versions with a Modbus TCP over Ethernet-APL output.

Star topology

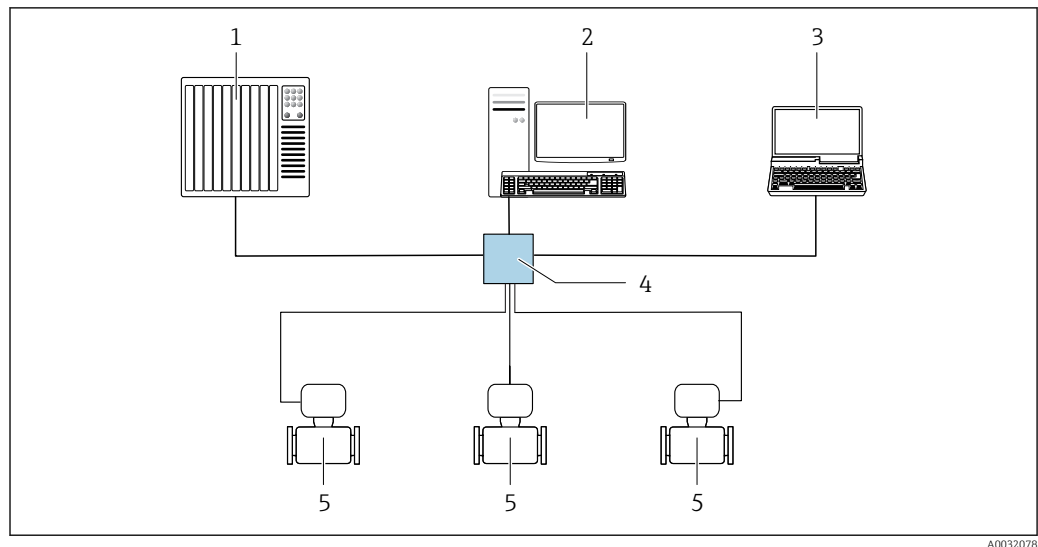

A0032078

59 Options for remote operation via Modbus TCP over Ethernet - 100 Mbit/s: Star topology

- 1 Automation system, z. B. RSLogix (Rockwell Automation)
- 2 Workstation for measuring instrument operation: with Custom Add-On Profile for "RSLogix 5000" (Rockwell Automation) or with Electronic Data Sheet (EDS)
- 3 Computer with web browser or operating tool
- 4 Standard Ethernet switch, e.g. Stratix (Rockwell Automation)
- 5 Measuring instrument/communication via port 2 (RJ45 connector)

Service interface

Via service interface (CDI-RJ45)

To configure the device on site, a point-to-point connection can be established. Alternatively, a connection via Modbus TCP can be used. The connection is made with the housing open, directly via the device's service interface (CDI-RJ45).

i An adapter for the RJ45 to the M12 connector is optionally available for the non-hazardous area:

Order code for "Accessories", option **NB**: "Adapter RJ45 M12 (service interface)"

The adapter connects the service interface (CDI-RJ45) to an M12 connector mounted in the cable entry. The connection to the service interface can be established via an M12 connector without opening the device.

Proline 500 – digital transmitter

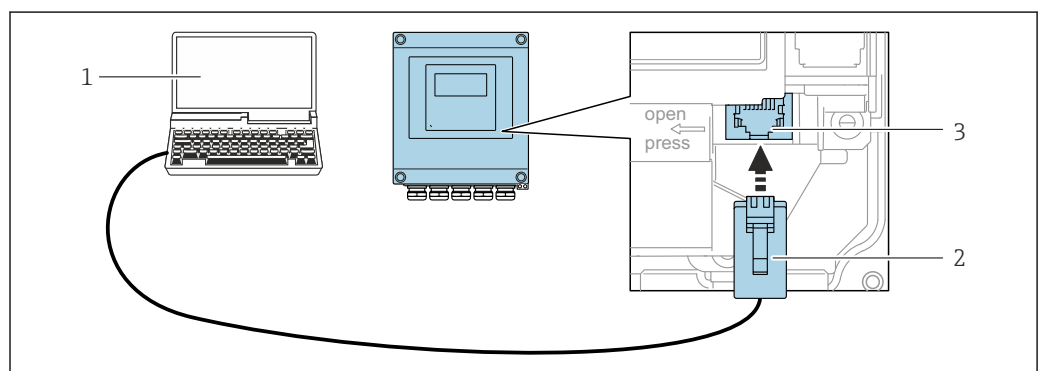

A0029163

60 Connection via service interface (CDI-RJ45)

- 1 Computer with web browser for accessing the integrated web server or computer with operating tool, e.g. "FieldCare", "DeviceCare" with COM DTM "CDI Communication TCP/IP" or operating tool
- 2 Standard Ethernet connecting cable with RJ45 connector
- 3 Service interface (CDI-RJ45) of the measuring instrument with access to the integrated web server

Proline 500 transmitter

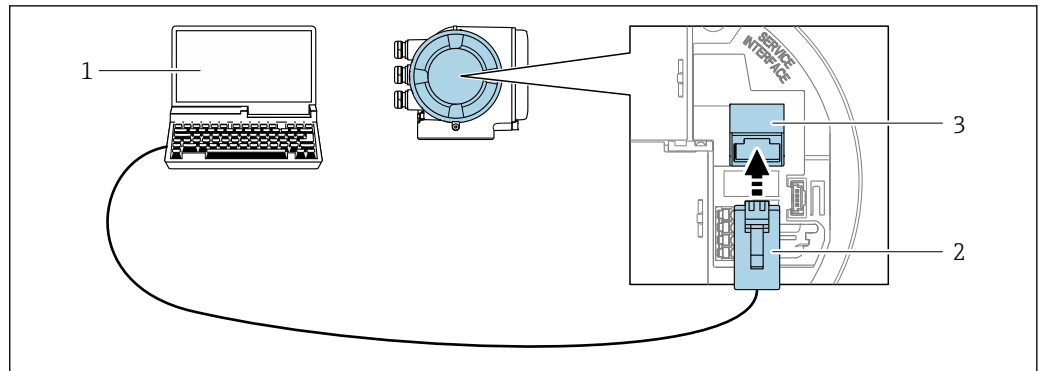

A0027563

61 Connection via service interface (CDI-RJ45)

- 1 Computer with web browser for accessing integrated web server or with operating tool e.g. "FieldCare", "DeviceCare", with COM DTM "CDI Communication TCP/IP" or Modbus DTM or operating tool
- 2 Standard Ethernet connecting cable with RJ45 connector
- 3 Service interface (CDI-RJ45) of the measuring instrument with access to the integrated web server

Via WLAN interface

The optional WLAN interface is available on the following device version:

Order code for "Display; operation", option G "4-line, illuminated; touch control + WLAN"

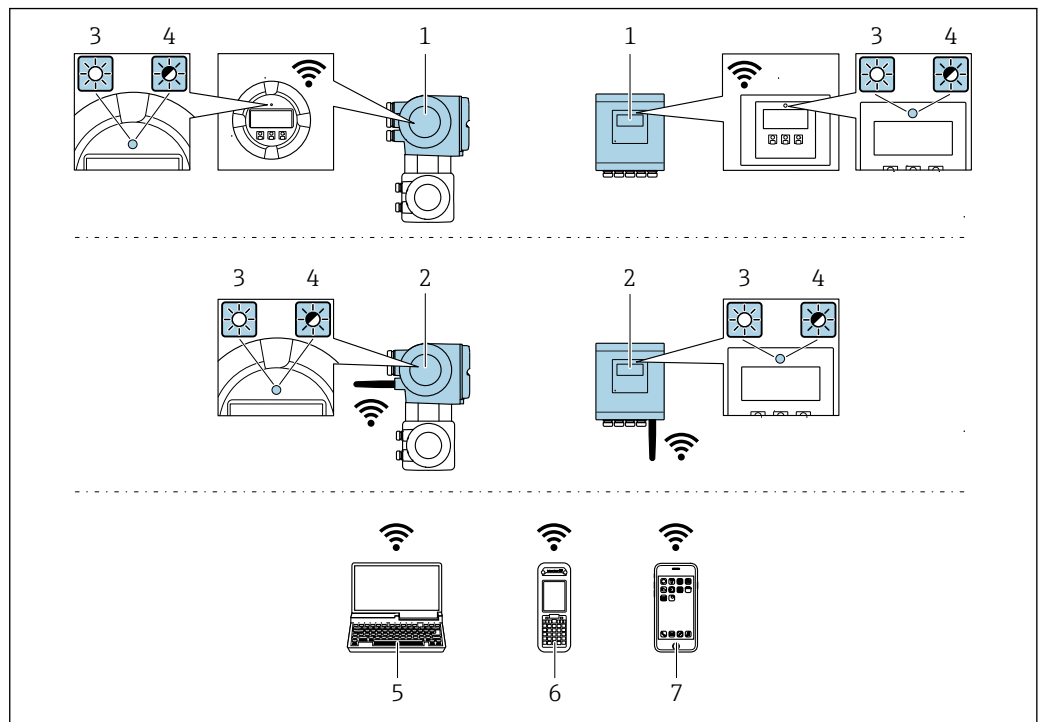

A0034569

- 1 Transmitter with integrated WLAN antenna
- 2 Transmitter with external WLAN antenna
- 3 LED lit constantly: WLAN reception is enabled on measuring instrument
- 4 LED flashing: WLAN connection established between operating unit and measuring instrument
- 5 Computer with WLAN interface and web browser for accessing integrated device web server or with operating tool e.g. FieldCare, DeviceCare)
- 6 Mobile handheld terminal with WLAN interface and web browser for accessing integrated device web server or operating tool (e.g. FieldCare, DeviceCare)
- 7 Smartphone or tablet (e.g. Field Xpert SMT70)

Function	WLAN: IEEE 802.11 b/g (2.4 GHz) <ul style="list-style-type: none"> ▪ Access point with DHCP server (factory setting) ▪ Network
Encryption	WPA2-PSK AES-128 (in accordance with IEEE 802.11i)
Configurable WLAN channels	1 to 11
Degree of protection	IP66/67
Available antennas	<ul style="list-style-type: none"> ▪ Internal antenna ▪ External antenna (optional) In the event of poor transmission/reception conditions at the place of installation. Available as an accessory .  Only 1 antenna is active at any one time!
Range	<ul style="list-style-type: none"> ▪ Internal antenna: typically 10 m (32 ft) ▪ External antenna: typically 50 m (164 ft)
Materials (external antenna)	<ul style="list-style-type: none"> ▪ Antenna: ASA plastic (acrylonitrile styrene acrylate) and nickel-plated brass ▪ Adapter: Stainless steel and nickel-plated brass ▪ Cable: Polyethylene ▪ Plug: Nickel-plated brass ▪ Angle bracket: Stainless steel

Network integration



Network integration is only available for the HART communication protocol.

With the optional "OPC UA Server" application package, the device can be integrated into an Ethernet network via the service interface (CDI-RJ45 and WLAN) and communicate with OPC UA clients. If the device is used in this way, IT security must be considered.



For detailed information on connecting transmitters with an Ex de approval, see separate document "Safety instructions" (XA) for the device.

For permanent access to device data and for device configuration via the web server, the device is incorporated directly in a network via the service interface (CDI-RJ45). In this way, the device can be accessed any time from the control station. The measured values are processed separately via the inputs and outputs through the automation system.

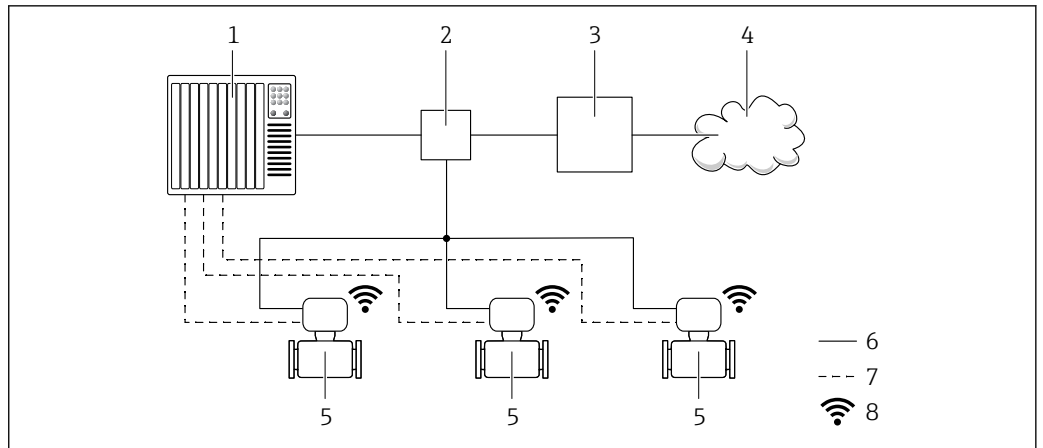

A0033618



- 1 Automation system, e.g. Simatic S7 (Siemens)
- 2 Ethernet switch
- 3 Edge Gateway
- 4 Cloud
- 5 Measuring instrument
- 6 Ethernet network
- 7 Measured values via inputs and outputs
- 8 Optional WLAN interface

 The optional WLAN interface is available on the following device version:
Order code for "Display; operation", option G "4-line, backlit, graphic display; touch control + WLAN"

 Special Documentation for the OPC UA Server application package →  133.

Supported operating tools

Different operating tools can be used for local or remote access to the measuring device. Depending on the operating tool used, access is possible with different operating units and via a variety of interfaces.

Supported operating tools	Operating unit	Interface	Additional information
Web browser	Notebook, PC or tablet with web browser	<ul style="list-style-type: none"> ▪ Service interface CDI-RJ45 ▪ WLAN interface ▪ Ethernet-based fieldbus (EtherNet/IP, PROFINET, Modbus TCP over Ethernet-APL) 	Special Documentation for device →  133
DeviceCare SFE100	Notebook, PC or tablet with Microsoft Windows system	<ul style="list-style-type: none"> ▪ Service interface CDI-RJ45 ▪ WLAN interface ▪ Fieldbus protocol ▪ Modbus TCP over Ethernet-APL 	→  130

Supported operating tools	Operating unit	Interface	Additional information
FieldCare SFE500	Notebook, PC or tablet with Microsoft Windows system	<ul style="list-style-type: none"> ■ Service interface CDI-RJ45 ■ WLAN interface ■ Fieldbus protocol 	→  130
Field Xpert	SMT70/77/50	<ul style="list-style-type: none"> ■ All fieldbus protocols ■ WLAN interface ■ Bluetooth ■ Service interface CDI-RJ45 	Operating Instructions BAO1202S Device description files: Use update function of handheld terminal

 Other operating tools based on FDT technology with a device driver such as DTM/iDTM or DD/EDD can be used for device operation. These operating tools are available from the individual manufacturers. Integration into the following operating tools, among others, is supported:

- FactoryTalk AssetCentre (FTAC) from Rockwell Automation → www.rockwellautomation.com
- Process Device Manager (PDM) from Siemens → www.siemens.com
- Asset Management Solutions (AMS) from Emerson → www.emersonprocess.com
- FieldCommunicator 375/475 from Emerson → www.emersonprocess.com
- Emersons TREX → www.emerson.com
- Field Device Manager (FDM) from Honeywell → www.process.honeywell.com
- FieldMate from Yokogawa → www.yokogawa.com
- PACTWare → www.pactware.com

The related device description files are available: www.endress.com → Download Area



Web server

The integrated web server can be used to operate and configure the device via a web browser via Ethernet-APL, via service interface (CDI-RJ45) or via WLAN interface. The structure of the operating menu is the same as for the local display. In addition to the measured values, status information on the device is displayed and can be used to monitor device health. Furthermore the device data can be managed and the network parameters can be configured.

A device that has a WLAN interface (can be ordered as an option) is required for the WLAN connection: order code for "Display; Operation", option G "4-line, illuminated; touch control + WLAN". The device acts as an Access Point and enables communication by computer or a mobile handheld terminal.

Supported functions

Data exchange between the operating unit (such as a notebook, for example,) and measuring instrument:

- Upload the configuration from the measuring instrument (XML format, configuration backup)
- Save the configuration to the measuring instrument (XML format, restore configuration)
- Export event list (.csv file)
- Export parameter settings (.csv file or PDF file, document the measuring point configuration)
- Export the Heartbeat Technology verification report (PDF file, only available with the **Heartbeat Verification** →  126 application package)
- Flash firmware version for device firmware upgrade, for example
- Download driver for system integration
- Visualize up to 1000 saved measured values (only available with the **Extended HistoROM** application package →  126)

HistoROM data management

The measuring instrument features HistoROM data management. HistoROM data management comprises both the storage and import/export of key device and process data, making operation and servicing far more reliable, secure and efficient.

 When the device is delivered, the factory settings of the configuration data are stored as a backup in the device memory. This memory can be overwritten with an updated data record, for example after commissioning.

Additional information on the data storage concept

There are different types of data storage units in which device data are stored and used by the device:

	HistoROM backup	T-DAT	S-DAT
Available data	<ul style="list-style-type: none"> ▪ Event logbook, e.g. diagnostic events ▪ Parameter data record backup ▪ Device firmware package ▪ Driver for system integration for exporting via web server, e.g.: <ul style="list-style-type: none"> ▪ GSD for PROFIBUS DP ▪ GSD for PROFIBUS PA ▪ GSD for PROFINET ▪ EDS for EtherNet/IP ▪ DD for FOUNDATION Fieldbus 	<ul style="list-style-type: none"> ▪ Measured value logging ("Extended HistoROM" order option) ▪ Current parameter data record (used by firmware at run time) ▪ Indicator (minimum/maximum values) ▪ Totalizer value 	<ul style="list-style-type: none"> ▪ Sensor data: e.g. nominal diameter ▪ Serial number ▪ Calibration data ▪ Device configuration (e.g. SW options, fixed I/O or multi I/O)
Storage location	Fixed on the user interface PC board in the connection compartment	Can be plugged into the user interface PC board in the connection compartment	In the sensor plug in the transmitter neck part

Data backup

Automatic

- The most important device data (sensor and transmitter) are automatically saved in the DAT modules
- If the transmitter or measuring device is replaced: once the T-DAT containing the previous device data has been exchanged, the new measuring device is ready for operation again immediately without any errors
- If the sensor is replaced: once the sensor has been replaced, new sensor data are transferred from the S-DAT in the measuring device and the measuring device is ready for operation again immediately without any errors
- If exchanging the electronics module (e.g. I/O electronics module): Once the electronics module has been replaced, the software of the module is compared against the current device firmware. The module software is upgraded or downgraded where necessary. The electronics module is available for use immediately afterwards and no compatibility problems occur.

Manual

Additional parameter data record (complete parameter settings) in the integrated device memory HistoROM backup for:

- Data backup function
Backup and subsequent restoration of a device configuration in the device memory HistoROM backup
- Data comparison function
Comparison of the current device configuration with the device configuration saved in the device memory HistoROM backup

Data transmission

Manual

- Transfer of a device configuration to another device using the export function of the specific operating tool, e.g. with FieldCare, DeviceCare or web server: to duplicate the configuration or to store in an archive (e.g. for backup purposes)
- Transmission of the drivers for system integration via web server, e.g.:
 - GSD for PROFIBUS DP
 - GSD for PROFIBUS PA
 - GSD for PROFINET
 - EDS for Ethernet/IP
 - DD for FOUNDATION fieldbus

Event list

Automatic

- Chronological display of up to 20 event messages in the events list
- If the **Extended HistoROM** application package (order option) is enabled: up to 100 event messages are displayed in the events list along with a time stamp, plain text description and remedial measures
- The events list can be exported and displayed via a variety of interfaces and operating tools e.g. DeviceCare, FieldCare or Web server

Data logging**Manual**

If the **Extended HistoROM** application package (order option) is enabled:

- Recording of 1 to 4 channels of up to 1 000 measured values (up to 250 measured values per channel)
- User configurable recording interval
- Export the measured value log via a variety of interfaces and operating tools e.g. FieldCare, DeviceCare or web server

Certificates and approvals

Current certificates and approvals for the product are available at www.endress.com on the relevant product page:

1. Select the product using the filters and search field.
2. Open the product page.
3. Select **Downloads**.

CE mark	<p>The device meets the legal requirements of the applicable EU Directives. These are listed in the corresponding EU Declaration of Conformity along with the standards applied.</p> <p>Endress+Hauser confirms successful testing of the device by affixing to it the CE mark.</p>
UKCA marking	<p>The device meets the legal requirements of the applicable UK regulations (Statutory Instruments). These are listed in the UKCA Declaration of Conformity along with the designated standards. By selecting the order option for UKCA marking, Endress+Hauser confirms a successful evaluation and testing of the device by affixing the UKCA mark.</p> <p>Contact address Endress+Hauser UK: Endress+Hauser Ltd. Floats Road Manchester M23 9NF United Kingdom www.uk.endress.com</p>
RCM marking	<p>The measuring system meets the EMC requirements of the "Australian Communications and Media Authority (ACMA)".</p>
Ex approval	<p>The measuring device is certified for use in hazardous areas and the relevant safety instructions are provided in the separate "Safety Instructions" (XA) document. Reference is made to this document on the nameplate.</p> <p>The following devices have equipment protection level (EPL) Ga/Gb (Zone 0 in the measuring tube):</p> <ul style="list-style-type: none"> ▪ Device versions with the order code for "Integrated ISEM electronics", option A and the order code for "Approval; transmitter; sensor", option BI, BJ, BM or BN. ▪ Device versions with the order code for "Integrated ISEM electronics", option B and the order code for "Approval; transmitter; sensor", option BA, BB, BC or BD. <p> The separate Ex documentation (XA) containing all the relevant explosion protection data is available from your Endress+Hauser sales center.</p>

Hygienic compatibility

- 3-A approval
 - Only measuring instruments with the order code for "Additional approval", option LP "3A" have 3-A approval.
 - The 3-A approval refers to the measuring instrument.
 - When installing the measuring instrument, ensure that no liquid can accumulate on the outside of the measuring instrument.
A remote display module must be installed in accordance with the 3-A Standard.
 - Accessories (e.g. heating jacket, weather protection cover, wall holder unit) must be installed in accordance with the 3-A Standard.
Each accessory can be cleaned. Disassembly may be necessary under certain circumstances.
- EHEDG-tested (Type EL Class I)
Only devices with the order code for "Additional approval", option LT "EHEDG" have been tested and meet the requirements of the EHEDG.
To meet the requirements for EHEDG certification, the device must be used with process connections in accordance with the EHEDG position paper entitled "Easy cleanable Pipe couplings and Process connections" (www.ehedg.org).
To meet the requirements for EHEDG certification, the orientation of the device must ensure drainability.
Test criteria for cleanability according to EHEDG is a flow velocity of 1.5 m/s in the process line. This speed must be ensured for EHEDG-compliant cleaning.
- FDA CFR 21
- Food Contact Materials Regulation (EC) 1935/2004
- Food Contact Materials Regulation GB 4806
- The requirements of the Food Contact Material regulations must be observed when selecting the material versions.



Observe special installation instructions

Pharmaceutical compatibility

- FDA 21 CFR 177
- USP <87>
- USP <88> Class VI 121 °C
- TSE/BSE Certificate of Suitability
- cGMP
Devices with the order code for "Test, certificate", option JG "Conformity with cGMP-derived requirements, declaration" comply with the requirements of cGMP with regard to the surfaces of parts in contact with the medium, design, FDA 21 CFR material conformity, USP Class VI tests and TSE/BSE conformity.
A serial number-specific declaration is generated.

Functional safety

The measuring instrument can be used for flow monitoring systems (min., max., range) up to SIL 2 (single-channel architecture; order code for "Additional approval", option LA) and SIL 3 (multi-channel architecture with homogeneous redundancy) and is independently evaluated and certified in accordance with IEC 61508.

The following types of monitoring in safety equipment are possible:

- Mass flow
- Volume flow
- Density



Functional safety manual with information for the SIL device → 132

HART certification**HART interface**

The measuring device is certified and registered by the FieldComm Group. The measuring system meets all the requirements of the following specifications:

- Certified according to HART 7
- The device can also be operated with certified devices of other manufacturers (interoperability)

FOUNDATION Fieldbus certification**FOUNDATION Fieldbus interface**

The measuring device is certified and registered by the FieldComm Group. The measuring system meets all the requirements of the following specifications:

- Certified in accordance with FOUNDATION Fieldbus H1
- Interoperability Test Kit (ITK), revision version 6.2.0 (certificate available on request)
- Physical Layer Conformance Test
- The device can also be operated with certified devices of other manufacturers (interoperability)

Certification PROFIBUS**PROFIBUS interface**

The measuring device is certified and registered by the PNO (PROFIBUS Nutzerorganisation e.V./ PROFIBUS User Organization). The measuring system meets all the requirements of the following specifications:

- Certified according to PA Profile 3.02
- The device can also be operated with certified devices of other manufacturers (interoperability)

EtherNet/IP certification

The measuring device is certified and registered by the ODVA (Open Device Vendor Association). The measuring system meets all the requirements of the following specifications:

- Certified in accordance with the ODVA Conformance Test
- EtherNet/IP Performance Test
- EtherNet/IP PlugFest compliance
- The device can also be operated with certified devices of other manufacturers (interoperability)

Certification PROFINET**PROFINET interface**

The measuring instrument is certified and registered by the PROFIBUS Nutzerorganisation e.V. (PNO). The measuring system meets all the requirements of the following specifications:

- Certified according to:
 - Test specification for PROFINET devices
 - PROFINET Netload Class 2 100 Mbit/s
- The device can also be operated with certified devices of other manufacturers (interoperability).
- The device supports PROFINET S2 system redundancy.

PROFINET over Ethernet-APL certification**PROFINET interface**

The measuring instrument is certified and registered by the PROFIBUS Nutzerorganisation e.V. (PNO). The measuring system meets all the requirements of the following specifications:

- Certified according to:
 - Test specification for PROFINET devices
 - PROFINET PA Profile 4.02
 - PROFINET Netload Robustness Class 2 10 Mbit/s
 - APL conformance test
- The device can also be operated with certified devices of other manufacturers (interoperability)
- The device supports PROFINET S2 system redundancy.

Pressure Equipment Directive

The measuring instruments can be ordered with or without PED or PESR. If a device with PED or PESR is required, this must be ordered explicitly. For devices with nominal diameters less than or equal to DN 25 (NPS 1"), this is neither possible nor necessary. A UK order option must be selected for PESR under the order code for "Approvals".

- With the marking
 - a) PED/G1/x (x = category) or
 - b) PESR/G1/x (x = category)
 on the sensor nameplate, Endress+Hauser confirms compliance with the "Essential Safety Requirements"
 - a) specified in Annex I of the Pressure Equipment Directive 2014/68/EU or
 - b) Schedule 2 of Statutory Instruments 2016 No. 1105.
- Devices bearing this marking (PED or PESR) are suitable for the following types of medium:
 - Media in Group 1 and 2 with a vapor pressure greater than, or smaller and equal to 0.5 bar (7.3 psi)
 - Unstable gases
- Devices not bearing this marking (without PED or PESR) are designed and manufactured according to sound engineering practice. They meet the requirements of
 - a) Art. 4, Section 3 of the Pressure Equipment Directive 2014/68/EU or
 - b) Part 1, Section 8 of Statutory Instruments 2016 No. 1105.
 The scope of application is indicated
 - a) in diagrams 6 to 9 in Annex II of the Pressure Equipment Directive 2014/68/EU or
 - b) in Schedule 3, Section 2 of Statutory Instruments 2016 No. 1105.

Radio approval

The measuring instrument has radio approval.



For detailed information on the radio approval, see the Special Documentation → 133

Additional certification**Marine approval**

Currently valid certificates are available:

- In the Downloads area of the Endress+Hauser website: www.endress.com → Downloads
- Specify the following details:
 - Product root, e.g. 8E5B
 - Search: Approval & Certificates → Marine

CRN approval

Some device versions have CRN approval. A CRN-approved process connection with a CSA approval must be ordered for a CRN-approved device.

Tests and certificates

- EN10204-3.1 material certificate, wetted parts and sensor housing (order code for "Test, certificate", option JA)
- Pressure test, internal process, test report (order code for "Test, certificate", option JB)
- Surface roughness test ISO4287/Ra, (wetted parts), test report (option JE)
- Compliance with requirements derived from cGMP, Declaration (option JG)

External standards and guidelines

- EN 60529
Degrees of protection provided by enclosure (IP code)
- IEC/EN 60068-2-6
Environmental influences: Test procedure - Test Fc: vibrate (sinusoidal).
- IEC/EN 60068-2-31
Environmental influences: Test procedure - Test Ec: shocks due to rough handling, primarily for devices.
- EN 61010-1
Safety requirements for electrical equipment for measurement, control and laboratory use - general requirements
- GB 30439.5
Safety requirements for industrial automation products - Part 5: Flowmeter safety requirements
- EN 61326-1/-2-3
EMC requirements for electrical equipment for measurement, control and laboratory use
- NAMUR NE 21
Electromagnetic compatibility (EMC) of industrial process and laboratory control equipment
- NAMUR NE 32
Data retention in the event of a power failure in field and control instruments with microprocessors

- NAMUR NE 43
Standardization of the signal level for the breakdown information of digital transmitters with analog output signal.
- NAMUR NE 53
Software of field devices and signal-processing devices with digital electronics
- NAMUR NE 80
The application of the pressure equipment directive to process control devices
- NAMUR NE 105
Specifications for integrating fieldbus devices in engineering tools for field devices
- NAMUR NE 107
Self-monitoring and diagnostics of field devices
- NAMUR NE 131
Requirements for field devices for standard applications
- NAMUR NE 132
Coriolis mass meter
- ETSI EN 300 328
Guidelines for 2.4 GHz radio components.
- EN 301489
Electromagnetic compatibility and radio spectrum matters (ERM).

Ordering information

Detailed ordering information is available from your nearest sales organization www.addresses.endress.com or in the Product Configurator at www.endress.com:

1. Select the product using the filters and search field.
2. Open the product page.
3. Select **Configuration**.



Product Configurator - the tool for individual product configuration

- Up-to-the-minute configuration data
- Depending on the device: direct input of information specific to the measuring point, such as the measuring range or operating language
- Automatic verification of exclusion criteria
- Automatic creation of the order code and its breakdown in PDF or Excel output format
- Ability to order directly in the Endress+Hauser Online Shop

Application packages

Many different application packages are available to enhance the functionality of the device. Such packages might be needed to address safety aspects or specific application requirements.

The application packages can be ordered with the device or subsequently from Endress+Hauser. Detailed information on the order code in question is available from your local Endress+Hauser sales center or on the product page of the Endress+Hauser website: www.endress.com.



Detailed information on the application packages:
Special Documentation → 132

Diagnostic functionality

Order code for "Application package", option EA "Extended HistoROM"

Comprises extended functions concerning the event log and the activation of the measured value memory.

Event log:

Memory volume is extended from 20 message entries (standard version) to up to 100 entries.

Data logging (line recorder):

- Memory capacity for up to 1000 measured values is activated.
- 250 measured values can be output via each of the 4 memory channels. The recording interval can be defined and configured by the user.
- Measured value logs can be accessed via the local display or operating tool e.g. FieldCare, DeviceCare or Web server.



For detailed information, see the Operating Instructions for the device.

Heartbeat Technology

Order code for "Application package", option EB "Heartbeat Verification + Monitoring"

Heartbeat Verification

Meets the requirement for traceable verification in accordance with DIN ISO 9001:2015 Clause 7.6 a) "Control of monitoring and measuring equipment".

- Functional testing in the installed state without interrupting the process.
- Traceable verification results on request, including a report.
- Simple testing process via local operation or other operating interfaces.
- Clear measuring point assessment (pass/fail) with high total test coverage within the framework of manufacturer specifications.
- Extension of calibration intervals according to operator's risk evaluation.

Heartbeat Monitoring

Continuously supplies data, which are characteristic of the measuring principle, to an external condition monitoring system for the purpose of preventive maintenance or process analysis. These data enable the operator to:

- Draw conclusions - using these data and other information - about the impact the process influences (e.g. corrosion, abrasion, deposit buildup etc.) have on measuring performance over time.
- Schedule servicing in time.
- Monitor the process or product quality, e.g. gas pockets.



Detailed information on Heartbeat Technology:
Special Documentation → 132

Concentration measurement

Order code for "Application package", option ED "Concentration"

Calculation and outputting of fluid concentrations.

The measured density is converted to the concentration of a substance of a binary mixture using the "Concentration" application package:

- Choice of predefined fluids (e.g. various sugar solutions, acids, alkalis, salts, ethanol etc.).
- Common or user-defined units ("Brix", "Plato", % mass, % volume, mol/l etc.) for standard applications.
- Concentration calculation from user-defined tables.



For detailed information, see the Special Documentation for the device.

Petroleum

Order code for "Application package", option EJ "Petroleum"

The most important parameters for the Oil & Gas Industry can be calculated and displayed with this application package.

- Corrected volume flow and calculated reference density in accordance with the "API Manual of Petroleum Measurement Standards, Chapter 11.1"
- Water content, based on density measurement
- Weighted mean of the density and temperature



For detailed information, see the Special Documentation for the device.

Petroleum & locking function

Order code for "Application package", option EM "Petroleum & locking function"

The most important parameters for the Oil & Gas Industry can be calculated and displayed with this application package. It is also possible to lock the settings.

- Corrected volume flow and calculated reference density in accordance with the "API Manual of Petroleum Measurement Standards, Chapter 11.1"
- Water content, based on density measurement
- Weighted mean of the density and temperature



For detailed information, see the Special Documentation for the device.

OPC-UA Server

Order code for "Application package", option EL "OPC-UA Server"

The application package provides an integrated OPC-UA server for comprehensive device services for IoT and SCADA applications.



For detailed information, see the Special Documentation for the device.











Accessories







Various accessories, which can be ordered with the device or subsequently from Endress+Hauser, are available for the device. Detailed information on the order code in question is available from your local Endress+Hauser sales center or on the product page of the Endress+Hauser website:

www.endress.com.



Device-specific accessories

For the transmitter



Accessory	Description
Transmitter <ul style="list-style-type: none"> ▪ Proline 500 – digital ▪ Proline 500 	Transmitter for replacement or storage. Use the order code to define the following specifications: <ul style="list-style-type: none"> ▪ Approvals ▪ Output ▪ Input ▪ Display/operation ▪ Housing ▪ Software <p> ▪ Proline 500 – digital transmitter: Order number: 8X5BXX-*****A</p> <p>▪ Proline 500 transmitter: Order number: 8X5BXX-*****B</p> <p> Proline 500 transmitter for replacement: It is essential to specify the serial number of the current transmitter when ordering. On the basis of the serial number, the device-specific data (e.g. calibration factors) of the replaced device can be used for the new transmitter.</p> <p> ▪ Proline 500 – digital transmitter: Installation Instructions EA01151D</p> <p>▪ Proline 500 transmitter: Installation Instructions EA01152D</p>
External WLAN antenna	External WLAN antenna with 1.5 m (59.1 in) connecting cable and two angle brackets. Order code for "Accessory enclosed", option P8 "Wireless antenna wide area". <p> ▪ The external WLAN antenna is not suitable for use in hygienic applications.</p> <p>▪ Further information on the WLAN interface →  117.</p> <p> Order number: 71351317</p> <p> Installation Instructions EA01238D</p>
Pipe mounting set	Pipe mounting set for transmitter. <p> Proline 500 – digital transmitter Order number: 71346427</p> <p> Installation Instructions EA01195D</p> <p> Proline 500 transmitter Order number: 71346428</p>



<p>Protective cover Transmitter</p> <ul style="list-style-type: none"> ▪ Proline 500 – digital ▪ Proline 500 	<p>Is used to protect the measuring instrument from the effects of the weather: e.g. rainwater, excess heating from direct sunlight.</p> <ul style="list-style-type: none">  <ul style="list-style-type: none"> ▪ Proline 500 – digital transmitter Order number: 71343504 ▪ Proline 500 transmitter Order number: 71343505  Installation Instructions EA01191D
<p>Display guard Proline 500 – digital</p>	<p>Is used to protect the display against impact or scoring, for example from sand in desert areas.</p> <ul style="list-style-type: none">  Order number: 71228792  Installation Instructions EA01093D
<p>Connecting cable Proline 500 – digital Sensor – Transmitter</p>	<p>The connecting cable can be ordered directly with the measuring instrument (order code for "Cable, sensor connection") or as an accessory (order number DK8012).</p> <p>The following cable lengths are available: order code for "Cable, sensor connection"</p> <ul style="list-style-type: none"> ▪ Option B: 20 m (65 ft) ▪ Option E: User-configurable up to max. 50 m ▪ Option F: User-configurable up to max. 165 ft <ul style="list-style-type: none">  Maximum possible cable length for a Proline 500 – digital connecting cable: 300 m (1 000 ft)
<p>Connecting cable Proline 500 Sensor – Transmitter</p>	<p>The connecting cable can be ordered directly with the measuring instrument (order code for "Cable, sensor connection") or as an accessory (order number DK8012).</p> <p>The following cable lengths are available: order code for "Cable, sensor connection"</p> <ul style="list-style-type: none"> ▪ Option 1: 5 m (16 ft) ▪ Option 2: 10 m (32 ft) ▪ Option 3: 20 m (65 ft) <ul style="list-style-type: none">  Possible cable length for a Proline 500 connecting cable: max. 20 m (65 ft)

For the sensor



Accessories	Description
<p>Heating jacket</p>	<p>Is used to stabilize the temperature of the fluids in the sensor. Water, water vapor and other non-corrosive liquids are permitted for use as fluids.</p> <ul style="list-style-type: none">  If using oil as a heating medium, please consult with Endress+Hauser. <p>Heating jackets cannot be used with sensors fitted with a rupture disk. Use the order code with the product root DK8003.</p> <ul style="list-style-type: none">  Special Documentation SD02151D





Communication-specific accessories

Accessories	Description
<p>Commubox FXA195 HART</p>	<p>For intrinsically safe HART communication with FieldCare via the USB interface.</p> <ul style="list-style-type: none">  Technical Information TI00404F
<p>HART loop converter HMX50</p>	<p>Is used to evaluate and convert dynamic HART process variables to analog current signals or limit values.</p> <ul style="list-style-type: none">  <ul style="list-style-type: none"> ▪ Technical Information TI00429F ▪ Operating Instructions BA00371F
<p>Fieldgate FXA42</p>	<p>Transmission of the measured values of connected 4 to 20 mA analog measuring instruments, as well as digital measuring instruments</p> <ul style="list-style-type: none">  <ul style="list-style-type: none"> ▪ Technical Information TI01297S ▪ Operating Instructions BA01778S ▪ Product page: www.endress.com/fxa42

Field Xpert SMT50	<p>The Field Xpert SMT50 tablet PC for device configuration enables mobile plant asset management in non-hazardous areas. It is suitable for commissioning and maintenance staff to manage field instruments with a digital communication interface and to record progress.</p> <p>This tablet PC is designed as an all-in-one solution with a preinstalled driver library and is an easy-to-use, touch-sensitive tool which can be used to manage field instruments throughout their entire life cycle.</p>  <ul style="list-style-type: none"> ▪ Technical Information TI01555S ▪ Operating Instructions BA02053S ▪ Product page: www.endress.com/smt50
Field Xpert SMT70	<p>The Field Xpert SMT70 tablet PC for device configuration enables mobile plant asset management in hazardous and non-hazardous areas. It is suitable for commissioning and maintenance staff to manage field instruments with a digital communication interface and to record progress.</p> <p>This tablet PC is designed as an all-in-one solution with a preinstalled driver library and is an easy-to-use, touch-sensitive tool which can be used to manage field instruments throughout their entire life cycle.</p>  <ul style="list-style-type: none"> ▪ Technical Information TI01342S ▪ Operating Instructions BA01709S ▪ Product page: www.endress.com/smt70
Field Xpert SMT77	<p>The Field Xpert SMT77 tablet PC for device configuration enables mobile plant asset management in areas categorized as Ex Zone 1.</p>  <ul style="list-style-type: none"> ▪ Technical Information TI01418S ▪ Operating Instructions BA01923S ▪ Product page: www.endress.com/smt77

Service-specific accessories

Accessory	Description
Applicator	<p>Software for selecting and sizing Endress+Hauser measuring instruments:</p> <ul style="list-style-type: none"> ▪ Choice of measuring instruments for industrial requirements ▪ Calculation of all the necessary data for identifying the optimum flowmeter: e.g. nominal diameter, pressure loss, flow velocity and measurement accuracy. ▪ Graphic display of the calculation results ▪ Determining the partial order code. Administration, documentation and access to all project-related data and parameters over the entire life cycle of a project. <p>Applicator is available: Via the Internet: https://portal.endress.com/webapp/applicator</p>
Netilion	<p>IIoT ecosystem: Unlock knowledge</p> <p>With the Netilion IIoT ecosystem, Endress+Hauser allows you to optimize your plant performance, digitize workflows, share knowledge, and enhance collaboration.</p> <p>Based on decades of experience in process automation, Endress+Hauser offers the process industry an IIoT ecosystem that enables you to gain useful insights from data. These insights can be used to optimize processes, leading to increased plant availability, efficiency, and reliability - ultimately resulting in a more profitable plant.</p> <p>www.netilion.endress.com</p>
FieldCare	<p>FDT-based plant asset management tool from Endress+Hauser.</p> <p>It can configure all intelligent field units in your system and helps you manage them. By using the status information, it is also a simple but effective way of checking their status and condition.</p>  <ul style="list-style-type: none"> ▪ Operating Instructions BA00027S and BA00059S
DeviceCare	<p>Tool to connect and configure Endress+Hauser field devices.</p>  <ul style="list-style-type: none"> ▪ Technical Information: TI01134S ▪ Innovation brochure: INO1047S

System components	Accessories	Description
	Memograph M graphic data manager	The Memograph M graphic data manager provides information on all the relevant measured variables. Measured values are recorded correctly, limit values are monitored and measuring points analyzed. The data are stored in the 256 MB internal memory and also on a SD card or USB stick.  <ul style="list-style-type: none"> ▪ Technical Information TI00133R ▪ Operating Instructions BA00247R
	Cerabar M	The pressure transmitter for measuring the absolute and gauge pressure of gases, steam and liquids. It can be used to read in the operating pressure value.  <ul style="list-style-type: none"> ▪ Technical Information TI00426P and TI00436P ▪ Operating Instructions BA00200P and BA00382P
	Cerabar S	The pressure transmitter for measuring the absolute and gauge pressure of gases, steam and liquids. It can be used to read in the operating pressure value.  <ul style="list-style-type: none"> ▪ Technical Information TI00383P ▪ Operating Instructions BA00271P
	iTEMP	The temperature transmitters can be used in all applications and are suitable for the measurement of gases, steam and liquids. They can be used to read in the medium temperature.  "Fields of Activity" document FA00006T

Documentation

-  For an overview of the scope of the associated Technical Documentation, refer to the following:
- *Device Viewer* (www.endress.com/deviceviewer): Enter the serial number from the nameplate
 - *Endress+Hauser Operations app*: Enter serial number from nameplate or scan matrix code on nameplate.

Standard documentation

-  Supplementary information on the semi-standard options is available in the relevant Special Documentation in the TSP database.

Brief Operating Instructions

Brief Operating Instructions for the sensor

Measuring instrument	Documentation code
Proline Promass E	KA01260D

Brief Operating Instructions for the transmitter

Measuring instrument	Documentation code				
	HART	FOUNDATION Fieldbus	PROFIBUS PA	PROFIBUS DP	Modbus RS485
Proline 500 – digital	KA01315D	KA01233D	KA01392D	KA01390D	KA01319D
Proline 500	KA01314D	KA01291D	KA01391D	KA01389D	KA01318D

Brief Operating Instructions for the transmitter

Measuring instrument	Documentation code			
	EtherNet/IP	PROFINET	PROFINET over Ethernet-APL	Modbus TCP
Proline 500 – digital	KA01346D	KA01351D	KA01521D	KA01737D
Proline 500	KA01347D	KA01350D	KA01520D	KA01736D

Operating Instructions

Measuring instrument	Documentation code				
	HART	FOUNDATION Fieldbus	PROFIBUS PA	PROFIBUS DP	Modbus RS485
Promass E 500	BA01528D	BA01561D	BA01550D	BA01872D	BA01539D

Measuring instrument	Documentation code			
	EtherNet/IP	PROFINET	PROFINET over Ethernet-APL	Modbus TCP
Promass E 500	BA01749D	BA01760D	BA02124D	BA01539D

Description of Device Parameters

Measuring instrument	Documentation code				
	HART	FOUNDATION Fieldbus	PROFIBUS PA	PROFIBUS DP	Modbus RS485
Promass 500	GP01060D	GP01096D	GP01061D	GP01137D	GP01062D

Measuring instrument	Documentation code			
	EtherNet/IP	PROFINET	PROFINET over Ethernet-APL	Modbus TCP over Ethernet-APL
Promass 500	GP01120D	GP01121D	GP01173D	GP01236D

Device-dependent additional documentation

Safety instructions

Safety instructions for electrical equipment for hazardous areas.

Contents	Documentation code
	Measuring instrument
ATEX/IECEX Ex ia	XA01473D
ATEX/IECEX Ex ec	XA01474D
cCSAus IS	XA01475D
cCSAus Ex ia	XA01509D
cCSAus Ex ec	XA01510D
EAC Ex ia	XA01658D
EAC Ex ec	XA01659D
JPN Ex ia	XA01780D
KCs Ex ia	XA03287D
INMETRO Ex ia	XA01476D
INMETRO Ex ec	XA01477D
NEPSI Ex ia	XA01478D
NEPSI Ex nA	XA01479D
UKEX Ex ia	XA02570D
UKEX Ex ec	XA02572D

Functional Safety Manual

Contents	Documentation code
Proline Promass 500	SD01729D

Special Documentation

Contents	Documentation code
Information on the Pressure Equipment Directive	SD01614D
Radio approvals for WLAN interface for A309/A310 display module	SD01793D
OPC UA server ¹⁾	SD02040D
Modbus TCP system integration	SD03383D

1) This Special Documentation is only available for device versions with a HART output.

Contents	Documentation code				
	HART	FOUNDATION Fieldbus	PROFIBUS PA	PROFIBUS DP	Modbus RS485
Web server	SD01666D	SD01669D	SD01668D	SD02232D	SD01667D
Heartbeat Technology	SD01643D	SD01608D	SD01705D	SD02203D	SD01704D
Concentration measurement	SD01645D	SD01709D	SD01711D	SD02213D	SD01710D
Petroleum	SD02013D	–	SD02292D	SD02217D	SD02014D
Petroleum & locking function	SD02499D	–	–	–	SD02500D
Gas fraction handler	SD02584D	–	–	–	SD02584D

Contents	Documentation code			
	PROFINET	EtherNet/IP	PROFINET over Ethernet-APL	Modbus TCP
Web server	SD01971D	SD01970D	SD02769D	–
Heartbeat Technology	SD01989D	SD01983D	SD02732D	SD03351D
Concentration measurement	SD02007D	SD02006D	SD02736D	SD03355D
Petroleum	SD02015D	SD02012D	SD02740D	SD03359D
Petroleum & locking function	–	–	–	–
Gas fraction handler	SD02584D	–	SD02584D	SD02584D

Installation Instructions

Contents	Note
Installation instructions for spare part sets and accessories	The corresponding documentation code is listed with the relevant accessory. → 128.

Registered trademarks

HART®

Registered trademark of the FieldComm Group, Austin, Texas USA

PROFIBUS®

Registered trademark of the PROFIBUS Nutzerorganisation e.V. (PROFIBUS User Organization), Karlsruhe, Germany

FOUNDATION™ fieldbus

Registration-pending trademark of the FieldComm Group, Austin, Texas, USA

Modbus®

Registered trademark of SCHNEIDER AUTOMATION, INC.

Ethernet/IP™

Trademark of ODVA, Inc.

Ethernet-APL™

Registered trademark of the PROFIBUS Nutzerorganisation e.V. (PROFIBUS User Organization), Karlsruhe, Germany

PROFINET®

Registered trademark of the PROFIBUS Nutzerorganisation e.V. (PROFIBUS User Organization), Karlsruhe, Germany

TRI-CLAMP®

Registered trademark of Ladish & Co., Inc., Kenosha, USA



71776563

www.addresses.endress.com
