

Safety Instructions

Levelflex FMP50-FMP57

PROFIBUS PA, FOUNDATION Fieldbus

ATEX: II 1/2 G Ex ia IIC T6...T1 Ga/Gb
II 1/2 D Ex ia IIIC T85°C Da/Db

IECEX: Ex ia IIC T6...T1 Ga/Gb
Ex ia IIIC T85°C Da/Db



Levelflex FMP50-FMP57

PROFIBUS PA, FOUNDATION Fieldbus

Table of contents

About this document	4
Associated documentation	4
Supplementary documentation	4
Manufacturer's certificates	4
Manufacturer address	5
Other standards	5
Extended order code	5
Safety instructions: General	9
Safety instructions: Special conditions	10
Safety instructions: Installation	11
Safety instructions: Zone 0	14
Temperature tables	14
Connection data	17

About this document



This document has been translated into several languages. Legally determined is solely the English source text.

The document translated into EU languages is available:

- In the download area of the Endress+Hauser website:
www.endress.com -> Downloads -> Manuals and Datasheets -> Type: Ex Safety Instruction (XA) -> Text Search: ...
- In the Device Viewer: www.endress.com -> Product tools -> Access device specific information -> Check device features

Associated documentation

This document is an integral part of the following Operating Instructions:

PROFIBUS PA

- BA01005F/00 (FMP50)
- BA01006F/00 (FMP51, FMP52, FMP54)
- BA01007F/00 (FMP53)
- BA01008F/00 (FMP55)
- BA01009F/00 (FMP56, FMP57)

PROFIBUS PA

- BA01051F/00 (FMP50)
- BA01052F/00 (FMP51, FMP52, FMP54)
- BA01053F/00 (FMP53)
- BA01054F/00 (FMP55)
- BA01055F/00 (FMP56, FMP57)

Supplementary documentation

Explosion-protection brochure: CP00021Z/11

The Explosion-protection brochure is available:

- In the download area of the Endress+Hauser website:
www.endress.com -> Downloads -> Brochures and Catalogs -> Text Search: CP00021Z
- On the CD for devices with CD-based documentation

Manufacturer's certificates

EU Declaration of Conformity

Declaration Number:

EG10013

The EU Declaration of Conformity is available:

In the download area of the Endress+Hauser website:

www.endress.com -> Downloads -> Declaration ->

Type: EU Declaration -> Product Code: ...

EU type-examination certificate

Certificate number:
KEMA 10 ATEX 0093 X

List of applied standards: See EU Declaration of Conformity.

IEC Declaration of Conformity

Certificate number:
IECEX KEM 10.0043 X

Affixing the certificate number certifies conformity with the following standards (depending on the device version):

- IEC 60079-0 : 2017
- IEC 60079-11 : 2011 + Corr. 1: 2012
- IEC 60079-26 : 2014
- IEC 60079-31 : 2013

Manufacturer address

Endress+Hauser SE+Co. KG
Hauptstraße 1
79689 Maulburg, Germany

Address of the manufacturing plant: See nameplate.

Other standards

Among other things, the following standards shall be observed in their current version for proper installation:

- IEC/EN 60079-14: "Explosive atmospheres - Part 14: Electrical installations design, selection and erection"
- EN 1127-1: "Explosive atmospheres - Explosion prevention and protection - Part 1: Basic concepts and methodology"

Extended order code

The extended order code is indicated on the nameplate, which is affixed to the device in such a way that it is clearly visible. Additional information about the nameplate is provided in the associated Operating Instructions.

Structure of the extended order code

FMP5x	–	*****	+	A*B*C*D*E*F*G*..
<i>(Device type)</i>		<i>(Basic specifications)</i>		<i>(Optional specifications)</i>

* = Placeholder

At this position, an option (number or letter) selected from the specification is displayed instead of the placeholders.

Basic specifications

The features that are absolutely essential for the device (mandatory features) are specified in the basic specifications. The number of positions depends on the number of features available.

The selected option of a feature can consist of several positions.

Optional specifications

The optional specifications describe additional features for the device (optional features). The number of positions depends on the number of features available. The features have a 2-digit structure to aid identification (e.g. JA). The first digit (ID) stands for the feature group and consists of a number or a letter (e.g. J = Test, Certificate). The second digit constitutes the value that stands for the feature within the group (e.g. A = 3.1 material (wetted parts), inspection certificate).

More detailed information about the device is provided in the following tables. These tables describe the individual positions and IDs in the extended order code which are relevant to hazardous locations.

Extended order code: Levelflex



The following specifications reproduce an extract from the product structure and are used to assign:

- This documentation to the device (using the extended order code on the nameplate).
- The device options cited in the document.

Device type

FMP50, FMP51, FMP52, FMP53, FMP54, FMP55, FMP56, FMP57

Basic specifications

Position 1, 2 (Approval)		
Selected option		Description
FMP5x	B2	ATEX II 1/2 G Ex ia IIC T6...T1 Ga/Gb ATEX II 1/2 D Ex ia IIIC T85°C Da/Db
	I2	IECEX Ex ia IIC T6...T1 Ga/Gb IECEX Ex ia IIIC T85°C Da/Db

Position 3 (Power Supply, Output)		
Selected option		Description
FMP5x	E	2-wire, FOUNDATION Fieldbus, switch output (PFS)
	G	2-wire, PROFIBUS PA, switch output (PFS)

Position 4 (Display, Operation)		
Selected option		Description
FMP5x	A	Without, via communication
	C	SD02, 4-line, push buttons + data backup function
	E	SD03, 4-line, illum., touch control + data backup function
	M ¹⁾	Prepared for display FHX50 + custom connection
	N ¹⁾	Prepared for display FHX50 + NPT1/2"

1) FHX50 is approved according to DEK12.0046X or DEKRA 12ATEX0151X.

Position 5 (Housing)		
Selected option		Description
FMP51 FMP52 FMP54-57	B	GT18 dual compartment, 316L
FMP5x	C	GT20 dual compartment, Alu coated

Position 6 (Electrical Connection)		
Selected option		Description
FMR5x	A	Gland M20, IP66/68 NEMA4X/6P
	B	Thread M20, IP66/68 NEMA4X/6P
	C	Thread G1/2, IP66/68 NEMA4X/6P
	D	Thread NPT1/2, IP66/68 NEMA4X/6P

Position 9, 10 (Seal)		
Selected option		Description
FMP50	A1	Viton, -20...80 °C
FMP51	A4	Viton, -30...150 °C
	B3	EPDM, -40...120 °C
	C3	Kalrez, -20...200 °C
	E1	FVMQ, -50...150 °C
FMP53	AD	FKM, FDA, USP Cl. VI, -10...150 °C
	B5	EPDM, FDA, USP Cl. VI, -20...130 °C
	C4	Kalrez, FDA, USP Cl. VI, -20...150 °C
FMP54	D1	Graphite, -196...280 °C (XT)
	D2	Graphite, -196...450 °C (HT)
FMP56	AB	Viton, -30...120 °C
	B3	EPDM, -40...120 °C
FMP57	A4	Viton, -30...150 °C
	B3	EPDM, -40...120 °C
	C5	Kalrez, -5...185 °C



Shown in the temperature tables
exemplary as follows:

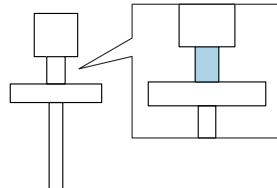

Optional specifications

ID Mx (Probe Design)		
Selected option		Description
FMP5x	MB	Sensor remote, 3 m/9 ft cable, detachable + mounting bracket
FMP53	MA	Sensor compact, detachable
FMP50-54	MC	Sensor remote, 6 m/18 ft cable, detachable + mounting bracket
FMP56 FMP57	MD	Sensor remote, 9 m/27 ft cable, detachable + mounting bracket

ID Nx, Ox (Accessory Mounted)		
Selected option		Description
FMP5x	NA	Overvoltage protection
FMP51 FMP52 FMP55	NC	Gas-tight feed through

Safety instructions:
General

- Staff must meet the following conditions for mounting, electrical installation, commissioning and maintenance of the device:
 - Be suitably qualified for their role and the tasks they perform
 - Be trained in explosion protection
 - Be familiar with national regulations
- Install the device according to the manufacturer's instructions and national regulations.
- Do not operate the device outside the specified electrical, thermal and mechanical parameters.
- Only use the device in media to which the wetted materials have sufficient durability.
- Avoid electrostatic charging:
 - Of plastic surfaces (e.g. housing, sensor element, special varnishing, attached additional plates, ..)
 - Of isolated capacities (e.g. isolated metallic plates)
- Modifications to the device can affect the explosion protection and must be carried out by staff authorized to perform such work by Endress+Hauser.

- Refer to the temperature tables for the relationship between the permitted ambient temperature for the sensor and/or transmitter, depending on the range of application and the temperature class.
- When replacing the probe electronics or opening the connection between the remote cable and the probe, a jumper plug must be used or a short-circuit must be established between the probe contact and the potential equalization conductor to avoid electrostatically charging the probe.
- When using in hybrid mixtures (gas and dust occurring simultaneously), observe additional measures for explosion protection.

**Safety
instructions:**

Special conditions

Permitted ambient temperature range at the electronics housing:
 $-40\text{ °C} \leq T_a \leq +80\text{ °C}$

- Observe the information in the temperature tables.
- In the case of process connections made of polymeric material or with polymeric coatings, avoid electrostatic charging of the plastic surfaces.
- To avoid electrostatic charging: Do not rub surfaces with a dry cloth.
- In the event of additional or alternative special varnishing on the housing or other metal parts or for adhesive plates:
 - Observe the danger of electrostatic charging and discharge.
 - Do not install in the vicinity of processes ($\leq 0.5\text{ m}$) generating strong electrostatic charges.
- Secure probes against swinging: e.g by fixing them to the wall or floor or by installing them in the ground tube.

Device type FMP52, FMP55 and Device type FMP5x with non-conductive plastic coated probes

A probe coated with non-conductive material can be used if avoiding electrostatic charging (e.g. through friction, cleaning, maintenance, strong medium flow).

Safety instructions: Installation

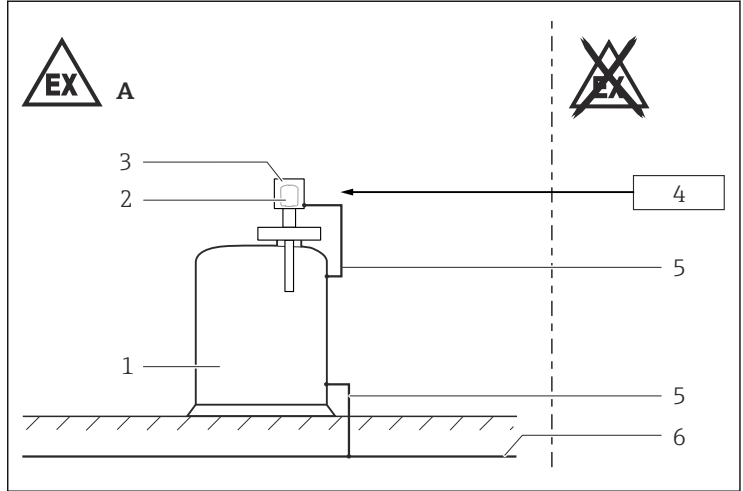

A0025536

- A Zone 1, Zone 21
 1 Tank; Zone 0, Zone 1 or Zone 20, Zone 21
 2 Electronic insert
 3 Housing
 4 Certified associated apparatus
 5 Potential equalization line
 6 Potential equalization

- After aligning (rotating) the housing, retighten the fixing screw (see Operating Instructions).
- Install the device to exclude any mechanical damage or friction during the application. Pay particular attention to flow conditions and tank fittings.
- Only use certified cable entries or sealing plugs. The metal sealing plugs supplied meet this requirement.
- Before operation:
 - Screw in the cover all the way.
 - Tighten the securing clamp on the cover.
- After mounting and connecting the probe, ingress protection of the housing must be at least IP65.
- Perform the following to achieve the degree of protection:
 - Screw the cover tight.
 - Mount the cable entry correctly.
- Continuous service temperature of the connecting cable: -40 °C to $\geq +85\text{ °C}$; in accordance with the range of service temperature taking into account additional influences of the process conditions ($T_{a,\min}$), ($T_{a,\max} + 20\text{ K}$).

Basic specification, Position 4 (Display, Operation) = N

Observe the requirements according to IEC/EN 60079-14 for conduit systems and the wiring- and installation instructions of the suitable Safety Instructions (XA). In addition, observe national regulations and standards for conduit systems.

Intrinsic safety

- The device is only suitable for connection to certified, intrinsically safe equipment with explosion protection Ex ia / Ex ib.
- The intrinsically safe input power circuit of the device is isolated from ground. If the device is only equipped with one input, the dielectric strength of the input is at least $500 V_{\text{rms}}$. If the device is equipped with more than one input, the dielectric strength of each individual input to ground is at least $500 V_{\text{rms}}$, and the dielectric strength of the inputs vis-à-vis one another is also at least $500 V_{\text{rms}}$.
- Observe the pertinent guidelines when interconnecting intrinsically safe circuits.
- The device can be connected to the Endress+Hauser FXA291 service tool: refer to the Operating Instructions and specifications in the "Overvoltage protection" chapter.
- When the intrinsically safe Ex ia circuits of the device are connected to certified intrinsically safe circuits of Category Ex ib for Equipment Groups IIC or IIB, the type of protection changes to Ex ib [ia] IIC or Ex ib [ia] IIB. Regardless of the power supply, all the internal circuits correspond to Ex ia IIC type of protection (e.g. service interface, external display, sensor).

Potential equalization

- Integrate the device into the local potential equalization.
- Grounding the screen, see the following figure.

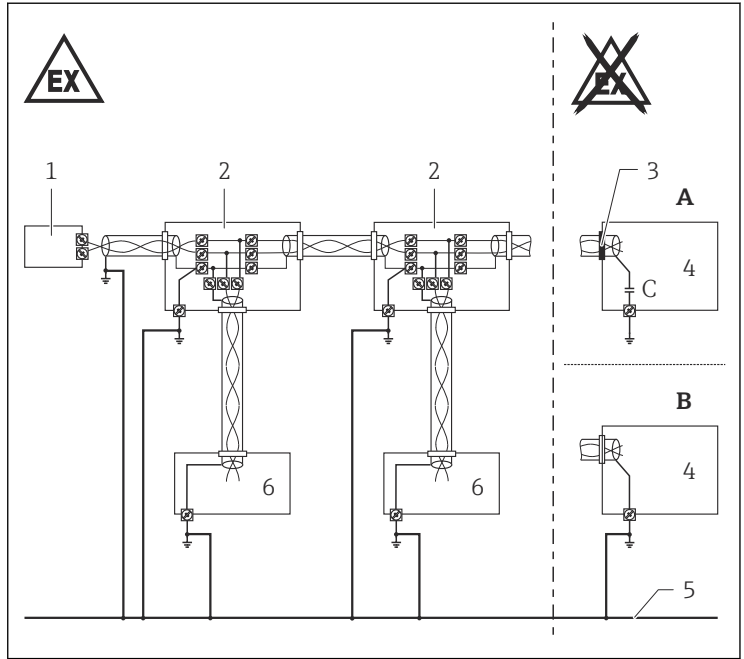

A0022352

- A Version 1: Use small capacitors (e.g. 1 nF, 1500 V dielectric strength, ceramic). Total capacitance connected to the screen may not exceed 10 nF.
- B Version 2
- 1 Terminating resistor
- 2 Distributor/T box
- 3 Screen insulated
- 4 Supply unit/Segment coupler
- 5 Potential equalization (secured in high degree)
- 6 Field device

Overvoltage protection

- If an overvoltage protection against atmospheric over voltages is required: no other circuits may leave the housing during normal operation without additional measures.
- For installations which require overvoltage protection to comply with national regulations or standards, install the device using overvoltage protection (e.g. HAW56x from Endress+Hauser).
- Observe the safety instructions of the overvoltage protection.

Optional specification, ID Nx, Ox (Accessory Mounted) = NA
(Overvoltage protection Type OVP20)

The intrinsically safe input power circuit of the device is isolated from ground. If the device is only equipped with one input, the dielectric strength of the input is at least 290 V_{rms}. If the device is equipped with

more than one input, the dielectric strength of each individual input to ground is at least $290 V_{\text{rms}}$, and the dielectric strength of the inputs vis-à-vis one another is also at least $290 V_{\text{rms}}$.

Safety instructions: Zone 0

- In the event of potentially explosive vapor/air mixtures, only operate the device under atmospheric conditions.
 - Temperature: -20 to $+60$ °C
 - Pressure: 80 to 110 kPa (0.8 to 1.1 bar)
 - Air with normal oxygen content, usually 21 % (V/V)
- If no potentially explosive mixtures are present, or if additional protective measures have been taken, the device may also be operated under non-atmospheric conditions in accordance with the manufacturer's specifications.
- Associated devices with galvanic isolation between the intrinsically safe and non-intrinsically safe circuits are preferred.
- If there is a risk of dangerous potential differences within Zone 0 (e.g. through the occurrence of atmospheric electricity), implement suitable measures for intrinsically safe circuits in Zone 0.

Temperature tables

→ Safety Instructions: XA02259F/00



The Safety Instructions for temperature tables are available:
In the download area of the Endress+Hauser website:
www.endress.com -> Downloads ->
Manuals and Datasheets ->
Type: Ex Safety Instructions (XA) -> Text Search: ...



Optional specification, ID Nx, Ox (Accessory Mounted) = NA (Overvoltage protection type OVP20)

When using the internal overvoltage protection: Reduce the admissible ambient temperature at the housing by 5 K.



Observe the permitted temperature range at the probe.

Explanation of how to use the temperature tables



Unless otherwise indicated, the positions always refer to the basic specification.

Zone 0, Zone 1 or Zone 1

1st column: Position 5 (Housing) = A, B, ...

2nd column: Position 3 (Power Supply, Output) = A, B, ..

- (1): 1 channel used
- (2): 2 channels used

3rd column: Temperature classes T6 (85 °C) to T1 (450 °C)

Column P1 to P6: Position (temperature value) on the axes of the derating

- T_a : Ambient temperature in °C
- T_p : Process temperature in °C

 Column P6 is only relevant for version B of the derating.

Example table

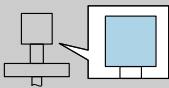
 = C	(1)	P1		P2		P3		P4		P5		P6		
		T_p	T_a	T_p	T_a	T_p	T_a	T_p	T_a	T_p	T_a	T_p	T_a	
	E, G	T6	-40	60	60	60	85	54	85	-40	-40	-40	-	-
		T5	-40	75	75	75	100	69	100	-40	-40	-40	-	-
		T4	-40	80	80	80	135	72	135	-40	-40	-40	-	-

Zone 20, Zone 21

1st column: Position 5 (Housing) = A, B, ...

2nd column: Position 3 (Power Supply, Output) = A, B, ..

- (1): 1 channel used
- (2): 2 channels used

3rd column: Process temperature

Column P1 to P6: Position (temperature value) on the axes of the derating

- T_a : Ambient temperature in °C
- T_p : Process temperature in °C

 Column P6 is only relevant for version B of the derating.

Example table

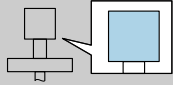
 = C	(1)	P1		P2		P3		P4		P5		P6	
		T_p	T_a	T_p	T_a	T_p	T_a	T_p	T_a	T_p	T_a	T_p	T_a
	E, G	135	-40	79	79	79	67	135	-40	-40	-40	-	-
		200	-40	79	79	79	48	200	-40	-40	-40	-	-

Example diagrams of possible deratings

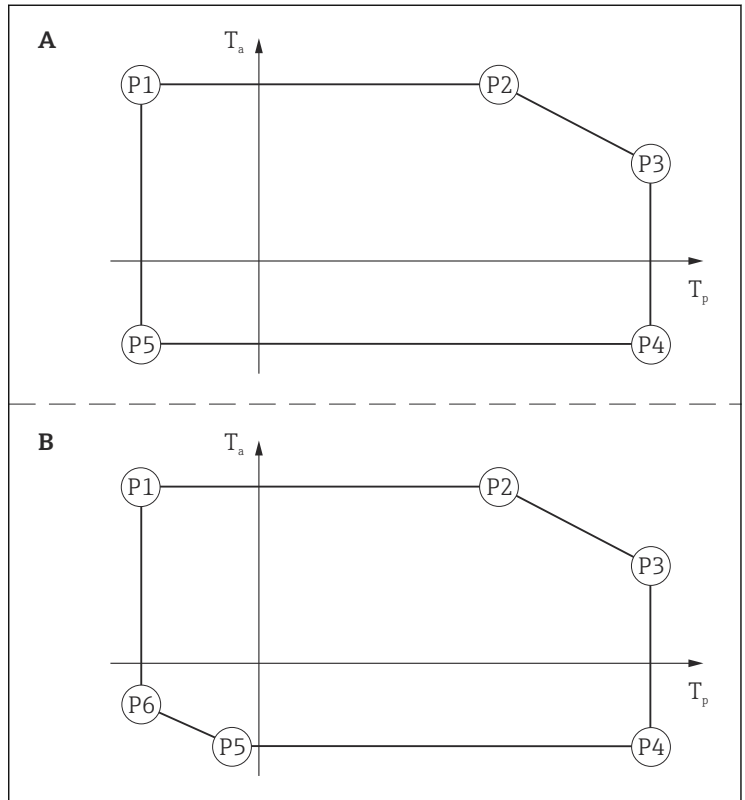

A0022717

Connection data

Cable entry: Connection compartment

Ex ia IIC

Not relevant.

Ex ia IIIC

Cable gland: Basic specification, Position 6 (Electrical Connection) = A

Basic specification, Position 5 (Housing) = B, C

preferably for Position 5 (Housing) = B

Thread	Clamping range	Material	Sealing insert	O-ring
M20x1,5	ø 7 to 12 mm	1.4404	NBR	EPDM (ø 17x2)

preferably for Position 5 (Housing) = C

Thread	Clamping range	Material	Sealing insert	O-ring
M20x1,5	ø 8 to 10.5 mm ¹⁾ (ø 6.5 to 13 mm) ²⁾	Ms, nickel-plated	Silicone	EPDM (ø 17x2)

- 1) Standard
2) Separate clamping inserts available

-  The tightening torque refers to cable glands installed by the manufacturer:
 - Recommended: 3.5 Nm
 - Maximum: 10 Nm
 - This value may be different depending on the type of cable. However, the maximum value must not be exceeded.
- Only suitable for fixed installation. The operator must pay attention to a suitable strain relief of the cable.
- The cable glands are suitable for a low risk of mechanical danger (4 Joule) and must be mounted in a protected position if larger impact energy levels are expected.
- To maintain the ingress protection of the housing: Install the housing cover, cable glands and blind plugs correctly.

Cable entry: Electronics compartment

Cable gland: *Basic specification, Position 4 (Display, Operation) = M*

Basic specification, Position 5 (Housing) = B, C

preferably for Position 5 (Housing) = B

Thread	Clamping range	Material	Sealing insert	O-ring
M16x1,5	ø 5 to 10 mm	1.4404	PA/NBR	NBR (ø 13x2)

preferably for Position 5 (Housing) = C

Thread	Clamping range	Material	Sealing insert	O-ring
M16x1,5	ø 5 to 10 mm	Ms, nickel-plated	PA/NBR	NBR (ø 13x2)

-  The tightening torque refers to cable glands installed by the manufacturer:
 - Recommended: 3.5 Nm
 - Maximum: 5 Nm
 - This value may be different depending on the type of cable. However, the maximum value must not be exceeded.

- Only suitable for fixed installation. The operator must pay attention to a suitable strain relief of the cable.
- The cable glands are suitable for a low risk of mechanical danger (4 Joule) and must be mounted in a protected position if larger impact energy levels are expected.
- To maintain the ingress protection of the housing: Install the housing cover, cable glands and blind plugs correctly.

Terminals

Optional specification, ID Nx, Ox (Accessory Mounted) = NA (Overvoltage protection Type OVP20)

When using the internal overvoltage protection: No changes to the connection values.

Ex ia

Power supply and signal circuit with protection type: intrinsic safety
Ex ia IIC, Ex ia IIB, Ex ia IIIC.

Basic specification, Position 3 (Power Supply, Output) = E, G

Terminal 1 (+), 2 (-)		Terminal 3 (+), 4 (-)
FISCO	Entity	Switch output (PFS)
$U_i = 17.5 \text{ V}$	$U_i = 30 \text{ V}$	$U_i = 30 \text{ V}$
$I_i = 550 \text{ mA}$	$I_i = 300 \text{ mA}$	$I_i = 300 \text{ mA}$
$P_i = 5.5 \text{ W}$	$P_i = 1.2 \text{ W}$	$P_i = 1 \text{ W}$
effective inner inductance $L_i = 10 \text{ }\mu\text{H}$		effective inner inductance $L_i = 0$
effective inner capacitance $C_i = 5 \text{ nF}$		effective inner capacitance $C_i = 6 \text{ nF}$

Service interface (CDI)

Taking the following values into consideration, the device can be connected to the certified Endress+Hauser FXA291 service tool or a similar interface:

Service interface													
$U_i = 7.3 \text{ V}$ effective inner inductance $L_i = \text{negligible}$ effective inner capacitance $C_i = \text{negligible}$													
$U_o = 7.3 \text{ V}$ $I_o = 100 \text{ mA}$ $P_o = 160 \text{ mW}$													
$L_o \text{ (mH)} =$	5.00	2.00	1.00	0.50	0.20	0.15	0.10	0.05	0.02	0.01	0.005	0.002	0.001
$C_o \text{ (}\mu\text{F)}^{1) =}$	0.73	1.20	1.60	2.00	2.60	-	3.20	4.00	5.50	7.30	10.00	12.70	12.70
$C_o \text{ (}\mu\text{F)}^{2) =}$	-	0.49	0.90	1.40	-	2.00	-	-	-	-	-	-	-

- 1) Values according to PTB "ispark" program
- 2) Values according to IEC/EN 60079-25, Annex C



71497709

www.addresses.endress.com
