

# Technical Information

## Proline Promass E 300

Coriolis flowmeter



Mid-range Coriolis flowmeter with a compact, easily accessible transmitter

### Application

- Measuring principle operates independently of physical fluid properties such as viscosity or density
- Accurate measurement of liquids and gases for a wide range of standard applications

### Device properties

- Compact dual-tube sensor
- Medium temperature up to +150 °C (+302 °F)
- Process pressure up to 100 bar (1450 psi)
- Compact dual-compartment housing with up to 3 I/Os
- Backlit display with touch control and WLAN access
- Remote display available

### Your benefits

- Cost-effective – multipurpose device; an alternative to conventional volumetric flowmeters
- Fewer process measuring points – multivariable measurement (flow, density, temperature)
- Space-saving installation – no in-/outlet run needs
- Full access to process and diagnostic information – numerous, freely combinable I/Os and Ethernet
- Reduced complexity and variety – freely configurable I/O functionality
- Integrated verification – Heartbeat Technology

## Table of contents





|  |           |   |            |
|--|-----------|---|------------|
| <b>About this document</b> . . . . .         | <b>4</b>  | <b>Environment</b> . . . . .                        | <b>58</b>  |
| Symbols . . . . .                            | 4         | Ambient temperature range . . . . .                 | 58         |
| <b>Function and system design</b> . . . . .  | <b>5</b>  | Storage temperature . . . . .                       | 58         |
| Measuring principle . . . . .                | 5         | Climate class . . . . .                             | 58         |
| Measuring system . . . . .                   | 6         | Relative humidity . . . . .                         | 58         |
| Equipment architecture . . . . .             | 7         | Operating height . . . . .                          | 59         |
| Reliability . . . . .                        | 7         | Degree of protection . . . . .                      | 59         |
| <b>Input</b> . . . . .                       | <b>10</b> | Vibration resistance and shock resistance . . . . . | 59         |
| Measured variable . . . . .                  | 10        | Mechanical load . . . . .                           | 59         |
| Measuring range . . . . .                    | 10        | Electromagnetic compatibility (EMC) . . . . .       | 59         |
| Operable flow range . . . . .                | 11        | <b>Process</b> . . . . .                            | <b>59</b>  |
| Input signal . . . . .                       | 11        | Medium temperature range . . . . .                  | 59         |
| <b>Output</b> . . . . .                      | <b>13</b> | Medium density . . . . .                            | 60         |
| Output and input variants . . . . .          | 13        | Pressure/temperature ratings . . . . .              | 60         |
| Output signal . . . . .                      | 15        | Sensor housing . . . . .                            | 64         |
| Signal on alarm . . . . .                    | 22        | Rupture disk . . . . .                              | 65         |
| Load . . . . .                               | 24        | Internal cleaning . . . . .                         | 65         |
| Ex connection data . . . . .                 | 25        | Flow limit . . . . .                                | 65         |
| Low flow cut off . . . . .                   | 28        | Pressure loss . . . . .                             | 65         |
| Galvanic isolation . . . . .                 | 28        | Static pressure . . . . .                           | 65         |
| Protocol-specific data . . . . .             | 29        | Thermal insulation . . . . .                        | 65         |
| <b>Power supply</b> . . . . .                | <b>37</b> | Heating . . . . .                                   | 66         |
| Terminal assignment . . . . .                | 37        | Vibrations . . . . .                                | 66         |
| Available device plugs . . . . .             | 38        | <b>Mechanical construction</b> . . . . .            | <b>67</b>  |
| Supply voltage . . . . .                     | 40        | Dimensions in SI units . . . . .                    | 67         |
| Power consumption . . . . .                  | 40        | Dimensions in US units . . . . .                    | 81         |
| Current consumption . . . . .                | 40        | Weight . . . . .                                    | 89         |
| Power supply failure . . . . .               | 40        | Materials . . . . .                                 | 89         |
| Overcurrent protection element . . . . .     | 40        | Process connections . . . . .                       | 91         |
| Electrical connection . . . . .              | 40        | Surface roughness . . . . .                         | 91         |
| Potential equalization . . . . .             | 46        | <b>Operability</b> . . . . .                        | <b>93</b>  |
| Terminals . . . . .                          | 46        | Operation concept . . . . .                         | 93         |
| Cable entries . . . . .                      | 47        | Languages . . . . .                                 | 93         |
| Pin assignment, device plug . . . . .        | 47        | Local operation . . . . .                           | 93         |
| Cable specification . . . . .                | 49        | Remote operation . . . . .                          | 94         |
| Overvoltage protection . . . . .             | 51        | Service interface . . . . .                         | 101        |
| <b>Performance characteristics</b> . . . . . | <b>51</b> | Network integration . . . . .                       | 102        |
| Reference operating conditions . . . . .     | 51        | Supported operating tools . . . . .                 | 103        |
| Maximum measurement error . . . . .          | 51        | HistoROM data management . . . . .                  | 104        |
| Repeatability . . . . .                      | 53        | <b>Certificates and approvals</b> . . . . .         | <b>106</b> |
| Response time . . . . .                      | 53        | CE mark . . . . .                                   | 106        |
| Influence of ambient temperature . . . . .   | 53        | UKCA marking . . . . .                              | 106        |
| Influence of medium temperature . . . . .    | 53        | RCM marking . . . . .                               | 106        |
| Influence of medium pressure . . . . .       | 54        | Ex approval . . . . .                               | 106        |
| Design fundamentals . . . . .                | 54        | Hygienic compatibility . . . . .                    | 107        |
| <b>Installation</b> . . . . .                | <b>55</b> | Pharmaceutical compatibility . . . . .              | 107        |
| Mounting location . . . . .                  | 55        | Functional safety . . . . .                         | 107        |
| Orientation . . . . .                        | 56        | HART certification . . . . .                        | 107        |
| Inlet and outlet runs . . . . .              | 57        | FOUNDATION Fieldbus certification . . . . .         | 108        |
| Special installation instructions . . . . .  | 57        | Certification PROFIBUS . . . . .                    | 108        |
|  |           | EtherNet/IP certification . . . . .                 | 108        |
|  |           | Certification PROFINET . . . . .                    | 108        |
|  |           | PROFINET over Ethernet-APL certification . . . . .  | 108        |
|  |           | Pressure Equipment Directive . . . . .              | 108        |

|   |            |
|---|------------|
| Radio approval . . . . .                            | 109        |
| Additional certification . . . . .                  | 109        |
| External standards and guidelines . . . . .         | 109        |
| <b>Ordering information . . . . .</b>               | <b>110</b> |
| <b>Application packages . . . . .</b>               | <b>110</b> |
| Diagnostic functionality . . . . .                  | 110        |
| Heartbeat Technology . . . . .                      | 111        |
| Concentration measurement . . . . .                 | 111        |
| Petroleum . . . . .                                 | 111        |
| Petroleum & locking function . . . . .              | 111        |
| OPC-UA Server . . . . .                             | 112        |
| <b>Accessories . . . . .</b>                        | <b>112</b> |
| Device-specific accessories . . . . .               | 112        |
| Communication-specific accessories . . . . .        | 113        |
| Service-specific accessories . . . . .              | 114        |
| System components . . . . .                         | 114        |
| <b>Documentation . . . . .</b>                      | <b>115</b> |
| Standard documentation . . . . .                    | 115        |
| Device-dependent additional documentation . . . . . | 116        |
| <b>Registered trademarks . . . . .</b>              | <b>118</b> |





## About this document

### Symbols









#### Electrical symbols

| Symbol  | Meaning   |
|---|---|
|  | Direct current  |
|  | Alternating current   |
|  | Direct current and alternating current  |
|  | <b>Ground connection</b><br>A grounded terminal which, as far as the operator is concerned, is grounded via a grounding system.   |
|  | <b>Protective earth (PE)</b><br>Ground terminals that must be connected to ground prior to establishing any other connections.<br><br>The ground terminals are located on the interior and exterior of the device: <ul style="list-style-type: none"> <li>▪ Interior ground terminal: protective earth is connected to the mains supply.</li> <li>▪ Exterior ground terminal: device is connected to the plant grounding system.</li> </ul> |



#### Communication-specific symbols

| Symbol  | Meaning   |
|---|---|
|   | <b>Wireless Local Area Network (WLAN)</b><br>Communication via a wireless, local area network |
|  | <b>LED</b><br>LED is off.   |
|  | <b>LED</b><br>LED is on.  |
|  | <b>LED</b><br>LED flashing.   |

#### Symbols for certain types of information

| Symbol  | Meaning  |
|---|--|
|  | <b>Permitted</b><br>Procedures, processes or actions that are permitted. |
|  | <b>Preferred</b><br>Procedures, processes or actions that are preferred. |
|  | <b>Forbidden</b><br>Procedures, processes or actions that are forbidden. |
|  | <b>Tip</b><br>Indicates additional information.                          |
|  | Reference to documentation   |
|  | Reference to page  |
|  | Reference to graphic   |
|  | Visual inspection  |

Symbols in graphics

| Symbol  | Meaning                        |
|---|--------------------------------|
| 1, 2, 3, ...  | Item numbers                   |
| 1, 2, 3, ...  | Series of steps                |
| A, B, C, ...  | Views                          |
| A-A, B-B, C-C, ...  | Sections                       |
|  | Hazardous area                 |
|  | Safe area (non-hazardous area) |
|  | Flow direction                 |

Function and system design

Measuring principle

The measuring principle is based on the controlled generation of Coriolis forces. These forces are always present in a system when both translational and rotational movements are superimposed.

$$F_c = 2 \cdot \Delta m (v \cdot \omega)$$

$F_c$  = Coriolis force

$\Delta m$  = moving mass

$\omega$  = rotational velocity

$v$  = radial velocity in rotating or oscillating system

The amplitude of the Coriolis force depends on the moving mass  $\Delta m$ , its velocity  $v$  in the system and thus on the mass flow. Instead of a constant rotational velocity  $\omega$ , the sensor uses oscillation.

In the sensor, two parallel measuring tubes containing flowing medium oscillate in antiphase, acting like a vibrating fork. The Coriolis forces produced at the measuring tubes cause a phase shift in the tube oscillations (see illustration):

- At zero flow (when the medium is at a standstill) the two tubes oscillate in phase (1).
- Mass flow causes deceleration of the oscillation at the inlet of the tubes (2) and acceleration at the outlet (3).

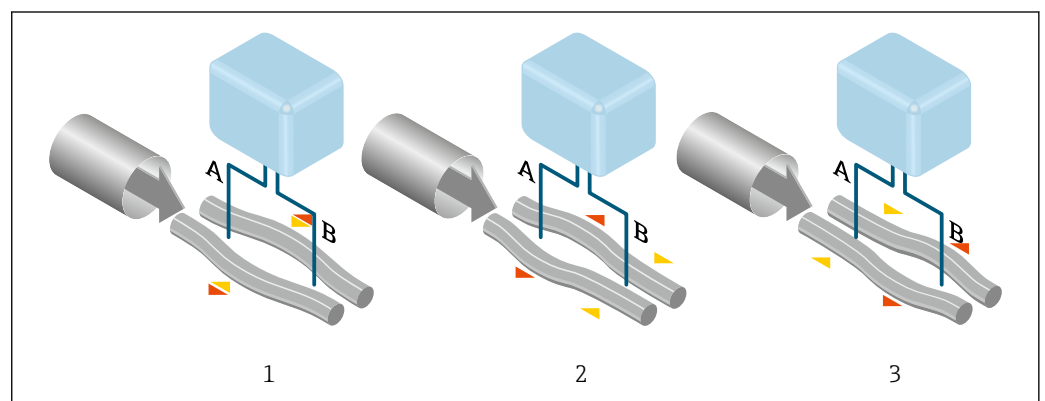

A0028850

The phase shift (A-B) increases with increasing mass flow. Electrodynamic sensors register the tube oscillations at the inlet and outlet. System balance is ensured by the antiphase oscillation of the two measuring tubes. The measuring principle operates independently of temperature, pressure, viscosity, conductivity and flow profile.

**Density measurement**

The measuring tube is continuously excited at its resonance frequency. A change in the mass and thus the density of the oscillating system (comprising measuring tube and medium) results in a corresponding, automatic adjustment in the oscillation frequency. The resonance frequency is thus a function of the medium density. The microprocessor utilizes this relationship to obtain a density signal.

**Volume measurement**

Together with the measured mass flow, this is used to calculate the volume flow.

**Temperature measurement**

The temperature of the measuring tube is determined in order to calculate the compensation factor due to temperature effects. This signal corresponds to the process temperature and is also available as an output signal.

**Gas Fraction Handler (GFH)**

The Gas Fraction Handler is a Promass software function that improves measurement stability and repeatability. The function continuously checks for the presence of disturbances in single-phase flow, i.e. gas bubbles in liquids. In the presence of the second phase, flow and density become increasingly unstable. The Gas Fraction Handler function improves measurement stability with respect to the severity of the disturbances, without any effect under single-phase flow conditions.

 The Gas Fraction Handler is only available for device versions with HART, Modbus RS485, PROFINET, PROFINET over Ethernet-APL and Modbus TCP over Ethernet-APL.

 For more detailed information on the Gas Fraction Handler, see the "Gas Fraction Handler" Special Documentation →  117

**Measuring system**

The device consists of a transmitter and a sensor.

The device is available as a compact version:

The transmitter and sensor form a mechanical unit.

**Transmitter**

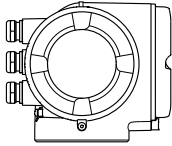
|   |  |
|---|--|
| <p><b>Proline 300</b></p>  <p>A0026708</p> | <p>Device versions and materials:</p> <ul style="list-style-type: none"> <li>■ Transmitter housing <ul style="list-style-type: none"> <li>■ Aluminum, coated: aluminum, AlSi10Mg, coated</li> <li>■ Stainless, hygienic: stainless steel, 1.4404</li> </ul> </li> <li>■ Material of window in transmitter housing: <ul style="list-style-type: none"> <li>■ Aluminum, coated: glass</li> <li>■ Stainless, hygienic: polycarbonate</li> </ul> </li> </ul> <p>Configuration:</p> <ul style="list-style-type: none"> <li>■ External operation via 4-line, illuminated graphic local display (LCD) with touch control and guided menus ("Make-it-run" wizards) for application-specific commissioning.</li> <li>■ Via service interface or WLAN interface: <ul style="list-style-type: none"> <li>■ Operating tools (e.g. FieldCare, DeviceCare)</li> <li>■ Web server (access via web browser)</li> </ul> </li> </ul> |
|---|--|

**Sensor**

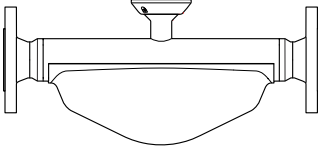
|   |   |
|---|---|
| <p><b>Promass E</b></p>  <p>A0026712</p> | <ul style="list-style-type: none"> <li>■ Bent dual-tube system</li> <li>■ For standard applications where stable and reliable measurements are required</li> <li>■ Simultaneous measurement of flow, volume flow, density and temperature (multivariable)</li> <li>■ Immune to process influences</li> <li>■ Nominal diameter range: DN 8 to 80 (3/8 to 3")</li> <li>■ Materials: <ul style="list-style-type: none"> <li>■ Sensor: stainless steel, 1.4301 (304)</li> <li>■ Measuring tubes: stainless steel, 1.4539 (904L)</li> <li>■ Process connections: stainless steel, 1.4404 (316/316L)</li> </ul> </li> </ul> |
|---|---|

Equipment architecture

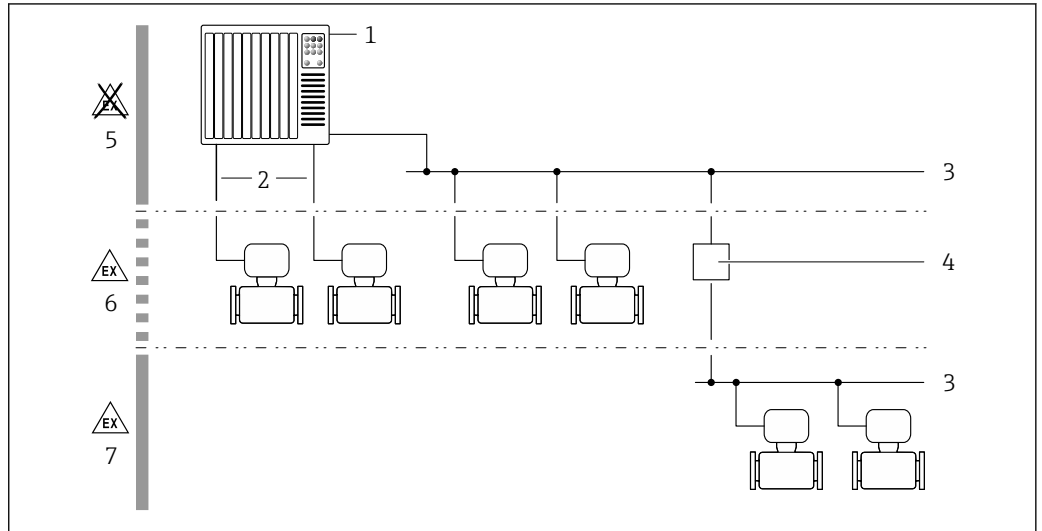

A0027512

1 Possibilities for integrating measuring instruments into a system

- 1 Automation system (e.g. PLC)
- 2 Connection cable (0/4 to 20 mA HART etc.)
- 3 Fieldbus
- 4 Coupler
- 5 Non-hazardous area
- 6 Hazardous area: Zone 2; Class I, Division 2
- 7 Hazardous area: Zone 1; Class I, Division 1

Reliability

IT security

The manufacturer warranty is valid only if the product is installed and used as described in the Operating Instructions. The product is equipped with security mechanisms to protect it against any inadvertent changes to the settings.

IT security measures, which provide additional protection for the product and associated data transfer, must be implemented by the operators themselves in line with their security standards.

Device-specific IT security

The device offers a range of specific functions to support protective measures on the operator's side. These functions can be configured by the user and guarantee greater in-operation safety if used correctly. The following list provides an overview of the most important functions:

| Function/interface   | Factory setting    | Recommendation  |
|--|--------------------|---|
| Write protection via hardware write protection switch → 8                  | Not enabled        | On an individual basis following risk assessment          |
| Access code (also applies to web server login or FieldCare connection) → 8 | Not enabled (0000) | Assign a customized access code during commissioning      |
| WLAN (order option in display module)                                      | Enabled            | On an individual basis following risk assessment          |
| WLAN security mode   | Enabled (WPA2-PSK) | Do not change   |
| WLAN passphrase (Password) → 8   | Serial number      | Assign an individual WLAN passphrase during commissioning |
| WLAN mode  | Access point       | On an individual basis following risk assessment          |
| Web server → 8   | Enabled            | On an individual basis following risk assessment          |
| Service interface CDI-RJ45 → 9   | Enabled            | -   |

*Protecting access via hardware write protection*

Write access to the parameters of the device via the local display, web browser or operating tool (e.g. FieldCare, DeviceCare) can be disabled via a write protection switch (DIP switch on the main electronics module). When hardware write protection is enabled, only read access to the parameters is possible.

Hardware write protection is disabled when the device is delivered.

*Protecting access via a password*

Different passwords are available to protect write access to the device parameters or access to the device via the WLAN interface.

- **User-specific access code**  
Protect write access to the device parameters via the local display, web browser or operating tool (e.g. FieldCare, DeviceCare). Access authorization is clearly regulated through the use of a user-specific access code.
- **WLAN passphrase**  
The network key protects a connection between an operating unit (e.g. notebook or tablet) and the device via the WLAN interface which can be ordered as an option.
- **Infrastructure mode**  
When the device is operated in infrastructure mode, the WLAN passphrase corresponds to the WLAN passphrase configured on the operator side.

*User-specific access code*

Local display, web browser and operating tool (e.g. FieldCare, DeviceCare)

- Write access to the device parameters via the local display, web browser or operating tool (e.g. FieldCare, DeviceCare) can be protected by the modifiable, user-specific access code.
- When delivered, the device does not have an access code; the default value is 0000 (open).

*WLAN passphrase: Operation as WLAN access point*

A connection between an operating unit (e.g. notebook or tablet) and the device via the WLAN interface, which can be ordered as an optional extra, is protected by the network key. The WLAN authentication of the network key complies with the IEEE 802.11 standard.

When the device is delivered, the network key is pre-defined depending on the device. It can be changed via the **WLAN settings** submenu in the **WLAN passphrase** parameter.

*Infrastructure mode*

A connection between the device and WLAN access point is protected by means of an SSID and passphrase on the system side. Please contact the relevant system administrator for access.

*General notes on the use of passwords*

- The access code and network key supplied with the device should be changed during commissioning for security reasons.
- Follow the general rules for generating a secure password when defining and managing the access code or network key.
- The user is responsible for the management and careful handling of the access code and network key.

*Access via web server*

The integrated web server can be used to operate and configure the device via a web browser. The connection is established via the service interface (CDI-RJ45) or WLAN interface. For device versions with the Ethernet/IP and PROFINET communication protocols, the connection can also be established via the terminal connection for signal transmission with Ethernet/IP, PROFINET (RJ45 plug), PROFINET over Ethernet-APL (two-wire) or Modbus TCP over Ethernet-APL.

The web server is enabled when the device is delivered. The web server can be disabled if necessary via the **Web server functionality** parameter (e.g., after commissioning).

The device and status information can be hidden on the login page. This prevents unauthorized access to the information.



For detailed information on device parameters, see: Description of Device Parameters.

#### Access via OPC UA



The "OPC UA Server" application package is available in the device version with the HART communication protocol → 112.

The device can communicate with OPC UA clients using the "OPC UA Server" application package.

The OPC UA server integrated in the device can be accessed via the WLAN access point using the WLAN interface - which can be ordered as an optional extra - or the service interface (CDI-RJ45) via Ethernet network. Access rights and authorization as per separate configuration.

The following Security Modes are supported as per the OPC UA Specification (IEC 62541):

- Without
- Basic128Rsa15 – signed
- Basic128Rsa15 – signed and encrypted

#### Access via service interface (port 2): CDI-RJ45

The device can be connected to a network via the service interface. Device-specific functions guarantee the secure operation of the device in a network.

The use of relevant industrial standards and guidelines that have been defined by national and international safety committees, such as IEC/ISA62443 or the IEEE, is recommended. This includes organizational security measures such as the assignment of access authorization as well as technical measures such as network segmentation.



PROFINET, Ethernet/IP:

The device can be integrated into a ring topology. The device is integrated via the terminal connection for signal transmission, output 1 (port 1) and the terminal connection to the service interface (port 2) → 101.



For detailed information on connecting transmitters with an Ex de approval, see separate document "Safety instructions" (XA) for the device.

#### Advanced safety requirements

If the specified requirements for measures cannot be met, alternative measures may need to be put in place. This may involve, for example, mechanical protection of the product against tampering, the cabling, or organizational measures. The Proline measuring instruments can be used in the open field for example. Measures to combat physical tampering of the Proline measuring instruments must be arranged by the customer.

Additional analysis is required if Proline measuring instruments are integrated into a different system. Please note the following:

- The fieldbus network (OT) and company network (IT) must be strictly separated.
- Endress+Hauser recommends the segmentation of the fieldbus networks according to DIN IEC 62443-3-3.

#### Network

Pay particular attention to the network components used, the router and switches for example. The operator must guarantee the integrity of the components. Access to the network must be restricted by the operator, if necessary.

#### FDI Packages

Signed FDI Packages can be obtained via [www.endress.com](http://www.endress.com) for the configuration of the field device.

#### User training

Depending on the application scenario, users who are not specialized in this area may come in contact with the instrument. We recommend that these users be trained in the safe use of the relevant terminals, components and/or interfaces and be made aware of security issues.

## Input

### Measured variable

#### Direct measured variables

- Mass flow
- Density
- Temperature

#### Calculated measured variables

- Volume flow
- Corrected volume flow
- Reference density

### Measuring range

#### Measuring range for liquids

| DN   |                | Measuring range full scale values $\dot{m}_{\min(F)}$ to $\dot{m}_{\max(F)}$ |            |
|------|----------------|--|------------|
| [mm] | [in]           | [kg/h]   | [lb/min]   |
| 8    | $\frac{3}{8}$  | 0 to 2 000   | 0 to 73.50 |
| 15   | $\frac{1}{2}$  | 0 to 6 500   | 0 to 238.9 |
| 25   | 1              | 0 to 18 000  | 0 to 661.5 |
| 40   | $1\frac{1}{2}$ | 0 to 45 000  | 0 to 1 654 |
| 50   | 2              | 0 to 70 000  | 0 to 2 573 |
| 80   | 3              | 0 to 180 000   | 0 to 6 615 |

#### Measuring range for gases



The full scale value depends on the density and the speed of sound of the gas used. The full scale value can be calculated with the following formulas:

$$\dot{m}_{\max(G)} = \text{minimum of } (\dot{m}_{\max(F)} \cdot \rho_G \cdot x) \text{ and } (\rho_G \cdot (c_G/2) \cdot d_i^2 \cdot (\pi/4) \cdot 3600 \cdot n)$$

|   |   |
|---|---|
| $\dot{m}_{\max(G)}$                     | Maximum full scale value for gas [kg/h]                           |
| $\dot{m}_{\max(F)}$                     | Maximum full scale value for liquid [kg/h]                        |
| $\dot{m}_{\max(G)} < \dot{m}_{\max(F)}$ | $\dot{m}_{\max(G)}$ can never be greater than $\dot{m}_{\max(F)}$ |
| $\rho_G$                                | Gas density in [kg/m <sup>3</sup> ] at operating conditions       |
| $x$                                     | Limitation constant for max. gas flow [kg/m <sup>3</sup> ]        |
| $c_G$                                   | Speed of sound (gas) [m/s]  |
| $d_i$                                   | Measuring tube internal diameter [m]                              |
| $\pi$                                   | Pi  |
| $n = 2$                                 | Number of measuring tubes   |

| DN   |                | $x$<br>[kg/m <sup>3</sup> ] |
|------|----------------|-----------------------------|
| [mm] | [in]           |                             |
| 8    | $\frac{3}{8}$  | 85                          |
| 15   | $\frac{1}{2}$  | 110                         |
| 25   | 1              | 125                         |
| 40   | $1\frac{1}{2}$ | 125                         |



| DN   |      | x                    |
|------|------|----------------------|
| [mm] | [in] | [kg/m <sup>3</sup> ] |
| 50   | 2    | 125                  |
| 80   | 3    | 155                  |

 To calculate the measuring range, use the *Applicator* sizing tool →  114

If calculating the full scale value using the two formulas:

1. Calculate the full scale value with both formulas.
2. The smaller value is the value that must be used.

#### Recommended measuring range

 Flow limit →  65

#### Operable flow range

Over 1000 : 1.

Flow rates above the preset full scale value do not override the electronics unit, with the result that the totalizer values are registered correctly.

#### Input signal

#### Output and input variants

→  13

#### External measured values

To increase the measurement accuracy of certain measured variables or to calculate the corrected volume flow for gases, the automation system can continuously write different measured values to the measuring instrument:

- Operating pressure to increase measurement accuracy (Endress+Hauser recommends the use of a pressure measuring instrument for absolute pressure, e.g. Cerabar M or Cerabar S)
- Medium temperature to increase measurement accuracy (e.g. iTEMP)
- Reference density for calculating the corrected volume flow for gases

 Various pressure and temperature measuring devices can be ordered from Endress+Hauser: see "Accessories" section →  114

It is recommended to read in external measured values to calculate the corrected volume flow.

#### HART protocol

The measured values are written from the automation system to the measuring device via the HART protocol. The pressure transmitter must support the following protocol-specific functions:

- HART protocol
- Burst mode

#### Current input

The measured values are written from the automation system to the measuring device via the current input →  12.

#### Digital communication

The measured values can be written by the automation system via:

- FOUNDATION Fieldbus
- PROFIBUS DP
- PROFIBUS PA
- Modbus RS485
- Modbus TCP over Ethernet-APL
- EtherNet/IP
- PROFINET
- PROFINET over Ethernet-APL

**Current input 0/4 to 20 mA**

|                                 |   |
|---------------------------------|---|
| <b>Current input</b>            | 0/4 to 20 mA (active/passive)   |
| <b>Current span</b>             | <ul style="list-style-type: none"> <li>▪ 4 to 20 mA (active)</li> <li>▪ 0/4 to 20 mA (passive)</li> </ul> |
| <b>Resolution</b>               | 1 $\mu$ A   |
| <b>Voltage drop</b>             | Typically: 0.6 to 2 V for 3.6 to 22 mA (passive)  |
| <b>Maximum input voltage</b>    | $\leq 30$ V (passive)   |
| <b>Open-circuit voltage</b>     | $\leq 28.8$ V (active)  |
| <b>Possible input variables</b> | <ul style="list-style-type: none"> <li>▪ Pressure</li> <li>▪ Temperature</li> <li>▪ Density</li> </ul>    |

**Status input**

|                             |  |
|-----------------------------|--|
| <b>Maximum input values</b> | <ul style="list-style-type: none"> <li>▪ DC -3 to 30 V</li> <li>▪ If status input is active (ON): <math>R_i &gt; 3</math> k<math>\Omega</math></li> </ul>              |
| <b>Response time</b>        | Configurable: 5 to 200 ms  |
| <b>Input signal level</b>   | <ul style="list-style-type: none"> <li>▪ Low signal: DC -3 to +5 V</li> <li>▪ High signal: DC 12 to 30 V</li> </ul>  |
| <b>Assignable functions</b> | <ul style="list-style-type: none"> <li>▪ Off</li> <li>▪ Reset the individual totalizers separately</li> <li>▪ Reset all totalizers</li> <li>▪ Flow override</li> </ul> |



# Output

## Output and input variants

Depending on the option selected for output/input 1, different options are available for the other outputs and inputs. Only one option can be selected for each output/input 1 to 3. The following tables must be read vertically (↓).

Example: If the option BA "4–20 mA HART" was selected for output/input 1, one of the options A, B, D, E, F, H, I or J is available for output 2 and one of the options A, B, D, E, F, H, I or J is available for output 3.

## Output/input 1 and options for output/input 2

 Options for output/input 3 →  14

| Order code for "Output; input 1" (020) →                                   | Possible options |      |      |      |      |      |      |      |      |      |      |      |      |      |   |
|--|------------------|------|------|------|------|------|------|------|------|------|------|------|------|------|---|
| Current output 4 to 20 mA HART   | BA               |      |      |      |      |      |      |      |      |      |      |      |      |      |   |
| Current output 4 to 20 mA HART Ex i passive                                | ↓ CA             |      |      |      |      |      |      |      |      |      |      |      |      |      |   |
| Current output 4 to 20 mA HART Ex i active                                 |                  | ↓ CC |      |      |      |      |      |      |      |      |      |      |      |      |   |
| FOUNDATION fieldbus  |                  |      | ↓ SA |      |      |      |      |      |      |      |      |      |      |      |   |
| FOUNDATION fieldbus Ex i   |                  |      |      | ↓ TA |      |      |      |      |      |      |      |      |      |      |   |
| PROFIBUS DP  |                  |      |      |      | ↓ LA |      |      |      |      |      |      |      |      |      |   |
| PROFIBUS PA  |                  |      |      |      |      | ↓ GA |      |      |      |      |      |      |      |      |   |
| PROFIBUS PA Ex i   |                  |      |      |      |      |      | ↓ HA |      |      |      |      |      |      |      |   |
| Modbus RS485   |                  |      |      |      |      |      |      | ↓ MA |      |      |      |      |      |      |   |
| Ethernet/IP 2-port switch integrated                                       |                  |      |      |      |      |      |      |      | ↓ NA |      |      |      |      |      |   |
| PROFINET 2-port switch integrated  |                  |      |      |      |      |      |      |      |      | ↓ RA |      |      |      |      |   |
| PROFINET over Ethernet-APL   |                  |      |      |      |      |      |      |      |      |      | ↓ RB |      |      |      |   |
| PROFINET over Ethernet-APL Ex i  |                  |      |      |      |      |      |      |      |      |      |      | ↓ RC |      |      |   |
| Modbus TCP over Ethernet-APL 10 Mbit/s, SPE 10 Mbit/s, Ethernet 100 Mbit/s |                  |      |      |      |      |      |      |      |      |      |      |      | ↓ MB |      |   |
| Modbus TCP over Ethernet-APL, Ex i, 10 Mbit/s, Ethernet 100 Mbit/s         |                  |      |      |      |      |      |      |      |      |      |      |      |      | ↓ MC |   |
| <b>Order code for "Output; input 2" (021) →</b>                            | ↓                | ↓    | ↓    | ↓    | ↓    | ↓    | ↓    | ↓    | ↓    | ↓    | ↓    | ↓    | ↓    | ↓    | ↓ |
| Not used   | A                | A    | A    | A    | A    | A    | A    | A    | A    | A    | A    | A    | A    | A    | A |
| Current output 4 to 20 mA  | B                |      |      | B    |      | B    | B    |      | B    | B    | B    | B    |      | B    |   |
| Current output 4 to 20 mA Ex i passive                                     |                  | C    | C    |      | C    |      |      | C    |      |      |      |      | C    |      | C |
| User-configurable input/output <sup>1)</sup>                               | D                |      |      | D    |      | D    | D    |      | D    | D    | D    | D    |      | D    |   |
| Pulse/frequency/switch output  | E                |      |      | E    |      | E    | E    |      | E    | E    | E    | E    |      | E    |   |
| Double pulse output <sup>2)</sup>  | F                |      |      |      |      |      |      |      | F    |      |      |      |      |      |   |
| Pulse/frequency/switch output Ex i passive                                 |                  | G    | G    |      | G    |      |      | G    |      |      |      |      | G    |      | G |
| Relay output   | H                |      |      | H    |      | H    | H    |      | H    | H    | H    | H    |      | H    |   |
| Current input 0/4 to 20 mA   | I                |      |      | I    |      | I    | I    |      | I    | I    | I    | I    |      | I    |   |
| Status input   | J                |      |      | J    |      | J    | J    |      | J    | J    | J    | J    |      | J    |   |

- 1) A specific input or output can be assigned to a user-configurable input/output →  22.
- 2) If double pulse output (F) is selected for output/input 2 (021), only the double pulse output (F) option is available for selection for output/input 3 (022).

## Output/input 1 and options for output/input 3

 Options for output/input 2 →  13

| Order code for "Output; input 1" (020) →                                   | Possible options |    |    |    |    |    |    |    |    |    |    |    |    |    |    |
|--|------------------|----|----|----|----|----|----|----|----|----|----|----|----|----|----|
| Current output 4 to 20 mA HART   | BA               |    |    |    |    |    |    |    |    |    |    |    |    |    |    |
| Current output 4 to 20 mA HART Ex i passive                                | ↓                | CA |    |    |    |    |    |    |    |    |    |    |    |    |    |
| Current output 4 to 20 mA HART Ex i active                                 |                  | ↓  | CC |    |    |    |    |    |    |    |    |    |    |    |    |
| FOUNDATION fieldbus  |                  |    | ↓  | SA |    |    |    |    |    |    |    |    |    |    |    |
| FOUNDATION fieldbus Ex i   |                  |    |    | ↓  | TA |    |    |    |    |    |    |    |    |    |    |
| PROFIBUS DP  |                  |    |    |    | ↓  | LA |    |    |    |    |    |    |    |    |    |
| PROFIBUS PA  |                  |    |    |    |    | ↓  | GA |    |    |    |    |    |    |    |    |
| PROFIBUS PA Ex i   |                  |    |    |    |    |    | ↓  | HA |    |    |    |    |    |    |    |
| Modbus RS485   |                  |    |    |    |    |    |    | ↓  | MA |    |    |    |    |    |    |
| Ethernet/IP 2-port switch integrated                                       |                  |    |    |    |    |    |    |    | ↓  | NA |    |    |    |    |    |
| PROFINET 2-port switch integrated  |                  |    |    |    |    |    |    |    |    | ↓  | RA |    |    |    |    |
| PROFINET over Ethernet-APL 10 Mbit/s, 2-wire                               |                  |    |    |    |    |    |    |    |    |    | ↓  | RB |    |    |    |
| PROFINET over Ethernet-APL Ex i, 10 Mbit/s, 2-wire                         |                  |    |    |    |    |    |    |    |    |    |    | ↓  | RC |    |    |
| Modbus TCP over Ethernet-APL 10 Mbit/s, SPE 10 Mbit/s, Ethernet 100 Mbit/s |                  |    |    |    |    |    |    |    |    |    |    |    | ↓  | MB |    |
| Modbus TCP over Ethernet-APL, Ex i, 10 Mbit/s, Ethernet 100 Mbit/s         |                  |    |    |    |    |    |    |    |    |    |    |    |    | ↓  | MC |
| <b>Order code for "Output; input 3" (022) →</b>                            | ↓                | ↓  | ↓  | ↓  | ↓  | ↓  | ↓  | ↓  | ↓  | ↓  | ↓  | ↓  | ↓  | ↓  | ↓  |
| Not used   | A                | A  | A  | A  | A  | A  | A  | A  | A  | A  | A  | A  | A  | A  | A  |
| Current output 4 to 20 mA  | B                |    |    |    |    | B  |    |    | B  | B  | B  | B  |    | B  |    |
| Current output 4 to 20 mA Ex i passive                                     |                  | C  | C  |    |    |    |    |    |    |    |    |    |    |    |    |
| User-configurable input/output   | D                |    |    |    |    | D  |    |    | D  | D  | D  | D  |    | D  |    |
| Pulse/frequency/switch output  | E                |    |    |    |    | E  |    |    | E  | E  | E  | E  |    | E  |    |
| Double pulse output (slave) <sup>1)</sup>                                  | F                |    |    |    |    |    |    |    | F  |    |    |    |    |    |    |
| Pulse/frequency/switch output Ex i passive                                 |                  | G  | G  |    |    |    |    |    |    |    |    |    |    |    |    |
| Relay output   | H                |    |    |    |    | H  |    |    | H  | H  | H  | H  |    | H  |    |
| Current input 0/4 to 20 mA   | I                |    |    |    |    | I  |    |    | I  | I  | I  | I  |    | I  |    |
| Status input   | J                |    |    |    |    | J  |    |    | J  | J  | J  | J  |    | J  |    |

1) If double pulse output (F) is selected for output/input 2 (021), only the double pulse output (F) option is available for output/input 3 (022).

## Output signal

## Current output 4 to 20 mA HART

|                                      |  |
|--------------------------------------|--|
| <b>Order code</b>                    | "Output; input 1" (20):<br>Option BA: current output 4 to 20 mA HART   |
| <b>Signal mode</b>                   | Can be set to: <ul style="list-style-type: none"> <li>■ Active</li> <li>■ Passive</li> </ul>   |
| <b>Current range</b>                 | Can be set to: <ul style="list-style-type: none"> <li>■ 4 to 20 mA NAMUR</li> <li>■ 4 to 20 mA US</li> <li>■ 4 to 20 mA</li> <li>■ 0 to 20 mA (only if the signal mode is active)</li> <li>■ Fixed current</li> </ul>  |
| <b>Open-circuit voltage</b>          | DC 28.8 V (active)   |
| <b>Maximum input voltage</b>         | DC 30 V (passive)  |
| <b>Load</b>                          | 250 to 700 $\Omega$  |
| <b>Resolution</b>                    | 0.38 $\mu$ A   |
| <b>Damping</b>                       | Configurable: 0 to 999.9 s   |
| <b>Assignable measured variables</b> | <ul style="list-style-type: none"> <li>■ Mass flow</li> <li>■ Volume flow</li> <li>■ Corrected volume flow</li> <li>■ Density</li> <li>■ Reference density</li> <li>■ Temperature</li> <li>■ Electronics temperature</li> <li>■ Oscillation frequency 0</li> <li>■ Oscillation damping 0</li> <li>■ Signal asymmetry</li> <li>■ Exciter current 0</li> </ul> <p> The range of options increases if the measuring device has one or more application packages.</p> |

## Current output 4 to 20 mA HART Ex i

|                              |   |
|------------------------------|---|
| <b>Order code</b>            | "Output; input 1" (20) choose from: <ul style="list-style-type: none"> <li>■ Option CA: current output 4 to 20 mA HART Ex i passive</li> <li>■ Option CC: current output 4 to 20 mA HART Ex i active</li> </ul>       |
| <b>Signal mode</b>           | Depends on the selected order version.  |
| <b>Current range</b>         | Can be set to: <ul style="list-style-type: none"> <li>■ 4 to 20 mA NAMUR</li> <li>■ 4 to 20 mA US</li> <li>■ 4 to 20 mA</li> <li>■ 0 to 20 mA (only if the signal mode is active)</li> <li>■ Fixed current</li> </ul> |
| <b>Open-circuit voltage</b>  | DC 21.8 V (active)  |
| <b>Maximum input voltage</b> | DC 30 V (passive)   |
| <b>Load</b>                  | <ul style="list-style-type: none"> <li>■ 250 to 400 <math>\Omega</math> (active)</li> <li>■ 250 to 700 <math>\Omega</math> (passive)</li> </ul>   |
| <b>Resolution</b>            | 0.38 $\mu$ A  |

|                                      |  |
|--------------------------------------|--|
| <b>Damping</b>                       | Configurable: 0 to 999.9 s   |
| <b>Assignable measured variables</b> | <ul style="list-style-type: none"> <li>▪ Mass flow</li> <li>▪ Volume flow</li> <li>▪ Corrected volume flow</li> <li>▪ Density</li> <li>▪ Reference density</li> <li>▪ Temperature</li> <li>▪ Electronics temperature</li> <li>▪ Oscillation frequency 0</li> <li>▪ Oscillation damping 0</li> <li>▪ Signal asymmetry</li> <li>▪ Exciter current 0</li> </ul> <p> The range of options increases if the measuring device has one or more application packages.</p> |

#### FOUNDATION Fieldbus

|                                 |   |
|---------------------------------|---|
| <b>FOUNDATION Fieldbus</b>      | H1, IEC 61158-2, galvanically isolated      |
| <b>Data transfer</b>            | 31.25 kbit/s                                |
| <b>Current consumption</b>      | 10 mA                                       |
| <b>Permitted supply voltage</b> | 9 to 32 V                                   |
| <b>Bus connection</b>           | With integrated reverse polarity protection |

#### PROFIBUS DP

|                             |   |
|-----------------------------|---|
| <b>Signal encoding</b>      | NRZ code                                      |
| <b>Data transfer</b>        | 9.6 kBaud...12 MBaud                          |
| <b>Terminating resistor</b> | Integrated, can be activated via DIP switches |

#### PROFIBUS PA

|                                 |  |
|---------------------------------|--|
| <b>PROFIBUS PA</b>              | In accordance with EN 50170 Volume 2, IEC 61158-2 (MBP), galvanically isolated |
| <b>Data transmission</b>        | 31.25 kbit/s   |
| <b>Current consumption</b>      | 10 mA  |
| <b>Permitted supply voltage</b> | 9 to 32 V  |
| <b>Bus connection</b>           | With integrated reverse polarity protection                                    |

#### Modbus RS485

|                             |   |
|-----------------------------|---|
| <b>Physical interface</b>   | RS485 in accordance with EIA/TIA-485 standard |
| <b>Terminating resistor</b> | Integrated, can be activated via DIP switches |

**Modbus TCP over Ethernet-APL**

| <b>Port 1: Modbus TCP over Ethernet-APL 10 Mbit/s</b> |  |
|---|--|
| <b>Device usage</b>                                   | <p><b>Device connection to an APL field switch (terminal 26/27)</b><br/>                     The device may only be operated according to the following APL port classifications:</p> <ul style="list-style-type: none"> <li>▪ If used in hazardous areas: SLAA or SLAC <sup>1)</sup></li> <li>▪ If used in non-hazardous areas: SLAX</li> </ul> <p>Connection values of APL field switch (corresponds to APL port classification SPCC or SPAA, for instance):</p> <ul style="list-style-type: none"> <li>▪ Maximum input voltage: 15 V<sub>DC</sub></li> <li>▪ Minimum output values: 0.54 W</li> </ul> <p><b>Device connection to an SPE switch</b></p> <ul style="list-style-type: none"> <li>▪ In non-hazardous areas, the device can be used with an appropriate SPE switch:                             <ul style="list-style-type: none"> <li>▪ Maximum output voltage: 30 V<sub>DC</sub></li> <li>▪ Minimum output power: 1.85 W</li> </ul> </li> <li>▪ The SPE switch must support the 10BASE-T1L standard and PoDL power classes 10, 11 or 12 and have a function to disable power class detection.</li> </ul> |
| <b>Standards</b>                                      | According to IEEE 802.3cg, APL port profile specification v1.0, galvanically isolated  |
| <b>Data transfer</b>                                  | Full-duplex (APL/SPE)  |
| <b>Current consumption</b>                            | Terminal 26/27 max. approx. 45 mA  |
| <b>Permitted supply voltage</b>                       | 9 to 30 V  |
| <b>Bus connection</b>                                 | Terminal 26/27 with integrated reverse polarity protection   |

1) For more information on using the device in the hazardous area, see the Ex-specific Safety Instructions

| <b>Port 2: Modbus TCP over Ethernet 100 Mbit/s</b> |   |
|--|---|
| <b>Device usage</b>                                | <p><b>Device connection to a Fast Ethernet (RJ45) switch</b><br/>                     In non-hazardous areas, the Ethernet switch must support the standard 100BASE-TX.</p> |
| <b>Standards</b>                                   | In accordance with IEEE 802.3u  |
| <b>Data transfer</b>                               | Half-duplex, full-duplex  |
| <b>Current consumption</b>                         | -   |
| <b>Permitted supply voltage</b>                    | -   |
| <b>Bus connection</b>                              | Service interface (RJ45)  |

**EtherNet/IP**

|                  |                               |
|------------------|-------------------------------|
| <b>Standards</b> | In accordance with IEEE 802.3 |
|------------------|-------------------------------|

**PROFINET**

|                  |                               |
|------------------|-------------------------------|
| <b>Standards</b> | In accordance with IEEE 802.3 |
|------------------|-------------------------------|

## PROFINET over Ethernet-APL

|                                 |  |
|---------------------------------|--|
| <b>Device use</b>               | <p><b>Device connection to an APL field switch</b><br/>The device may only be operated according to the following APL port classifications:</p> <ul style="list-style-type: none"> <li>▪ If used in hazardous areas: SLAA or SLAC <sup>1)</sup></li> <li>▪ If used in non-hazardous areas: SLAX</li> </ul> <p>Connection values of APL field switch (corresponds to APL port classification SPCC or SPAA, for instance):</p> <ul style="list-style-type: none"> <li>▪ Maximum input voltage: 15 V<sub>DC</sub></li> <li>▪ Minimum output values: 0.54 W</li> </ul> <p><b>Device connection to an SPE switch</b></p> <ul style="list-style-type: none"> <li>▪ In non-hazardous areas, the device can be used with an appropriate SPE switch: The device can be connected to an SPE switch with a maximum voltage of 30 V<sub>DC</sub> and a minimum output power of 1.85 W connected.</li> <li>▪ The SPE switch must support the 10BASE-T1L standard and PoDL power classes 10, 11 or 12 and have a function to disable power class detection.</li> </ul> |
| <b>PROFINET</b>                 | According to IEC 61158 and IEC 61784   |
| <b>Ethernet-APL</b>             | According to IEEE 802.3cg, APL port profile specification v1.0, galvanically isolated  |
| <b>Data transfer</b>            | 10 Mbit/s  |
| <b>Current consumption</b>      | <p><b>Transmitter</b></p> <ul style="list-style-type: none"> <li>▪ Max. 400 mA (24 V)</li> <li>▪ Max. 200 mA (110 V, 50/60 Hz; 230 V, 50/60 Hz)</li> </ul>   |
| <b>Permitted supply voltage</b> | 9 to 30 V  |
| <b>Network connection</b>       | With integrated reverse polarity protection  |

1) For more information on using the device in the hazardous area, see the Ex-specific Safety Instructions

## Current output 4 to 20 mA

|                              |   |
|------------------------------|---|
| <b>Order code</b>            | "Output; input 2" (21), "Output; input 3" (022):<br>Option B: current output 4 to 20 mA   |
| <b>Signal mode</b>           | Can be set to: <ul style="list-style-type: none"> <li>▪ Active</li> <li>▪ Passive</li> </ul>  |
| <b>Current range</b>         | Can be set to: <ul style="list-style-type: none"> <li>▪ 4 to 20 mA NAMUR</li> <li>▪ 4 to 20 mA US</li> <li>▪ 4 to 20 mA</li> <li>▪ 0 to 20 mA (only if the signal mode is active)</li> <li>▪ Fixed current</li> </ul> |
| <b>Maximum output values</b> | 22.5 mA   |
| <b>Open-circuit voltage</b>  | DC 28.8 V (active)  |
| <b>Maximum input voltage</b> | DC 30 V (passive)   |
| <b>Load</b>                  | 0 to 700 Ω  |
| <b>Resolution</b>            | 0.38 μA   |



|                                      |  |
|--------------------------------------|--|
| <b>Damping</b>                       | Configurable: 0 to 999.9 s   |
| <b>Assignable measured variables</b> | <ul style="list-style-type: none"> <li>▪ Mass flow</li> <li>▪ Volume flow</li> <li>▪ Corrected volume flow</li> <li>▪ Density</li> <li>▪ Reference density</li> <li>▪ Temperature</li> <li>▪ Electronics temperature</li> <li>▪ Oscillation frequency 0</li> <li>▪ Oscillation damping 0</li> <li>▪ Signal asymmetry</li> <li>▪ Exciter current 0</li> </ul> <p> The range of options increases if the measuring device has one or more application packages.</p> |

**Current output 4 to 20 mA Ex i passive**

|                                      |  |
|--------------------------------------|--|
| <b>Order code</b>                    | "Output; input 2" (21), "Output; input 3" (022):<br>Option C: current output 4 to 20 mA Ex i passive   |
| <b>Signal mode</b>                   | Passive  |
| <b>Current range</b>                 | Can be set to: <ul style="list-style-type: none"> <li>▪ 4 to 20 mA NAMUR</li> <li>▪ 4 to 20 mA US</li> <li>▪ 4 to 20 mA</li> <li>▪ Fixed current</li> </ul>  |
| <b>Maximum output values</b>         | 22.5 mA  |
| <b>Maximum input voltage</b>         | DC 30 V  |
| <b>Load</b>                          | 0 to 700 Ω   |
| <b>Resolution</b>                    | 0.38 μA  |
| <b>Damping</b>                       | Configurable: 0 to 999 s   |
| <b>Assignable measured variables</b> | <ul style="list-style-type: none"> <li>▪ Mass flow</li> <li>▪ Volume flow</li> <li>▪ Corrected volume flow</li> <li>▪ Density</li> <li>▪ Reference density</li> <li>▪ Temperature</li> <li>▪ Electronics temperature</li> <li>▪ Oscillation frequency 0</li> <li>▪ Oscillation damping 0</li> <li>▪ Signal asymmetry</li> <li>▪ Exciter current 0</li> </ul> <p> The range of options increases if the measuring device has one or more application packages.</p> |

**Pulse/frequency/switch output**

|                             |  |
|-----------------------------|--|
| <b>Function</b>             | Can be configured as pulse, frequency or switch output   |
| <b>Version</b>              | Open collector<br>Can be set to: <ul style="list-style-type: none"> <li>▪ Active</li> <li>▪ Passive</li> <li>▪ Passive NAMUR</li> </ul> <p> Ex-i, passive</p> |
| <b>Maximum input values</b> | DC 30 V, 250 mA (passive)  |
| <b>Open-circuit voltage</b> | DC 28.8 V (active)   |
| <b>Voltage drop</b>         | For 22.5 mA: ≤ DC 2 V  |

| Pulse output                  |   |
|-------------------------------|---|
| Maximum input values          | DC 30 V, 250 mA (passive)   |
| Maximum output current        | 22.5 mA (active)  |
| Open-circuit voltage          | DC 28.8 V (active)  |
| Pulse width                   | Configurable: 0.05 to 2 000 ms  |
| Maximum pulse rate            | 10 000 Impulse/s  |
| Pulse value                   | Configurable  |
| Assignable measured variables | <ul style="list-style-type: none"> <li>▪ Mass flow</li> <li>▪ Volume flow</li> <li>▪ Corrected volume flow</li> </ul>  The range of options increases if the measuring device has one or more application packages.  |
| Frequency output              |   |
| Maximum input values          | DC 30 V, 250 mA (passive)   |
| Maximum output current        | 22.5 mA (active)  |
| Open-circuit voltage          | DC 28.8 V (active)  |
| Output frequency              | Configurable: end value frequency 2 to 10 000 Hz ( $f_{\max} = 12\,500$ Hz)   |
| Damping                       | Configurable: 0 to 999.9 s  |
| Pulse/pause ratio             | 1:1   |
| Assignable measured variables | <ul style="list-style-type: none"> <li>▪ Mass flow</li> <li>▪ Volume flow</li> <li>▪ Corrected volume flow</li> <li>▪ Density</li> <li>▪ Reference density</li> <li>▪ Temperature</li> <li>▪ Electronics temperature</li> <li>▪ Oscillation frequency 0</li> <li>▪ Oscillation damping 0</li> <li>▪ Signal asymmetry</li> <li>▪ Exciter current 0</li> </ul>  The range of options increases if the measuring device has one or more application packages. |
| Switch output                 |   |
| Maximum input values          | DC 30 V, 250 mA (passive)   |
| Open-circuit voltage          | DC 28.8 V (active)  |
| Switching behavior            | Binary, conductive or non-conductive  |
| Switching delay               | Configurable: 0 to 100 s  |

|                                   |  |
|-----------------------------------|--|
| <b>Number of switching cycles</b> | Unlimited  |
| <b>Assignable functions</b>       | <ul style="list-style-type: none"> <li>▪ Disable</li> <li>▪ On</li> <li>▪ Diagnostic behavior</li> <li>▪ Limit                             <ul style="list-style-type: none"> <li>▪ Mass flow</li> <li>▪ Volume flow</li> <li>▪ Corrected volume flow</li> <li>▪ Density</li> <li>▪ Reference density</li> <li>▪ Temperature</li> <li>▪ Totalizer 1-3</li> </ul> </li> <li>▪ Flow direction monitoring</li> <li>▪ Status                             <ul style="list-style-type: none"> <li>▪ Partially filled pipe detection</li> <li>▪ Low flow cut off</li> </ul> </li> </ul> <p> The range of options increases if the measuring device has one or more application packages.</p> |

**Double pulse output**

|                                      |  |
|--------------------------------------|--|
| <b>Function</b>                      | Double pulse   |
| <b>Version</b>                       | Open collector<br>Can be set to: <ul style="list-style-type: none"> <li>▪ Active</li> <li>▪ Passive</li> <li>▪ Passive NAMUR</li> </ul>  |
| <b>Maximum input values</b>          | DC 30 V, 250 mA (passive)  |
| <b>Open-circuit voltage</b>          | DC 28.8 V (active)   |
| <b>Voltage drop</b>                  | For 22.5 mA: ≤ DC 2 V  |
| <b>Output frequency</b>              | Configurable: 0 to 1000 Hz   |
| <b>Damping</b>                       | Configurable: 0 to 999 s   |
| <b>Pulse/pause ratio</b>             | 1:1  |
| <b>Assignable measured variables</b> | <ul style="list-style-type: none"> <li>▪ Mass flow</li> <li>▪ Volume flow</li> <li>▪ Corrected volume flow</li> <li>▪ Density</li> <li>▪ Reference density</li> <li>▪ Temperature</li> </ul> <p> The range of options increases if the measuring device has one or more application packages.</p> |

**Relay output**

|                           |  |
|---------------------------|--|
| <b>Function</b>           | Switch output  |
| <b>Version</b>            | Relay output, galvanically isolated  |
| <b>Switching behavior</b> | Can be set to: <ul style="list-style-type: none"> <li>▪ NO (normally open), factory setting</li> <li>▪ NC (normally closed)</li> </ul> |

|   |  |
|---|--|
| <b>Maximum switching capacity (passive)</b> | <ul style="list-style-type: none"> <li>▪ DC 30 V, 0.1 A</li> <li>▪ AC 30 V, 0.5 A</li> </ul>   |
| <b>Assignable functions</b>                 | <ul style="list-style-type: none"> <li>▪ Disable</li> <li>▪ On</li> <li>▪ Diagnostic behavior</li> <li>▪ Limit                             <ul style="list-style-type: none"> <li>▪ Mass flow</li> <li>▪ Volume flow</li> <li>▪ Corrected volume flow</li> <li>▪ Density</li> <li>▪ Reference density</li> <li>▪ Temperature</li> <li>▪ Totalizer 1-3</li> </ul> </li> <li>▪ Flow direction monitoring</li> <li>▪ Status                             <ul style="list-style-type: none"> <li>▪ Partially filled pipe detection</li> <li>▪ Low flow cut off</li> </ul> </li> </ul> <p> The range of options increases if the measuring device has one or more application packages.</p> |

### User-configurable input/output

**One** specific input or output is assigned to a user-configurable input/output (configurable I/O) during device commissioning.

The following inputs and outputs are available for assignment:

- Choice of current output: 4 to 20 mA (active), 0/4 to 20 mA (passive)
- Pulse/frequency/switch output
- Choice of current input: 4 to 20 mA (active), 0/4 to 20 mA (passive)
- Status input

The technical values correspond to those of the inputs and outputs described in this section.

### Signal on alarm

Depending on the interface, failure information is displayed as follows:

#### HART current output

|                           |  |
|---------------------------|--|
| <b>Device diagnostics</b> | Device condition can be read out via HART Command 48 |
|---------------------------|--|

#### PROFIBUS PA

|   |   |
|---|---|
| <b>Status and alarm messages</b>                            | Diagnostics in accordance with PROFIBUS PA Profile 3.02 |
| <b>Failure current FDE (Fault Disconnection Electronic)</b> | 0 mA  |

#### PROFIBUS DP

|                                  |   |
|----------------------------------|---|
| <b>Status and alarm messages</b> | Diagnostics in accordance with PROFIBUS PA Profile 3.02 |
|----------------------------------|---|

#### EtherNet/IP

|                           |  |
|---------------------------|--|
| <b>Device diagnostics</b> | Device condition can be read out in Input Assembly |
|---------------------------|--|

#### PROFINET

|                           |  |
|---------------------------|--|
| <b>Device diagnostics</b> | According to "Application Layer protocol for decentralized periphery", Version 2.3 |
|---------------------------|--|

**PROFINET over Ethernet-APL**

|                    |   |
|--------------------|---|
| Device diagnostics | Diagnostics according to PROFINET PA Profile 4.02 |
|--------------------|---|

**FOUNDATION Fieldbus**

|  |                                       |
|--|---------------------------------------|
| Status and alarm messages                            | Diagnostics in accordance with FF-891 |
| Failure current FDE (Fault Disconnection Electronic) | 0 mA                                  |

**Modbus RS485**

|              |   |
|--------------|---|
| Failure mode | Choose from: <ul style="list-style-type: none"> <li>▪ NaN value instead of current value</li> <li>▪ Last valid value</li> </ul> |
|--------------|---|

**Modbus TCP over Ethernet-APL/SPE/Fast Ethernet**

|              |   |
|--------------|---|
| Failure mode | Choose from: <ul style="list-style-type: none"> <li>▪ NaN value instead of current value</li> <li>▪ Last valid value</li> </ul> |
|--------------|---|

**Current output**

|                               |  |
|-------------------------------|--|
| <b>Current output 4-20 mA</b> |  |
| Failure mode                  | Configurable: <ul style="list-style-type: none"> <li>▪ 4 to 20 mA in accordance with NAMUR recommendation NE 43</li> <li>▪ 4 to 20 mA in accordance with US</li> <li>▪ Min. value: 3.59 mA</li> <li>▪ Max. value: 22.5 mA</li> <li>▪ Definable value between: 3.59 to 22.5 mA</li> <li>▪ Actual value</li> <li>▪ Last valid value</li> </ul> |
| <b>Current output 4-20 mA</b> |  |
| Failure mode                  | Configurable: <ul style="list-style-type: none"> <li>▪ Maximum alarm: 22 mA</li> <li>▪ Definable value between: 0 to 20.5 mA</li> </ul>  |

**Pulse/frequency/switch output**

|                         |   |
|-------------------------|---|
| <b>Pulse output</b>     |   |
| Failure mode            | Configurable: <ul style="list-style-type: none"> <li>▪ Actual value</li> <li>▪ No pulses</li> </ul>   |
| <b>Frequency output</b> |   |
| Failure mode            | Configurable: <ul style="list-style-type: none"> <li>▪ Actual value</li> <li>▪ 0 Hz</li> <li>▪ Definable value between: 2 to 12 500 Hz</li> </ul> |
| <b>Switch output</b>    |   |
| Failure mode            | Configurable: <ul style="list-style-type: none"> <li>▪ Current status</li> <li>▪ Open</li> <li>▪ Closed</li> </ul>                                |

**Relay output**

|                     |   |
|---------------------|---|
| <b>Failure mode</b> | Choose from: <ul style="list-style-type: none"> <li>■ Current status</li> <li>■ Open</li> <li>■ Closed</li> </ul> |
|---------------------|---|

**Local display**

|                           |   |
|---------------------------|---|
| <b>Plain text display</b> | With information on cause and remedial measures |
| <b>Backlight</b>          | Red lighting indicates a device error.          |



Status signal as per NAMUR recommendation NE 107

**Interface/protocol**

- Via digital communication:
  - HART protocol
  - FOUNDATION Fieldbus
  - PROFIBUS PA
  - PROFIBUS DP
  - Modbus RS485
  - Modbus TCP over Ethernet-APL
  - EtherNet/IP
  - PROFINET
  - PROFINET over Ethernet-APL
- Via service interface
  - Service interface CDI-RJ45
  - Via service interface/port 2: (RJ45)
  - WLAN interface
- Plain text display
  - With information on cause and remedial actions
  - Modbus TCP



Additional information on remote operation → 94

**Web browser**

|                           |   |
|---------------------------|---|
| <b>Plain text display</b> | With information on cause and remedial measures |
|---------------------------|---|

**LEDs**

|                           |   |
|---------------------------|---|
| <b>Status information</b> | Status indicated by various LEDs<br>The following information is displayed depending on the device version: <ul style="list-style-type: none"> <li>■ Supply voltage active</li> <li>■ Data transmission active</li> <li>■ Device alarm/error has occurred</li> <li>■ Network available <sup>1)</sup></li> <li>■ Connection established <sup>1)</sup></li> <li>■ Diagnostic status <sup>2)</sup></li> <li>■ PROFINET blinking feature <sup>3)</sup></li> </ul> |
|---------------------------|---|

1) Only available for PROFINET, PROFINET over Ethernet-APL, Modbus over Ethernet-APL, Ethernet/IP

2) Only available for Modbus over Ethernet-APL

3) Only available for PROFINET, PROFINET over Ethernet-APL,

**Load**

Output signal → 15

**Ex connection data**                      **Safety-related values**

| Order code for<br>"Output; input 1" | Output type  | Safety-related values   |  |
|-------------------------------------|--|---|--|
|                                     |  | Output; input 1<br>(Port 1)   | Service interface<br>(Port 2)            |
| Option <b>BA</b>                    | Current output<br>4-20 mA HART   | $U_N = 30 V_{DC}$<br>$U_M = 250 V_{AC}$   | $U_N = 3.3 V_{AC}$<br>$U_M = 250 V_{AC}$ |
| Option <b>GA</b>                    | PROFIBUS PA  | $U_N = 32 V_{DC}$<br>$U_M = 250 V_{AC}$   | $U_N = 3.3 V_{AC}$<br>$U_M = 250 V_{AC}$ |
| Option <b>LA</b>                    | PROFIBUS DP  | $U_N = 5 V$<br>$U_M = 250 V_{AC}$   | $U_N = 3.3 V_{AC}$<br>$U_M = 250 V_{AC}$ |
| Option <b>MA</b>                    | Modbus RS485   | $U_N = 5 V$<br>$U_M = 250 V_{AC}$   | $U_N = 3.3 V_{AC}$<br>$U_M = 250 V_{AC}$ |
| Option <b>MB</b>                    | Modbus TCP over Ethernet-APL 10<br>Mbit/s, SPE 10 Mbit/s,<br>Ethernet 100 Mbit/s | APL port profile SLAX<br>SPE PoDL classes 10, 11, 12<br>$U_N = 30 V_{DC}$<br>$U_M = 250 V_{AC}$ | $U_N = 3.3 V_{AC}$<br>$U_M = 250 V_{AC}$ |
| Option <b>NA</b>                    | EtherNet/IP  | $U_N = 3.3 V_{AC}$<br>$U_M = 250 V_{AC}$  | $U_N = 3.3 V_{AC}$<br>$U_M = 250 V_{AC}$ |
| Option <b>RA</b>                    | PROFINET   | $U_N = 3.3 V_{AC}$<br>$U_M = 250 V_{AC}$  | $U_N = 3.3 V_{AC}$<br>$U_M = 250 V_{AC}$ |
| Option <b>RB</b>                    | PROFINET over Ethernet-APL/SPE,<br>10Mbit/s                                      | APL port profile SLAX<br>SPE PoDL classes 10, 11, 12<br>$U_N = 30 V_{DC}$<br>$U_M = 250 V_{AC}$ | $U_N = 3.3 V_{AC}$<br>$U_M = 250 V_{AC}$ |
| Option <b>SA</b>                    | FOUNDATION Fieldbus  | $U_N = 32 V_{DC}$<br>$U_M = 250 V_{AC}$   | $U_N = 3.3 V_{AC}$<br>$U_M = 250 V_{AC}$ |

The specifications for  $U_M$  only apply to devices with Ex i circuits. Zone 1; Class I, Division 1 devices; Zone 2; Class I Division 2 devices with Ex i sensor.

| Order code for<br>"Output; input 2"<br>"Output; input 3" | Output type                          | Safety-related values  |                 |
|--|--------------------------------------|--|-----------------|
|  |                                      | Output; input 2  | Output; input 3 |
| Option <b>B</b>  | Current output<br>4-20 mA            | $U_N = 30 V_{DC}$<br>$U_M = 250 V_{AC}$                                    |                 |
| Option <b>D</b>  | Configurable I/O initial setting off | $U_N = 30 V_{DC}$<br>$U_M = 250 V_{AC}$                                    |                 |
| Option <b>E</b>  | Pulse/frequency/switch output        | $U_N = 30 V_{DC}$<br>$U_M = 250 V_{AC}$                                    |                 |
| Option <b>F</b>  | Double pulse output                  | $U_N = 30 V_{DC}$<br>$U_M = 250 V_{AC}$                                    |                 |
| Option <b>H</b>  | Relay output                         | $U_N = 30 V_{DC}$<br>$I_N = 100 mA_{DC}/500 mA_{AC}$<br>$U_M = 250 V_{AC}$ |                 |
| Option <b>I</b>  | Current input<br>4-20 mA             | $U_N = 30 V_{DC}$<br>$U_M = 250 V_{AC}$                                    |                 |
| Option <b>J</b>  | Status input                         | $U_N = 30 V_{DC}$<br>$U_M = 250 V_{AC}$                                    |                 |

## Intrinsically safe values

| Zone 1, Zone 21                     |   |   |  |
|-------------------------------------|---|---|--|
| Order code for<br>"Output; input 1" | Output type                                   | Intrinsically safe values   |  |
|                                     |   | Output; input 1<br>(Port 1)   | Service interface<br>(Port 2)  |
| Option CA                           | Current output<br>4-20mA HART Ex-i<br>passive | <b>Ex ia</b><br>$U_i = 30 \text{ V}$<br>$I_i = 100 \text{ mA}$<br>$P_i = 1.25 \text{ W}$<br>$L_i = 0 \text{ } \mu\text{H}$<br>$C_i = 6 \text{ nF}$  | <b>Ex ia</b><br>$U_i = 10 \text{ V}$<br>$I_i = \text{n. a.}$<br>$P_i = \text{n. a.}$<br>$L_i = 0 \text{ } \mu\text{H}$<br>$C_i = 200 \text{ nF}$ |
| Option CC                           | Current output<br>4-20mA HART Ex-i active     | <b>Ex ia</b><br>$U_0 = 21.8 \text{ V}$<br>$I_0 = 90 \text{ mA}$<br>$P_0 = 491 \text{ mW}$<br>$L_0 = 4.1 \text{ mH(IIC)}/15 \text{ mH(IIB)}$<br>$C_0 = 160 \text{ nF(IIC)}/1160 \text{ nF(IIB)}$<br><br>$U_i = 30 \text{ V}$<br>$I_i = 10 \text{ mA}$<br>$P_i = 0.3 \text{ W}$<br>$L_i = 5 \text{ } \mu\text{H}$<br>$L_i = 4.1 \text{ } \mu\text{H}$<br>$C_i = 6 \text{ nF}$ | <b>Ex ia</b><br>$U_i = 10 \text{ V}$<br>$I_i = \text{n. a.}$<br>$P_i = \text{n. a.}$<br>$L_i = 0 \text{ } \mu\text{H}$<br>$C_i = 200 \text{ nF}$ |
| Option HA                           | PROFIBUS PA Ex i<br>(STANDARD + FISCO)        | <b>Ex ia</b><br>$U_i = 30 \text{ V}$<br>$I_i = 570 \text{ mA}$<br>$P_i = 8.5 \text{ W}$<br>$L_i = 10 \text{ } \mu\text{H}$<br>$C_i = 5 \text{ nF}$  | <b>Ex ia</b><br>$U_i = 10 \text{ V}$<br>$I_i = \text{n. a.}$<br>$P_i = \text{n. a.}$<br>$L_i = 0 \text{ } \mu\text{H}$<br>$C_i = 200 \text{ nF}$ |

| Zone 1, Zone 21                  |  |   |  |
|----------------------------------|--|---|--|
| Order code for "Output; input 1" | Output type                                  | Intrinsically safe values   |  |
|                                  |  | Output; input 1 (Port 1)  | Service interface (Port 2)   |
| Option MC                        | Modbus TCP over Ethernet-APL, Ex-i, 10Mbit/s | <b>2-WISE power load, APL port profile SLAA <sup>1)</sup></b><br><b>Ex ia</b><br>$U_i = 17.5 \text{ V}$<br>$I_i = 380 \text{ mA}$<br>$P_i = 5.32 \text{ W}$<br>$L_i = 10 \text{ } \mu\text{H}$<br>$C_i = 5 \text{ nF}$<br><b>Cable specifications according to 2-WISE:</b><br>$R_c = 15 \text{ to } 150 \text{ } \Omega/\text{km}$<br>$L_c = 0.4 \text{ to } 1 \text{ mH/km}$<br>$C_c = 45 \text{ to } 200 \text{ nF/km}$<br>$C_c = C_c \text{ line/line} + 0,5 C_c \text{ line/screen}$ , if both lines are floating, or<br>$C_c = C_c \text{ line/line} + C_c \text{ line/screen}$ , if the screen is connected to one line<br>Length of cable (not including cable stubs): $\leq 200 \text{ m (656.2 ft)}$<br>Length of cable stubs: $\leq 1 \text{ m (3.3 ft)}$ | <b>Ex ia</b><br>$U_i = 10 \text{ V}$<br>$I_i = \text{n. a.}$<br>$P_i = \text{n. a.}$<br>$L_i = 0 \text{ } \mu\text{H}$<br>$C_i = 200 \text{ nF}$ |
| Option RC                        | PROFINET over Ethernet-APL, Ex-i, 10Mbit/s   | <b>2-WISE power load, APL port profile SLAA <sup>1)</sup></b><br><b>Ex ia</b><br>$U_i = 17.5 \text{ V}$<br>$I_i = 380 \text{ mA}$<br>$P_i = 5.32 \text{ W}$<br>$L_i = 10 \text{ } \mu\text{H}$<br>$C_i = 5 \text{ nF}$<br><b>Cable specifications according to 2-WISE:</b><br>$R_c = 15 \text{ to } 150 \text{ } \Omega/\text{km}$<br>$L_c = 0.4 \text{ to } 1 \text{ mH/km}$<br>$C_c = 45 \text{ to } 200 \text{ nF/km}$<br>$C_c = C_c \text{ line/line} + 0,5 C_c \text{ line/screen}$ , if both lines are floating, or<br>$C_c = C_c \text{ line/line} + C_c \text{ line/screen}$ , if the screen is connected to one line<br>Length of cable (not including cable stubs): $\leq 200 \text{ m (656.2 ft)}$<br>Length of cable stubs: $\leq 1 \text{ m (3.3 ft)}$ | <b>Ex ia</b><br>$U_i = 10 \text{ V}$<br>$I_i = \text{n. a.}$<br>$P_i = \text{n. a.}$<br>$L_i = 0 \text{ } \mu\text{H}$<br>$C_i = 200 \text{ nF}$ |
| Option TA                        | FOUNDATION Fieldbus Ex i (STANDARD + FISCO)  | <b>Ex ia</b><br>$U_i = 30 \text{ V}$<br>$I_i = 570 \text{ mA}$<br>$P_i = 8.5 \text{ W}$<br>$L_i = 10 \text{ } \mu\text{H}$<br>$C_i = 5 \text{ nF}$  | <b>Ex ia</b><br>$U_i = 10 \text{ V}$<br>$I_i = \text{n. a.}$<br>$P_i = \text{n. a.}$<br>$L_i = 0 \text{ } \mu\text{H}$<br>$C_i = 200 \text{ nF}$ |

1) For further options see Ethernet-APL Installation Drawing HE\_01622.

| Zone 2                           |   |   |
|----------------------------------|---|---|
| Order code for "Output; input 1" | Output type                                     | Intrinsically safe values or NIFW values<br>Output; input 1<br>(Port 1)   |
| Option HA                        | PROFIBUS PA Ex i<br>(STANDARD + FISCO)          | <b>Ex ic</b><br><b>AEx ic, Ex ic, NIFW</b><br>$U_i = 32 \text{ V}$<br>$I_i = 570 \text{ mA}$<br>$P_i = 8.5 \text{ W}$<br>$L_i = 10 \mu\text{H}$<br>$C_i = 5 \text{ nF}$   |
| Option MC                        | Modbus TCP over Ethernet-APL,<br>Ex-i, 10Mbit/s | <b>2-WISE power load, APL port profile SLAC</b> <sup>1)</sup><br><b>Ex ic</b><br><b>AEx ic, Ex ic, NIFW</b><br>$U_i = 17.5 \text{ V}$<br>$I_i = 380 \text{ mA}$<br>$P_i = 5.32 \text{ W}$<br>$L_i = 10 \mu\text{H}$<br>$C_i = 5 \text{ nF}$<br><b>Cable specifications according to 2-WISE:</b><br>$R_c = 15 \text{ to } 150 \Omega/\text{km}$<br>$L_c = 0.4 \text{ to } 1 \text{ mH}/\text{km}$<br>$C_c = 45 \text{ to } 200 \text{ nF}/\text{km}$<br>$C_c = C_c \text{ line}/\text{line} + 0,5 C_c \text{ line}/\text{screen}$ , if both lines are floating, or<br>$C_c = C_c \text{ line}/\text{line} + C_c \text{ line}/\text{screen}$ , if the screen is connected to one line<br>Length of cable (not including cable stubs): $\leq 200 \text{ m}$ (656.2 ft)<br>Length of cable stubs: $\leq 1 \text{ m}$ (3.3 ft) |
| Option RC                        | PROFINET over Ethernet-APL, Ex-i,<br>10Mbit/s   |   |
| Option TA                        | FOUNDATION Fieldbus Ex i<br>(STANDARD + FISCO)  | <b>Ex ic</b><br><b>AEx ic, Ex ic, NIFW</b><br>$U_i = 32 \text{ V}$<br>$I_i = 570 \text{ mA}$<br>$P_i = 8.5 \text{ W}$<br>$L_i = 10 \mu\text{H}$<br>$C_i = 5 \text{ nF}$   |

1) For further options see Ethernet-APL Installation Drawing HE\_01622.

| Order code for "Output; input 2"<br>"Output; input 3" | Output type                                   | Intrinsically safe values or NIFW values   |                 |
|---|---|--|-----------------|
|   |   | Output; input 2  | Output; input 3 |
| Option C  | Current output<br>4-20mA Ex-i passive         | <b>Ex ia</b><br><b>Ex ic</b><br><b>AEx ic, Ex ic, NIFW</b><br>$U_i = 30 \text{ V}$<br>$I_i = 100 \text{ mA}$<br>$P_i = 1.25 \text{ W}$<br>$L_i = 0$<br>$C_i = 0$ |                 |
| Option G  | Pulse/frequency/switch output Ex-i<br>passive | <b>Ex ia</b><br><b>Ex ic</b><br><b>AEx ic, Ex ic, NIFW</b><br>$U_i = 30 \text{ V}$<br>$I_i = 100 \text{ mA}$<br>$P_i = 1.25 \text{ W}$<br>$L_i = 0$<br>$C_i = 0$ |                 |

**Low flow cut off** The switch points for low flow cut off are user-selectable.

**Galvanic isolation** The outputs are galvanically isolated:

- from the power supply
- from one another
- from the protective ground connection (PE)

Protocol-specific data

HART



|                                    |  |
|------------------------------------|--|
| Manufacturer ID                    | 0x11   |
| Device type ID                     | 0x3B   |
| HART protocol revision             | 7  |
| Device description files (DTM, DD) | Information and files under:<br><a href="http://www.endress.com">www.endress.com</a>   |
| HART load                          | Min. 250 Ω   |
| System integration                 | Information on system integration: Operating Instructions → 115.<br><ul style="list-style-type: none"> <li>▪ Measured variables via HART protocol</li> <li>▪ Burst Mode functionality</li> </ul> |

FOUNDATION Fieldbus

|   |   |
|---|---|
| Manufacturer ID                                   | 0x452B48 (hex)  |
| Ident number                                      | 0x103B (hex)  |
| Device revision                                   | 1   |
| DD revision                                       | Information and files under:  |
| CFF revision                                      | <ul style="list-style-type: none"> <li>▪ <a href="http://www.endress.com">www.endress.com</a></li> <li>▪ <a href="http://www.fieldcommgroup.org">www.fieldcommgroup.org</a></li> </ul>  |
| Interoperability Test Kit (ITK)                   | Version 6.2.0   |
| ITK Test Campaign Number                          | Information: <ul style="list-style-type: none"> <li>▪ <a href="http://www.endress.com">www.endress.com</a></li> <li>▪ <a href="http://www.fieldcommgroup.org">www.fieldcommgroup.org</a></li> </ul>   |
| Link Master capability (LAS)                      | Yes   |
| Choice of "Link Master" and "Basic Device"        | Yes<br>Factory setting: Basic Device  |
| Node address                                      | Factory setting: 247 (0xF7)   |
| Supported functions                               | The following methods are supported: <ul style="list-style-type: none"> <li>▪ Restart</li> <li>▪ ENP Restart</li> <li>▪ Diagnostic</li> <li>▪ Set to OOS</li> <li>▪ Set to AUTO</li> <li>▪ Read trend data</li> <li>▪ Read event logbook</li> </ul> |
| <b>Virtual Communication Relationships (VCRs)</b> |   |
| Number of VCRs                                    | 44  |
| Number of link objects in VFD                     | 50  |
| Permanent entries                                 | 1   |
| Client VCRs                                       | 0   |
| Server VCRs                                       | 10  |
| Source VCRs                                       | 43  |
| Sink VCRs   | 0   |
| Subscriber VCRs                                   | 43  |
| Publisher VCRs                                    | 43  |
| <b>Device Link Capabilities</b>                   |   |
| Slot time   | 4   |
| Min. delay between PDU                            | 8   |



|                            |  |
|----------------------------|--|
| <b>Max. response delay</b> | 16   |
| <b>System integration</b>  | Information regarding system integration: Operating Instructions →  115. <ul style="list-style-type: none"> <li>▪ Cyclic data transmission</li> <li>▪ Description of the modules</li> <li>▪ Execution times</li> <li>▪ Methods</li> </ul> |

### PROFIBUS DP

|  |  |
|--|--|
| <b>Manufacturer ID</b>                         | 0x11   |
| <b>Ident number</b>                            | 0x156F   |
| <b>Profile version</b>                         | 3.02   |
| <b>Device description files (GSD, DTM, DD)</b> | Information and files under: <ul style="list-style-type: none"> <li>▪ <a href="https://www.endress.com/download">https://www.endress.com/download</a><br/>On the device product page: PRODUCTS → Product Finder → Links</li> <li>▪ <a href="https://www.profibus.com">https://www.profibus.com</a></li> </ul>  |
| <b>Supported functions</b>                     | <ul style="list-style-type: none"> <li>▪ Identification &amp; Maintenance<br/>Simplest device identification on the part of the control system and nameplate</li> <li>▪ PROFIBUS upload/download<br/>Reading and writing parameters is up to ten times faster with PROFIBUS upload/download</li> <li>▪ Condensed status<br/>Simplest and self-explanatory diagnostic information by categorizing diagnostic messages that occur</li> </ul>   |
| <b>Configuration of the device address</b>     | <ul style="list-style-type: none"> <li>▪ DIP switches on the I/O electronics module</li> <li>▪ Via operating tools (e.g. FieldCare)</li> </ul>   |
| <b>Compatibility with earlier model</b>        | <p>If the device is replaced, the measuring device Promass 300 supports the compatibility of the cyclic data with previous models. It is not necessary to adjust the engineering parameters of the PROFIBUS network with the Promass 300 GSD file.</p> <p>Previous model:<br/>Promass 83 PROFIBUS DP</p> <ul style="list-style-type: none"> <li>▪ ID No.: 1529 (hex)</li> <li>▪ Extended GSD file: EH3x1529.gsd</li> <li>▪ Standard GSD file: EH3_1529.gsd</li> </ul> <p> Description of the function scope of compatibility:<br/>Operating Instructions →  115.</p> |
| <b>System integration</b>                      | Information regarding system integration: Operating Instructions →  115. <ul style="list-style-type: none"> <li>▪ Cyclic data transmission</li> <li>▪ Block model</li> <li>▪ Description of the modules</li> </ul>  |





### PROFIBUS PA

|  |   |
|--|---|
| <b>Manufacturer ID</b>                         | 0x11  |
| <b>Ident number</b>                            | 0x156D  |
| <b>Profile version</b>                         | 3.02  |
| <b>Device description files (GSD, DTM, DD)</b> | Information and files under: <ul style="list-style-type: none"> <li>▪ <a href="https://www.endress.com/download">https://www.endress.com/download</a><br/>On the device product page: PRODUCTS → Product Finder → Links</li> <li>▪ <a href="https://www.profibus.com">https://www.profibus.com</a></li> </ul> |

|  |   |
|--|---|
| <b>Supported functions</b>                 | <ul style="list-style-type: none"> <li>▪ Identification &amp; Maintenance<br/>Simplest device identification on the part of the control system and nameplate</li> <li>▪ PROFIBUS upload/download<br/>Reading and writing parameters is up to ten times faster with PROFIBUS upload/download</li> <li>▪ Condensed status<br/>Simplest and self-explanatory diagnostic information by categorizing diagnostic messages that occur</li> </ul>  |
| <b>Configuration of the device address</b> | <ul style="list-style-type: none"> <li>▪ DIP switches on the I/O electronics module</li> <li>▪ Local display</li> <li>▪ Via operating tools (e.g. FieldCare)</li> </ul>   |
| <b>Compatibility with earlier model</b>    | <p>If the device is replaced, the measuring device Promass 300 supports the compatibility of the cyclic data with previous models. It is not necessary to adjust the engineering parameters of the PROFIBUS network with the Promass 300 GSD file.</p> <p>Earlier models:</p> <ul style="list-style-type: none"> <li>▪ Promass 80 PROFIBUS PA <ul style="list-style-type: none"> <li>▪ ID No.: 1528 (hex)</li> <li>▪ Extended GSD file: EH3x1528.gsd</li> <li>▪ Standard GSD file: EH3_1528.gsd</li> </ul> </li> <li>▪ Promass 83 PROFIBUS PA <ul style="list-style-type: none"> <li>▪ ID No.: 152A (hex)</li> <li>▪ Extended GSD file: EH3x152A.gsd</li> <li>▪ Standard GSD file: EH3_152A.gsd</li> </ul> </li> </ul> <p> Description of the function scope of compatibility:<br/>Operating Instructions →  115.</p> |
| <b>System integration</b>                  | <p>Information regarding system integration: Operating Instructions →  115.</p> <ul style="list-style-type: none"> <li>▪ Cyclic data transmission</li> <li>▪ Block model</li> <li>▪ Description of the modules</li> </ul>  |

**Modbus RS485**

|                                |  |
|--------------------------------|--|
| <b>Protocol</b>                | Modbus Applications Protocol Specification V1.1  |
| <b>Response times</b>          | <ul style="list-style-type: none"> <li>▪ Direct data access: typically 25 to 50 ms</li> <li>▪ Auto-scan buffer (data range): typically 3 to 5 ms</li> </ul>  |
| <b>Device type</b>             | Slave  |
| <b>Slave address range</b>     | 1 to 247   |
| <b>Broadcast address range</b> | 0  |
| <b>Function codes</b>          | <ul style="list-style-type: none"> <li>▪ 03: Read holding register</li> <li>▪ 04: Read input register</li> <li>▪ 06: Write single registers</li> <li>▪ 08: Diagnostics</li> <li>▪ 16: Write multiple registers</li> <li>▪ 23: Read/write multiple registers</li> </ul> |
| <b>Broadcast messages</b>      | <p>Supported by the following function codes:</p> <ul style="list-style-type: none"> <li>▪ 06: Write single registers</li> <li>▪ 16: Write multiple registers</li> <li>▪ 23: Read/write multiple registers</li> </ul>  |
| <b>Supported baud rate</b>     | <ul style="list-style-type: none"> <li>▪ 1 200 BAUD</li> <li>▪ 2 400 BAUD</li> <li>▪ 4 800 BAUD</li> <li>▪ 9 600 BAUD</li> <li>▪ 19 200 BAUD</li> <li>▪ 38 400 BAUD</li> <li>▪ 57 600 BAUD</li> <li>▪ 115 200 BAUD</li> </ul>  |
| <b>Data transmission mode</b>  | <ul style="list-style-type: none"> <li>▪ ASCII</li> <li>▪ RTU</li> </ul>   |

|   |  |
|---|--|
| <b>Data access</b>                      | Each device parameter can be accessed via Modbus RS485.<br> For Modbus register information   |
| <b>Compatibility with earlier model</b> | If the device is replaced, the measuring instrument Promass 300 supports the compatibility of the Modbus registers for the process variables and the diagnostic information with the previous model Promass 83. It is not necessary to change the engineering parameters in the automation system.<br> Description of the function scope of compatibility:<br>Operating Instructions →  115. |
| <b>System integration</b>               | Information regarding system integration: Operating Instructions →  115. <ul style="list-style-type: none"> <li>▪ Modbus RS485 information</li> <li>▪ Function codes</li> <li>▪ Register information</li> <li>▪ Response time</li> <li>▪ Modbus data map</li> </ul>   |

### Modbus TCP over Ethernet-APL

| Port 1: Modbus TCP over Ethernet-APL 10 Mbit/s, SPE 10 Mbit/s |   |
|---|---|
| <b>Protocol</b>   | <ul style="list-style-type: none"> <li>▪ Modbus application protocol V1.1</li> <li>▪ TCP</li> </ul>   |
| <b>Response times</b>   | On Modbus client request: Typically 3 to 5 ms   |
| <b>TCP port</b>   | 502   |
| <b>Modbus TCP connections</b>                                 | Maximum 4   |
| <b>Communication type</b>                                     | Ethernet Advanced Physical Layer 10BASE-T1L   |
| <b>Data transfer</b>  | Full-duplex   |
| <b>Polarity</b>   | Automatic correction of crossed "APL signal +" and "APL signal -" signal lines  |
| <b>Device type</b>  | Address   |
| <b>Device type ID</b>   | 0xC43B  |
| <b>Function codes</b>   | <ul style="list-style-type: none"> <li>▪ 03: Read holding register</li> <li>▪ 04: Read input register</li> <li>▪ 06: Write single registers</li> <li>▪ 16: Write multiple registers</li> <li>▪ 23: Read/write multiple registers</li> <li>▪ 43: Read device identification</li> </ul> |
| <b>Broadcast support for function codes</b>                   | <ul style="list-style-type: none"> <li>▪ 06: Write single registers</li> <li>▪ 16: Write multiple registers</li> <li>▪ 23: Read/write multiple registers</li> <li>▪ 43: Read device identification</li> </ul>   |
| <b>Supported transfer speed</b>                               | 10 Mbit/s (Ethernet-APL)  |
| <b>Supported features</b>                                     | Address can be configured using DHCP, web server or software  |
| <b>Device description files (FDI)</b>                         | Information and files available at:<br><a href="http://www.endress.com">www.endress.com</a> → Downloads area  |
| <b>Configuration options for measuring instrument</b>         | <ul style="list-style-type: none"> <li>▪ Asset management software (FieldCare, DeviceCare, Field Expert)</li> <li>▪ Integrated web server via web browser and IP address</li> <li>▪ Onsite operation</li> </ul>   |

|                            |  |
|----------------------------|--|
| <b>Supported functions</b> | <ul style="list-style-type: none"> <li>▪ Device identification using:                             <ul style="list-style-type: none"> <li>Nameplate</li> </ul> </li> <li>▪ Measured value status                             <ul style="list-style-type: none"> <li>The process variables are communicated with a measured value status</li> </ul> </li> <li>▪ Blinking feature via the local display for simple device identification and assignment</li> <li>▪ Device operation via asset management software (e.g. FieldCare, DeviceCare)</li> </ul> |
| <b>System integration</b>  | <p>Information regarding system integration: Operating Instructions →  115.</p> <ul style="list-style-type: none"> <li>▪ Overview and description of the supported function codes</li> <li>▪ Status coding</li> <li>▪ Factory setting</li> </ul>  |

| <b>Port 2: Modbus TCP over Ethernet 100 Mbit/s</b>    |  |
|---|--|
| <b>Protocol</b>                                       | <ul style="list-style-type: none"> <li>▪ Modbus application protocol V1.1</li> <li>▪ TCP</li> </ul>  |
| <b>Response times</b>                                 | On Modbus client request: Typically 3 to 5 ms  |
| <b>TCP port</b>                                       | 502  |
| <b>Modbus TCP connections</b>                         | Maximum 4  |
| <b>Communication type</b>                             | <ul style="list-style-type: none"> <li>▪ 10BASE-T</li> <li>▪ 100BASE-TX</li> </ul>   |
| <b>Data transfer</b>                                  | Half-duplex, full-duplex   |
| <b>Polarity</b>                                       | Auto-MDIX  |
| <b>Device type</b>                                    | Address  |
| <b>Device type ID</b>                                 | 0xC43B   |
| <b>Function codes</b>                                 | <ul style="list-style-type: none"> <li>▪ 03: Read holding register</li> <li>▪ 04: Read input register</li> <li>▪ 06: Write single registers</li> <li>▪ 16: Write multiple registers</li> <li>▪ 23: Read/write multiple registers</li> <li>▪ 43: Read device identification</li> </ul>  |
| <b>Broadcast support for function codes</b>           | <ul style="list-style-type: none"> <li>▪ 06: Write single registers</li> <li>▪ 16: Write multiple registers</li> <li>▪ 23: Read/write multiple registers</li> <li>▪ 43: Read device identification</li> </ul>  |
| <b>Supported transfer speed</b>                       | <ul style="list-style-type: none"> <li>▪ 10 Mbit/s</li> <li>▪ 100 Mbit/s (Fast-Ethernet)</li> </ul>  |
| <b>Supported features</b>                             | Address can be configured using DHCP, web server or software   |
| <b>Device description files (FDI)</b>                 | Information and files available at:<br><a href="http://www.endress.com">www.endress.com</a> → Downloads area   |
| <b>Configuration options for measuring instrument</b> | <ul style="list-style-type: none"> <li>▪ Asset management software (FieldCare, DeviceCare, Field Expert)</li> <li>▪ Integrated web server via web browser and IP address</li> <li>▪ Onsite operation</li> </ul>  |
| <b>Supported functions</b>                            | <ul style="list-style-type: none"> <li>▪ Device identification using:                             <ul style="list-style-type: none"> <li>Nameplate</li> </ul> </li> <li>▪ Measured value status                             <ul style="list-style-type: none"> <li>The process variables are communicated with a measured value status</li> </ul> </li> <li>▪ Device operation via asset management software (e.g. FieldCare, DeviceCare)</li> </ul> |
| <b>System integration</b>                             | <p>Information regarding system integration: Operating Instructions →  115.</p> <ul style="list-style-type: none"> <li>▪ Overview and description of the supported function codes</li> <li>▪ Status coding</li> <li>▪ Factory setting</li> </ul>  |

## EtherNet/IP

|   |  |
|---|--|
| <b>Protocol</b>                                   | <ul style="list-style-type: none"> <li>▪ The CIP Networks Library Volume 1: Common Industrial Protocol</li> <li>▪ The CIP Networks Library Volume 2: EtherNet/IP Adaptation of CIP</li> </ul>  |
| <b>Communication type</b>                         | <ul style="list-style-type: none"> <li>▪ 10Base-T</li> <li>▪ 100Base-TX</li> </ul>   |
| <b>Device profile</b>                             | Generic device (product type: 0x2B)  |
| <b>Manufacturer ID</b>                            | 0x000049E  |
| <b>Device type ID</b>                             | 0x103B   |
| <b>Baud rates</b>                                 | Automatic <sup>19</sup> / <sub>100</sub> Mbit with half-duplex and full-duplex detection   |
| <b>Polarity</b>                                   | Auto-polarity for automatic correction of crossed TxD and RxD pairs  |
| <b>Supported CIP connections</b>                  | Max. 3 connections   |
| <b>Explicit connections</b>                       | Max. 6 connections   |
| <b>I/O connections</b>                            | Max. 6 connections (scanner)   |
| <b>Configuration options for measuring device</b> | <ul style="list-style-type: none"> <li>▪ DIP switches on the electronics module for IP addressing</li> <li>▪ Manufacturer-specific software (FieldCare)</li> <li>▪ Add-on Profile Level 3 for Rockwell Automation control systems</li> <li>▪ Web browser</li> <li>▪ Electronic Data Sheet (EDS) integrated in the measuring device</li> </ul>                    |
| <b>Configuration of the EtherNet interface</b>    | <ul style="list-style-type: none"> <li>▪ Speed: 10 MBit, 100 MBit, auto (factory setting)</li> <li>▪ Duplex: half-duplex, full-duplex, auto (factory setting)</li> </ul>   |
| <b>Configuration of the device address</b>        | <ul style="list-style-type: none"> <li>▪ DIP switches on the electronics module for IP addressing (last octet)</li> <li>▪ DHCP</li> <li>▪ Manufacturer-specific software (FieldCare)</li> <li>▪ Add-on Profile Level 3 for Rockwell Automation control systems</li> <li>▪ Web browser</li> <li>▪ EtherNet/IP tools, e.g. RSLinx (Rockwell Automation)</li> </ul> |
| <b>Device Level Ring (DLR)</b>                    | Yes  |
| <b>System integration</b>                         | <p>Information regarding system integration: Operating Instructions<br/>→  115.</p> <ul style="list-style-type: none"> <li>▪ Cyclic data transmission</li> <li>▪ Block model</li> <li>▪ Input and output groups</li> </ul>  |

## PROFINET

|  |   |
|--|---|
| <b>Protocol</b>                        | Application layer protocol for decentral device periphery and distributed automation, Version 2.3 |
| <b>Communication type</b>              | 100 Mbit/s  |
| <b>Conformity class</b>                | Conformance class B   |
| <b>Netload Class</b>                   | Netload Class 2 100 Mbit/s  |
| <b>Baud rates</b>                      | Automatic 100 Mbit/s with full-duplex detection   |
| <b>Periods</b>                         | From 8 ms   |
| <b>Polarity</b>                        | Auto-polarity for automatic correction of crossed TxD and RxD pairs                               |
| <b>Media Redundancy Protocol (MRP)</b> | Yes   |
| <b>System redundancy support</b>       | System redundancy S2 (2 AR with 1 NAP)  |
| <b>Device profile</b>                  | Application interface identifier 0xF600<br>Generic device   |
| <b>Manufacturer ID</b>                 | 0x11  |
| <b>Device type ID</b>                  | 0x843B  |

|   |   |
|---|---|
| <b>Device description files (GSD, DTM, DD)</b>        | Information and files available at: <ul style="list-style-type: none"> <li>▪ <a href="http://www.endress.com">www.endress.com</a></li> <li>▪ On the product page for the device: Documents/Software → Device drivers</li> <li>▪ <a href="http://www.profibus.com">www.profibus.com</a></li> </ul>   |
| <b>Supported connections</b>                          | <ul style="list-style-type: none"> <li>▪ 2 x AR (IO Controller AR)</li> <li>▪ 1 x AR (IO-Supervisor Device AR connection allowed)</li> <li>▪ 1 x Input CR (Communication Relation)</li> <li>▪ 1 x Output CR (Communication Relation)</li> <li>▪ 1 x Alarm CR (Communication Relation)</li> </ul>  |
| <b>Configuration options for measuring instrument</b> | <ul style="list-style-type: none"> <li>▪ DIP switches on the electronics module, for device name assignment (last part)</li> <li>▪ Asset management software (FieldCare, DeviceCare, Field Xpert)</li> <li>▪ Integrated web server via web browser and IP address</li> <li>▪ Device master file (GSD), can be read out via the integrated web server of the measuring instrument.</li> <li>▪ Onsite operation</li> </ul>  |
| <b>Configuration of the device name</b>               | <ul style="list-style-type: none"> <li>▪ DIP switches on the electronics module, for device name assignment (last part)</li> <li>▪ DCP protocol</li> <li>▪ Asset management software (FieldCare, DeviceCare, Field Xpert)</li> <li>▪ Integrated web server</li> </ul>   |
| <b>Supported functions</b>                            | <ul style="list-style-type: none"> <li>▪ Identification &amp; Maintenance, simple device identifier via: <ul style="list-style-type: none"> <li>▪ Control system</li> <li>▪ Nameplate</li> </ul> </li> <li>▪ Measured value status<br/>The process variables are communicated with a measured value status</li> <li>▪ Blinking feature via the local display for simple device identification and assignment</li> <li>▪ Device operation via asset management software (e.g. FieldCare, DeviceCare, SIMATIC PDM)</li> </ul> |
| <b>System integration</b>                             | Information regarding system integration: Operating Instructions → 115. <ul style="list-style-type: none"> <li>▪ Cyclic data transmission</li> <li>▪ Overview and description of the modules</li> <li>▪ Status coding</li> <li>▪ Startup configuration</li> <li>▪ Factory setting</li> </ul>  |

**PROFINET over Ethernet-APL**

|   |   |
|---|---|
| <b>Protocol</b>                                 | Application layer protocol for decentral device periphery and distributed automation, Version 2.43  |
| <b>Communication type</b>                       | Ethernet Advanced Physical Layer 10BASE-T1L   |
| <b>Conformance Class</b>                        | Conformance Class B (PA)  |
| <b>Netload Class</b>                            | PROFINET Netload Robustness Class 2 10 Mbit/s   |
| <b>Data transfer</b>                            | 10 Mbit/s Full-duplex   |
| <b>Cycle times</b>                              | 64 ms   |
| <b>Polarity</b>                                 | Automatic correction of crossed "APL signal +" and "APL signal -" signal lines  |
| <b>Media Redundancy Protocol (MRP)</b>          | Not possible (point-to-point connection to APL field switch)  |
| <b>System redundancy support</b>                | System redundancy S2 (2 AR with 1 NAP)  |
| <b>Device profile</b>                           | PROFINET PA profile 4.02 (Application interface identifier API: 0x9700)   |
| <b>Manufacturer ID</b>                          | 17  |
| <b>Device type ID</b>                           | 0xA43B  |
| <b>Device description files (GSD, DTM, FDI)</b> | Information and files available at: <ul style="list-style-type: none"> <li>▪ <a href="http://www.endress.com">www.endress.com</a> → Downloads area</li> <li>▪ <a href="http://www.profibus.com">www.profibus.com</a></li> </ul> |

|   |  |
|---|--|
| <b>Supported connections</b>                          | <ul style="list-style-type: none"> <li>▪ 2x AR (IO Controller AR)</li> <li>▪ 2x AR (IO Supervisor Device AR connection allowed)</li> </ul>   |
| <b>Configuration options for measuring instrument</b> | <ul style="list-style-type: none"> <li>▪ DIP switches on the electronics module, for device name assignment (last part)</li> <li>▪ Asset management software (FieldCare, DeviceCare, Field Xpert)</li> <li>▪ Integrated Web server via Web browser and IP address</li> <li>▪ Device master file (GSD), can be read out via the integrated Web server of the measuring instrument.</li> <li>▪ Onsite operation</li> </ul>   |
| <b>Configuration of the device name</b>               | <ul style="list-style-type: none"> <li>▪ DIP switches on the electronics module, for device name assignment (last part)</li> <li>▪ DCP protocol</li> <li>▪ Asset management software (FieldCare, DeviceCare, Field Xpert)</li> <li>▪ Integrated web server</li> </ul>  |
| <b>Supported functions</b>                            | <ul style="list-style-type: none"> <li>▪ Identification &amp; Maintenance, simple device identifier via: <ul style="list-style-type: none"> <li>▪ Control system</li> <li>▪ Nameplate</li> </ul> </li> <li>▪ Measured value status<br/>The process variables are communicated with a measured value status</li> <li>▪ Blinking feature via the local display for simple device identification and assignment</li> <li>▪ Device operation via asset management software (e.g. FieldCare, DeviceCare, SIMATIC PDM with FDI package)</li> </ul> |
| <b>System integration</b>                             | <p>Information regarding system integration: Operating Instructions →  115.</p> <ul style="list-style-type: none"> <li>▪ Cyclic data transmission</li> <li>▪ Overview and description of the modules</li> <li>▪ Status coding</li> <li>▪ Factory setting</li> </ul>   |

## Power supply

### Terminal assignment

### Transmitter: supply voltage, input/outputs

#### HART

| Supply voltage   |       | Input/output 1 (Port 1) |        | Input/output 2 |        | Input/output 3 |        | Service interface (Port 2) |
|--|-------|-------------------------|--------|----------------|--------|----------------|--------|----------------------------|
| 1 (+)  | 2 (-) | 26 (+)                  | 27 (-) | 24 (+)         | 25 (-) | 22 (+)         | 23 (-) | CDI-RJ45                   |
| The terminal assignment depends on the specific device version ordered → 13. |       |                         |        |                |        |                |        |                            |

#### FOUNDATION fieldbus

| Supply voltage   |       | Input/output 1 (Port 1) |        | Input/output 2 |        | Input/output 3 |        | Service interface (Port 2) |
|--|-------|-------------------------|--------|----------------|--------|----------------|--------|----------------------------|
| 1 (+)  | 2 (-) | 26 (A)                  | 27 (B) | 24 (+)         | 25 (-) | 22 (+)         | 23 (-) | CDI-RJ45                   |
| The terminal assignment depends on the specific device version ordered → 13. |       |                         |        |                |        |                |        |                            |

#### PROFIBUS DP

| Supply voltage   |       | Input/output 1 (Port 1) |        | Input/output 2 |        | Input/output 3 |        | Service interface (Port 2) |
|--|-------|-------------------------|--------|----------------|--------|----------------|--------|----------------------------|
| 1 (+)  | 2 (-) | 26 (B)                  | 27 (A) | 24 (+)         | 25 (-) | 22 (+)         | 23 (-) | CDI-RJ45                   |
| The terminal assignment depends on the specific device version ordered → 13. |       |                         |        |                |        |                |        |                            |

#### PROFIBUS PA

| Supply voltage   |       | Input/output 1 (Port 1) |        | Input/output 2 |        | Input/output 3 |        | Service interface (Port 2) |
|--|-------|-------------------------|--------|----------------|--------|----------------|--------|----------------------------|
| 1 (+)  | 2 (-) | 26 (B)                  | 27 (A) | 24 (+)         | 25 (-) | 22 (+)         | 23 (-) | CDI-RJ45                   |
| The terminal assignment depends on the specific device version ordered → 13. |       |                         |        |                |        |                |        |                            |

#### Modbus RS485

| Supply voltage   |       | Input/output 1 (Port 1) |        | Input/output 2 |        | Input/output 3 |        | Service interface (Port 2) |
|--|-------|-------------------------|--------|----------------|--------|----------------|--------|----------------------------|
| 1 (+)  | 2 (-) | 26 (B)                  | 27 (A) | 24 (+)         | 25 (-) | 22 (+)         | 23 (-) | CDI-RJ45                   |
| The terminal assignment depends on the specific device version ordered → 13. |       |                         |        |                |        |                |        |                            |

#### Modbus TCP

| Supply voltage   |       | Input/output 1 (Port 1) <sup>1)</sup> |        | Input/output 2 |        | Input/output 3 |        | Service interface (Port 2) <sup>1)</sup> |
|--|-------|---------------------------------------|--------|----------------|--------|----------------|--------|--|
| 1 (+)  | 2 (-) | 26 (+)                                | 27 (-) | 24 (+)         | 25 (-) | 22 (+)         | 23 (-) | CDI-RJ45                                 |
| The terminal assignment depends on the specific device version ordered → 13. |       |                                       |        |                |        |                |        |  |

1) For Modbus TCP communication, either port 1 OR port 2 can be used.

PROFINET

| Supply voltage   |       | Input/output 1 (Port 1) <sup>1)</sup> | Input/output 2 |        | Input/output 3 |        | Service interface (Port 2) <sup>1)</sup> |
|--|-------|---------------------------------------|----------------|--------|----------------|--------|--|
| 1 (+)  | 2 (-) | RJ45                                  | 24 (+)         | 25 (-) | 22 (+)         | 23 (-) | CDI-RJ45                                 |
| The terminal assignment depends on the specific device version ordered → 13. |       |                                       |                |        |                |        |  |

1) Port can be used for communication or as a service interface (CDI-RJ45).

PROFINET over Ethernet-APL

| Supply voltage   |       | Input/output 1 (Port 1) |        | Input/output 2 |        | Input/output 3 |        | Service interface (Port 2) <sup>1)</sup> |
|--|-------|-------------------------|--------|----------------|--------|----------------|--------|--|
| 1 (+)  | 2 (-) | 26 (+)                  | 27 (-) | 24 (+)         | 25 (-) | 22 (+)         | 23 (-) | CDI-RJ45                                 |
| The terminal assignment depends on the specific device version ordered → 13. |       |                         |        |                |        |                |        |  |

1) No PROFINET communication available on port 2

Ethernet/IP

| Supply voltage   |       | Input/output 1 (Port 1) <sup>1)</sup> | Input/output 2 |        | Input/output 3 |        | Service interface (Port 2) <sup>1)</sup> |
|--|-------|---------------------------------------|----------------|--------|----------------|--------|--|
| 1 (+)  | 2 (-) | RJ45                                  | 24 (+)         | 25 (-) | 22 (+)         | 23 (-) | CDI-RJ45                                 |
| The terminal assignment depends on the specific device version ordered → 13. |       |                                       |                |        |                |        |  |

1) Port can be used for communication or as a service interface (CDI-RJ45).



Terminal assignment of the remote display and operating module → 41.

For information on the pin assignment of the device plugs, see the Operating Instructions for the device.

Available device plugs



Device plugs may not be used in hazardous areas!

Device plugs for Proline 300:

Order code for "Input; output 1"

- Option SA "FOUNDATION Fieldbus" → 38
- Option GA "PROFIBUS PA" → 39
- Option NA "EtherNet/IP" → 39
- Option RA "PROFINET" → 39
- Option RB "PROFINET over Ethernet-APL" → 39
- Option MB "Modbus TCP" → 39

Device plug for connecting to the service interface:

Order code for "Accessory mounted"

Option NB, RJ45 M12 adapter (service interface) → 49

Order code for "Input; output 1", option SA "FOUNDATION fieldbus"

| Order code for "Electrical connection" | Cable entry/connection → 41 |   |
|--|-----------------------------|---|
|  | 2                           | 3 |
| M, 3, 4, 5                             | 7/8" plug                   | - |

**Order code for "Input; output 1", option GA "PROFIBUS PA"**

| Order code for<br>"Electrical connection" | Cable entry/connection → 41 |   |
|---|-----------------------------|---|
|   | 2                           | 3 |
| L, N, P, U                                | Connector M12×1             | - |

**Order code for "Input; output 1", option NA "EtherNet/IP"**

| Order code for<br>"Electrical connection"                                       | Cable entry/connection → 41 |                 |
|---|-----------------------------|-----------------|
|   | 2                           | 3               |
| L, N, P, U  | Connector M12×1             | -               |
| R <sup>1) 2)</sup> S <sup>1) 2)</sup> , T <sup>1) 2)</sup> , V <sup>1) 2)</sup> | Connector M12×1             | Connector M12×1 |

- 1) Not compatible with an external WLAN antenna (order code for "Accessory enclosed", option P8), an RJ45 M12 adapter for the service interface (order code for "Accessory mounted", option NB)
- 2) Suitable for integrating the device into a ring topology.

**Order code for "Input; output 1", option RA "PROFINET"**

| Order code for<br>"Electrical connection"   | Cable entry/connection → 41 |                 |
|---|-----------------------------|-----------------|
|   | 2                           | 3               |
| L, N, P, U  | Connector M12×1             | -               |
| R <sup>1) 2)</sup> , S <sup>1) 2)</sup> , T <sup>1) 2)</sup> , V <sup>1) 2)</sup> | Connector M12×1             | Connector M12×1 |

- 1) Not compatible with an external WLAN antenna (order code for "Accessory enclosed", option P8), an RJ45 M12 adapter for the service interface (order code for "Accessory mounted", option NB)
- 2) Suitable for integrating the device into a ring topology.

**Order code for "Input; output 1", option RB "PROFINET over Ethernet-APL"**

| Order code for<br>"Electrical connection" | Cable entry/connection → 41 |   |
|---|-----------------------------|---|
|   | 2                           | 3 |
| L, N, P, U                                | Connector M12×1             | - |

**Order code for "Input; output 1", option MB "Modbus TCP over Ethernet-APL"**

| Order code for<br>"Electrical connection"                             | Accessories      | Cable entry/connection → 40 |  |
|---|------------------|-----------------------------|--|
|   |                  | 2                           | 3  |
| L, N, P, U  | -                | Connector M12×1<br>A-coded  | -  |
| L, N, P, U  | NB <sup>1)</sup> | Connector M12×1<br>A-coded  | Connector M12×1 <sup>1)</sup><br>D-coded |
| 1 <sup>2)</sup> , 2 <sup>2)</sup> , 7 <sup>2)</sup> , 8 <sup>2)</sup> | -                | -                           | Connector M12×1<br>D-coded               |

- 1) Cannot be used as a Modbus TCP port.
- 2) Not compatible with an external WLAN antenna (order code for "Accessory enclosed", option P8, an RJ45 M12 adapter for the service interface (order code for "Accessory mounted", option NB) or a remote operating and display module DKX001.

## Order code for "Accessory mounted", option NB: "Adapter RJ45 M12 (service interface)"

| Order code for<br>"Accessory mounted" | Cable entry/connection →  40 |                  |
|---------------------------------------|---|------------------|
|                                       | Cable entry<br>2  | Cable entry<br>3 |
| NB <sup>1)</sup>                      | -   | Connector M12×1  |

1) Not compatible with electrical connection option 1, 2, 7, 8

## Supply voltage

| Order code for<br>"Power supply" | Terminal voltage |            | Frequency range |
|----------------------------------|------------------|------------|-----------------|
| Option D                         | DC 24 V          | ±20%       | -               |
| Option E                         | AC 100 to 240 V  | -15 to 10% | 50/60 Hz        |
| Option I                         | DC 24 V          | ±20%       | -               |
|                                  | AC 100 to 240 V  | -15 to 10% | 50/60 Hz        |

## Power consumption

## Transmitter

Max. 10 W (active power)

|                   |   |
|-------------------|---|
| switch-on current | Max. 36 A (<5 ms) as per NAMUR Recommendation NE 21 |
|-------------------|---|

## Current consumption

## Transmitter

- Max. 400 mA (24 V)
- Max. 200 mA (110 V, 50/60 Hz; 230 V, 50/60 Hz)

## Power supply failure

- Totalizers stop at the last value measured.
- Depending on the device version, the configuration is retained in the device memory or in the plug-in memory (HistoROM DAT).
- Error messages (incl. total operated hours) are stored.





## Overcurrent protection element

The device must be operated with a dedicated circuit breaker, as it does not have an ON/OFF switch of its own.

- The circuit breaker must be easy to reach and labeled accordingly.
- Permitted nominal current of the circuit breaker: 2 A up to maximum 10 A.

## Electrical connection

## Transmitter connection

-  Terminal assignment →  37
-  Device plugs available →  38

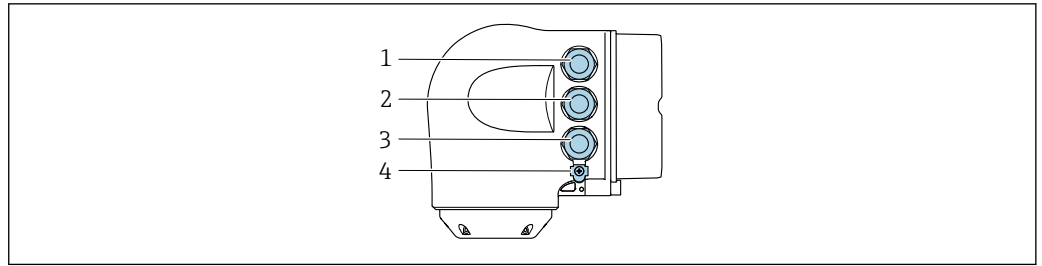

A0026781

- 1 Terminal connection for supply voltage
- 2 Terminal connection for signal transmission, input/output
- 3 Terminal connection for signal transmission, input/output or terminal for network connection via service interface (CDI-RJ45); Optional: terminal connection for external WLAN antenna or connection for remote display and operating module DKX001
- 4 Protective ground connection (PE)

**i** An adapter for the RJ45 to the M12 connector is optionally available:  
Order code for "Accessories", option **NB**: "Adapter RJ45 M12 (service interface)"

The adapter connects the service interface (CDI-RJ45) to an M12 connector mounted in the cable entry. The connection to the service interface can be established via an M12 connector without opening the device.

**i** Network connection via service interface (CDI-RJ45) → 101

#### Connecting in a ring topology

Device versions with EtherNet/IP and PROFINET communication protocols can be integrated into a ring topology. The device is integrated via the terminal connection for signal transmission (output 1) and the connection to the service interface (CDI-RJ45).

**i** Integrating the transmitter into a ring topology:

- EtherNet/IP
- PROFINET

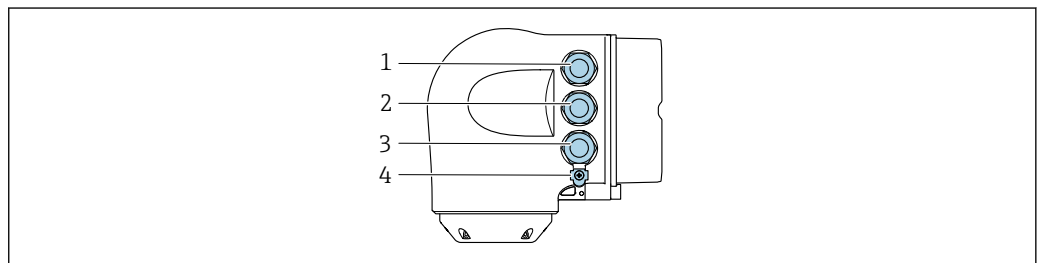

A0026781

- 1 Terminal connection for supply voltage
- 2 Terminal connection for signal transmission: PROFINET or EtherNet/IP (RJ45 plug)
- 3 Connection to service interface (CDI-RJ45)
- 4 Protective ground connection (PE)

**i** If the device has additional inputs/outputs, these are routed in parallel via the cable entry for connection to the service interface (CDI-RJ45).

#### Connecting the remote display and operating module DKX001

**i** The remote display and operating module DKX001 is available as an optional extra → 112..

- The remote display and operating module DKX001 is only available for the following housing version: order code for "Housing": option A "Aluminum, coated"
- The measuring instrument is always supplied with a dummy cover when the remote display and operating module DKX001 is ordered directly with the measuring instrument. Display or operation at the transmitter is not possible in this case.
- If ordered subsequently, the remote display and operating module DKX001 may not be connected at the same time as the existing measuring instrument display module. Only one display or operation unit may be connected to the transmitter at any one time.

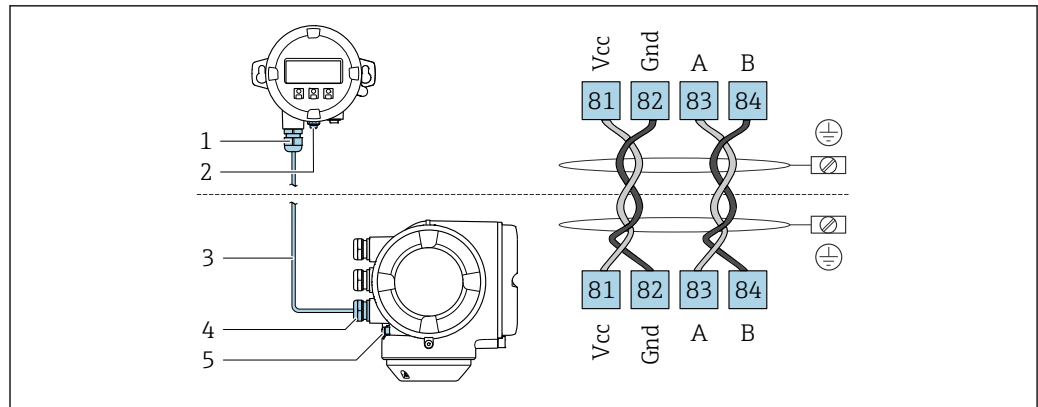

A0027518

- 1 Remote display and operating module DKX001
- 2 Protective ground connection (PE)
- 3 Connecting cable
- 4 Measuring instrument
- 5 Protective ground connection (PE)

### Connection examples

Current output 4 to 20 mA (without HART)

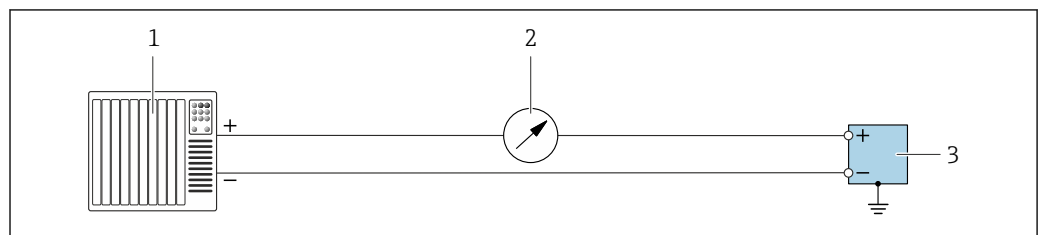

A0055851

2 Connection example for 4 to 20 mA current output (active)

- 1 Automation system with current input (e.g. PLC)
- 2 Optional additional display unit: Observe maximum load
- 3 Flowmeter with current output (active)

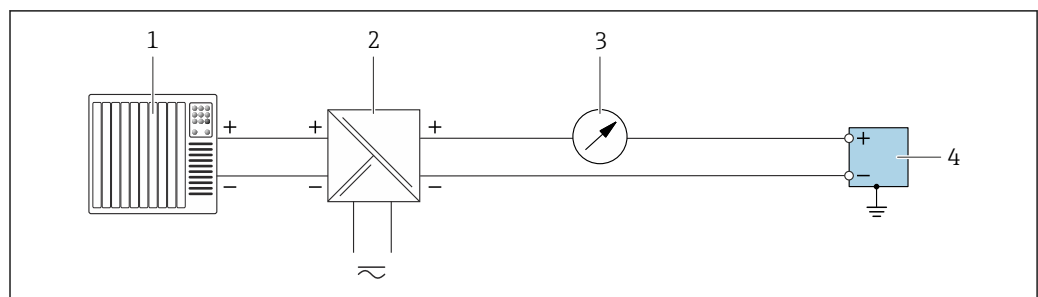

A0055852

3 Connection example for 4 to 20 mA current output (passive)

- 1 Automation system with current input (e.g. PLC)
- 2 Power supply
- 3 Optional additional display unit: Observe maximum load
- 4 Transmitter with current output (passive)

Current input 4 to 20 mA

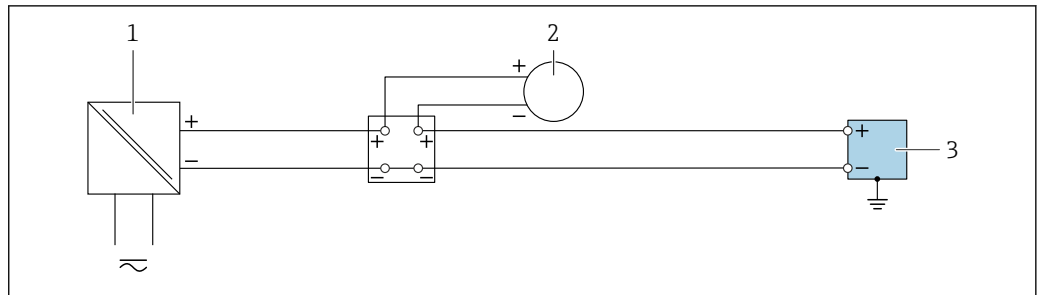

A0055853

4 Connection example for 4 to 20 mA current input

- 1 Power supply
- 2 External measuring instrument with 4 to 20 mA passive current output, e.g. pressure or temperature)
- 3 Transmitter with 4 to 20 mA current input

Pulse output/frequency output/switch output

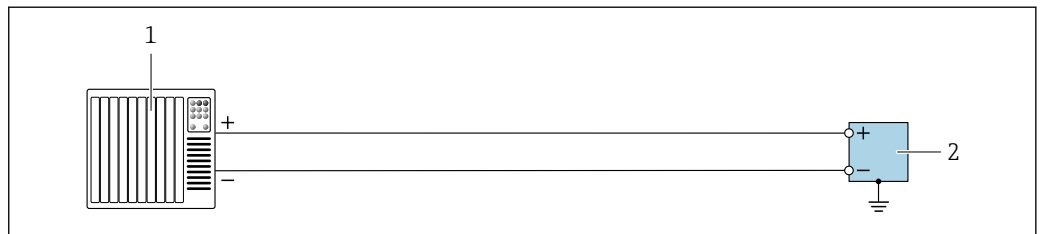

A0055856

5 Connection example for pulse output/frequency output/switch output (active)

- 1 Automation system with pulse input/frequency input/switch input (e.g. PLC)
- 2 Transmitter with pulse output/frequency output/switch output (active)

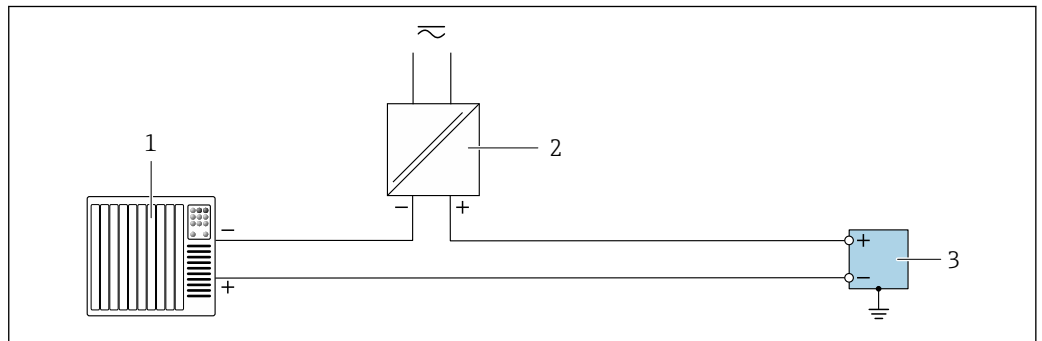

A0055855

6 Connection example for pulse output/frequency output/switch output (passive)

- 1 Automation system with pulse input/frequency input/switch input (e.g. PLC)
- 2 Power supply
- 3 Transmitter with pulse output/frequency output/switch output (passive)

## Relay output

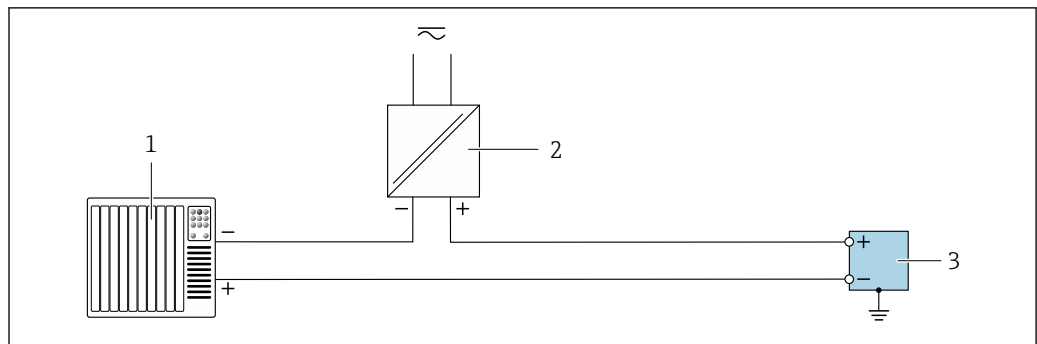

A0055859

 7 Connection example for relay output

- 1 Automation system with switch input (e.g. PLC)
- 2 Power supply
- 3 Transmitter with relay output

## Status input

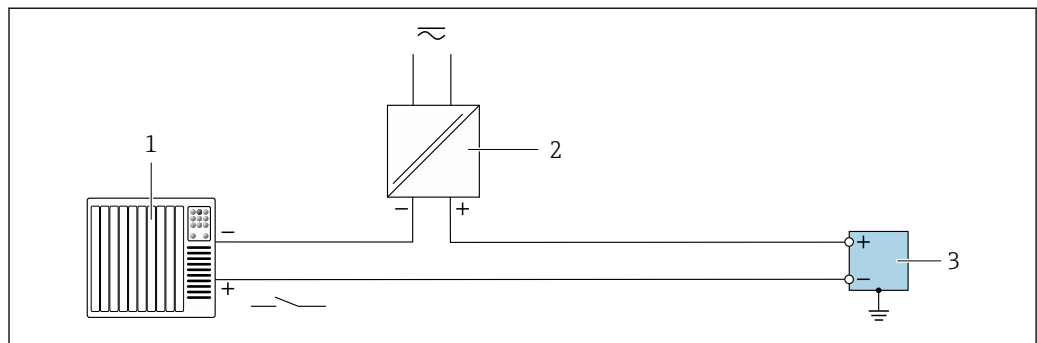

A0055860

 8 Connection example for status input

- 1 Automation system with switch output passive e.g. PLC)
- 2 Power supply
- 3 Transmitter with status input

## Current output 4 to 20 mA HART

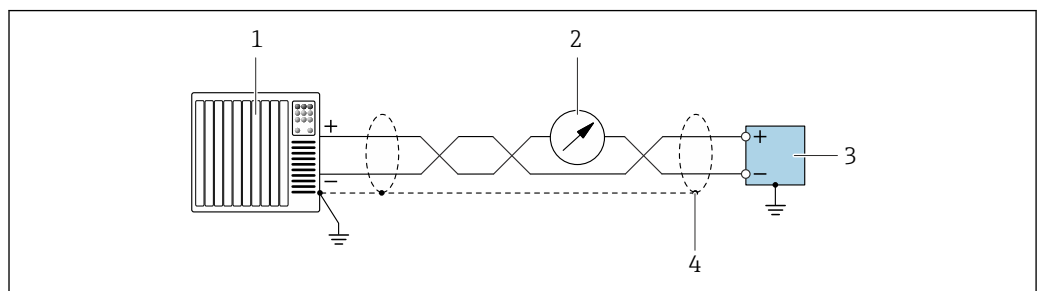

A0055862

 9 Connection example for 4 to 20 mA current output with HART (active)

- 1 Automation system with 4 to 20 mA current input with HART (e.g. PLC)
- 2 Optional display unit: Note maximum load
- 3 Transmitter with 4 to 20 mA current output with HART (active)
- 4 Ground cable shield at one end. For installations in compliance with NAMUR NE 89, grounding of the cable shield on both sides is required.

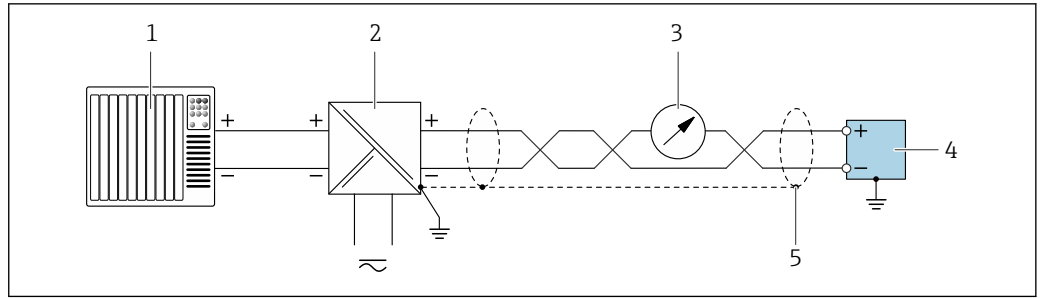

A0055861

10 Connection example for 4 to 20 mA current output with HART (passive)

- 1 Automation system with 4 to 20 mA current input with HART (e.g. PLC)
- 2 Power supply
- 3 Optional display unit: Note maximum load
- 4 Transmitter with 4 to 20 mA current output with HART (passive)
- 5 Ground cable shield at one end. For installations in compliance with NAMUR NE 89, grounding of the cable shield on both sides is required.

Modbus RS485

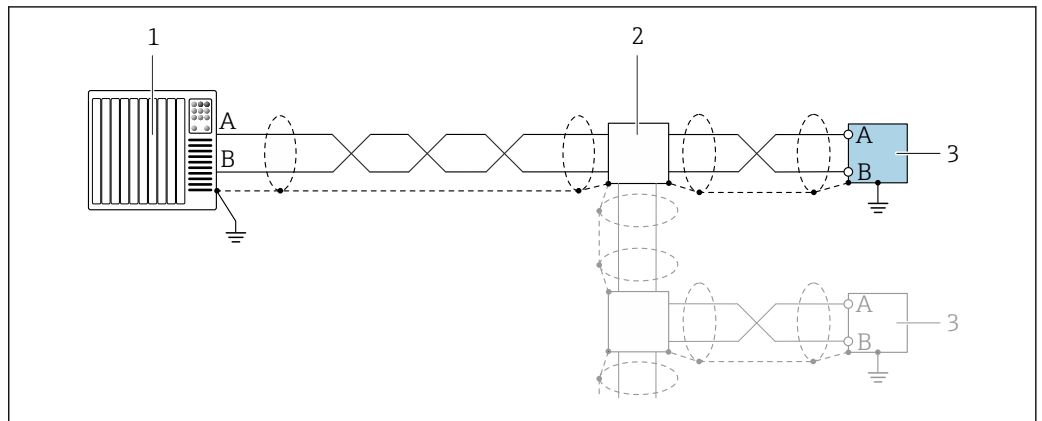

A0055863

11 Connection example for Modbus RS485

- 1 Automation system with Modbus master (e.g. PLC)
- 2 Optional distribution box
- 3 Transmitter with Modbus RS485

PROFIBUS PA

See <https://www.profibus.com> "PROFIBUS Installation Guidelines".

PROFIBUS DP

See <https://www.profibus.com> "PROFIBUS Installation Guidelines".

## FOUNDATION Fieldbus

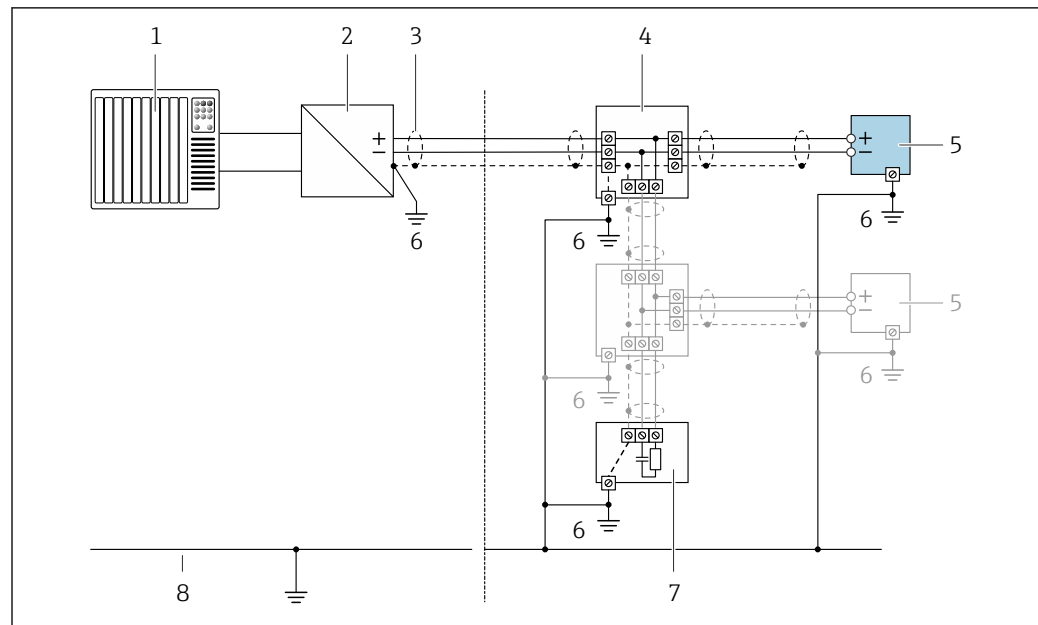

A0028768

12 Connection example for FOUNDATION Fieldbus

- 1 Automation system (e.g. PLC)
- 2 Power Conditioner (FOUNDATION Fieldbus)
- 3 Cable shield provided at one end. The cable shield must be grounded at both ends to comply with EMC requirements; observe cable specifications
- 4 T-box
- 5 Measuring instrument
- 6 Local grounding
- 7 Bus terminator
- 8 Potential equalization conductor

## PROFINET

See <https://www.profibus.com> "PROFINET Planning guideline".

## EtherNet/IP

See <https://www.odva.org> "EtherNet/IP Media Planning & Installation Manual".

## Ethernet-APL

See <https://www.profibus.com> Ethernet-APL White Paper "

## Potential equalization

## Requirements

For potential equalization:

- Pay attention to in-house grounding concepts
- Take account of operating conditions like the pipe material and grounding
- Connect the medium, sensor and transmitter to the same electric potential
- Use a ground cable with a minimum cross-section of 6 mm<sup>2</sup> (10 AWG) and a cable lug for potential equalization connections

## Terminals

Spring-loaded terminals: Suitable for strands and strands with ferrules.  
Conductor cross-section 0.2 to 2.5 mm<sup>2</sup> (24 to 12 AWG).

**Cable entries**

- Cable gland: M20 × 1.5 with cable Ø 6 to 12 mm (0.24 to 0.47 in)
- Thread for cable entry:
  - NPT ½"
  - G ½"
  - M20
- Device plug for digital communication: M12  
Only available for certain device versions → 38.

**Pin assignment, device plug**

**FOUNDATION Fieldbus**

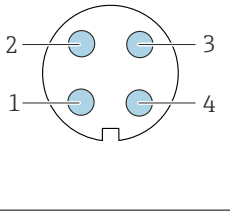
|  | Pin                | Assignment |                           | Coding | Plug/socket |
|---|--------------------|------------|---------------------------|--------|-------------|
|   | 1                  | +          | Signal +                  | A      | Plug        |
|   | 2                  | -          | Signal -                  |        |             |
|   | 3                  |            | Cable shield <sup>1</sup> |        |             |
|   | 4                  |            | Not used                  |        |             |
|   | Metal plug housing |            | Cable shield              |        |             |
| <sup>1</sup> If a cable shield is used  |                    |            |                           |        |             |

**PROFIBUS PA**

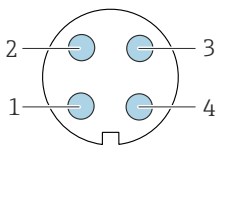
|  | Pin                 | Assignment |               | Coding | Plug/socket |
|--|---------------------|------------|---------------|--------|-------------|
|  | 1                   | +          | PROFIBUS PA + | A      | Plug        |
|  | 2                   |            | Grounding     |        |             |
|  | 3                   | -          | PROFIBUS PA - |        |             |
|  | 4                   |            | Not used      |        |             |
|  | Met al plug housing |            | Cable shield  |        |             |



Recommended plug:

- Binder, series 713, part no. 99 1430 814 04
- Phoenix, part no. 1413934 SACC-FS-4QO SH PBPA SCO

**PROFINET**

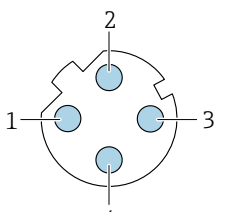
|  | Pin                | Assignment |              | Coding | Plug/socket |
|---|--------------------|------------|--------------|--------|-------------|
|   | 1                  | +          | TD +         | D      | Socket      |
|   | 2                  | +          | RD +         |        |             |
|   | 3                  | -          | TD -         |        |             |
|   | 4                  | -          | RD -         |        |             |
|   | Metal plug housing |            | Cable shield |        |             |



Recommended plug:

- Binder, series 825, part no. 99 3729 810 04
- Phoenix, part no. 1543223 SACC-M12MSD-4Q

**PROFINET over Ethernet-APL**

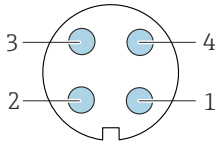
|  | Pin          | Assignment                | Coding | Plug/socket |
|---|--------------|---------------------------|--------|-------------|
|   | 1            | Ethernet-APL signal -     | A      | Socket      |
|   | 2            | Ethernet-APL signal +     |        |             |
|   | 3            | Cable shield <sup>1</sup> |        |             |
|   | 4            | Not used                  |        |             |
| Metal plug housing  | Cable shield |                           |        |             |
| <sup>1</sup> If a cable shield is used  |              |                           |        |             |

- i** Recommended plug:
- Binder, series 713, part no. 99 1430 814 04
  - Phoenix, part no. 1413934 SACC-FS-4QO SH PBPA SCO

**Modbus TCP over Ethernet-APL 10 Mbit/s**

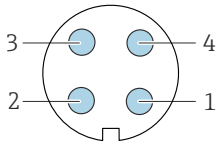
|  | Pin          | Assignment                | Coding | Plug/socket |
|---|--------------|---------------------------|--------|-------------|
|   | 1            | Ethernet-APL signal -     | A      | Socket      |
|   | 2            | Ethernet-APL signal +     |        |             |
|   | 3            | Cable shield <sup>1</sup> |        |             |
|   | 4            | Not used                  |        |             |
| Metal plug housing  | Cable shield |                           |        |             |
| <sup>1</sup> If a cable shield is used  |              |                           |        |             |

- i** Recommended plug:
- Binder, series 713, part no. 99 1430 814 04
  - Phoenix, part no. 1413934 SACC-FS-4QO SH PBPA SCO

**Modbus TCP over Ethernet 100 Mbit/s**

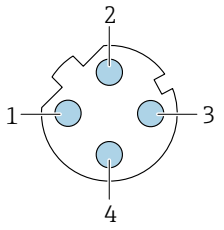
|  | Pin | Assignment | Coding | Plug/socket |        |
|---|-----|------------|--------|-------------|--------|
|   | 1   | +          | Tx     | D           | Socket |
|   | 2   | +          | Rx     |             |        |
|   | 3   | -          | Tx     |             |        |
|   | 4   | -          | Rx     |             |        |

**EtherNet/IP**

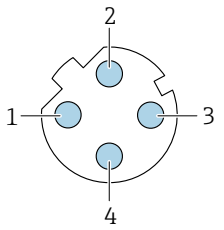
|  | Pin | Assignment   | Coding | Plug/socket |        |
|---|-----|--------------|--------|-------------|--------|
|   | 1   | +            | Tx     | D           | Socket |
|   | 2   | +            | Rx     |             |        |
|   | 3   | -            | Tx     |             |        |
|   | 4   | -            | Rx     |             |        |
| Metal plug housing  |     | Cable shield |        |             |        |

-  Recommended plug:
- Binder, series 825, part no. 99 3729 810 04
  - Phoenix, part no. 1543223 SACC-M12MSD-4Q

**Service interface**

Order code for "Accessory mounted", option **NB**: "Adapter RJ45 M12 (service interface)"

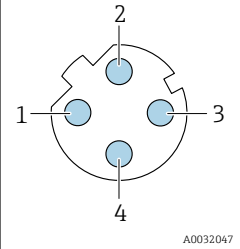
|  | Pin | Assignment | Coding | Plug/socket |        |
|---|-----|------------|--------|-------------|--------|
|   | 1   | +          | Tx     | D           | Socket |
|   | 2   | +          | Rx     |             |        |
|   | 3   | -          | Tx     |             |        |
| 4   | -   | Rx         |        |             |        |

-  Recommended plug:
- Binder, series 825, part no. 99 3729 810 04
  - Phoenix, part no. 1543223 SACC-M12MSD-4Q

**Cable specification**

**Permitted temperature range**

- The installation guidelines that apply in the country of installation must be observed.
- The cables must be suitable for the minimum and maximum temperatures to be expected.

**Power supply cable (incl. conductor for the inner ground terminal)**

Standard installation cable is sufficient.

**Protective grounding cable for the outer ground terminal**

Conductor cross-section < 6 mm<sup>2</sup> (10 AWG)  
 Larger cross-sections can be connected using a cable lug.  
 The grounding impedance must be less than 2 Ω.

**Signal cable**

*4 to 20 mA current input*  
 Standard installation cable is sufficient.

*Pulse/frequency/switch output*  
 Standard installation cable is sufficient.

*Relay output*  
 Standard installation cable is sufficient.

*Status input*  
 Standard installation cable is sufficient.

*Current output 4 to 20 mA HART*  
 Shielded twisted-pair cable.

 See <https://www.fieldcommgroup.org> "HART PROTOCOL SPECIFICATIONS".

*Modbus RS485*  
 Shielded twisted-pair cable.

 See <https://modbus.org> "MODBUS over Serial Line Specification and Implementation Guide".

*PROFIBUS PA*

Shielded twisted-pair cable. Cable type A is recommended.



See <https://www.profibus.com> "PROFIBUS Installation Guidelines".

*PROFIBUS DP*

Shielded twisted-pair cable. Cable type A is recommended.



See <https://www.profibus.com> "PROFIBUS Installation Guidelines".

*PROFINET*

Only PROFINET cables.



See <https://www.profibus.com> "PROFINET Planning guideline".

*EtherNet/IP*

Twisted-pair Ethernet CAT 5 or better.



See <https://www.odva.org> "EtherNet/IP Media Planning & Installation Manual".

*Ethernet-APL*

Shielded twisted-pair cable. Cable type A is recommended.



See <https://www.profibus.com> Ethernet-APL White Paper "

*FOUNDATION Fieldbus*

Twisted, shielded two-wire cable.



For further information on planning and installing FOUNDATION Fieldbus networks see:

- Operating Instructions for "FOUNDATION Fieldbus Overview" (BA00013S)
- FOUNDATION Fieldbus Guideline
- IEC 61158-2 (MBP)

**Connecting cable for transmitter - remote display and operating module DKX001***Standard cable*

A standard cable can be used as the connecting cable.

|                                 |   |
|---------------------------------|---|
| <b>Standard cable</b>           | 4 cores (2 pairs); pair-stranded with common shield |
| <b>Shielding</b>                | Tin-plated copper-braid, optical cover ≥ 85 %       |
| <b>Capacitance: core/shield</b> | Maximum 1 000 nF for Zone 1; Class I, Division 1    |
| <b>L/R</b>                      | Maximum 24 μH/Ω for Zone 1; Class I, Division 1     |
| <b>Cable length</b>             | Maximum 300 m (1 000 ft), see the following table   |

| Cross-section                 | Cable length for use in:   |
|-------------------------------|--|
|                               | <ul style="list-style-type: none"> <li>▪ Non-hazardous area</li> <li>▪ Hazardous area: Zone 2; Class I, Division 2</li> <li>▪ Hazardous area: Zone 1; Class I, Division 1</li> </ul> |
| 0.34 mm <sup>2</sup> (22 AWG) | 80 m (270 ft)  |
| 0.50 mm <sup>2</sup> (20 AWG) | 120 m (400 ft)   |
| 0.75 mm <sup>2</sup> (18 AWG) | 180 m (600 ft)   |
| 1.00 mm <sup>2</sup> (17 AWG) | 240 m (800 ft)   |
| 1.50 mm <sup>2</sup> (15 AWG) | 300 m (1 000 ft)   |

Optionally available connecting cable

|                                 |  |
|---------------------------------|--|
| <b>Standard cable</b>           | 2 × 2 × 0.34 mm <sup>2</sup> (22 AWG) PVC cable <sup>1)</sup> with common shield (2 pairs, pair-stranded)                      |
| <b>Flame resistance</b>         | According to DIN EN 60332-1-2  |
| <b>Oil-resistance</b>           | According to DIN EN 60811-2-1  |
| <b>Shielding</b>                | Tin-plated copper-braid, optical cover ≥ 85 %  |
| <b>Capacitance: core/shield</b> | ≤200 pF/m  |
| <b>L/R</b>                      | ≤24 μH/Ω   |
| <b>Available cable length</b>   | 10 m (35 ft)   |
| <b>Operating temperature</b>    | When mounted in a fixed position: -50 to +105 °C (-58 to +221 °F); when cable can move freely: -25 to +105 °C (-13 to +221 °F) |

1) UV radiation can impair the cable outer sheath. Protect the cable from direct sunshine where possible.

Overvoltage protection

|  |   |
|--|---|
| <b>Mains voltage fluctuations</b>        | → ☰ 40  |
| <b>Overvoltage category</b>              | Overvoltage category II                             |
| <b>Short-term, temporary overvoltage</b> | Between cable and ground up to 1200 V, for max. 5 s |
| <b>Long-term, temporary overvoltage</b>  | Between cable and ground up to 500 V                |

## Performance characteristics

Reference operating conditions

- Error limits based on ISO 11631
  - Water
    - +15 to +45 °C (+59 to +113 °F)
    - 2 to 6 bar (29 to 87 psi)
  - Data as indicated in the calibration protocol
  - Accuracy based on accredited calibration rigs according to ISO 17025
-  To obtain measured errors, use the *Applicator* sizing tool → ☰ 114

Maximum measurement error

o.r. = of reading; 1 g/cm<sup>3</sup> = 1 kg/l; T = medium temperature

Base accuracy

 Design fundamentals → ☰ 54

*Mass flow and volume flow (liquids)*

±0.15 % o.r.  
 ±0.10 % o.r. (order code for "Calibration flow", option A, B, C)

*Mass flow (gases)*

±0.50 % o.r.

*Density (liquids)*

| Under reference conditions<br>[g/cm <sup>3</sup> ] | Standard density calibration<br>[g/cm <sup>3</sup> ] |
|--|--|
| ±0.0005  | ±0.002   |

*Temperature*
 $\pm 0.5 \text{ }^\circ\text{C} \pm 0.005 \cdot T \text{ }^\circ\text{C} (\pm 0.9 \text{ }^\circ\text{F} \pm 0.003 \cdot (T - 32) \text{ }^\circ\text{F})$ 
**Zero point stability**

| DN   |                | Zero point stability |          |
|------|----------------|----------------------|----------|
| [mm] | [in]           | [kg/h]               | [lb/min] |
| 8    | $\frac{3}{8}$  | 0.20                 | 0.007    |
| 15   | $\frac{1}{2}$  | 0.65                 | 0.024    |
| 25   | 1              | 1.80                 | 0.066    |
| 40   | $1\frac{1}{2}$ | 4.50                 | 0.165    |
| 50   | 2              | 7.0                  | 0.257    |
| 80   | 3              | 18.0                 | 0.6615   |

**Flow values**

Flow values as turndown parameters depending on nominal diameter.

*SI units*

| DN   | 1:1     | 1:10   | 1:20   | 1:50   | 1:100  | 1:500  |
|------|---------|--------|--------|--------|--------|--------|
| [mm] | [kg/h]  | [kg/h] | [kg/h] | [kg/h] | [kg/h] | [kg/h] |
| 8    | 2 000   | 200    | 100    | 40     | 20     | 4      |
| 15   | 6 500   | 650    | 325    | 130    | 65     | 13     |
| 25   | 18 000  | 1 800  | 900    | 360    | 180    | 36     |
| 40   | 45 000  | 4 500  | 2 250  | 900    | 450    | 90     |
| 50   | 70 000  | 7 000  | 3 500  | 1 400  | 700    | 140    |
| 80   | 180 000 | 18 000 | 9 000  | 3 600  | 1 800  | 360    |

*US units*

| DN             | 1:1      | 1:10     | 1:20     | 1:50     | 1:100    | 1:500    |
|----------------|----------|----------|----------|----------|----------|----------|
| [inch]         | [lb/min] | [lb/min] | [lb/min] | [lb/min] | [lb/min] | [lb/min] |
| $\frac{3}{8}$  | 73.50    | 7.350    | 3.675    | 1.470    | 0.735    | 0.147    |
| $\frac{1}{2}$  | 238.9    | 23.89    | 11.95    | 4.778    | 2.389    | 0.478    |
| 1              | 661.5    | 66.15    | 33.08    | 13.23    | 6.615    | 1.323    |
| $1\frac{1}{2}$ | 1 654    | 165.4    | 82.70    | 33.08    | 16.54    | 3.308    |
| 2              | 2 573    | 257.3    | 128.7    | 51.46    | 25.73    | 5.146    |
| 3              | 6 615    | 661.5    | 330.8    | 132.3    | 66.15    | 13.23    |

**Accuracy of outputs**

The outputs have the following base accuracy specifications:

*Current output*

|          |                     |
|----------|---------------------|
| Accuracy | $\pm 5 \mu\text{A}$ |
|----------|---------------------|

*Pulse/frequency output*

o.r. = of reading

|                 |   |
|-----------------|---|
| <b>Accuracy</b> | Max. ±50 ppm o.r. (over the entire ambient temperature range) |
|-----------------|---|

**Repeatability**

o.r. = of reading; 1 g/cm<sup>3</sup> = 1 kg/l; T = medium temperature

**Base repeatability**

 Design fundamentals →  54

*Mass flow and volume flow (liquids)*

±0.075 % o.r.  
 ±0.05 % o.r. (calibration option, for mass flow)

*Mass flow (gases)*

±0.25 % o.r. (up to a Mach number of 0.2)

*Density (liquids)*

±0.00025 g/cm<sup>3</sup>

*Temperature*

±0.25 °C ± 0.0025 · T °C (±0.45 °F ± 0.0015 · (T-32) °F)

**Response time**

The response time depends on the configuration (damping).

**Influence of ambient temperature**

**Current output**

|                                |              |
|--------------------------------|--------------|
| <b>Temperature coefficient</b> | Max. 1 µA/°C |
|--------------------------------|--------------|

**Pulse/frequency output**

|                                |   |
|--------------------------------|---|
| <b>Temperature coefficient</b> | No additional effect. Included in accuracy. |
|--------------------------------|---|

**Influence of medium temperature**

**Mass flow**

o.f.s. = of full scale value

If there is a difference between the temperature during zero adjustment and the process temperature, the additional measurement error of the sensors is typically ±0.0002 %o.f.s./°C (±0.0001 % o. f.s./°F).

The influence is reduced when the zero adjustment is performed at process temperature.

**Density**

If there is a difference between the density calibration temperature and the process temperature, the measurement error of the sensors is typically ±0.0001 g/cm<sup>3</sup>/°C (±0.00005 g/cm<sup>3</sup>/°F). Field density adjustment is possible.

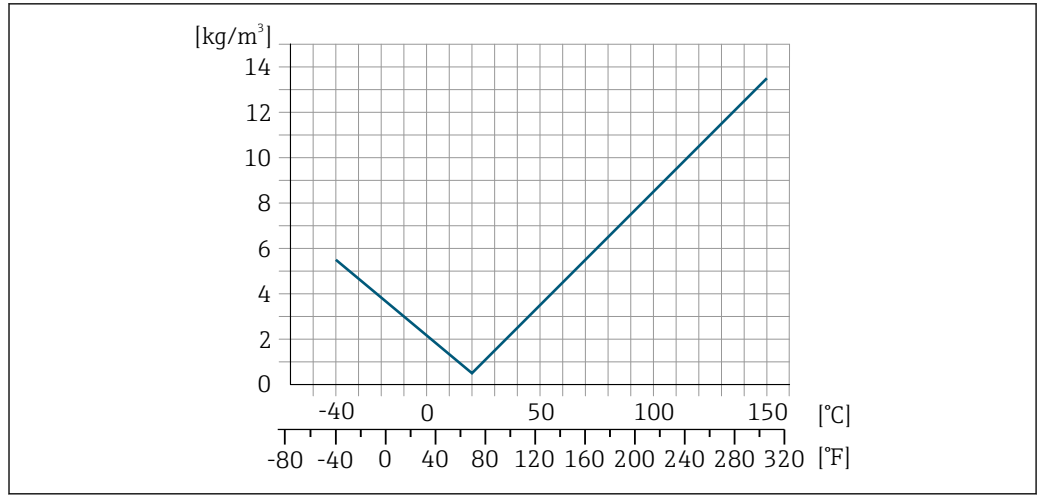

13 Field density adjustment, for example at +20 °C (+68 °F)

**Temperature**

$$\pm 0.005 \cdot T \text{ } ^\circ\text{C} (\pm 0.005 \cdot (T - 32) \text{ } ^\circ\text{F})$$

**Influence of medium pressure**

The following shows how the process pressure (gauge pressure) affects the accuracy of the mass flow.

o.r. = of reading



It is possible to compensate for the effect by:

- Reading in the current pressure measured value via the current input or a digital input.
- Specifying a fixed value for the pressure in the device parameters.



Operating Instructions → 115.

| DN   |       | [% o.r./bar] | [% o.r./psi] |
|------|-------|--------------|--------------|
| [mm] | [in]  |              |              |
| 8    | 3/8   | no effect    |              |
| 15   | 1/2   | no effect    |              |
| 25   | 1     | no effect    |              |
| 40   | 1 1/2 | no effect    |              |
| 50   | 2     | -0.009       | -0.0006      |
| 80   | 3     | -0.020       | -0.0014      |

**Design fundamentals**

o.r. = of reading, o.f.s. = of full scale value

BaseAccu = base accuracy in % o.r., BaseRepeat = base repeatability in % o.r.

MeasValue = measured value; ZeroPoint = zero point stability

Calculation of the maximum measured error as a function of the flow rate

| Flow rate  | Maximum measured error in % o.r.   |
|--|--|
| $\geq \frac{\text{ZeroPoint}}{\text{BaseAccu}} \cdot 100$<br><small>A0021332</small> | $\pm \text{BaseAccu}$<br><small>A0021339</small>                                     |
| $< \frac{\text{ZeroPoint}}{\text{BaseAccu}} \cdot 100$<br><small>A0021333</small>    | $\pm \frac{\text{ZeroPoint}}{\text{MeasValue}} \cdot 100$<br><small>A0021334</small> |

Calculation of the maximum repeatability as a function of the flow rate

| Flow rate  | Maximum repeatability in % o.r.  |
|--|--|
| $\geq \frac{1/2 \cdot \text{ZeroPoint}}{\text{BaseRepeat}} \cdot 100$<br><small>A0021335</small> | $\pm \text{BaseRepeat}$<br><small>A0021340</small>   |
| $< \frac{1/2 \cdot \text{ZeroPoint}}{\text{BaseRepeat}} \cdot 100$<br><small>A0021336</small>    | $\pm 1/2 \cdot \frac{\text{ZeroPoint}}{\text{MeasValue}} \cdot 100$<br><small>A0021337</small> |

**Example of maximum measurement error**

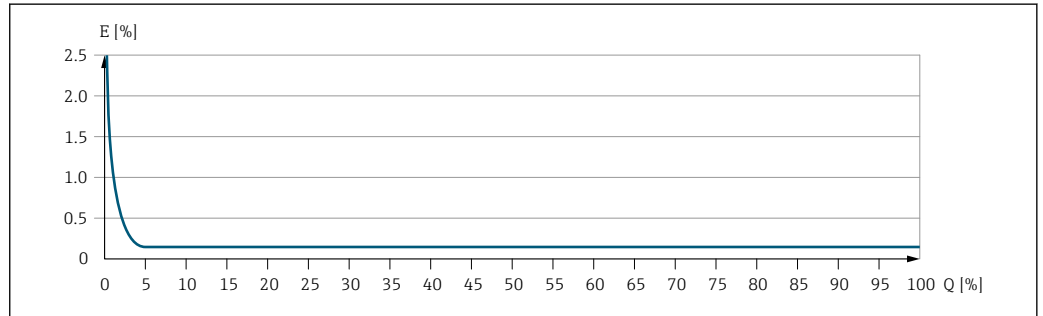

E Maximum measurement error in % o.r. (example)  
 Q Flow rate in % of maximum full scale value

**Installation**

**Mounting location**

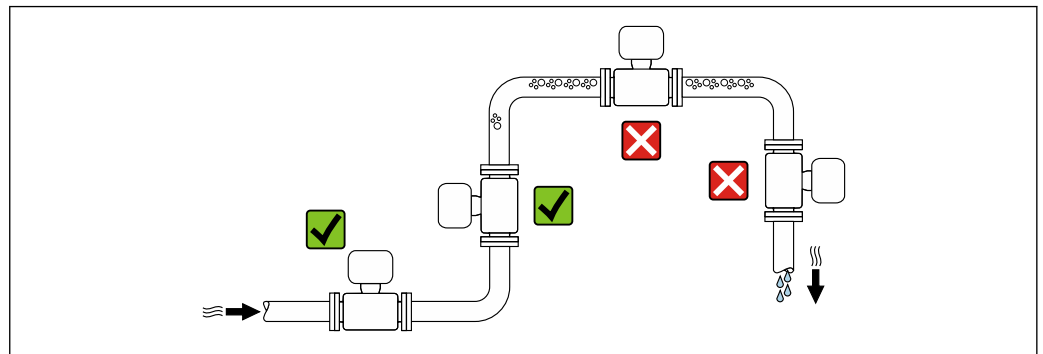

To avoid measurement errors caused by gas bubble formation in the measuring tube, avoid the following installation locations in the pipe:

- Highest point of a pipeline
- Directly upstream of a free pipe outlet in a down pipe

**Installation in down pipes**

However, the following installation suggestion allows for installation in an open vertical pipeline. Pipe restrictions or the use of an orifice with a smaller cross-section than the nominal diameter prevent the sensor running empty while measurement is in progress.

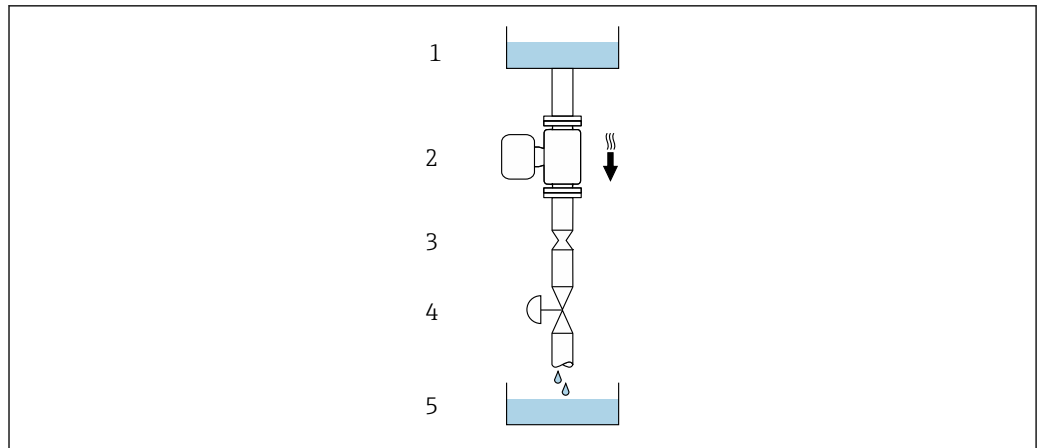

A0028773

14 Installation in a down pipe (e.g. for batching applications)

- 1 Supply tank
- 2 Sensor
- 3 Orifice plate, pipe restriction
- 4 Valve
- 5 Filling container

| DN/NPS |       | Ø orifice plate, pipe restriction |      |
|--------|-------|-----------------------------------|------|
| [mm]   | [in]  | [mm]                              | [in] |
| 8      | 3/8   | 6                                 | 0.24 |
| 15     | 1/2   | 10                                | 0.40 |
| 25     | 1     | 14                                | 0.55 |
| 40     | 1 1/2 | 22                                | 0.87 |
| 50     | 2     | 28                                | 1.10 |
| 80     | 3     | 50                                | 1.97 |

**Orientation**

The direction of the arrow on the sensor nameplate helps you to install the sensor according to the flow direction (direction of medium flow through the piping).

| Orientation |   | Recommendation |
|-------------|---|----------------|
| <b>A</b>    | Vertical orientation                          | <br>A0015591   |
| <b>B</b>    | Horizontal orientation, transmitter at top    | <br>A0015589   |
| <b>C</b>    | Horizontal orientation, transmitter at bottom | <br>A0015590   |
| <b>D</b>    | Horizontal orientation, transmitter at side   | <br>A0015592   |

- 1) This orientation is recommended to ensure self-draining.
- 2) Applications with low process temperatures may reduce the ambient temperature. To maintain the minimum ambient temperature for the transmitter, this orientation is recommended.
- 3) Applications with high process temperatures may increase the ambient temperature. To maintain the maximum ambient temperature for the transmitter, this orientation is recommended.

If a sensor is installed horizontally with a curved measuring tube, match the position of the sensor to the medium properties.

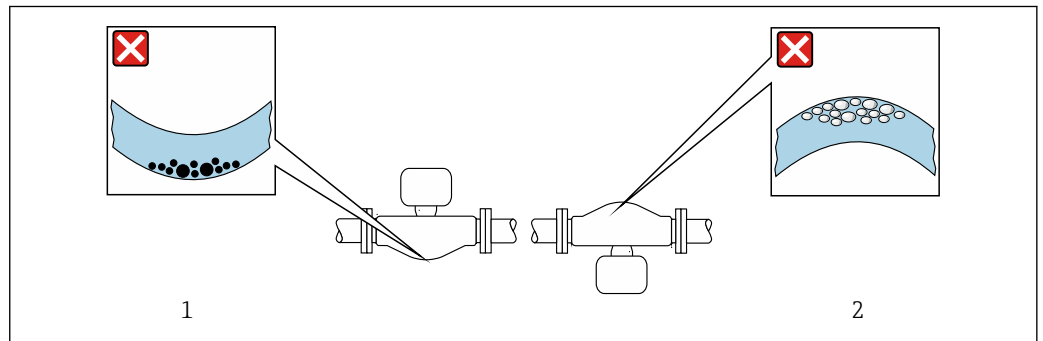

15 Orientation of sensor with curved measuring tube

- 1 Avoid this orientation for media with entrained solids: Risk of solids accumulating
- 2 Avoid this orientation for outgassing media: Risk of gas accumulating

A0028774

### Inlet and outlet runs

No special precautions need to be taken for fittings that create turbulence, such as valves, elbows or T-pieces, as long as no cavitation occurs → 65.

### Special installation instructions

#### Drainability

When installed vertically, the measuring tubes can be drained completely and protected against buildup.

#### Hygienic compatibility

-  When installing in hygienic applications, please refer to the information in the "Certificates and approvals/hygienic compatibility" section → 107
- In the case of measuring devices with the order code for "Housing", option B "Stainless, hygienic", to seal the connection compartment cover, screw it closed finger-tight and tighten it by another 45° (corresponds to 15 Nm).

#### Rupture disk

Process-related information: → 65.

#### WARNING

#### Danger from medium escaping!

Medium escaping under pressure can cause injury or material damage.

- ▶ Take precautions to prevent danger to persons and damage if the rupture disk is actuated.
- ▶ Observe the information on the rupture disk sticker.
- ▶ Make sure that the function and operation of the rupture disk is not impeded through the installation of the device.
- ▶ Do not use a heating jacket.
- ▶ Do not remove or damage the rupture disk.

The position of the rupture disk is indicated on a sticker applied over it. If the rupture disk is triggered, the sticker is destroyed. The disk can therefore be visually monitored.

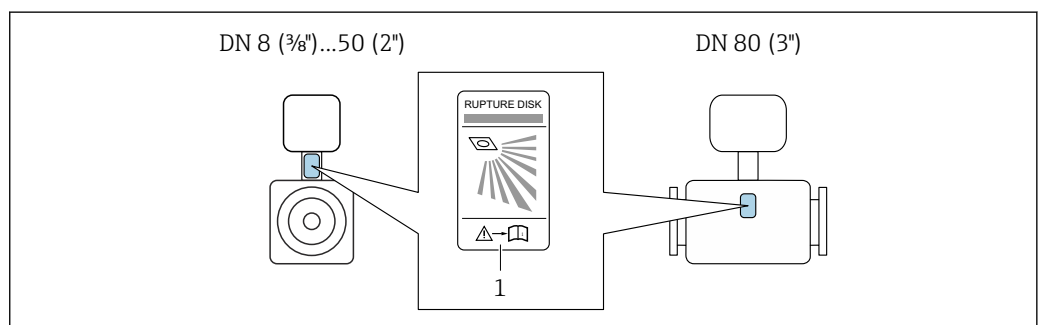

1 Rupture disk label

A0029956

### Zero point verification and zero adjustment

All measuring instruments are calibrated in accordance with state-of-the-art technology. Calibration takes place under reference conditions → 51. Therefore, a zero adjustment in the field is generally not required.

Experience shows that zero adjustment is advisable only in special cases:

- To achieve maximum measurement accuracy even with low flow rates.
- Under extreme process or operating conditions (e.g. very high process temperatures or very high-viscosity media).
- For gas applications with low pressure.

For information on checking the zero point and performing a zero adjustment, see the Operating Instructions for the device.

**i** To achieve the highest possible measurement accuracy at low flow rates, the installation must protect the sensor from mechanical stress during operation.

### Protective cover

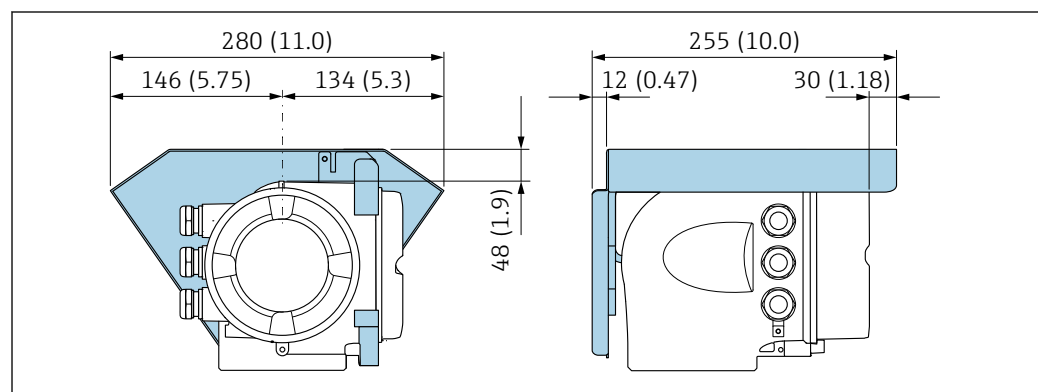

A0029553

16 Unit mm (in)

## Environment

### Ambient temperature range

|                                  |   |
|----------------------------------|---|
| Measuring instrument             | <ul style="list-style-type: none"> <li>▪ -40 to +60 °C (-40 to +140 °F)</li> <li>▪ Order code for "Test, certificate", option JP:<br/>-50 to +60 °C (-58 to +140 °F)</li> </ul> |
| Readability of the local display | -20 to +60 °C (-4 to +140 °F)<br>The readability of the display may be impaired at temperatures outside the temperature range.  |

**i** Dependency of ambient temperature on medium temperature → 59

- ▶ If operating outdoors:  
Avoid direct sunlight, particularly in warm climatic regions.

**i** You can order a weather protection cover from Endress+Hauser. → 112.

### Storage temperature



-50 to +80 °C (-58 to +176 °F)

### Climate class

DIN EN 60068-2-38 (test Z/AD)

### Relative humidity

The device is suitable for use in outdoor and indoor areas with a relative humidity of 4 to 95%.

|  |   |
|--|---|
| <b>Operating height</b>                          | According to EN 61010-1<br>≤ 2 000 m (6 562 ft)   |
| <b>Degree of protection</b>                      | <p><b>Transmitter</b></p> <ul style="list-style-type: none"> <li>■ IP66/67, Type 4X enclosure, suitable for pollution degree 4</li> <li>■ When the housing is open: IP20, Type 1 enclosure, suitable for pollution degree 2</li> <li>■ Display module: IP20, Type 1 enclosure, suitable for pollution degree 2</li> </ul> <p><b>Optional</b></p> <p>Order code for "Sensor options", option CM "IP69"</p> <p><b>External WLAN antenna</b></p> <p>IP67</p>   |
| <b>Vibration resistance and shock resistance</b> | <p><b>Sinusoidal vibration similar to IEC 60068-2-6</b></p> <ul style="list-style-type: none"> <li>■ 2 to 8.4 Hz, 3.5 mm peak</li> <li>■ 8.4 to 2 000 Hz, 1 g peak</li> </ul> <p><b>Broadband random vibration similar to IEC 60068-2-64</b></p> <ul style="list-style-type: none"> <li>■ 10 to 200 Hz, 0.003 g<sup>2</sup>/Hz</li> <li>■ 200 to 2 000 Hz, 0.001 g<sup>2</sup>/Hz</li> <li>■ Total: 1.54 g rms</li> </ul> <p><b>Half-sine shocks similar to IEC 60068-2-27</b></p> <p>6 ms 30 g</p> <p><b>Rough handling shocks similar to IEC 60068-2-31</b></p>   |
| <b>Mechanical load</b>                           | <p>Transmitter housing:</p> <ul style="list-style-type: none"> <li>■ Protect against mechanical effects, such as shock or impact</li> <li>■ Do not use as a ladder or climbing aid</li> </ul>   |
| <b>Electromagnetic compatibility (EMC)</b>       | <ul style="list-style-type: none"> <li>■ As per IEC/EN 61326 and NAMUR Recommendation 21 (NE 21), NAMUR Recommendation 21 (NE 21) is fulfilled when the device is installed in accordance with NAMUR Recommendation 98 (NE 98).</li> <li>■ As per IEC/EN 61000-6-2 and IEC/EN 61000-6-4</li> <li>■ Device version with PROFIBUS DP: Complies with emission limits for industry as per EN 50170 Volume 2, IEC 61784</li> </ul> <p> The following applies for PROFIBUS DP: If baud rates &gt; 1.5 MBaud, an EMC cable entry must be used and the cable shield must continue as far as the terminal wherever possible.</p> <p> Details are provided in the Declaration of Conformity.</p> <p> This unit is not intended for use in residential environments and cannot guarantee adequate protection of the radio reception in such environments.</p> |

## Process

---

|                                 |                                 |
|---------------------------------|---------------------------------|
| <b>Medium temperature range</b> | -40 to +150 °C (-40 to +302 °F) |
|---------------------------------|---------------------------------|

Dependency of ambient temperature on medium temperature

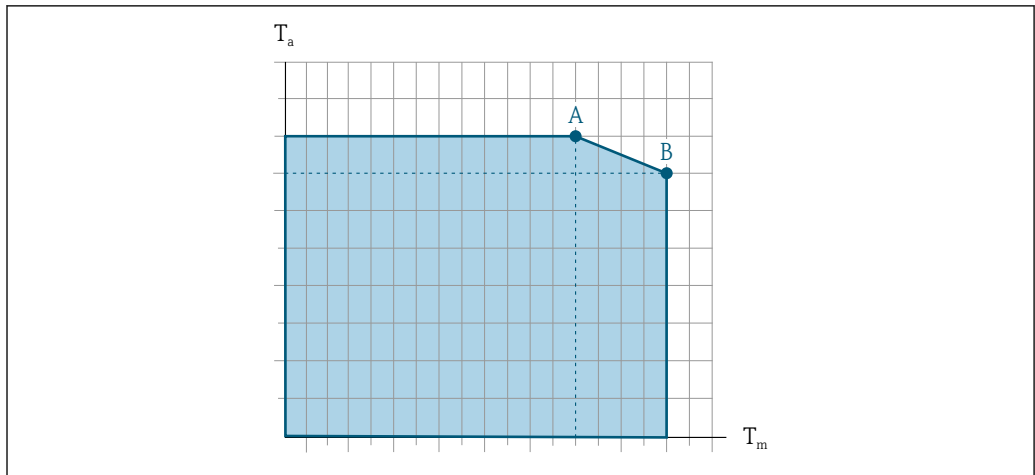

A0031121

17 Exemplary representation, values in the table below.

$T_a$  Ambient temperature

$T_m$  Medium temperature

A Maximum permitted medium temperature  $T_m$  at  $T_{a\ max} = 60\text{ °C (140 °F)}$ ; higher medium temperatures  $T_m$  require a reduction in the ambient temperature  $T_a$

B Maximum permitted ambient temperature  $T_a$  for the maximum specified medium temperature  $T_m$  of the sensor

**i** Values for devices that are used in the hazardous area:  
Separate Ex documentation (XA) for the device → 116.

| Not insulated  |                 |       |       | Insulated      |                 |                |                 |
|----------------|-----------------|-------|-------|----------------|-----------------|----------------|-----------------|
| A              |                 | B     |       | A              |                 | B              |                 |
| $T_a$          | $T_m$           | $T_a$ | $T_m$ | $T_a$          | $T_m$           | $T_a$          | $T_m$           |
| 60 °C (140 °F) | 150 °C (302 °F) | -     | -     | 60 °C (140 °F) | 110 °C (230 °F) | 55 °C (131 °F) | 150 °C (302 °F) |

**Medium density** 0 to 5 000 kg/m<sup>3</sup> (0 to 312 lb/cf)

**Pressure/temperature ratings** The following pressure/temperature diagrams apply to all pressure-bearing parts of the device and not just the process connection. The diagrams show the maximum permissible medium pressure depending on the specific medium temperature.

**Flange similar to EN 1092-1 (DIN 2501)**

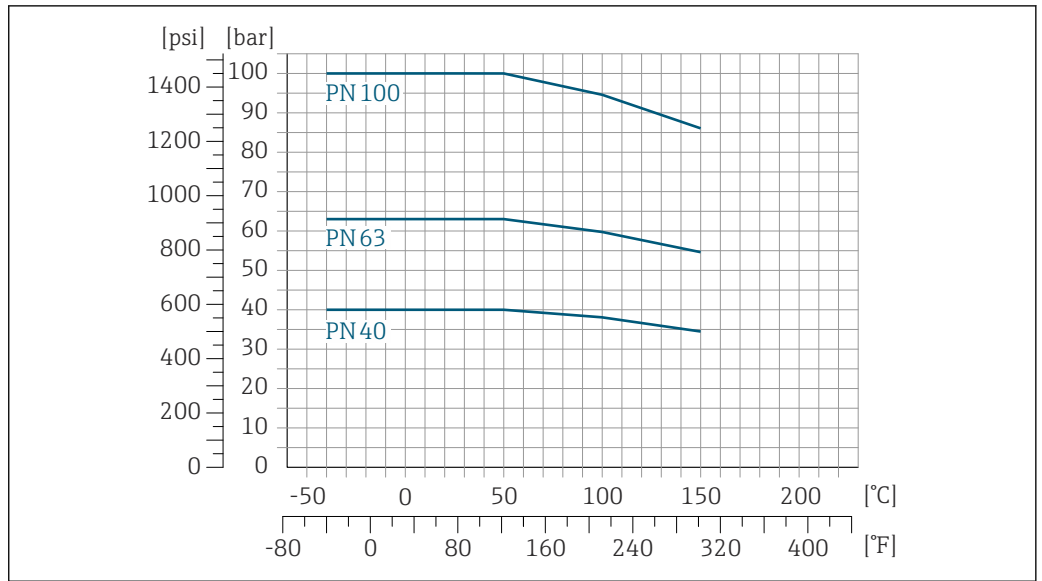

18 With flange material 1.4404 (F316/F316L)

A0029832-EN

**Flange similar to ASME B16.5**

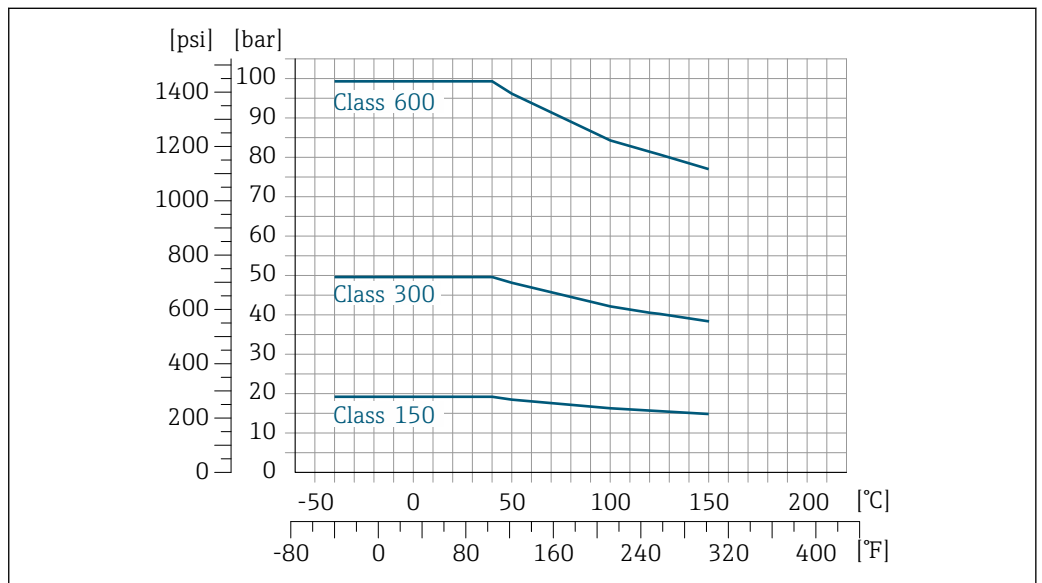

19 With flange material 1.4404 (F316/F316L)

A0029833-EN

**Flange JIS B2220**

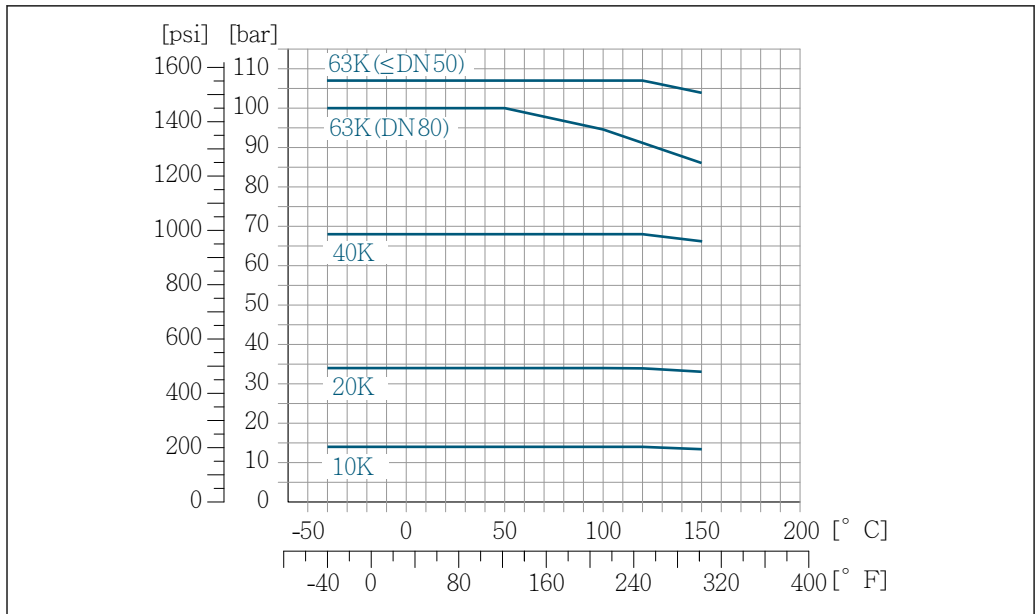

A0029834-EN

20 With flange material 1.4404 (F316/F316L)

**Flange DIN 11864-2 Form A**

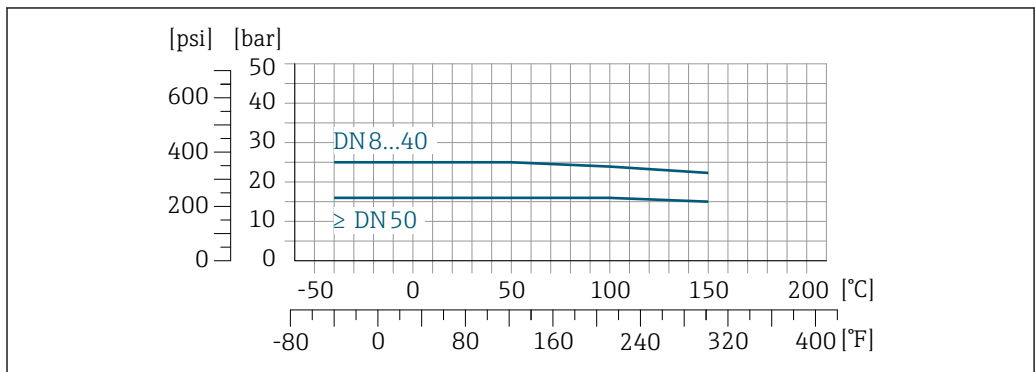

A0029839-EN

21 With flange material 1.4404 (316/316L)

**Threaded adapter DIN 11851**

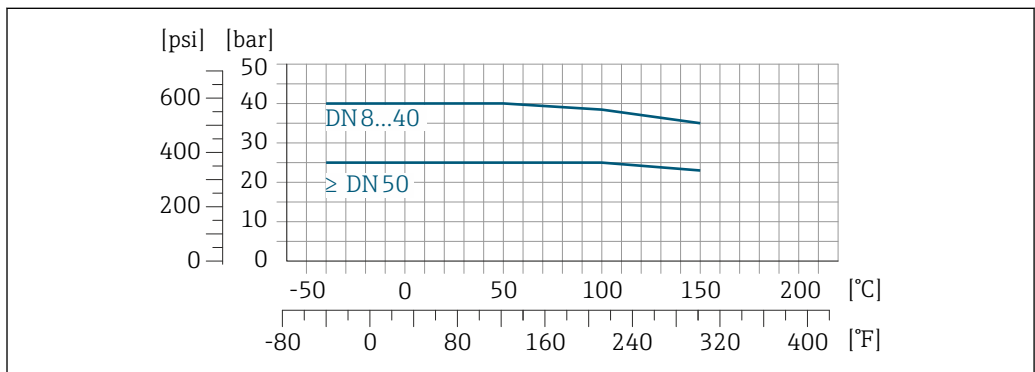

A0029848-EN

22 With connection material 1.4404 (316/316L)

DIN 11851 allows for applications up to +140 °C (+284 °F) if suitable sealing materials are used. Please take this into account when selecting seals and counterparts, as these components can limit the pressure and temperature range.

**Threaded adapter DIN 11864-1 Form A**

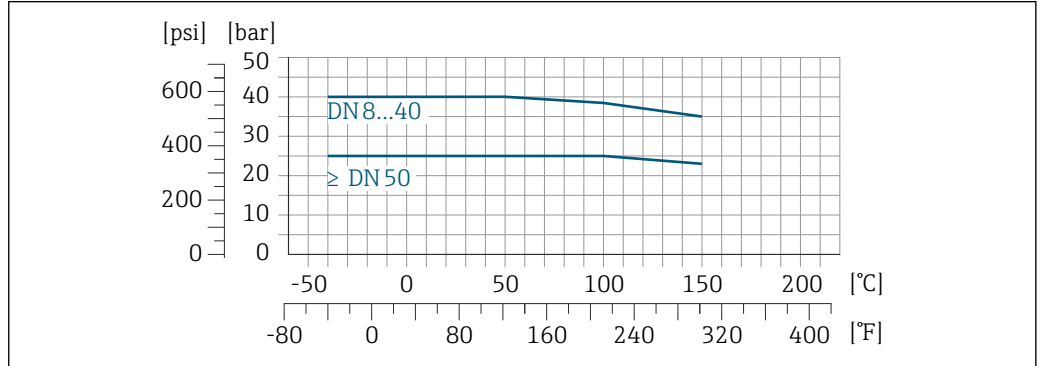

A0029848-EN

23 With connection material 1.4404 (316/316L)

**Threaded adapter ISO 2853**

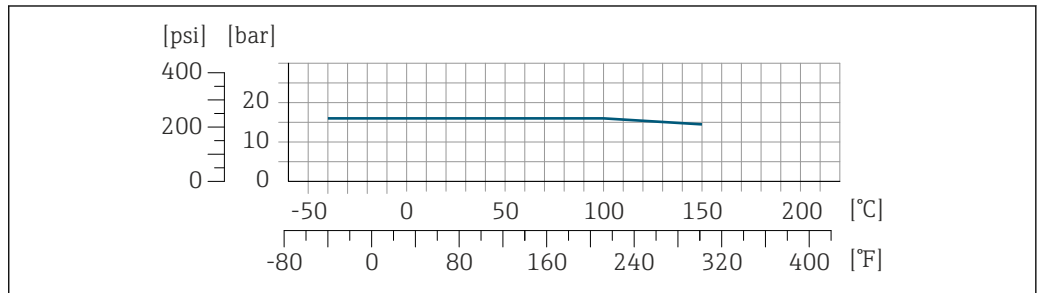

A0029853-EN

24 With connection material 1.4404 (316/316L)

**Threaded adapter SMS 1145**

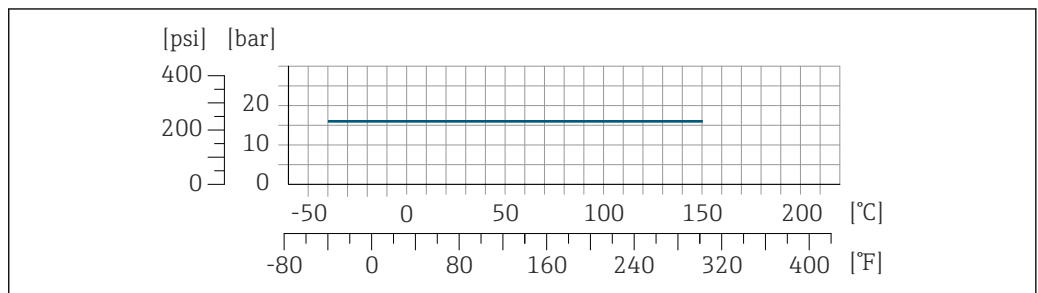

A0032218-EN

25 With connection material 1.4404 (316/316L)

## VCO

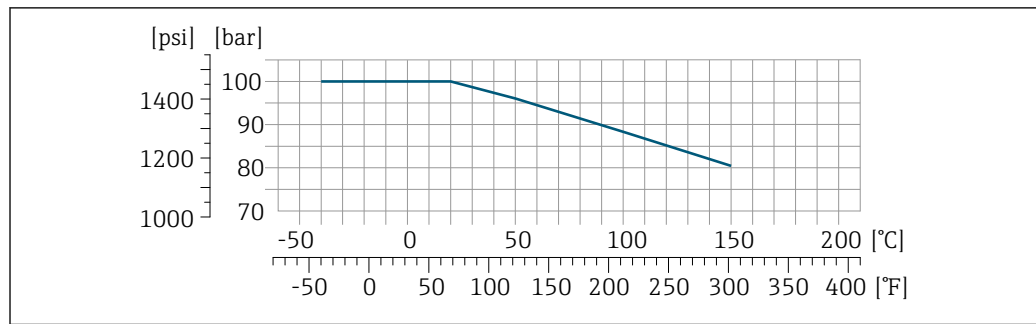

A0029863-EN

26 With connection material 1.4404 (316/316L)

## Tri-Clamp

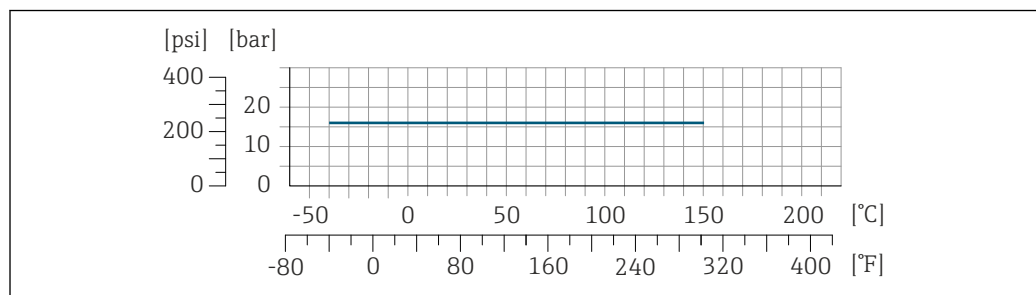

A0032218-EN

The clamp connections are suitable up to a maximum pressure of 16 bar (232 psi). Please observe the operating limits of the clamp and seal used as they can be over 16 bar (232 psi). The clamp and seal are not included in the scope of supply.

## Sensor housing

The sensor housing is filled with dry nitrogen gas and protects the electronics and mechanics inside.

**i** If a measuring tube fails (e.g. due to process characteristics like corrosive or abrasive fluids), the fluid will initially be contained by the sensor housing.

In the event of a tube failure, the pressure level inside the sensor housing will rise according to the operating process pressure. If the user judges that the sensor housing burst pressure does not provide an adequate safety margin, the device can be fitted with a rupture disk. This prevents excessively high pressure from forming inside the sensor housing. Therefore, the use of a rupture disk is strongly recommended in applications involving high gas pressures, and particularly in applications in which the process pressure is greater than 2/3 of the sensor housing burst pressure.

## Burst pressure of the sensor housing

If the device is fitted with a rupture disk (order code for "Sensor option", option CA "Rupture disk"), the rupture disk trigger pressure is decisive.

The sensor housing burst pressure refers to a typical internal pressure which is reached prior to mechanical failure of the sensor housing and which was determined during type testing. The corresponding type test declaration can be ordered with the device (order code for "Additional approval", option LN "Sensor housing burst pressure, type test").

| DN   |                | Sensor housing burst pressure |       |
|------|----------------|-------------------------------|-------|
| [mm] | [in]           | [bar]                         | [psi] |
| 8    | $\frac{3}{8}$  | 250                           | 3 620 |
| 15   | $\frac{1}{2}$  | 250                           | 3 620 |
| 25   | 1              | 250                           | 3 620 |
| 40   | $1\frac{1}{2}$ | 200                           | 2 900 |

| DN   |      | Sensor housing burst pressure |       |
|------|------|-------------------------------|-------|
| [mm] | [in] | [bar]                         | [psi] |
| 50   | 2    | 180                           | 2 610 |
| 80   | 3    | 120                           | 1 740 |

For information on the dimensions: see the "Mechanical construction" section → 67

**Rupture disk**

To increase the level of safety, a device version with a rupture disk with a trigger pressure of 10 to 15 bar (145 to 217.5 psi) can be used (order code for "Sensor option", option CA "rupture disk").  
The use of rupture disks cannot be combined with the separately available heating jacket.

**Internal cleaning**

- CIP cleaning
- SIP cleaning

**Options**

Oil- and grease-free version for wetted parts, without declaration  
Order code for "Service", option HA <sup>1)</sup>

**Flow limit**

Select the nominal diameter by optimizing between the required flow range and permissible pressure loss.

**i** For an overview of the full scale values for the measuring range, see the "Measuring range" section → 10

- The minimum recommended full scale value is approx. 1/20 of the maximum full scale value
- For the most common applications, 20 to 50 % of the maximum full scale value can be considered ideal
- A low full scale value must be selected for abrasive media (such as liquids with entrained solids): flow velocity < 1 m/s (< 3 ft/s).
- For gas measurement the following rules apply:
  - The flow velocity in the measuring tubes should not exceed half the speed of sound (0.5 Mach)
  - The maximum mass flow depends on the density of the gas: formula

**i** To calculate the flow limit, use the *Applicator* sizing tool → 114

**Pressure loss**

**i** To calculate the pressure loss, use the *Applicator* sizing tool → 114

**Static pressure**

It is important that cavitation does not occur, or that gases entrained in the liquids do not outgas. This is prevented by means of a sufficiently high static pressure.

For this reason, the following mounting locations are recommended:

- At the lowest point in a vertical pipe
- Downstream from pumps (no danger of vacuum)

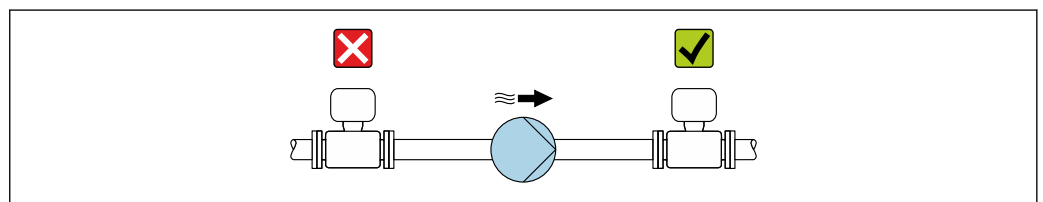

A0028777

**Thermal insulation**

In the case of some fluids, it is important to keep the heat radiated from the sensor to the transmitter to a low level. A wide range of materials can be used for the required insulation.

1) Cleaning only refers to the measuring instrument. Any accessories that have been supplied are not cleaned.

**NOTICE****Electronics overheating on account of thermal insulation!**

- ▶ Recommended orientation: horizontal orientation, transmitter housing pointing downwards.
- ▶ Do not insulate the transmitter housing .
- ▶ Maximum permissible temperature at the lower end of the transmitter housing: 80 °C (176 °F)
- ▶ Thermal insulation with exposed extension neck: We recommend that you do not insulate the extension neck in order to ensure optimum dissipation of heat.

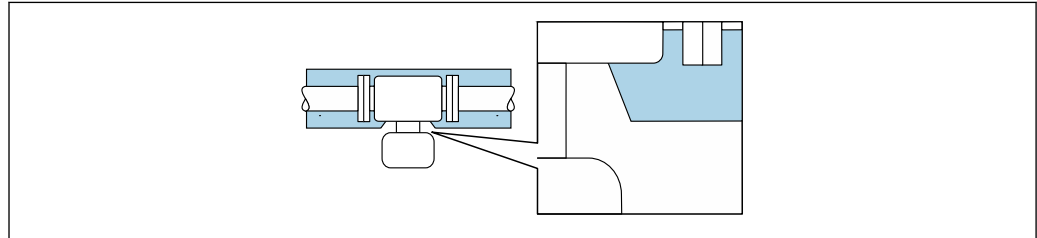

A0034391

 27 Thermal insulation with exposed extension neck

**Heating**

Some media require suitable measures to avoid loss of heat at the sensor.

**Heating options**

- Electrical heating, e.g. with electric band heaters <sup>2)</sup>
- Via pipes carrying hot water or steam
- Via heating jackets



Heating jackets for the sensors can be ordered as accessories from Endress+Hauser →  113.

**NOTICE****Danger of overheating when heating**

- ▶ Ensure that the temperature at the lower end of the transmitter housing does not exceed 80 °C (176 °F).
- ▶ Ensure that sufficient convection takes place at the transmitter neck.
- ▶ Ensure that a sufficiently large area of the transmitter neck remains exposed. The uncovered part serves as a radiator and protects the electronics from overheating and excessive cooling.
- ▶ When using in potentially explosive atmospheres, observe the information in the device-specific Ex documentation. For detailed information on the temperature tables, see the separate document entitled "Safety Instructions" (XA) for the device.
- ▶ Consider the behavior of the process diagnostics "830 Ambient temperature too high" and "832 Electronics temperature too high" if overheating cannot be avoided by a suitable system design.

**Vibrations**

The high oscillation frequency of the measuring tubes ensures that the correct operation of the measuring system is not influenced by plant vibrations.

2) The use of parallel electric band heaters is generally recommended (bidirectional electricity flow). Particular considerations must be made if a single-wire heating cable is to be used. Additional information is provided in the document EA01339D "Installation instructions for electrical trace heating systems" →  118

## Mechanical construction

Dimensions in SI units

Compact version

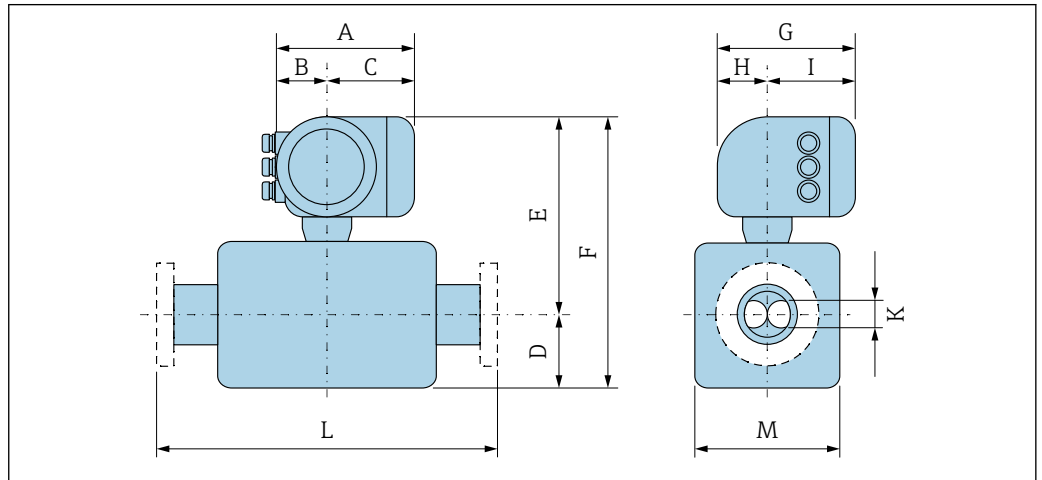

A0033786

Order code for "Housing", option A "Aluminum, coated"

| DN   | A <sup>1)</sup> | B <sup>1)</sup> | C    | D     | E     | F     | G <sup>2)</sup> | H    | I <sup>2)</sup> | K    | L             | M    |
|------|-----------------|-----------------|------|-------|-------|-------|-----------------|------|-----------------|------|---------------|------|
| [mm] | [mm]            | [mm]            | [mm] | [mm]  | [mm]  | [mm]  | [mm]            | [mm] | [mm]            | [mm] | [mm]          | [mm] |
| 8    | 169             | 68              | 101  | 89    | 252   | 341   | 200             | 59   | 141             | 5.35 | <sup>3)</sup> | 45   |
| 15   | 169             | 68              | 101  | 100   | 252   | 352   | 200             | 59   | 141             | 8.30 | <sup>3)</sup> | 45   |
| 25   | 169             | 68              | 101  | 102   | 249   | 351   | 200             | 59   | 141             | 12.0 | <sup>3)</sup> | 51   |
| 40   | 169             | 68              | 101  | 121   | 255   | 376   | 200             | 59   | 141             | 17.6 | <sup>3)</sup> | 65   |
| 50   | 169             | 68              | 101  | 175.5 | 269.5 | 445   | 200             | 59   | 141             | 26.0 | <sup>3)</sup> | 95   |
| 80   | 169             | 68              | 101  | 205   | 288.5 | 493.5 | 200             | 59   | 141             | 40.5 | <sup>3)</sup> | 127  |

- 1) Depending on the cable gland used: values up to + 30 mm
- 2) For version without local display: values - 30 mm
- 3) Depending on the process connection

Order code for "Housing", option A "Aluminum, coated"; Ex d

| DN   | A <sup>1)</sup> | B <sup>1)</sup> | C    | D     | E    | F     | G <sup>2)</sup> | H    | I <sup>2)</sup> | K    | L             | M    |
|------|-----------------|-----------------|------|-------|------|-------|-----------------|------|-----------------|------|---------------|------|
| [mm] | [mm]            | [mm]            | [mm] | [mm]  | [mm] | [mm]  | [mm]            | [mm] | [mm]            | [mm] | [mm]          | [mm] |
| 8    | 188             | 85              | 103  | 89    | 253  | 342   | 217             | 58   | 159             | 5.35 | <sup>3)</sup> | 45   |
| 15   | 188             | 85              | 103  | 100   | 253  | 353   | 217             | 58   | 159             | 8.30 | <sup>3)</sup> | 45   |
| 25   | 188             | 85              | 103  | 102   | 250  | 352   | 217             | 58   | 159             | 12.0 | <sup>3)</sup> | 51   |
| 40   | 188             | 85              | 103  | 121   | 256  | 377   | 217             | 58   | 159             | 17.6 | <sup>3)</sup> | 65   |
| 50   | 188             | 85              | 103  | 175.5 | 270  | 445.5 | 217             | 58   | 159             | 26.0 | <sup>3)</sup> | 95   |
| 80   | 188             | 85              | 103  | 205   | 289  | 494   | 217             | 58   | 159             | 40.5 | <sup>3)</sup> | 127  |

- 1) Depending on the cable gland used: values up to + 30 mm
- 2) For version without local display: values - 40 mm
- 3) Depending on the process connection

Order code for "Housing", option B "Stainless, hygienic"

| DN   | A <sup>1)</sup> | B <sup>1)</sup> | C    | D     | E     | F     | G <sup>2)</sup> | H    | I <sup>2)</sup> | K    | L             | M    |
|------|-----------------|-----------------|------|-------|-------|-------|-----------------|------|-----------------|------|---------------|------|
| [mm] | [mm]            | [mm]            | [mm] | [mm]  | [mm]  | [mm]  | [mm]            | [mm] | [mm]            | [mm] | [mm]          | [mm] |
| 8    | 183             | 73              | 110  | 89    | 252   | 341   | 200             | 65   | 135             | 5.35 | <sup>3)</sup> | 45   |
| 15   | 183             | 73              | 110  | 100   | 252   | 352   | 200             | 65   | 135             | 8.30 | <sup>3)</sup> | 45   |
| 25   | 183             | 73              | 110  | 102   | 249   | 351   | 200             | 65   | 135             | 12.0 | <sup>3)</sup> | 51   |
| 40   | 183             | 73              | 110  | 121   | 255   | 376   | 200             | 65   | 135             | 17.6 | <sup>3)</sup> | 65   |
| 50   | 183             | 73              | 110  | 175.5 | 269.5 | 445   | 200             | 65   | 135             | 26.0 | <sup>3)</sup> | 95   |
| 80   | 183             | 73              | 110  | 205   | 288.5 | 493.5 | 200             | 65   | 135             | 40.5 | <sup>3)</sup> | 127  |

- 1) Depending on the cable gland used: values up to + 30 mm  
 2) For version without local display: values - 13 mm  
 3) Depending on the process connection

**Flange connections**

*Fixed flange EN 1092-1, ASME B16.5, JIS B2220*

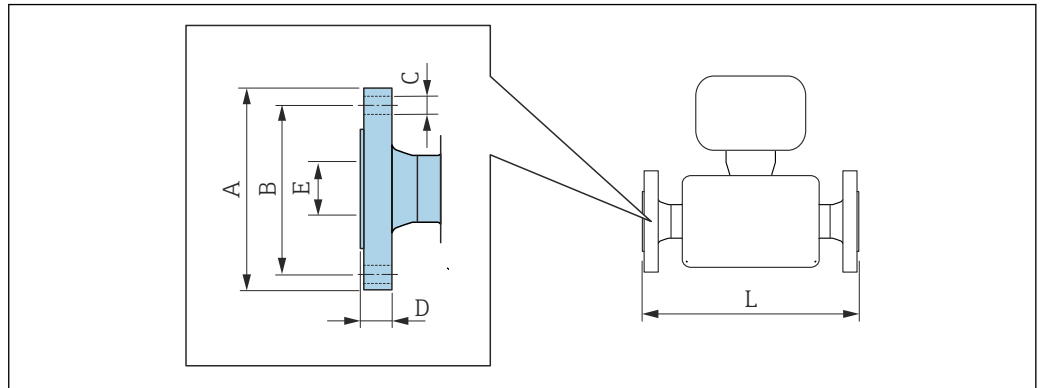

A0015621

**i** Length tolerance for dimension L in mm:  
+1.5/-2.0

| <b>Flange similar to EN 1092-1 (DIN 2501/DIN 2512N), PN 40</b>              |        |        |         |        |        |                       |
|---|--------|--------|---------|--------|--------|-----------------------|
| <b>1.4404 (F316/F316L): order code for "Process connection", option D2S</b> |        |        |         |        |        |                       |
| <b>Flange with groove similar to EN 1092-1 Form D (DIN 2512N), PN 40</b>    |        |        |         |        |        |                       |
| <b>1.4404 (F316/F316L): order code for "Process connection", option D6S</b> |        |        |         |        |        |                       |
| DN [mm]   | A [mm] | B [mm] | C [mm]  | D [mm] | E [mm] | L [mm]                |
| 8 <sup>1)</sup>   | 95     | 65     | 4 × Ø14 | 16     | 17.3   | 232/510 <sup>2)</sup> |
| 15  | 95     | 65     | 4 × Ø14 | 16     | 17.3   | 279/510 <sup>2)</sup> |
| 25  | 115    | 85     | 4 × Ø14 | 18     | 28.5   | 329/600 <sup>2)</sup> |
| 40  | 150    | 110    | 4 × Ø18 | 18     | 43.1   | 445                   |
| 50  | 165    | 125    | 4 × Ø18 | 20     | 54.5   | 556/715 <sup>2)</sup> |
| 80  | 200    | 160    | 8 × Ø18 | 24     | 82.5   | 611/915 <sup>2)</sup> |

Surface roughness (flange): EN 1092-1 Form B1 (DIN 2526 Form C), Ra 3.2 to 12.5 µm

- 1) DN 8 with DN 15 flanges as standard
- 2) Installed length in accordance with NAMUR recommendation NE 132 optionally available (order code for "Process connection", option D2N or D6N (with groove))

| <b>Flange similar to EN 1092-1 (DIN 2501), PN 40 (with DN 25 flanges)</b> |        |        |         |        |        |        |
|---|--------|--------|---------|--------|--------|--------|
| <b>1.4404 (F316/F316L)</b>  |        |        |         |        |        |        |
| <i>Order code for "Process connection", option R2S</i>                    |        |        |         |        |        |        |
| DN [mm]   | A [mm] | B [mm] | C [mm]  | D [mm] | E [mm] | L [mm] |
| 8   | 115    | 85     | 4 × Ø14 | 18     | 28.5   | 329    |
| 15  | 115    | 85     | 4 × Ø14 | 18     | 28.5   | 329    |

Surface roughness (flange): EN 1092-1 Form B1 (DIN 2526 Form C), Ra 3.2 to 12.5 µm

| <b>Flange similar to EN 1092-1 (DIN 2501/DIN 2512N), PN 63</b><br>1.4404 (F316/F316L): order code for "Process connection", option D3S           |           |           |           |           |           |           |
|--|-----------|-----------|-----------|-----------|-----------|-----------|
| <b>Flange with groove similar to EN 1092-1 Form D (DIN 2512N), PN 63</b><br>1.4404 (F316/F316L): order code for "Process connection", option D7S |           |           |           |           |           |           |
| DN<br>[mm]   | A<br>[mm] | B<br>[mm] | C<br>[mm] | D<br>[mm] | E<br>[mm] | L<br>[mm] |
| 50   | 180       | 135       | 4 × Ø22   | 26        | 54.5      | 565       |
| 80   | 215       | 170       | 8 × Ø22   | 28        | 81.7      | 646       |
| Surface roughness (flange): EN 1092-1 Form B2 (DIN 2526 Form E), Ra 0.8 to 3.2 µm  |           |           |           |           |           |           |

| <b>Flange similar to EN 1092-1 (DIN 2501/DIN 2512N), PN 100</b><br>1.4404 (F316/F316L)<br>Order code for "Process connection", option D4S                     |           |           |           |           |           |           |
|---|-----------|-----------|-----------|-----------|-----------|-----------|
| <b>Flange with groove similar to EN 1092-1 Form D (DIN 2512N) available, PN 100</b><br>1.4404 (F316/F316L)<br>Order code for "Process connection", option D8S |           |           |           |           |           |           |
| DN<br>[mm]  | A<br>[mm] | B<br>[mm] | C<br>[mm] | D<br>[mm] | E<br>[mm] | L<br>[mm] |
| 8 <sup>1)</sup>   | 105       | 75        | 4 × Ø14   | 20        | 17.3      | 261       |
| 15  | 105       | 75        | 4 × Ø14   | 20        | 17.3      | 295       |
| 25  | 140       | 100       | 4 × Ø18   | 24        | 28.5      | 360       |
| 40  | 170       | 125       | 4 × Ø22   | 26        | 42.5      | 486       |
| 50  | 195       | 145       | 4 × Ø26   | 28        | 53.9      | 581       |
| 80  | 230       | 180       | 8 × Ø26   | 32        | 80.9      | 656       |
| Surface roughness (flange): EN 1092-1 Form B2 (DIN 2526 Form E), Ra 0.8 to 3.2 µm   |           |           |           |           |           |           |

1) DN 8 with DN 15 flanges as standard

| <b>Flange similar to ASME B16.5, Class 150</b><br>1.4404 (F316/F316L)<br>Order code for "Process connection", option AAS |           |           |           |           |           |           |
|--|-----------|-----------|-----------|-----------|-----------|-----------|
| DN<br>[mm]   | A<br>[mm] | B<br>[mm] | C<br>[mm] | D<br>[mm] | E<br>[mm] | L<br>[mm] |
| 8 <sup>1)</sup>  | 90        | 60.3      | 4 × Ø15.7 | 11.2      | 15.7      | 232       |
| 15   | 90        | 60.3      | 4 × Ø15.7 | 11.2      | 15.7      | 279       |
| 25   | 110       | 79.4      | 4 × Ø15.7 | 14.2      | 26.7      | 329       |
| 40   | 125       | 98.4      | 4 × Ø15.7 | 17.5      | 40.9      | 445       |
| 50   | 150       | 120.7     | 4 × Ø19.1 | 19.1      | 52.6      | 556       |
| 80   | 190       | 152.4     | 4 × Ø19.1 | 23.9      | 78.0      | 611       |
| Surface roughness (flange): Ra 3.2 to 6.3 µm   |           |           |           |           |           |           |

1) DN 8 with DN 15 flanges as standard

| <b>Flange similar to ASME B16.5, Class 300</b><br>1.4404 (F316/F316L)<br>Order code for "Process connection", option ABS |           |           |           |           |           |           |
|--|-----------|-----------|-----------|-----------|-----------|-----------|
| DN<br>[mm]   | A<br>[mm] | B<br>[mm] | C<br>[mm] | D<br>[mm] | E<br>[mm] | L<br>[mm] |
| 8 <sup>1)</sup>  | 95        | 66.7      | 4 × Ø15.7 | 14.2      | 15.7      | 232       |
| 15   | 95        | 66.7      | 4 × Ø15.7 | 14.2      | 15.7      | 279       |

| <b>Flange similar to ASME B16.5, Class 300</b>         |                         |                         |                         |                         |                         |                         |
|--|-------------------------|-------------------------|-------------------------|-------------------------|-------------------------|-------------------------|
| <b>1.4404 (F316/F316L)</b>                             |                         |                         |                         |                         |                         |                         |
| <i>Order code for "Process connection", option ABS</i> |                         |                         |                         |                         |                         |                         |
| <b>DN</b><br><b>[mm]</b>                               | <b>A</b><br><b>[mm]</b> | <b>B</b><br><b>[mm]</b> | <b>C</b><br><b>[mm]</b> | <b>D</b><br><b>[mm]</b> | <b>E</b><br><b>[mm]</b> | <b>L</b><br><b>[mm]</b> |
| 25   | 125                     | 88.9                    | 4 × Ø19.0               | 17.5                    | 26.7                    | 329                     |
| 40   | 155                     | 114.3                   | 4 × Ø22.3               | 20.6                    | 40.9                    | 445                     |
| 50   | 165                     | 127                     | 8 × Ø19.0               | 22.3                    | 52.6                    | 556                     |
| 80   | 210                     | 168.3                   | 8 × Ø22.3               | 28.4                    | 78.0                    | 611                     |
| Surface roughness (flange): Ra 3.2 to 6.3 µm           |                         |                         |                         |                         |                         |                         |

1) DN 8 with DN 15 flanges as standard

| <b>Flange similar to ASME B16.5, Class 600</b>         |                         |                         |                         |                         |                         |                         |
|--|-------------------------|-------------------------|-------------------------|-------------------------|-------------------------|-------------------------|
| <b>1.4404 (F316/F316L)</b>                             |                         |                         |                         |                         |                         |                         |
| <i>Order code for "Process connection", option ACS</i> |                         |                         |                         |                         |                         |                         |
| <b>DN</b><br><b>[mm]</b>                               | <b>A</b><br><b>[mm]</b> | <b>B</b><br><b>[mm]</b> | <b>C</b><br><b>[mm]</b> | <b>D</b><br><b>[mm]</b> | <b>E</b><br><b>[mm]</b> | <b>L</b><br><b>[mm]</b> |
| 8 <sup>1)</sup>  | 95                      | 66.7                    | 4 × Ø15.7               | 20.6                    | 13.9                    | 261                     |
| 15   | 95                      | 66.7                    | 4 × Ø15.7               | 20.6                    | 13.9                    | 295                     |
| 25   | 125                     | 88.9                    | 4 × Ø19.1               | 23.9                    | 24.3                    | 380                     |
| 40   | 155                     | 114.3                   | 4 × Ø22.4               | 28.7                    | 38.1                    | 496                     |
| 50   | 165                     | 127                     | 8 × Ø19.1               | 31.8                    | 49.2                    | 583                     |
| 80   | 210                     | 168.3                   | 8 × Ø22.4               | 38.2                    | 73.7                    | 671                     |
| Surface roughness (flange): Ra 3.2 to 6.3 µm           |                         |                         |                         |                         |                         |                         |

1) DN 8 with DN 15 flanges as standard

| <b>Flange JIS B2220, 10K</b>                           |                         |                         |                         |                         |                         |                         |
|--|-------------------------|-------------------------|-------------------------|-------------------------|-------------------------|-------------------------|
| <b>1.4404 (F316/F316L)</b>                             |                         |                         |                         |                         |                         |                         |
| <i>Order code for "Process connection", option NDS</i> |                         |                         |                         |                         |                         |                         |
| <b>DN</b><br><b>[mm]</b>                               | <b>A</b><br><b>[mm]</b> | <b>B</b><br><b>[mm]</b> | <b>C</b><br><b>[mm]</b> | <b>D</b><br><b>[mm]</b> | <b>E</b><br><b>[mm]</b> | <b>L</b><br><b>[mm]</b> |
| 50   | 155                     | 120                     | 4 × Ø19                 | 16                      | 50                      | 556                     |
| 80   | 185                     | 150                     | 8 × Ø19                 | 18                      | 80                      | 603                     |
| Surface roughness (flange): Ra 3.2 to 6.3 µm           |                         |                         |                         |                         |                         |                         |

| <b>Flange JIS B2220, 20K</b>                           |                         |                         |                         |                         |                         |                         |
|--|-------------------------|-------------------------|-------------------------|-------------------------|-------------------------|-------------------------|
| <b>1.4404 (F316/F316L)</b>                             |                         |                         |                         |                         |                         |                         |
| <i>Order code for "Process connection", option NES</i> |                         |                         |                         |                         |                         |                         |
| <b>DN</b><br><b>[mm]</b>                               | <b>A</b><br><b>[mm]</b> | <b>B</b><br><b>[mm]</b> | <b>C</b><br><b>[mm]</b> | <b>D</b><br><b>[mm]</b> | <b>E</b><br><b>[mm]</b> | <b>L</b><br><b>[mm]</b> |
| 8 <sup>1)</sup>  | 95                      | 70                      | 4 × Ø15                 | 14                      | 15                      | 232                     |
| 15   | 95                      | 70                      | 4 × Ø15                 | 14                      | 15                      | 279                     |
| 25   | 125                     | 90                      | 4 × Ø19                 | 16                      | 25                      | 329                     |
| 40   | 140                     | 105                     | 4 × Ø19                 | 18                      | 40                      | 445                     |
| 50   | 155                     | 120                     | 8 × Ø19                 | 18                      | 50                      | 556                     |

| <b>Flange JIS B2220, 20K</b><br><b>1.4404 (F316/F316L)</b><br><i>Order code for "Process connection", option NES</i> |           |           |           |           |           |           |
|--|-----------|-----------|-----------|-----------|-----------|-----------|
| DN<br>[mm]   | A<br>[mm] | B<br>[mm] | C<br>[mm] | D<br>[mm] | E<br>[mm] | L<br>[mm] |
| 80   | 200       | 160       | 8 × Ø23   | 22        | 80        | 603       |
| Surface roughness (flange): Ra 3.2 to 6.3 µm   |           |           |           |           |           |           |

- 1) DN 8 with DN 15 flanges as standard

| <b>Flange JIS B2220, 40K</b><br><b>1.4404 (F316/F316L)</b><br><i>Order code for "Process connection", option NGS</i> |           |           |           |           |           |           |
|--|-----------|-----------|-----------|-----------|-----------|-----------|
| DN<br>[mm]   | A<br>[mm] | B<br>[mm] | C<br>[mm] | D<br>[mm] | E<br>[mm] | L<br>[mm] |
| 8 <sup>1)</sup>  | 115       | 80        | 4 × Ø19   | 20        | 15        | 261       |
| 15   | 115       | 80        | 4 × Ø19   | 20        | 15        | 300       |
| 25   | 130       | 95        | 4 × Ø19   | 22        | 25        | 375       |
| 40   | 160       | 120       | 4 × Ø23   | 24        | 38        | 496       |
| 50   | 165       | 130       | 8 × Ø19   | 26        | 50        | 601       |
| 80   | 210       | 170       | 8 × Ø23   | 32        | 75        | 661       |
| Surface roughness (flange): Ra 3.2 to 6.3 µm   |           |           |           |           |           |           |

- 1) DN 8 with DN 15 flanges as standard

| <b>Flange JIS B2220, 63K</b><br><b>1.4404 (F316/F316L)</b><br><i>Order code for "Process connection", option NHS</i> |           |           |           |           |           |           |
|--|-----------|-----------|-----------|-----------|-----------|-----------|
| DN<br>[mm]   | A<br>[mm] | B<br>[mm] | C<br>[mm] | D<br>[mm] | E<br>[mm] | L<br>[mm] |
| 8 <sup>1)</sup>  | 120       | 85        | 4 × Ø19   | 23        | 12        | 282       |
| 15   | 120       | 85        | 4 × Ø19   | 23        | 12        | 315       |
| 25   | 140       | 100       | 4 × Ø23   | 27        | 22        | 383       |
| 40   | 175       | 130       | 4 × Ø25   | 32        | 35        | 515       |
| 50   | 185       | 145       | 4 × Ø23   | 34        | 48        | 616       |
| 80   | 230       | 185       | 4 × Ø25   | 40        | 73        | 686       |
| Surface roughness (flange): Ra 3.2 to 6.3 µm   |           |           |           |           |           |           |

- 1) DN 8 with DN 15 flanges as standard

Fixed flange DIN 11864-2

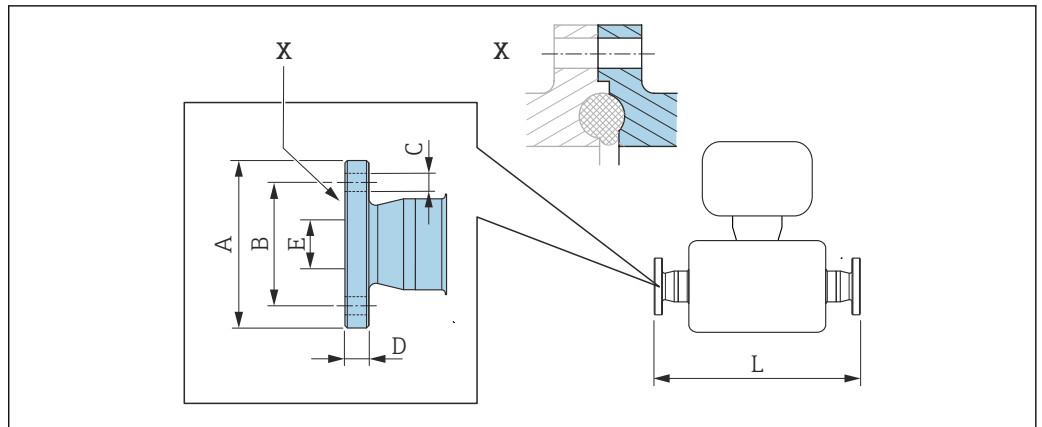

A0015627

28 Detail X: Asymmetrical process connection; the part shown in blue is provided by the supplier.

**i** Length tolerance for dimension L in mm:  
+1.5/-2.0

**Flange DIN11864-2 Form A, for pipe according to DIN11866 series A, flange with notch 1.4404 (316/316L)**

Order code for "Process connection", option KCS

| DN [mm]         | A [mm] | B [mm] | C [mm]  | D [mm] | E [mm] | L [mm] |
|-----------------|--------|--------|---------|--------|--------|--------|
| 8 <sup>1)</sup> | 54     | 37     | 4 × Ø9  | 10     | 10     | 249    |
| 15              | 59     | 42     | 4 × Ø9  | 10     | 16     | 293    |
| 25              | 70     | 53     | 4 × Ø9  | 10     | 26     | 344    |
| 40              | 82     | 65     | 4 × Ø9  | 10     | 38     | 456    |
| 50              | 94     | 77     | 4 × Ø9  | 10     | 50     | 562    |
| 80              | 133    | 112    | 8 × Ø11 | 12     | 81     | 671    |

3-A version available: order code for "Additional approval", option LP in conjunction with  
 Ra ≤ 0.76 µm: order code for "Measuring tube material", option SB, SJ  
 Ra ≤ 0.38 µm: order code for "Measuring tube material", option SC, SK

1) DN 8 with DN 10 flanges as standard

## Clamp connections

### Tri-Clamp

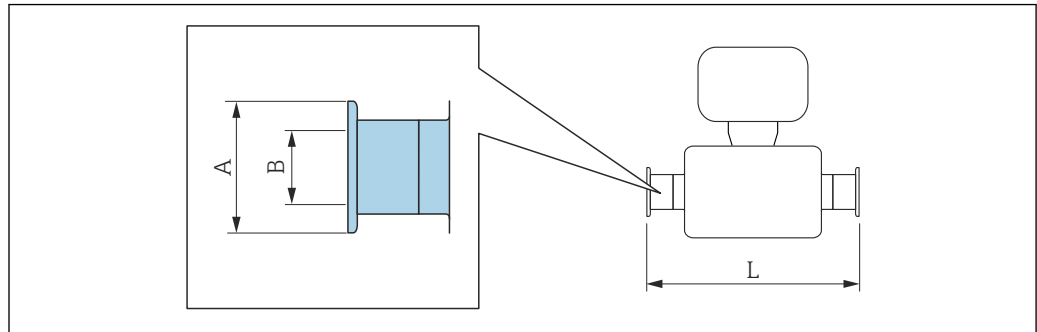

A0015625

**i** Length tolerance for dimension L in mm:  
+1.5/-2.0

#### Tri-Clamp ( $\frac{1}{2}$ " ), for pipe according to DIN 11866 series C 1.4404 (316/316L)

Order code for "Process connection", option FDW

| DN<br>[mm] | Clamp<br>[in] | A<br>[mm] | B<br>[mm] | L<br>[mm] |
|------------|---------------|-----------|-----------|-----------|
| 8          | $\frac{1}{2}$ | 25.0      | 9.5       | 229       |
| 15         | $\frac{1}{2}$ | 25.0      | 9.5       | 273       |

3-A version available: order code for "Additional approval", option LP in conjunction with  
 $Ra \leq 0.76 \mu\text{m}$ : order code for "Measuring tube material", option SB, SJ  
 $Ra \leq 0.38 \mu\text{m}$ : order code for "Measuring tube material", option SC, SK

#### Tri-Clamp ( $\geq 1$ " ), for pipe according to DIN 11866 series C 1.4404 (316/316L)

Order code for "Process connection", option FTS

| DN<br>[mm] | Clamp<br>[in]  | A<br>[mm] | B<br>[mm] | L<br>[mm] |
|------------|----------------|-----------|-----------|-----------|
| 8          | 1              | 50.4      | 22.1      | 229       |
| 15         | 1              | 50.4      | 22.1      | 273       |
| 25         | 1              | 50.4      | 22.1      | 324       |
| 40         | $1\frac{1}{2}$ | 50.4      | 34.8      | 456       |
| 50         | 2              | 63.9      | 47.5      | 562       |
| 80         | 3              | 90.9      | 72.9      | 671       |

3-A version available: order code for "Additional approval", option LP in conjunction with  
 $Ra \leq 0.76 \mu\text{m}$ : order code for "Measuring tube material", option SB, SJ  
 $Ra \leq 0.38 \mu\text{m}$ : order code for "Measuring tube material", option SC, SK

**Threaded couplings**

*Threaded adapter DIN 11851, DIN11864-1, SMS 1145*

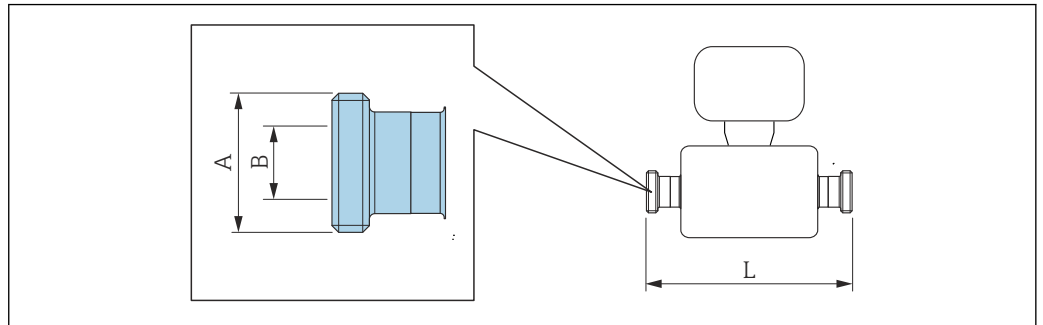

A0015628

**i** Length tolerance for dimension L in mm:  
+1.5/-2.0

| <b>Threaded adapter DIN 11851, for pipe according to DIN11866 series A</b> |                   |                   |                   |
|--|-------------------|-------------------|-------------------|
| <b>1.4404 (316/316L)</b>   |                   |                   |                   |
| <i>Order code for "Process connection", option FMW</i>                     |                   |                   |                   |
| <b>DN<br/>[mm]</b>   | <b>A<br/>[in]</b> | <b>B<br/>[mm]</b> | <b>L<br/>[mm]</b> |
| 8  | Rd 34 × 1/8       | 16                | 229               |
| 15   | Rd 34 × 1/8       | 16                | 273               |
| 25   | Rd 52 × 1/6       | 26                | 324               |
| 40   | Rd 65 × 1/6       | 38                | 456               |
| 50   | Rd 78 × 1/6       | 50                | 562               |
| 80   | Rd 110 × 1/4      | 81                | 671               |

3-A version available: order code for "Additional approval", option LP in conjunction with  
 Ra ≤ 0.76 µm: order code for "Measuring tube material", option SB, SJ  
 Ra ≤ 0.38 µm: order code for "Measuring tube material", option SC, SK

| <b>Threaded adapter DIN11864-1 Form A, for pipe according to DIN11866 series A</b> |                   |                   |                   |
|--|-------------------|-------------------|-------------------|
| <b>1.4404 (316/316L)</b>   |                   |                   |                   |
| <i>Order code for "Process connection", option FLW</i>                             |                   |                   |                   |
| <b>DN<br/>[mm]</b>   | <b>A<br/>[in]</b> | <b>B<br/>[mm]</b> | <b>L<br/>[mm]</b> |
| 8  | Rd 28 × 1/8       | 10                | 229               |
| 15   | Rd 34 × 1/8       | 16                | 273               |
| 25   | Rd 52 × 1/6       | 26                | 324               |
| 40   | Rd 65 × 1/6       | 38                | 456               |
| 50   | Rd 78 × 1/6       | 50                | 562               |
| 80   | Rd 110 × 1/4      | 81                | 671               |

3-A version available: order code for "Additional approval", option LP in conjunction with  
 Ra ≤ 0.76 µm: order code for "Measuring tube material", option SB, SJ  
 Ra ≤ 0.38 µm: order code for "Measuring tube material", option SC, SK

| Threaded adapter SMS 1145<br>1.4404 (316/316L)<br><i>Order code for "Process connection", option SCS</i> |             |           |           |
|--|-------------|-----------|-----------|
| DN<br>[mm]   | A<br>[in]   | B<br>[mm] | L<br>[mm] |
| 8  | Rd 40 × 1/6 | 22.5      | 229       |
| 15   | Rd 40 × 1/6 | 22.5      | 273       |
| 25   | Rd 40 × 1/6 | 22.5      | 324       |
| 40   | Rd 60 × 1/6 | 35.5      | 456       |
| 50   | Rd 70 × 1/6 | 48.5      | 562       |
| 80   | Rd 98 × 1/6 | 72.9      | 671       |

3-A version available: order code for "Additional approval", option LP in conjunction with  
 Ra ≤ 0.76 µm: order code for "Measuring tube material", option SB, SJ  
 Ra ≤ 0.38 µm: order code for "Measuring tube material", option SC, SK

Threaded adapter ISO 2853

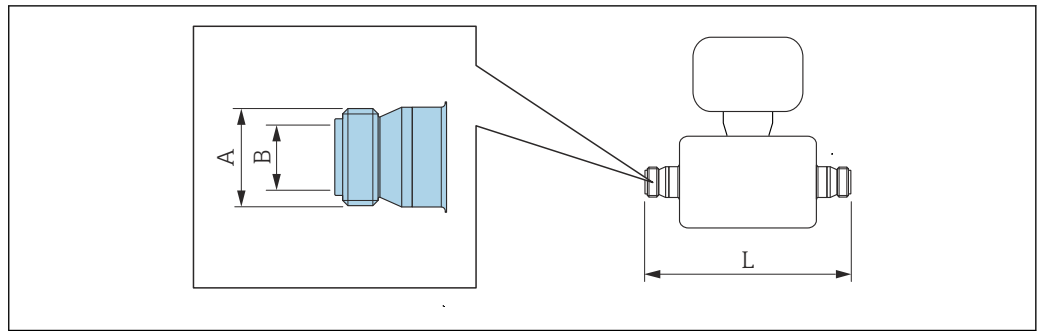

A0015623

 Length tolerance for dimension L in mm:  
+1.5/-2.0

| Threaded adapter ISO 2853, for pipe according to ISO 2037<br>1.4404 (316/316L)<br>Order code for "Process connection", option JSF |                         |           |           |
|---|-------------------------|-----------|-----------|
| DN<br>[mm]  | A <sup>1)</sup><br>[mm] | B<br>[mm] | L<br>[mm] |
| 8   | 37.13                   | 22.6      | 229       |
| 15  | 37.13                   | 22.6      | 273       |
| 25  | 37.13                   | 22.6      | 324       |
| 40  | 50.68                   | 35.6      | 456       |
| 50  | 64.16                   | 48.6      | 562       |
| 80  | 91.19                   | 72.9      | 671       |

3-A version available: order code for "Additional approval", option LP in conjunction with  
 Ra ≤ 0.76 µm: order code for "Measuring tube material", option SB, SJ  
 Ra ≤ 0.38 µm: order code for "Measuring tube material", option SC, SK

1) Max. thread diameter according to ISO 2853 Annex A

VCO

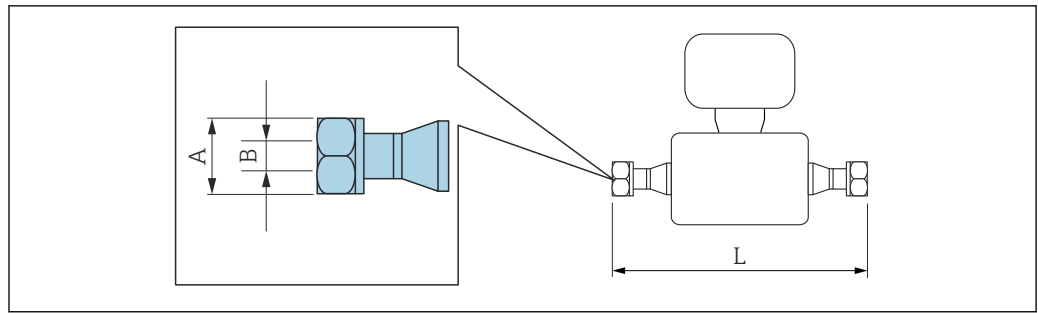

A0015624

**i** Length tolerance for dimension L in mm:  
+1.5/-2.0

| 8-VCO-4 (½")<br>1.4404 (316/316L)<br>Order code for "Process connection", option CVS |        |        |        |
|--|--------|--------|--------|
| DN [mm]  | A [in] | B [mm] | L [mm] |
| 8  | AF 1   | 10.2   | 252    |

| 12-VCO-4 (¾")<br>1.4404 (316/316L)<br>Order code for "Process connection", option CWS |        |        |        |
|---|--------|--------|--------|
| DN [mm]   | A [in] | B [mm] | L [mm] |
| 15  | AF 1½  | 15.7   | 305    |

Accessories

Protective cover

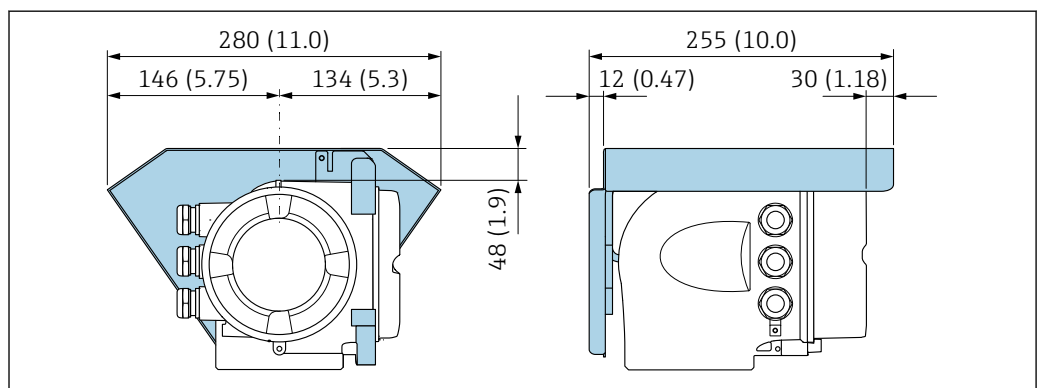

A0029553

**29** Unit mm (in)

Remote display and operating module DKX001

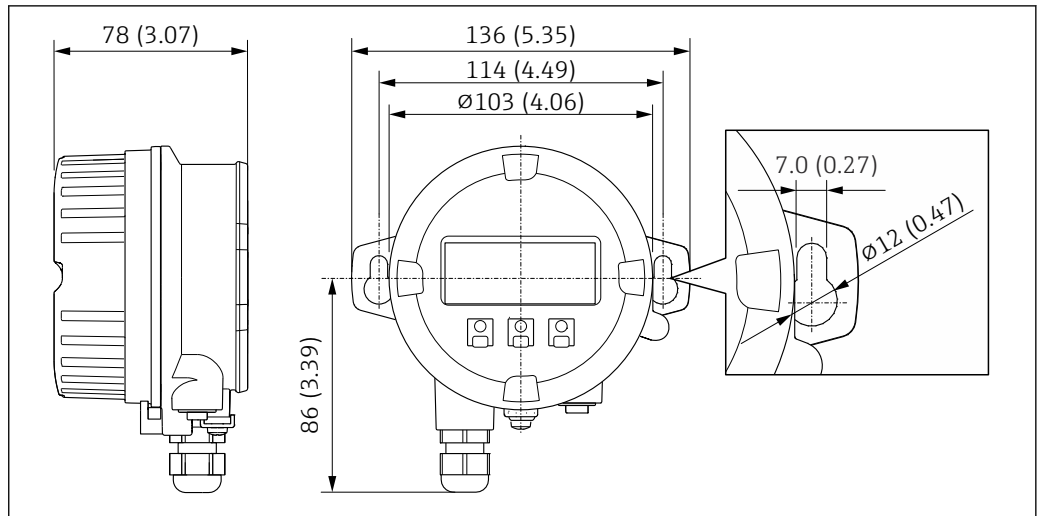

A0028921

30 Unit mm (in)

External WLAN antenna

**i** The external WLAN antenna is not suitable for use in hygienic applications.

External WLAN antenna mounted on device

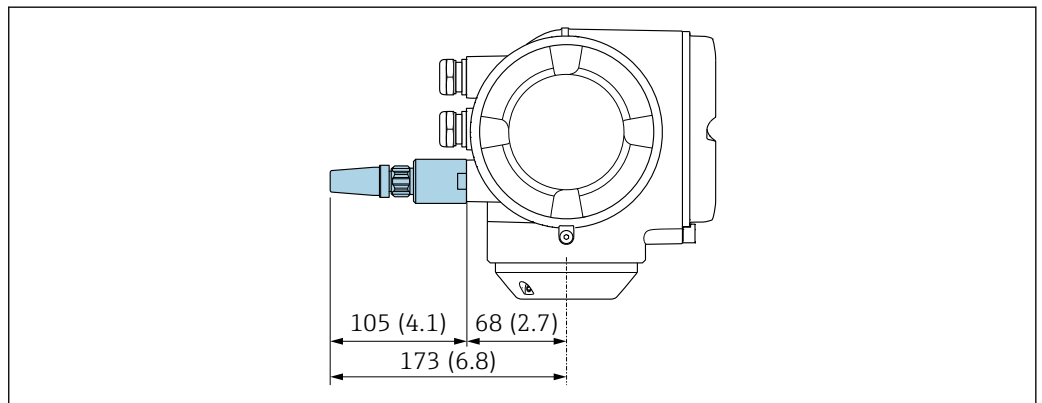

A0028923

31 Unit mm (in)

External WLAN antenna mounted with cable

The external WLAN antenna can be mounted separately from the transmitter if the transmission/reception conditions at the transmitter mounting location are poor.

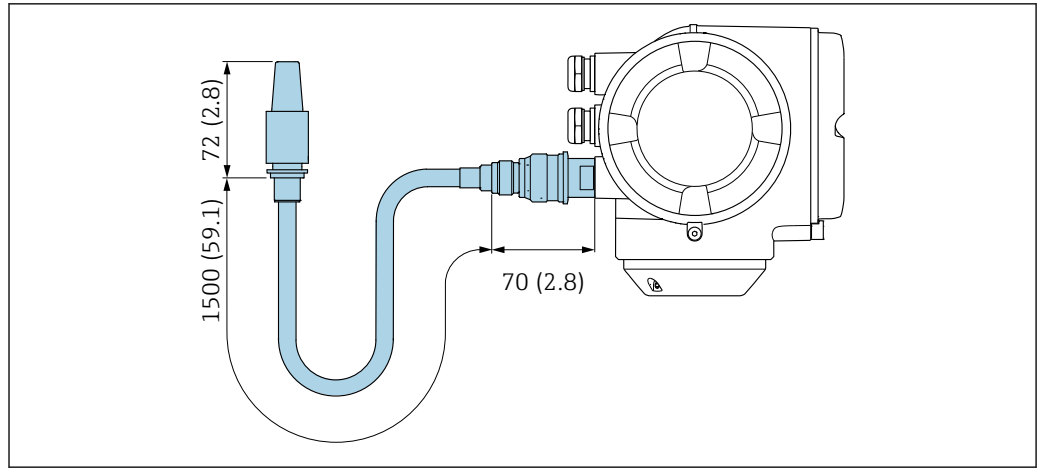

A0033597

32 Unit mm (in)

Dimensions in US units

Compact version

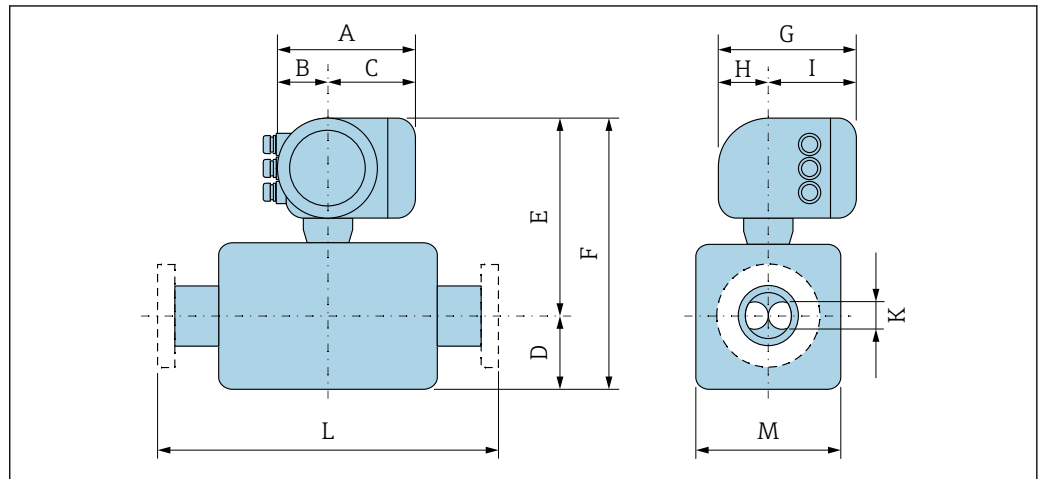

A0033786

Order code for "Housing", option A "Aluminum, coated"

| DN    | A <sup>1)</sup> | B <sup>1)</sup> | C    | D    | E     | F     | G <sup>2)</sup> | H    | I <sup>2)</sup> | K    | L             | M    |
|-------|-----------------|-----------------|------|------|-------|-------|-----------------|------|-----------------|------|---------------|------|
| [in]  | [in]            | [in]            | [in] | [in] | [in]  | [in]  | [in]            | [in] | [in]            | [in] | [in]          | [in] |
| 3/8   | 6.65            | 2.68            | 3.98 | 3.5  | 9.92  | 13.43 | 7.87            | 2.32 | 5.55            | 0.21 | <sup>3)</sup> | 1.77 |
| 1/2   | 6.65            | 2.68            | 3.98 | 3.94 | 9.92  | 13.86 | 7.87            | 2.32 | 5.55            | 0.33 | <sup>3)</sup> | 1.77 |
| 1     | 6.65            | 2.68            | 3.98 | 4.02 | 9.8   | 13.82 | 7.87            | 2.32 | 5.55            | 0.47 | <sup>3)</sup> | 2.01 |
| 1 1/2 | 6.65            | 2.68            | 3.98 | 4.76 | 10.04 | 14.8  | 7.87            | 2.32 | 5.55            | 0.69 | <sup>3)</sup> | 2.56 |
| 2     | 6.65            | 2.68            | 3.98 | 6.91 | 10.61 | 17.52 | 7.87            | 2.32 | 5.55            | 1.02 | <sup>3)</sup> | 3.74 |
| 3     | 6.65            | 2.68            | 3.98 | 8.07 | 11.36 | 19.43 | 7.87            | 2.32 | 5.55            | 1.59 | <sup>3)</sup> | 5.00 |

- 1) Depending on the cable gland used: values up to + 1.18 in
- 2) For version without local display: values - 1.18 in
- 3) Depending on the process connection

Order code for "Housing", option A "Aluminum, coated"; Ex d

| DN    | A <sup>1)</sup> | B <sup>1)</sup> | C    | D    | E     | F     | G <sup>2)</sup> | H    | I <sup>2)</sup> | K    | L             | M    |
|-------|-----------------|-----------------|------|------|-------|-------|-----------------|------|-----------------|------|---------------|------|
| [in]  | [in]            | [in]            | [in] | [in] | [in]  | [in]  | [in]            | [in] | [in]            | [in] | [in]          | [in] |
| 3/8   | 7.40            | 3.35            | 4.06 | 3.5  | 9.96  | 13.46 | 8.54            | 2.28 | 6.26            | 0.21 | <sup>3)</sup> | 1.77 |
| 1/2   | 7.40            | 3.35            | 4.06 | 3.94 | 9.96  | 13.9  | 8.54            | 2.28 | 6.26            | 0.33 | <sup>3)</sup> | 1.77 |
| 1     | 7.40            | 3.35            | 4.06 | 4.02 | 9.84  | 13.86 | 8.54            | 2.28 | 6.26            | 0.47 | <sup>3)</sup> | 2.01 |
| 1 1/2 | 7.40            | 3.35            | 4.06 | 4.76 | 10.08 | 14.84 | 8.54            | 2.28 | 6.26            | 0.69 | <sup>3)</sup> | 2.56 |
| 2     | 7.40            | 3.35            | 4.06 | 6.91 | 10.63 | 17.54 | 8.54            | 2.28 | 6.26            | 1.02 | <sup>3)</sup> | 3.74 |
| 3     | 7.40            | 3.35            | 4.06 | 8.07 | 11.38 | 19.45 | 8.54            | 2.28 | 6.26            | 1.59 | <sup>3)</sup> | 5.00 |

- 1) Depending on the cable gland used: values up to + 1.18 in
- 2) For version without local display: values - 1.57 in
- 3) Depending on the process connection

Order code for "Housing", option B "Stainless, hygienic"

| DN<br>[in]    | A <sup>1)</sup><br>[in] | B <sup>1)</sup><br>[in] | C<br>[in] | D<br>[in] | E<br>[in] | F<br>[in] | G <sup>2)</sup><br>[in] | H<br>[in] | I <sup>2)</sup><br>[in] | K<br>[in] | L<br>[in]     | M<br>[in] |
|---------------|-------------------------|-------------------------|-----------|-----------|-----------|-----------|-------------------------|-----------|-------------------------|-----------|---------------|-----------|
| $\frac{3}{8}$ | 7.20                    | 2.87                    | 4.33      | 3.5       | 9.92      | 13.43     | 7.87                    | 2.56      | 5.31                    | 0.21      | <sup>3)</sup> | 1.77      |
| $\frac{1}{2}$ | 7.20                    | 2.87                    | 4.33      | 3.94      | 9.92      | 13.86     | 7.87                    | 2.56      | 5.31                    | 0.33      | <sup>3)</sup> | 1.77      |
| 1             | 7.20                    | 2.87                    | 4.33      | 4.02      | 9.8       | 13.82     | 7.87                    | 2.56      | 5.31                    | 0.47      | <sup>3)</sup> | 2.01      |
| 1½            | 7.20                    | 2.87                    | 4.33      | 4.76      | 10.04     | 14.8      | 7.87                    | 2.56      | 5.31                    | 0.69      | <sup>3)</sup> | 2.56      |
| 2             | 7.20                    | 2.87                    | 4.33      | 6.91      | 10.61     | 17.52     | 7.87                    | 2.56      | 5.31                    | 1.02      | <sup>3)</sup> | 3.74      |
| 3             | 7.20                    | 2.87                    | 4.33      | 8.07      | 11.36     | 19.43     | 7.87                    | 2.56      | 5.31                    | 1.59      | <sup>3)</sup> | 5.00      |

- 1) Depending on the cable gland used: values up to + 1.18 in  
 2) For version without local display: values - 0.51 in  
 3) Depending on the process connection

**Flange connections**

*Fixed flange ASME B16.5*

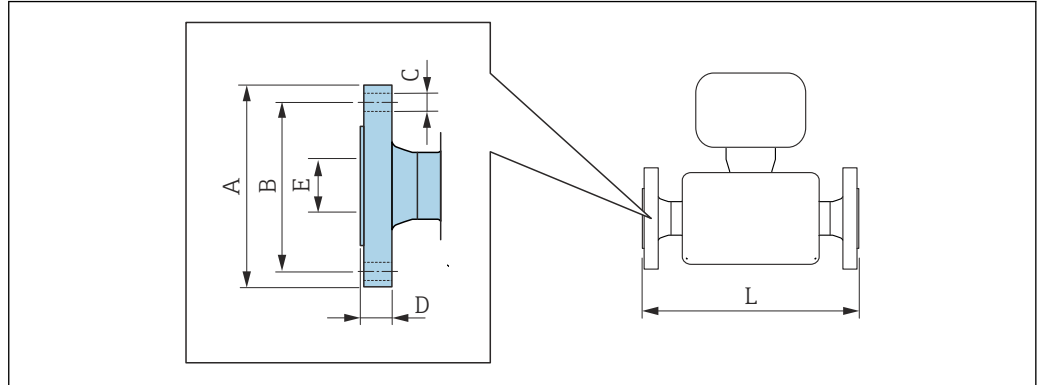

A0015621

**i** Length tolerance for dimension L in inches:  
+0.06/-0.08

**Flange similar to ASME B16.5, CI 150**  
**1.4404 (F316/F316L)**  
*Order code for "Process connection", option AAS*

| DN [in]                     | A [in] | B [in] | C [in]    | D [in] | E [in] | L [in] |
|-----------------------------|--------|--------|-----------|--------|--------|--------|
| $\frac{3}{8}$ <sup>1)</sup> | 3.54   | 2.37   | 4 × Ø0.62 | 0.44   | 0.62   | 9.13   |
| $\frac{1}{2}$               | 3.54   | 2.37   | 4 × Ø0.62 | 0.44   | 0.62   | 10.98  |
| 1                           | 4.33   | 3.13   | 4 × Ø0.62 | 0.56   | 1.05   | 12.95  |
| 1½                          | 4.92   | 3.87   | 4 × Ø0.62 | 0.69   | 1.61   | 17.52  |
| 2                           | 5.91   | 4.75   | 4 × Ø0.75 | 0.75   | 2.07   | 21.89  |
| 3                           | 7.48   | 6.00   | 4 × Ø0.75 | 0.94   | 3.07   | 24.06  |

Surface roughness (flange): Ra 126 to 248 µin

1) DN  $\frac{3}{8}$ " with DN  $\frac{1}{2}$ " flanges as standard

**Flange similar to ASME B16.5, Class 300**  
**1.4404 (F316/F316L)**  
*Order code for "Process connection", option ABS*

| DN [in]                     | A [in] | B [in] | C [in]    | D [in] | E [in] | L [in] |
|-----------------------------|--------|--------|-----------|--------|--------|--------|
| $\frac{3}{8}$ <sup>1)</sup> | 3.74   | 2.63   | 4 × Ø0.62 | 0.56   | 0.62   | 9.13   |
| $\frac{1}{2}$               | 3.74   | 2.63   | 4 × Ø0.62 | 0.56   | 0.62   | 10.98  |
| 1                           | 4.92   | 3.50   | 4 × Ø0.75 | 0.69   | 1.05   | 12.95  |
| 1½                          | 6.10   | 4.50   | 4 × Ø0.88 | 0.81   | 1.61   | 17.52  |
| 2                           | 6.50   | 5.00   | 8 × Ø0.75 | 0.88   | 2.07   | 21.89  |
| 3                           | 8.27   | 6.63   | 8 × Ø0.88 | 1.12   | 3.07   | 24.06  |

Surface roughness (flange): Ra 126 to 248 µin

1) DN  $\frac{3}{8}$ " with DN  $\frac{1}{2}$ " flanges as standard

| <b>Flange similar to ASME B16.5, Class 600</b><br><b>1.4404 (F316/F316L)</b><br><i>Order code for "Process connection", option ACS</i> |           |           |           |           |           |           |
|--|-----------|-----------|-----------|-----------|-----------|-----------|
| DN<br>[in]   | A<br>[in] | B<br>[in] | C<br>[in] | D<br>[in] | E<br>[in] | L<br>[in] |
| $\frac{3}{8}$ <sup>1)</sup>  | 3.74      | 2.63      | 4 × Ø0.62 | 0.81      | 0.55      | 10.28     |
| $\frac{1}{2}$  | 3.74      | 2.63      | 4 × Ø0.62 | 0.81      | 0.55      | 11.61     |
| 1  | 4.92      | 3.50      | 4 × Ø0.75 | 0.94      | 0.96      | 14.96     |
| 1½   | 6.10      | 4.50      | 4 × Ø0.88 | 1.13      | 1.50      | 19.53     |
| 2  | 6.50      | 5.00      | 8 × Ø0.75 | 1.25      | 1.94      | 22.95     |
| 3  | 8.27      | 6.63      | 8 × Ø0.88 | 1.50      | 2.9       | 26.42     |
| Surface roughness (flange): Ra 126 to 248 µin  |           |           |           |           |           |           |

1) DN  $\frac{3}{8}$ " with DN  $\frac{1}{2}$ " flanges as standard

**Clamp connections**

*Tri-Clamp*

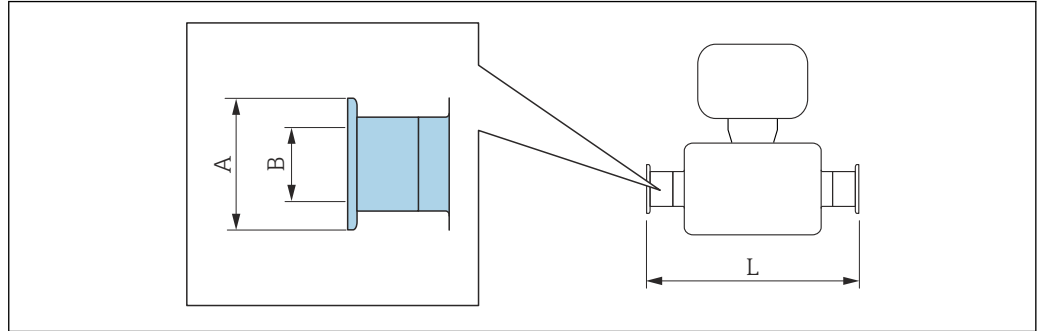

A0015625

 Length tolerance for dimension L in inches:  
+0.06/-0.08

| <b>Tri-Clamp (½"), DIN 11866 series C</b>              |               |           |           |           |
|--|---------------|-----------|-----------|-----------|
| <b>1.4404 (316/316L)</b>                               |               |           |           |           |
| <i>Order code for "Process connection", option FDW</i> |               |           |           |           |
| DN<br>[in]   | Clamp<br>[in] | A<br>[in] | B<br>[in] | L<br>[in] |
| ¾  | ½             | 0.98      | 0.37      | 9.02      |
| ½  | ½             | 0.98      | 0.37      | 10.75     |

3-A version available: order code for "Additional approval", option LP in conjunction with  
 Ra ≤ 30 µin: order code for "Measuring tube material", option SB, SJ  
 Ra ≤ 15 µin: order code for "Measuring tube material", option SC, SK

| <b>Tri-Clamp (≥ 1"), DIN 11866 series C</b>            |               |           |           |           |
|--|---------------|-----------|-----------|-----------|
| <b>1.4404 (316/316L)</b>                               |               |           |           |           |
| <i>Order code for "Process connection", option FTS</i> |               |           |           |           |
| DN<br>[in]   | Clamp<br>[in] | A<br>[in] | B<br>[in] | L<br>[in] |
| ¾  | 1             | 1.98      | 0.87      | 9.02      |
| ½  | 1             | 1.98      | 0.87      | 10.75     |
| 1  | 1             | 1.98      | 0.87      | 12.76     |
| 1½   | 1½            | 1.98      | 1.37      | 17.95     |
| 2  | 2             | 2.52      | 1.87      | 22.13     |
| 3  | 3             | 3.58      | 2.87      | 26.42     |

3-A version available: order code for "Additional approval", option LP in conjunction with  
 Ra ≤ 30 µin: order code for "Measuring tube material", option SB, SJ  
 Ra ≤ 15 µin: order code for "Measuring tube material", option SC, SK

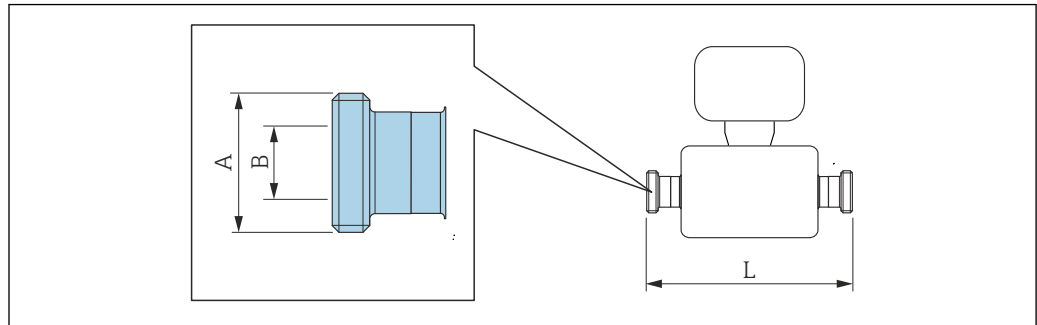
**Threaded couplings***Threaded adapter SMS 1145*

A0015628

**i** Length tolerance for dimension L in inches:  
+0.06/-0.08

**Threaded adapter SMS 1145****1.4404 (316/316L)***Order code for "Process connection", option SCS*

| DN<br>[in]    | A<br>[in]             | B<br>[in] | L<br>[in] |
|---------------|-----------------------|-----------|-----------|
| $\frac{3}{8}$ | Rd 40 × $\frac{1}{6}$ | 0.89      | 9.02      |
| $\frac{1}{2}$ | Rd 40 × $\frac{1}{6}$ | 0.89      | 10.75     |
| 1             | Rd 40 × $\frac{1}{6}$ | 0.89      | 12.76     |
| 1½            | Rd 60 × $\frac{1}{6}$ | 1.40      | 17.95     |
| 2             | Rd 70 × $\frac{1}{6}$ | 1.91      | 22.13     |
| 3             | Rd 98 × $\frac{1}{6}$ | 2.87      | 26.42     |

3-A version available: order code for "Additional approval", option LP in conjunction with  
 Ra ≤ 30 µin: order code for "Measuring tube material", option SB, SJ  
 Ra ≤ 15 µin: order code for "Measuring tube material", option SC, SK

VCO

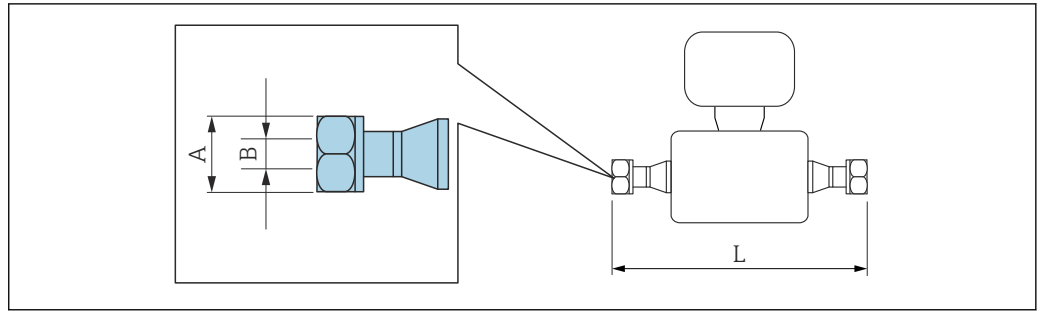

A0015624

**i** Length tolerance for dimension L in inches:  
+0.06/-0.08

| 8-VCO-4 (1/2")<br>1.4404 (316/316L)<br>Order code for "Process connection", option CVS |           |           |           |
|--|-----------|-----------|-----------|
| DN<br>[in]   | A<br>[in] | B<br>[in] | L<br>[in] |
| 3/8  | AF 1      | 0.40      | 9.92      |

| 12-VCO-4 (3/4")<br>1.4404 (316/316L)<br>Order code for "Process connection", option CWS |           |           |           |
|---|-----------|-----------|-----------|
| DN<br>[in]  | A<br>[in] | B<br>[in] | L<br>[in] |
| 1/2   | AF 1 1/2  | 0.62      | 12.01     |

Accessories

Protective cover

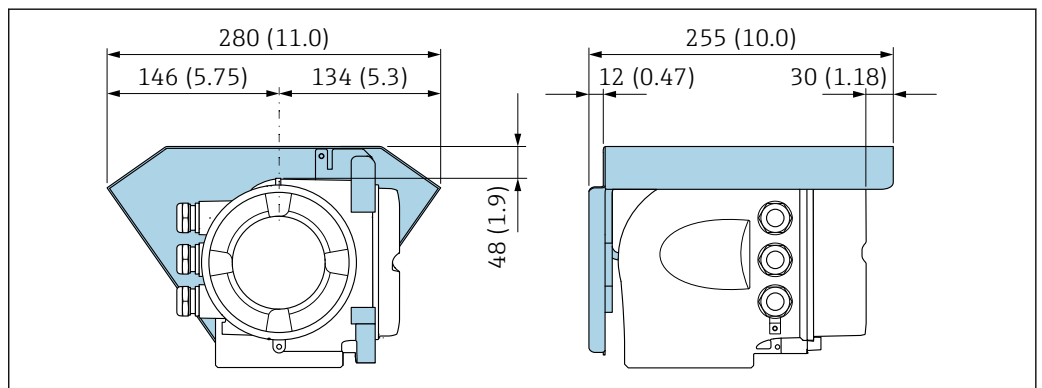

A0029553

**33** Unit mm (in)

## Remote display and operating module DKX001

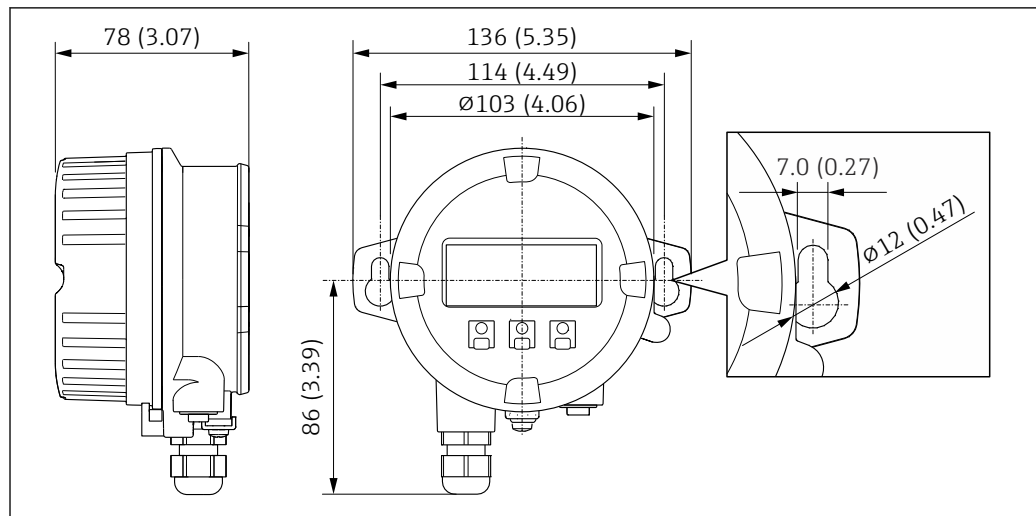

A0028921

34 Unit mm (in)

## External WLAN antenna

**i** The external WLAN antenna is not suitable for use in hygienic applications.

## External WLAN antenna mounted on device

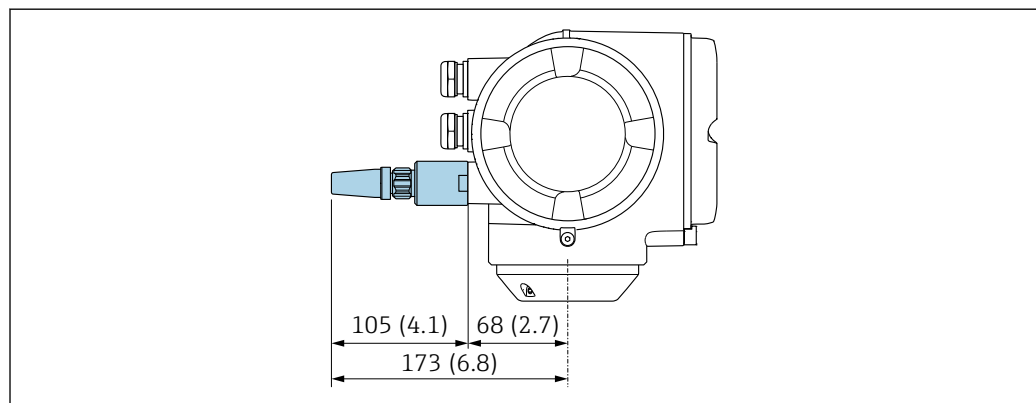

A0028923

35 Unit mm (in)

## External WLAN antenna mounted with cable

The external WLAN antenna can be mounted separately from the transmitter if the transmission/reception conditions at the transmitter mounting location are poor.

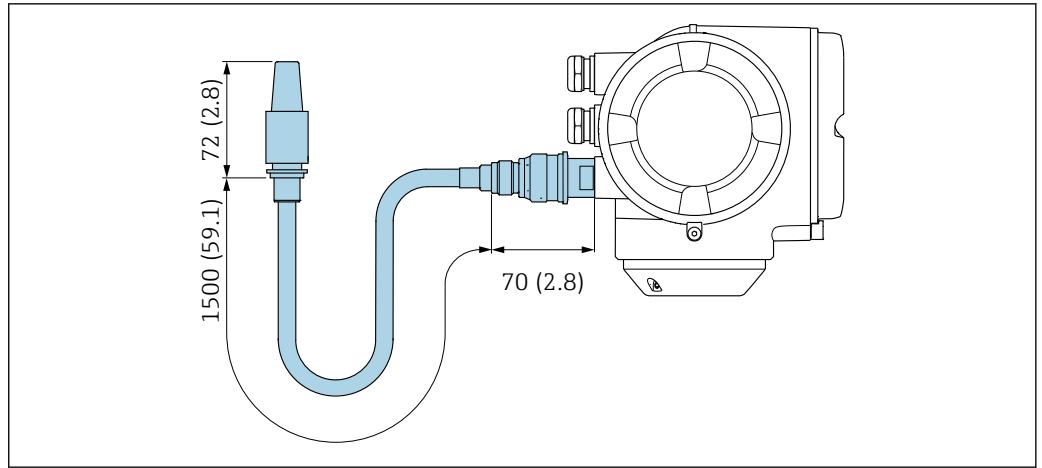

A0033597

36 Unit mm (in)

**Weight**

All values (weight exclusive of packaging material) refer to devices with EN/DIN PN 40 flanges. Weight specifications including transmitter as per order code for "Housing", option A "Aluminum, coated".

Different values due to different transmitter versions:

- Transmitter version for the hazardous area  
(Order code for "Housing", option A "Aluminum, coated"; Ex d): +2 kg (+4.4 lbs)
- Transmitter version for hygienic area  
(Order code for "Housing", option B "Stainless, hygienic"): +0.2 kg (+0.44 lbs)

**Weight in SI units**

| DN [mm] | Weight [kg] |
|---------|-------------|
| 8       | 5           |
| 15      | 5.5         |
| 25      | 7           |
| 40      | 11          |
| 50      | 16          |
| 80      | 32          |

**Weight in US units**

| DN [in] | Weight [lbs] |
|---------|--------------|
| 3/8     | 11           |
| 1/2     | 12           |
| 1       | 15           |
| 1 1/2   | 24           |
| 2       | 35           |
| 3       | 71           |

**Materials**

**Transmitter housing**

Order code for "Housing":

- Option A "Aluminum, coated": aluminum, AlSi10Mg, coated
- Option B "Stainless, hygienic": stainless steel, 1.4404 (316L)

*Window material*

Order code for "Housing":

- Option **A** "Aluminum, coated": glass
- Option **B** "Stainless, hygienic": polycarbonate

*Seals*

Order code for "Housing":

Option **B** "Stainless, hygienic": EPDM and silicone

**Cable entries/cable glands**

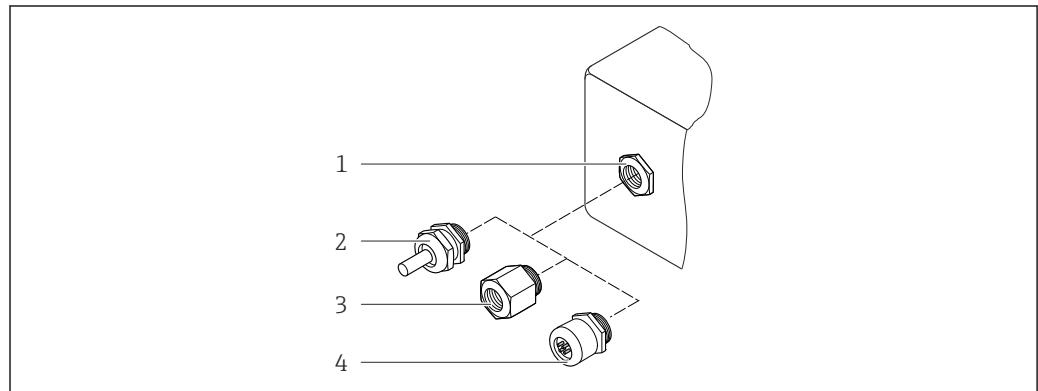

A0028352

37 Possible cable entries/cable glands

- 1 Internal thread M20 × 1.5
- 2 Cable gland M20 × 1.5
- 3 Adapter for cable entry with internal thread G ½" or NPT ½"
- 4 Device plug

Order code for "Housing", option A "Aluminum, coated"

The various cable entries are suitable for hazardous and non-hazardous areas.

| Cable entry/cable gland                             | Material                            |
|---|-------------------------------------|
| Gland M20 × 1.5                                     | Non-Ex: plastic                     |
|   | Z2, D2, Ex d/de: brass with plastic |
| Adapter for cable entry with internal thread G ½"   | Nickel-plated brass                 |
| Adapter for cable entry with internal thread NPT ½" |                                     |

Order code for "Housing", option B "Stainless, hygienic"

The various cable entries are suitable for hazardous and non-hazardous areas.

| Cable entry/cable gland                             | Material            |
|---|---------------------|
| Cable gland M20 × 1.5                               | Plastic             |
| Adapter for cable entry with internal thread G ½"   | Nickel-plated brass |
| Adapter for cable entry with internal thread NPT ½" |                     |

**Device plug**

| Electrical connection | Material  |
|-----------------------|---|
| Plug M12x1            | <ul style="list-style-type: none"> <li>▪ Socket: Stainless steel, 1.4404 (316L)</li> <li>▪ Contact housing: Polyamide</li> <li>▪ Contacts: Gold-plated brass</li> </ul> |

**Sensor housing**



- Acid and alkali-resistant outer surface
- Stainless steel 1.4301 (304)

**Measuring tubes**

Stainless steel, 1.4539 (904L); manifold: stainless steel, 1.4404 (316L)

**Process connections**

- Flanges similar to EN 1092-1 (DIN2501) / similar to ASME B 16.5 / as per JIS B2220: Stainless steel, 1.4404 (F316/F316L)
- All other process connections: Stainless steel, 1.4404 (316/316L)

 Available process connections →  91

**Seals**

Welded process connections without internal seals

**Accessories**

*Protective cover*

Stainless steel, 1.4404 (316L)

*External WLAN antenna*

- Antenna: ASA plastic (acrylonitrile styrene acrylate) and nickel-plated brass
- Adapter: Stainless steel and nickel-plated brass
- Cable: Polyethylene
- Plug: Nickel-plated brass
- Angle bracket: Stainless steel

**Process connections**

- Fixed flange connections:
  - EN 1092-1 (DIN 2501) flange
  - EN 1092-1 (DIN 2512N) flange
  - NAMUR lengths in accordance with NE 132
  - ASME B16.5 flange
  - JIS B2220 flange
  - DIN 11864-2 Form A flange, DIN 11866 series A, flange with notch
- Clamp connections: Tri-Clamp (OD tubes), DIN 11866 series C
- Thread:
  - DIN 11851 thread, DIN 11866 series A
  - SMS 1145 thread
  - ISO 2853 thread, ISO 2037
  - DIN 11864-1 Form A thread, DIN 11866 series A
- VCO connections:
  - 8-VCO-4
  - 12-VCO-4

 Process connection materials →  91

**Surface roughness**

All data relate to parts in contact with medium.

*The following surface roughness categories can be ordered:*

| Category                            | Method                              | Option(s)/Order code "Measuring tube mat., wetted surface" |
|-------------------------------------|-------------------------------------|--|
| Not polished                        | -                                   | SA   |
| Ra ≤ 0.76 µm (30 µin) <sup>1)</sup> | Mechanically polished <sup>2)</sup> | SB   |

| Category  | Method  | Option(s)/Order code<br>"Measuring tube mat., wetted<br>surface" |
|---|---|--|
| $Ra \leq 0.76 \mu\text{m}$ (30 $\mu\text{in}$ ) <sup>1)</sup> | Mechanically polished <sup>2)</sup> , welds in<br>as-welded condition | SJ   |
| $Ra \leq 0.38 \mu\text{m}$ (15 $\mu\text{in}$ ) <sup>1)</sup> | Mechanically polished <sup>2)</sup>                                   | SC   |
| $Ra \leq 0.38 \mu\text{m}$ (15 $\mu\text{in}$ ) <sup>1)</sup> | Mechanically polished <sup>2)</sup> , welds in<br>as-welded condition | SK   |

1) Ra according to ISO 21920

2) Inaccessible weld seams between pipe and manifold are excluded

## Operability

### Operation concept

#### Operator-oriented menu structure for user-specific tasks

- Commissioning
- Operation
- Diagnosis
- Expert level

#### Quick and safe commissioning

- Guided menus ("Make-it-run" wizards) for applications
- Menu guidance with brief descriptions of the individual parameter functions
- Access to the device via web server
- WLAN access to the device via mobile handheld terminal, tablet or smart phone

#### Reliable operation

- Operation in local language
- Uniform operating philosophy applied to device and operating tools
- If replacing electronic modules, transfer the device configuration via the integrated memory (HistoROM backup) which contains the process and measuring device data and the event logbook. No need to reconfigure.

#### Efficient diagnostics increase measurement reliability

- Troubleshooting measures can be called up via the device and in the operating tools
- Diverse simulation options, logbook for events that occur and optional line recorder functions

### Languages

Can be operated in the following languages:

- Via local operation  
English, German, French, Spanish, Italian, Dutch, Portuguese, Polish, Russian, Turkish, Chinese, Japanese, Korean, Vietnamese, Czech, Swedish
- Via web browser  
English, German, French, Spanish, Italian, Dutch, Portuguese, Polish, Russian, Turkish, Chinese, Japanese, Vietnamese, Czech, Swedish
- Via "FieldCare", "DeviceCare" operating tool: English, German, French, Spanish, Italian, Chinese, Japanese

### Local operation

#### Via display module

Equipment level:

- Order code for "Display; operation", option F "4-line, illuminated, graphic display; touch control"
- Order code for "Display; operation", option G "4-line, illuminated, graphic display; touch control + WLAN"

 Information about WLAN interface →  101

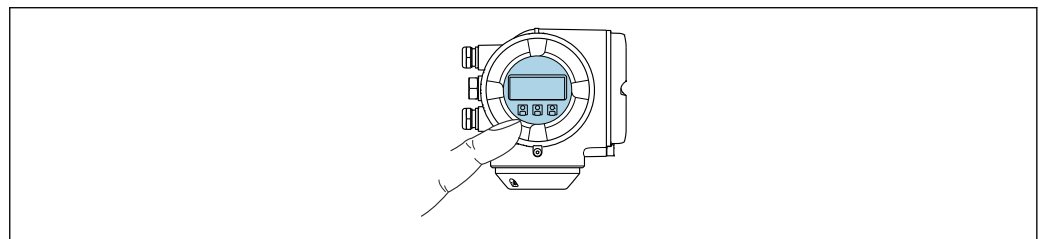

 38 Operation with touch control

#### Display elements

- 4-line, illuminated, graphic display
- White background lighting; switches to red in event of device errors
- Format for displaying measured variables and status variables can be individually configured

#### Operating elements

- External operation via touch control (3 optical keys) without opening the housing: , , 
- Operating elements also accessible in the various zones of the hazardous area

### Via remote display and operating module DKX001

- i** The remote display and operating module DKX001 is available as an optional extra →  112..
- The remote display and operating module DKX001 is only available for the following housing version: order code for "Housing": option A "Aluminum, coated"
  - The measuring instrument is always supplied with a dummy cover when the remote display and operating module DKX001 is ordered directly with the measuring instrument. Display or operation at the transmitter is not possible in this case.
  - If ordered subsequently, the remote display and operating module DKX001 may not be connected at the same time as the existing measuring instrument display module. Only one display or operation unit may be connected to the transmitter at any one time.

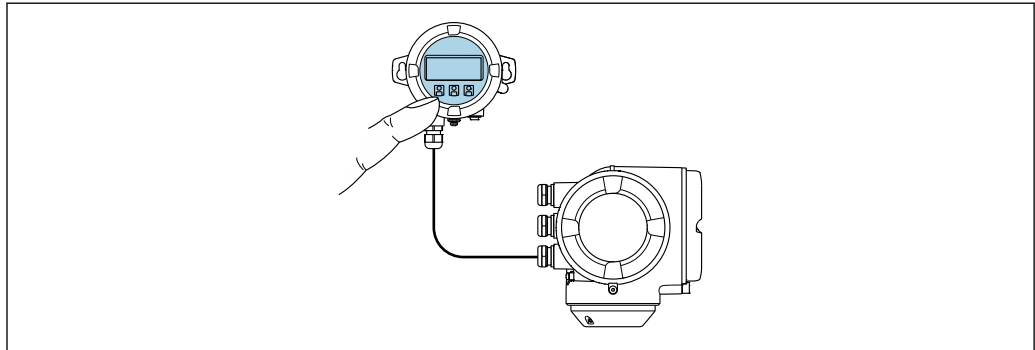

A0026786

 39 Operation via remote display and operating module DKX001

#### Display and operating elements

The display and operating elements correspond to those of the display module →  93.

#### Housing material

The housing material of the display and operating module DKX001 depends on the choice of transmitter housing material.

| Transmitter housing         |                  | Remote display and operating module |
|-----------------------------|------------------|-------------------------------------|
| Order code for "Housing"    | Material         | Material                            |
| Option A "Aluminum, coated" | AlSi10Mg, coated | AlSi10Mg, coated                    |

#### Cable entry

Corresponds to the choice of transmitter housing, order code for "Electrical connection".

#### Connecting cable

→  50

#### Dimensions

→  79

## Remote operation

### Via HART protocol

This communication interface is available in device versions with a HART output.

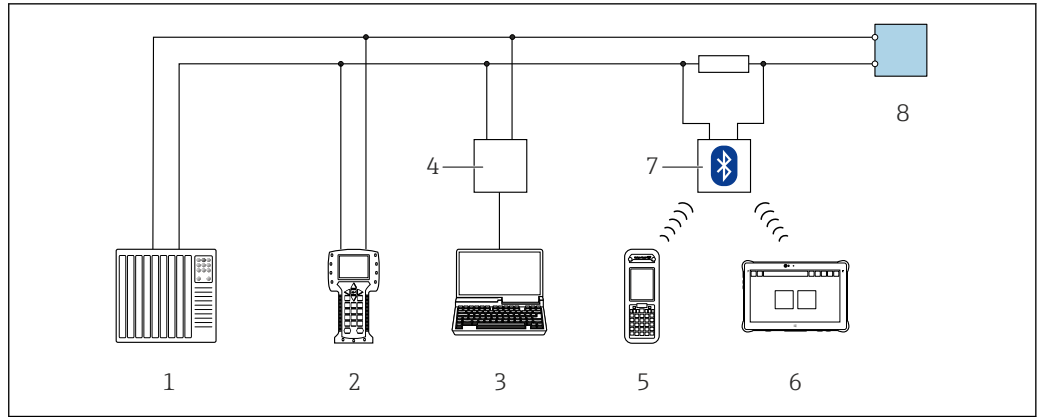

A0028747

40 Options for remote operation via HART protocol (active)

- 1 Automation system (e.g. PLC)
- 2 Field Communicator 475
- 3 Computer with web browser for accessing the integrated device web server or computer with operating tool (e.g. FieldCare, DeviceCare, AMS Device Manager, SIMATIC PDM) with COM DTM "CDI Communication TCP/IP"
- 4 Commubox FXA195 (USB)
- 5 Field Xpert SFX350 or SFX370
- 6 Field Xpert SMT70
- 7 VIATOR Bluetooth modem with connection cable
- 8 Transmitter

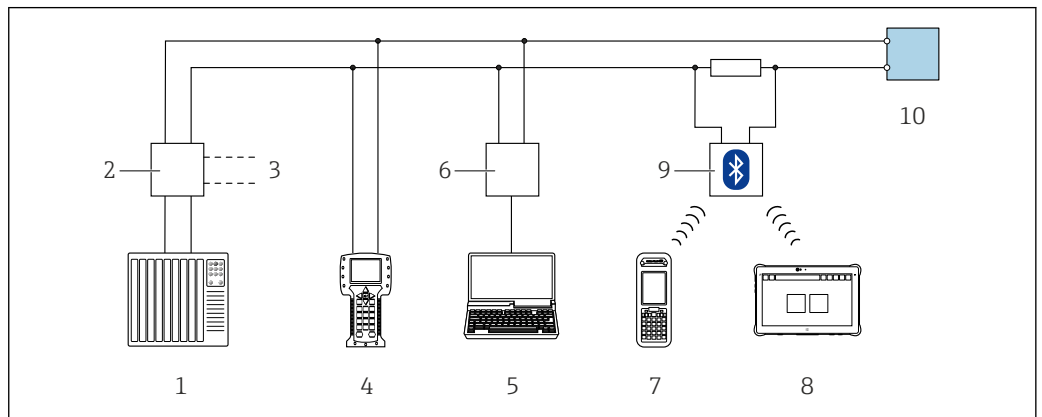

A0028746

41 Options for remote operation via HART protocol (passive)

- 1 Automation system (e.g. PLC)
- 2 Transmitter power supply unit, e.g. RN221N (with communication resistor)
- 3 Connection for Commubox FXA195 and Field Communicator 475
- 4 Field Communicator 475
- 5 Computer with web browser for accessing the integrated device web server or computer with operating tool (e.g. FieldCare, DeviceCare, AMS Device Manager, SIMATIC PDM) with COM DTM "CDI Communication TCP/IP"
- 6 Commubox FXA195 (USB)
- 7 Field Xpert SFX350 or SFX370
- 8 Field Xpert SMT70
- 9 VIATOR Bluetooth modem with connection cable
- 10 Transmitter

**Via FOUNDATION Fieldbus network**

This communication interface is available in device versions with FOUNDATION Fieldbus.

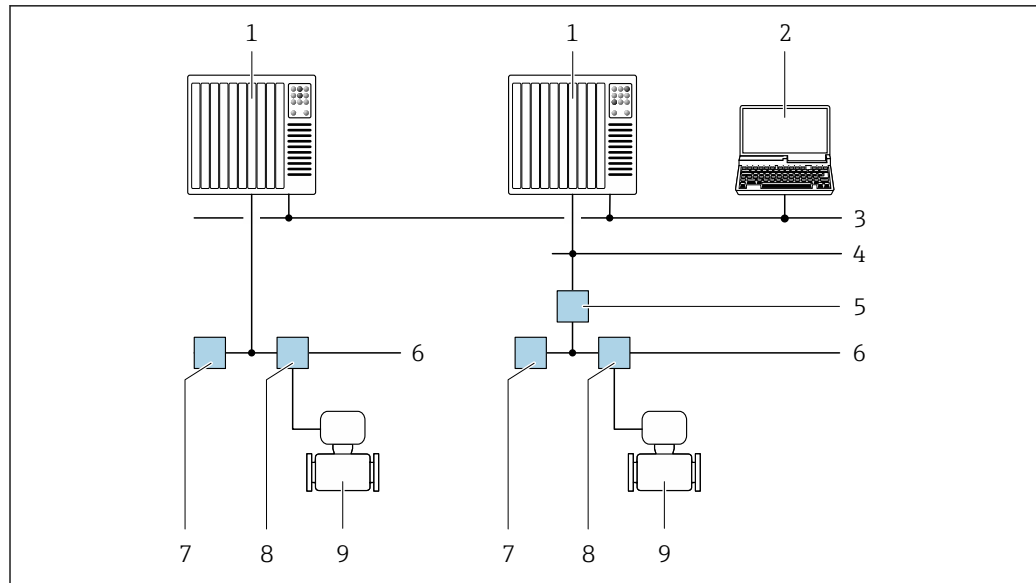

A0028837

▣ 42 Options for remote operation via FOUNDATION Fieldbus network

- 1 Automation system
- 2 Computer with FOUNDATION Fieldbus network card
- 3 Industry network
- 4 High Speed Ethernet FF-HSE network
- 5 Segment coupler FF-HSE/FF-H1
- 6 FOUNDATION Fieldbus FF-H1 network
- 7 Power supply FF-H1 network
- 8 T-box
- 9 Measuring instrument

#### Via PROFIBUS DP network

This communication interface is available in device versions with PROFIBUS DP.

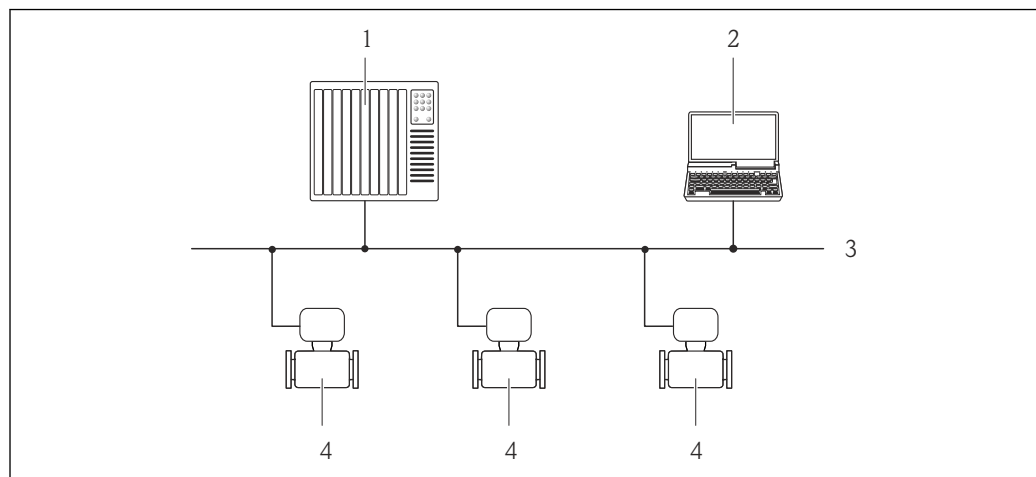

A0020903

▣ 43 Options for remote operation via PROFIBUS DP network

- 1 Automation system
- 2 Computer with PROFIBUS network card
- 3 PROFIBUS DP network
- 4 Measuring instrument

#### Via PROFIBUS PA network

This communication interface is available in device versions with PROFIBUS PA.

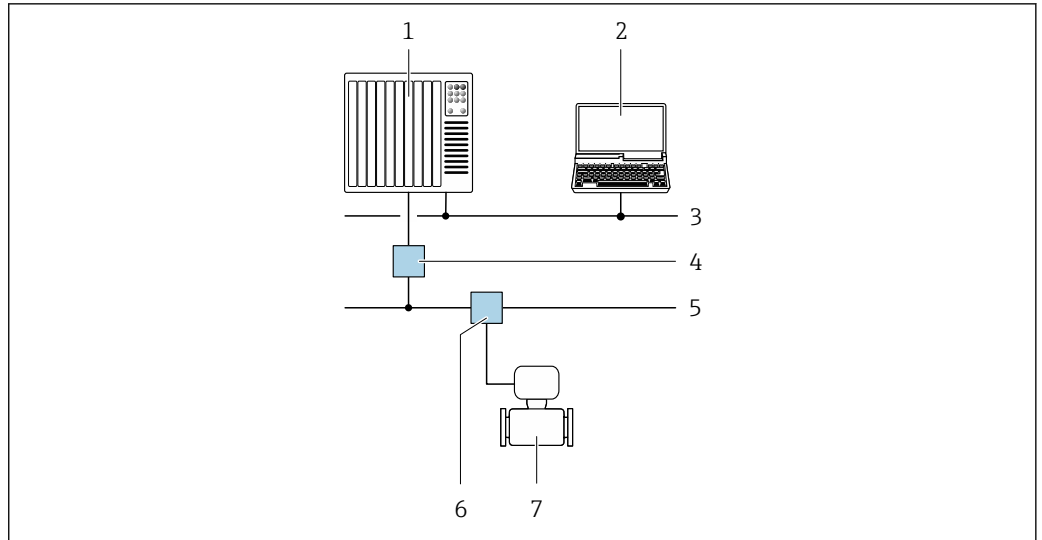

A0028838

44 Options for remote operation via PROFIBUS PA network

- 1 Automation system
- 2 Computer with PROFIBUS network card
- 3 PROFIBUS DP network
- 4 Segment coupler PROFIBUS DP/PA
- 5 PROFIBUS PA network
- 6 T-box
- 7 Measuring instrument

**Via Modbus RS485 protocol**

This communication interface is available in device versions with a Modbus RS485 output.

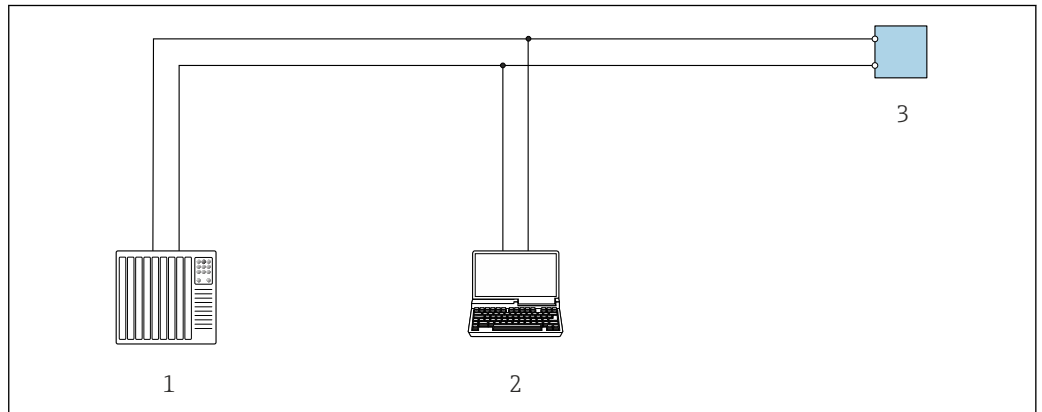

A0029437

45 Options for remote operation via Modbus RS485 protocol (active)

- 1 Automation system (e.g. PLC)
- 2 Computer with web browser for accessing the integrated device web server or with operating tool (e.g. FieldCare, DeviceCare) with COM DTM "CDI Communication TCP/IP" or Modbus DTM
- 3 Transmitter

**Via Modbus TCP over Ethernet-APL 10 Mbit/s, SPE 10 Mbit/s**

This communication interface is available on port 1 in device versions with a Modbus TCP over Ethernet-APL output.

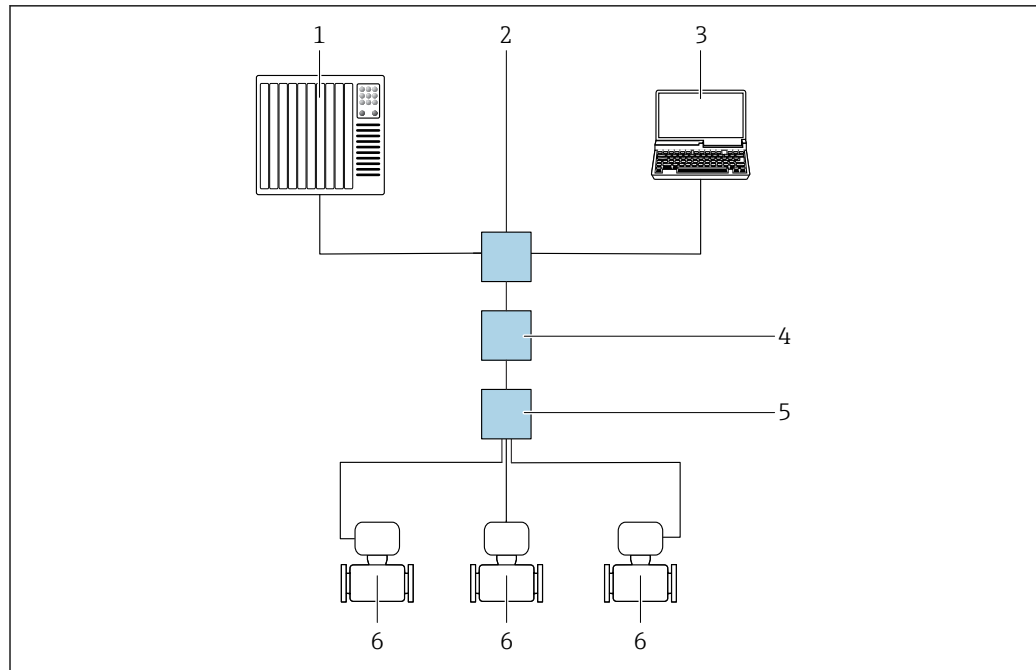

A0046117

46 Options for remote operation via Modbus TCP over Ethernet-APL protocol (active)

- 1 Automation system, e.g. Simatic S7 (Siemens)
- 2 Ethernet switch, e.g. Scalance X204 (Siemens)
- 3 Computer with web browser or operating tool
- 4 APL power switch/SPE power switch (optional)
- 5 APL field switch/SPE field switch
- 6 Measuring instrument/communication via port 1 (terminal 26 + 27)

### Via Modbus TCP over Ethernet 100 Mbit/s

This communication interface is available on port 2 in device versions with a Modbus TCP over Ethernet-APL output.

#### Star topology

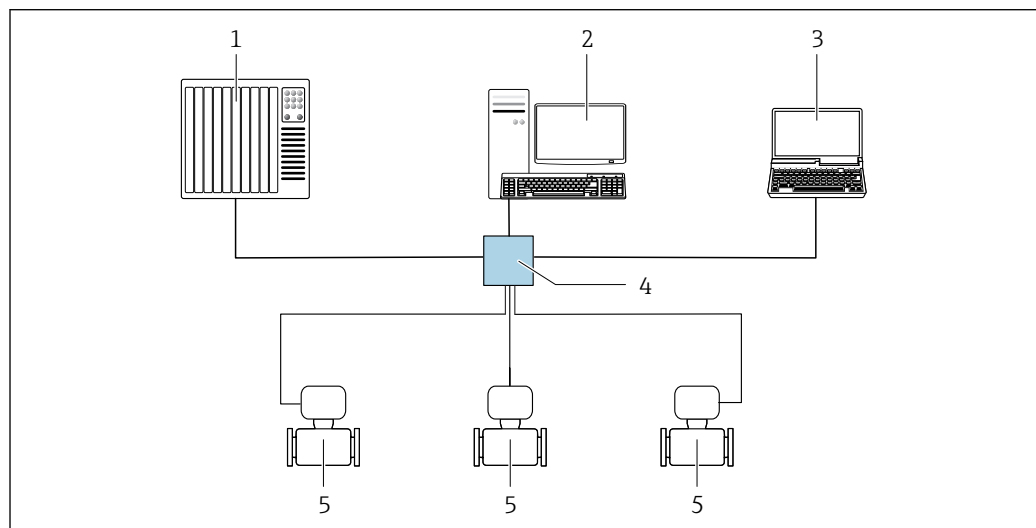

A0032078

47 Options for remote operation via Modbus TCP over Ethernet - 100 Mbit/s: Star topology

- 1 Automation system, z. B. RSLogix (Rockwell Automation)
- 2 Workstation for measuring instrument operation: with Custom Add-On Profile for "RSLogix 5000" (Rockwell Automation) or with Electronic Data Sheet (EDS)
- 3 Computer with web browser or operating tool
- 4 Standard Ethernet switch, e.g. Stratix (Rockwell Automation)
- 5 Measuring instrument/communication via port 2 (RJ45 connector)

### Via EtherNet/IP network

This communication interface is available in device versions with EtherNet/IP.

#### Star topology

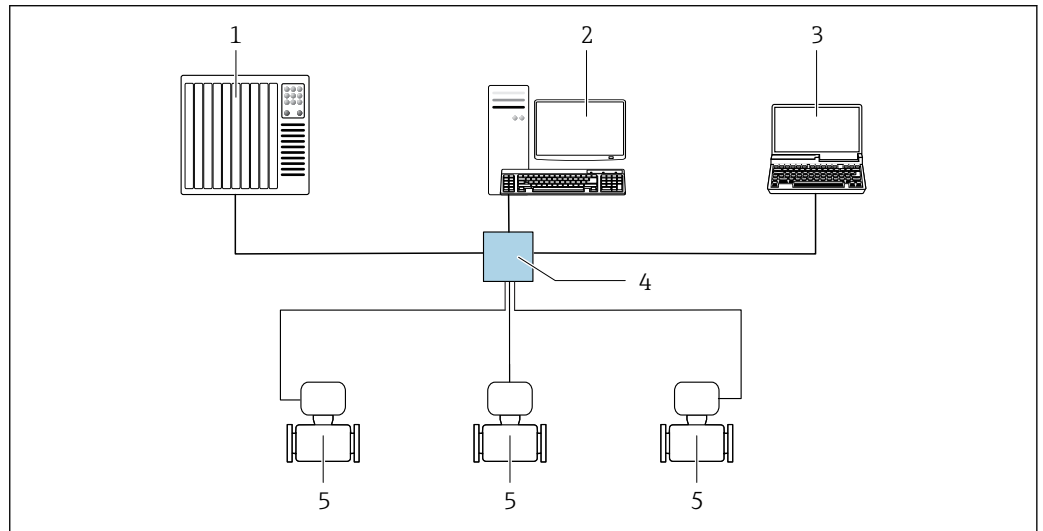

A0032078

48 Options for remote operation via Ethernet/IP network: star topology

- 1 Automation system, z. B. "RSLogix" (Rockwell Automation)
- 2 Workstation for measuring instrument operation: with Custom Add-On Profile for "RSLogix 5000" (Rockwell Automation) or with Electronic Data Sheet (EDS)
- 3 Computer with web browser for accessing the integrated web server or computer with operating tool (e.g. FieldCare, DeviceCare) with COM DTM "CDI Communication TCP/IP"
- 4 Standard Ethernet switch, e.g. Scalance X204 (Siemens)
- 5 Measuring instrument

#### Ring topology

The device is integrated via the terminal connection for signal transmission (output 1) and the service interface (CDI-RJ45).

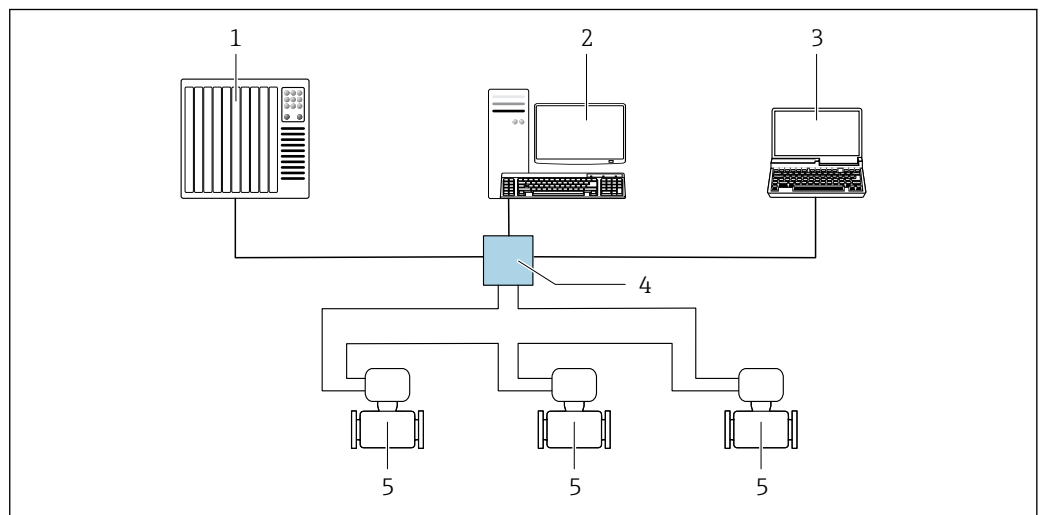

A0033725

49 Options for remote operation via Ethernet/IP network: ring topology

- 1 Automation system, z. B. "RSLogix" (Rockwell Automation)
- 2 Workstation for measuring instrument operation: with Custom Add-On Profile for RSLogix 5000 (Rockwell Automation) or with Electronic Data Sheet (EDS)
- 3 Computer with web browser for accessing the integrated web server or computer with operating tool (e.g. FieldCare, DeviceCare) with COM DTM "CDI Communication TCP/IP"
- 4 Standard Ethernet switch, e.g. Scalance X204 (Siemens)
- 5 Measuring instrument

### Via PROFINET network

This communication interface is available in device versions with PROFINET.

#### Star topology

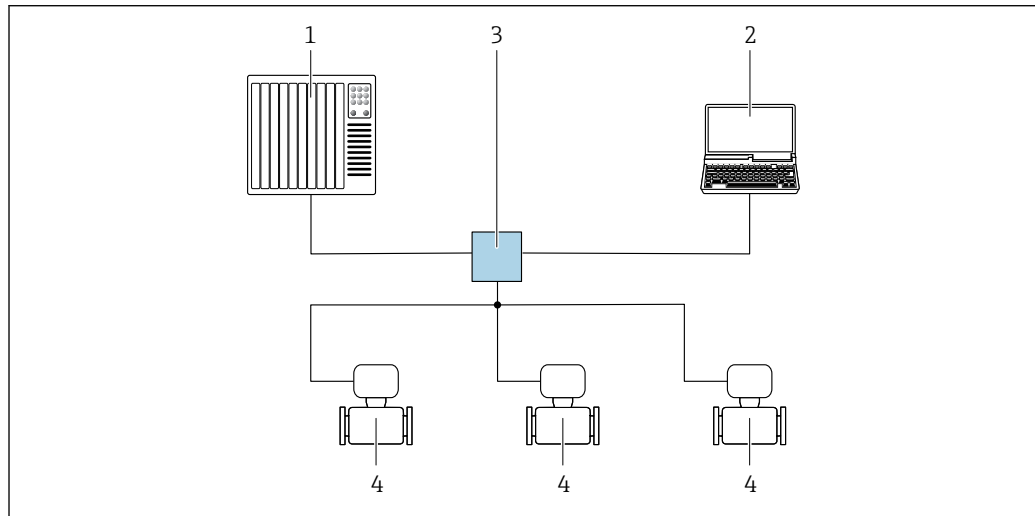

A0026545

50 Options for remote operation via PROFINET network: star topology

- 1 Automation system, e.g. Simatic S7 (Siemens)
- 2 Computer with web browser for accessing integrated web server or computer with operating tool (e.g. FieldCare, DeviceCare, SIMATIC PDM) with COM DTM "CDI Communication TCP/IP"
- 3 Standard Ethernet switch, e.g. Scalance X204 (Siemens)
- 4 Measuring instrument

#### Ring topology

The device is integrated via the terminal connection for signal transmission (output 1) and the service interface (CDI-RJ45).

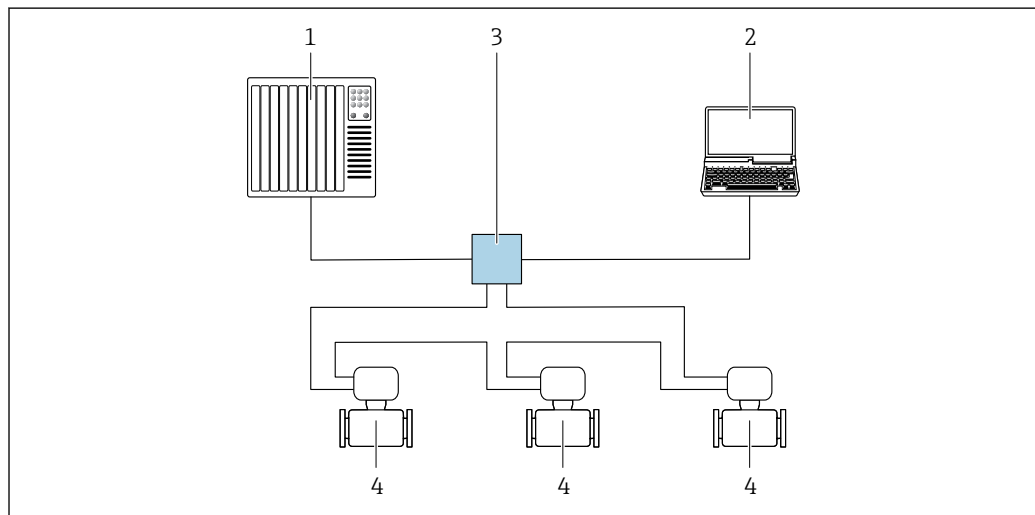

A0033719

51 Options for remote operation via PROFINET network: ring topology

- 1 Automation system, e.g., Simatic S7 (Siemens)
- 2 Computer with web browser for accessing integrated web server or computer with operating tool (e.g. FieldCare, DeviceCare, SIMATIC PDM) with COM DTM "CDI Communication TCP/IP"
- 3 Standard Ethernet switch, e.g. Scalance X204 (Siemens)
- 4 Measuring instrument

**Service interface**

**Via service interface (CDI-RJ45)**

To configure the device on site, a point-to-point connection can be established. Alternatively, a connection via Modbus TCP can be used. The connection is made with the housing open, directly via the device's service interface (CDI-RJ45).

**i** An adapter for the RJ45 to the M12 connector is optionally available for the non-hazardous area:

Order code for "Accessories", option **NB**: "Adapter RJ45 M12 (service interface)"

The adapter connects the service interface (CDI-RJ45) to an M12 connector mounted in the cable entry. The connection to the service interface can be established via an M12 connector without opening the device.

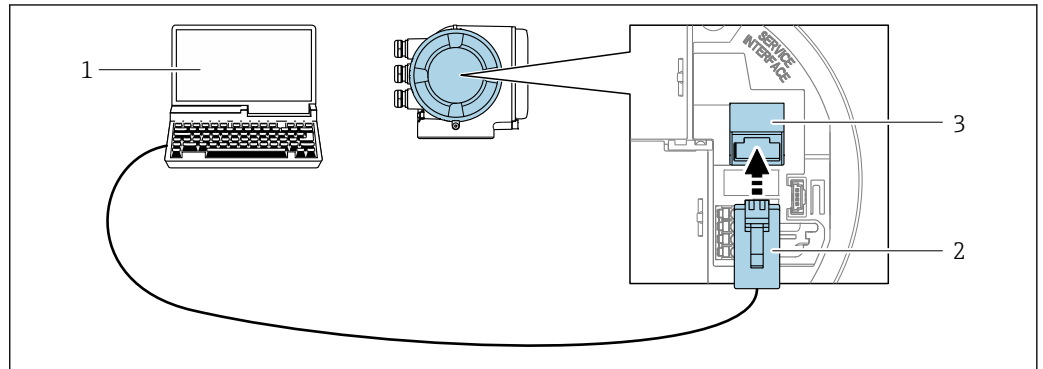

A0027563

**52** Connection via service interface (CDI-RJ45)

- 1 Computer with web browser for accessing the integrated web server or computer with operating tool, e.g. "FieldCare", "DeviceCare", with COM DTM "CDI Communication TCP/IP" or Modbus DTM or operating tool
- 2 Standard Ethernet connecting cable with RJ45 connector
- 3 Service interface (CDI-RJ45) of the measuring instrument with access to the integrated web server

**Via WLAN interface**

The optional WLAN interface is available on the following device version:

Order code for "Display; operation", option G "4-line, illuminated; touch control + WLAN"

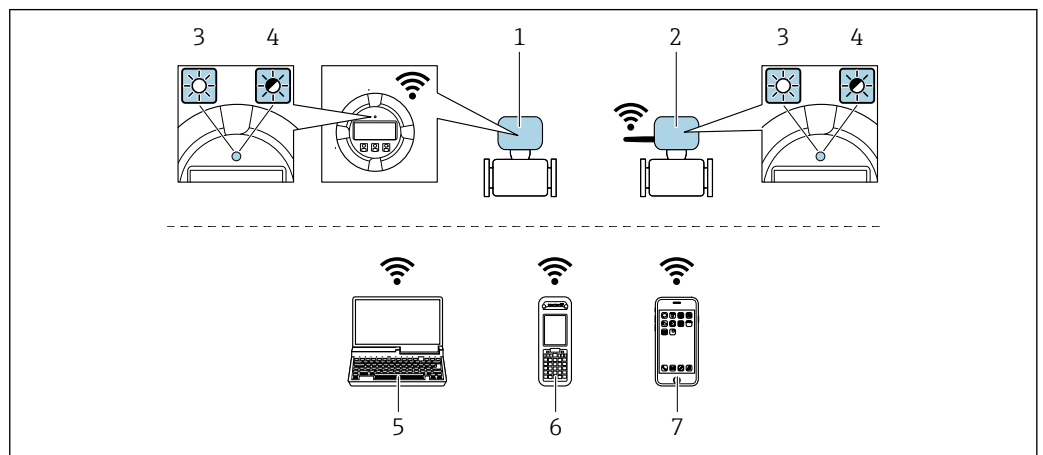

A0034570

- 1 Transmitter with integrated WLAN antenna
- 2 Transmitter with external WLAN antenna
- 3 LED lit constantly: WLAN reception is enabled on measuring instrument
- 4 LED flashing: WLAN connection established between operating unit and measuring instrument
- 5 Computer with WLAN interface and web browser for accessing integrated device web server or with operating tool e.g. FieldCare, DeviceCare)
- 6 Mobile handheld terminal with WLAN interface and web browser for accessing integrated device web server or operating tool (e.g. FieldCare, DeviceCare)
- 7 Smartphone or tablet (e.g. Field Xpert SMT70)

|                              |  |
|------------------------------|--|
| Function                     | WLAN: IEEE 802.11 b/g (2.4 GHz) <ul style="list-style-type: none"> <li>▪ Access point with DHCP server (factory setting)</li> <li>▪ Network</li> </ul>   |
| Encryption                   | WPA2-PSK AES-128 (in accordance with IEEE 802.11i)   |
| Configurable WLAN channels   | 1 to 11  |
| Degree of protection         | IP66/67  |
| Available antennas           | <ul style="list-style-type: none"> <li>▪ Internal antenna</li> <li>▪ External antenna (optional)<br/>In the event of poor transmission/reception conditions at the place of installation.<br/>Available as an accessory .</li> </ul>  Only 1 antenna is active at any one time! |
| Range                        | <ul style="list-style-type: none"> <li>▪ Internal antenna: typically 10 m (32 ft)</li> <li>▪ External antenna: typically 50 m (164 ft)</li> </ul>  |
| Materials (external antenna) | <ul style="list-style-type: none"> <li>▪ Antenna: ASA plastic (acrylonitrile styrene acrylate) and nickel-plated brass</li> <li>▪ Adapter: Stainless steel and nickel-plated brass</li> <li>▪ Cable: Polyethylene</li> <li>▪ Plug: Nickel-plated brass</li> <li>▪ Angle bracket: Stainless steel</li> </ul>  |

### Network integration



Network integration is only available for the HART communication protocol.

With the optional "OPC UA Server" application package, the device can be integrated into an Ethernet network via the service interface (CDI-RJ45 and WLAN) and communicate with OPC UA clients. If the device is used in this way, IT security must be considered.



For detailed information on connecting transmitters with an Ex de approval, see separate document "Safety instructions" (XA) for the device.

For permanent access to device data and for device configuration via the web server, the device is incorporated directly in a network via the service interface (CDI-RJ45). In this way, the device can be accessed any time from the control station. The measured values are processed separately via the inputs and outputs through the automation system.

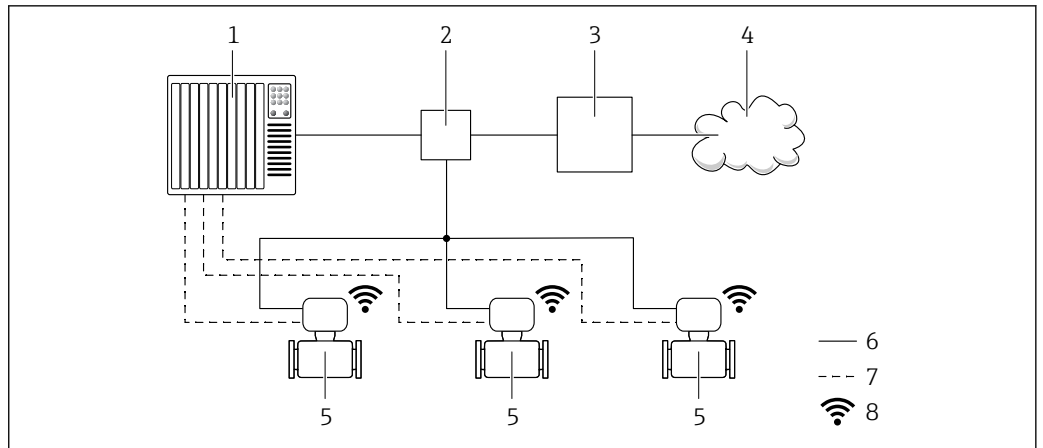

A0033618



- 1 Automation system, e.g. Simatic S7 (Siemens)
- 2 Ethernet switch
- 3 Edge Gateway
- 4 Cloud
- 5 Measuring instrument
- 6 Ethernet network
- 7 Measured values via inputs and outputs
- 8 Optional WLAN interface

 The optional WLAN interface is available on the following device version:  
Order code for "Display; operation", option G "4-line, backlit, graphic display; touch control + WLAN"

 Special Documentation for the OPC UA Server application package →  117.

**Supported operating tools**

Different operating tools can be used for local or remote access to the measuring device. Depending on the operating tool used, access is possible with different operating units and via a variety of interfaces.

| Supported operating tools | Operating unit                                       | Interface   | Additional information   |
|---------------------------|--|---|--|
| Web browser               | Notebook, PC or tablet with web browser              | <ul style="list-style-type: none"> <li>▪ Service interface CDI-RJ45</li> <li>▪ WLAN interface</li> <li>▪ Ethernet-based fieldbus (EtherNet/IP, PROFINET, Modbus TCP over Ethernet-APL)</li> </ul> | Special Documentation for device →  117 |
| DeviceCare SFE100         | Notebook, PC or tablet with Microsoft Windows system | <ul style="list-style-type: none"> <li>▪ Service interface CDI-RJ45</li> <li>▪ WLAN interface</li> <li>▪ Fieldbus protocol</li> <li>▪ Modbus TCP over Ethernet-APL</li> </ul>                     | →  114                                  |

| Supported operating tools | Operating unit                                       | Interface   | Additional information   |
|---------------------------|--|---|--|
| FieldCare SFE500          | Notebook, PC or tablet with Microsoft Windows system | <ul style="list-style-type: none"> <li>■ Service interface CDI-RJ45</li> <li>■ WLAN interface</li> <li>■ Fieldbus protocol</li> </ul>                           | →  114                |
| Field Xpert               | SMT70/77/50  | <ul style="list-style-type: none"> <li>■ All fieldbus protocols</li> <li>■ WLAN interface</li> <li>■ Bluetooth</li> <li>■ Service interface CDI-RJ45</li> </ul> | Operating Instructions BAO1202S<br>Device description files:<br>Use update function of handheld terminal |

 Other operating tools based on FDT technology with a device driver such as DTM/iDTM or DD/EDD can be used for device operation. These operating tools are available from the individual manufacturers. Integration into the following operating tools, among others, is supported:

- FactoryTalk AssetCentre (FTAC) from Rockwell Automation → [www.rockwellautomation.com](http://www.rockwellautomation.com)
- Process Device Manager (PDM) from Siemens → [www.siemens.com](http://www.siemens.com)
- Asset Management Solutions (AMS) from Emerson → [www.emersonprocess.com](http://www.emersonprocess.com)
- FieldCommunicator 375/475 from Emerson → [www.emersonprocess.com](http://www.emersonprocess.com)
- Emersons TREX → [www.emerson.com](http://www.emerson.com)
- Field Device Manager (FDM) from Honeywell → [www.process.honeywell.com](http://www.process.honeywell.com)
- FieldMate from Yokogawa → [www.yokogawa.com](http://www.yokogawa.com)
- PACTWare → [www.pactware.com](http://www.pactware.com)

The related device description files are available: [www.endress.com](http://www.endress.com) → Download Area



### Web server

The integrated web server can be used to operate and configure the device via a web browser via Ethernet-APL, via service interface (CDI-RJ45) or via WLAN interface. The structure of the operating menu is the same as for the local display. In addition to the measured values, status information on the device is displayed and can be used to monitor device health. Furthermore the device data can be managed and the network parameters can be configured.

A device that has a WLAN interface (can be ordered as an option) is required for the WLAN connection: order code for "Display; Operation", option G "4-line, illuminated; touch control + WLAN". The device acts as an Access Point and enables communication by computer or a mobile handheld terminal.

### Supported functions

Data exchange between the operating unit (such as a notebook, for example,) and measuring instrument:

- Upload the configuration from the measuring instrument (XML format, configuration backup)
- Save the configuration to the measuring instrument (XML format, restore configuration)
- Export event list (.csv file)
- Export parameter settings (.csv file or PDF file, document the measuring point configuration)
- Export the Heartbeat Technology verification report (PDF file, only available with the **Heartbeat Verification** →  110 application package)
- Flash firmware version for device firmware upgrade, for example
- Download driver for system integration
- Visualize up to 1000 saved measured values (only available with the **Extended HistoROM** application package →  110)

### HistoROM data management

The measuring instrument features HistoROM data management. HistoROM data management comprises both the storage and import/export of key device and process data, making operation and servicing far more reliable, secure and efficient.

 When the device is delivered, the factory settings of the configuration data are stored as a backup in the device memory. This memory can be overwritten with an updated data record, for example after commissioning.

### Additional information on the data storage concept

There are different types of data storage units in which device data are stored and used by the device:

|                         | HistoROM backup  | T-DAT  | S-DAT   |
|-------------------------|--|--|---|
| <b>Available data</b>   | <ul style="list-style-type: none"> <li>▪ Event logbook, e.g. diagnostic events</li> <li>▪ Parameter data record backup</li> <li>▪ Device firmware package</li> <li>▪ Driver for system integration for exporting via web server, e.g.:               <ul style="list-style-type: none"> <li>▪ GSD for PROFIBUS DP</li> <li>▪ GSD for PROFIBUS PA</li> <li>▪ GSD for PROFINET</li> <li>▪ EDS for EtherNet/IP</li> <li>▪ DD for FOUNDATION Fieldbus</li> </ul> </li> </ul> | <ul style="list-style-type: none"> <li>▪ Measured value logging ("Extended HistoROM" order option)</li> <li>▪ Current parameter data record (used by firmware at run time)</li> <li>▪ Indicator (minimum/maximum values)</li> <li>▪ Totalizer value</li> </ul> | <ul style="list-style-type: none"> <li>▪ Sensor data: e.g. nominal diameter</li> <li>▪ Serial number</li> <li>▪ Calibration data</li> <li>▪ Device configuration (e.g. SW options, fixed I/O or multi I/O)</li> </ul> |
| <b>Storage location</b> | Fixed on the user interface PC board in the connection compartment   | Can be plugged into the user interface PC board in the connection compartment  | In the sensor plug in the transmitter neck part   |

#### Data backup

##### Automatic

- The most important device data (sensor and transmitter) are automatically saved in the DAT modules
- If the transmitter or measuring device is replaced: once the T-DAT containing the previous device data has been exchanged, the new measuring device is ready for operation again immediately without any errors
- If exchanging the electronics module (e.g. I/O electronics module): Once the electronics module has been replaced, the software of the module is compared against the current device firmware. The module software is upgraded or downgraded where necessary. The electronics module is available for use immediately afterwards and no compatibility problems occur.

##### Manual

Additional parameter data record (complete parameter settings) in the integrated device memory HistoROM backup for:

- Data backup function  
Backup and subsequent restoration of a device configuration in the device memory HistoROM backup
- Data comparison function  
Comparison of the current device configuration with the device configuration saved in the device memory HistoROM backup

#### Data transmission

##### Manual

- Transfer of a device configuration to another device using the export function of the specific operating tool, e.g. with FieldCare, DeviceCare or web server: to duplicate the configuration or to store in an archive (e.g. for backup purposes)
- Transmission of the drivers for system integration via web server, e.g.:
  - GSD for PROFIBUS DP
  - GSD for PROFIBUS PA
  - GSD for PROFINET
  - EDS for Ethernet/IP
  - DD for FOUNDATION fieldbus

#### Event list

##### Automatic

- Chronological display of up to 20 event messages in the events list
- If the **Extended HistoROM** application package (order option) is enabled: up to 100 event messages are displayed in the events list along with a time stamp, plain text description and remedial measures
- The events list can be exported and displayed via a variety of interfaces and operating tools e.g. DeviceCare, FieldCare or Web server

### Data logging

#### Manual

If the **Extended HistoROM** application package (order option) is enabled:

- Recording of 1 to 4 channels of up to 1 000 measured values (up to 250 measured values per channel)
- User configurable recording interval
- Export the measured value log via a variety of interfaces and operating tools e.g. FieldCare, DeviceCare or web server

## Certificates and approvals

Current certificates and approvals for the product are available at [www.endress.com](http://www.endress.com) on the relevant product page:

1. Select the product using the filters and search field.
2. Open the product page.
3. Select **Downloads**.

|                     |  |
|---------------------|--|
| <b>CE mark</b>      | <p>The device meets the legal requirements of the applicable EU Directives. These are listed in the corresponding EU Declaration of Conformity along with the standards applied.</p> <p>Endress+Hauser confirms successful testing of the device by affixing to it the CE mark.</p>  |
| <b>UKCA marking</b> | <p>The device meets the legal requirements of the applicable UK regulations (Statutory Instruments). These are listed in the UKCA Declaration of Conformity along with the designated standards. By selecting the order option for UKCA marking, Endress+Hauser confirms a successful evaluation and testing of the device by affixing the UKCA mark.</p> <p>Contact address Endress+Hauser UK:<br/>         Endress+Hauser Ltd.<br/>         Floats Road<br/>         Manchester M23 9NF<br/>         United Kingdom<br/> <a href="http://www.uk.endress.com">www.uk.endress.com</a></p>  |
| <b>RCM marking</b>  | <p>The measuring system meets the EMC requirements of the "Australian Communications and Media Authority (ACMA)".</p>  |
| <b>Ex approval</b>  | <p>The measuring device is certified for use in hazardous areas and the relevant safety instructions are provided in the separate "Safety Instructions" (XA) document. Reference is made to this document on the nameplate.</p> <p>Devices with the order code for "Approval; transmitter + sensor", option BA, BB, BC or BD have equipment protection level (EPL) Ga/Gb (Zone 0 in the measuring tube).</p> <p> The separate Ex documentation (XA) containing all the relevant explosion protection data is available from your Endress+Hauser sales center.</p> |

**Hygienic compatibility**

- 3-A approval
  - Only measuring instruments with the order code for "Additional approval", option LP "3A" have 3-A approval.
  - The 3-A approval refers to the measuring instrument.
  - When installing the measuring instrument, ensure that no liquid can accumulate on the outside of the measuring instrument.  
A remote display module must be installed in accordance with the 3-A Standard.
  - Accessories (e.g. heating jacket, weather protection cover, wall holder unit) must be installed in accordance with the 3-A Standard.  
Each accessory can be cleaned. Disassembly may be necessary under certain circumstances.
- EHEDG-tested (Type EL Class I)  
Only devices with the order code for "Additional approval", option LT "EHEDG" have been tested and meet the requirements of the EHEDG.  
To meet the requirements for EHEDG certification, the device must be used with process connections in accordance with the EHEDG position paper entitled "Easy cleanable Pipe couplings and Process connections" ([www.ehedg.org](http://www.ehedg.org)).  
To meet the requirements for EHEDG certification, the orientation of the device must ensure drainability.  
Test criteria for cleanability according to EHEDG is a flow velocity of 1.5 m/s in the process line. This speed must be ensured for EHEDG-compliant cleaning.
- FDA CFR 21
- Food Contact Materials Regulation (EC) 1935/2004
- Food Contact Materials Regulation GB 4806
- The requirements of the Food Contact Material regulations must be observed when selecting the material versions.



Observe special installation instructions

**Pharmaceutical compatibility**

- FDA 21 CFR 177
- USP <87>
- USP <88> Class VI 121 °C
- TSE/BSE Certificate of Suitability
- cGMP  
Devices with the order code for "Test, certificate", option JG "Conformity with cGMP-derived requirements, declaration" comply with the requirements of cGMP with regard to the surfaces of parts in contact with the medium, design, FDA 21 CFR material conformity, USP Class VI tests and TSE/BSE conformity.  
A serial number-specific declaration is generated.

**Functional safety**

The measuring instrument can be used for flow monitoring systems (min., max., range) up to SIL 2 (single-channel architecture; order code for "Additional approval", option LA) and SIL 3 (multi-channel architecture with homogeneous redundancy) and is independently evaluated and certified in accordance with IEC 61508.

The following types of monitoring in safety equipment are possible:

- Mass flow
- Volume flow
- Density



Functional safety manual with information for the SIL device → 116

**HART certification****HART interface**

The measuring device is certified and registered by the FieldComm Group. The measuring system meets all the requirements of the following specifications:

- Certified according to HART 7
- The device can also be operated with certified devices of other manufacturers (interoperability)

**FOUNDATION Fieldbus certification****FOUNDATION Fieldbus interface**

The measuring device is certified and registered by the FieldComm Group. The measuring system meets all the requirements of the following specifications:

- Certified in accordance with FOUNDATION Fieldbus H1
- Interoperability Test Kit (ITK), revision version 6.2.0 (certificate available on request)
- Physical Layer Conformance Test
- The device can also be operated with certified devices of other manufacturers (interoperability)

**Certification PROFIBUS****PROFIBUS interface**

The measuring device is certified and registered by the PNO (PROFIBUS Nutzerorganisation e.V./ PROFIBUS User Organization). The measuring system meets all the requirements of the following specifications:

- Certified according to PA Profile 3.02
- The device can also be operated with certified devices of other manufacturers (interoperability)

**EtherNet/IP certification**

The measuring device is certified and registered by the ODVA (Open Device Vendor Association). The measuring system meets all the requirements of the following specifications:

- Certified in accordance with the ODVA Conformance Test
- EtherNet/IP Performance Test
- EtherNet/IP PlugFest compliance
- The device can also be operated with certified devices of other manufacturers (interoperability)

**Certification PROFINET****PROFINET interface**

The measuring instrument is certified and registered by the PROFIBUS Nutzerorganisation e.V. (PNO). The measuring system meets all the requirements of the following specifications:

- Certified according to:
  - Test specification for PROFINET devices
  - PROFINET Netload Class 2 100 Mbit/s
- The device can also be operated with certified devices of other manufacturers (interoperability).
- The device supports PROFINET S2 system redundancy.

**PROFINET over Ethernet-APL certification****PROFINET interface**

The measuring instrument is certified and registered by the PROFIBUS Nutzerorganisation e.V. (PNO). The measuring system meets all the requirements of the following specifications:

- Certified according to:
  - Test specification for PROFINET devices
  - PROFINET PA Profile 4.02
  - PROFINET Netload Robustness Class 2 10 Mbit/s
  - APL conformance test
- The device can also be operated with certified devices of other manufacturers (interoperability)
- The device supports PROFINET S2 system redundancy.

**Pressure Equipment Directive**

The measuring instruments can be ordered with or without PED or PESR. If a device with PED or PESR is required, this must be ordered explicitly. For devices with nominal diameters less than or equal to DN 25 (NPS 1"), this is neither possible nor necessary. A UK order option must be selected for PESR under the order code for "Approvals".

- With the marking
  - a) PED/G1/x (x = category) or
  - b) PESR/G1/x (x = category)
 on the sensor nameplate, Endress+Hauser confirms compliance with the "Essential Safety Requirements"
  - a) specified in Annex I of the Pressure Equipment Directive 2014/68/EU or
  - b) Schedule 2 of Statutory Instruments 2016 No. 1105.
- Devices bearing this marking (PED or PESR) are suitable for the following types of medium:
  - Media in Group 1 and 2 with a vapor pressure greater than, or smaller and equal to 0.5 bar (7.3 psi)
  - Unstable gases
- Devices not bearing this marking (without PED or PESR) are designed and manufactured according to sound engineering practice. They meet the requirements of
  - a) Art. 4, Section 3 of the Pressure Equipment Directive 2014/68/EU or
  - b) Part 1, Section 8 of Statutory Instruments 2016 No. 1105.
 The scope of application is indicated
  - a) in diagrams 6 to 9 in Annex II of the Pressure Equipment Directive 2014/68/EU or
  - b) in Schedule 3, Section 2 of Statutory Instruments 2016 No. 1105.

---

**Radio approval**

The measuring instrument has radio approval.



For detailed information on the radio approval, see the Special Documentation →  117

---

**Additional certification**

**Marine approval**

Currently valid certificates are available:

- In the Downloads area of the Endress+Hauser website: [www.endress.com](http://www.endress.com) → Downloads
- Specify the following details:
  - Product root, e.g. 8E3B
  - Search: Approval & Certificates → Marine

**CRN approval**

Some device versions have CRN approval. A CRN-approved process connection with a CSA approval must be ordered for a CRN-approved device.

**Tests and certificates**

- EN10204-3.1 material certificate, wetted parts and sensor housing (order code for "Test, certificate", option JA)
- Pressure test, internal process, test report (order code for "Test, certificate", option JB)
- Surface roughness test ISO4287/Ra, (wetted parts), test report (option JE)
- Compliance with requirements derived from cGMP, Declaration (option JG)

---

**External standards and guidelines**

- EN 60529  
Degrees of protection provided by enclosure (IP code)
- IEC/EN 60068-2-6  
Environmental influences: Test procedure - Test Fc: vibrate (sinusoidal).
- IEC/EN 60068-2-31  
Environmental influences: Test procedure - Test Ec: shocks due to rough handling, primarily for devices.
- EN 61010-1  
Safety requirements for electrical equipment for measurement, control and laboratory use - general requirements
- GB 30439.5  
Safety requirements for industrial automation products - Part 5: Flowmeter safety requirements
- EN 61326-1/-2-3  
EMC requirements for electrical equipment for measurement, control and laboratory use
- NAMUR NE 21  
Electromagnetic compatibility (EMC) of industrial process and laboratory control equipment
- NAMUR NE 32  
Data retention in the event of a power failure in field and control instruments with microprocessors

- NAMUR NE 43  
Standardization of the signal level for the breakdown information of digital transmitters with analog output signal.
- NAMUR NE 53  
Software of field devices and signal-processing devices with digital electronics
- NAMUR NE 80  
The application of the pressure equipment directive to process control devices
- NAMUR NE 105  
Specifications for integrating fieldbus devices in engineering tools for field devices
- NAMUR NE 107  
Self-monitoring and diagnostics of field devices
- NAMUR NE 131  
Requirements for field devices for standard applications
- NAMUR NE 132  
Coriolis mass meter
- ETSI EN 300 328  
Guidelines for 2.4 GHz radio components.
- EN 301489  
Electromagnetic compatibility and radio spectrum matters (ERM).

## Ordering information

Detailed ordering information is available from your nearest sales organization [www.addresses.endress.com](http://www.addresses.endress.com) or in the Product Configurator at [www.endress.com](http://www.endress.com):

1. Select the product using the filters and search field.
2. Open the product page.
3. Select **Configuration**.



### Product Configurator - the tool for individual product configuration

- Up-to-the-minute configuration data
- Depending on the device: direct input of information specific to the measuring point, such as the measuring range or operating language
- Automatic verification of exclusion criteria
- Automatic creation of the order code and its breakdown in PDF or Excel output format
- Ability to order directly in the Endress+Hauser Online Shop

## Application packages

Many different application packages are available to enhance the functionality of the device. Such packages might be needed to address safety aspects or specific application requirements.

The application packages can be ordered with the device or subsequently from Endress+Hauser. Detailed information on the order code in question is available from your local Endress+Hauser sales center or on the product page of the Endress+Hauser website: [www.endress.com](http://www.endress.com).



Detailed information on the application packages:  
Special Documentation → 116

### Diagnostic functionality

Order code for "Application package", option EA "Extended HistoROM"

Comprises extended functions concerning the event log and the activation of the measured value memory.

Event log:

Memory volume is extended from 20 message entries (standard version) to up to 100 entries.

Data logging (line recorder):

- Memory capacity for up to 1000 measured values is activated.
- 250 measured values can be output via each of the 4 memory channels. The recording interval can be defined and configured by the user.
- Measured value logs can be accessed via the local display or operating tool e.g. FieldCare, DeviceCare or Web server.



For detailed information, see the Operating Instructions for the device.

---

## Heartbeat Technology

Order code for "Application package", option EB "Heartbeat Verification + Monitoring"

### Heartbeat Verification

Meets the requirement for traceable verification in accordance with DIN ISO 9001:2015 Clause 7.6 a) "Control of monitoring and measuring equipment".

- Functional testing in the installed state without interrupting the process.
- Traceable verification results on request, including a report.
- Simple testing process via local operation or other operating interfaces.
- Clear measuring point assessment (pass/fail) with high total test coverage within the framework of manufacturer specifications.
- Extension of calibration intervals according to operator's risk evaluation.

### Heartbeat Monitoring

Continuously supplies data, which are characteristic of the measuring principle, to an external condition monitoring system for the purpose of preventive maintenance or process analysis. These data enable the operator to:

- Draw conclusions - using these data and other information - about the impact the process influences (e.g. corrosion, abrasion, deposit buildup etc.) have on measuring performance over time.
- Schedule servicing in time.
- Monitor the process or product quality, e.g. gas pockets.



Detailed information on Heartbeat Technology:  
Special Documentation → 116

---

## Concentration measurement

Order code for "Application package", option ED "Concentration"

Calculation and outputting of fluid concentrations.

The measured density is converted to the concentration of a substance of a binary mixture using the "Concentration" application package:

- Choice of predefined fluids (e.g. various sugar solutions, acids, alkalis, salts, ethanol etc.).
- Common or user-defined units ("Brix", "Plato", % mass, % volume, mol/l etc.) for standard applications.
- Concentration calculation from user-defined tables.



For detailed information, see the Special Documentation for the device.

---

## Petroleum

Order code for "Application package", option EJ "Petroleum"

The most important parameters for the Oil & Gas Industry can be calculated and displayed with this application package.

- Corrected volume flow and calculated reference density in accordance with the "API Manual of Petroleum Measurement Standards, Chapter 11.1"
- Water content, based on density measurement
- Weighted mean of the density and temperature



For detailed information, see the Special Documentation for the device.

---

## Petroleum & locking function

Order code for "Application package", option EM "Petroleum & locking function"

The most important parameters for the Oil & Gas Industry can be calculated and displayed with this application package. It is also possible to lock the settings.

- Corrected volume flow and calculated reference density in accordance with the "API Manual of Petroleum Measurement Standards, Chapter 11.1"
- Water content, based on density measurement
- Weighted mean of the density and temperature



For detailed information, see the Special Documentation for the device.

## OPC-UA Server

Order code for "Application package", option EL "OPC-UA Server"

The application package provides an integrated OPC-UA server for comprehensive device services for IoT and SCADA applications.



For detailed information, see the Special Documentation for the device.





## Accessories







Various accessories, which can be ordered with the device or subsequently from Endress+Hauser, are available for the device. Detailed information on the order code in question is available from your local Endress+Hauser sales center or on the product page of the Endress+Hauser website:

[www.endress.com](http://www.endress.com).



### Device-specific accessories

#### For the transmitter









| Accessory                                  | Description   |
|--|---|
| Proline 300 transmitter                    | <p>Transmitter for replacement or storage. Use the order code to define the following specifications:</p> <ul style="list-style-type: none"> <li>▪ Approvals</li> <li>▪ Output</li> <li>▪ Input</li> <li>▪ Display/operation</li> <li>▪ Housing</li> <li>▪ Software</li> </ul> <p> Order code: 8X3BXX</p> <p> Installation Instructions EA01200D</p>  |
| Remote display and operating module DKX001 | <ul style="list-style-type: none"> <li>▪ If ordered directly with the measuring instrument:<br/>Order code for "Display; operation", option O "Remote display 4-line, illuminated; 10 m (30 ft) cable; touch control"</li> <li>▪ If ordered separately: <ul style="list-style-type: none"> <li>▪ Measuring instrument: order code for "Display; operation", option M "W/o, prepared for remote display"</li> <li>▪ DKX001: Via the separate product structure DKX001</li> </ul> </li> <li>▪ If ordered subsequently:<br/>DKX001: Via the separate product structure DKX001</li> </ul> <p><b>Mounting bracket for DKX001</b></p> <ul style="list-style-type: none"> <li>▪ If ordered directly: order code for "Accessory enclosed", option RA "Mounting bracket, pipe 1/2"</li> <li>▪ If ordered subsequently: order number: 71340960</li> </ul> <p><b>Connecting cable (replacement cable)</b><br/>Via the separate product structure: DKX002</p> <p> Further information on display and operating module DKX001 →  94.</p> <p> Special Documentation SD01763D</p> |



|                       |   |
|-----------------------|---|
| External WLAN antenna | <p>External WLAN antenna with 1.5 m (59.1 in) connecting cable and two angle brackets. Order code for "Accessory enclosed", option P8 "Wireless antenna wide area".</p> <ul style="list-style-type: none"> <li> The external WLAN antenna is not suitable for use in hygienic applications.</li> <li> Further information on the WLAN interface →  101.</li> </ul> <p> Order number: 71351317</p> <p> Installation Instructions EA01238D</p> |
| Protective cover      | <p>Is used to protect the measuring instrument from the effects of the weather: e.g. rainwater, excess heating from direct sunlight.</p> <p> Order number: 71343505</p> <p> Installation Instructions EA01160D</p>  |

**For the sensor**



| Accessories    | Description  |
|----------------|--|
| Heating jacket | <p>Is used to stabilize the temperature of the fluids in the sensor. Water, water vapor and other non-corrosive liquids are permitted for use as fluids.</p> <ul style="list-style-type: none"> <li> If using oil as a heating medium, please consult with Endress+Hauser.</li> </ul> <p>Heating jackets cannot be used with sensors fitted with a rupture disk. Use the order code with the product root DK8003.</p> <p> Special Documentation SD02151D</p> |

**Communication-specific accessories**



| Accessories               | Description  |
|---------------------------|--|
| Commbus FXA195 HART       | <p>For intrinsically safe HART communication with FieldCare via the USB interface.</p> <p> Technical Information TI00404F</p>   |
| HART loop converter HMX50 | <p>Is used to evaluate and convert dynamic HART process variables to analog current signals or limit values.</p> <ul style="list-style-type: none"> <li> Technical Information TI00429F</li> <li> Operating Instructions BA00371F</li> </ul>   |
| Fieldgate FXA42           | <p>Transmission of the measured values of connected 4 to 20 mA analog measuring instruments, as well as digital measuring instruments</p> <ul style="list-style-type: none"> <li> Technical Information TI01297S</li> <li> Operating Instructions BA01778S</li> <li> Product page: <a href="http://www.endress.com/fxa42">www.endress.com/fxa42</a></li> </ul>  |
| Field Xpert SMT50         | <p>The Field Xpert SMT50 tablet PC for device configuration enables mobile plant asset management in non-hazardous areas. It is suitable for commissioning and maintenance staff to manage field instruments with a digital communication interface and to record progress.</p> <p>This tablet PC is designed as an all-in-one solution with a preinstalled driver library and is an easy-to-use, touch-sensitive tool which can be used to manage field instruments throughout their entire life cycle.</p> <ul style="list-style-type: none"> <li> Technical Information TI01555S</li> <li> Operating Instructions BA02053S</li> <li> Product page: <a href="http://www.endress.com/smt50">www.endress.com/smt50</a></li> </ul> |



|                   |  |
|-------------------|--|
| Field Xpert SMT70 | <p>The Field Xpert SMT70 tablet PC for device configuration enables mobile plant asset management in hazardous and non-hazardous areas. It is suitable for commissioning and maintenance staff to manage field instruments with a digital communication interface and to record progress.</p> <p>This tablet PC is designed as an all-in-one solution with a preinstalled driver library and is an easy-to-use, touch-sensitive tool which can be used to manage field instruments throughout their entire life cycle.</p> <ul style="list-style-type: none"> <li> ■ Technical Information TI01342S</li> <li>■ Operating Instructions BA01709S</li> <li>■ Product page: <a href="http://www.endress.com/smt70">www.endress.com/smt70</a></li> </ul> |
| Field Xpert SMT77 | <p>The Field Xpert SMT77 tablet PC for device configuration enables mobile plant asset management in areas categorized as Ex Zone 1.</p> <ul style="list-style-type: none"> <li> ■ Technical Information TI01418S</li> <li>■ Operating Instructions BA01923S</li> <li>■ Product page: <a href="http://www.endress.com/smt77">www.endress.com/smt77</a></li> </ul>   |

## Service-specific accessories

| Accessory  | Description  |
|------------|--|
| Applicator | <p>Software for selecting and sizing Endress+Hauser measuring instruments:</p> <ul style="list-style-type: none"> <li>■ Choice of measuring instruments for industrial requirements</li> <li>■ Calculation of all the necessary data for identifying the optimum flowmeter: e.g. nominal diameter, pressure loss, flow velocity and measurement accuracy.</li> <li>■ Graphic display of the calculation results</li> <li>■ Determining the partial order code. Administration, documentation and access to all project-related data and parameters over the entire life cycle of a project.</li> </ul> <p>Applicator is available:<br/>Via the Internet: <a href="https://portal.endress.com/webapp/applicator">https://portal.endress.com/webapp/applicator</a></p> |
| Netilion   | <p>IIoT ecosystem: Unlock knowledge</p> <p>With the Netilion IIoT ecosystem, Endress+Hauser allows you to optimize your plant performance, digitize workflows, share knowledge, and enhance collaboration.</p> <p>Based on decades of experience in process automation, Endress+Hauser offers the process industry an IIoT ecosystem that enables you to gain useful insights from data. These insights can be used to optimize processes, leading to increased plant availability, efficiency, and reliability - ultimately resulting in a more profitable plant.</p> <p><a href="http://www.netilion.endress.com">www.netilion.endress.com</a></p>   |
| FieldCare  | <p>FDT-based plant asset management tool from Endress+Hauser.</p> <p>It can configure all intelligent field units in your system and helps you manage them. By using the status information, it is also a simple but effective way of checking their status and condition.</p> <ul style="list-style-type: none"> <li> Operating Instructions BA00027S and BA00059S</li> </ul>  |
| DeviceCare | <p>Tool to connect and configure Endress+Hauser field devices.</p> <ul style="list-style-type: none"> <li> ■ Technical Information: TI01134S</li> <li>■ Innovation brochure: IN01047S</li> </ul>  |

## System components

| Accessories                      | Description  |
|----------------------------------|--|
| Memograph M graphic data manager | <p>The Memograph M graphic data manager provides information on all the relevant measured variables. Measured values are recorded correctly, limit values are monitored and measuring points analyzed. The data are stored in the 256 MB internal memory and also on a SD card or USB stick.</p> <ul style="list-style-type: none"> <li> ■ Technical Information TI00133R</li> <li>■ Operating Instructions BA00247R</li> </ul> |
| Cerabar M                        | <p>The pressure transmitter for measuring the absolute and gauge pressure of gases, steam and liquids. It can be used to read in the operating pressure value.</p> <ul style="list-style-type: none"> <li> ■ Technical Information TI00426P and TI00436P</li> <li>■ Operating Instructions BA00200P and BA00382P</li> </ul>   |

| Accessories | Description  |
|-------------|--|
| Cerabar S   | The pressure transmitter for measuring the absolute and gauge pressure of gases, steam and liquids. It can be used to read in the operating pressure value.<br> <ul style="list-style-type: none"> <li>▪ Technical Information TI00383P</li> <li>▪ Operating Instructions BA00271P</li> </ul> |
| iTEMP       | The temperature transmitters can be used in all applications and are suitable for the measurement of gases, steam and liquids. They can be used to read in the medium temperature.<br> "Fields of Activity" document FA00006T   |

## Documentation

-  For an overview of the scope of the associated Technical Documentation, refer to the following:
- *Device Viewer* ([www.endress.com/deviceviewer](http://www.endress.com/deviceviewer)): Enter the serial number from the nameplate
  - *Endress+Hauser Operations app*: Enter serial number from nameplate or scan matrix code on nameplate.

### Standard documentation

-  Supplementary information on the semi-standard options is available in the relevant Special Documentation in the TSP database.

### Brief Operating Instructions

*Brief Operating Instructions for the sensor*

| Measuring instrument | Documentation code |
|----------------------|--------------------|
| Proline Promass E    | KA01260D           |

*Brief Operating Instructions for the transmitter*

| Measuring instrument | Documentation code |                     |             |             |              |
|----------------------|--------------------|---------------------|-------------|-------------|--------------|
|                      | HART               | FOUNDATION Fieldbus | PROFIBUS PA | PROFIBUS DP | Modbus RS485 |
| Proline 300          | KA01309D           | KA01229D            | KA01227D    | KA01386D    | KA01311D     |

*Brief Operating Instructions for the transmitter*

| Measuring instrument | Documentation code |          |                            |            |
|----------------------|--------------------|----------|----------------------------|------------|
|                      | EtherNet/IP        | PROFINET | PROFINET over Ethernet-APL | Modbus TCP |
| Proline 300          | KA01339D           | KA01341D | KA01517D                   | KA01733D   |

### Operating Instructions

| Measuring instrument | Documentation code |                     |             |             |              |
|----------------------|--------------------|---------------------|-------------|-------------|--------------|
|                      | HART               | FOUNDATION Fieldbus | PROFIBUS PA | PROFIBUS DP | Modbus RS485 |
| Promass E 300        | BA01484D           | BA01517D            | BA01506D    | BA01855D    | BA01495D     |

| Measuring instrument | Documentation code |          |                            |            |
|----------------------|--------------------|----------|----------------------------|------------|
|                      | EtherNet/IP        | PROFINET | PROFINET over Ethernet-APL | Modbus TCP |
| Promass E 300        | BA01727D           | BA01738D | BA02110D                   | BA02403D   |

### Description of Device Parameters

| Measuring instrument | Documentation code |                     |             |             |              |
|----------------------|--------------------|---------------------|-------------|-------------|--------------|
|                      | HART               | FOUNDATION Fieldbus | PROFIBUS PA | PROFIBUS DP | Modbus RS485 |
| Promass 300          | GP01057D           | GP01094D            | GP01058D    | GP01134D    | GP01059D     |

| Measuring instrument | Documentation code |          |                            |            |
|----------------------|--------------------|----------|----------------------------|------------|
|                      | EtherNet/IP        | PROFINET | PROFINET over Ethernet-APL | Modbus TCP |
| Promass 300          | GP01114D           | GP01115D | GP01168D                   | GP01235D   |

### Device-dependent additional documentation

#### Safety instructions

Safety instructions for electrical equipment for hazardous areas.

| Contents         | Documentation code |
|------------------|--------------------|
| ATEX/IECEX Ex d  | XA01405D           |
| ATEX/IECEX Ex ec | XA01439D           |
| cCSAus XP        | XA01373D           |
| cCSAus Ex d      | XA01372D           |
| cCSAus Ex ec     | XA01507D           |
| EAC Ex d         | XA01656D           |
| EAC Ex ec        | XA01657D           |
| JPN Ex d         | XA01778D           |
| KCs Ex d         | XA03285D           |
| INMETRO Ex d     | XA01468D           |
| INMETRO Ex ec    | XA01470D           |
| NEPSI Ex d       | XA01469D           |
| NEPSI Ex ec      | XA01471D           |
| UKEX Ex d        | XA02566D           |
| UKEX Ex ec       | XA02568D           |

### Remote display and operating module DKX001

| Contents         | Documentation code |
|------------------|--------------------|
| ATEX/IECEX Ex i  | XA01494D           |
| ATEX/IECEX Ex ec | XA01498D           |
| cCSAus IS        | XA01499D           |
| cCSAus Ex nA     | XA01513D           |
| EAC Ex i         | XA01664D           |
| EAC Ex ec        | XA01665D           |
| INMETRO Ex i     | XA01500D           |

| Contents      | Documentation code |
|---------------|--------------------|
| INMETRO Ex ec | XA01501D           |
| JPN           | XA01781D           |
| KCs Ex i      | XA03280D           |
| NEPSI Ex i    | XA01502D           |
| NEPSI Ex nA   | XA01503D           |
| UKCA Ex i     | XA01494D           |
| UKCA Ex ec    | XA01498D           |

### Functional Safety Manual

| Contents            | Documentation code |
|---------------------|--------------------|
| Proline Promass 300 | SD01727D           |

### Special Documentation

| Contents  | Documentation code |
|---|--------------------|
| Information on the Pressure Equipment Directive                 | SD01614D           |
| Remote display and operating module DKX001                      | SD01763D           |
| Radio approvals for WLAN interface for A309/A310 display module | SD01793D           |
| OPC UA server <sup>1)</sup>                                     | SD02039D           |
| Modbus TCP system integration                                   | SD03408D           |

1) This Special Documentation is only available for device versions with a HART output.

| Contents                     | Documentation code |                     |             |             |              |
|------------------------------|--------------------|---------------------|-------------|-------------|--------------|
|                              | HART               | FOUNDATION Fieldbus | PROFIBUS PA | PROFIBUS DP | Modbus RS485 |
| Web server                   | SD01662D           | SD01665D            | SD01664D    | SD02226D    | SD01663D     |
| Heartbeat Technology         | SD01642D           | SD01696D            | SD01698D    | SD02202D    | SD01697D     |
| Concentration measurement    | SD01644D           | SD01706D            | SD01708D    | SD02212D    | SD01707D     |
| Petroleum                    | SD02097D           | -                   | SD02291D    | SD02216D    | SD02098D     |
| Petroleum & locking function | SD02499D           | -                   | -           | -           | SD02500D     |
| Gas fraction handler         | SD02584D           | -                   | -           | -           | SD02584D     |

| Contents                  | Documentation code |             |                            |            |
|---------------------------|--------------------|-------------|----------------------------|------------|
|                           | PROFINET           | EtherNet/IP | PROFINET over Ethernet-APL | Modbus TCP |
| Web server                | SD01969D           | SD01968D    | SD02762D                   | -          |
| Heartbeat Technology      | SD01988D           | SD01982     | SD02731D                   | SD03350D   |
| Concentration measurement | SD02005D           | SD02004D    | SD02735D                   | SD03354D   |
| Petroleum                 | SD02099D           | SD02096D    | SD02739D                   | SD03358D   |

| Contents                     | Documentation code |             |                            |            |
|------------------------------|--------------------|-------------|----------------------------|------------|
|                              | PROFINET           | EtherNet/IP | PROFINET over Ethernet-APL | Modbus TCP |
| Petroleum & locking function | -                  | -           | SD02739D                   | -          |
| Gas fraction handler         | SD02584D           | -           | SD02584D                   | SD02584D   |

### Installation Instructions

| Contents  | Note   |
|---|--|
| Installation instructions for spare part sets and accessories | The corresponding documentation code is listed with the relevant accessory. → 112. |

## Registered trademarks

### **HART®**

Registered trademark of the FieldComm Group, Austin, Texas USA

### **PROFIBUS®**

Registered trademark of the PROFIBUS Nutzerorganisation e.V. (PROFIBUS User Organization), Karlsruhe, Germany

### **FOUNDATION™ fieldbus**

Registration-pending trademark of the FieldComm Group, Austin, Texas, USA

### **Modbus®**

Registered trademark of SCHNEIDER AUTOMATION, INC.

### **Ethernet/IP™**

Trademark of ODVA, Inc.

### **Ethernet-APL™**

Registered trademark of the PROFIBUS Nutzerorganisation e.V. (PROFIBUS User Organization), Karlsruhe, Germany

### **PROFINET®**

Registered trademark of the PROFIBUS Nutzerorganisation e.V. (PROFIBUS User Organization), Karlsruhe, Germany

### **TRI-CLAMP®**

Registered trademark of Ladish & Co., Inc., Kenosha, USA

---



[www.addresses.endress.com](http://www.addresses.endress.com)

---