

Brief Operating Instructions

Cerabar PMP63B

Process pressure measurement
Analog



These are Brief Operating Instructions; they do not replace the Operating Instructions included in the scope of supply.

Detailed information can be found in the Operating Instructions and the additional documentation.

Available for all device versions via:

- Internet:
www.endress.com/deviceviewer
- Smartphone/tablet:
Endress+Hauser
Operations app



1 Associated documentation



A0023555

2 About this document

2.1 Document function

The Brief Operating Instructions contain all the essential information from incoming acceptance to initial commissioning.

2.2 Symbols

2.2.1 Warning symbols



This symbol alerts you to a dangerous situation. Failure to avoid this situation will result in serious or fatal injury.

⚠ WARNING

This symbol alerts you to a potentially dangerous situation. Failure to avoid this situation can result in serious or fatal injury.

⚠ CAUTION

This symbol alerts you to a potentially dangerous situation. Failure to avoid this situation can result in minor or medium injury.

NOTICE

This symbol alerts you to a potentially harmful situation. Failure to avoid this situation can result in damage to the product or something in its vicinity.

2.2.2 Electrical symbols

Ground connection: \perp

Terminal for connection to the grounding system.

2.2.3 Symbols for certain types of Information

Permitted: 

Procedures, processes or actions that are permitted.

Forbidden: 

Procedures, processes or actions that are forbidden.

Additional information: 

Reference to documentation: 

Reference to page: 

Series of steps: 1, 2, 3.

Result of an individual step: \hookrightarrow



2.2.4 Symbols in graphics

Item numbers: 1, 2, 3 ...

Series of steps: 1, 2, 3.

Views: A, B, C, ...

2.2.5 Symbols on the device

Safety instructions:  \rightarrow 

Observe the safety instructions contained in the associated Operating Instructions.

2.3 Registered trademarks

Bluetooth®

The Bluetooth® wordmark and logos are registered trademarks of Bluetooth SIG, Inc. and any use of these trademarks by Endress+Hauser is licensed. Other trademarks and trade names are those of their respective owners.

Apple®

Apple, the Apple logo, iPhone, and iPod touch are trademarks of Apple Inc., registered in the U.S. and other countries. App Store is a service mark of Apple Inc.

Android®

Android, Google Play and the Google Play logo are trademarks of Google Inc.

3 Basic safety requirements

3.1 Requirements for the personnel

The personnel for installation, commissioning, diagnostics and maintenance must fulfill the following requirements:

- ▶ Trained, qualified specialists must have a relevant qualification for this specific function and task
- ▶ Are authorized by the plant owner/operator
- ▶ Are familiar with federal/national regulations
- ▶ Before beginning work, the specialist staff must have read and understood the instructions in the Operating Instructions and supplementary documentation as well as in the certificates (depending on the application)
- ▶ Follow instructions and comply with conditions

The operating personnel must fulfill the following requirements:

- ▶ Being instructed and authorized according to the requirements of the task by the facility's owner-operator
- ▶ Following the instructions in these Operating Instructions

3.2 Intended use

The Cerabar is a pressure transmitter for measuring level and pressure.

3.2.1 Incorrect use

The manufacturer is not liable for damage caused by improper or non-intended use.

Verification for borderline cases:

- ▶ For special fluids and fluids for cleaning, Endress+Hauser is glad to provide assistance in verifying the corrosion resistance of fluid-wetted materials, but does not accept any warranty or liability.

3.3 Workplace safety

When working on and with the device:

- ▶ Wear the required personal protective equipment according to federal/national regulations.
- ▶ Switch off the supply voltage before connecting the device.

3.4 Operational safety

Risk of injury!

- ▶ Operate the device only if it is in proper technical condition, free from errors and faults.
- ▶ The operator is responsible for the interference-free operation of the device.

Modifications to the device

Unauthorized modifications to the device are not permitted and can lead to unforeseeable dangers:

- ▶ If, despite this, modifications are required, consult with Endress+Hauser.

Repair

To ensure continued operational safety and reliability:

- ▶ Carry out repairs on the device only if they are expressly permitted.
- ▶ Observe federal/national regulations pertaining to the repair of an electrical device.
- ▶ Use original spare parts and accessories from Endress+Hauser only.

Hazardous area

To eliminate the risk of danger to persons or the facility when the device is used in the approval-related area (e.g. explosion protection, pressure equipment safety):

- ▶ Check the nameplate to verify if the device ordered can be put to its intended use in the approval-related area.
- ▶ Observe the specifications in the separate supplementary documentation that is an integral part of these Instructions.

3.5 Product safety

This device is designed in accordance with good engineering practice to meet state-of-the-art safety requirements, has been tested, and left the factory in a condition in which it is safe to operate.

It meets general safety standards and legal requirements. It also complies with the EC directives listed in the device-specific EC Declaration of Conformity. Endress+Hauser confirms this by affixing the CE mark to the device.

4 Incoming acceptance and product identification

4.1 Incoming acceptance

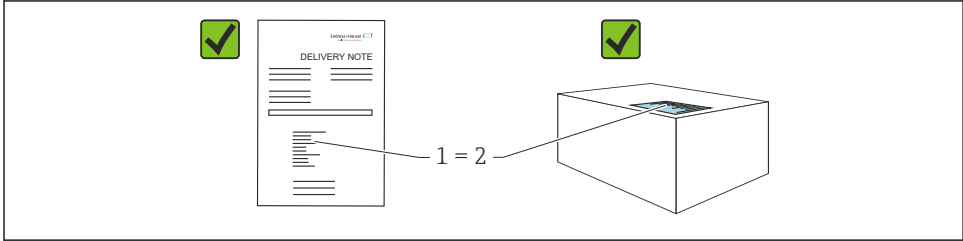

A0016870

- Is the order code on the delivery note (1) identical to the order code on the product sticker (2)?
- Are the goods undamaged?
- Do the data on the nameplate correspond to the order specifications and the delivery note?
- Is the documentation available?
- If required (see nameplate): are the Safety Instructions (XA) provided?

 If you can answer "no" to any of these questions, please contact Endress+Hauser.

4.2 Storage and transport

4.2.1 Storage conditions

- Use the original packaging
- Store the device in clean and dry conditions and protect from damage caused by shocks

Storage temperature range

See Technical Information.

4.2.2 Transporting the product to the measuring point

WARNING

Incorrect transport!

Housing and membrane may become damaged, and there is a risk of injury!

- ▶ Transport the device to the measuring point in the original packaging.

WARNING

Incorrect transport!

Capillaries may become damaged, and there is a risk of injury!

- ▶ Do not use capillaries as a carrying aid for the diaphragm seals.

5 Installation

5.1 Installation requirements

5.1.1 General instructions

- Do not clean or touch the membrane with hard and/or pointed objects.
- Do not remove the protection on the membrane until just before installation.

Always firmly tighten the housing cover and the cable entries.

1. Counter-tighten the cable entries.
2. Tighten the coupling nut.

5.1.2 Installation instructions

- Standard devices are installed according to the same guidelines as pressure gauges (DIN EN837-2).
- To ensure optimal readability of the local display, align the housing and local display.
- Endress+Hauser offers a mounting bracket for installing the device on pipes or walls.
- For measurements in media containing solids (e.g. dirty liquids), it makes sense to install separators and drain valves.
- Using a valve allows for easy commissioning, installation and maintenance without interrupting the process.
- When installing the device, establishing the electrical connection and during operation: prevent moisture from entering the housing.
- Point the cable and connector downwards where possible to prevent moisture from entering (e.g. rain or condensation water).

5.1.3 Installation instructions for thread

- Device with G 1 ½" thread:
Place the flat seal on the sealing surface of the process connection
Avoid additional strain on the membrane: do not seal the thread with hemp or similar materials
- Device with NPT thread:
 - Wrap Teflon tape around the thread to seal it
 - Tighten the device at the hexagon bolt only; do not turn it by the housing
 - When screwing in, do not overtighten the thread; tighten the NPT thread to the required depth according to the standard
- For the following process connections, a tightening torque of max. 40 Nm (29.50 lbf ft) is specified:
 - Thread ISO228 G ½" with flush membrane
 - Thread DIN13 M20 x 1.5 with flush membrane
 - NPT 3/4" with flush membrane

5.1.4 Installation instructions for devices with diaphragm seals

NOTICE

Incorrect handling!

Damage to the device!

- ▶ The diaphragm seal and pressure transmitter together form a sealed, calibrated system filled with fill fluid. Do not open the fill openings under any circumstances.
- ▶ Ensure strain relief to prevent the capillaries from bending (bending radius \geq 100 mm (3.94 in)).
- ▶ Do not use capillaries as a carrying aid for the diaphragm seals.
- ▶ Keep within the application limits of the fill fluid.

General information

In the case of devices with diaphragm seals and capillaries, the zero point shift caused by the hydrostatic pressure of the filling liquid column in the capillaries must be taken into account when selecting the measuring cell. Perform zero adjustment if necessary. If a measuring cell with a small measuring range is selected, the nominal measuring cell range may be overdriven as a result of a position adjustment (position adjustment due to the zero offset caused by the installation position of the fluid column of the fill fluid).

For devices with a capillary, a suitable fastening device (mounting bracket) is recommended for installation.

During installation, ensure sufficient strain relief for the capillary to prevent it from bending (capillary bending radius \geq 100 mm (3.94 in)).

Mount the capillary so that it is vibration-free (in order to avoid additional pressure fluctuations).

Do not mount capillaries in the vicinity of heating or cooling lines and protect them against direct sunlight.

Additional installation instructions are provided in the Applicator "[Sizing Diaphragm Seal](#)".

5.1.5 Orientation

NOTICE

Damage to the device!

If a heated measuring device is cooled during a cleaning process (e.g. by cold water), a vacuum develops for a short time. As a result of this, moisture can enter the measuring cell via the pressure compensation element (1).

- ▶ Mount the device as follows.

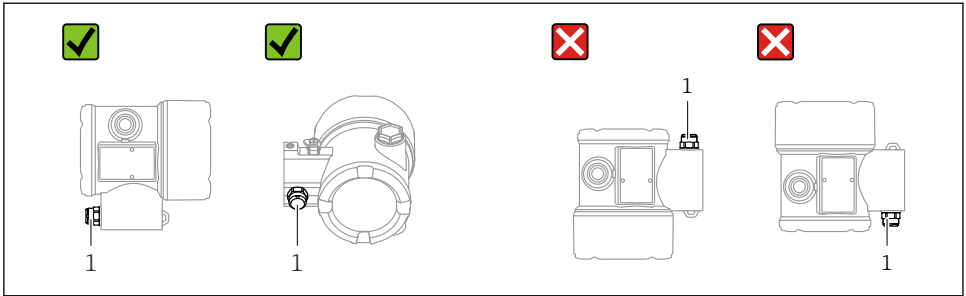

A0038723

- Keep the pressure compensation element (1) free from contamination
- A position-dependent zero point shift (when the vessel is empty the measured value does not display zero) can be corrected
- Diaphragm seals also shift the zero point, depending on the installation position
- The use of shutoff devices and/or siphons is recommended for installation.
- The orientation depends on the measuring application

5.2 Installing the device

5.2.1 Pressure measurement in gases

Mount the device with the shutoff device above the tapping point so that any condensate can flow into the process.

5.2.2 Pressure measurement in steam

Observe the maximum permitted ambient temperature of the transmitter!

Installation:

- Preferably install the device with a circular siphon below the tapping point. The device may also be installed above the tapping point.
- Fill the siphon with fluid before commissioning.

Advantages of using siphons:

- Protects the measuring instrument from hot, pressurized media by forming and accumulating condensate
- Dampens pressure shocks
- The defined water column only causes minimal (negligible) measurement errors and minimal (negligible) thermal effects on the device.



For technical data (e.g. materials, dimensions or order numbers), see the accessory document SD01553P.

5.2.3 Pressure measurement in liquids

Mount the device with the shutoff device below or at the same level as the tapping point.

5.2.4 Level measurement

- Always install the device below the lowest measuring point.
- Do not install the device at the following positions:
 - In the filling curtain
 - In the tank outlet
 - In the suction area of a pump
 - At a point in the tank that could be affected by pressure pulses from the agitator
- Install the device downstream from a shutoff device: the functional test and adjustment can then be carried out more easily.

5.2.5 Closing the housing covers

NOTICE

Thread and housing cover damaged from dirt and fouling!

- ▶ Remove dirt (e.g. sand.) on the thread of the cover and housing.
- ▶ If you continue to encounter resistance when closing the cover, check the thread again for fouling.



Housing thread

The threads of the electronics and connection compartment can be coated with an anti-friction coating.

The following applies for all housing materials:

- ✘ **Do not lubricate the housing threads.**

6 Electrical connection

6.1 Connection requirements

6.1.1 Potential equalization

The protective ground on the device must not be connected. If necessary, the potential matching line can be connected to the outer ground terminal of the device before the device is connected.

⚠ WARNING

Ignitable sparks.

Explosion hazard!

- ▶ Please refer to the separate documentation on applications in hazardous areas for the safety instructions.



For optimum electromagnetic compatibility:

- Use the shortest possible potential matching line.
- Ensure a cross-section of at least 2.5 mm² (14 AWG).

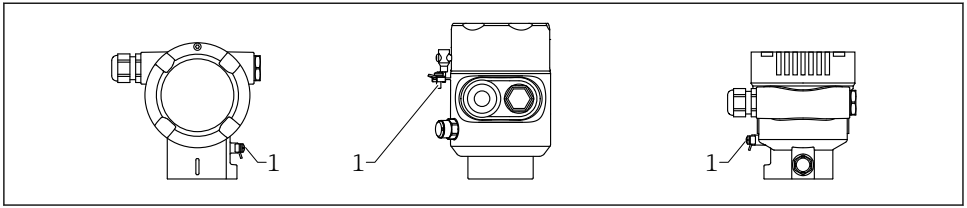

A0057850

1 Ground terminal for connecting the potential matching line

6.2 Connecting the device

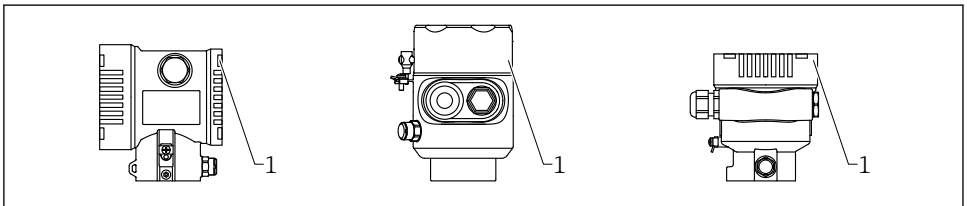

A0058264

1 Connection compartment cover



Housing thread

The threads of the electronics and connection compartment can be coated with an anti-friction coating.

The following applies for all housing materials:

✗ Do not lubricate the housing threads.

6.2.1 Supply voltage

- Ex d, Ex e, non-Ex: supply voltage: 10.5 to 35 V_{DC}
- Ex i: supply voltage: 10.5 to 30 V_{DC}



The power unit must be tested to ensure it meets safety requirements (e.g. PELV, SELV, Class 2) and must comply with the relevant protocol specifications. For 4 to 20 mA, the same requirements apply as for HART.

6.2.2 Terminals

- Supply voltage and inner ground terminal
Clamping range: 0.5 to 2.5 mm² (20 to 14 AWG)
- External ground terminal
Clamping range: 0.5 to 4 mm² (20 to 12 AWG)

6.2.3 Cable specification

- Protective ground or grounding of the cable shield: rated cross-section $> 1 \text{ mm}^2$ (17 AWG)
Rated cross-section of 0.5 mm^2 (20 AWG) to 2.5 mm^2 (13 AWG)
- Cable outer diameter: $\varnothing 5$ to 12 mm (0.2 to 0.47 in) depends on the cable gland used (see Technical Information)

6.2.4 4-20 mA

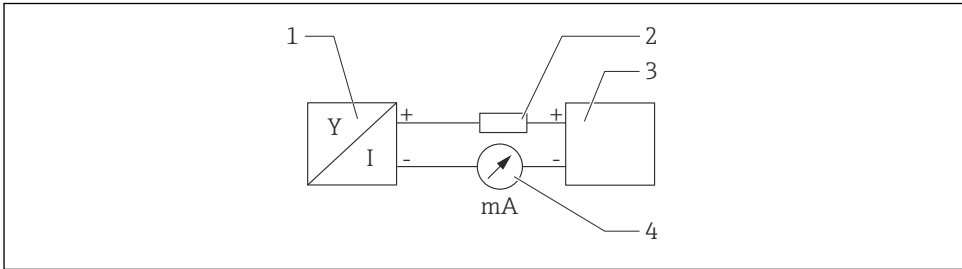

A0028908

1 Block diagram

- 1 Device
- 2 Load
- 3 Power supply
- 4 multimeter

6.2.5 Overvoltage protection

Devices without optional overvoltage protection

Equipment from Endress+Hauser fulfills the requirements of the product standard IEC/DIN EN 61326-1 (Table 2 Industrial Environment).

Depending on the type of port (DC power supply, input/output port) different testing levels according to IEC/DIN EN against transient overvoltages are applied (IEC/DIN EN 61000-4-5 Surge):

Test level on DC power ports and input/output ports is 1 000 V line to earth

Devices with optional overvoltage protection

- Spark-over voltage: min. $400 \text{ V}_{\text{DC}}$
- Tested according to IEC/DIN EN 60079-14 sub chapter 12.3 (IEC/DIN EN 60060-1 chapter 7)
- Nominal discharge current: 10 kA

NOTICE

The device may be damaged by excessively high electrical voltages.

- ▶ Always ground the device with integrated overvoltage protection.

Overvoltage category

Overvoltage category II

6.2.6 Wiring

WARNING

Supply voltage might be connected!

Risk of electric shock and/or explosion!

- ▶ When operating the device in hazardous areas, ensure compliance with national standards and the specifications outlined in the Safety Instructions (XAs). Use the specified cable gland.
- ▶ The supply voltage must match the specifications on the nameplate.
- ▶ Switch off the supply voltage before connecting the device.
- ▶ If necessary, the potential matching line can be connected to the outer ground terminal of the device before the power supply lines are connected.
- ▶ A suitable circuit breaker should be provided for the device in accordance with IEC/EN 61010.
- ▶ The cables must be adequately insulated, with due consideration given to the supply voltage and the overvoltage category.
- ▶ The connecting cables must offer adequate temperature stability, with due consideration given to the ambient temperature.
- ▶ Only operate the device with the covers closed.
- ▶ Protective circuits against reverse polarity, HF influences and overvoltage peaks are installed.

Connect the device in the following order:

1. Release the cover lock (if provided).
2. Unscrew the cover.
3. Guide the cables into the cable glands or cable entries.
4. Connect the cables.
5. Tighten the cable glands or cable entries so that they are leak-tight. Counter-tighten the housing entry. Use a suitable tool with width across flats AF24/25 8 Nm (5.9 lbf ft) for the M20 cable gland.
6. Screw the cover securely back onto the connection compartment.
7. If provided: tighten the screw of the cover lock using the Allen key 0.7 Nm (0.52 lbf ft) ± 0.2 Nm (0.15 lbf ft).

6.2.7 Terminal assignment

Single compartment housing

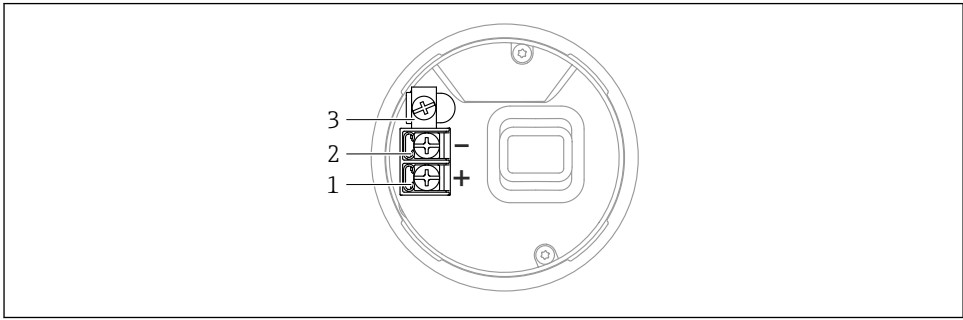

2 Connection terminals and ground terminal in the connection compartment

- 1 Plus terminal
- 2 Minus terminal
- 3 Internal ground terminal

Dual-compartment housing

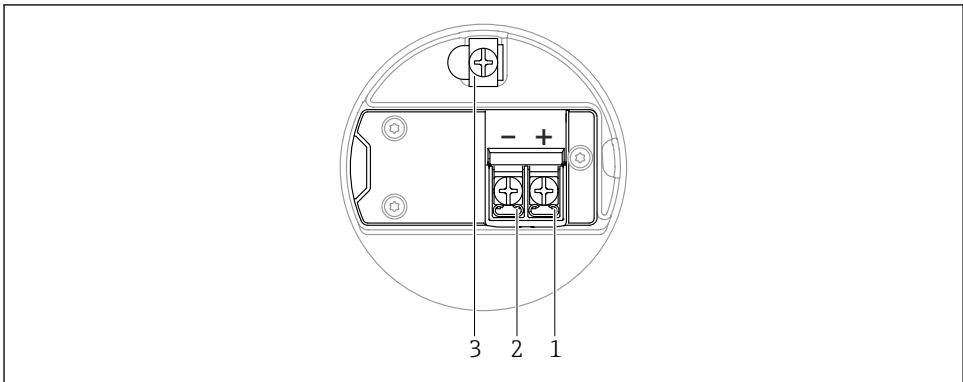

3 Connection terminals and ground terminal in the connection compartment

- 1 Plus terminal
- 2 Minus terminal
- 3 Internal ground terminal

6.2.8 Cable entries

The type of cable entry depends on the device version ordered.

i Always route connecting cables downwards so that moisture cannot penetrate the connection compartment.

If necessary, create a drip loop or use a weather protection cover.

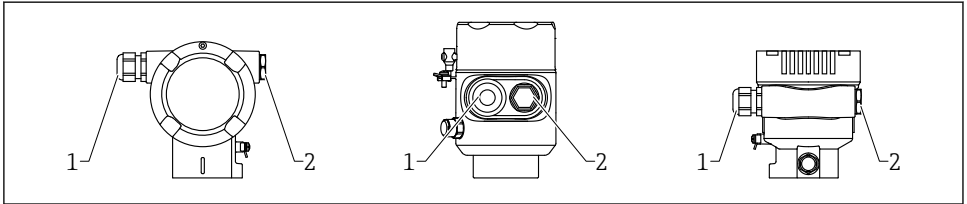

A0057851

1 Cable entry

2 Blind plug

6.2.9 Available device plugs

i In the case of devices with a plug, it is not necessary to open the housing for connection purposes.

Use the enclosed seals to prevent the penetration of moisture into the device.

6.3 Ensuring the degree of protection

6.3.1 Cable entries

- Gland M20, plastic, IP66/68 TYPE 4X/6P
- Gland M20, brass nickel plated, IP66/68 TYPE 4X/6P
- Gland M20, 316L, IP66/68 TYPE 4X/6P
- Thread M20, IP66/68 TYPE 4X/6P
- Thread G1/2, IP66/68 TYPE 4X/6P

If the G1/2 thread is selected, the device is delivered with an M20 thread as standard and a G1/2 adapter is included with the delivery, along with the corresponding documentation

- Thread NPT1/2, IP66/68 TYPE 4X/6P
- Dummy plug transport protection: IP22, TYPE 2
- M12 plug

When housing is closed and connecting cable is plugged in: IP66/67, NEMA Type 4X

When housing is open or connecting cable is not plugged in: IP20, NEMA Type 1

NOTICE**M12 plug: incorrect installation can invalidate the IP protection class!**

- ▶ The degree of protection only applies if the connecting cable used is plugged in and screwed tight.
- ▶ The degree of protection only applies if the connecting cable used is specified according to IP67, NEMA Type 4X.
- ▶ The IP protection classes are only maintained if the dummy cap is used or the cable is connected.

7 Operation options

7.1 Operating keys and DIP switches on the electronic insert

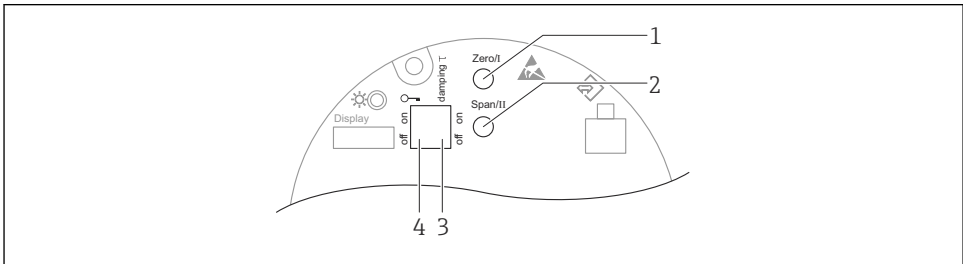

A0039344

- 1 *Operating key for lower range value (Zero)*
- 2 *Operating key for upper range value (Span)*
- 3 *DIP switch for damping*
- 4 *DIP switch for locking and unlocking the device*

i The setting of the DIP switches has priority over the settings made via other operation methods (e.g. FieldCare/DeviceCare).

7.2 local display

7.2.1 Device display (optional)

Functions:

- Display measured values and fault and notice messages
- Background lighting, which switches from green to red in the event of an error
- The device display can be removed for easier operation

i The device displays are available with the additional option of Bluetooth® wireless technology.

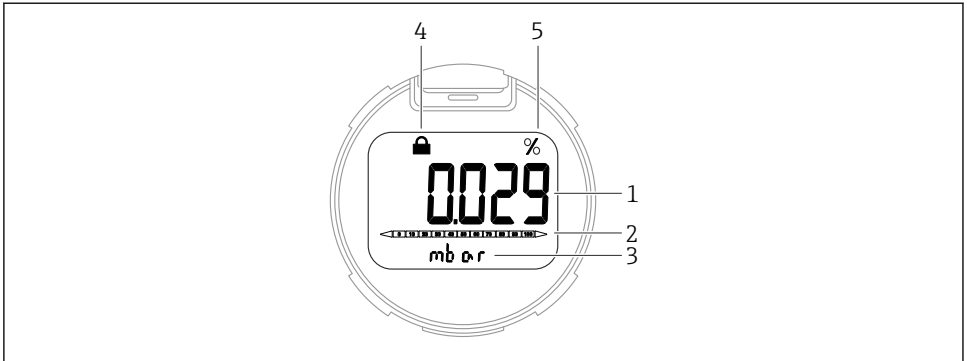

A0047140

4 Segment display

- 1 Measured value (up to 5 digits)
- 2 Bar graph (refers to the specified pressure range) proportional to current output
- 3 Unit of measured value
- 4 Locking (symbol appears when device is locked)
- 5 Measured value output in %

The following graphics are examples. The display depends on the display settings.

- **+** key
 - Navigate downwards in the selection list
 - Edit the numerical values or characters within a function
- **-** key
 - Navigate upwards in the selection list
 - Edit the numerical values or characters within a function
- **Enter** key
 - Confirm entry
 - Jump to the next item
 - Select a menu item and activate edit mode
 - Unlock/lock the display operation
 - Press and hold the **Enter** key to display a short description of the selected parameter (if available)
- **+** key and **-** key (ESC function)
 - Exit the edit mode for a parameter without saving the changed value
 - Menu at a selection level: pressing the keys simultaneously takes the user back up a level in the menu
 - Press and hold the keys simultaneously to return to the upper level

8 Commissioning

8.1 Preparatory steps

The measuring range and the unit in which the measured value is transmitted correspond to the specifications on the nameplate.

WARNING

Process pressure above or below permitted maximum/minimum!

Risk of injury if parts burst! Warnings are displayed if the pressure is too high.

- ▶ If a pressure smaller than the minimum permitted pressure or greater than the maximum permitted pressure is present at the device, a message is output.
- ▶ Only use the device within the measuring range limits.

8.1.1 As-delivered state

If no customized settings were ordered:

- Calibration values defined by defined measuring cell nominal value
- The alarm current is set to min. (3.6 mA), (only if no other option was selected when ordering)
- DIP switch to Off position

8.2 Function check

Perform a function check before putting the measuring point into operation:



- "Post-installation check" checklist (see the "Installation" section)
- "Post-connection check" checklist (see the "Electrical connection" section)

8.3 Setting the operating language

8.3.1 Local display

Setting the operating language

 To set the operating language, the display first needs to be unlocked:

1. Press the  key for at least 2 s.
↳ A dialog box appears.
2. Unlock the display operation.
3. In the main menu, select the **Language** parameter.
4. Press the  key.
5. Select the desired language with the  key.

6. Press the  key.



Display operation locks automatically in the following cases:

- after 1 min on the main page if no key has been pressed
- after 10 min within the operating menu if no key has been pressed

Display operation - locking or unlocking

The  key must be pressed for at least 2 seconds in order to lock or unlock the optical keys. Display operation can be locked or unlocked in the dialog that appears.

Display operation locks automatically:

- After 1 minute on the main page if no key has been pressed
- After 10 minutes within the operating menu if no key has been pressed

8.3.2 Operating tool

See the description of the relevant operating tool.

8.4 Configuring the measuring instrument

8.4.1 Commissioning with keys on the electronic insert

The following functions are possible via the keys on the electronic insert:

- Position adjustment (zero point correction)
The orientation of the device may cause a pressure shift
This pressure shift can be corrected by a position adjustment
- Setting the lower range value and upper range value
The pressure applied must be within the nominal pressure limits of the sensor (see the specifications on the nameplate)
- Resetting the device

Performing position adjustment

1. Device installed in required position and no pressure is applied.
2. Press the "Zero" and "Span" keys simultaneously for at least 3 seconds.
3. When the LED lights up briefly, the pressure present has been accepted for position adjustment.

Setting the lower range value (pressure or scaled variable)

1. The desired pressure for the lower range value is present at the device.
2. Press "Zero" for at least 3 s.
3. When the LED lights up briefly, the pressure present has been accepted for the lower range value.

Setting the upper range value (pressure or scaled variable)

1. The desired pressure for the upper range value is present at the device.
2. Press "Span" for at least 3 seconds.

3. When the LED lights up briefly, the pressure present has been accepted for the upper range value.
4. Does the LED on the electronic insert not light up?
 - ↳ Applied pressure for upper range value has not been accepted.
Wet calibration is not possible if, in the **Assign PV** parameter **Scaled variable** option and in **Scaled variable transfer function** parameter **Table** option has been selected.

Checking the settings (pressure or scaled variable)

1. Press "Zero" key briefly (approx. 1 second) to display the lower range value.
2. Press "Span" key briefly (approx. 1 second) to display the upper range value.
3. Press "Zero" and "Span" keys briefly and at the same time (approx. 1 second) to display the calibration offset.

Resetting the device

- ▶ Press and hold "Zero" and "Span" simultaneously for at least 12 seconds.



71752030

www.addresses.endress.com
