

Operating Instructions

Proline Promag H 500

Electromagnetic flowmeter
Modbus TCP



- Make sure the document is stored in a safe place such that it is always available when working on or with the device.
- To avoid danger to individuals or the facility, read the "Basic safety instructions" section carefully, as well as all other safety instructions in the document that are specific to working procedures.
- The manufacturer reserves the right to modify technical data without prior notice. Your Endress+Hauser sales organization will supply you with current information and updates to this manual.

Table of contents

1	About this document	6	6	Installation	22
1.1	Document function	6	6.1	Installation requirements	22
1.2	Symbols	6	6.1.1	Installation position	22
1.2.1	Safety symbols	6	6.1.2	Environmental and process requirements	28
1.2.2	Electrical symbols	6	6.1.3	Special installation instructions	30
1.2.3	Communication-specific symbols	6	6.2	Installing the measuring instrument	30
1.2.4	Tool symbols	7	6.2.1	Required tools	30
1.2.5	Symbols for certain types of information	7	6.2.2	Preparing the measuring device	31
1.2.6	Symbols in graphics	7	6.2.3	Installing the sensor	31
1.3	Documentation	8	6.2.4	Installing the transmitter housing: Proline 500 – digital	33
1.4	Registered trademarks	8	6.2.5	Installing the transmitter housing: Proline 500	35
2	Safety instructions	9	6.2.6	Turning the transmitter housing: Proline 500	36
2.1	Requirements for the personnel	9	6.2.7	Turning the display module: Proline 500	36
2.2	Intended use	9	6.3	Post-installation check	37
2.3	Workplace safety	10	7	Electrical connection	38
2.4	Operational safety	10	7.1	Electrical safety	38
2.5	Product safety	10	7.2	Connecting requirements	38
2.6	IT security	10	7.2.1	Required tools	38
2.7	Device-specific IT security	11	7.2.2	Requirements for connection cable	38
2.7.1	Protecting access via hardware write protection	11	7.2.3	Terminal assignment	42
2.7.2	Protecting access via a password	11	7.2.4	Available device plugs for Proline 500	42
2.7.3	Access via web server	12	7.2.5	Available device plugs for Proline 500 digital	43
2.7.4	Access via service interface (port 2): CDI-RJ45	12	7.2.6	Modbus TCP over Ethernet 100 Mbit/s	43
2.7.5	Advanced safety requirements	12	7.2.7	Modbus TCP over Ethernet-APL 10 Mbit/s	43
3	Product description	14	7.2.8	Preparing the device	44
3.1	Product design	14	7.2.9	Preparing the connecting cable: Proline 500 – digital	45
3.1.1	Proline 500 – digital	14	7.2.10	Preparing the connecting cable: Proline 500	45
3.1.2	Proline 500	15	7.3	Connecting the device: Proline 500 – digital	48
4	Incoming acceptance and product identification	16	7.3.1	Connecting the connecting cable	48
4.1	Incoming acceptance	16	7.3.2	Connecting the transmitter	53
4.2	Product identification	16	7.4	Connecting the device: Proline 500	56
4.2.1	Transmitter nameplate	17	7.4.1	Connecting the connecting cable	56
4.2.2	Sensor nameplate	19	7.5	Ensuring potential equalization	58
4.2.3	Symbols on the device	20	7.5.1	Requirements	58
5	Storage and transport	21	7.5.2	Connection example, standard scenario	59
5.1	Storage conditions	21	7.5.3	Connection example in special situations	59
5.2	Transporting the product	21	7.6	Special connection instructions	60
5.2.1	Measuring devices without lifting lugs	21	7.6.1	Connection examples	60
5.2.2	Measuring devices with lifting lugs	22	7.7	Hardware settings	62
5.2.3	Transporting with a fork lift	22	7.7.1	Setting the device address	62
5.3	Packaging disposal	22	7.7.2	Activating the default IP address	64

7.8	Ensuring the degree of protection	65			
7.9	Post-connection check	66			
8	Operation options	67			
8.1	Overview of operation options	67			
8.2	Structure and function of the operating menu	68			
	8.2.1 Structure of the operating menu	68			
	8.2.2 Operating philosophy	69			
8.3	Access to operating menu via local display ...	70			
	8.3.1 Operational display	70			
	8.3.2 Navigation view	72			
	8.3.3 Editing view	74			
	8.3.4 Operating elements	76			
	8.3.5 Opening the context menu	76			
	8.3.6 Navigating and selecting from list ...	78			
	8.3.7 Calling the parameter directly	78			
	8.3.8 Calling up help text	79			
	8.3.9 Changing the parameters	79			
	8.3.10 User roles and related access authorization	80			
	8.3.11 Disabling write protection via access code	80			
	8.3.12 Enabling and disabling the keypad lock	81			
8.4	Access to operating menu via web browser ...	81			
	8.4.1 Function range	81			
	8.4.2 Requirements	82			
	8.4.3 Connecting the device	83			
	8.4.4 Logging on	85			
	8.4.5 User interface	86			
	8.4.6 Disabling the Web server	87			
	8.4.7 Logging out	87			
8.5	Operation via SmartBlue app	88			
8.6	Access to the operating menu via the operating tool	88			
	8.6.1 Connecting the operating tool	89			
	8.6.2 FieldCare	93			
	8.6.3 DeviceCare	93			
9	System integration	94			
9.1	Overview of device description files	94			
	9.1.1 Current version data for the device ...	94			
	9.1.2 Operating tools	94			
9.2	Modbus TCP system integration	94			
10	Commissioning	95			
10.1	Post-installation and post-connection check ..	95			
10.2	Switching on the measuring instrument	95			
10.3	Connecting via FieldCare	95			
10.4	Setting the operating language	95			
10.5	Configuring the device	96			
	10.5.1 Displaying the communication interface	97			
	10.5.2 Setting the system units	100			
	10.5.3 Displaying the I/O configuration ...	102			
	10.5.4 Configuring the current input	103			
	10.5.5 Configuring the status input	104			
	10.5.6 Configuring the current output	105			
	10.5.7 "Pulse/frequency/switch output 1 to n" wizard	108			
	10.5.8 Configuring the relay output	112			
	10.5.9 Configuring the double pulse output ..	114			
	10.5.10 Configuring the local display	115			
	10.5.11 Configuring the low flow cut off	118			
	10.5.12 Configuring empty pipe detection ..	119			
	10.5.13 Configuring flow damping	120			
10.6	Advanced settings	122			
	10.6.1 Carrying out a sensor adjustment ...	122			
	10.6.2 Configuring the totalizer	123			
	10.6.3 "Custody transfer activation" wizard ..	124			
	10.6.4 "Custody transfer deactivation" wizard	126			
	10.6.5 Carrying out additional display configurations	128			
	10.6.6 Performing electrode cleaning	130			
	10.6.7 WLAN configuration	131			
	10.6.8 Performing Heartbeat Technology basic setup	132			
	10.6.9 Configuration management	133			
	10.6.10 Using parameters for device administration	134			
10.7	Simulation	136			
	10.7.1 Process value simulation	138			
	10.7.2 Simulation input	138			
	10.7.3 Output simulation	139			
	10.7.4 Diagnostic event simulation	140			
10.8	Protecting settings from unauthorized access	141			
	10.8.1 Write protection via access code ...	141			
	10.8.2 Write protection via write protection switch	142			
11	Operation	145			
11.1	Reading the device locking status	145			
11.2	Reading off measured values	145			
	11.2.1 "Process variables" submenu	145			
	11.2.2 "Input values" submenu	147			
	11.2.3 Output values	148			
	11.2.4 Totalizer	150			
11.3	Adapting the measuring device to the process conditions	151			
11.4	Performing a totalizer reset	151			
	11.4.1 Function scope of "Control Totalizer" parameter	151			
	11.4.2 Function range of "Reset all totalizers" parameter	152			
12	Diagnostics and troubleshooting ..	153			
12.1	General troubleshooting	153			
12.2	Diagnostic information via LEDs	155			
	12.2.1 Transmitter	155			
	12.2.2 Sensor connection housing	156			
12.3	Diagnostic information on local display	158			
	12.3.1 Diagnostic message	158			
	12.3.2 Calling up remedial actions	160			

12.4	Diagnostic information in the web browser . .	160	16.3	Input	180
12.4.1	Diagnostic options	160	16.4	Output	184
12.4.2	Calling up remedial actions	161	16.5	Power supply	191
12.5	Diagnostic information in FieldCare or DeviceCare	161	16.6	Performance characteristics	192
12.5.1	Diagnostic options	161	16.7	Installation	194
12.5.2	Calling up remedy information	162	16.8	Environment	194
12.6	Diagnostic information via communication interface	162	16.9	Process	195
12.6.1	Reading out diagnostic information	162	16.10	Mechanical construction	197
12.6.2	Configuring error response mode . . .	163	16.11	User interface	201
12.7	Adapting the diagnostic information	163	16.12	Certificates and approvals	204
12.7.1	Adapting the diagnostic behavior . . .	163	16.13	Application packages	207
12.8	Overview of diagnostic information	163	16.14	Accessories	208
12.9	Pending diagnostic events	168	16.15	Documentation	208
12.10	Diagnostic list	168	Index	211	
12.11	Event logbook	169			
12.11.1	Reading out the event logbook	169			
12.11.2	Filtering the event logbook	170			
12.11.3	Overview of information events	170			
12.12	Resetting the device	171			
12.12.1	Function scope of the "Device reset" parameter	171			
12.13	Device information	172			
12.14	Firmware history	173			
13	Maintenance	174			
13.1	Maintenance tasks	174			
13.1.1	Cleaning	174			
13.1.2	Replacing seals	174			
13.2	Measuring and test equipment	174			
13.3	Maintenance services	174			
14	Repair	175			
14.1	General notes	175			
14.1.1	Repair and conversion concept	175			
14.1.2	Notes for repair and conversion	175			
14.2	Spare parts	175			
14.3	Repair services	175			
14.4	Return	175			
14.5	Disposal	176			
14.5.1	Removing the measuring instrument	176			
14.5.2	Disposing of the measuring instrument	176			
15	Accessories	177			
15.1	Device-specific accessories	177			
15.1.1	For the transmitter	177			
15.1.2	For the sensor	178			
15.2	Service-specific accessories	179			
15.3	System components	179			
16	Technical data	180			
16.1	Application	180			
16.2	Function and system design	180			

1 About this document

1.1 Document function

These Operating Instructions contain all the information required in the various life cycle phases of the device: from product identification, incoming acceptance and storage, to installation, connection, operation and commissioning, through to troubleshooting, maintenance and disposal.

1.2 Symbols

1.2.1 Safety symbols

DANGER

This symbol alerts you to a dangerous situation. Failure to avoid this situation will result in serious or fatal injury.

WARNING

This symbol alerts you to a potentially dangerous situation. Failure to avoid this situation can result in serious or fatal injury.





CAUTION

This symbol alerts you to a potentially dangerous situation. Failure to avoid this situation can result in minor or medium injury.



NOTICE



This symbol alerts you to a potentially harmful situation. Failure to avoid this situation can result in damage to the product or something in its vicinity.

1.2.2 Electrical symbols



Symbol	Meaning
	Direct current
	Alternating current
	Direct current and alternating current
	Ground connection A grounded terminal which, as far as the operator is concerned, is grounded via a grounding system.
	Protective earth (PE) Ground terminals that must be connected to ground prior to establishing any other connections. The ground terminals are located on the interior and exterior of the device: <ul style="list-style-type: none"> ▪ Interior ground terminal: protective earth is connected to the mains supply. ▪ Exterior ground terminal: device is connected to the plant grounding system.

1.2.3 Communication-specific symbols













Symbol	Meaning
	Wireless Local Area Network (WLAN) Communication via a wireless, local area network
	LED LED is off.

Symbol	Meaning
	LED LED is on.
	LED LED flashing.





1.2.4 Tool symbols



Symbol	Meaning
	Torx screwdriver
	Phillips screwdriver
	Open-end wrench

1.2.5 Symbols for certain types of information

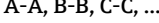
Symbol	Meaning
	Permitted Procedures, processes or actions that are permitted.
	Preferred Procedures, processes or actions that are preferred.
	Forbidden Procedures, processes or actions that are forbidden.
	Tip Indicates additional information.
	Reference to documentation
	Reference to page
	Reference to graphic
	Notice or individual step to be observed
	Series of steps
	Result of a step
	Help in the event of a problem
	Visual inspection

1.2.6 Symbols in graphics

Symbol	Meaning
	Item numbers
	Series of steps
	Views
	Sections
	Hazardous area

Symbol	Meaning
	Safe area (non-hazardous area)
	Flow direction

1.3 Documentation

 For an overview of the scope of the associated Technical Documentation, refer to the following:

- *Device Viewer* (www.endress.com/deviceviewer): Enter the serial number from the nameplate
- *Endress+Hauser Operations app*: Enter serial number from nameplate or scan matrix code on nameplate.

The following document types are available in the Downloads area of the Endress+Hauser website (www.endress.com/downloads), depending on the product configuration:

Document type	Purpose and content of the document
Technical Information (TI)	Planning aid This document contains all the technical data on the product and provides an overview of everything that can be ordered with the product.
Brief Operating Instructions (KA)	Quick guide to obtaining the first measured value The Operating Instructions contain all the essential information about the product from incoming acceptance to initial commissioning.
Operating Instructions (BA)	Reference The Operating Instructions contain the information that is required in the various phases of the life cycle of the product: From product identification, incoming acceptance and storage, to mounting, connection, operation and commissioning through to troubleshooting, maintenance and disposal.
Description of Device Parameters (GP)	Reference for parameters The document contains detailed explanations of readable or configurable parameters in the product. The description is aimed at those who work with the product over its entire life cycle and perform specific configurations.
Safety Instructions (XA)	Safety Instructions for electrical equipment in hazardous areas are supplied with the product depending on the approval. These are an integral part of the Operating Instructions.  The nameplate indicates the Safety Instructions (XA) that are relevant to the product.
Supplementary device-dependent documentation (SD/FY)	Always comply strictly with the instructions in the relevant supplementary documentation. The supplementary documentation is an integral part of the product documentation.

1.4 Registered trademarks

Modbus®

Registered trademark of SCHNEIDER AUTOMATION, INC.

2 Safety instructions

2.1 Requirements for the personnel

The personnel for installation, commissioning, diagnostics and maintenance must fulfill the following requirements:

- ▶ Trained, qualified specialists must have a relevant qualification for this specific function and task.
- ▶ Are authorized by the plant owner/operator.
- ▶ Are familiar with federal/national regulations.
- ▶ Before starting work, read and understand the instructions in the manual and supplementary documentation as well as the certificates (depending on the application).
- ▶ Follow instructions and comply with basic conditions.

The operating personnel must fulfill the following requirements:

- ▶ Are instructed and authorized according to the requirements of the task by the facility's owner-operator.
- ▶ Follow the instructions in this manual.

2.2 Intended use

Application and media

The measuring instrument described in this manual is intended only for the flow measurement of liquids with a minimum conductivity of 5 $\mu\text{S}/\text{cm}$.

Depending on the version ordered, the measuring instrument can also measure potentially explosive, flammable, poisonous and oxidizing media.

Measuring instruments for use in hazardous areas, in hygienic applications, or where there is an increased risk due to pressure, are specially labeled on the nameplate.

To ensure that the measuring instrument remains in proper condition during the operating time:

- ▶ Only use the measuring instrument in full compliance with the data on the nameplate and the general conditions listed in the manual and supplementary documentation.
- ▶ Using the nameplate, check whether the ordered device is permitted for the intended use in the hazardous area (e.g. explosion protection, pressure vessel safety).
- ▶ Use the measuring instrument only for media against which the materials in contact with the process are sufficiently resistant.
- ▶ Keep within the specified pressure and temperature range.
- ▶ Keep within the specified ambient temperature range.
- ▶ Protect the measuring instrument permanently against corrosion from environmental influences.

Incorrect use

Non-designated use can compromise safety. The manufacturer is not liable for damage caused by improper or non-designated use.

WARNING

Danger of breakage due to corrosive or abrasive fluids and ambient conditions!

- ▶ Verify the compatibility of the process fluid with the sensor material.
- ▶ Ensure the resistance of all wetted materials during the process.
- ▶ Keep within the specified pressure and temperature range.

NOTICE**Verification for borderline cases:**

- ▶ For special fluids and fluids for cleaning, Endress+Hauser is glad to provide assistance in verifying the corrosion resistance of fluid-wetted materials, but does not accept any warranty or liability as minute changes in the temperature, concentration or level of contamination in the process can alter the corrosion resistance properties.

Residual risks**⚠ WARNING****Risk of hot or cold burns! The use of media and electronics with high or low temperatures can produce hot or cold surfaces on the device.**

- ▶ Mount suitable touch protection.

2.3 Workplace safety

For work on and with the device:

- ▶ Wear the required personal protective equipment according to federal/national regulations.

2.4 Operational safety

Damage to the device!

- ▶ Operate the device in proper technical condition and fail-safe condition only.
- ▶ The operator is responsible for the interference-free operation of the device.

Modifications to the device

Unauthorized modifications to the device are not permitted and can lead to unforeseeable dangers!

- ▶ If modifications are nevertheless required, consult with the manufacturer.

Repair

To ensure continued operational safety and reliability:

- ▶ Carry out repairs on the device only if they are expressly permitted.
- ▶ Observe federal/national regulations pertaining to the repair of an electrical device.
- ▶ Use only original spare parts and accessories.

2.5 Product safety

This state-of-the-art device is designed and tested in accordance with good engineering practice to meet operational safety standards. It left the factory in a condition in which it is safe to operate.

It meets general safety standards and legal requirements. It also complies with the EU directives listed in the device-specific EU declaration of conformity. The manufacturer confirms this by affixing the CE mark.





2.6 IT security

The manufacturer warranty is valid only if the product is installed and used as described in the Operating Instructions. The product is equipped with security mechanisms to protect it against any inadvertent changes to the settings.

IT security measures, which provide additional protection for the product and associated data transfer, must be implemented by the operators themselves in line with their security standards.

2.7 Device-specific IT security

The device offers a range of specific functions to support protective measures on the operator's side. These functions can be configured by the user and guarantee greater in-operation safety if used correctly. The following list provides an overview of the most important functions:

Function/interface	Factory setting	Recommendation
Write protection via hardware write protection switch →  11	Not enabled	On an individual basis following risk assessment
Access code (also applies to web server login or FieldCare connection) →  11	Not enabled (0000)	Assign a customized access code during commissioning
WLAN (order option in display module)	Enabled	On an individual basis following risk assessment
WLAN security mode	Enabled (WPA2-PSK)	Do not change
WLAN passphrase (Password) →  12	Serial number	Assign an individual WLAN passphrase during commissioning
WLAN mode	Access point	On an individual basis following risk assessment
Web server →  12	Enabled	On an individual basis following risk assessment
Service interface CDI-RJ45 →  12	Enabled	-

2.7.1 Protecting access via hardware write protection

Write access to the parameters of the device via the local display, web browser or operating tool (e.g. FieldCare, DeviceCare) can be disabled via a write protection switch (DIP switch on the main electronics module). When hardware write protection is enabled, only read access to the parameters is possible.

Hardware write protection is disabled when the device is delivered →  142.

2.7.2 Protecting access via a password

Different passwords are available to protect write access to the device parameters or access to the device via the WLAN interface.

- **User-specific access code**
Protect write access to the device parameters via the local display, web browser or operating tool (e.g. FieldCare, DeviceCare). Access authorization is clearly regulated through the use of a user-specific access code.
- **WLAN passphrase**
The network key protects a connection between an operating unit (e.g. notebook or tablet) and the device via the WLAN interface which can be ordered as an option.
- **Infrastructure mode**
When the device is operated in infrastructure mode, the WLAN passphrase corresponds to the WLAN passphrase configured on the operator side.

User-specific access code

Local display, web browser and operating tool (e.g. FieldCare, DeviceCare)

- Write access to the device parameters via the local display, web browser or operating tool (e.g. FieldCare, DeviceCare) can be protected by the modifiable, user-specific access code →  141.
- When delivered, the device does not have an access code; the default value is 0000 (open).

WLAN passphrase: Operation as WLAN access point

A connection between an operating unit (e.g. notebook or tablet) and the device via the WLAN interface (→  91), which can be ordered as an optional extra, is protected by the network key. The WLAN authentication of the network key complies with the IEEE 802.11 standard.

When the device is delivered, the network key is pre-defined depending on the device. It can be changed via the **WLAN settings** submenu in the **WLAN passphrase** parameter (→  132).

Infrastructure mode

A connection between the device and WLAN access point is protected by means of an SSID and passphrase on the system side. Please contact the relevant system administrator for access.

General notes on the use of passwords

- The access code and network key supplied with the device should be changed during commissioning for security reasons.
- Follow the general rules for generating a secure password when defining and managing the access code or network key.
- The user is responsible for the management and careful handling of the access code and network key.
- For information on configuring the access code or on what to do if you lose the password, for example, see "Write protection via access code" →  141.

2.7.3 Access via web server

The integrated web server can be used to operate and configure the device by means of a web browser via Ethernet-APL, the service interface (CDI-RJ45) or via WLAN interface.

The web server is enabled when the device is delivered. The web server can be disabled if necessary via the **Web server functionality** parameter (e.g., after commissioning).

The device and status information can be hidden on the login page. This prevents unauthorized access to the information.



For detailed information on device parameters, see: Description of Device Parameters.

2.7.4 Access via service interface (port 2): CDI-RJ45

The device can be connected to a network via the service interface. Device-specific functions guarantee the secure operation of the device in a network.

The use of relevant industrial standards and guidelines that have been defined by national and international safety committees, such as IEC/ISA62443 or the IEEE, is recommended. This includes organizational security measures such as the assignment of access authorization as well as technical measures such as network segmentation.



For detailed information on connecting transmitters with an Ex de approval, see separate document "Safety instructions" (XA) for the device.

2.7.5 Advanced safety requirements

If the specified requirements for measures cannot be met, alternative measures may need to be put in place. This may involve, for example, mechanical protection of the product against tampering, the cabling, or organizational measures. The Proline measuring instruments can be used in the open field for example. Measures to combat physical tampering of the Proline measuring instruments must be arranged by the customer.

Additional analysis is required if Proline measuring instruments are integrated into a different system. Please note the following:

- The fieldbus network (OT) and company network (IT) must be strictly separated.
- Endress+Hauser recommends the segmentation of the fieldbus networks according to DIN IEC 62443-3-3.

Network

Pay particular attention to the network components used, the router and switches for example. The operator must guarantee the integrity of the components. Access to the network must be restricted by the operator, if necessary.

FDI Packages

Signed FDI Packages can be obtained via www.endress.com for the configuration of the field device.

User training

Depending on the application scenario, users who are not specialized in this area may come in contact with the instrument. We recommend that these users be trained in the safe use of the relevant terminals, components and/or interfaces and be made aware of security issues.

3 Product description

The measuring system consists of a transmitter and a sensor. The transmitter and sensor are mounted in physically separate locations. They are interconnected by connecting cables.

3.1 Product design

Two versions of the transmitter are available.

3.1.1 Proline 500 – digital

Signal transmission: digital

Order code for "Integrated ISEM electronics", option **A** "Sensor"

For use in applications not required to meet special requirements due to ambient or operating conditions.

As the electronics are located in the sensor, the device is ideal:

For simple transmitter replacement.

- A standard cable can be used as the connecting cable.
- Not sensitive to external EMC interference.

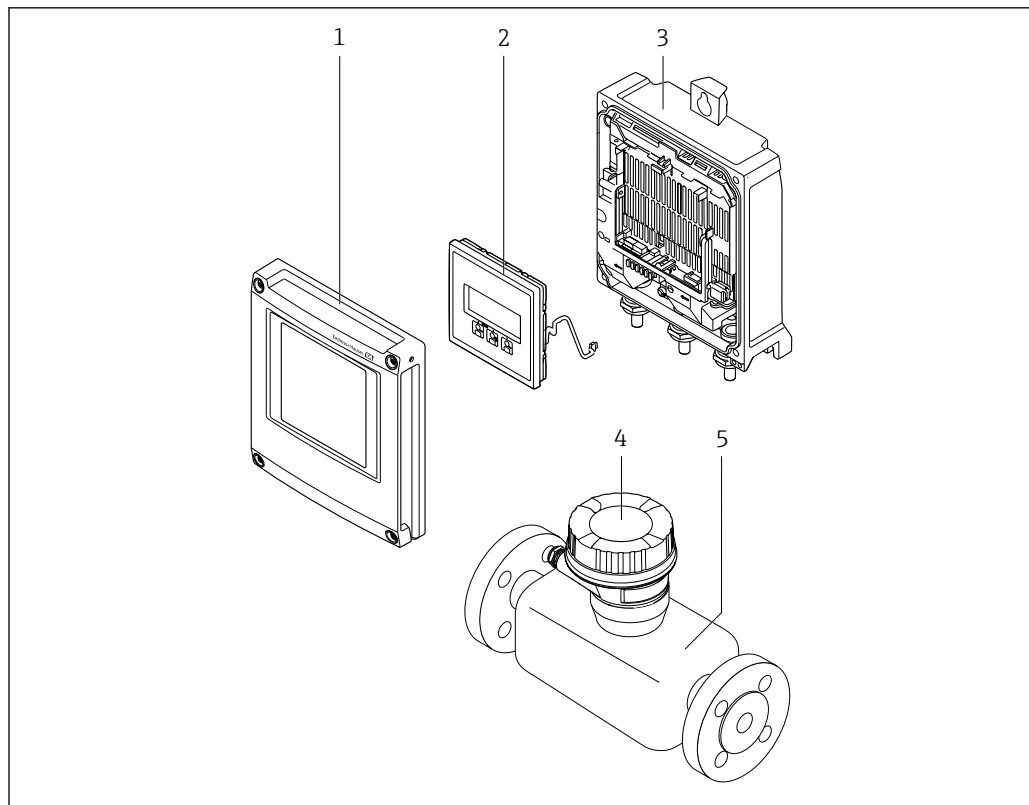

A0029593

1 Important components of a measuring device

- 1 Electronics compartment cover
- 2 Display module
- 3 Transmitter housing
- 4 Sensor connection housing with integrated ISEM electronics: connecting cable connection
- 5 Sensor

3.1.2 Proline 500

Signal transmission: analog

Order code for "Integrated ISEM electronics", option **B** "Transmitter"

For use in applications required to meet special requirements due to ambient or operating conditions.

As the electronics are located in the transmitter, the device is ideal in the event of:

- Sensor operation in underground installations.
- Permanent sensor immersion in water.

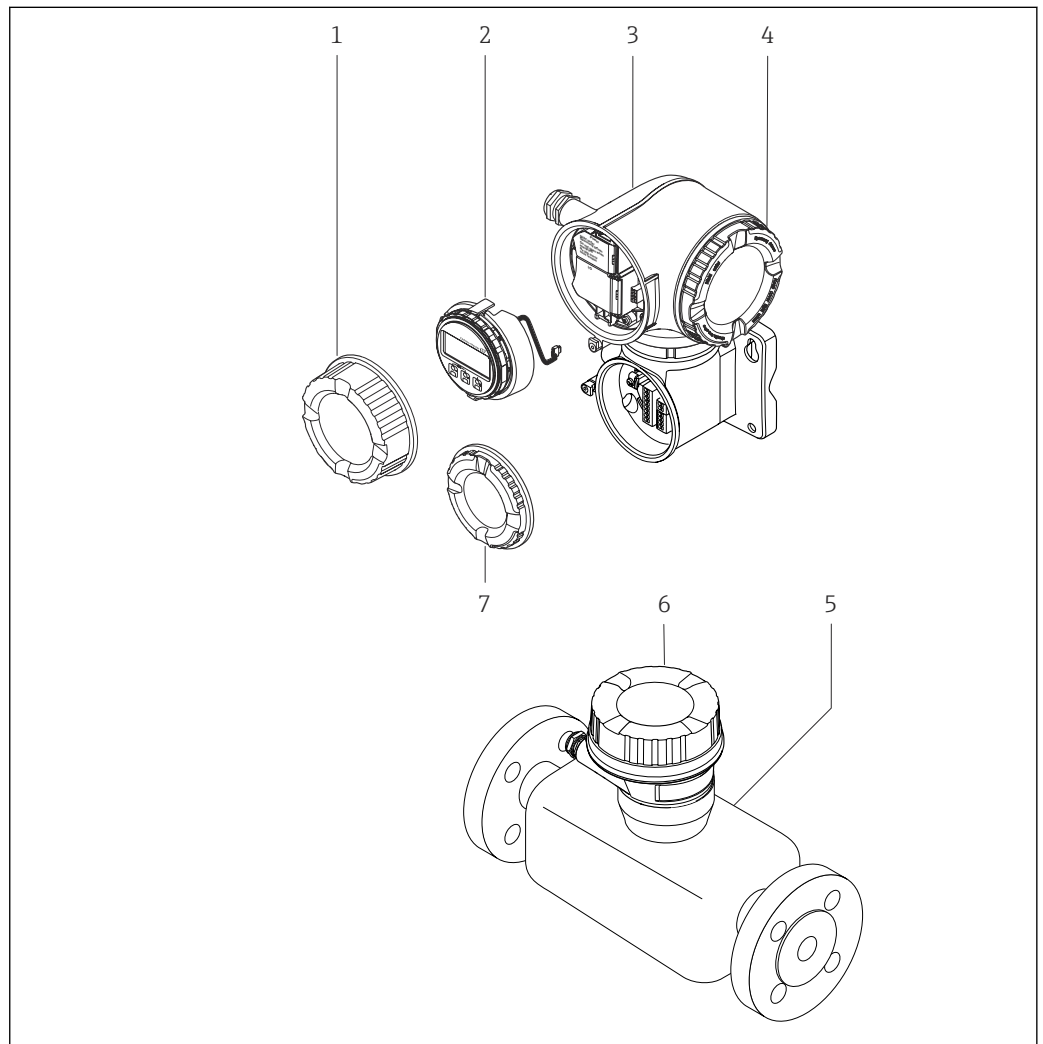

A0029589

2 Important components of a measuring device

- 1 Connection compartment cover
- 2 Display module
- 3 Transmitter housing with integrated ISEM electronics
- 4 Electronics compartment cover
- 5 Sensor
- 6 Sensor connection housing: connecting cable connection
- 7 Connection compartment cover: connecting cable connection

4 Incoming acceptance and product identification

4.1 Incoming acceptance

On receipt of the delivery:

1. Check the packaging for damage.
 - ↳ Report all damage immediately to the manufacturer.
Do not install damaged components.
2. Check the scope of delivery using the delivery note.
3. Compare the data on the nameplate with the order specifications on the delivery note.
4. Check the technical documentation and all other necessary documents, e.g. certificates, to ensure they are complete.

 If one of the conditions is not satisfied, contact the manufacturer.

4.2 Product identification

The device can be identified in the following ways:

- Nameplate
- Order code with details of the device features on the delivery note
- Enter the serial numbers from the nameplates in the *Device Viewer* (www.endress.com/deviceviewer): all the information about the device is displayed.
- Enter the serial numbers from the nameplates into the *Endress+Hauser Operations app* or scan the DataMatrix code on the nameplate with the *Endress+Hauser Operations app*: all the information about the device is displayed.

For an overview of the scope of the associated Technical Documentation, refer to the following:

- The "Additional standard device documentation" and "Supplementary device-dependent documentation" sections
- The *Device Viewer*: Enter the serial number from the nameplate (www.endress.com/deviceviewer)
- The *Endress+Hauser Operations app*: Enter the serial number from the nameplate or scan the DataMatrix code on the nameplate.

4.2.1 Transmitter nameplate

Proline 500 – digital

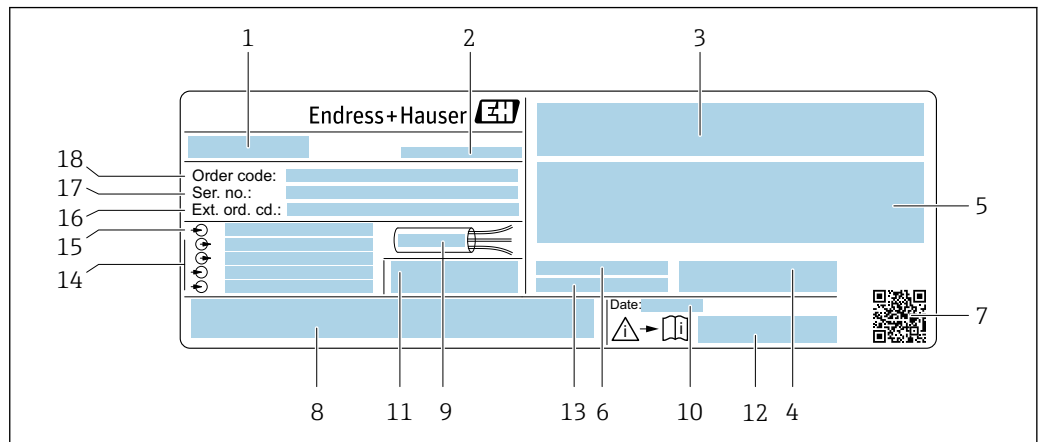

A0058873

3 Example of a transmitter nameplate

- 1 Name of the transmitter
- 2 Manufacturer/certificate holder
- 3 Space for approvals: Use in hazardous areas
- 4 Degree of protection
- 5 Electrical connection data: available inputs and outputs
- 6 Permitted ambient temperature (T_a)
- 7 2-D matrix code
- 8 Space for approvals and certificates: e.g. CE mark, RCM symbol
- 9 Permitted temperature range for cable
- 10 Manufacturing date: year-month
- 11 Firmware version (FW) and device revision (Dev. Rev.) from the factory
- 12 Document number of safety-related supplementary documentation
- 13 Space for additional information in the case of special products
- 14 Available inputs and outputs, supply voltage
- 15 Electrical connection data: supply voltage
- 16 Extended order code (Ext. ord. cd.)
- 17 Serial number (Ser. no.)
- 18 Order code

Proline 500

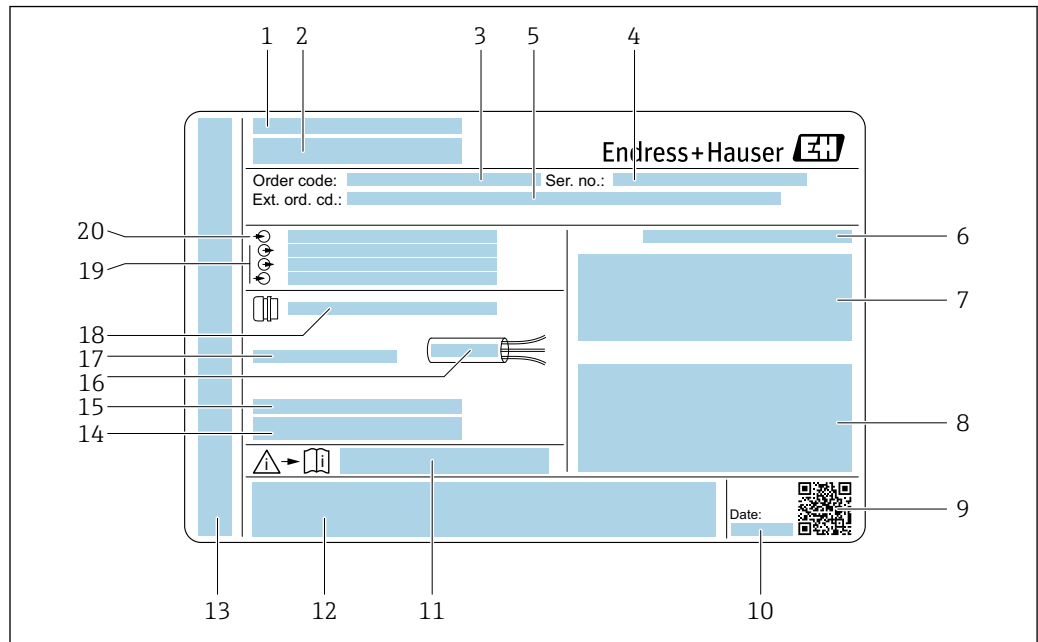

A0058872

4 Example of a transmitter nameplate

- 1 Manufacturer/certificate holder
- 2 Name of the transmitter
- 3 Order code
- 4 Serial number (Ser. no.)
- 5 Extended order code (Ext. ord. cd.)
- 6 Degree of protection
- 7 Space for approvals: use in hazardous areas
- 8 Electrical connection data: available inputs and outputs
- 9 2-D matrix code
- 10 Manufacturing date: year-month
- 11 Document number of safety-related supplementary documentation
- 12 Space for approvals and certificates: e.g. CE mark, RCM symbol
- 13 Space for degree of protection of connection and electronics compartment when used in hazardous areas
- 14 Firmware version (FW) and device revision (Dev. Rev.) from the factory
- 15 Space for additional information in the case of special products
- 16 Permitted temperature range for cable
- 17 Permitted ambient temperature (T_a)
- 18 Information on cable gland
- 19 Available inputs and outputs, supply voltage
- 20 Electrical connection data: supply voltage

4.2.2 Sensor nameplate

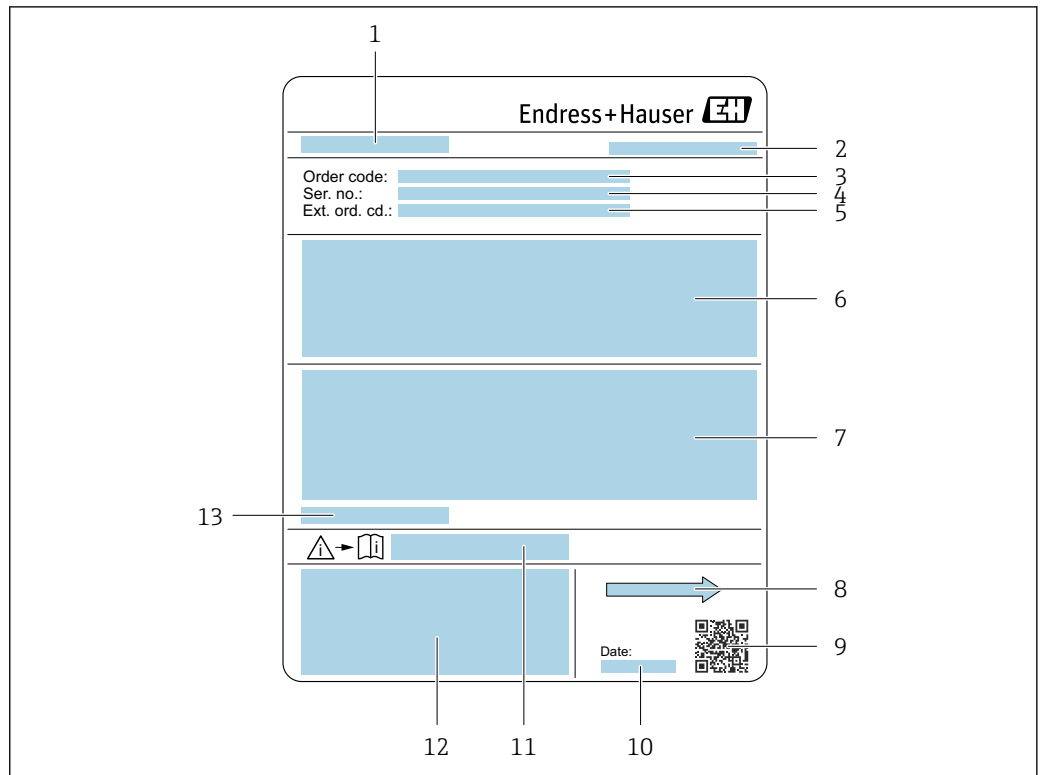

A0029204

5 Example of sensor nameplate

- 1 Name of sensor
- 2 Manufacturer/certificate holder
- 3 Order code
- 4 Serial number (Ser. no.)
- 5 Extended order code (Ext. ord. cd.)
- 6 Flow; nominal diameter of the sensor; pressure rating; nominal pressure; static pressure; medium temperature range; material of liner and electrodes
- 7 Approval information for explosion protection, Pressure Equipment Directive and degree of protection
- 8 Flow direction
- 9 2-D matrix code
- 10 Manufacturing date: year-month
- 11 Document number of safety-related supplementary documentation
- 12 CE mark, RCM symbol
- 13 Permitted ambient temperature (T_a)



Order code

The measuring device is reordered using the order code.

Extended order code

- The device type (product root) and basic specifications (mandatory features) are always listed.
- Of the optional specifications (optional features), only the safety and approval-related specifications are listed (e.g. LA). If other optional specifications are also ordered, these are indicated collectively using the # placeholder symbol (e.g. #LA#).
- If the ordered optional specifications do not include any safety and approval-related specifications, they are indicated by the + placeholder symbol (e.g. XXXXXX-ABCDE+).

4.2.3 Symbols on the device

Symbol	Meaning
	WARNING! This symbol alerts you to a dangerous situation. Failure to avoid this situation can result in serious or fatal injury. Please consult the documentation for the measuring instrument to discover the type of potential danger and measures to avoid it.
	Reference to documentation Refers to the corresponding device documentation.
	Protective ground connection A terminal that must be connected to the ground prior to establishing any other connections.

5 Storage and transport

5.1 Storage conditions

Observe the following notes for storage:

- ▶ Store in the original packaging to ensure protection from shock.
- ▶ Do not remove protective covers or protective caps installed on process connections. They prevent mechanical damage to the sealing surfaces and contamination in the measuring tube.
- ▶ Protect from direct sunlight. Avoid unacceptably high surface temperatures.
- ▶ Select a storage location that excludes the possibility of condensation forming on the measuring instrument. Fungi and bacteria can damage the liner.
- ▶ Store in a dry and dust-free place.
- ▶ Do not store outdoors.

Storage temperature →  194

5.2 Transporting the product

Transport the measuring device to the measuring point in the original packaging.

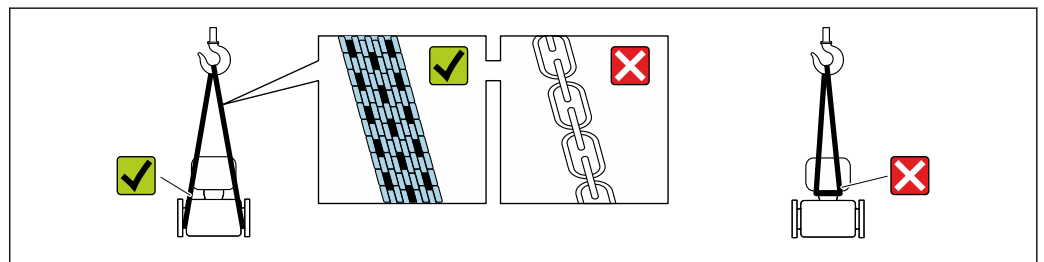

A0029252

-  Do not remove protective covers or caps installed on process connections. They prevent mechanical damage to the sealing surfaces and contamination in the measuring tube.

5.2.1 Measuring devices without lifting lugs

WARNING

Center of gravity of the measuring device is higher than the suspension points of the webbing slings.

Risk of injury if the measuring device slips.

- ▶ Secure the measuring device against slipping or turning.
- ▶ Observe the weight specified on the packaging (stick-on label).

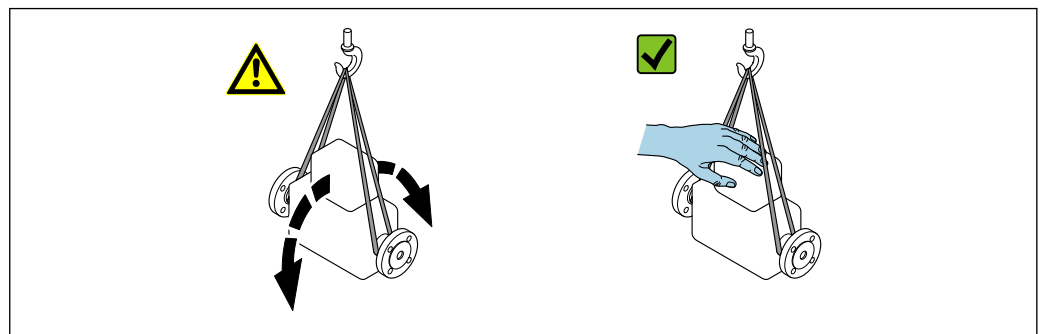

A0029214

5.2.2 Measuring devices with lifting lugs

⚠ CAUTION

Special transportation instructions for devices with lifting lugs

- ▶ Only use the lifting lugs fitted on the device or flanges to transport the device.
- ▶ The device must always be secured at two lifting lugs at least.

5.2.3 Transporting with a fork lift

If transporting in wood crates, the floor structure enables the crates to be lifted lengthwise or at both sides using a forklift.

⚠ CAUTION

Risk of damaging the magnetic coil!

- ▶ If transporting by forklift, do not lift the sensor by the metal casing.
- ▶ This would buckle the casing and damage the internal magnetic coils.

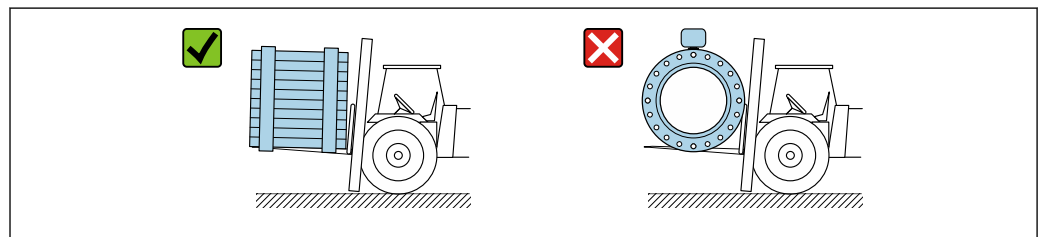

A0029319

5.3 Packaging disposal

All packaging materials are environmentally friendly and 100% recyclable:

- Outer packaging of device
 - Stretch wrap made of polymer in accordance with EU Directive 2002/95/EC (RoHS)
- Packaging
 - Wood crate treated in accordance with ISPM 15 standard, confirmed by IPPC logo
 - Cardboard box in accordance with European packaging guideline 94/62/EC, recyclability confirmed by Resy symbol
- Transport material and fastening fixtures
 - Disposable plastic pallet
 - Plastic straps
 - Plastic adhesive strips
- Filler material
 - Paper pads

6 Installation

6.1 Installation requirements

6.1.1 Installation position

Installation location

- Do not install the device at the highest point of the pipe.
- Do not install the device upstream from a free pipe outlet in a down pipe.

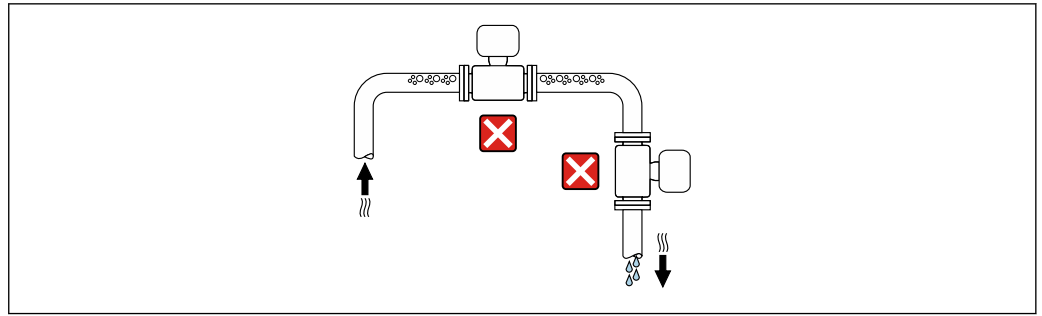

A0042317

The device should ideally be installed in an ascending pipe.

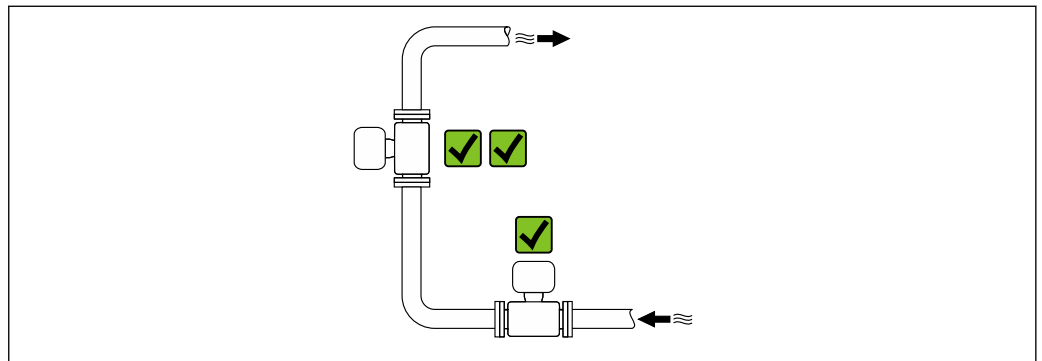

A0042317

Installation upstream from a down pipe

NOTICE

A vacuum in the measuring tube can damage the liner!

- ▶ If installing upstream of down pipes whose length $h \geq 5 \text{ m}$ (16.4 ft): install a siphon with a vent valve downstream of the device.

i This arrangement prevents the flow of liquid stopping in the pipe and the formation of air pockets.

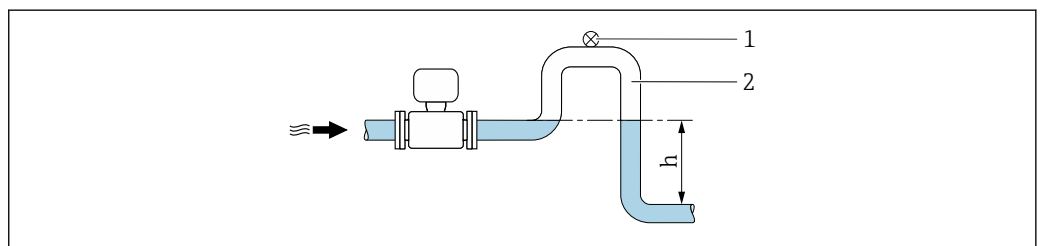

A0028981

- 1 Vent valve
- 2 Pipe siphon
- h Length of down pipe

Installation with partially filled pipes

- Partially filled pipes with a gradient require a drain-type configuration.
- The installation of a cleaning valve is recommended.

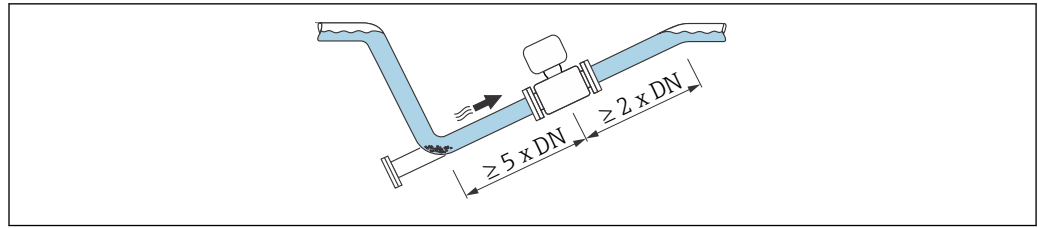

A0041088

Installation near pumps

NOTICE

A vacuum in the measuring tube can damage the liner!

- ▶ In order to maintain the static pressure, install the device in the flow direction downstream from the pump.
- ▶ Install pulsation dampers if reciprocating, diaphragm or peristaltic pumps are used.

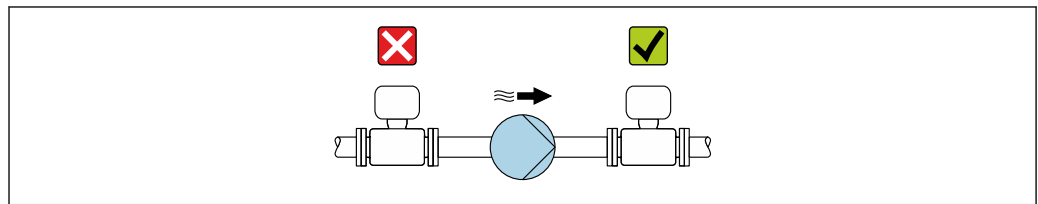

A0041088

- i** Information on the liner's resistance to partial vacuum
- Information on the measuring system's resistance to vibration and shock → 195

Installation in event of pipe vibrations

NOTICE

Pipe vibrations can damage the device!

- ▶ Do not expose the device to strong vibrations.
- ▶ Support the pipe and fix it in place.
- ▶ Support the device and fix it in place.

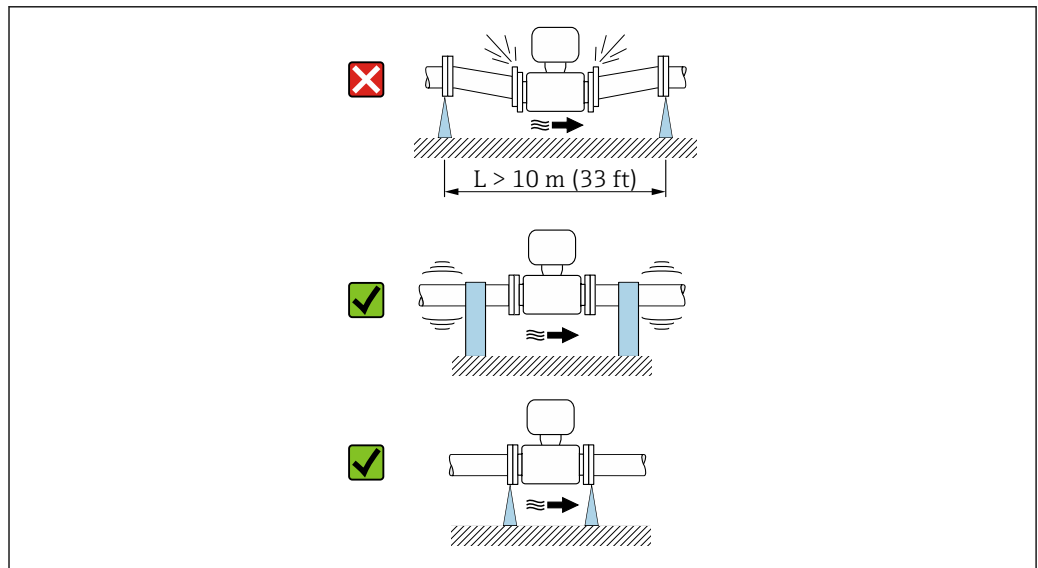



A0041092

- i** Information on the measuring system's resistance to vibration and shock → 195

Orientation

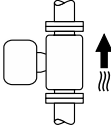
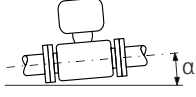
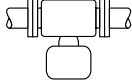
The direction of the arrow on the nameplate helps you to install the measuring instrument according to the flow direction (direction of medium flow through the piping).

Orientation		Recommendation
Vertical orientation		<input checked="" type="checkbox"/> <input checked="" type="checkbox"/>
Horizontal orientation		<input checked="" type="checkbox"/> 1)
Horizontal orientation, transmitter at bottom		<input checked="" type="checkbox"/> <input checked="" type="checkbox"/> 2) 3) <input checked="" type="checkbox"/> 4)
Horizontal orientation, transmitter at side		<input checked="" type="checkbox"/>

- 1) The measuring instrument should be self-draining for hygiene applications. A vertical orientation is recommended for this. If only a horizontal orientation is possible, an angle of inclination $\alpha \geq 10^\circ$ is recommended.
- 2) Applications with high process temperatures may increase the ambient temperature. To maintain the maximum ambient temperature for the transmitter, this orientation is recommended.
- 3) To prevent the electronics module from overheating in the case of a sharp rise in temperature (e.g. CIP or SIP processes), install the measuring instrument with the transmitter component pointing downwards.
- 4) With the empty pipe detection function switched on: empty pipe detection only works if the transmitter housing is pointing upwards.

Vertical

Optimum for self-emptying pipe systems and for use in conjunction with empty pipe detection.

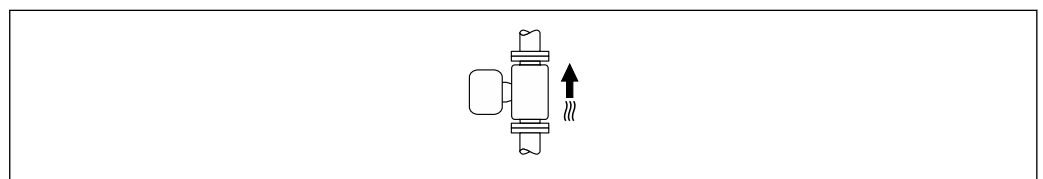

Horizontal

- Ideally, the measuring electrode plane should be horizontal. This prevents brief insulation of the measuring electrodes by entrained air bubbles.
- Empty pipe detection only works if the transmitter housing is pointing upwards as otherwise there is no guarantee that the empty pipe detection function will actually respond to a partially filled or empty measuring tube.

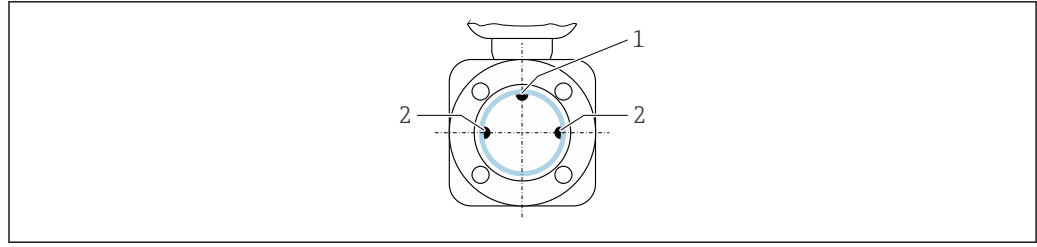

A0028998

- 1 EPD electrode for empty pipe detection, available from \geq DN 15 (1/2")
- 2 Measuring electrodes for signal detection

i Measuring instruments with a nominal diameter $<$ DN 15 (1/2") do not have an EPD electrode. In this case, empty pipe detection is performed via the measuring electrodes.

Inlet and outlet runs

Installation with inlet and outlet runs

Installation is carried out with inlet and outlet runs.

Maintain straight, unimpeded inlet and outlet runs.

To avoid a vacuum and to maintain the specified level of measurement accuracy, if possible install the device upstream from assemblies that produce turbulence (e.g. valves, T-sections) and downstream from pumps.

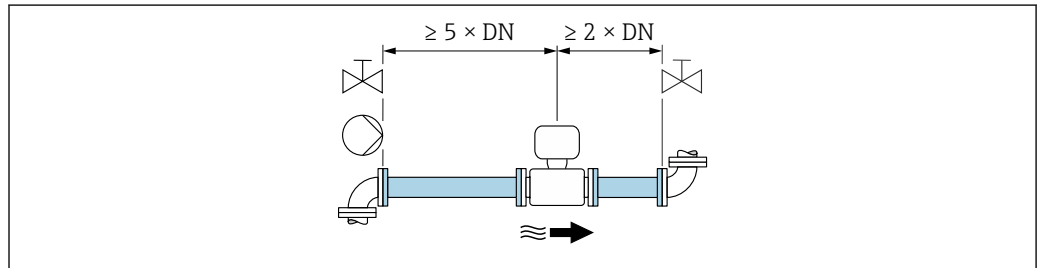

A0028997

Keep a sufficient distance to the next pipe elbow.

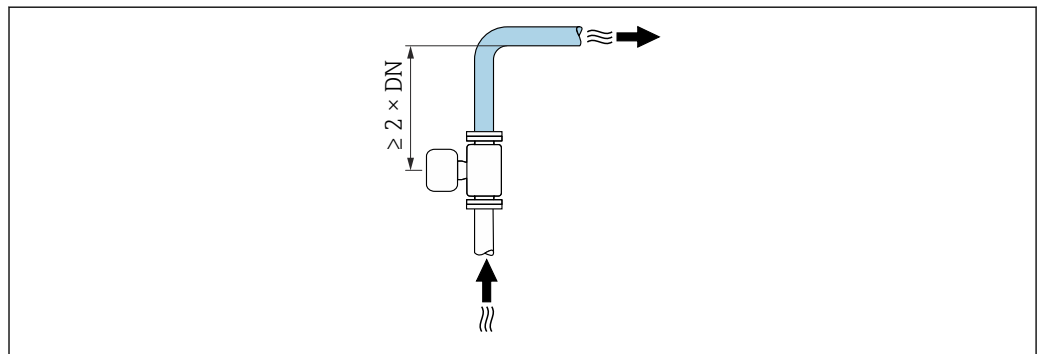

A0042132

Installation without inlet and outlet runs

Depending on the device design and installation location, the inlet and outlet runs can be reduced or omitted entirely.

i Maximum measurement error

When the device is installed with the inlet and outlet runs described, a maximum measurement error of ± 0.5 % of measured value ± 1 mm/s (0.04 in/s) can be ensured.

Devices and possible order options

Order code for "Electrodes"		
Option	Description	Design
J	1.4435/316L, pointed for 0 x DN inlet/outlet runs	0 x DN full-bore design ¹⁾
L	1.4435/316L for 0 x DN inlet/outlet runs	
M	Alloy C22 for 0 x DN inlet/outlet runs	
N	Tantalum for 0 x DN inlet/outlet runs	

1) "Full-bore" indicates a measuring tube cross-section corresponding to the nominal diameter without constriction. This means there is no pressure loss.

Installation before or after bends

Installation without inlet and outlet runs is possible.

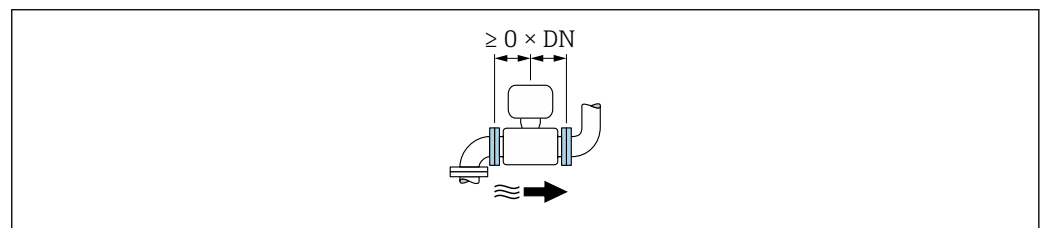

A0032859

Installation downstream of pumps

Installation without inlet and outlet runs is possible.

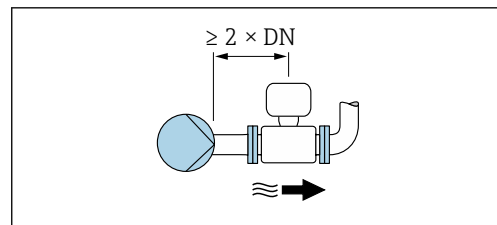

A0045530



An inlet run of $\geq 2 \times \text{DN}$ is recommended.

Installation upstream of valves

Installation without inlet and outlet runs is possible.

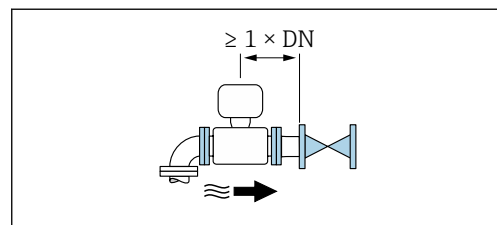

A0045531



An outlet run of $\geq 1 \times \text{DN}$ is recommended.

Installation downstream of valves

The device can be installed without inlet and outlet runs if the valve is 100% open during operation.

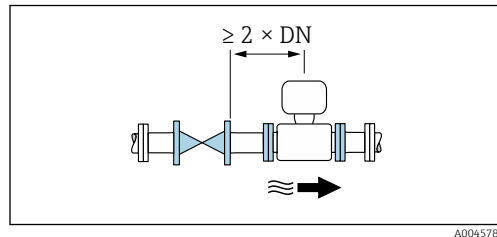

An inlet run of $\geq 2 \times DN$ is recommended if the valve is 100% open during operation.

Installation dimensions



For the dimensions and installed lengths of the device, see the "Technical Information" document, "Mechanical construction" section

6.1.2 Environmental and process requirements

Ambient temperature range

Transmitter	<ul style="list-style-type: none"> ▪ Standard: -40 to $+60$ °C (-40 to $+140$ °F) ▪ Optional: -50 to $+60$ °C (-58 to $+140$ °F) (Order code for "Test, certificate", option JN "Ambient temperature of transmitter -50 °C (-58 °F)")
Local display	-20 to $+60$ °C (-4 to $+140$ °F), the readability of the display may be impaired at temperatures outside the temperature range.
Sensor	-40 to $+60$ °C (-40 to $+140$ °F)
Liner	Do not exceed or fall below the permitted temperature range of the liner .

If operating outdoors:

- Install the measuring device in a shady location.
- Avoid direct sunlight, particularly in warm climatic regions.
- Avoid direct exposure to weather conditions.

System pressure

Installation near pumps → 24

Vibrations

Installation in event of pipe vibrations → 24

Adapters

The sensor can also be installed in larger-diameter pipes with the aid of suitable adapters according to DIN EN 545 (double-flange reducers). The resultant increase in the rate of flow improves measurement accuracy with very slow-moving fluids. The nomogram shown here can be used to calculate the pressure loss caused by reducers and expanders.



- The nomogram only applies to liquids with a viscosity similar to that of water.
- If the medium has a high viscosity, a larger measuring tube diameter can be considered in order to reduce pressure loss.

1. Calculate the ratio of the diameters d/D .
2. From the nomogram read off the pressure loss as a function of flow velocity (downstream from the reduction) and the d/D ratio.

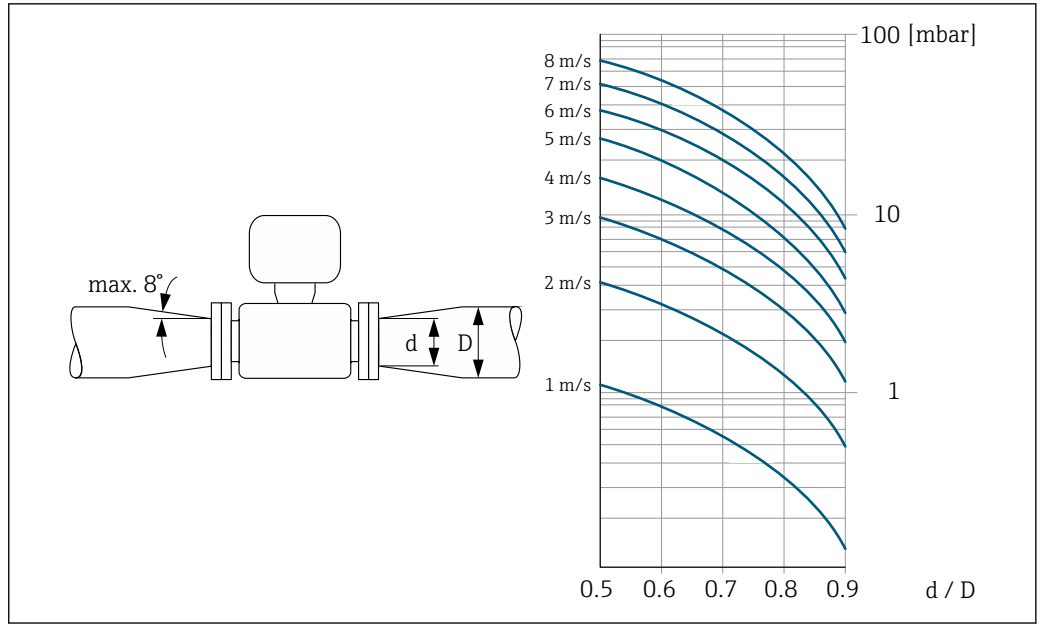

A0029002

Length of connecting cable

Proline 500 – digital transmitter

Lengths of connecting cable → 40

Proline 500 transmitter

Max. 200 m (650 ft)

To obtain correct measurement results, observe the permitted connecting cable length of L_{max} . This length is determined by the conductivity of the medium. If measuring liquids in general: 5 $\mu S/cm$

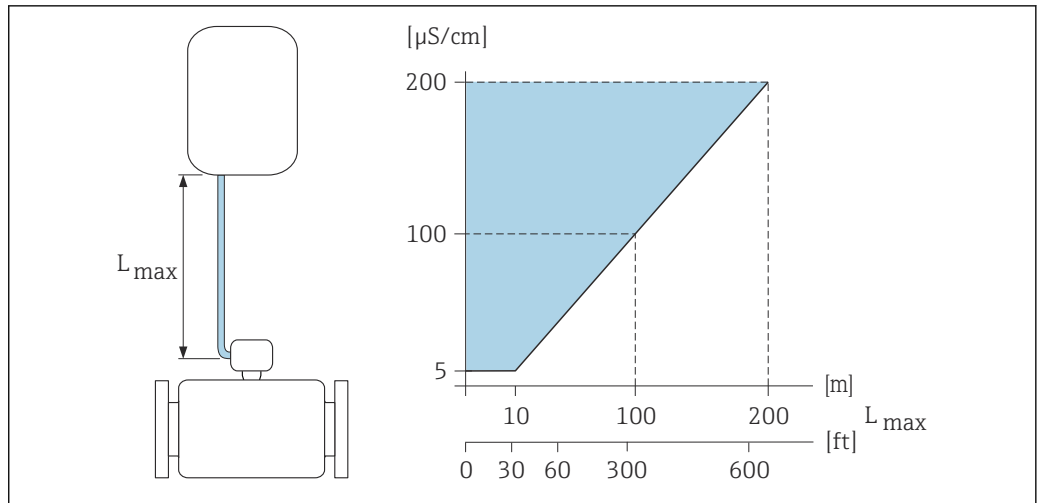

A0016539

6 Permitted length of connecting cable

Colored area = permitted range
 L_{max} = length of connecting cable in [m] ([ft])
 $[\mu S/cm]$ = medium conductivity

6.1.3 Special installation instructions

Protective cover

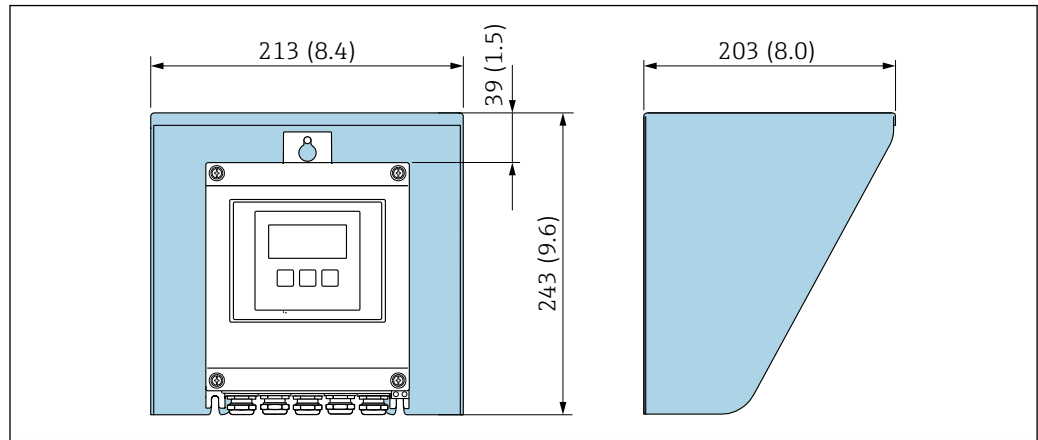

A0029552

7 Weather protection cover for Proline 500 – digital; unit mm (in)

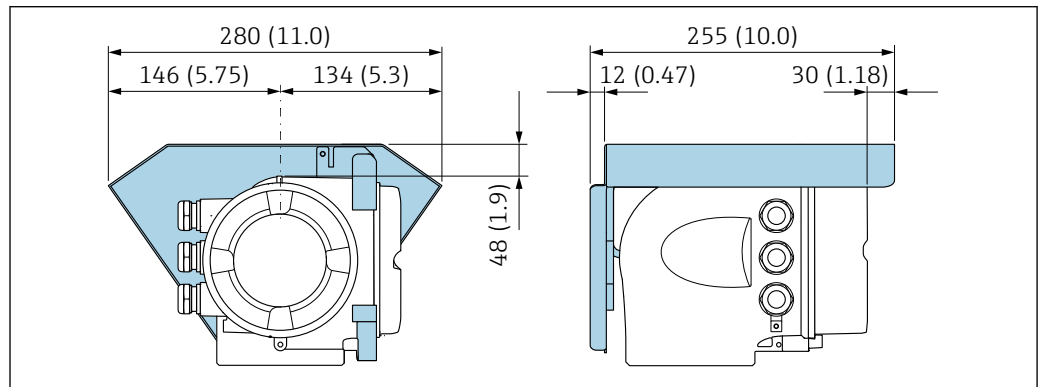

A0029553

8 Weather protection cover for Proline 500 – unit mm (in)

Hygienic compatibility

i When installing in hygienic applications, please refer to the information in the "Certificates and approvals/hygienic compatibility" section → 205

6.2 Installing the measuring instrument

6.2.1 Required tools

For transmitter

For mounting on a post:

- Proline 500 – digital transmitter
 - Open-ended wrench AF 10
 - Torx screwdriver TX 25
- Proline 500 transmitter
 - Open-ended wrench AF 13

For wall mounting:

Drill with drill bit \varnothing 6.0 mm

For sensor

For flanges and other process connections: Use a suitable mounting tool.

6.2.2 Preparing the measuring device

1. Remove all remaining transport packaging.
2. Remove any protective covers or protective caps present from the sensor.
3. Remove stick-on label on the electronics compartment cover.

6.2.3 Installing the sensor**⚠ WARNING****Danger due to improper process sealing!**

- ▶ Ensure that the inside diameters of the gaskets are greater than or equal to that of the process connections and piping.
 - ▶ Ensure that the seals and sealing surfaces are clean and undamaged.
 - ▶ Secure the seals correctly.
1. Ensure that the direction of the arrow on the sensor matches the flow direction of the medium.
 2. To ensure compliance with device specifications, install the measuring instrument between the pipe flanges so that it is centered in the measurement section.
 3. Install the measuring instrument or turn the transmitter housing so that the cable entries do not point upwards.

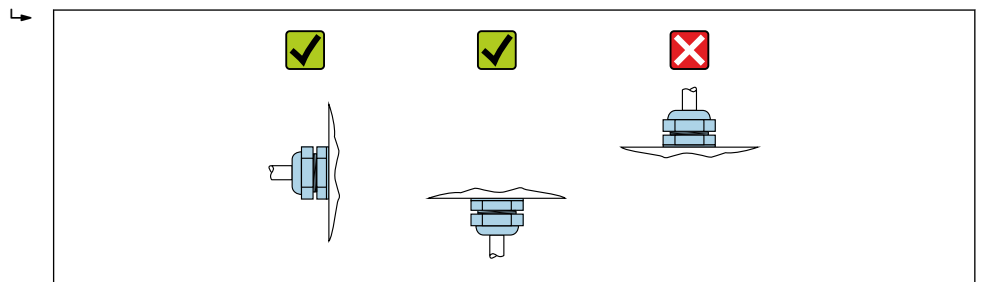

A0029263

The sensor is supplied to order, with or without pre-installed process connections. Pre-installed process connections are firmly secured to the sensor by 4 or 6 hexagonal-headed bolts.

- ▶ Depending on the application and pipe length:
Support the sensor or secure it additionally.
- ▶ If using plastic process connections:
It is absolutely essential to secure the sensor.

i An appropriate wall mounting kit can be ordered separately as an accessory from Endress+Hauser → 208.

Welding the sensor into the pipe (welding connections)**⚠ WARNING****Risk of destroying the electronics!**

- ▶ Make sure that the welding system is not grounded via the sensor or transmitter.
1. Tack-weld the sensor to secure it in the pipe. A suitable welding jig can be ordered separately as an accessory → 208.

2. Loosen the screws on the process connection flange and remove the sensor, along with the seal, from the pipe.
 3. Weld the process connection into the pipe.
 4. Reinstall the sensor in the pipe, and in doing so make sure that the seal is clean and in the right position.
- ▶ If thin-walled pipes carrying food are welded correctly:
Disassemble the sensor and seal even if the seal is not damaged by the heat when mounted.

 It must be possible to open the pipe by at least 8 mm (0.31 in) for disassembly.

Installing the seals



Comply with the following instructions when installing seals:

1. In the case of metal process connections, the screws must be tightened securely. The process connection forms a metal connection with the sensor, which ensures a defined compression of the seal.
2. In the case of plastic process connections, observe the maximum torques for lubricated threads: 7 Nm (5.2 lbf ft); always insert a seal between the connection and the counterflange in the case of plastic flanges.
3. Depending on the application, the seals should be replaced periodically, particularly if molded seals are used (aseptic version). The interval between changes depends on the frequency of the cleaning cycles, the cleaning temperature and the medium temperature. Replacement seals can be ordered as an accessory →  208.

Installing grounding rings (DN 2 to 25 (1/12 to 1"))

 Pay attention to the information on potential equalization .

In the case of plastic process connections (e.g. flange connections or adhesive fittings), additional grounding rings must be used to ensure potential matching between the sensor and the fluid. If grounding rings are not installed, this can affect the measurement accuracy or cause the destruction of the sensor as a result of the electrochemical decomposition of the electrodes.

-  ■ Depending on the option ordered, plastic disks are used instead of grounding rings on some process connections. These plastic disks only act as "spacers" and do not have any potential matching function. Furthermore, they also perform a significant sealing function at the sensor/process connection interface. Therefore, in the case of process connections without metal grounding rings, these plastic disks/seals should never be removed and should always be installed!
- Grounding rings can be ordered separately as an accessory from Endress+Hauser →  208. When ordering, make sure that the grounding rings are compatible with the material used for the electrodes, as otherwise there is the danger that the electrodes could be destroyed by electrochemical corrosion!
Material specifications →  200.
 - Grounding rings, including seals, are mounted inside the process connections. This does not affect the installed length.

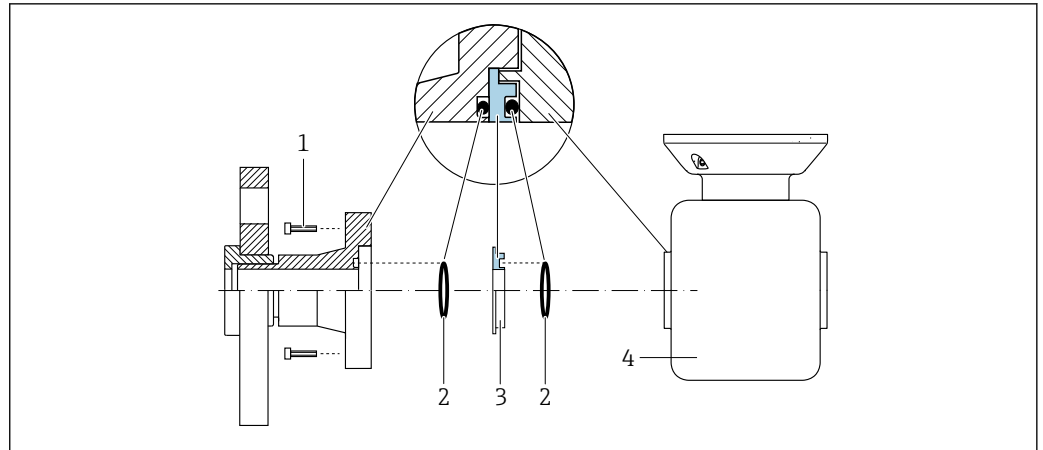

A0028971

9 Installing grounding rings

- 1 Hexagonal-headed bolts of process connection
- 2 O-ring seals
- 3 Grounding ring or plastic disk (spacer)
- 4 Sensor

1. Loosen the 4 or 6 hexagonal-headed bolts (1) and remove the process connection from the sensor (4).
2. Remove the plastic disk (3), along with the two O-ring seals (2), from the process connection.
3. Place the first O-ring seal (2) back into the groove of the process connection.
4. Fit the metal grounding ring (3) in the process connection as illustrated.
5. Place the second O-ring seal (2) into the groove of the grounding ring.
6. Mount the process connection back on the sensor. When doing so, make sure to observe the maximum screw tightening torques for lubricated threads: 7 Nm (5.2 lbf ft)

6.2.4 Installing the transmitter housing: Proline 500 – digital

NOTICE

Ambient temperature too high!

Danger of electronics overheating and housing deformation.

- ▶ Do not exceed the permitted maximum ambient temperature. → 28
- ▶ If operating outdoors: Avoid direct sunlight and exposure to weathering, particularly in warm climatic regions.

NOTICE

Excessive force can damage the housing!

- ▶ Avoid excessive mechanical stress.

The transmitter can be mounted in the following ways:

- Post mounting
- Wall mounting

Pipe mounting

Required tools:

- Open-ended wrench AF 10
- Torx screwdriver TX 25

NOTICE

Excessive tightening torque applied to the fixing screws!

Risk of damaging the plastic transmitter.

- ▶ Tighten the fixing screws as per the tightening torque: 2.5 Nm (1.8 lbf ft)

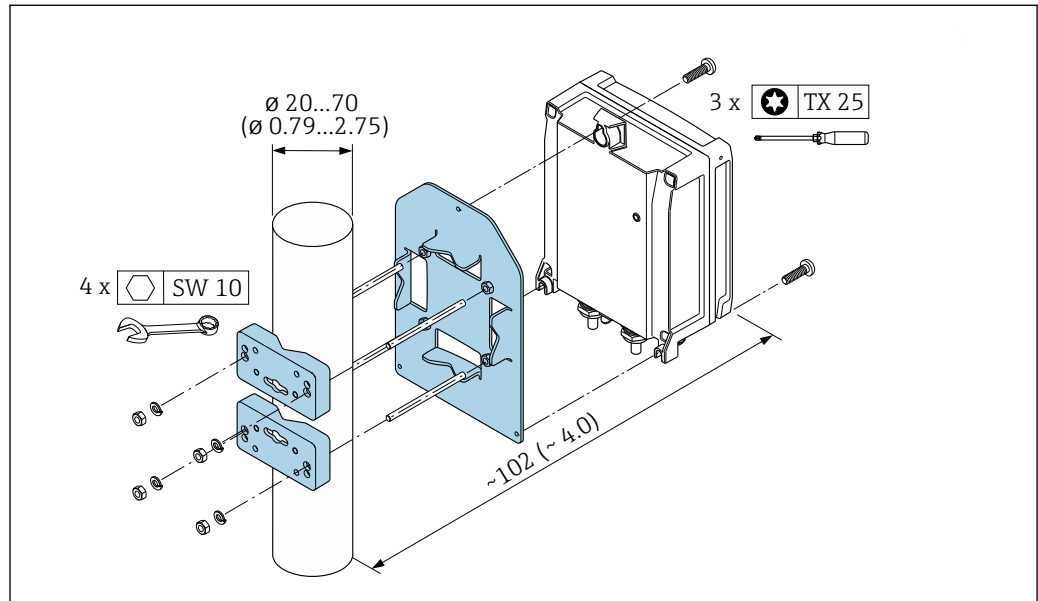

A0029051

10 Unit mm (in)

Wall mounting

Required tools:

Drill with drill bit $\varnothing 6.0$ mm

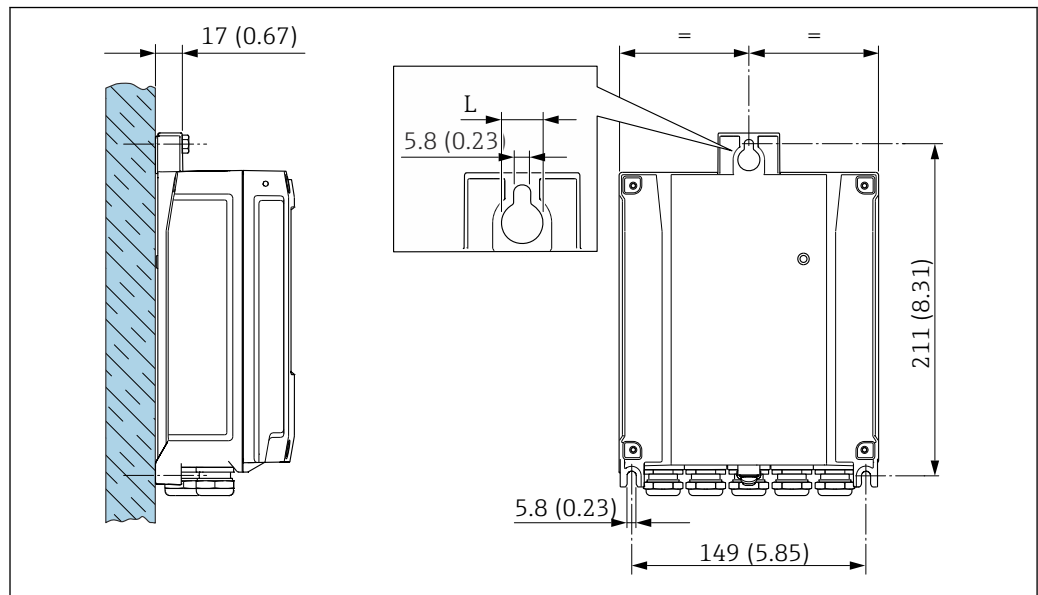

A0029054

11 Unit mm (in)

L Depends on order code for "Transmitter housing"

Order code for "Transmitter housing"

Option A, aluminum, coated: L = 14 mm (0.55 in)

1. Drill the holes.

2. Insert wall plugs into the drilled holes.
3. Screw in the securing screws loosely.
4. Fit the transmitter housing over the securing screws and mount in place.
5. Tighten the securing screws.

6.2.5 Installing the transmitter housing: Proline 500

NOTICE

Ambient temperature too high!

Danger of electronics overheating and housing deformation.

- ▶ Do not exceed the permitted maximum ambient temperature. → 28
- ▶ If operating outdoors: Avoid direct sunlight and exposure to weathering, particularly in warm climatic regions.

NOTICE

Excessive force can damage the housing!

- ▶ Avoid excessive mechanical stress.

The transmitter can be mounted in the following ways:

- Post mounting
- Wall mounting

Wall mounting

Required tools

Drill with drill bit \varnothing 6.0 mm

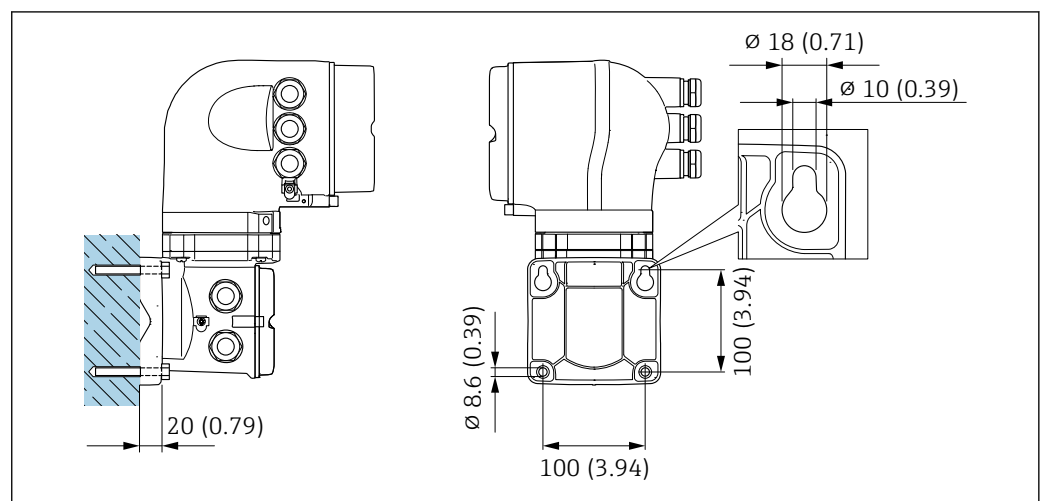

12 Unit mm (in)

1. Drill the holes.
2. Insert wall plugs into the drilled holes.
3. Lightly screw in the securing screws.
4. Fit the transmitter housing over the securing screws and hook into place.
5. Tighten the securing screws.

Pipe mounting

Required tools

Open-ended wrench AF 13

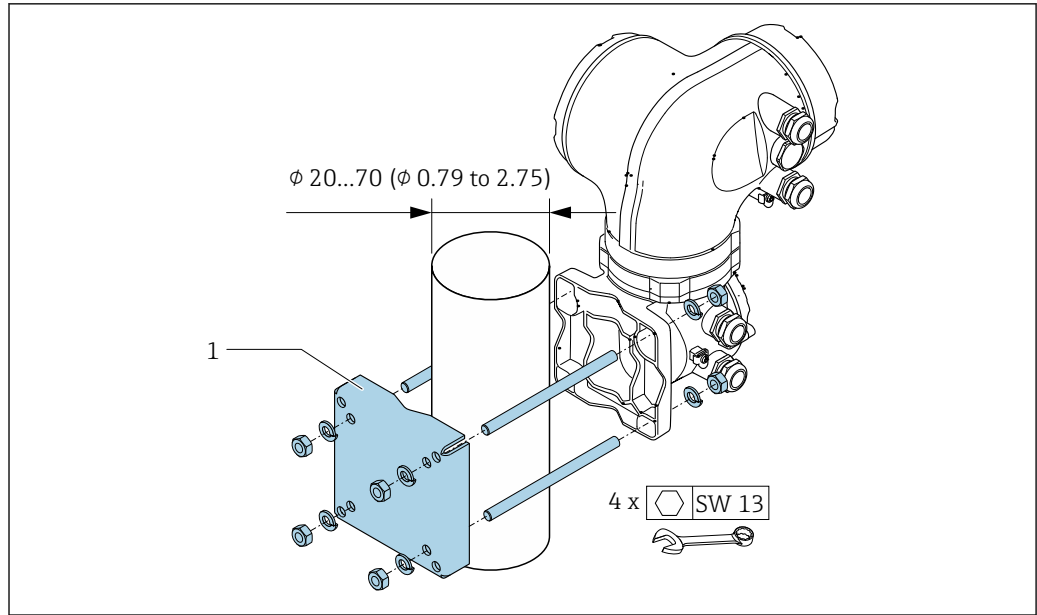

A0029057

13 Unit mm (in)

6.2.6 Turning the transmitter housing: Proline 500

To provide easier access to the connection compartment or display module, the transmitter housing can be turned.

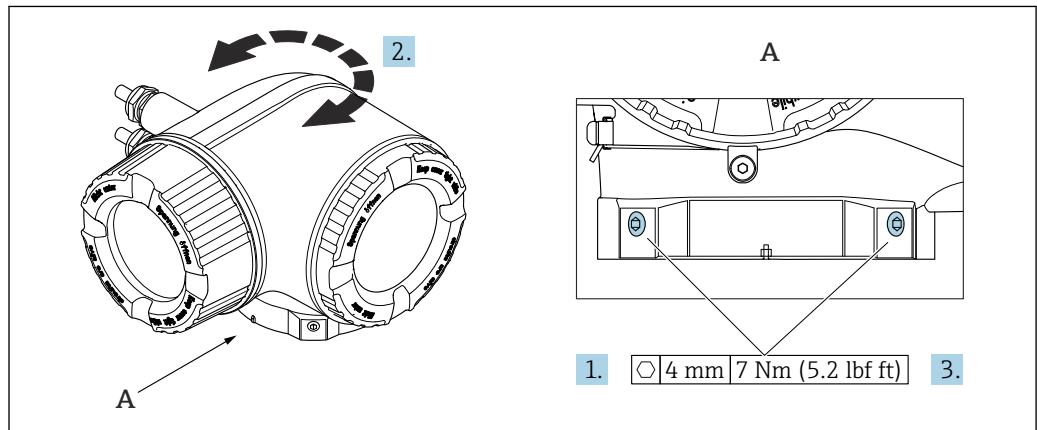

A0043150

14 Ex housing

1. Loosen the fixing screws.
2. Turn the housing to the desired position.
3. Tighten the securing screws.

6.2.7 Turning the display module: Proline 500

The display module can be turned to optimize display readability and operability.

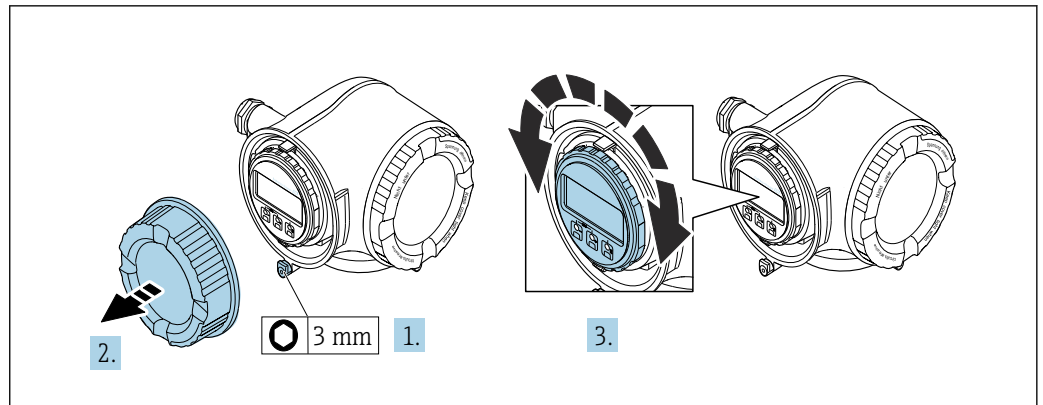

A0030035

1. Depending on the device version: Loosen the securing clamp of the connection compartment cover.
2. Unscrew the connection compartment cover.
3. Turn the display module to the desired position: max. 8 × 45° in each direction.
4. Screw on the connection compartment cover.
5. Depending on the device version: Attach the securing clamp of the connection compartment cover.

6.3 Post-installation check

Is the device undamaged (visual inspection)?	<input type="checkbox"/>
Does the measuring instrument correspond to the measuring point specifications? For example: <ul style="list-style-type: none"> ▪ Process temperature ▪ Process pressure (refer to the section on "Pressure-temperature ratings" in the "Technical Information" document. ▪ Ambient temperature ▪ Measuring range 	<input type="checkbox"/>
Has the correct orientation been selected for the sensor → 25 ? <ul style="list-style-type: none"> ▪ According to sensor type ▪ As per medium temperature ▪ As per medium properties (outgassing, with entrained solids) 	<input type="checkbox"/>
Does the arrow on the sensor match the direction of flow of the medium → 25?	<input type="checkbox"/>
Is the tag name and labeling correct (visual inspection)?	<input type="checkbox"/>
Are the fixing screws tightened securely?	<input type="checkbox"/>
Was cleaning carried out in accordance with the specified cleaning specifications before initial commissioning? → 174?	<input type="checkbox"/>

7 Electrical connection

WARNING

Live parts! Incorrect work performed on the electrical connections can result in an electric shock.

- ▶ Set up a disconnecting device (switch or power-circuit breaker) to easily disconnect the device from the supply voltage.
- ▶ In addition to the device fuse, include an overcurrent protection unit with max. 10 A in the plant installation.

7.1 Electrical safety

In accordance with applicable national regulations.

7.2 Connecting requirements

7.2.1 Required tools

- For cable entries: use appropriate tool
- For securing clamp: Allen key 3 mm
- Wire stripper
- When using stranded cables: crimper for wire end ferrule
- For removing cables from terminal: flat blade screwdriver ≤ 3 mm (0.12 in)

7.2.2 Requirements for connection cable

The connecting cables provided by the customer must fulfill the following requirements.

Protective grounding cable for the outer ground terminal

Conductor cross-section < 6 mm² (10 AWG)

Larger cross-sections can be connected using a cable lug.

The grounding impedance must be less than 2 Ω .

Permitted temperature range

- The installation guidelines that apply in the country of installation must be observed.
- The cables must be suitable for the minimum and maximum temperatures to be expected.

Power supply cable (incl. conductor for the inner ground terminal)

Standard installation cable is sufficient.

Signal cable

4 to 20 mA current input

Standard installation cable is sufficient.

Pulse/frequency/switch output

Standard installation cable is sufficient.

Relay output

Standard installation cable is sufficient.

Status input

Standard installation cable is sufficient.

Ethernet-APL

Shielded twisted-pair cable. Cable type A is recommended.



See <https://www.profibus.com> Ethernet-APL White Paper "

Cable diameter

- Cable glands supplied:
M20 × 1.5 with cable Ø 6 to 12 mm (0.24 to 0.47 in)
- Spring-loaded terminals: Suitable for strands and strands with ferrules.
Conductor cross-section 0.2 to 2.5 mm² (24 to 12 AWG)

Choice of connecting cable between the transmitter and sensor

Depends on the type of transmitter and the installation zones

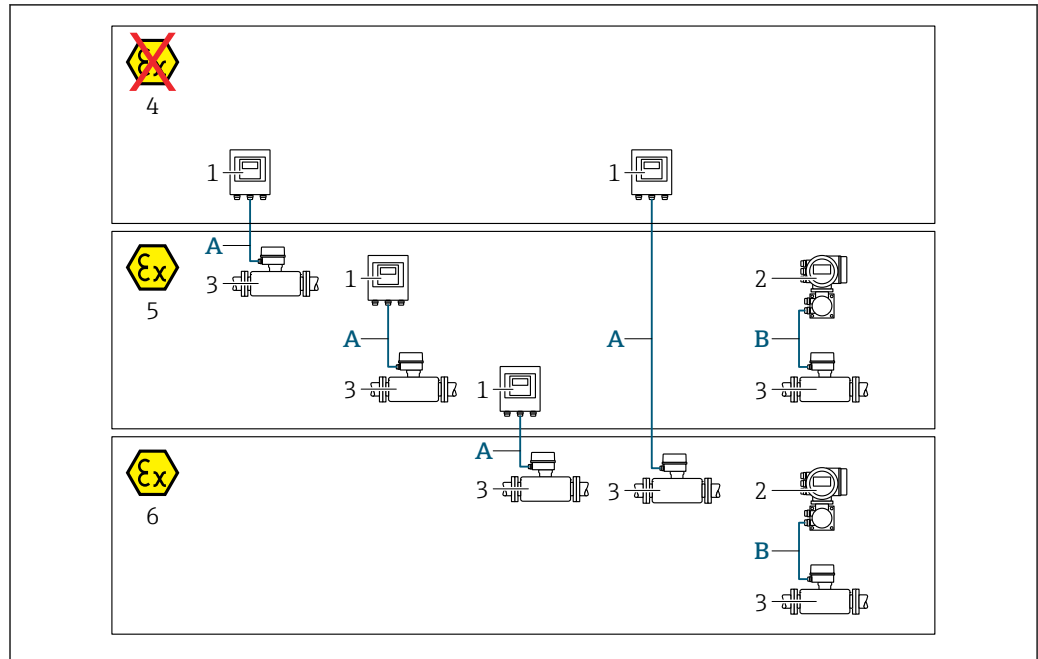

A0032477

- 1 Proline 500 digital transmitter
- 2 Proline 500 transmitter
- 3 Promag sensor
- 4 Non-hazardous area
- 5 Hazardous area: Zone 2; Class I, Division 2
- 6 Hazardous area: Zone 1; Class I, Division 1
- A Standard cable to 500 digital transmitter → 40
Transmitter installed in the non-hazardous area or hazardous area: Zone 2; Class I, Division 2 / sensor installed in the hazardous area: Zone 2; Class I, Division 2 or Zone 1; Class I, Division 1
- B Signal cable to 500 transmitter → 41
Transmitter and sensor installed in the hazardous area: Zone 2; Class I, Division 2 or Zone 1; Class I, Division 1

A: Connecting cable between sensor and transmitter: Proline 500 – digital

Standard cable

A standard cable with the following specifications can be used as the connecting cable.

Design	4 cores (2 pairs); uninsulated stranded CU wires; pair-stranded with common shield
Shielding	Tin-plated copper braid, optical cover ≥ 85 %
Cable length	Maximum 300 m (900 ft), see the following table.

Cross-section	Cable lengths for use in	
	Non-hazardous area, Hazardous area: Zone 2; Class I, Division 2	Hazardous area: Zone 1; Class I, Division 1
0.34 mm ² (AWG 22)	80 m (240 ft)	50 m (150 ft)
0.50 mm ² (AWG 20)	120 m (360 ft)	60 m (180 ft)
0.75 mm ² (AWG 18)	180 m (540 ft)	90 m (270 ft)
1.00 mm ² (AWG 17)	240 m (720 ft)	120 m (360 ft)

Cross-section	Cable lengths for use in	
	Non-hazardous area, Hazardous area: Zone 2; Class I, Division 2	Hazardous area: Zone 1; Class I, Division 1
1.50 mm ² (AWG 15)	300 m (900 ft)	180 m (540 ft)
2.50 mm ² (AWG 13)	300 m (900 ft)	300 m (900 ft)

Optionally available connecting cable

Design	2 × 2 × 0.34 mm ² (AWG 22) PVC cable ¹⁾ with common shield (2 pairs, uninsulated stranded CU wires; pair-stranded)
Flame resistance	According to DIN EN 60332-1-2
Oil-resistance	According to DIN EN 60811-2-1
Shielding	Tin-plated copper braid, optical cover ≥ 85 %
Operating temperature	When mounted in a fixed position: -50 to +105 °C (-58 to +221 °F); when cable can move freely: -25 to +105 °C (-13 to +221 °F)
Available cable length	Fixed: 20 m (60 ft); variable: up to maximum 50 m (150 ft)

1) UV radiation can impair the cable outer sheath. Protect the cable from direct sunshine where possible.

B: Connecting cable between sensor and transmitter: Proline 500

Signal cable

Design	3 × 0.38 mm ² (20 AWG) with common, braided copper shield (∅ ~ 9.5 mm (0.37 in)) and individual shielded cores
Conductor resistance	≤ 50 Ω/km (0.015 Ω/ft)
Capacitance: core/shield	≤ 420 pF/m (128 pF/ft)
Cable length (max.)	Depends on the medium conductivity, max. 200 m (656 ft)
Cable lengths (available for order)	5 m (15 ft), 10 m (30 ft), 20 m (60 ft) or variable length up to max. 200 m (656 ft)
Cable diameter	9.4 mm (0.37 in) ± 0.5 mm (0.02 in)
Permanent operating temperature	-40 to +80 °C (-40 to +176 °F)
Permanent operating temperature option JN	-50 to +80 °C (-58 to +176 °F)

Coil current cable

Design	3 × 0.75 mm ² (18 AWG) with common, braided copper shield (∅ ~ 9 mm (0.35 in)) and individual shielded cores
Conductor resistance	≤ 37 Ω/km (0.011 Ω/ft)
Capacitance: core/core, shield grounded	≤ 120 pF/m (37 pF/ft)
Cable length (max.)	Depends on the medium conductivity, max. 200 m (656 ft)
Cable lengths (available for order)	5 m (15 ft), 10 m (30 ft), 20 m (60 ft) or variable length up to max. 200 m (656 ft)
Cable diameter	8.8 mm (0.35 in) ± 0.5 mm (0.02 in)
Permanent operating temperature	-40 to +80 °C (-40 to +176 °F)

Permanent operating temperature option JN	-50 to +80 °C (-58 to +176 °F)
Test voltage for cable insulation	≤ AC 1433 V rms 50/60 Hz or ≥ DC 2026 V

Operation in zones of severe electrical interference

The measuring system meets the general safety requirements →  207 and EMC specifications →  195.

Grounding is by means of the ground terminal provided for the purpose inside the connection housing. The stripped and twisted lengths of cable shield to the ground terminal must be as short as possible.

7.2.3 Terminal assignment

Transmitter: supply voltage, input/outputs

The terminal assignment of the inputs and outputs depends on the individual order version of the device. The device-specific terminal assignment is documented on an adhesive label in the terminal cover.

Modbus TCP

Supply voltage		Input/output 1 (Port 1 ¹⁾)		Input/output 2		Input/output 3		Input/output 4 ²⁾		Service interface (Port 2) ¹⁾
1 (+)	2 (-)	26 (+)	27 (-)	24 (+)	25 (-)	22 (+)	23 (-)	20 (+)	21 (-)	CDI-RJ45
Device-specific terminal assignment: adhesive label in terminal cover.										



1) For Modbus TCP communication, either port 1 OR port 2 can be used.

2) Input/output only available for Proline 500 - digital.

Transmitter and sensor connection housing: connecting cable

The sensor and transmitter, which are mounted in separate locations, are interconnected by a connecting cable. The cable is connected via the sensor connection housing and the transmitter housing.

Terminal assignment and connection of the connecting cable:

- Proline 500 – digital →  48
- Proline 500 →  56

7.2.4 Available device plugs for Proline 500

 Device plugs may not be used in hazardous areas!

Order code for "Input; output 1", option MB "Modbus TCP over Ethernet-APL"

Order code for "Electrical connection"	Accessories	Cable entry/connection	
		2	3
L, N, P, U	-	Connector M12×1 A-coded	-
L, N, P, U	NB ¹⁾	Connector M12×1 A-coded	Connector M12×1 ¹⁾ D-coded
1 ²⁾ , 2 ²⁾ , 7 ²⁾ , 8 ²⁾	-	-	Connector M12×1 D-coded

- 1) Cannot be used as a Modbus TCP port.
- 2) Not compatible with an external WLAN antenna (order code for "Accessory enclosed", option P8, an RJ45 M12 adapter for the service interface (order code for "Accessory mounted", option NB)

7.2.5 Available device plugs for Proline 500 digital

 Device plugs may not be used in hazardous areas!

Order code for "Input; output 1", option MB "Modbus TCP over Ethernet-APL"

Order code for "Electrical connection"	Accessories	Cable entry/connection			
		2	3	4	5
L, N, P, U	-	-	Connector M12×1 A-coded	-	-
L, N, P, U	NB ¹⁾	-	Connector M12×1 A-coded	-	Connector M12×1 ¹⁾ D-coded
1 ²⁾ , 2 ²⁾ , 7 ²⁾ , 8 ²⁾	-	-	-	-	Connector M12×1 D-coded

- 1) Cannot be used as a Modbus TCP port.
- 2) Not compatible with an external WLAN antenna (order code for "Accessory enclosed", option P8, an RJ45 M12 adapter for the service interface (order code for "Accessory mounted", option NB)

7.2.6 Modbus TCP over Ethernet 100 Mbit/s

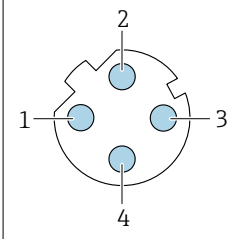
	Pin	Assignment	Coding	Plug/socket	
	1	+			Tx
	2	+			Rx
	3	-			Tx
	4	-			Rx

7.2.7 Modbus TCP over Ethernet-APL 10 Mbit/s

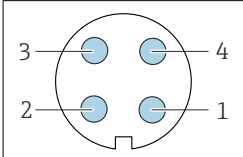
	Pin	Assignment	Coding	Plug/socket
	1	Ethernet-APL signal -		
	2	Ethernet-APL signal +		
	3	Cable shield ¹⁾		

	4	Not used		
	Metal plug housing	Cable shield		
	¹If a cable shield is used			

7.2.8 Preparing the device

Carry out the steps in the following order:

1. Mount the sensor and transmitter.
2. Sensor connection housing: Connect connecting cable.
3. Transmitter: Connect connecting cable.
4. Transmitter: Connect signal cable and cable for supply voltage.

NOTICE

Insufficient sealing of the housing!

Operational reliability of the measuring device could be compromised.

- ▶ Use suitable cable glands corresponding to the degree of protection.

1. Remove dummy plug if present.
2. If the measuring instrument is supplied without cable glands:
Provide suitable cable gland for corresponding connecting cable.
3. If the measuring instrument is supplied with cable glands:
Observe requirements for connecting cables →  38.

7.2.9 Preparing the connecting cable: Proline 500 – digital

When terminating the connecting cable, pay attention to the following points:

- ▶ For cables with fine-wire cores (stranded cables):
Fit the cores with ferrules.

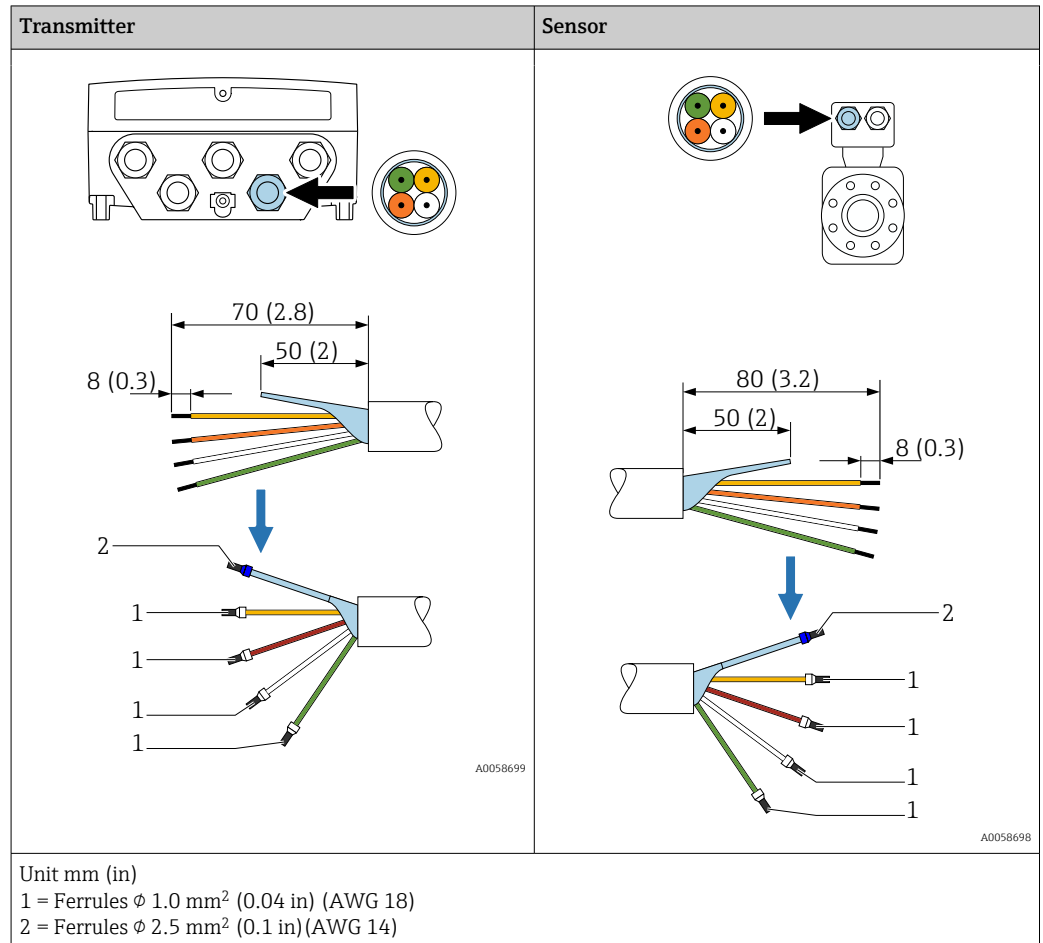

7.2.10 Preparing the connecting cable: Proline 500

When terminating the connecting cable, pay attention to the following points:

1. In the case of the electrode cable:
Make sure that the ferrules do not touch the core shields on the sensor side.
Minimum distance = 1 mm (exception: green "GND" cable)
2. In the case of the coil current cable:
Insulate one core of the three-core cable at the level of the core reinforcement. You only require two cores for the connection.
3. For cables with fine-wire cores (stranded cables):
Fit the cores with ferrules.

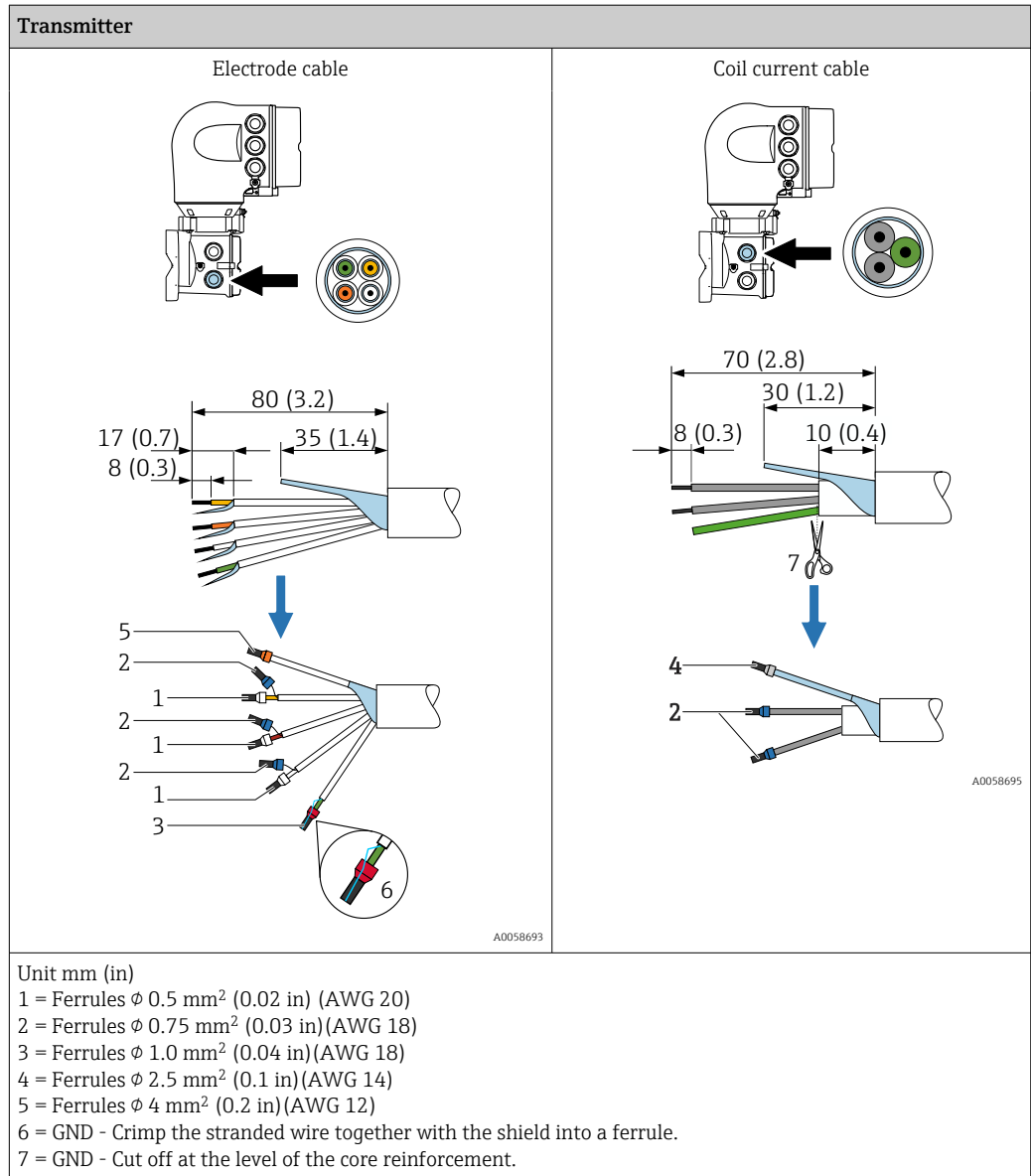

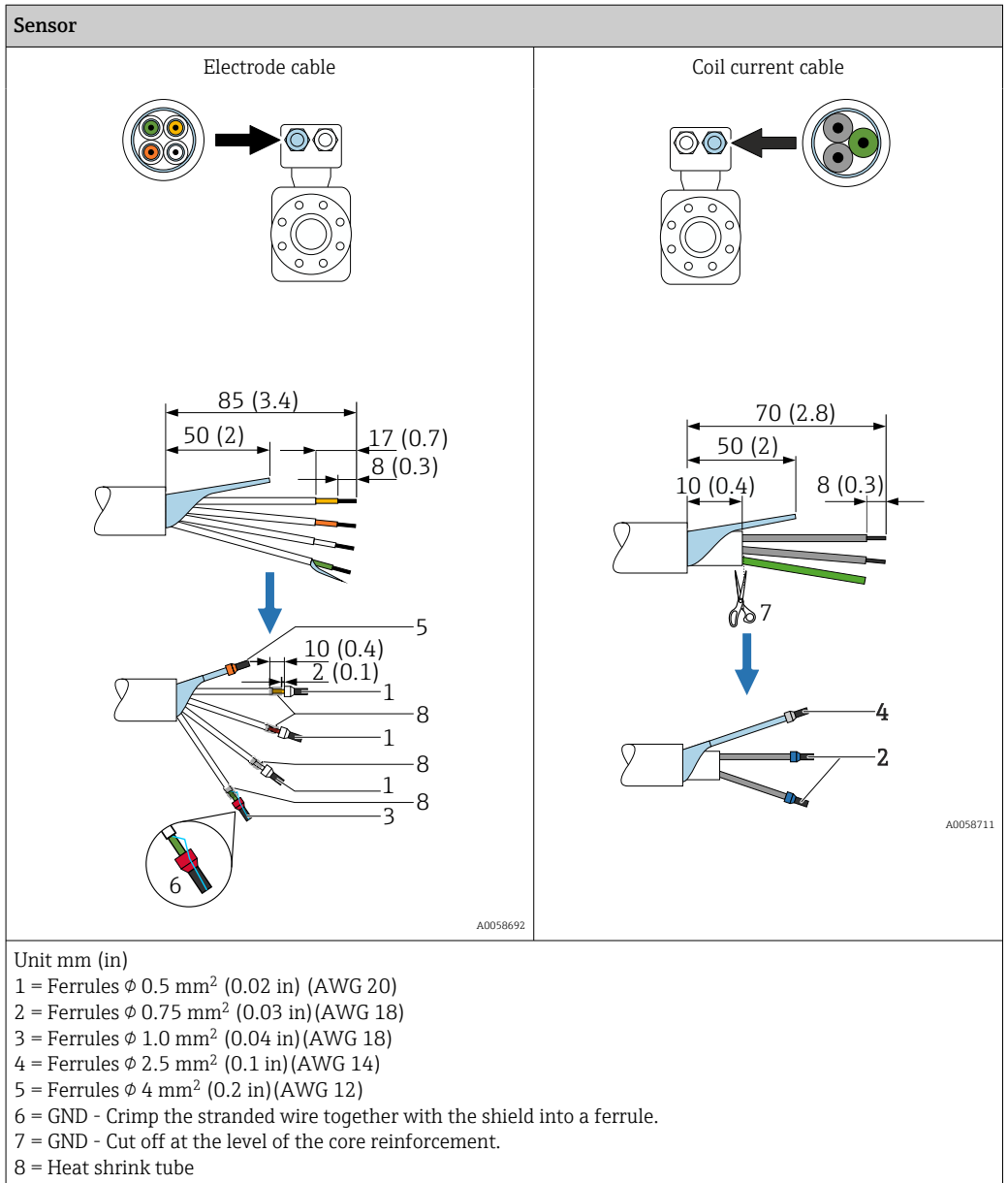

A0058711

7.3 Connecting the device: Proline 500 – digital

NOTICE

An incorrect connection compromises electrical safety!

- ▶ Only properly trained specialist staff may perform electrical connection work.
- ▶ Observe applicable federal/national installation codes and regulations.
- ▶ Comply with local workplace safety regulations.
- ▶ Always connect the protective ground cable ⊕ before connecting additional cables.
- ▶ When using in potentially explosive atmospheres, observe the information in the device-specific Ex documentation.

7.3.1 Connecting the connecting cable

NOTICE

Risk of damaging the electronic components!

- ▶ Connect the sensor and transmitter to the same potential equalization.
- ▶ Only connect the sensor to a transmitter with the same serial number.
- ▶ Ground the connection housing of the sensor via the external screw terminal.

Connecting cable terminal assignment

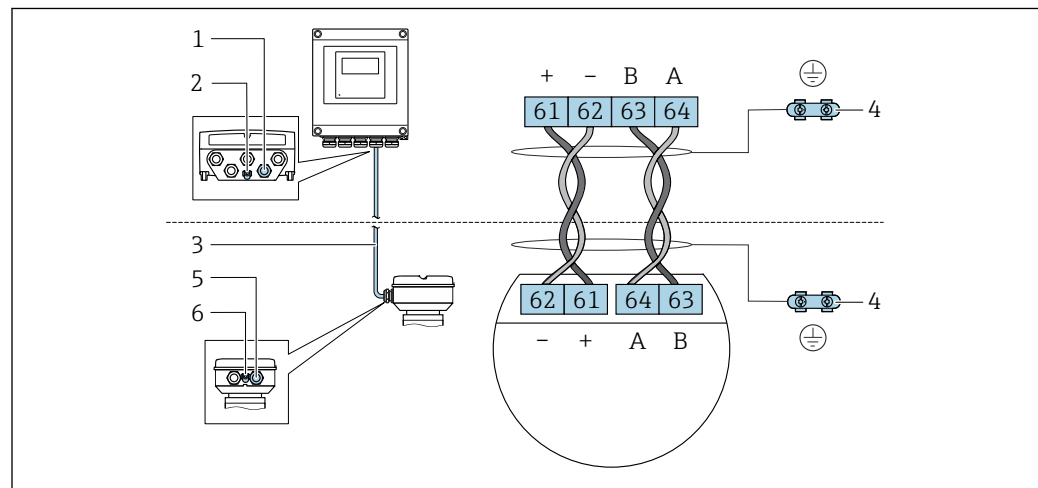

A0028198

- 1 Cable entry for cable on transmitter housing
- 2 Protective earth (PE)
- 3 Connecting cable ISEM communication
- 4 Grounding via ground connection; in the version with a device plug, grounding is ensured through the plug itself
- 5 Cable entry for cable or connection of device plug on sensor connection housing
- 6 Protective earth (PE)

Connecting the connecting cable to the sensor connection housing

- Connection via terminals with order code for "Sensor connection housing":
Option B "Stainless, hygienic" → 50
- Connection via connectors with order code for "Sensor connection housing":
Option C "Ultra-compact hygienic, stainless" → 51

Connecting the connecting cable to the transmitter

The cable is connected to the transmitter via terminals → 52.

Connecting the sensor connection housing via terminals

For the device version with the order code for "Sensor connection housing":
Option **A** "Aluminum coated"

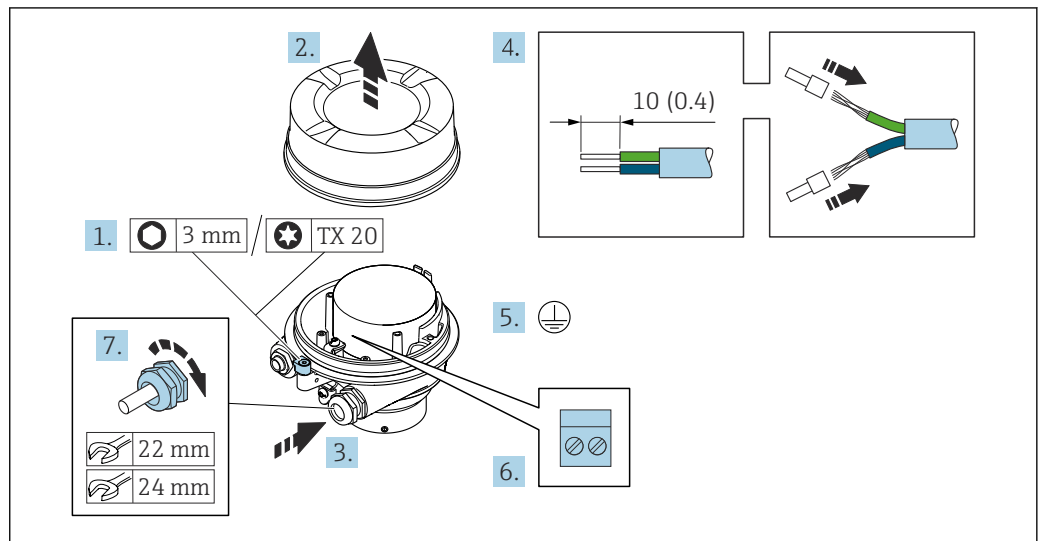

A0029616

1. Loosen the securing clamp of the housing cover.
2. Unscrew the housing cover.
3. Push the cable through the cable entry. To ensure tight sealing, do not remove the sealing ring from the cable entry.
4. Strip the cable and cable ends. In the case of stranded cables, fit ferrules.
5. Connect the protective ground.
6. Connect the cable in accordance with the connecting cable terminal assignment.
7. Firmly tighten the cable glands.
 - ↳ This concludes the process for connecting the connecting cable.

⚠ WARNING

Housing degree of protection voided due to insufficient sealing of the housing.

- ▶ Screw in the thread on the cover without using any lubricant. The thread on the cover is coated with a dry lubricant.
8. Screw on the housing cover.
 9. Tighten the securing clamp of the housing cover.

Connecting the sensor connection housing via terminals

For the device version with the order code for "Sensor connection housing":
Option B "Stainless, hygienic"

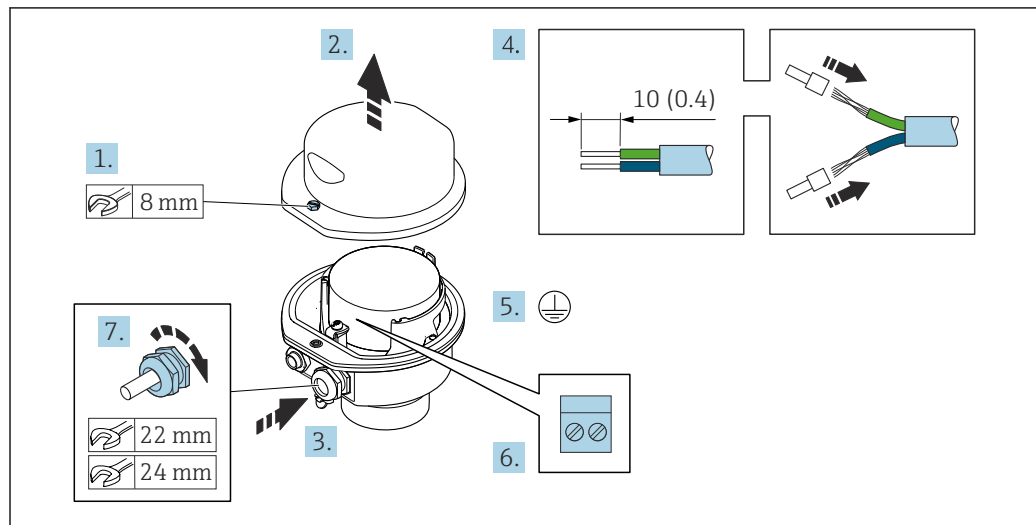

A0029613

1. Release the securing screw of the housing cover.
2. Open the housing cover.
3. Push the cable through the cable entry . To ensure tight sealing, do not remove the sealing ring from the cable entry.
4. Strip the cable and cable ends. In the case of stranded cables, fit ferrules.
5. Connect the protective ground.
6. Connect the cable in accordance with the connecting cable terminal assignment.
7. Firmly tighten the cable glands.
 - ↳ This concludes the process for connecting the connecting cable.
8. Close the housing cover.
9. Tighten the securing screw of the housing cover.

Connecting the sensor connection housing via the connector

For the device version with the order code for "Sensor connection housing":
Option C "Ultra-compact hygienic, stainless"

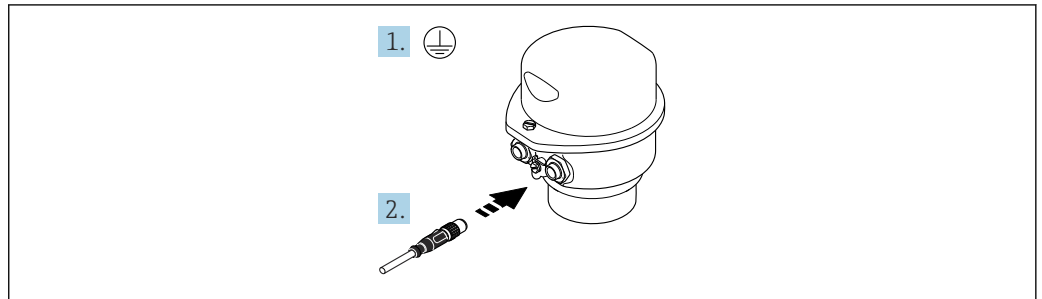

A0029615

1. Connect the protective ground.
2. Connect the connector.

Connecting the connecting cable to the transmitter

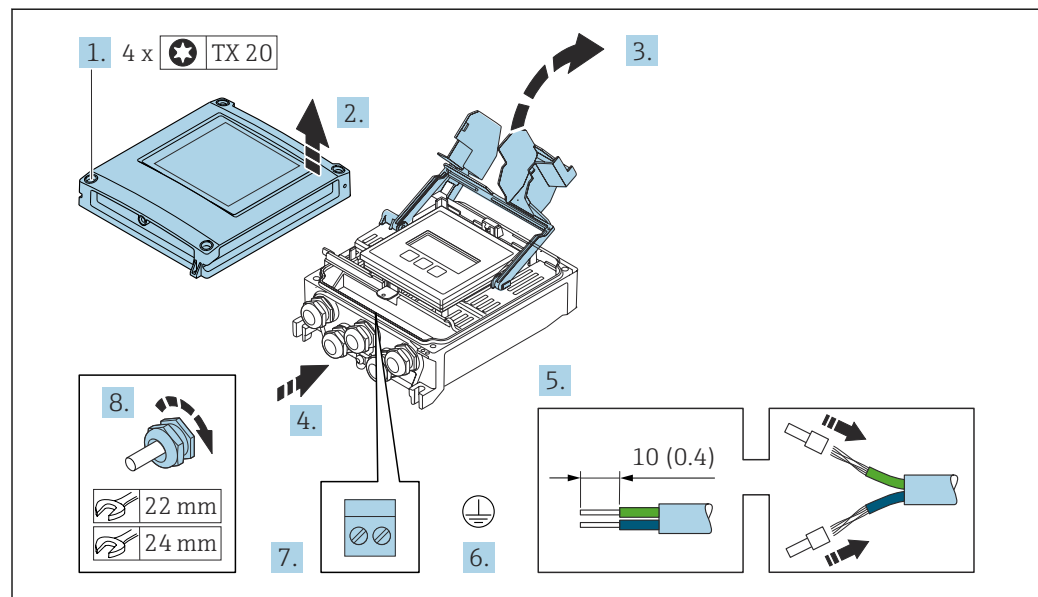

A0029597

1. Loosen the 4 fixing screws on the housing cover.
2. Open the housing cover.
3. Fold open the terminal cover.
4. Push the cable through the cable entry. To ensure tight sealing, do not remove the sealing ring from the cable entry.
5. Strip the cable and cable ends. In the case of stranded cables, fit ferrules.
6. Connect the protective ground.
7. Connect the cable according to the terminal assignment for the connecting cable → 48.
8. Firmly tighten the cable glands.
 - ↳ The process for connecting the connecting cable is now complete.
9. Close the housing cover.
10. Tighten the securing screw of the housing cover.
11. After connecting the connecting cable:
 - Connect the signal cable and the supply voltage cable → 53.

7.3.2 Connecting the transmitter

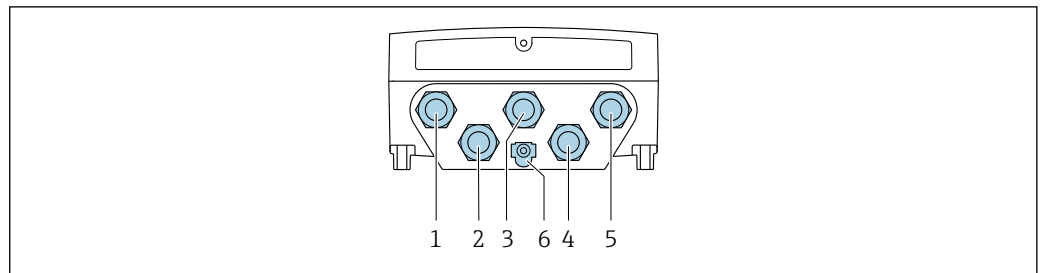

A0028200

- 1 Terminal connection for supply voltage
- 2 Terminal connection for signal transmission, input/output
- 3 Terminal connection for signal transmission, input/output
- 4 Terminal connection for connecting cable between sensor and transmitter
- 5 Terminal connection for signal transmission, input/output; optional: connection for external WLAN antenna
- 6 Protective earth (PE)

i In addition to connecting the device via and the available input/outputs, additional connection options are also available:
Integrate into a network via the service interface (CDI-RJ45) .

Connecting the plug

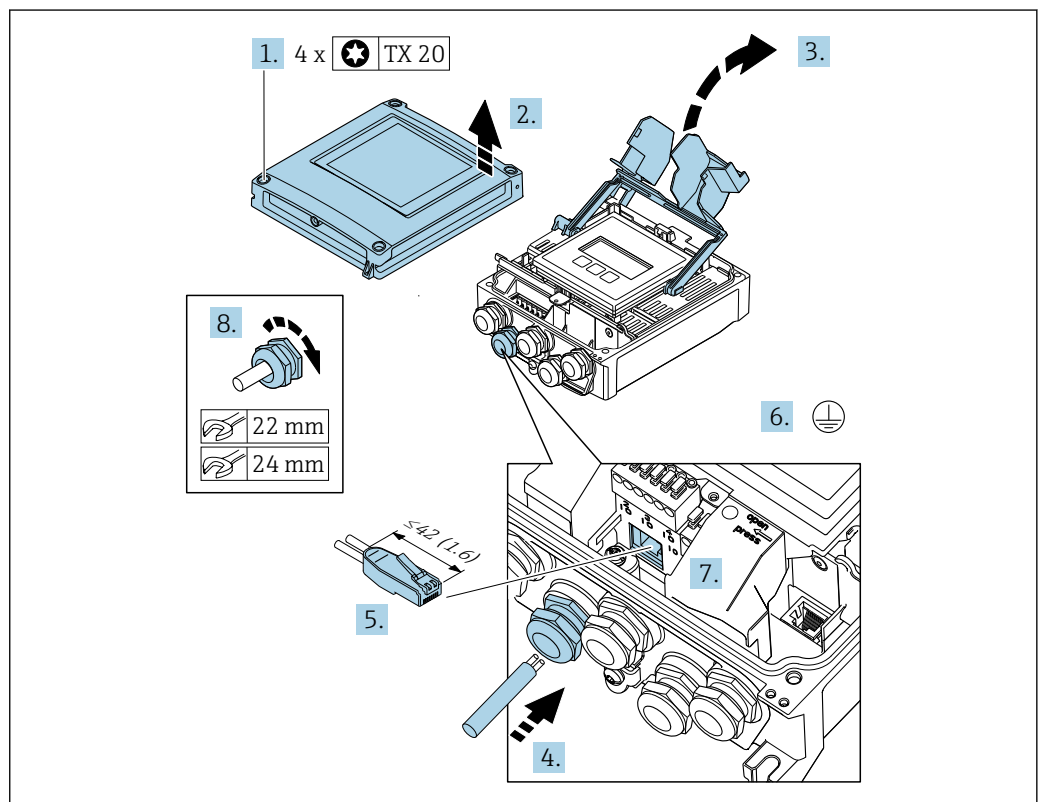

A0033987

1. Loosen the 4 fixing screws on the housing cover.
2. Open the housing cover.
3. Fold open the terminal cover.
4. Push the cable through the cable entry. To ensure tight sealing, do not remove the sealing ring from the cable entry.
5. Strip the cable and cable ends and connect to the RJ45 connector.
6. Connect the protective ground.

7. Plug in the RJ45 connector.
8. Firmly tighten the cable glands.
 - ↳ This concludes the connection process.

Connecting the supply voltage and additional inputs/outputs

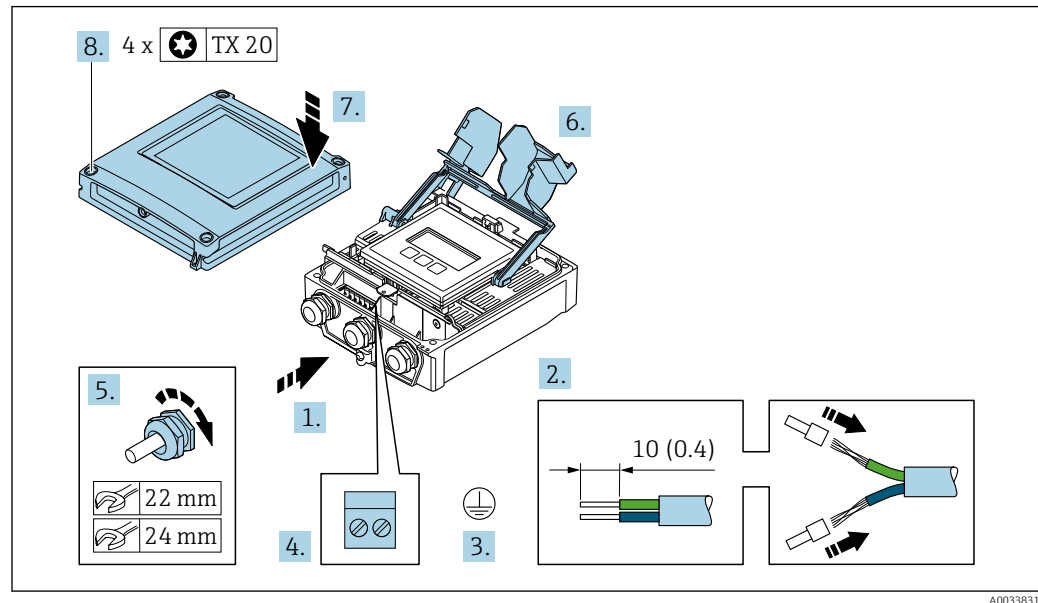

1. Push the cable through the cable entry. To ensure tight sealing, do not remove the sealing ring from the cable entry.
2. Strip the cable and cable ends. In the case of stranded cables, fit ferrules.
3. Connect the protective ground.
4. Connect the cable according to the terminal assignment.
 - ↳ **Signal cable terminal assignment:** The device-specific terminal assignment is documented on an adhesive label in the terminal cover.
 - Supply voltage terminal assignment:** Adhesive label in the terminal cover or → 42.
5. Firmly tighten the cable glands.
 - ↳ This concludes the cable connection process.
6. Close the terminal cover.
7. Close the housing cover.

⚠ WARNING

Housing degree of protection may be voided due to insufficient sealing of the housing.

- ▶ Screw in the screw without using any lubricant.

NOTICE

Excessive tightening torque applied to the fixing screws!

Risk of damaging the plastic transmitter.

- ▶ Tighten the fixing screws as per the tightening torque: 2.5 Nm (1.8 lbf ft)

8. Tighten the 4 fixing screws on the housing cover.

Removing a cable

To remove a cable from the terminal:

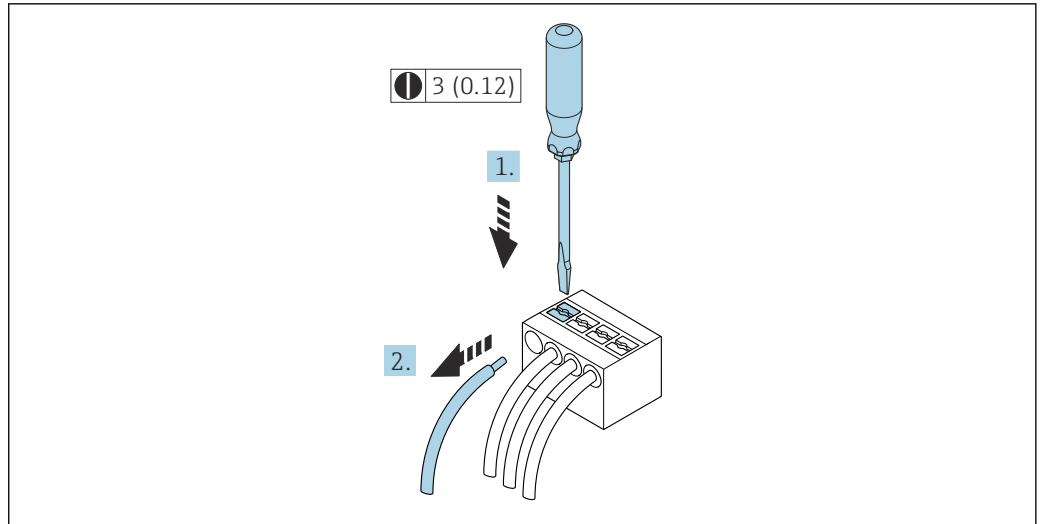

15 Unit mm(in)

1. Use a flat-blade screwdriver to press down on the slot between the two terminal holes.
2. Remove the cable end from the terminal.

7.4 Connecting the device: Proline 500

NOTICE

An incorrect connection compromises electrical safety!

- ▶ Only properly trained specialist staff may perform electrical connection work.
- ▶ Observe applicable federal/national installation codes and regulations.
- ▶ Comply with local workplace safety regulations.
- ▶ Always connect the protective ground cable ⊕ before connecting additional cables.
- ▶ When using in potentially explosive atmospheres, observe the information in the device-specific Ex documentation.

7.4.1 Connecting the connecting cable

NOTICE

Risk of damaging the electronic components!

- ▶ Connect the sensor and transmitter to the same potential equalization.
- ▶ Only connect the sensor to a transmitter with the same serial number.
- ▶ Ground the connection housing of the sensor via the external screw terminal.

Connecting cable terminal assignment

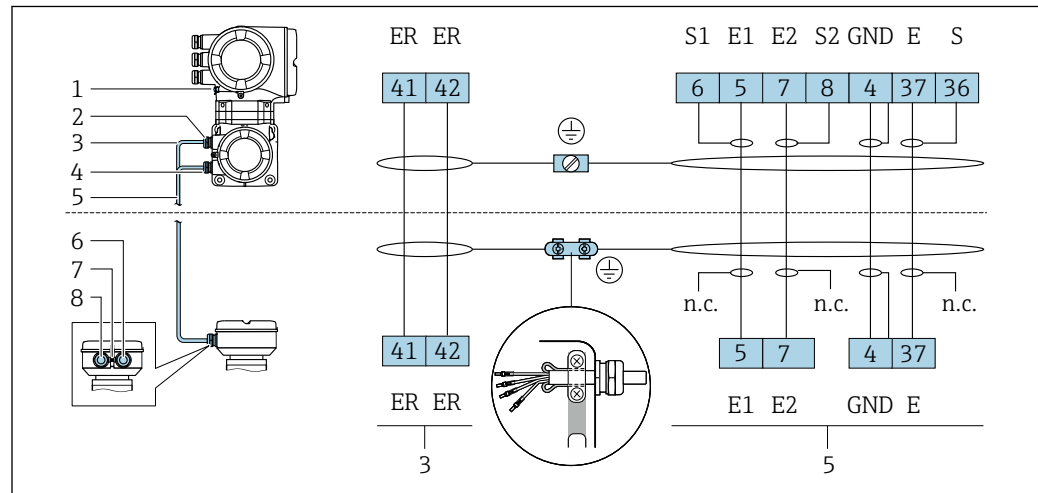

- 1 Protective earth (PE)
- 2 Cable entry for coil current cable on transmitter connection housing
- 3 Coil current cable
- 4 Cable entry for signal cable on transmitter connection housing
- 5 Signal cable
- 6 Cable entry for signal cable on sensor connection housing
- 7 Protective earth (PE)
- 8 Cable entry for coil current cable on sensor connection housing

Connecting the connecting cable to the sensor connection housing

Connection via terminals with order code for "Sensor connection housing":
Option **B** "Stainless, hygienic" → 57

Connecting the sensor connection housing via terminals

For the device version, order code for "Sensor connection housing":

Option **B**: stainless, hygienic

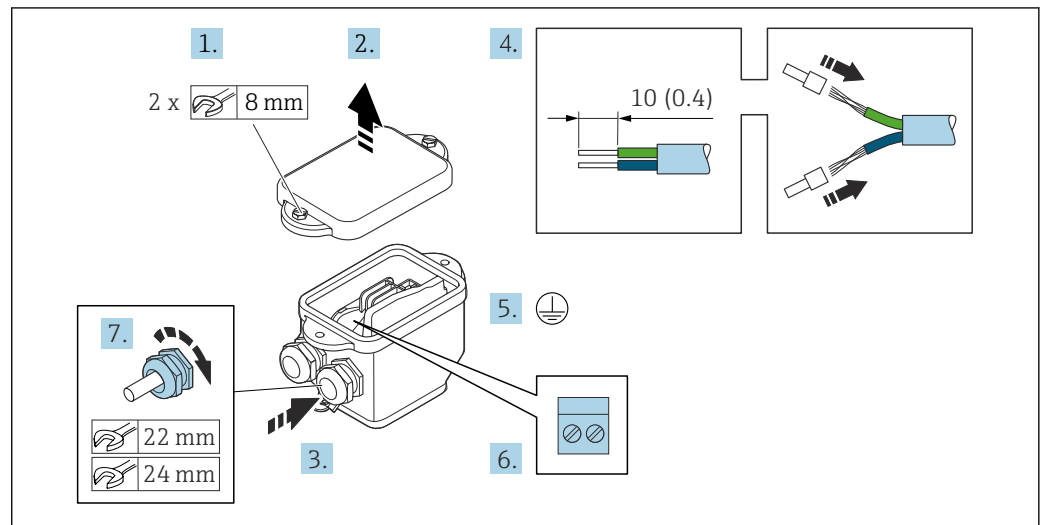

A0029617

1. Release the securing screw of the housing cover.
2. Open the housing cover.
3. Push the cable through the cable entry . To ensure tight sealing, do not remove the sealing ring from the cable entry.
4. Strip the cable and cable ends. In the case of stranded cables, fit ferrules.
5. Connect the protective ground.
6. Connect the cable in accordance with the connecting cable terminal assignment.
7. Firmly tighten the cable glands.
 - ↳ This concludes the process for connecting the connecting cables.
8. Close the housing cover.
9. Tighten the securing screw of the housing cover.

Attaching the connecting cable to the transmitter

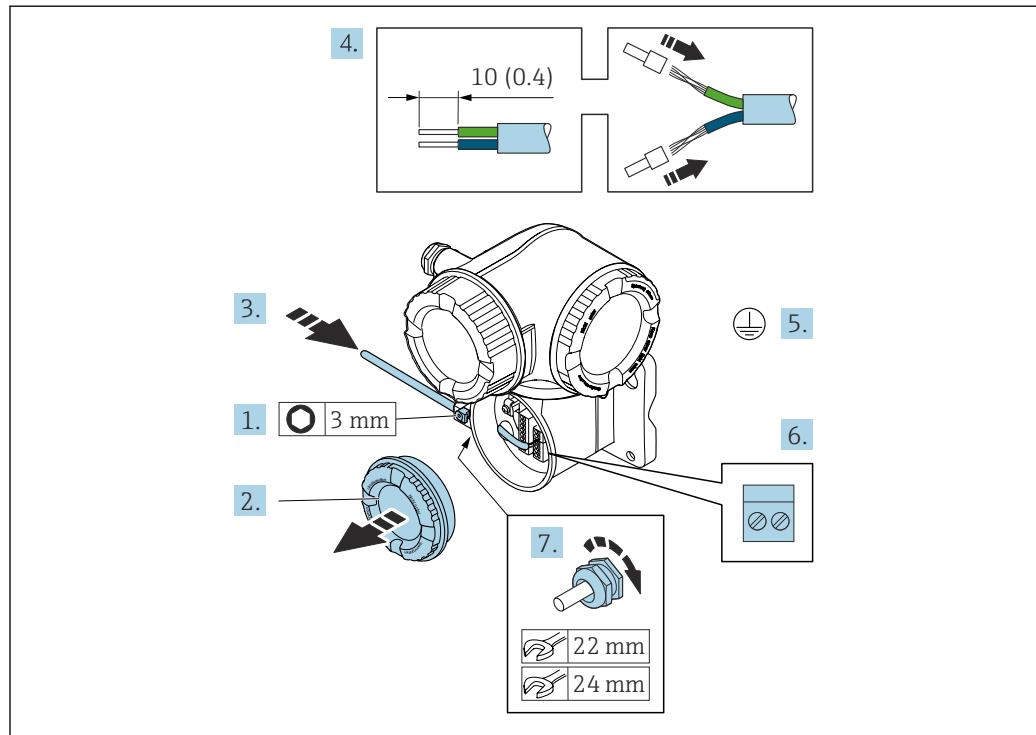

A0029592

1. Loosen the securing clamp of the connection compartment cover.
2. Unscrew the connection compartment cover.
3. Push the cable through the cable entry. To ensure tight sealing, do not remove the sealing ring from the cable entry.
4. Strip the cable and cable ends. In the case of stranded cables, also fit ferrules.
5. Connect the protective ground.
6. Connect the cable in accordance with the connecting cable terminal assignment
→ 56.
7. Firmly tighten the cable glands.
↳ This concludes the process for connecting the connecting cables.
8. Screw on the connection compartment cover.
9. Tighten the securing clamp of the connection compartment cover.
10. After connecting the connecting cables:
Connect the signal cable and the supply voltage cable .

7.5 Ensuring potential equalization

7.5.1 Requirements

For potential equalization:

- Pay attention to in-house grounding concepts
- Take account of operating conditions like the pipe material and grounding
- Connect the medium, sensor and transmitter to the same electric potential
- Use a ground cable with a minimum cross-section of 6 mm² (10 AWG) and a cable lug for potential equalization connections

7.5.2 Connection example, standard scenario

Metal process connections

Potential equalization is generally via the metal process connections that are in contact with the medium and mounted directly on the sensor. Therefore there is generally no need for additional potential equalization measures.

7.5.3 Connection example in special situations

Plastic process connections

In the case of plastic process connections, additional grounding rings or process connections with an integrated grounding electrode must be used to ensure potential matching between the sensor and the fluid. If there is no potential matching, this can affect the measuring accuracy or cause the destruction of the sensor as a result of the electrochemical decomposition of the electrodes.

Note the following when using grounding rings:

- Depending on the option ordered, plastic disks are used instead of grounding rings on some process connections. These plastic disks only act as "spacers" and do not have any potential matching function. Furthermore, they also perform a significant sealing function at the sensor/connection interface. Therefore, in the case of process connections without metal grounding rings, these plastic disks/seals should never be removed and should always be installed!
- Grounding rings can be ordered separately as accessory DK5HR* from Endress+Hauser (does not contain any seals). When ordering make sure that the grounding rings are compatible with the material used for the electrodes, as otherwise there is the danger that the electrodes could be destroyed by electrochemical corrosion!
- If seals are required, they can be additionally ordered with seal set DK5G*.
- Grounding rings including seals are mounted inside the process connections. This does not affect the installed length.

Potential equalization via additional grounding ring

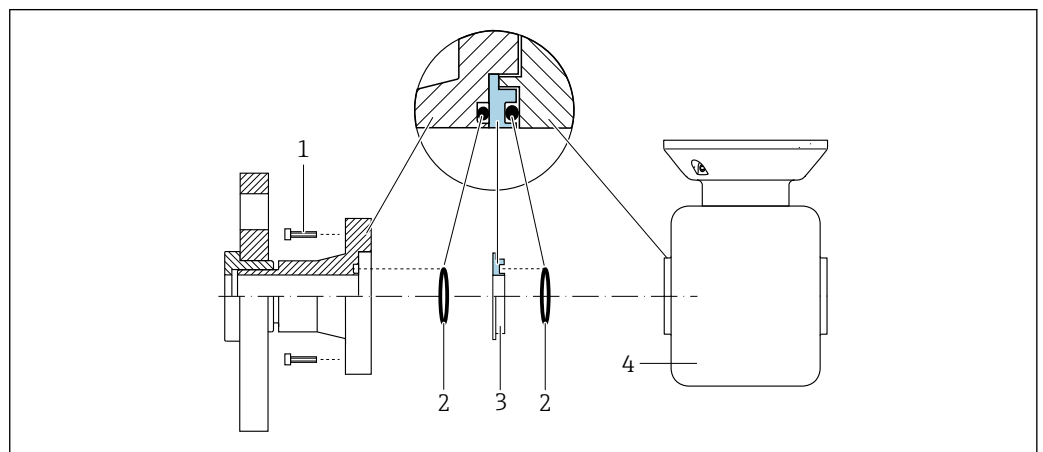

- 1 Hexagonal-headed bolts of process connection
- 2 O-ring seals
- 3 Plastic disk (spacer) or grounding ring
- 4 Sensor

A0028971

Potential equalization via grounding electrodes on process connection

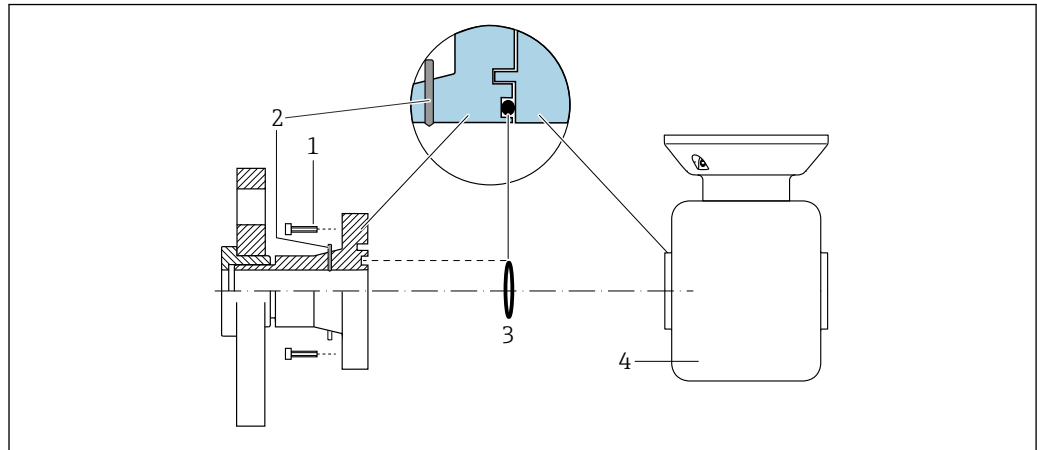

A0028972

- 1 Hexagonal-headed bolts of process connection
- 2 Integrated grounding electrodes
- 3 O-ring seal
- 4 Sensor

7.6 Special connection instructions

7.6.1 Connection examples

Current output 4 to 20 mA (without HART)

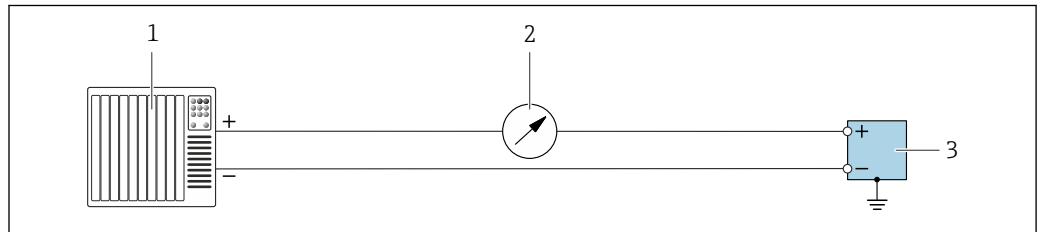

A0055851

16 Connection example for 4 to 20 mA current output (active)

- 1 Automation system with current input (e.g. PLC)
- 2 Optional additional display unit: Observe maximum load
- 3 Flowmeter with current output (active)

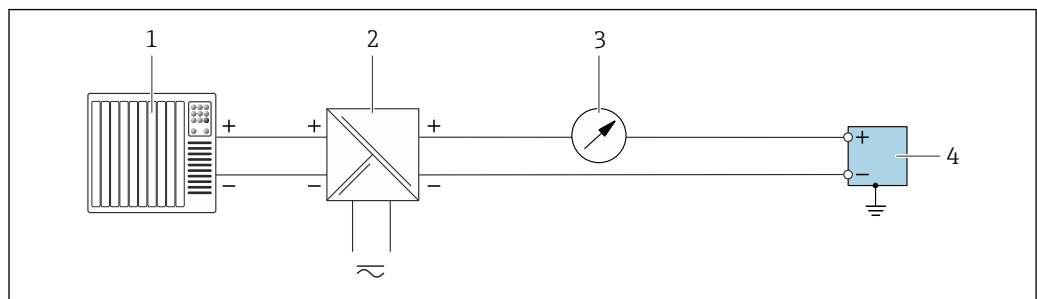

A0055852

17 Connection example for 4 to 20 mA current output (passive)

- 1 Automation system with current input (e.g. PLC)
- 2 Power supply
- 3 Optional additional display unit: Observe maximum load
- 4 Transmitter with current output (passive)

Current input 4 to 20 mA

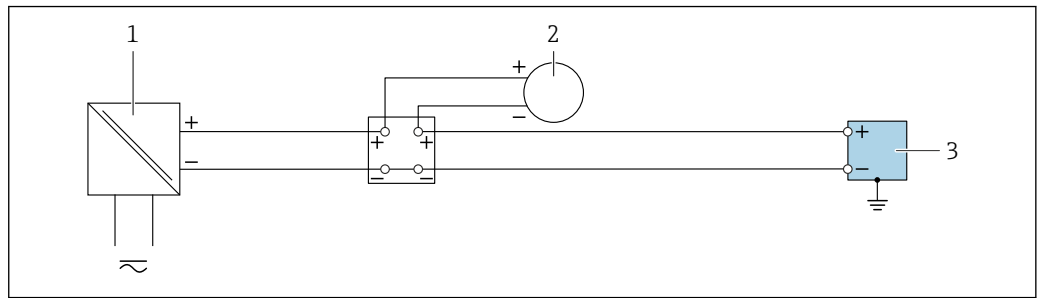

A0055B53

18 Connection example for 4 to 20 mA current input

- 1 Power supply
- 2 External measuring instrument with 4 to 20 mA passive current output. e.g. pressure or temperature
- 3 Transmitter with 4 to 20 mA current input

Pulse output/frequency output/switch output

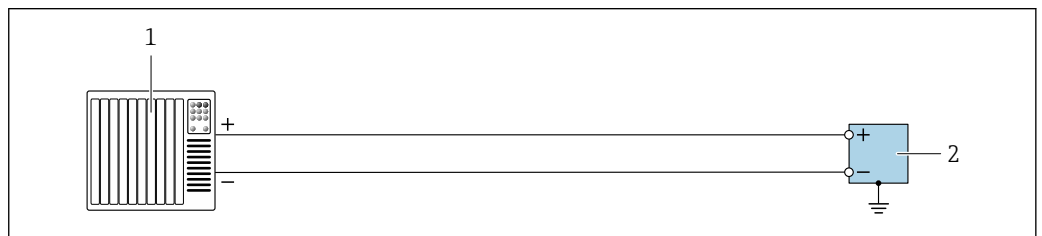

A0055B56

19 Connection example for pulse output/frequency output/switch output (active)

- 1 Automation system with pulse input/frequency input/switch input (e.g. PLC)
- 2 Transmitter with pulse output/frequency output/switch output (active)

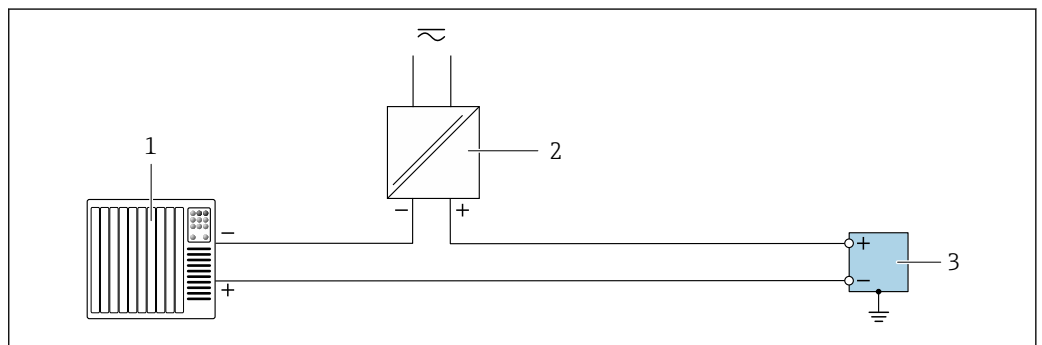

A0055B55

20 Connection example for pulse output/frequency output/switch output (passive)

- 1 Automation system with pulse input/frequency input/switch input (e.g. PLC)
- 2 Power supply
- 3 Transmitter with pulse output/frequency output/switch output (passive)

Relay output

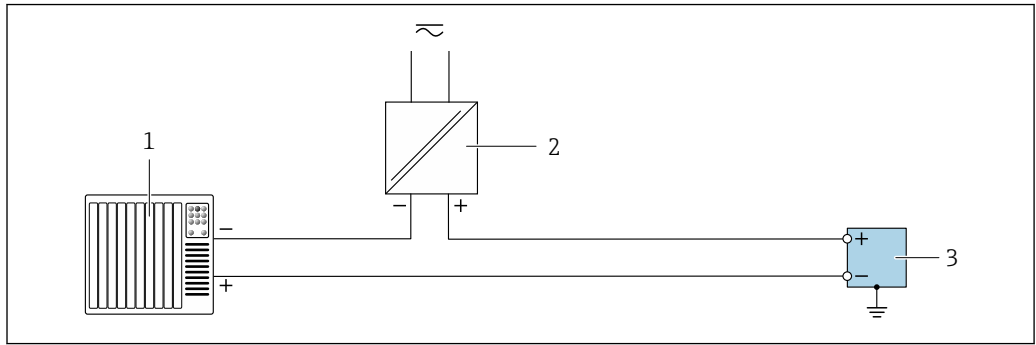

A0055859

21 Connection example for relay output

- 1 Automation system with switch input (e.g. PLC)
- 2 Power supply
- 3 Transmitter with relay output

Status input

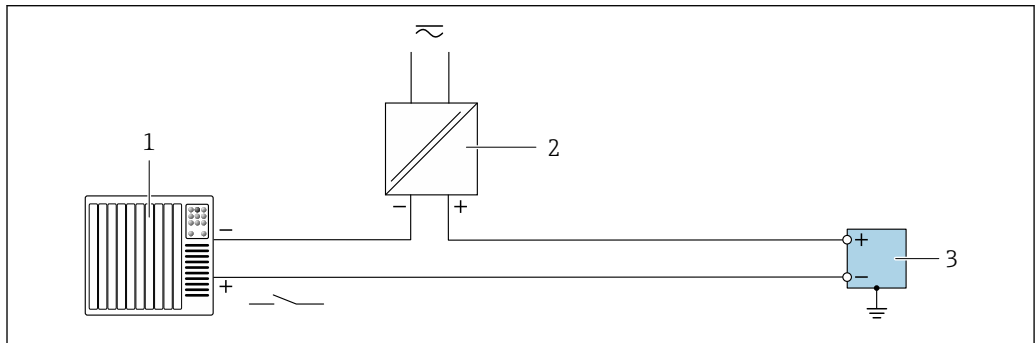

A0055860

22 Connection example for status input

- 1 Automation system with switch output passive e.g. PLC)
- 2 Power supply
- 3 Transmitter with status input

Ethernet-APL

See <https://www.profibus.com> Ethernet-APL White Paper "

7.7 Hardware settings

7.7.1 Setting the device address

The IP address of the measuring instrument can be configured for the network via DIP switches.

Addressing data

IP address and configuration options			
1st octet	2nd octet	3rd octet	4th octet
192.	168.	1.	XXX
	↓		↓
	Can only be configured via software addressing		Can be configured via software addressing and hardware addressing

IP address range	1 to 254 (4th octet)
IP address broadcast	255
Addressing mode ex works	Software addressing; all DIP switches for hardware addressing are set to OFF.
IP address ex works	DHCP server active

Setting the IP address: Proline 500 - digital

Risk of electric shock when opening the transmitter housing.

- ▶ Before opening the transmitter housing:
- ▶ Disconnect the device from the power supply.

 The default IP address may **not** be activated .

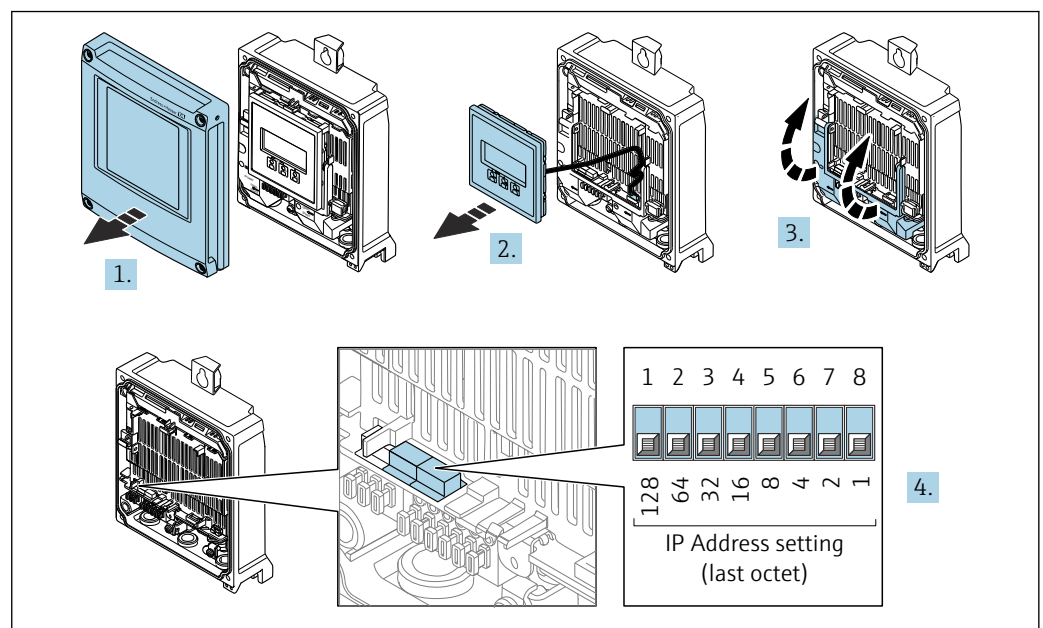

A0029678

1. Loosen the 4 fixing screws on the housing cover.
2. Open the housing cover.
3. Fold open the terminal cover.
4. Set the desired IP address using the corresponding DIP switches on the I/O electronics module.
5. Reassemble the transmitter in the reverse order.
6. Reconnect the device to the power supply.
 - ↳ The configured device address is used once the device is restarted.

Setting the IP address: Proline 500

Risk of electric shock when opening the transmitter housing.

- ▶ Before opening the transmitter housing:
- ▶ Disconnect the device from the power supply.

 The default IP address may **not** be activated .

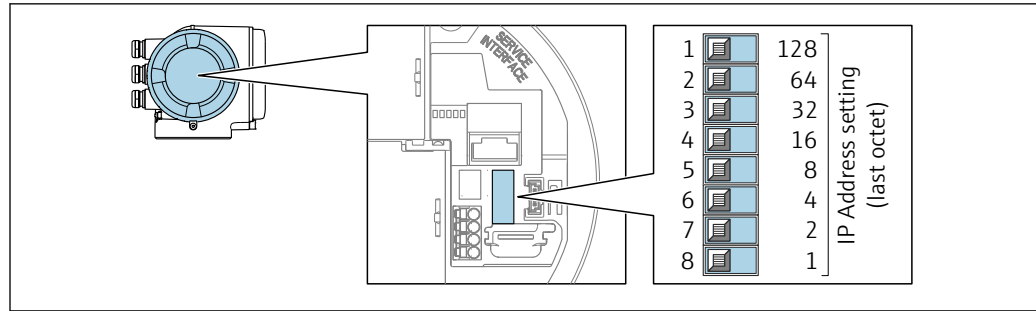

A0029635

1. Depending on the housing version, loosen the securing clamp or fixing screw of the housing cover.
2. Depending on the housing version, unscrew or open the housing cover and disconnect the local display from the main electronics module where necessary.
3. Set the desired IP address using the corresponding DIP switches on the I/O electronics module.
4. Reassemble the transmitter in the reverse order.
5. Reconnect the device to the power supply.
 - ↳ The configured device address is used once the device is restarted.

7.7.2 Activating the default IP address

Activating the default IP address by DIP switch: Proline 500 - digital

Risk of electric shock when opening the transmitter housing.

- ▶ Before opening the transmitter housing:
- ▶ Disconnect the device from the power supply.

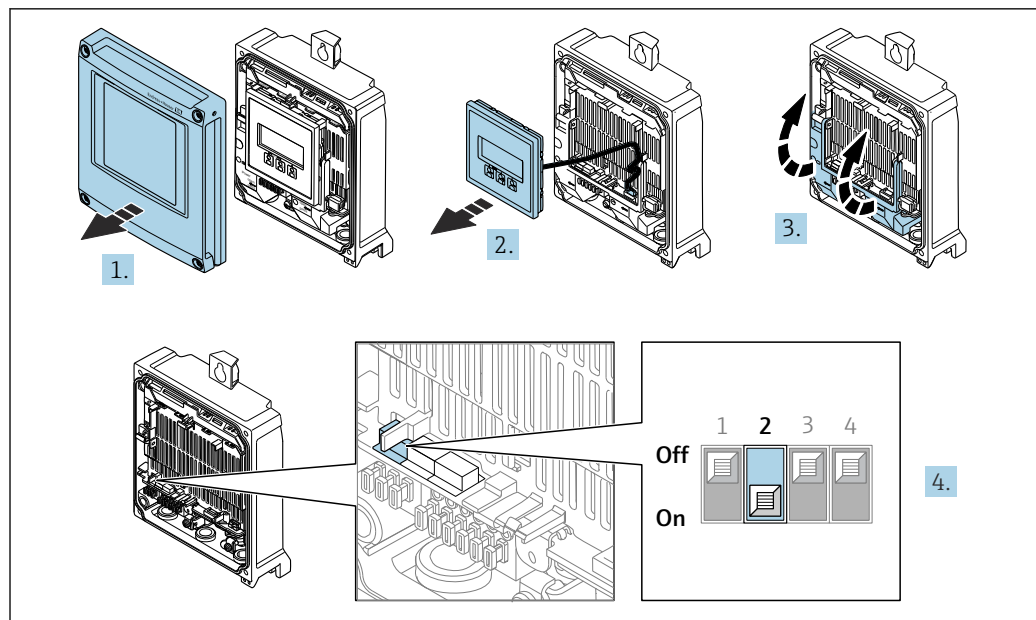

A0034500

1. Loosen the 4 fixing screws on the housing cover.
2. Open the housing cover.
3. Fold open the terminal cover.
4. Set DIP switch no. on the I/O electronics module from **OFF** → **ON**.
5. Reassemble the transmitter in the reverse order.

6. Reconnect the device to the power supply.
 - ↳ The default IP address is used once the device is restarted.

Activating the default IP address by DIP switch: Proline 500

Risk of electric shock when opening the transmitter housing.

- ▶ Before opening the transmitter housing:
- ▶ Disconnect the device from the power supply.

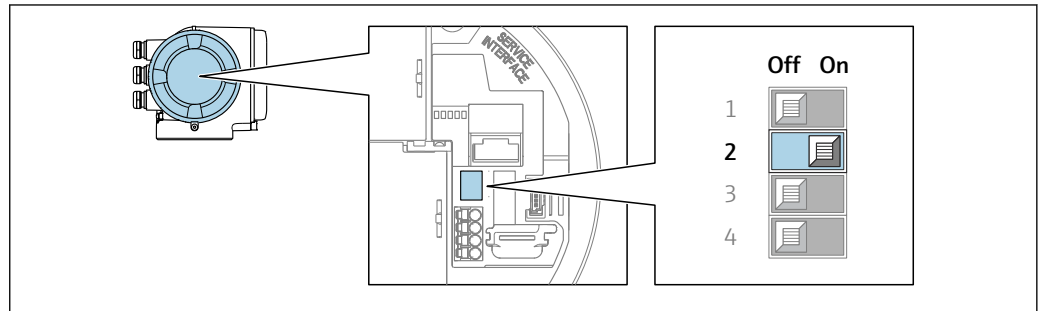

1. Depending on the housing version, loosen the securing clamp or fixing screw of the housing cover.
2. Depending on the housing version, unscrew or open the housing cover and disconnect the local display from the main electronics module where necessary .
3. DIP switch no. 2 on the I/O electronics module from **OFF** → **ON**.
4. Reassemble the transmitter in the reverse order.
5. Reconnect the device to the power supply.
 - ↳ The default IP address is used once the device is restarted.

7.8 Ensuring the degree of protection

The measuring instrument fulfills all the requirements for the degree of protection IP66/67, Type 4X enclosure.

To ensure degree of protection IP66/67, Type 4X enclosure, carry out the following steps after making the electrical connection:

1. Check that the housing seals are clean and fitted correctly.
2. Dry, clean or replace the seals if necessary.
3. Tighten all housing screws and screw covers.
4. Firmly tighten the cable glands.
5. To ensure that moisture does not enter the cable entry:
 - Route the cable so that it loops down before the cable entry ("water trap").

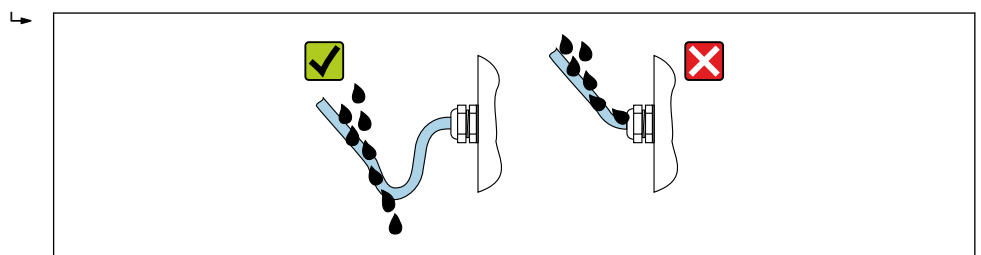

6. The supplied cable glands and plastic dummy plugs used for the threaded cable entries do not ensure degree of protection IP66/67, Type 4X enclosure. To achieve this degree of protection, cable glands and plastic dummy plugs that are not used must be replaced by threaded dummy plugs with the degree of protection IP66/67, Type 4X enclosure.

7.9 Post-connection check

Are the device and cable undamaged (visual inspection)?	<input type="checkbox"/>
Is the protective earthing established correctly?	<input type="checkbox"/>
Do the cables used meet the requirements ?	<input type="checkbox"/>
Are the mounted cables strain-relieved and fixed securely in place?	<input type="checkbox"/>
Are all cable glands installed, securely tightened and leak-tight? Cable run with "water trap" → 65?	<input type="checkbox"/>
Is the terminal assignment correct ?	<input type="checkbox"/>
Is the potential equalization established correctly ?	<input type="checkbox"/>
Are dummy plugs inserted in unused cable entries and have transportation plugs been replaced with dummy plugs?	<input type="checkbox"/>

8 Operation options

8.1 Overview of operation options

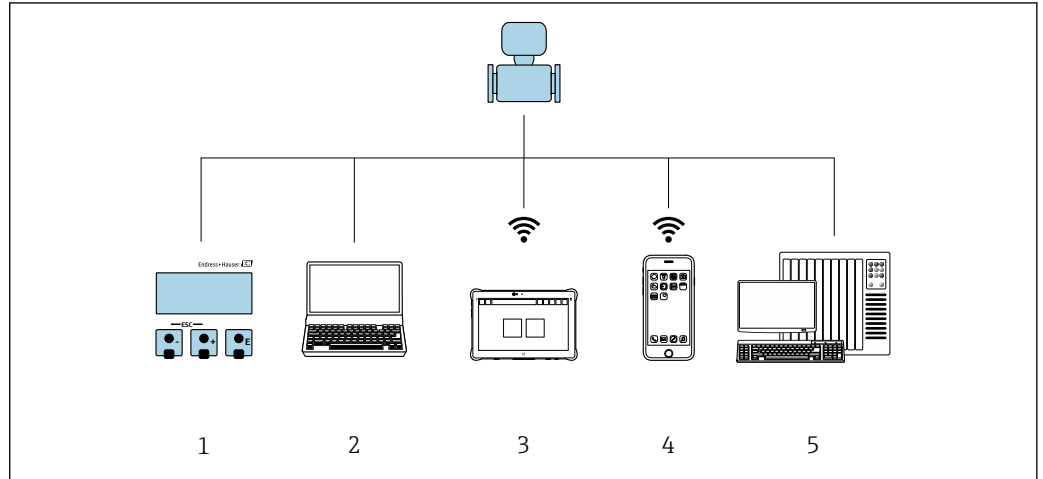



A0046226

- 1 Local operation via display module
- 2 Computer with web browser or with operating tool (e.g. FieldCare, DeviceCare, SIMATIC PDM)
- 3 Field Xpert SMT70
- 4 Mobile handheld terminal
- 5 Automation system (e.g. PLC)

8.2 Structure and function of the operating menu

8.2.1 Structure of the operating menu

 For an overview of the operating menu for experts: see the "Description of Device Parameters" document supplied with the device →  209

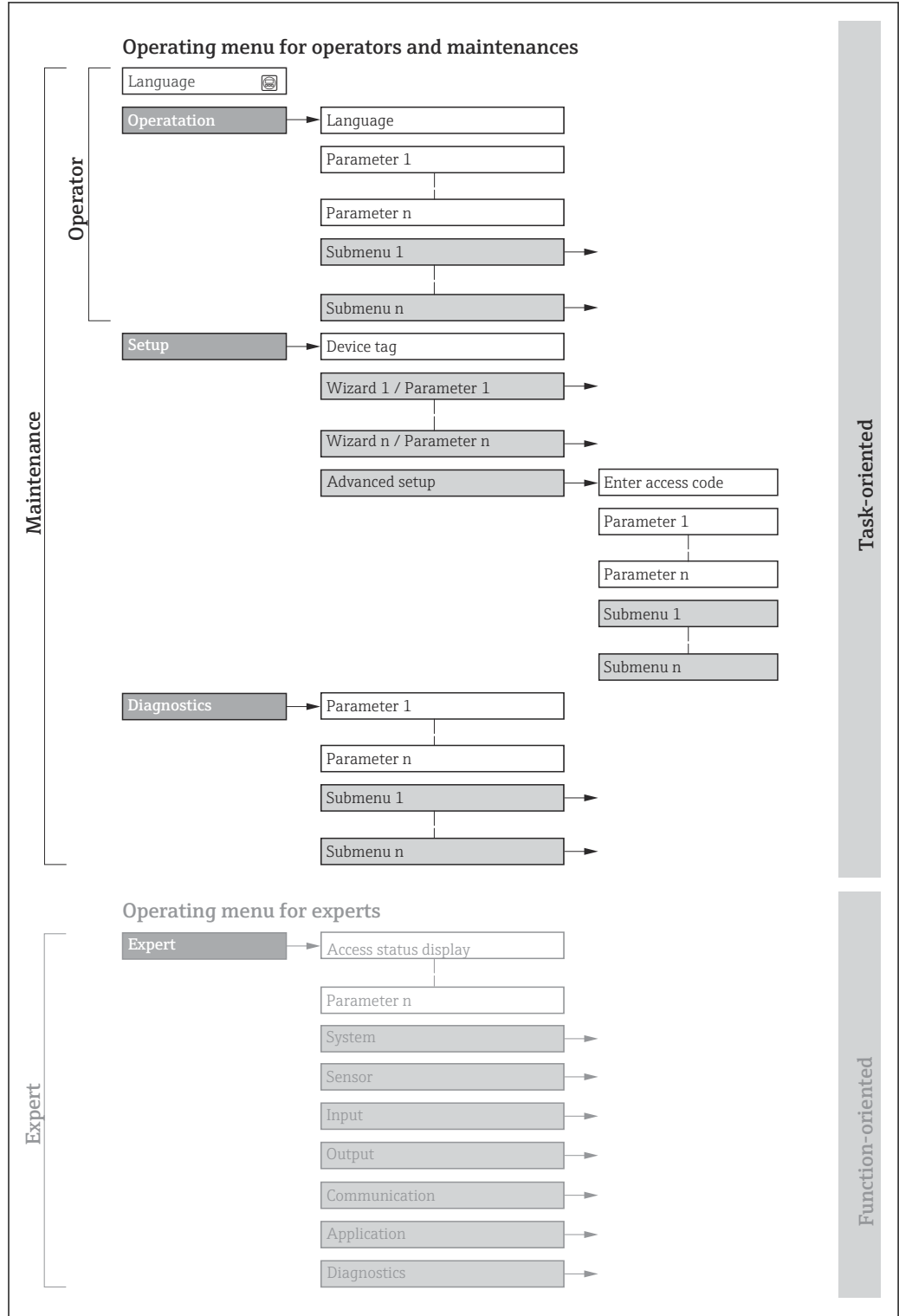

 23 Schematic structure of the operating menu

A0018237-EN

8.2.2 Operating philosophy

The individual parts of the operating menu are assigned to certain user roles (e.g. operator, maintenance etc.). Each user role contains typical tasks within the device life cycle.

Menu/parameter		User role and tasks	Content/meaning
Language	Task-oriented	Role "Operator", "Maintenance" Tasks during operation: <ul style="list-style-type: none"> ▪ Configuring the operational display ▪ Reading measured values 	Defining the operating language
Operation			<ul style="list-style-type: none"> ▪ Defining the operating language ▪ Defining the web server operating language ▪ Resetting and controlling totalizers ▪ Configuring the operational display (e.g. display format, display contrast) ▪ Resetting and controlling totalizers
Setup		"Maintenance" role Commissioning: <ul style="list-style-type: none"> ▪ Configuring the measurement ▪ Configuring the inputs and outputs ▪ Configuring the communication interface 	Wizard for quick commissioning: <ul style="list-style-type: none"> ▪ Configuring the system units ▪ Displaying the I/O configuration ▪ Configuring the inputs ▪ Configuring the outputs ▪ Configuring the operational display ▪ Configuring the low flow cut off ▪ Configuring empty pipe detection Advanced setup <ul style="list-style-type: none"> ▪ For more customized configuration of the measurement (adaptation to special measuring conditions) ▪ Calculated process variables ▪ Sensor adjustment ▪ Configuring totalizers ▪ Configuring the display ▪ Configuring electrode cleaning (optional) ▪ Configuring the WLAN settings ▪ Data backup ▪ Administration (define access code, reset measuring instrument)
Diagnostics	"Maintenance" role Troubleshooting: <ul style="list-style-type: none"> ▪ Diagnostics and elimination of process and device errors ▪ Measured value simulation 	Contains all parameters for error detection and analyzing process and device errors: <ul style="list-style-type: none"> ▪ Diagnostic list Contains up to 5 currently pending diagnostic messages. ▪ Event logbook Contains event messages that have occurred. ▪ Device information Contains information for identifying the device. ▪ Measured values Contains all current measured values. ▪ Data logging submenu with the "Extended HistoROM" order option Storage and visualization of measured values ▪ Heartbeat Technology The functionality of the device is checked on demand and the verification results are documented. ▪ Simulation Used to simulate measured values or output values. ▪ Testpoints 	

Menu/parameter	User role and tasks	Content/meaning
Expert	Function-oriented	<p>Tasks that require detailed knowledge of the function of the device:</p> <ul style="list-style-type: none"> ▪ Commissioning measurements under difficult conditions ▪ Optimal adaptation of the measurement to difficult conditions ▪ Detailed configuration of the communication interface ▪ Error diagnostics in difficult cases
		<p>Contains all the parameters of the device and makes it possible to access these parameters directly using an access code. The structure of this menu is based on the function blocks of the device:</p> <ul style="list-style-type: none"> ▪ System Contains all higher-level device parameters that do not affect measurement or measured value communication. ▪ Sensor Configuring the measurement. ▪ Input Configuring the status input. ▪ Output Configuring the analog current outputs as well as the pulse/frequency and switch output. ▪ Communication Configuring the digital communication interface and the web server. ▪ Application Configuring the functions that go beyond the actual measurement (e.g. totalizer). ▪ Diagnostics Error detection and analysis of process and device errors and for device simulation and the Heartbeat Technology menu.

8.3 Access to operating menu via local display

8.3.1 Operational display

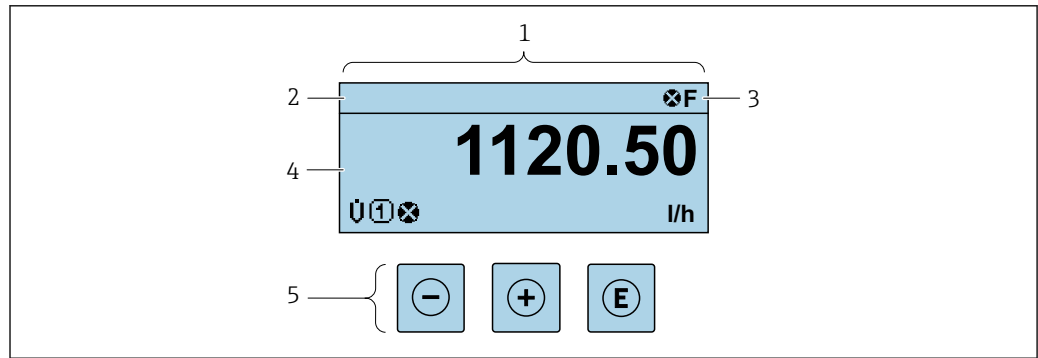

- 1 Operational display
- 2 Tag name
- 3 Status area
- 4 Display area for measured values (up to 4 lines)
- 5 Operating elements → 76

Status area

The following symbols appear in the status area of the operational display at the top right:



- Status signals → 158
 - F: Failure
 - C: Function check
 - S: Out of specification
 - M: Maintenance required
- Diagnostic behavior → 159
 - ⊗: Alarm
 - ⚠: Warning
 - 🗝: Locking (the device is locked via the hardware)
 - ↔: Communication (communication via remote operation is active)

Display area

In the display area, each measured value is prefaced by certain symbol types for further description:

Measured variables

Symbol	Meaning
U	
G	Conductivity
\dot{m}	Mass flow

 The number and display format of the measured variables can be configured via the **Format display** parameter (→  116).



Totalizer

Symbol	Meaning
Σ	Totalizer  The measurement channel number indicates which of the three totalizers is displayed.



Input

Symbol	Meaning
	Status input

Measurement channel numbers

Symbol	Meaning
	Measurement channel 1 to 4  The measurement channel number is displayed only if more than one channel is present for the same measured variable type (e.g. Totalizer 1 to 3).

Diagnostic behavior

Symbol	Meaning
	Alarm <ul style="list-style-type: none"> ▪ Measurement is interrupted. ▪ Signal outputs and totalizers assume the defined alarm condition. ▪ A diagnostic message is generated.
	Warning <ul style="list-style-type: none"> ▪ Measurement is resumed. ▪ The signal outputs and totalizers are not affected. ▪ A diagnostic message is generated.

 The diagnostic behavior pertains to a diagnostic event that is relevant to the displayed measured variable.

8.3.2 Navigation view

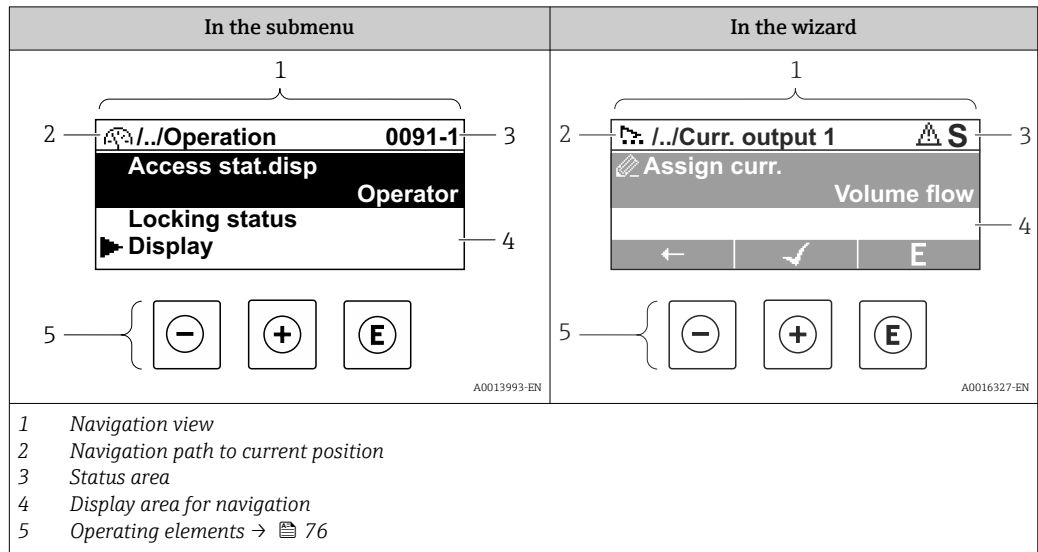

Navigation path

The navigation path to the current position is displayed at the top left in the navigation view and consists of the following elements:

- The display symbol for the menu/submenu (▶) or the wizard (⚙).
- An omission symbol (/ ../) for operating menu levels in between.
- Name of the current submenu, wizard or parameter

	Display symbol	Omission symbol	Parameter
	↓	↓	↓
Example	▶	/ ../	Indication

For more information about the icons in the menu, refer to the "Display area" section → 72

Status area

The following appears in the status area of the navigation view in the top right corner:



- In the submenu
 - The direct access code to the parameter (e.g., 0022-1)
 - If a diagnostic event is present, the diagnostic behavior and status signal
- In the wizard
 - If a diagnostic event is present, the diagnostic behavior and status signal

- For information on the diagnostic behavior and status signal → 158
- For information on the function and entry of the direct access code → 78





Display area

Menus

Symbol	Meaning
	<p>Operation Is displayed:</p> <ul style="list-style-type: none"> ▪ In the menu next to the "Operation" selection ▪ At the left in the navigation path in the Operation menu

	<p>Setup Is displayed:</p> <ul style="list-style-type: none"> ▪ In the menu next to the "Setup" selection ▪ At the left in the navigation path in the Setup menu
	<p>Diagnosis Is displayed:</p> <ul style="list-style-type: none"> ▪ In the menu next to the "Diagnostics" selection ▪ At the left in the navigation path in the Diagnostics menu
	<p>Expert Is displayed:</p> <ul style="list-style-type: none"> ▪ In the menu next to the "Expert" selection ▪ At the left in the navigation path in the Expert menu



Submenus, wizards, parameters

Symbol	Meaning
	Submenu
	Wizards
	Parameters within a wizard
	No display symbol exists for parameters in submenus.

Locking procedure

Symbol	Meaning
	<p>Parameter locked When displayed in front of a parameter name, indicates that the parameter is locked.</p> <ul style="list-style-type: none"> ▪ By a user-specific access code ▪ By the hardware write protection switch

Wizards

Symbol	Meaning
	Switches to the previous parameter.
	Confirms the parameter value and switches to the next parameter.
	Opens the editing view of the parameter.

8.3.3 Editing view

Numeric editor

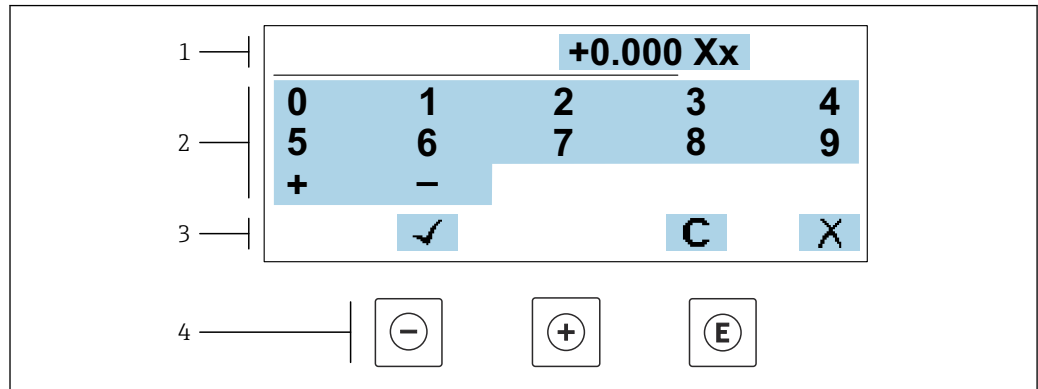

A0034250

24 For entering values in parameters (e.g. limit values)

- 1 Entry display area
- 2 Input screen
- 3 Confirm, delete or reject entry
- 4 Operating elements

Text editor

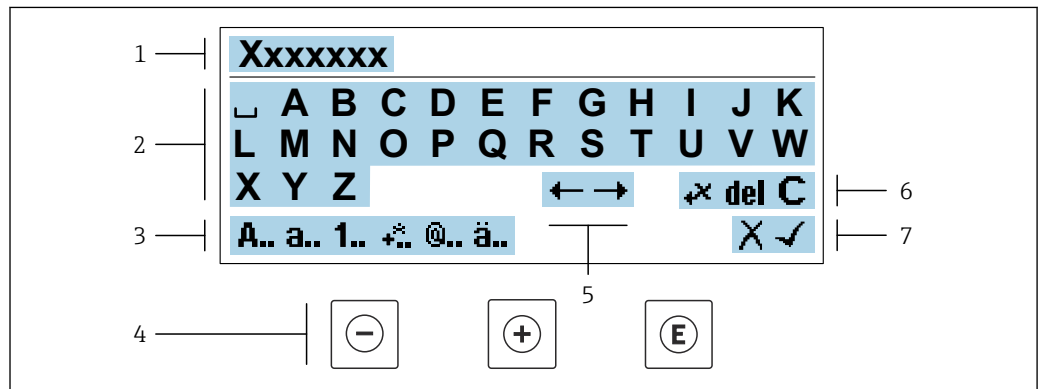

A0034114

25 For entering text in parameters (e.g. device tag)

- 1 Entry display area
- 2 Current input screen
- 3 Change input screen
- 4 Operating elements
- 5 Move entry position
- 6 Delete entry
- 7 Reject or confirm entry

Using the operating elements in the editing view



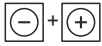

Operating key	Meaning
⊖	Minus key Move the entry position to the left.
⊕	Plus key Move the entry position to the right.

Operating key	Meaning
	Enter key <ul style="list-style-type: none"> Pressing the key briefly confirms your selection. Pressing the key for 2 s confirms your entry.
	Escape key combination (press keys simultaneously) Close the editing view without accepting a change.





Input screens

Symbol	Meaning
A..	Upper case
a..	Lower case
1..	Numbers
+..	Punctuation marks and special characters: = + - * / ² ³ ¼ ½ ¾ () [] < > { }
@..	Punctuation marks and special characters: " ' ^ . , ; : ? ! % μ ° € \$ £ ¥ § @ # / \ ~ & _
ä..	Umlauts and accents

Controlling data entries

Symbol	Meaning
	Move entry position
	Reject entry
	Confirm entry
	Delete character immediately to the left of the entry position
del	Delete character immediately to the right of the entry position
C	Clear all the characters entered

8.3.4 Operating elements

Operating key	Meaning
	<p>Minus key</p> <p><i>In menu, submenu</i> Moves the selection bar upwards in a picklist</p> <p><i>In wizards</i> Goes to previous parameter</p> <p><i>In the text and numeric editor</i> Move the entry position to the left.</p>
	<p>Plus key</p> <p><i>In menu, submenu</i> Moves the selection bar downwards in a picklist</p> <p><i>In wizards</i> Goes to the next parameter</p> <p><i>In the text and numeric editor</i> Move the entry position to the right.</p>
	<p>Enter key</p> <p><i>In the operational display</i> Pressing the key briefly opens the operating menu.</p> <p><i>In menu, submenu</i></p> <ul style="list-style-type: none"> ▪ Pressing the key briefly: <ul style="list-style-type: none"> ▪ Opens the selected menu, submenu or parameter. ▪ Starts the wizard. ▪ If help text is open, closes the help text of the parameter. ▪ Pressing the key for 2 s in a parameter: <ul style="list-style-type: none"> ▪ If present, opens the help text for the function of the parameter. <p><i>In wizards</i> Opens the editing view of the parameter and confirms the parameter value</p> <p><i>In the text and numeric editor</i></p> <ul style="list-style-type: none"> ▪ Pressing the key briefly confirms your selection. ▪ Pressing the key for 2 s confirms your entry.
	<p>Escape key combination (press keys simultaneously)</p> <p><i>In menu, submenu</i></p> <ul style="list-style-type: none"> ▪ Pressing the key briefly: <ul style="list-style-type: none"> ▪ Exits the current menu level and takes you to the next higher level. ▪ If help text is open, closes the help text of the parameter. ▪ Pressing the key for 2 s returns you to the operational display ("home position"). <p><i>In wizards</i> Exits the wizard and takes you to the next higher level</p> <p><i>In the text and numeric editor</i> Exits the Editing view without applying the changes.</p>
	<p>Minus/Enter key combination (press and hold down the keys simultaneously)</p> <ul style="list-style-type: none"> ▪ If keypad lock is active: <ul style="list-style-type: none"> ▪ Pressing the key for 3 s deactivates the keypad lock. ▪ If keypad lock is not active: <ul style="list-style-type: none"> ▪ Pressing the key for 3 s opens the context menu including the option for activating the keypad lock.



8.3.5 Opening the context menu

Using the context menu, the user can call up the following menus quickly and directly from the operational display:



- Setup
- Data backup
- Simulation

Calling up and closing the context menu

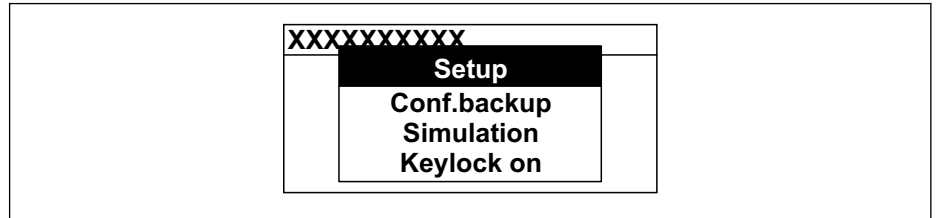

The user is in the operational display.

1. Press the  and  keys for longer than 3 seconds.
 - ↳ The context menu opens.



2. Press  +  simultaneously.
 - ↳ The context menu is closed and the operational display appears.

Calling up the menu via the context menu

1. Open the context menu.
2. Press  to navigate to the desired menu.
3. Press  to confirm the selection.
 - ↳ The selected menu opens.

8.3.6 Navigating and selecting from list

Different operating elements are used to navigate through the operating menu. The navigation path is displayed on the left in the header. Icons are displayed in front of the individual menus. These icons are also shown in the header during navigation.

i For an explanation of the navigation view with symbols and operating elements → 72

Example: Setting the number of displayed measured values to "2 values"

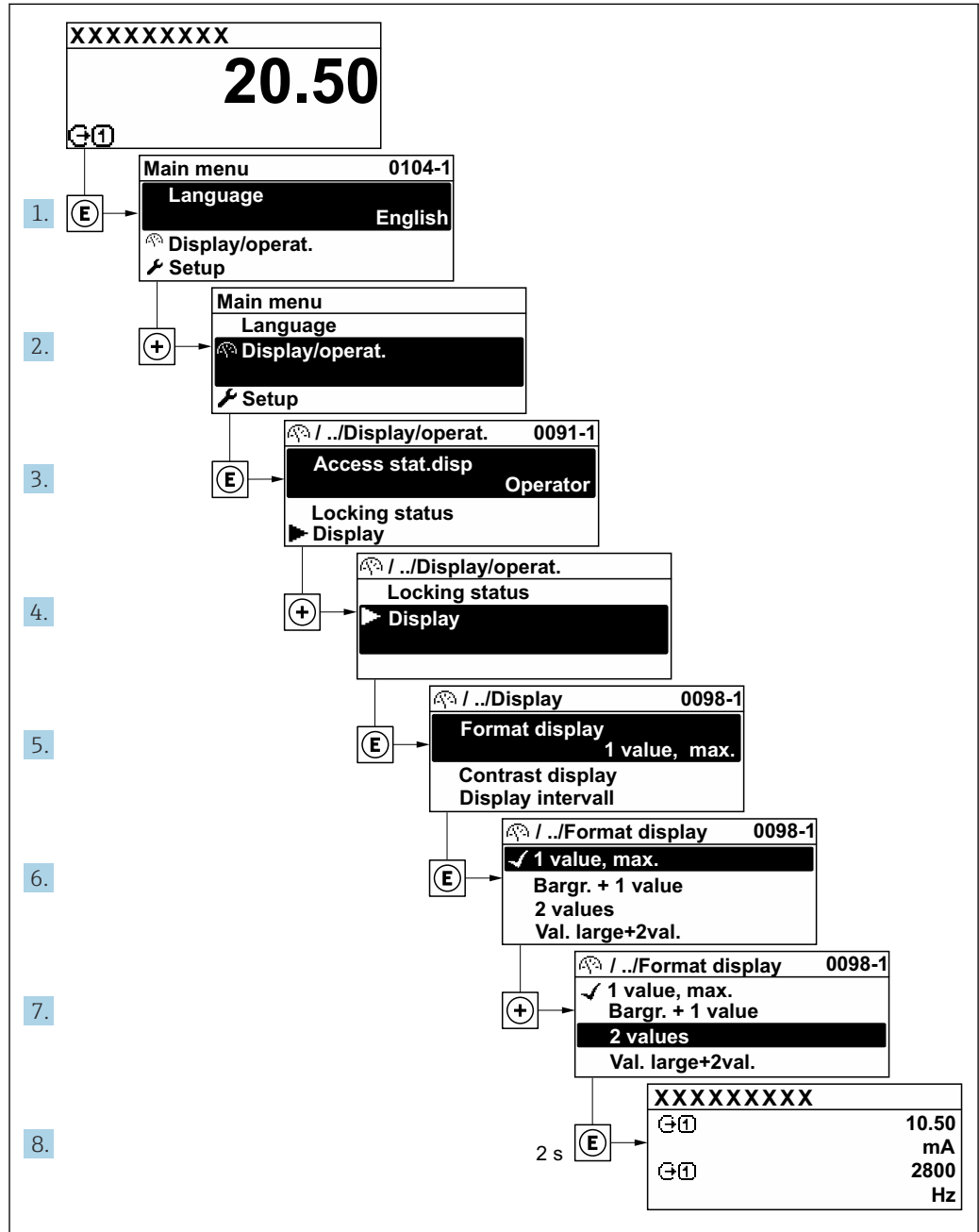

A0029562-EN

8.3.7 Calling the parameter directly

A parameter number is assigned to every parameter to be able to access a parameter directly via the onsite display. Entering this access code in the **Direct access** parameter calls up the desired parameter directly.

Navigation path

Expert → Direct access

The direct access code consists of a 5-digit number (at maximum) and the channel number, which identifies the channel of a process variable: e.g. 00914-2. In the navigation view, this appears on the right-hand side in the header of the selected parameter.

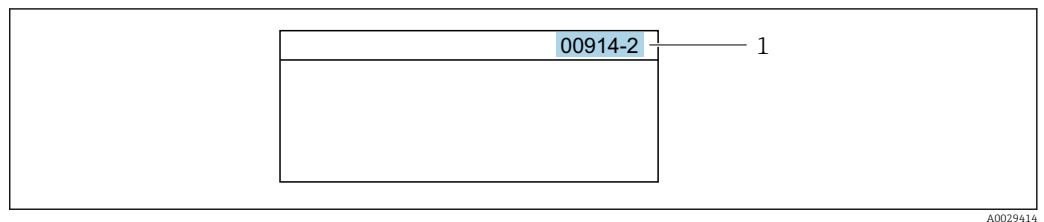

1 Direct access code

Note the following when entering the direct access code:

- The leading zeros in the direct access code do not have to be entered.
Example: Enter "914" instead of "00914"
- If no channel number is entered, channel 1 is opened automatically.
Example: Enter 00914 → **Assign process variable** parameter
- If a different channel is opened: Enter the direct access code with the corresponding channel number.
Example: Enter 00914-2 → **Assign process variable** parameter



For the direct access codes of the individual parameters, see the "Description of Device Parameters" document for the device

8.3.8 Calling up help text

Help text is available for some parameters and can be called up from the navigation view. The help text provides a brief explanation of the parameter function and thereby supports swift and safe commissioning.



Calling up and closing the help text

The user is in the navigation view and the selection bar is on a parameter.

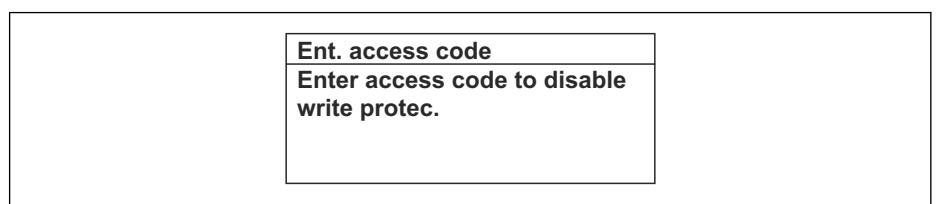
1. Press  for 2 s.
↳ The help text for the selected parameter opens.



 26 Example: Help text for parameter "Enter access code"

2. Press  +  simultaneously.
↳ The help text is closed.

8.3.9 Changing the parameters

Parameters can be changed via the numeric editor or text editor.

- Numeric editor: Change values in a parameter, e.g. specifications for limit values.
- Text editor: Enter text in a parameter, e.g. tag name.

A message is displayed if the value entered is outside the permitted value range.

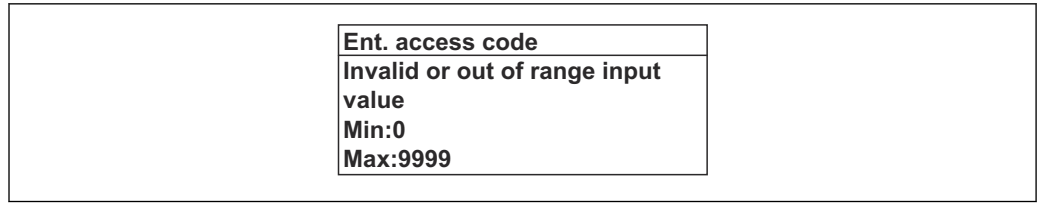

A0014049-EN

i For a description of the editing view - consisting of the text editor and numeric editor - with symbols → 74, for a description of the operating elements → 76

8.3.10 User roles and related access authorization

The two user roles "Operator" and "Maintenance" have different write access to the parameters if the customer defines a user-specific access code. This protects the device configuration via the local display from unauthorized access → 141.

Defining access authorization for user roles

An access code is not yet defined when the device is delivered from the factory. Access authorization (read and write access) to the device is not restricted and corresponds to the "Maintenance" user role.

- ▶ Define the access code.
 - ↳ The "Operator" user role is redefined in addition to the "Maintenance" user role. Access authorization differs for the two user roles.

Access authorization to parameters: "Maintenance" user role

Access code status	Read access	Write access
An access code has not yet been defined (factory setting).	✓	✓
After an access code has been defined.	✓	✓ ¹⁾

1) The user only has write access after entering the access code.

Access authorization to parameters: "Operator" user role

Access code status	Read access	Write access
After an access code has been defined.	✓	_ ¹⁾

1) Despite the defined access code, certain parameters can always be modified and thus are excluded from the write protection as they do not affect the measurement: write protection via access code → 141

i The user role with which the user is currently logged on is indicated by the **Access status** parameter. Navigation path: Operation → Access status

8.3.11 Disabling write protection via access code

If the -symbol appears on the local display in front of a parameter, the parameter is write-protected by a user-specific access code and its value cannot be changed at the moment using local operation → 141.

Parameter write protection via local operation can be disabled by entering the user-specific access code in the **Enter access code** parameter (→ 122) via the respective access option.

1. After you press , the input prompt for the access code appears.

2. Enter the access code.
 - ↳ The -symbol in front of the parameters disappears; all previously write-protected parameters are now re-enabled.

8.3.12 Enabling and disabling the keypad lock



The keypad lock makes it possible to block access to the entire operating menu via local operation. As a result, it is no longer possible to navigate through the operating menu or change the values of individual parameters. Users can only read the measured values on the operational display.

The keypad lock is switched on and off via the context menu.

Switching on the keypad lock



-  The keypad lock is switched on automatically:
- If the device has not been operated via the display for > 1 minute.
 - Each time the device is restarted.

To activate the keylock manually:

1. The device is in the measured value display.
Press the  and  keys for 3 seconds.
 - ↳ A context menu appears.
2. In the context menu select the **Keylock on** option.
 - ↳ The keypad lock is switched on.

-  If the user attempts to access the operating menu while the keypad lock is active, the **Keylock on** message appears.

Switching off the keypad lock

- ▶ The keypad lock is switched on.
Press the  and  keys for 3 seconds.
 - ↳ The keypad lock is switched off.

8.4 Access to operating menu via web browser

8.4.1 Function range

The integrated web server can be used to operate and configure the device via a web browser via Ethernet-APL, service interface (CDI) or via WLAN interface. The structure of the operating menu is the same as for the local display. In addition to the measured values, status information on the device is displayed and can be used to monitor device health. Furthermore the device data can be managed and the network parameters can be configured.

A device that has a WLAN interface (can be ordered as an option) is required for the WLAN connection: order code for "Display; Operation", option G "4-line, illuminated; touch control + WLAN". The device acts as an Access Point and enables communication by computer or a mobile handheld terminal.

-  For additional information on the web server, see the Special Documentation for the device.

8.4.2 Requirements

Computer hardware



Hardware	Interface	
	RJ45	WLAN
Interface	The computer must have a RJ45 interface. ¹⁾	The operating unit must have a WLAN interface.
Connection		Connection via wireless local area network.
Screen	Recommended size: ≥12" (depends on the screen resolution)	

- 1) Recommended cable: CAT5e, CAT6 or CAT7, with shielded plug (e.g. YAMAICHI product; part no. Y-ConProfixPlug63/Prod. ID: 82-006660)

Computer software



Software	Interface	
	RJ45	WLAN
Recommended operating systems	<ul style="list-style-type: none"> ▪ Microsoft Windows 8 or higher. ▪ Mobile operating systems: <ul style="list-style-type: none"> ▪ iOS ▪ Android <p> Microsoft Windows XP and Windows 7 is supported.</p>	
Web browsers supported	<ul style="list-style-type: none"> ▪ Microsoft Edge ▪ Mozilla Firefox ▪ Google Chrome ▪ Safari 	

Computer settings



Settings	Interface	
	RJ45	WLAN
User rights	Appropriate user rights (e.g. administrator rights) for TCP/IP and proxy server settings are necessary (e.g. for adjusting the IP address, subnet mask etc.).	
Proxy server settings of the web browser	The web browser's <i>Use a Proxy Server for Your LAN</i> setting must be deselected .	
JavaScript	<p>JavaScript must be enabled.</p> <p> If JavaScript cannot be enabled: Enter <code>http://192.168.1.212/servlet/basic.html</code> in the address bar of the web browser. A fully functional but simplified version of the operating menu structure starts in the web browser.</p> <p> When installing a new firmware version: To enable correct data display, clear the temporary memory (cache) under Internet options in the web browser.</p>	<p>JavaScript must be enabled.</p> <p> The WLAN display requires JavaScript support.</p>
Network connections	Use only the active network connections for the measuring instrument.	
	Switch off all other network connections such as WLAN for example.	Switch off all other network connections.

 In the event of connection problems: →  154

Measuring device: Via CDI-RJ45 service interface

Device	CDI-RJ45 service interface
Measuring device	The measuring device has an RJ45 interface.
Web server	Web server must be enabled; factory setting: ON  For information on enabling the Web server →  87

Measuring device: via WLAN interface

Device	WLAN interface
Measuring device	The measuring device has a WLAN antenna: <ul style="list-style-type: none"> ▪ Transmitter with integrated WLAN antenna ▪ Transmitter with external WLAN antenna
Web server	Web server and WLAN must be enabled; factory setting: ON  For information on enabling the Web server →  87

8.4.3 Connecting the device

Via service interface (CDI-RJ45)

Preparing the measuring device

Proline 500 – digital

1. Loosen the 4 fixing screws on the housing cover.
2. Open the housing cover.
3. The location of the connection socket depends on the measuring device and the communication protocol.
 Connect the computer to the RJ45 plug via the standard Ethernet cable .

Proline 500

1. Depending on the housing version:
 Loosen the securing clamp or fixing screw of the housing cover.
2. Depending on the housing version:
 Unscrew or open the housing cover.
3. Connect the computer to the RJ45 plug via the standard Ethernet connecting cable..

Configuring the Internet protocol of the computer

1. Switch on the measuring device.
2. Connect the computer to the RJ45 plug via the standard Ethernet cable →  90.
3. If a 2nd network card is not used, close all the applications on the notebook.
 - ↳ Applications requiring Internet or a network, such as e-mail, SAP applications, Internet or Windows Explorer.
4. Close any open Internet browsers.
5. Configure the properties of the Internet protocol (TCP/IP) as defined in the table:

IP address	192.168.1.XXX; for XXX all numerical sequences except: 0, 212 and 255 → e.g. 192.168.1.213
Subnet mask	255.255.255.0
Default gateway	192.168.1.212 or leave cells empty

Via WLAN interface

Configuring the Internet protocol of the mobile device

NOTICE

If the WLAN connection is lost during the configuration, settings made may be lost.

- ▶ Make sure that the WLAN connection is not disconnected while configuring the device.

NOTICE

Please note the following to avoid a network conflict:

- ▶ Avoid accessing the measuring instrument simultaneously from the same mobile device via the service interface (CDI-RJ45) and the WLAN interface.
- ▶ Only activate one service interface (CDI-RJ45 or WLAN interface).
- ▶ If simultaneous communication is necessary: configure different IP address ranges, e.g. 192.168.0.1 (WLAN interface) and 192.168.1.212 (CDI-RJ45 service interface).

Preparing the mobile terminal

- ▶ Enable WLAN on the mobile terminal.

Establishing a WLAN connection from the mobile terminal to the measuring device

1. In the WLAN settings of the mobile terminal:
Select the measuring device using the SSID (e.g. EH_Promag_500_A802000).
2. If necessary, select the WPA2 encryption method.
3. Enter the password:
Serial number of the measuring device ex-works (e.g. L100A802000).
 - ↳ The LED on the display module flashes. It is now possible to operate the measuring device with the web browser, FieldCare or DeviceCare.

 The serial number can be found on the nameplate.

 To ensure the safe and swift assignment of the WLAN network to the measuring point, it is advisable to change the SSID name. It should be possible to clearly assign the new SSID name to the measuring point (e.g. tag name) because it is displayed as the WLAN network.

Terminating the WLAN connection

- ▶ After configuring the device:
Terminate the WLAN connection between the mobile terminal and measuring device.

Starting the web browser

1. Start the web browser on the computer.

2. Enter the IP address of the web server in the address line of the web browser:
192.168.1.212
↳ The login page appears.

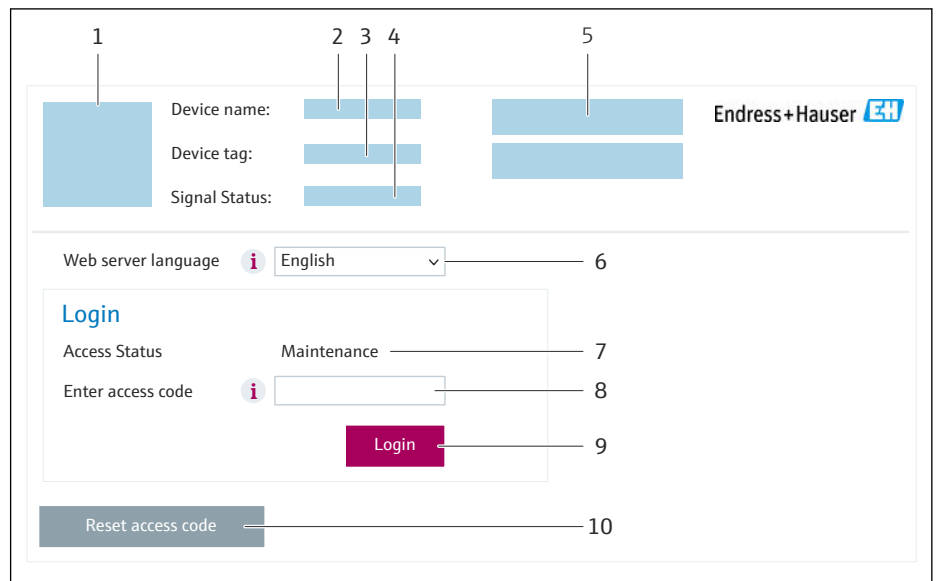

A0053670

- 1 Picture of device
- 2 Device name
- 3 Device tag
- 4 Status signal
- 5 Current measured values
- 6 Operating language
- 7 User role
- 8 Access code
- 9 Login
- 10 Reset access code (→ 136)

i If a login page does not appear, or if the page is incomplete → 154

8.4.4 Logging on

1. Select the preferred operating language for the Web browser.
2. Enter the user-specific access code.
3. Press **OK** to confirm your entry.

Access code	0000 (factory setting); can be changed by customer
--------------------	--

i If no action is performed for 10 minutes, the Web browser automatically returns to the login page.

8.4.5 User interface

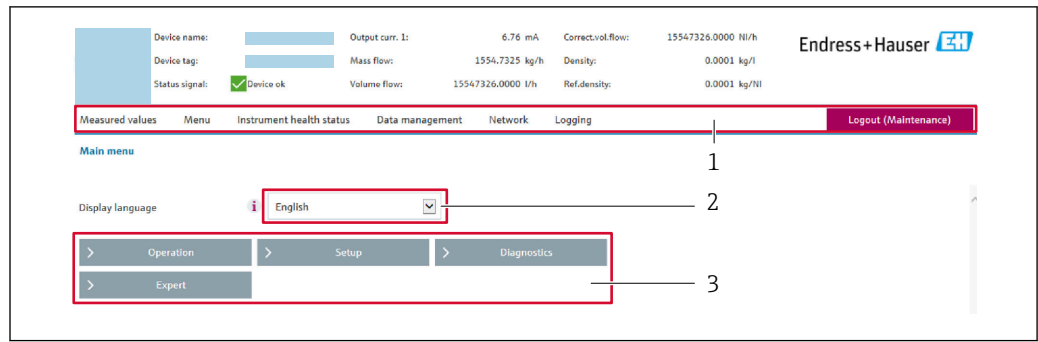

- 1 Function row
- 2 Local display language
- 3 Navigation area

Header

The following information appears in the header:

- Device name
- Device tag
- Device status with status signal → 161
- Current measured values

Function row

Functions	Meaning
Measured values	Displays the measured values of the measuring instrument
Menu	<ul style="list-style-type: none"> ■ Access to the operating menu from the measuring instrument ■ The structure of the operating menu is the same as for the local display  Detailed information on the "Description of Device Parameters" operating menu
Device status	Displays the diagnostic messages currently pending, listed in order of priority
Data management	Data exchange between computer and measuring instrument: <ul style="list-style-type: none"> ■ Device configuration: <ul style="list-style-type: none"> ■ Load settings from the device (XML format, save configuration) ■ Save settings to the device (XML format, restore configuration) ■ Logbook - Export Event logbook (.csv file) ■ Documents - Export documents: <ul style="list-style-type: none"> ■ Export backup data record (.csv file, create documentation of the measuring point configuration) ■ Verification report (PDF file, only available with the "Heartbeat Verification" application package) ■ Firmware update - Flashing a firmware version
Network	Configuration and checking of all the parameters required for establishing the connection to the measuring instrument: <ul style="list-style-type: none"> ■ Network settings (e.g. IP address, MAC address) ■ Device information (e.g. serial number, firmware version)
Logout	End the operation and call up the login page

Navigation area

The menus, the associated submenus and parameters can be selected in the navigation area.

Working area

Depending on the selected function and the related submenus, various actions can be performed in this area:

- Configuring parameters
- Reading measured values
- Calling up help text
- Starting an upload/download

8.4.6 Disabling the Web server

The Web server of the measuring device can be switched on and off as required using the **Web server functionality** parameter.

Navigation

"Expert" menu → Communication → Web server

Parameter overview with brief description

Parameter	Description	Selection	Factory setting
Web server functionality	Switch the Web server on and off.	<ul style="list-style-type: none"> ■ Off ■ HTML Off ■ On 	On

Function scope of the "Web server functionality" parameter

Option	Description
Off	<ul style="list-style-type: none"> ■ The Web server is completely disabled. ■ Port 80 is locked.
HTML Off	The HTML version of the Web server is not available.
On	<ul style="list-style-type: none"> ■ The complete Web server functionality is available. ■ JavaScript is used. ■ The password is transferred in an encrypted state. ■ Any change to the password is also transferred in an encrypted state.

Enabling the Web server

If the Web server is disabled it can only be re-enabled with the **Web server functionality** parameter via the following operating options:

- Via local display
- Via Bedientool "FieldCare"
- Via "DeviceCare" operating tool

8.4.7 Logging out

 Before logging out, perform a data backup via the **Data management** function (upload configuration from device) if necessary.

1. Select the **Logout** entry in the function row.
 - ↳ The home page with the Login box appears.
2. Close the Web browser.
3. If no longer needed:
 - Reset the modified properties of the Internet protocol (TCP/IP) →  83.

8.5 Operation via SmartBlue app

The device can be operated and configured with the SmartBlue App.

- The SmartBlue app must be downloaded onto a mobile device for this purpose
- For information on the compatibility of the SmartBlue app with mobile devices, see **Apple App Store (iOS devices)** or **Google Play Store (Android devices)**
- Incorrect operation by unauthorized persons is prevented by means of encrypted communication and password encryption.
- The Bluetooth® function can be deactivated after initial device setup.



A0033202

27 QR code for free Endress+Hauser SmartBlue App

Download and installation:

1. Scan the QR code or enter **SmartBlue** in the search field of the Apple App Store (iOS) or Google Play Store (Android).
2. Install and start the SmartBlue app.
3. For Android devices: enable location tracking (GPS) (not required for iOS devices).
4. Select a device that is ready to receive from the device list displayed.

Login:

1. Enter the user name: admin
2. Enter the initial password: serial number of the device
3. Change the password after logging in for the first time

i Information on password and reset code

For devices that meet the requirements of IEC 62443-4-1 "Secure product development lifecycle management" ("ProtectBlue"):

- If the user-defined password is lost: refer to the user management instructions and the reset button in the operating manual.
- Refer to the associated Security Manual (SD).

For all other devices (without "ProtectBlue"):

- If the user-defined password is lost, access can be restored via a reset code. The reset code is the serial number of the device in reverse. The original password is once again valid after the reset code has been entered.
- The reset code can also be changed in addition to the password.
- If the user-defined reset code is lost, the password can no longer be reset via the SmartBlue app. Contact Endress+Hauser Service in this case.

8.6 Access to the operating menu via the operating tool

The structure of the operating menu in the operating tools is the same as for operation via the local display.

8.6.1 Connecting the operating tool

Via Modbus TCP over Ethernet-APL 10 Mbit/s, SPE 10 Mbit/s

This communication interface is available on port 1 in device versions with a Modbus TCP over Ethernet-APL output.

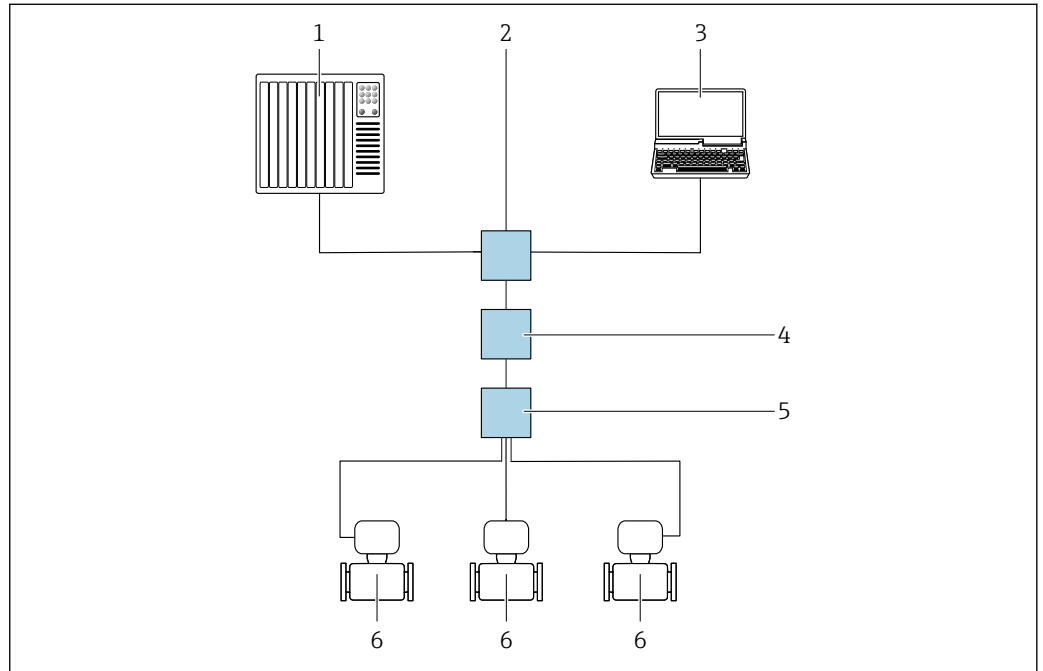

A0046117

28 Options for remote operation via Modbus TCP over Ethernet-APL protocol (active)

- 1 Automation system, e.g. Simatic S7 (Siemens)
- 2 Ethernet switch, e.g. Scalance X204 (Siemens)
- 3 Computer with web browser or operating tool
- 4 APL power switch/SPE power switch (optional)
- 5 APL field switch/SPE field switch
- 6 Measuring instrument/communication via port 1 (terminal 26 + 27)

Via Modbus TCP over Ethernet 100 Mbit/s

This communication interface is available on port 2 in device versions with a Modbus TCP over Ethernet-APL output.

Star topology

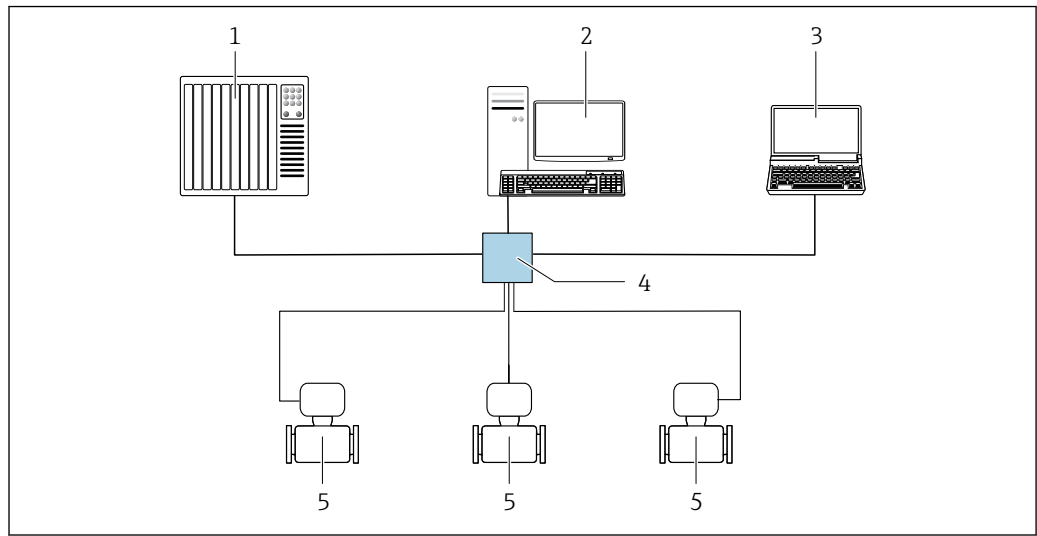

A0032078

29 Options for remote operation via Modbus TCP over Ethernet - 100 Mbit/s: Star topology

- 1 Automation system, z. B. RSLogix (Rockwell Automation)
- 2 Workstation for measuring instrument operation: with Custom Add-On Profile for "RSLogix 5000" (Rockwell Automation) or with Electronic Data Sheet (EDS)
- 3 Computer with web browser or operating tool
- 4 Standard Ethernet switch, e.g. Stratix (Rockwell Automation)
- 5 Measuring instrument/communication via port 2 (RJ45 connector)

Service interface

Via service interface (CDI-RJ45)

To configure the device on site, a point-to-point connection can be established. Alternatively, a connection via Modbus TCP can be used. The connection is made with the housing open, directly via the device's service interface (CDI-RJ45).

i An adapter for the RJ45 to the M12 connector is optionally available for the non-hazardous area:

Order code for "Accessories", option **NB**: "Adapter RJ45 M12 (service interface)"

The adapter connects the service interface (CDI-RJ45) to an M12 connector mounted in the cable entry. The connection to the service interface can be established via an M12 connector without opening the device.

Proline 500 – digital transmitter

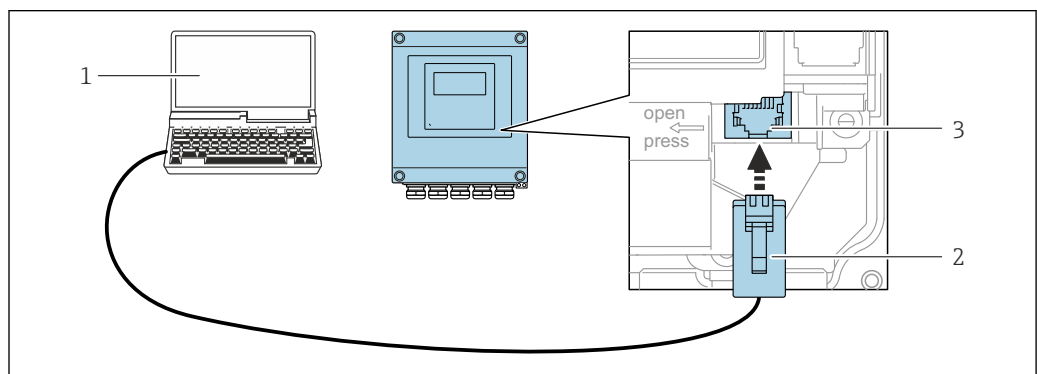

A0029163

30 Connection via service interface (CDI-RJ45)

- 1 Computer with web browser or operating tool
- 2 Standard Ethernet connecting cable with RJ45 connector
- 3 Service interface (CDI-RJ45) of the measuring instrument with access to the integrated web server

Proline 500 transmitter

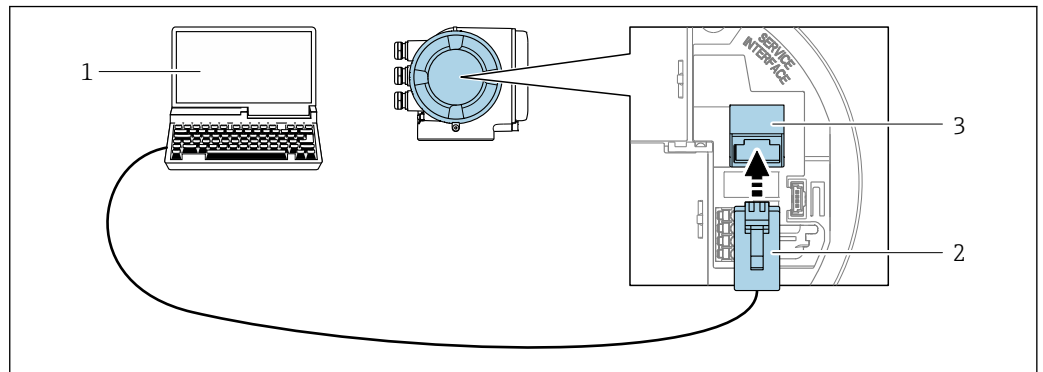

A0027563

31 Connection via service interface (CDI-RJ45)

- 1 Computer with web browser or operating tool
- 2 Standard Ethernet connecting cable with RJ45 connector
- 3 Service interface (CDI-RJ45) of the measuring instrument with access to the integrated web server

Via WLAN interface

The optional WLAN interface is available on the following device version:
 Order code for "Display; operation", option G "4-line, illuminated; touch control + WLAN"

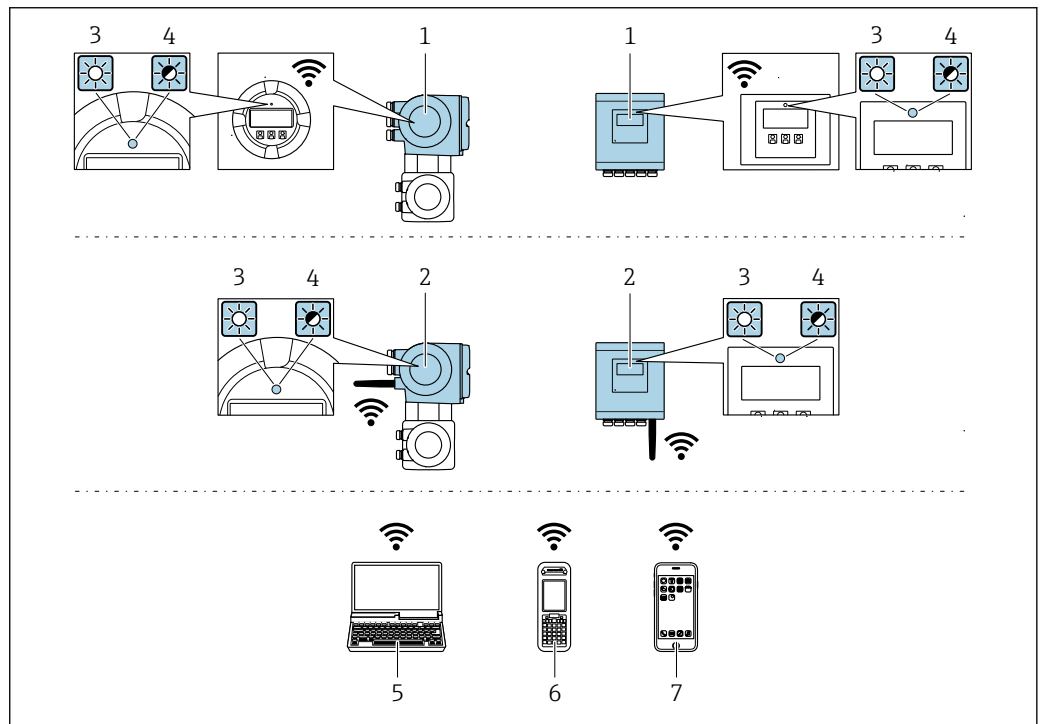

A0034569

- 1 Transmitter with integrated WLAN antenna
- 2 Transmitter with external WLAN antenna
- 3 LED lit constantly: WLAN reception is enabled on measuring instrument
- 4 LED flashing: WLAN connection established between operating unit and measuring instrument
- 5 Computer with WLAN interface and web browser for accessing integrated device web server or with operating tool e.g. FieldCare, DeviceCare)
- 6 Mobile handheld terminal with WLAN interface and web browser for accessing integrated device web server or operating tool (e.g. FieldCare, DeviceCare)
- 7 Smartphone or tablet (e.g. Field Xpert SMT70)

Encryption	WPA2-PSK AES-128 (in accordance with IEEE 802.11i)
Configurable WLAN channels	1 to 11

Degree of protection	IP66/67
Available antennas	<ul style="list-style-type: none"> ▪ Internal antenna ▪ External antenna (optional) In the event of poor transmission/reception conditions at the place of installation. <p> Only 1 antenna is active at any one time!</p>
Range	<ul style="list-style-type: none"> ▪ Internal antenna: typically 10 m (32 ft) ▪ External antenna: typically 50 m (164 ft)
Materials (external antenna)	<ul style="list-style-type: none"> ▪ Antenna: ASA plastic (acrylonitrile styrene acrylate) and nickel-plated brass ▪ Adapter: Stainless steel and nickel-plated brass ▪ Cable: Polyethylene ▪ Plug: Nickel-plated brass ▪ Angle bracket: Stainless steel

Configuring the Internet protocol of the mobile device

NOTICE

If the WLAN connection is lost during the configuration, settings made may be lost.

- ▶ Make sure that the WLAN connection is not disconnected while configuring the device.

NOTICE

Please note the following to avoid a network conflict:

- ▶ Avoid accessing the measuring instrument simultaneously from the same mobile device via the service interface (CDI-RJ45) and the WLAN interface.
- ▶ Only activate one service interface (CDI-RJ45 or WLAN interface).
- ▶ If simultaneous communication is necessary: configure different IP address ranges, e.g. 192.168.0.1 (WLAN interface) and 192.168.1.212 (CDI-RJ45 service interface).

Preparing the mobile terminal

- ▶ Enable WLAN on the mobile terminal.

Establishing a WLAN connection from the mobile terminal to the measuring device

1. In the WLAN settings of the mobile terminal:
Select the measuring device using the SSID (e.g. EH_Promag_500_A802000).
2. If necessary, select the WPA2 encryption method.
3. Enter the password:
Serial number of the measuring device ex-works (e.g. L100A802000).
↳ The LED on the display module flashes. It is now possible to operate the measuring device with the web browser, FieldCare or DeviceCare.

 The serial number can be found on the nameplate.

 To ensure the safe and swift assignment of the WLAN network to the measuring point, it is advisable to change the SSID name. It should be possible to clearly assign the new SSID name to the measuring point (e.g. tag name) because it is displayed as the WLAN network.

Terminating the WLAN connection



- ▶ After configuring the device:
Terminate the WLAN connection between the mobile terminal and measuring device.

8.6.2 FieldCare

Function range

FDT-based (Field Device Technology) plant asset management tool from Endress+Hauser. It can configure all smart field units in a system and helps you manage them. By using the status information, it is also a simple but effective way of checking their status and condition.

Access is via:

- CDI-RJ45 service interface →  90
- WLAN interface →  91

Typical functions:

- Transmitter parameter configuration
- Loading and saving of device data (upload/download)
- Documentation of the measuring point
- Visualization of the measured value memory (line recorder) and event logbook



- Operating Instructions BA00027S
- Operating Instructions BA00059S



Source for device description files →  94

8.6.3 DeviceCare

Function range

Tool for connecting and configuring Endress+Hauser field devices.

The fastest way to configure Endress+Hauser field devices is with the dedicated "DeviceCare" tool. Together with the device type managers (DTMs) it presents a convenient, comprehensive solution.



Innovation brochure IN01047S





Source for device description files →  94

9 System integration

9.1 Overview of device description files

9.1.1 Current version data for the device

Firmware version	01.00.zz	<ul style="list-style-type: none"> ▪ On the title page of the manual ▪ On the transmitter nameplate ▪ Firmware version Diagnostics → Device information → Firmware version
------------------	----------	---

 For an overview of the various firmware versions for the device
→  173

9.1.2 Operating tools

The suitable device description file for the individual operating tools is listed in the table below, along with information on where the file can be acquired.

FieldCare	<ul style="list-style-type: none"> ▪ www.endress.com → Downloads area ▪ USB stick (contact Endress+Hauser) ▪ E-mail → Downloads area
DeviceCare	<ul style="list-style-type: none"> ▪ www.endress.com → Downloads area ▪ E-mail → Downloads area

9.2 Modbus TCP system integration

 For detailed information on system integration, see the Special Documentation for the Modbus TCP system integration with the device:

10 Commissioning

10.1 Post-installation and post-connection check

Before commissioning the device:

- ▶ Make sure that the post-installation and post-connection checks have been performed successfully.
- Checklist for "Post-installation" check → 37
- Checklist for "Post-connection" check → 66

10.2 Switching on the measuring instrument

- ▶ Switch on the device upon successful completion of the post-mounting and post-connection check.
 - ↳ After a successful startup, the local display switches automatically from the startup display to the operational display.

If nothing appears on the local display or if a diagnostic message is displayed, refer to the section on "Diagnostics and troubleshooting" → 153.

10.3 Connecting via FieldCare

- For connecting FieldCare → 90
- For connecting via FieldCare
- For user interface of FieldCare

10.4 Setting the operating language

Factory setting: English or ordered local language

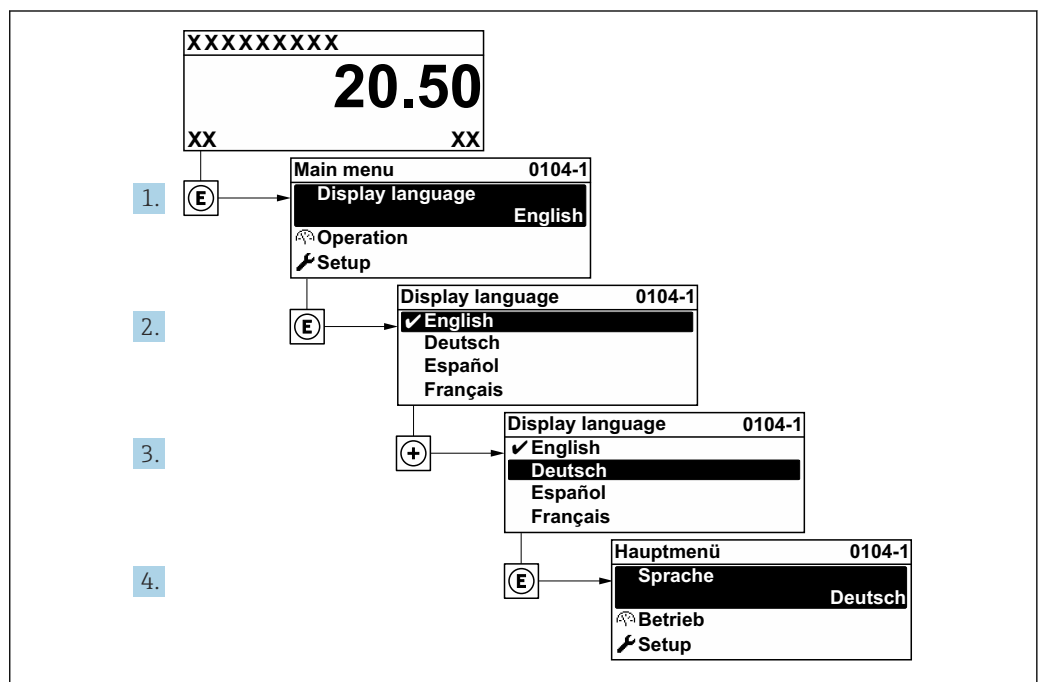

32 Taking the example of the local display

A0029420

10.5 Configuring the device

The **Setup** menu with its guided wizards contains all the parameters needed for standard operation.

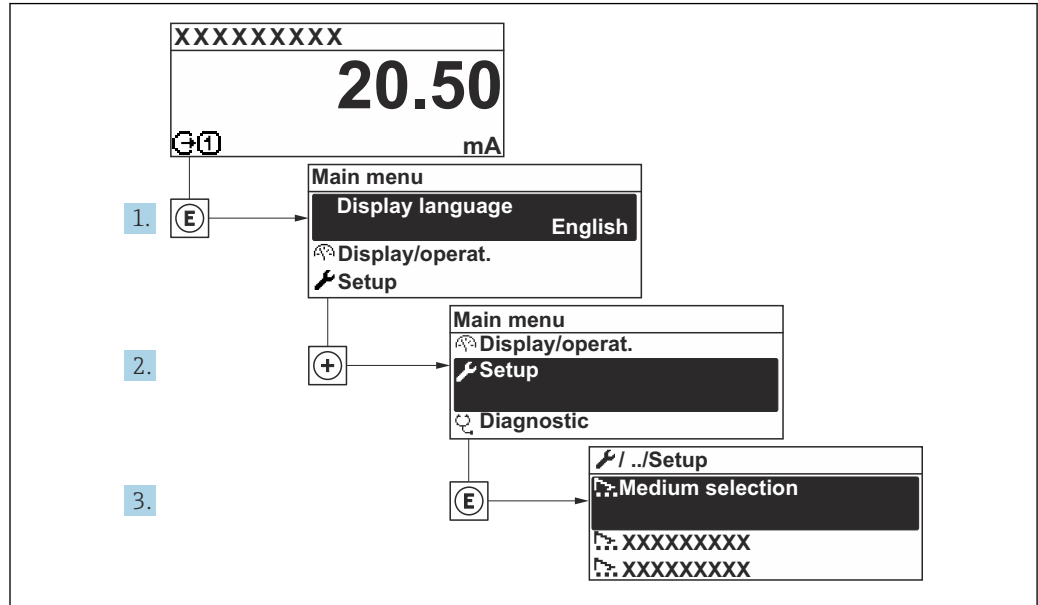

33 Navigation to the "Setup" menu using the example of the local display

i The number of submenus and parameters can vary depending on the device version. Certain submenus and parameters in these submenus are not described in the Operating Instructions. Instead a description is provided in the Special Documentation for the device ("Supplementary documentation").

Navigation

"Setup" menu → Device tag

🔧 Setup	
Device tag	→ 97
▶ Communication	→ 97
▶ System units	→ 100
▶ I/O configuration	→ 102
▶ Current input 1 to n	→ 103
▶ Status input 1 to n	→ 104
▶ Current output 1 to n	→ 105
▶ Pulse/frequency/switch output 1 to n	→ 108

▶ Relay output 1 to n	→ 112
▶ Double pulse output	→ 114
▶ Display	→ 115
▶ Low flow cutoff	→ 118
▶ Empty pipe detection	→ 119
▶ Configure flow damping	→ 120
▶ Advanced setup	→ 122

Parameter overview with brief description

Parameter	Description	User entry	Factory setting
Device tag	Enter the name for the measuring point.	Character string comprising numbers, letters and special characters (32)	Promag

10.5.1 Displaying the communication interface

The **Communication** submenu shows all the current parameter settings for selecting and configuring the communication interface.

Navigation

"Setup" menu → Communication

▶ Communication	
Byte order	→ 98
Failure mode	→ 98
Fieldbus write access	→ 98
▶ APL port	→ 98
▶ Service interface	→ 99
▶ Network diagnostics	→ 100

Parameter overview with brief description

Parameter	Description	Selection	Factory setting
Byte order	Select byte transmission sequence.	<ul style="list-style-type: none"> ■ 0-1-2-3 ■ 3-2-1-0 ■ 1-0-3-2 ■ 2-3-0-1 	1-0-3-2
Failure mode	Select measured value output behavior when a diagnostic message occurs via Modbus communication.	<ul style="list-style-type: none"> ■ NaN value ■ Last valid value 	NaN value
Fieldbus write access	Select access method to the measuring device via fieldbus.	<ul style="list-style-type: none"> ■ Read + write ■ Read only 	Read + write

"APL port" submenu**Navigation**

"Setup" menu → Communication → APL port

▶ APL port

IP address →  98

Subnet mask →  98

Default gateway →  98

MAC address →  98

DHCP client →  98

Parameter overview with brief description

Parameter	Description	User entry / User interface / Selection	Factory setting
IP address	Enter the IP address of the device.	Character string comprising numbers, letters and special characters (15)	192.168.2.212
Subnet mask	Enter subnet mask of the device.	Character string comprising numbers, letters and special characters (15)	255.255.255.0
Default gateway	Enter IP address for the default gateway of the device.	Character string comprising numbers, letters and special characters (15)	0.0.0.0
MAC address	Shows the MAC address of the measuring device.	Character string comprising numbers, letters and special characters	
DHCP client	Switch the DHCP client functionality on and off.	<ul style="list-style-type: none"> ■ Off ■ On 	On

"Service interface" submenu

Navigation

"Setup" menu → Communication → Service interface

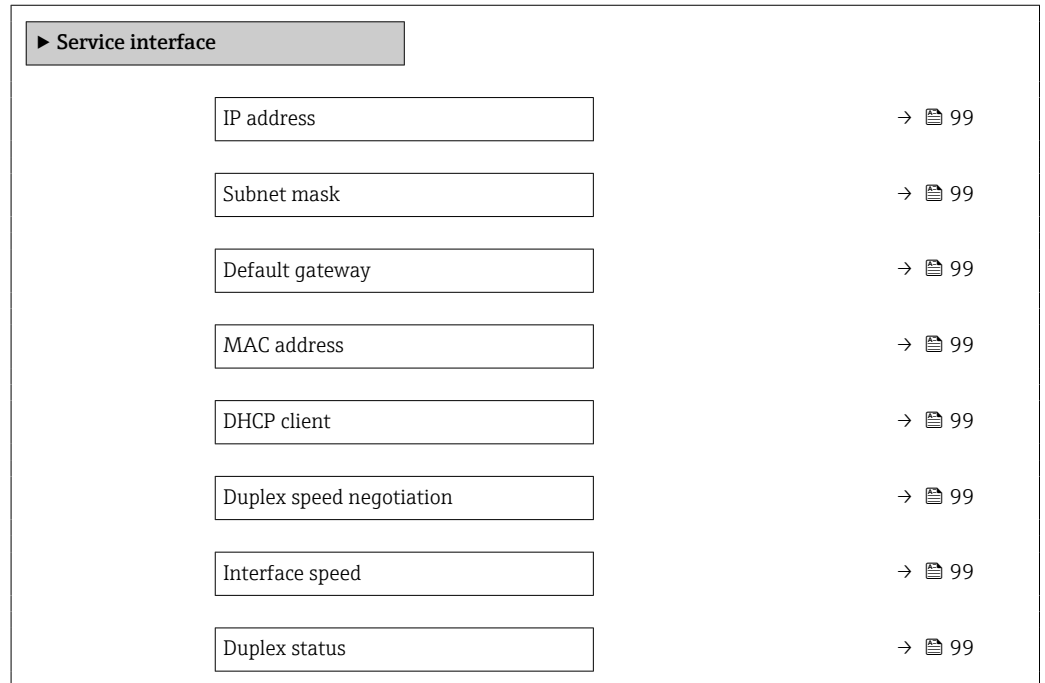

Parameter overview with brief description

Parameter	Description	User entry / User interface / Selection	Factory setting
IP address	Enter the IP address of the service interface (port 2).	4 octet: 0 to 255 (in the particular octet)	192.168.1.212
Subnet mask	Enter the subnet mask of the service interface (port 2).	4 octet: 0 to 255 (in the particular octet)	255.255.255.0
Default gateway	Enter the standard gateway of the service interface (port 2).	4 octet: 0 to 255 (in the particular octet)	0.0.0.0
MAC address	Shows the MAC address of the service interface (port 2).	Unique 12-digit character string comprising letters and numbers, e.g.: 00:07:05:10:01:5F	Each measuring instrument is given an individual address.
DHCP client	Switch the DHCP client functionality on and off.	<ul style="list-style-type: none"> ■ Off ■ On 	Off
Duplex speed negotiation	Select the duplex mode and transmission speed for the connected devices.	<ul style="list-style-type: none"> ■ Auto ■ 10 Mbit/s full duplex ■ 10 Mbit/s half duplex ■ 100 Mbit/s full duplex ■ 100 Mbit/s half duplex 	Auto
Interface speed		Positive integer	100 Mbit/s
Duplex status		<ul style="list-style-type: none"> ■ Full duplex ■ Half duplex ■ Unknown 	Unknown

"Network diagnostics" submenu

Navigation

"Setup" menu → Communication → Network diagnostics

▶ Network diagnostics

Signal to noise ratio	→ 100
Number of failed received packets	→ 100
Maximum number of TCP connections	→ 100
TCP connection request rejection	→ 100
Inactivity timeout	→ 100

Parameter overview with brief description

Parameter	Description	User interface / User entry / Selection	Factory setting
Signal to noise ratio	Shows the signal to noise ratio of the Ethernet-APL connection. A value >21dB is good and >23dB is excellent.	Signed floating-point number	0 dB
Number of failed received packets	Shows the number of failed received packets (PHY).	0 to 65 535	0
Maximum number of TCP connections	Select the maximum number of concurrent TCP connections allowed.	1 to 4	4
TCP connection request rejection	Indicate how incoming TCP connection requests should be handled when the maximum number of connections has been established.	<ul style="list-style-type: none"> ▪ Close inactive ▪ Close oldest ▪ Reject 	Close inactive
Inactivity timeout	Enter the amount of time until an inactive connection is closed automatically	0 to 99 s	60 s

10.5.2 Setting the system units

In the **System units** submenu the units of all the measured values can be set.







The number of submenus and parameters can vary depending on the device version. Certain submenus and parameters in these submenus are not described in the Operating Instructions. Instead a description is provided in the Special Documentation for the device ("Supplementary documentation").

Navigation

"Setup" menu → System units

▶ System units

Volume flow unit	→ 101
Volume unit	→ 101

Conductivity unit	→  101
Temperature unit	→  101
Mass flow unit	→  101
Mass unit	→  101
Density unit	→  101
Corrected volume flow unit	→  102
Corrected volume unit	→  102

Parameter overview with brief description

Parameter	Prerequisite	Description	Selection	Factory setting
Volume flow unit	–	Select volume flow unit. <i>Effect</i> The selected unit applies to: <ul style="list-style-type: none"> ▪ Output ▪ Low flow cut off ▪ Simulation process variable 	Unit choose list	Country-specific: <ul style="list-style-type: none"> ▪ l/h ▪ gal/min (us)
Volume unit	–	Select volume unit.	Unit choose list	Country-specific: <ul style="list-style-type: none"> ▪ m³ ▪ gal (us)
Conductivity unit	The On option is selected in the Conductivity measurement parameter.	Select conductivity unit. <i>Effect</i> The selected unit applies to: Simulation process variable	Unit choose list	µS/cm
Temperature unit	–	Select temperature unit. <i>Effect</i> The selected unit applies to: <ul style="list-style-type: none"> ▪ Temperature parameter ▪ Maximum value parameter ▪ Minimum value parameter ▪ External temperature parameter ▪ Maximum value parameter ▪ Minimum value parameter 	Unit choose list	Country-specific: <ul style="list-style-type: none"> ▪ °C ▪ °F
Mass flow unit	–	Select mass flow unit. <i>Effect</i> The selected unit applies to: <ul style="list-style-type: none"> ▪ Output ▪ Low flow cut off ▪ Simulation process variable 	Unit choose list	Country-specific: <ul style="list-style-type: none"> ▪ kg/h ▪ lb/min
Mass unit	–	Select mass unit.	Unit choose list	Country-specific: <ul style="list-style-type: none"> ▪ kg ▪ lb
Density unit	–	Select density unit. <i>Effect</i> The selected unit applies to: <ul style="list-style-type: none"> ▪ Output ▪ Simulation process variable 	Unit choose list	Country-specific: <ul style="list-style-type: none"> ▪ kg/l ▪ lb/ft³

Parameter	Prerequisite	Description	Selection	Factory setting
Corrected volume flow unit	–	Select corrected volume flow unit. <i>Effect</i> The selected unit applies to: Corrected volume flow parameter (→ ⓘ 146)	Unit choose list	Country-specific: ▪ NI/h ▪ Sft ³ /h
Corrected volume unit	–	Select corrected volume unit.	Unit choose list	Country-specific: ▪ Nm ³ ▪ Sft ³

10.5.3 Displaying the I/O configuration

The **I/O configuration** submenu guides the user systematically through all the parameters in which the configuration of the I/O modules is displayed.

Navigation

"Setup" menu → I/O configuration

► I/O configuration	
I/O module 1 to n terminal numbers	→ ⓘ 102
I/O module 1 to n information	→ ⓘ 102
I/O module 1 to n type	→ ⓘ 102
Apply I/O configuration	→ ⓘ 103
I/O alteration code	→ ⓘ 103

Parameter overview with brief description

Parameter	Description	User interface / Selection / User entry	Factory setting
I/O module 1 to n terminal numbers	Shows the terminal numbers used by the I/O module.	<ul style="list-style-type: none"> ▪ Not used ▪ 26-27 (I/O 1) ▪ 24-25 (I/O 2) ▪ 22-23 (I/O 3) ▪ 20-21 (I/O 4) 	–
I/O module 1 to n information	Shows information of the plugged I/O module.	<ul style="list-style-type: none"> ▪ Not plugged ▪ Invalid ▪ Not configurable ▪ Configurable ▪ MODBUS 	–
I/O module 1 to n type	Shows the I/O module type.	<ul style="list-style-type: none"> ▪ Off ▪ Current output * ▪ Current input * ▪ Status input * ▪ Pulse/frequency/switch output * ▪ Double pulse output * ▪ Relay output * 	Off

Parameter	Description	User interface / Selection / User entry	Factory setting
Apply I/O configuration	Apply parameterization of the freely configurable I/O module.	<ul style="list-style-type: none"> ■ No ■ Yes 	No
I/O alteration code	Enter the code in order to change the I/O configuration.	Positive integer	0

* Visibility depends on order options or device settings

10.5.4 Configuring the current input

The "Current input" wizard guides the user systematically through all the parameters that have to be set for configuring the current input.

Navigation

"Setup" menu → Current input 1 to n

▶ Current input 1 to n

Current span	→ ⓘ 104
Terminal number	→ ⓘ 104
Signal mode	→ ⓘ 104
Terminal number	→ ⓘ 104
0/4 mA value	→ ⓘ 104
20 mA value	→ ⓘ 104
Failure mode	→ ⓘ 104
Terminal number	→ ⓘ 104
Failure value	→ ⓘ 104
Terminal number	→ ⓘ 104

Parameter overview with brief description

Parameter	Prerequisite	Description	Selection / User interface / User entry	Factory setting
Current span	–	Select current range for process value output and upper/lower level for alarm signal.	<ul style="list-style-type: none"> ▪ 4 ... 20 mA (4 ... 20.5 mA) ▪ 4 ... 20 mA NE (3.8 ... 20.5 mA) ▪ 4 ... 20 mA US (3.9 ... 20.8 mA) ▪ 0...20 mA (0...20.5 mA) 	4 ... 20 mA NE (3.8 ... 20.5 mA)
Terminal number	–	Shows the terminal numbers used by the current input module.	<ul style="list-style-type: none"> ▪ Not used ▪ 24-25 (I/O 2) ▪ 22-23 (I/O 3) ▪ 20-21 (I/O 4) * 	–
Signal mode	The measuring device is not approved for use in the hazardous area with type of protection Ex-i.	Select the signal mode for the current input.	<ul style="list-style-type: none"> ▪ Passive ▪ Active * 	Active
0/4 mA value	–	Enter 4 mA value.	Signed floating-point number	0
20 mA value	–	Enter 20 mA value.	Signed floating-point number	Depends on country and nominal diameter
Failure mode	–	Define input behavior in alarm condition.	<ul style="list-style-type: none"> ▪ Alarm ▪ Last valid value ▪ Defined value 	Alarm
Failure value	In the Failure mode parameter, the Defined value option is selected.	Enter value to be used by the device if input value from external device is missing.	Signed floating-point number	0

* Visibility depends on order options or device settings

10.5.5 Configuring the status input

The **Status input** submenu guides the user systematically through all the parameters that have to be set for configuring the status input.

Navigation

"Setup" menu → Status input 1 to n

► Status input 1 to n	
Assign status input	→ 105
Terminal number	→ 105
Active level	→ 105
Terminal number	→ 105
Response time status input	→ 105
Terminal number	→ 105

Parameter overview with brief description

Parameter	Description	Selection / User interface / User entry	Factory setting
Assign status input	Select function for the status input.	<ul style="list-style-type: none"> ■ Off ■ Reset totalizer 1 ■ Reset totalizer 2 ■ Reset totalizer 3 ■ Reset all totalizers ■ Flow override 	Off
Terminal number	Shows the terminal numbers used by the status input module.	<ul style="list-style-type: none"> ■ Not used ■ 24-25 (I/O 2) ■ 22-23 (I/O 3) ■ 20-21 (I/O 4)* 	-
Active level	Define input signal level at which the assigned function is triggered.	<ul style="list-style-type: none"> ■ High ■ Low 	High
Response time status input	Define the minimum amount of time the input signal level must be present before the selected function is triggered.	5 to 200 ms	50 ms

* Visibility depends on order options or device settings

10.5.6 Configuring the current output





The **Current output** wizard guides you systematically through all the parameters that have to be set for configuring the current output.

Navigation

"Setup" menu → Current output







▶ **Current output 1 to n**

Process variable current output	→ ⓘ 106
Terminal number	→ ⓘ 106
Current range output	→ ⓘ 106
Terminal number	→ ⓘ 106
Signal mode	→ ⓘ 106
Terminal number	→ ⓘ 106
Lower range value output	→ ⓘ 106
Upper range value output	→ ⓘ 107
Fixed current	→ ⓘ 107
Terminal number	→ ⓘ 106
Damping current output	→ ⓘ 107

Failure behavior current output	→  107
Terminal number	→  106
Failure current	→  107
Terminal number	→  106

Parameter overview with brief description

Parameter	Prerequisite	Description	Selection / User interface / User entry	Factory setting
Process variable current output	–	Select the process variable for the current output.	<ul style="list-style-type: none"> ▪ Off ▪ Volume flow ▪ Mass flow ▪ Corrected volume flow ▪ Flow velocity ▪ Conductivity ▪ Corrected conductivity * ▪ Temperature * ▪ Electronics temperature ▪ Noise * ▪ Coil current shot time * ▪ Reference electrode potential against PE * ▪ HBSI * ▪ Buildup index * ▪ Test point 1 ▪ Test point 2 ▪ Test point 3 	Volume flow
Terminal number	–	Shows the terminal numbers used by the current output module.	<ul style="list-style-type: none"> ▪ Not used ▪ 26-27 (I/O 1) ▪ 24-25 (I/O 2) ▪ 22-23 (I/O 3) ▪ 20-21 (I/O 4) * 	–
Current range output	–	Select current range for process value output and upper/lower level for alarm signal.	<ul style="list-style-type: none"> ▪ 4 ... 20 mA NE (3.8 ... 20.5 mA) ▪ 4 ... 20 mA US (3.9 ... 20.8 mA) ▪ 4 ... 20 mA (4 ... 20.5 mA) ▪ 0...20 mA (0...20.5 mA) ▪ Fixed value 	Depends on country: <ul style="list-style-type: none"> ▪ 4 ... 20 mA NE (3.8 ... 20.5 mA) ▪ 4 ... 20 mA US (3.9 ... 20.8 mA)
Signal mode	–	Select the signal mode for the current output.	<ul style="list-style-type: none"> ▪ Active * ▪ Passive * 	Active
Lower range value output	In Current span parameter (→  106), one of the following options is selected: <ul style="list-style-type: none"> ▪ 4 ... 20 mA NE (3.8 ... 20.5 mA) ▪ 4 ... 20 mA US (3.9 ... 20.8 mA) ▪ 4 ... 20 mA (4 ... 20.5 mA) ▪ 0...20 mA (0...20.5 mA) 	Enter lower range value for the measured value range.	Signed floating-point number	Depends on country: <ul style="list-style-type: none"> ▪ 0 l/h ▪ 0 gal/min (us)

Parameter	Prerequisite	Description	Selection / User interface / User entry	Factory setting
Upper range value output	In Current span parameter (→  106), one of the following options is selected: <ul style="list-style-type: none"> ▪ 4 ... 20 mA NE (3.8 ... 20.5 mA) ▪ 4 ... 20 mA US (3.9 ... 20.8 mA) ▪ 4 ... 20 mA (4 ... 20.5 mA) ▪ 0...20 mA (0...20.5 mA) 	Enter upper range value for the measured value range.	Signed floating-point number	Depends on country and nominal diameter
Fixed current	The Fixed current option is selected in the Current span parameter (→  106).	Defines the fixed output current.	0 to 22.5 mA	22.5 mA
Damping current output	A process variable is selected in the Assign current output parameter (→  106) and one of the following options is selected in the Current span parameter (→  106): <ul style="list-style-type: none"> ▪ 4 ... 20 mA NE (3.8 ... 20.5 mA) ▪ 4 ... 20 mA US (3.9 ... 20.8 mA) ▪ 4 ... 20 mA (4 ... 20.5 mA) ▪ 0...20 mA (0...20.5 mA) 	Enter a time constant for output damping (PT1 element). Damping reduces the effect of fluctuations in the measured value on the output signal.	0.0 to 999.9 s	1.0 s
Failure behavior current output	A process variable is selected in the Assign current output parameter (→  106) and one of the following options is selected in the Current span parameter (→  106): <ul style="list-style-type: none"> ▪ 4 ... 20 mA NE (3.8 ... 20.5 mA) ▪ 4 ... 20 mA US (3.9 ... 20.8 mA) ▪ 4 ... 20 mA (4 ... 20.5 mA) ▪ 0...20 mA (0...20.5 mA) 	Select output behavior in the event of a device alarm.	<ul style="list-style-type: none"> ▪ Min. ▪ Max. ▪ Last valid value ▪ Actual value ▪ Fixed value 	Max.
Failure current	The Defined value option is selected in the Failure mode parameter.	Enter current output value in alarm condition.	0 to 22.5 mA	22.5 mA

* Visibility depends on order options or device settings







10.5.7 "Pulse/frequency/switch output 1 to n" wizard

The **Pulse/frequency/switch output** wizard guides you systematically through all the parameters that can be set for configuring the selected output type.

Navigation

"Setup" menu → Pulse/frequency/switch output 1 to n

► Pulse/frequency/switch output 1 to n	
Operating mode	→ 109
Terminal number	→ 109
Signal mode	→ 109
Assign pulse output	→ 109
Assign frequency output	→ 109
Switch output function	→ 110
Assign diagnostic behavior	→ 110
Assign limit	→ 110
Assign flow direction check	→ 110
Assign status	→ 110
Pulse scaling	→ 110
Pulse width	→ 110
Failure mode	→ 110
Minimum frequency value	→ 111
Maximum frequency value	→ 111
Measuring value at minimum frequency	→ 111
Measuring value at maximum frequency	→ 111
Output damping	→ 111
Failure mode	→ 111

Failure frequency	→  111
Switch-on value	→  111
Switch-off value	→  112
Switch-on delay	→  112
Switch-off delay	→  112
Failure mode	→  112
Invert output signal	→  112

Parameter overview with brief description

Parameter	Prerequisite	Description	Selection / User interface / User entry	Factory setting
Operating mode	–	Define the output as a pulse, frequency or switch output.	<ul style="list-style-type: none"> ■ Pulse ■ Frequency ■ Switch 	Pulse
Terminal number	–	Shows the terminal numbers used by the PFS output module.	<ul style="list-style-type: none"> ■ Not used ■ 24-25 (I/O 2) ■ 22-23 (I/O 3) ■ 20-21 (I/O 4) * 	–
Signal mode	–	Select the signal mode for the PFS output.	<ul style="list-style-type: none"> ■ Passive ■ Active * ■ Passive NE 	Passive
Assign pulse output	The Pulse option is selected in Operating mode parameter.	Select process variable for pulse output.	<ul style="list-style-type: none"> ■ Off ■ Volume flow ■ Mass flow ■ Corrected volume flow 	Off
Assign frequency output	The Frequency option is selected in Operating mode parameter (→  109).	Select process variable for frequency output.	<ul style="list-style-type: none"> ■ Off ■ Volume flow ■ Mass flow ■ Corrected volume flow ■ Flow velocity * ■ Conductivity * ■ Corrected conductivity * ■ Temperature * ■ Electronics temperature * ■ Noise * ■ Coil current shot time * ■ Reference electrode potential against PE * ■ Buildup index * ■ Test point 1 ■ Test point 2 ■ Test point 3 ■ HBSI * 	Off

Parameter	Prerequisite	Description	Selection / User interface / User entry	Factory setting
Switch output function	The Switch option is selected in the Operating mode parameter.	Select function for switch output.	<ul style="list-style-type: none"> ▪ Off ▪ On ▪ Diagnostic behavior ▪ Limit ▪ Flow direction check ▪ Status 	Off
Assign diagnostic behavior	–	The output is switched on (closed, conductive), if there is a pending diagnostic event of the assigned behavioral category.	<ul style="list-style-type: none"> ▪ Alarm ▪ Alarm or warning ▪ Warning 	Alarm
Assign limit	<ul style="list-style-type: none"> ▪ The Switch option is selected in Operating mode parameter. ▪ The Limit option is selected in Switch output function parameter. 	Select the variable to monitor in case the specified limit value is exceeded. If a limit value is exceeded, the output is switched on (conductive).	<ul style="list-style-type: none"> ▪ Off ▪ Volume flow ▪ Mass flow ▪ Corrected volume flow ▪ Flow velocity * ▪ Conductivity * ▪ Corrected conductivity * ▪ Totalizer 1 ▪ Totalizer 2 ▪ Totalizer 3 ▪ Temperature * ▪ Electronics temperature 	Volume flow
Assign flow direction check	<ul style="list-style-type: none"> ▪ The Switch option is selected in the Operating mode parameter. ▪ The Flow direction check option is selected in the Switch output function parameter. 	Select process variable for flow direction monitoring.		Volume flow
Assign status	<ul style="list-style-type: none"> ▪ The Switch option is selected in Operating mode parameter. ▪ The Status option is selected in Switch output function parameter. 	Select the device function for which to display the status. If the switch on point is reached, the output is switched on (closed, conductive).	<ul style="list-style-type: none"> ▪ Empty pipe detection ▪ Low flow cutoff ▪ Buildup index * ▪ HBSI limit exceeded * 	Empty pipe detection
Pulse scaling	The Pulse option is selected in the Operating mode parameter (→ 109) and a process variable is selected in the Assign pulse output parameter (→ 109).	Enter quantity for measured value at which a pulse is output.	Positive floating point number	Depends on country and nominal diameter
Pulse width	The Pulse option is selected in the Operating mode parameter (→ 109) and a process variable is selected in the Assign pulse output parameter (→ 109).	Define time width of the output pulse.	0.05 to 2 000 ms	100 ms
Failure mode	The Pulse option is selected in the Operating mode parameter (→ 109) and a process variable is selected in the Assign pulse output parameter (→ 109).	Select output behavior in the event of a device alarm.	<ul style="list-style-type: none"> ▪ Actual value ▪ No pulses 	No pulses

Parameter	Prerequisite	Description	Selection / User interface / User entry	Factory setting
Minimum frequency value	The Frequency option is selected in the Operating mode parameter (→ 109) and a process variable is selected in the Assign frequency output parameter (→ 109).	Enter minimum frequency.	0.0 to 10000.0 Hz	0.0 Hz
Maximum frequency value	The Frequency option is selected in the Operating mode parameter (→ 109) and a process variable is selected in the Assign frequency output parameter (→ 109).	Enter maximum frequency.	0.0 to 10000.0 Hz	10000.0 Hz
Measuring value at minimum frequency	The Frequency option is selected in the Operating mode parameter (→ 109) and a process variable is selected in the Assign frequency output parameter (→ 109).	Enter measured value for minimum frequency.	Signed floating-point number	Depends on country and nominal diameter
Measuring value at maximum frequency	The Frequency option is selected in the Operating mode parameter (→ 109) and a process variable is selected in the Assign frequency output parameter (→ 109).	Enter measured value for maximum frequency.	Signed floating-point number	Depends on country and nominal diameter
Output damping	One of the following options is selected in the Assign current output parameter (→ 106): <ul style="list-style-type: none"> ▪ Volume flow ▪ Mass flow ▪ Corrected volume flow ▪ Flow velocity ▪ Conductivity* ▪ Corrected conductivity* ▪ Temperature* ▪ Electronics temperature 	Enter a time constant for output damping (PT1 element). Damping reduces the effect of fluctuations in the measured value on the output signal.	0 to 999.9 s	0.0 s
Failure mode	The Frequency option is selected in the Operating mode parameter (→ 109) and a process variable is selected in the Assign frequency output parameter (→ 109).	Select output behavior in the event of a device alarm.	<ul style="list-style-type: none"> ▪ Actual value ▪ Fixed value ▪ 0 Hz 	0 Hz
Failure frequency	In the Operating mode parameter (→ 109), the Frequency option is selected, in the Assign frequency output parameter (→ 109) a process variable is selected, and in the Failure mode parameter, the Defined value option is selected.	Enter frequency output value in alarm condition.	0.0 to 12500.0 Hz	0.0 Hz
Switch-on value	<ul style="list-style-type: none"> ▪ The Switch option is selected in the Operating mode parameter. ▪ The Limit option is selected in the Switch output function parameter. 	Enter limit value for switch-on point (process variable > switch-on value = closed, conductive).	Signed floating-point number	Depends on country: <ul style="list-style-type: none"> ▪ 0 l/h ▪ 0 gal/min (us)

Parameter	Prerequisite	Description	Selection / User interface / User entry	Factory setting
Switch-off value	<ul style="list-style-type: none"> ▪ The Switch option is selected in the Operating mode parameter. ▪ The Limit option is selected in the Switch output function parameter. 	Enter limit value for switch-off point (process variable < switch-off value = open, nonconductive).	Signed floating-point number	Depends on country: <ul style="list-style-type: none"> ▪ 0 l/h ▪ 0 gal/min (us)
Switch-on delay	–	Enter a delay before the output is switched on.	0.0 to 100.0 s	0.0 s
Switch-off delay	–	Enter a delay before the output is switched off.	0.0 to 100.0 s	0.0 s
Failure mode	–	Select output behavior in the event of a device alarm.	<ul style="list-style-type: none"> ▪ Actual status ▪ Open ▪ Closed 	Open
Invert output signal	–	Invert the output signal.	<ul style="list-style-type: none"> ▪ No ▪ Yes 	No

* Visibility depends on order options or device settings

10.5.8 Configuring the relay output





The **Relay output** wizard guides the user systematically through all the parameters that have to be set for configuring the relay output.

Navigation

"Setup" menu → Relay output 1 to n

▶ Relay output 1 to n

Relay output function	→ 113
Terminal number	→ 113
Assign flow direction check	→ 113
Terminal number	→ 113
Assign limit	→ 113
Terminal number	→ 113
Assign diagnostic behavior	→ 113
Terminal number	→ 113
Assign status	→ 113
Terminal number	→ 113
Switch-off value	→ 113

Switch-off delay	→  114
Switch-on value	→  114
Switch-on delay	→  114
Failure mode	→  114
Terminal number	→  113

Parameter overview with brief description

Parameter	Prerequisite	Description	Selection / User interface / User entry	Factory setting
Relay output function	–	Select the function for the relay output.	<ul style="list-style-type: none"> ▪ Closed ▪ Open ▪ Diagnostic behavior ▪ Limit ▪ Flow direction check ▪ Status 	Closed
Terminal number	–	Shows the terminal numbers used by the relay output module.	<ul style="list-style-type: none"> ▪ Not used ▪ 24-25 (I/O 2) ▪ 22-23 (I/O 3) ▪ 20-21 (I/O 4) 	–
Assign flow direction check	The Flow direction check option is selected in the Relay output function parameter.	Select process variable for flow direction monitoring.		Volume flow
Assign limit	The Limit option is selected in Relay output function parameter.	Select the variable to monitor in case the specified limit value is exceeded. If a limit value is exceeded, the output is switched on (conductive).	<ul style="list-style-type: none"> ▪ Off ▪ Volume flow ▪ Mass flow ▪ Corrected volume flow ▪ Flow velocity ▪ Conductivity * ▪ Corrected conductivity * ▪ Totalizer 1 ▪ Totalizer 2 ▪ Totalizer 3 ▪ Temperature * ▪ Electronics temperature 	Volume flow
Assign diagnostic behavior	In the Relay output function parameter, the Diagnostic behavior option is selected.	The output is switched on (closed, conductive), if there is a pending diagnostic event of the assigned behavioral category.	<ul style="list-style-type: none"> ▪ Alarm ▪ Alarm or warning ▪ Warning 	Alarm
Assign status	In the Relay output function parameter, the Digital Output option is selected.	Select the device function for which to display the status. If the switch on point is reached, the output is switched on (closed, conductive).	<ul style="list-style-type: none"> ▪ Empty pipe detection ▪ Low flow cutoff ▪ HBSI limit exceeded * 	Empty pipe detection
Switch-off value	The Limit option is selected in the Relay output function parameter.	Enter limit value for switch-off point (process variable < switch-off value = open, nonconductive).	Signed floating-point number	Depends on country: <ul style="list-style-type: none"> ▪ 0 l/h ▪ 0 gal(us)/min

Parameter	Prerequisite	Description	Selection / User interface / User entry	Factory setting
Switch-off delay	In the Relay output function parameter, the Limit option is selected.	Enter a delay before the output is switched off.	0.0 to 100.0 s	0.0 s
Switch-on value	The Limit option is selected in the Relay output function parameter.	Enter measured value for the switch-on point.	Signed floating-point number	Depends on country: <ul style="list-style-type: none"> ■ 0 l/h ■ 0 gal(us)/min
Switch-on delay	In the Relay output function parameter, the Limit option is selected.	Enter a delay before the output is switched on.	0.0 to 100.0 s	0.0 s
Failure mode	–	Select output behavior in the event of a device alarm.	<ul style="list-style-type: none"> ■ Actual status ■ Open ■ Closed 	Open
Switch state	–	Indicates the current switch state of the output.	<ul style="list-style-type: none"> ■ Open ■ Closed 	–

* Visibility depends on order options or device settings

10.5.9 Configuring the double pulse output

The **Double pulse output** submenu guides the user systematically through all the parameters that have to be set for configuring the double pulse output.

Navigation

"Setup" menu → Double pulse output

▶ Double pulse output	
Signal mode	→ ⓘ 115
Master terminal number	→ ⓘ 115
Assign pulse output	→ ⓘ 115
Measuring mode	→ ⓘ 115
Value per pulse	→ ⓘ 115
Pulse width	→ ⓘ 115
Failure mode	→ ⓘ 115
Invert output signal	→ ⓘ 115

Parameter overview with brief description

Parameter	Description	Selection / User interface / User entry	Factory setting
Signal mode	Select the signal mode for the double pulse output.	<ul style="list-style-type: none"> ■ Passive ■ Active * ■ Passive NE 	Passive
Master terminal number	Shows the terminal numbers used by the master of the double pulse output module.	<ul style="list-style-type: none"> ■ Not used ■ 24-25 (I/O 2) ■ 22-23 (I/O 3) 	-
Assign pulse output	Select process variable for pulse output.	<ul style="list-style-type: none"> ■ Off ■ Volume flow ■ Mass flow ■ Corrected volume flow 	Off
Measuring mode	Select measuring mode for pulse output.	<ul style="list-style-type: none"> ■ Forward flow ■ Forward/Reverse flow ■ Reverse flow ■ Reverse flow compensation 	Forward flow
Value per pulse	Enter measured value at which a pulse is output.	Signed floating-point number	Depends on country and nominal diameter
Pulse width	Define time width of the output pulse.	0.5 to 2 000 ms	0.5 ms
Failure mode	Select output behavior in the event of a device alarm.	<ul style="list-style-type: none"> ■ Actual value ■ No pulses 	No pulses
Invert output signal	Invert the output signal.	<ul style="list-style-type: none"> ■ No ■ Yes 	No

* Visibility depends on order options or device settings

10.5.10 Configuring the local display



The **Display** wizard guides you systematically through all the parameters that can be configured for configuring the local display.

Navigation



"Setup" menu → Display

► **Display**

Format display	→ ⓘ 116
Value 1 display	→ ⓘ 116
0% bargraph value 1	→ ⓘ 116
100% bargraph value 1	→ ⓘ 116
Value 2 display	→ ⓘ 116
Value 3 display	→ ⓘ 116
0% bargraph value 3	→ ⓘ 116

100% bargraph value 3	→  117
Value 4 display	→  117

Parameter overview with brief description

Parameter	Prerequisite	Description	Selection / User entry	Factory setting
Format display	A local display is provided.	Select how measured values are shown on the display.	<ul style="list-style-type: none"> ■ 1 value, max. size ■ 1 bargraph + 1 value ■ 2 values ■ 1 value large + 2 values ■ 4 values 	1 value, max. size
Value 1 display	A local display is provided.	Select the measured value that is shown on the local display.	<ul style="list-style-type: none"> ■ Volume flow ■ Mass flow ■ Corrected volume flow ■ Flow velocity ■ Corrected conductivity * ■ Temperature * ■ Electronics temperature ■ HBSI * ■ Noise * ■ Coil current shot time * ■ Reference electrode potential against PE * ■ Buildup index * ■ Test point 1 ■ Test point 2 ■ Test point 3 ■ Totalizer 1 ■ Totalizer 2 ■ Totalizer 3 ■ Current output 1 * ■ Current output 2 * ■ Current output 3 * ■ Current output 4 * 	Volume flow
0% bargraph value 1	A local display is provided.	Enter 0 % value for bar graph display.	Signed floating-point number	Country-specific: <ul style="list-style-type: none"> ■ 0 l/h ■ 0 gal/min (us)
100% bargraph value 1	A local display is provided.	Enter 100 % value for bar graph display.	Signed floating-point number	Depends on country and nominal diameter
Value 2 display	A local display is provided.	Select the measured value that is shown on the local display.	For the picklist, see Value 1 display parameter (→  116)	None
Value 3 display	A local display is provided.	Select the measured value that is shown on the local display.	For the picklist, see Value 1 display parameter (→  116)	None
0% bargraph value 3	A selection was made in the Value 3 display parameter.	Enter 0 % value for bar graph display.	Signed floating-point number	Country-specific: <ul style="list-style-type: none"> ■ 0 l/h ■ 0 gal/min (us)

Parameter	Prerequisite	Description	Selection / User entry	Factory setting
100% bargraph value 3	A selection was made in the Value 3 display parameter.	Enter 100 % value for bar graph display.	Signed floating-point number	0
Value 4 display	A local display is provided.	Select the measured value that is shown on the local display.	For the picklist, see Value 1 display parameter (→ 116)	None
Display language	A local display is provided.	Set display language.	<ul style="list-style-type: none"> ▪ English ▪ Deutsch ▪ Français ▪ Español ▪ Italiano ▪ Nederlands ▪ Portuguesa ▪ Polski ▪ русский язык (Russian) ▪ Svenska ▪ Türkçe ▪ 中文 (Chinese) ▪ 日本語 (Japanese) ▪ 한국어 (Korean) ▪ tiếng Việt (Vietnamese)* ▪ čeština (Czech) 	English (alternatively, the ordered language is preset in the device)
Display interval	A local display is provided.	Set time measured values are shown on display if display alternates between values.	1 to 10 s	5 s
Display damping	A local display is provided.	Set display reaction time to fluctuations in the measured value.	0.0 to 999.9 s	0.0 s
Header	A local display is provided.	Select header contents on local display.	<ul style="list-style-type: none"> ▪ Device tag ▪ Free text 	Device tag
Header text	The Free text option is selected in the Header parameter.	Enter display header text.	Max. 12 characters, such as letters, numbers or special characters (e.g. @, %, /)	-----
Separator	A local display is provided.	Select decimal separator for displaying numerical values.	<ul style="list-style-type: none"> ▪ . (point) ▪ , (comma) 	. (point)
Backlight	–	Switch the local display backlight on and off.	<ul style="list-style-type: none"> ▪ Disable ▪ Enable 	Enable
Value 5 display	A local display is provided.	Select the measured value that is shown on the local display.	For the picklist, see Value 1 display parameter (→ 116)	None
Value 6 display	A local display is provided.	Select the measured value that is shown on the local display.	For the picklist, see Value 1 display parameter (→ 116)	None
Value 7 display	A local display is provided.	Select the measured value that is shown on the local display.	For the picklist, see Value 1 display parameter (→ 116)	None
Value 8 display	A local display is provided.	Select the measured value that is shown on the local display.	For the picklist, see Value 1 display parameter (→ 116)	None

* Visibility depends on order options or device settings

10.5.11 Configuring the low flow cut off

The **Low flow cutoff** wizard systematically guides the user through all the parameters that must be set to configure low flow cut off.

Navigation

"Setup" menu → Low flow cutoff

► Low flow cutoff	
Assign process variable	→ ⓘ 118
On value low flow cutoff	→ ⓘ 118
Off value low flow cutoff	→ ⓘ 118
Pressure shock suppression	→ ⓘ 118

Parameter overview with brief description

Parameter	Prerequisite	Description	Selection / User entry	Factory setting
Assign process variable	–	Select process variable for low flow cutoff.	<ul style="list-style-type: none"> ▪ Off ▪ Mass flow ▪ Volume flow ▪ Corrected volume flow 	Volume flow
On value low flow cutoff	A process variable is selected in the Assign process variable parameter (→ ⓘ 118).	Enter on value for low flow cutoff.	Positive floating-point number	Depends on country and nominal diameter
Off value low flow cutoff	A process variable is selected in the Assign process variable parameter (→ ⓘ 118).	Enter off value for low flow cutoff.	0 to 100.0 %	50 %
Pressure shock suppression	A process variable is selected in the Assign process variable parameter (→ ⓘ 118).	Enter time frame for signal suppression (= active pressure shock suppression).	0 to 100 s	0 s

10.5.12 Configuring empty pipe detection

-  The measuring instruments are calibrated with water (approx. 500 µS/cm) at the factory. For liquids with a lower conductivity, it is advisable to perform a new full pipe adjustment on site.
 - It is recommended to perform a new empty pipe adjustment on site if a cable that is longer than 50 meters is used.

The **Empty pipe detection** submenu contains parameters that must be configured for the configuration of empty pipe detection.

Navigation

"Setup" menu → Empty pipe detection

► Empty pipe detection	
Empty pipe detection	→ ⓘ 119
New adjustment	→ ⓘ 119
Progress	→ ⓘ 119
Switch point empty pipe detection	→ ⓘ 119
Response time empty pipe detection	→ ⓘ 119

Parameter overview with brief description

Parameter	Prerequisite	Description	Selection / User interface / User entry	Factory setting
Empty pipe detection	–	Switch empty pipe detection on and off.	<ul style="list-style-type: none"> ▪ Off ▪ On 	Off
New adjustment	The On option is selected in the Empty pipe detection parameter.	Select type of adjustment.	<ul style="list-style-type: none"> ▪ Cancel ▪ Empty pipe adjust ▪ Full pipe adjust 	Cancel
Progress	–	Shows the progress of the process.	<ul style="list-style-type: none"> ▪ Ok ▪ Busy ▪ Not ok 	Not ok
Switch point empty pipe detection	–	Enter the switch point in % of the difference between the two adjustment values. The lower the percentage, the earlier the pipe is detected as empty.	0 to 100 %	50 %
Response time empty pipe detection	A process variable is selected in the Assign process variable parameter (→ ⓘ 119).	Use this function to enter the minimum time (hold time) the signal must be present before diagnostic message S962 "Empty pipe" is triggered in the event of a partially filled or empty measuring pipe.	0 to 100 s	1 s

10.5.13 Configuring flow damping

The **Configure flow damping** wizard guides the user systematically through the parameters, depending on the selected scenario:

- Configuration of damping for the application
To configure flow damping for the specific requirements of the process application.
- Replace old device
To adopt the flow damping for the new device in the event of a device replacement.
- Restoring factory settings
To restore the factory settings of all the parameters that are relevant for flow damping.

Navigation

"Setup" menu → Configure flow damping

► Configure flow damping	
Scenario	→ 121
Old device	→ 121
CIP filter on	→ 121
Damping level	→ 121
Flow change rate	→ 121
Application	→ 121
Pulsating flow	→ 121
Flow peaks	→ 121
Damping level	→ 121
Filter options	→ 121
Median filter depth	→ 121
Flow damping	→ 121
Support ID	→ 121
Save settings	→ 121

Parameter overview with brief description

Parameter	Description	Selection / User interface	Factory setting
Scenario	Select the applicable scenario.	<ul style="list-style-type: none"> ■ Replace old device ■ Configure damping for application ■ Restore factory settings 	Configure damping for application
Old device	Select the measuring device to replace.	<ul style="list-style-type: none"> ■ Promag 10 (pre-2021) ■ Promag 50/53 ■ Promag 55 H 	Promag 50/53
CIP filter on	Indicate whether the CIP filter was applied for the device to be replaced.	<ul style="list-style-type: none"> ■ No ■ Yes 	No
Damping level	Select the degree of damping to apply.	<ul style="list-style-type: none"> ■ Default ■ Weak ■ Strong 	Default
Flow change rate	Select the rate at which the flow changes.	<ul style="list-style-type: none"> ■ Once a day or less ■ Once an hour or less ■ Once a minute or less ■ Once a second or more 	Once a minute or less
Application	Select the type of application that applies.	<ul style="list-style-type: none"> ■ Display flow ■ Control loop ■ Totalizing ■ Batching 	Display flow
Pulsating flow	Indicate whether the process is characterized by pulsating flow (e.g. due to a displacement pump).	<ul style="list-style-type: none"> ■ No ■ Yes 	No
Flow peaks	Select the frequency at which flow interference peaks occur.	<ul style="list-style-type: none"> ■ Never ■ Sporadically ■ Regularly ■ Continuously 	Never
Response Time		<ul style="list-style-type: none"> ■ Fast ■ Slow ■ Normal 	Normal
Filter options	Shows the type of flow filter recommended for damping.	<ul style="list-style-type: none"> ■ Adaptive ■ Adaptive CIP on ■ Dynamic ■ Dynamic CIP on ■ Binomial ■ Binomial CIP on 	Binomial
Median filter depth	Shows median filter depth recommended for damping.	0 to 255	6
Flow damping	Shows the flow filter depth recommended for damping.	0 to 15	7
Support ID	If the recommended settings are not satisfactory: please contact your Endress+Hauser service organization with the support ID displayed.	0 to 65535	0
Save settings	Indicate whether to save the recommended settings.	<ul style="list-style-type: none"> ■ Cancel ■ Save 	Cancel

10.6 Advanced settings

Navigation

"Setup" menu → Advanced setup

▶ Advanced setup		
Enter access code		→ 122
▶ Sensor adjustment		→ 122
▶ Totalizer 1 to n		→ 123
▶ Custody transfer activation		→ 126
▶ Custody transfer deactivation		→ 124
▶ Display		→ 128
▶ Electrode cleaning cycle		→ 130
▶ WLAN settings		→ 131
▶ Configuration backup		→ 133
▶ Administration		→ 134

Parameter overview with brief description

Parameter	Description	User entry	Factory setting
Enter access code	Enter access code to disable write protection of parameters.	0 to 9999	0

10.6.1 Carrying out a sensor adjustment

The **Sensor adjustment** submenu contains parameters that pertain to the functionality of the sensor.

Navigation

"Setup" menu → Advanced setup → Sensor adjustment

▶ Sensor adjustment	
Installation direction	→ 123

Parameter overview with brief description

Parameter	Description	Selection	Factory setting
Installation direction	Select sign of flow direction.	<ul style="list-style-type: none"> ■ Forward flow ■ Reverse flow 	Forward flow

10.6.2 Configuring the totalizer

In the "**Totalizer 1 to n**" submenu, you can configure the specific totalizer.

Navigation

"Setup" menu → Advanced setup → Totalizer 1 to n

▶ **Totalizer 1 to n**

Assign process variable 1 to n

→ ⓘ 123

Process variable unit 1 to n

→ ⓘ 123

Totalizer 1 to n operation mode

→ ⓘ 123

Totalizer 1 to n failure behavior

→ ⓘ 123

Parameter overview with brief description

Parameter	Prerequisite	Description	Selection	Factory setting
Assign process variable 1 to n	–	Select process variable for totalizer.	<ul style="list-style-type: none"> ■ Off ■ Volume flow ■ Mass flow ■ Corrected volume flow 	Volume flow
Process variable unit 1 to n	A process variable is selected in the Assign process variable parameter (→ ⓘ 123) of the Totalizer 1 to n submenu.	Select the unit for the process variable of the totalizer.	Unit choose list	Depends on country: <ul style="list-style-type: none"> ■ l ■ gal (us)
Totalizer 1 to n operation mode	A process variable is selected in the Assign process variable parameter (→ ⓘ 123) of the Totalizer 1 to n submenu.	Select totalizer operation mode, e.g. only totalize forward flow or only totalize reverse flow.	<ul style="list-style-type: none"> ■ Net ■ Forward ■ Reverse 	Net
Totalizer 1 to n failure behavior	A process variable is selected in the Assign process variable parameter (→ ⓘ 123) of the Totalizer 1 to n submenu.	Select totalizer behavior in the event of a device alarm.	<ul style="list-style-type: none"> ■ Hold ■ Continue ■ Last valid value + continue 	Hold

10.6.3 "Custody transfer activation" wizard

In the **Display** submenu you can set all the parameters associated with the configuration of the local display.

Navigation

"Setup" menu → Advanced setup → Custody transfer deactivation

▶ Custody transfer activation

Authorized user login	→ 124
Password	→ 124
Login state	→ 124
Display test	→ 124
Year	→ 124
Month	→ 125
Day	→ 125
AM/PM	→ 125
Hour	→ 125
Minute	→ 125
Clear custody transfer logbook	→ 125
Number of logbook entries	→ 125
Checksum	→ 125
Toggle DIP switch	→ 125

Parameter overview with brief description

Parameter	Description	User entry / User interface / Selection	Factory setting
Authorized user login	Enter a specified authorized user login.	Authorized user login	EH000
Password	Enter a specified password.	0 to 999 999	177 801
Login state	Display login status.	<ul style="list-style-type: none"> ▪ Logged in ▪ Logged out 	Logged out
Display test	Start or cancel display test.	<ul style="list-style-type: none"> ▪ Cancel ▪ Start 	Cancel
Year	Enter the year.	9 to 99	10

Parameter	Description	User entry / User interface / Selection	Factory setting
Month	Enter the month.	<ul style="list-style-type: none"> ▪ January ▪ February ▪ March ▪ April ▪ May ▪ June ▪ July ▪ August ▪ September ▪ October ▪ November ▪ December 	January
Day	Enter the day.	1 to 31 d	1 d
AM/PM	Select AM/PM.	<ul style="list-style-type: none"> ▪ AM ▪ PM 	AM
Hour	Enter the hour.	0 to 23 h	12 h
Minute	Enter the minutes.	0 to 59 min	0 min
Clear custody transfer logbook	Delete custody transfer logbook selection.	<ul style="list-style-type: none"> ▪ Cancel ▪ Clear data 	Cancel
Number of logbook entries	Display the recorded logbook entries.	0..30	0
Checksum	Shows the firmware's checksum.	Positive integer	-
Toggle DIP switch	Display the DIP switch status.	<ul style="list-style-type: none"> ▪ Off ▪ On 	Off

10.6.4 "Custody transfer deactivation" wizard

Navigation

"Setup" menu → Advanced setup → Custody transfer activation

► Custody transfer deactivation

Authorized user login	→ ⓘ 126
Password	→ ⓘ 126
Login state	→ ⓘ 126
Year	→ ⓘ 126
Month	→ ⓘ 126
Day	→ ⓘ 126
AM/PM	→ ⓘ 126
Hour	→ ⓘ 126
Minute	→ ⓘ 127
Toggle DIP switch	→ ⓘ 127

Parameter overview with brief description

Parameter	Description	User entry / User interface / Selection	Factory setting
Authorized user login	Enter a specified authorized user login.	Authorized user login	EH000
Password	Enter a specified password.	0 to 999 999	177 801
Login state	Display login status.	<ul style="list-style-type: none"> ▪ Logged in ▪ Logged out 	Logged out
Year	Enter the year.	9 to 99	10
Month	Enter the month.	<ul style="list-style-type: none"> ▪ January ▪ February ▪ March ▪ April ▪ May ▪ June ▪ July ▪ August ▪ September ▪ October ▪ November ▪ December 	January
Day	Enter the day.	1 to 31 d	1 d
AM/PM	Select AM/PM.	<ul style="list-style-type: none"> ▪ AM ▪ PM 	AM
Hour	Enter the hour.	0 to 23 h	12 h

Parameter	Description	User entry / User interface / Selection	Factory setting
Minute	Enter the minutes.	0 to 59 min	0 min
Toggle DIP switch	Display the DIP switch status.	<ul style="list-style-type: none">▪ Off▪ On	Off

10.6.5 Carrying out additional display configurations

In the **Display** submenu you can set all the parameters associated with the configuration of the local display.

Navigation

"Setup" menu → Advanced setup → Display

► Display	
Format display	→ 129
Value 1 display	→ 129
0% bargraph value 1	→ 129
100% bargraph value 1	→ 129
Value 2 display	→ 129
Value 3 display	→ 129
0% bargraph value 3	→ 129
100% bargraph value 3	→ 129
Value 4 display	→ 129

Parameter overview with brief description

Parameter	Prerequisite	Description	Selection / User entry	Factory setting
Format display	A local display is provided.	Select how measured values are shown on the display.	<ul style="list-style-type: none"> ■ 1 value, max. size ■ 1 bargraph + 1 value ■ 2 values ■ 1 value large + 2 values ■ 4 values 	1 value, max. size
Value 1 display	A local display is provided.	Select the measured value that is shown on the local display.	<ul style="list-style-type: none"> ■ Volume flow ■ Mass flow ■ Corrected volume flow ■ Flow velocity ■ Corrected conductivity * ■ Temperature * ■ Electronics temperature ■ HBSI * ■ Noise * ■ Coil current shot time * ■ Reference electrode potential against PE * ■ Buildup index * ■ Test point 1 ■ Test point 2 ■ Test point 3 ■ Totalizer 1 ■ Totalizer 2 ■ Totalizer 3 ■ Current output 1 * ■ Current output 2 * ■ Current output 3 * ■ Current output 4 * 	Volume flow
0% bargraph value 1	A local display is provided.	Enter 0 % value for bar graph display.	Signed floating-point number	Country-specific: <ul style="list-style-type: none"> ■ 0 l/h ■ 0 gal/min (us)
100% bargraph value 1	A local display is provided.	Enter 100 % value for bar graph display.	Signed floating-point number	Depends on country and nominal diameter
Value 2 display	A local display is provided.	Select the measured value that is shown on the local display.	For the picklist, see Value 1 display parameter (→ 116)	None
Value 3 display	A local display is provided.	Select the measured value that is shown on the local display.	For the picklist, see Value 1 display parameter (→ 116)	None
0% bargraph value 3	A selection was made in the Value 3 display parameter.	Enter 0 % value for bar graph display.	Signed floating-point number	Country-specific: <ul style="list-style-type: none"> ■ 0 l/h ■ 0 gal/min (us)
100% bargraph value 3	A selection was made in the Value 3 display parameter.	Enter 100 % value for bar graph display.	Signed floating-point number	0
Value 4 display	A local display is provided.	Select the measured value that is shown on the local display.	For the picklist, see Value 1 display parameter (→ 116)	None

* Visibility depends on order options or device settings





10.6.6 Performing electrode cleaning

The **Electrode cleaning cycle** submenu contains the parameters that must be set for the configuration of electrode cleaning.

 The submenu is only available if the device was ordered with electrode cleaning.

Navigation

"Setup" menu → Advanced setup → Electrode cleaning cycle

▶ Electrode cleaning cycle	
Electrode cleaning cycle	→  130
ECC duration	→  130
ECC recovery time	→  130
ECC interval	→  130
ECC polarity	→  130

Parameter overview with brief description

Parameter	Prerequisite	Description	Selection / User entry / User interface	Factory setting
Electrode cleaning cycle	For the following order code: "Application package", option EC "ECC electrode cleaning"	Switch electrode cleaning on or off.	<ul style="list-style-type: none"> ▪ Off ▪ On 	On
ECC duration	For the following order code: "Application package", option EC "ECC electrode cleaning"	Specify the duration of the cleaning phase of the cycle. Diag. msg. no. 530 is displayed until the cleaning phase and recovery phase are complete.	0.01 to 30 s	2 s
ECC recovery time	For the following order code: "Application package", option EC "ECC electrode cleaning"	Specify the maximum timespan after the cleaning phase for recovery before measurement resumes during which the output signal values are frozen.	1 to 600 s	60 s
ECC interval	For the following order code: "Application package", option EC "ECC electrode cleaning"	Specify the interval between one cleaning cycle and the next.	0.5 to 168 h	0.5 h
ECC polarity	For the following order code: "Application package", option EC "ECC electrode cleaning"	Select the polarity of the electrode cleaning circuit.	<ul style="list-style-type: none"> ▪ Positive ▪ Negative 	Depends on the electrode material: <ul style="list-style-type: none"> ▪ Tantalum: Negative option ▪ Platinum, Alloy C22, stainless steel: Positive option

10.6.7 WLAN configuration

The **WLAN Settings** submenu guides the user systematically through all the parameters that have to be set for the WLAN configuration.

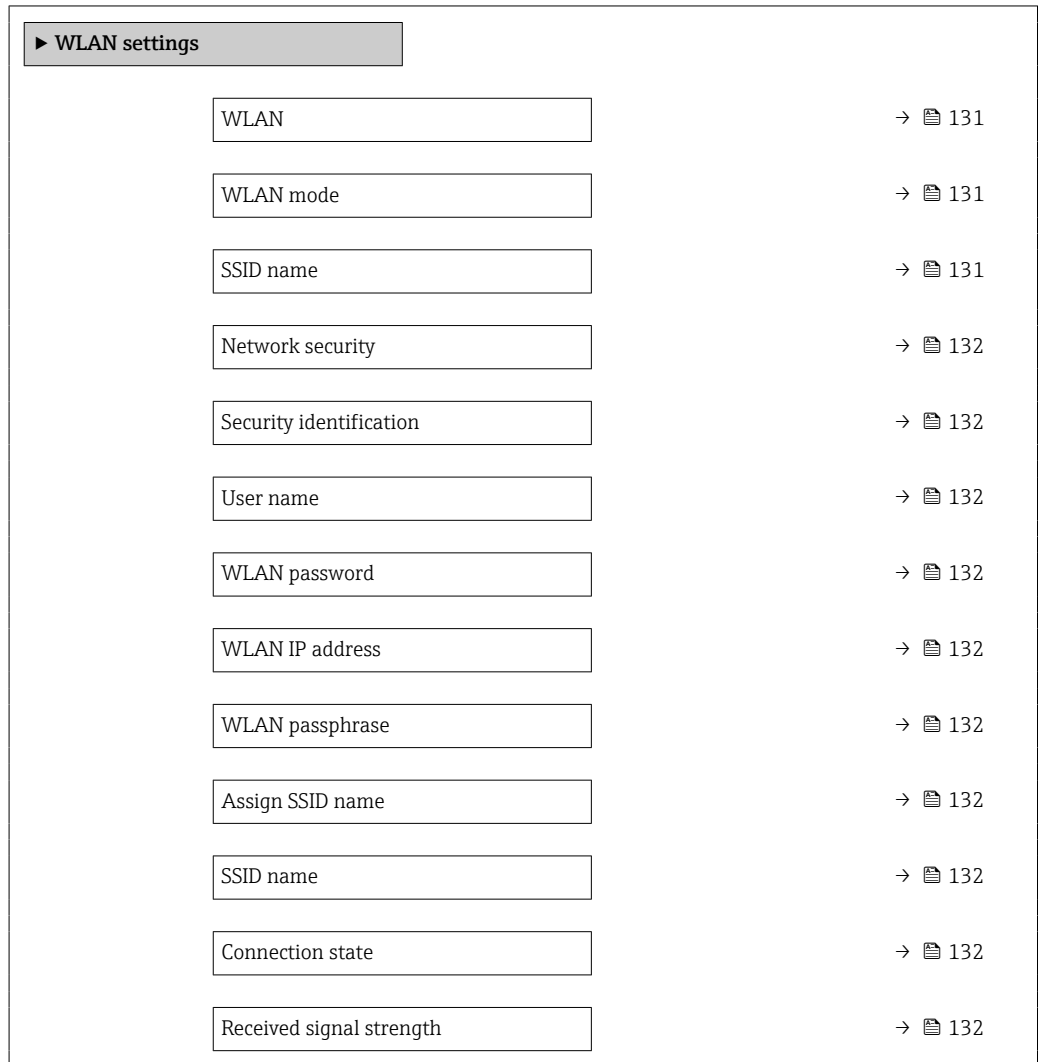

Navigation

"Setup" menu → Advanced setup → WLAN settings



Parameter overview with brief description

Parameter	Prerequisite	Description	Selection / User entry / User interface	Factory setting
WLAN	–	Switch WLAN on and off.	<ul style="list-style-type: none"> ■ Disable ■ Enable 	Enable
WLAN mode	–	Select WLAN mode.	<ul style="list-style-type: none"> ■ WLAN access point ■ WLAN Client 	WLAN access point
SSID name	The client is activated.	Enter the user-defined SSID name (max. 32 characters).	–	–

Parameter	Prerequisite	Description	Selection / User entry / User interface	Factory setting
Network security	–	Select the security type of the WLAN network.	<ul style="list-style-type: none"> ■ Unsecured ■ WPA2-PSK ■ EAP-PEAP with MSCHAPv2 * ■ EAP-PEAP MSCHAPv2 no server authentic. * ■ EAP-TLS * 	WPA2-PSK
Security identification	–	Select security settings and download these settings via menu Data management > Security > WLAN.	<ul style="list-style-type: none"> ■ Trusted issuer certificate ■ Device certificate ■ Device private key 	–
User name	–	Enter user name.	–	–
WLAN password	–	Enter WLAN password.	–	–
WLAN IP address	–	Enter IP address of the WLAN interface of the device.	4 octet: 0 to 255 (in the particular octet)	192.168.1.212
WLAN passphrase	The WPA2-PSK option is selected in the Security type parameter.	Enter the network key (8 to 32 characters).  The network key supplied with the device should be changed during commissioning for security reasons.	8 to 32-digit character string comprising numbers, letters and special characters (without spaces)	Serial number of the measuring device (e.g. L100A802000)
Assign SSID name	–	Select which name will be used for SSID: device tag or user-defined name.	<ul style="list-style-type: none"> ■ Device tag ■ User-defined 	User-defined
SSID name	<ul style="list-style-type: none"> ■ The User-defined option is selected in the Assign SSID name parameter. ■ The WLAN access point option is selected in the WLAN mode parameter. 	Enter the user-defined SSID name (max. 32 characters).  The user-defined SSID name may only be assigned once. If the SSID name is assigned more than once, the devices can interfere with one another.	Max. 32-digit character string comprising numbers, letters and special characters	EH_device designation_last 7 digits of the serial number (e.g. EH_Promag_500_A 802000)
Connection state	–	Displays the connection status.	<ul style="list-style-type: none"> ■ Connected ■ Not connected 	Not connected
Received signal strength	–	Shows the received signal strength.	<ul style="list-style-type: none"> ■ Low ■ Medium ■ High 	High

* Visibility depends on order options or device settings

10.6.8 Performing Heartbeat Technology basic setup

Heartbeat setup submenu guides the user systematically through all the parameters that can be used for the Heartbeat Technology basic setup.

 The Heartbeat Technology verification wizard only appears if the device has the Heartbeat Verification+Monitoring application package.

"Heartbeat base settings" submenu

Navigation

"Setup" menu → Advanced setup → Heartbeat setup → Heartbeat base settings

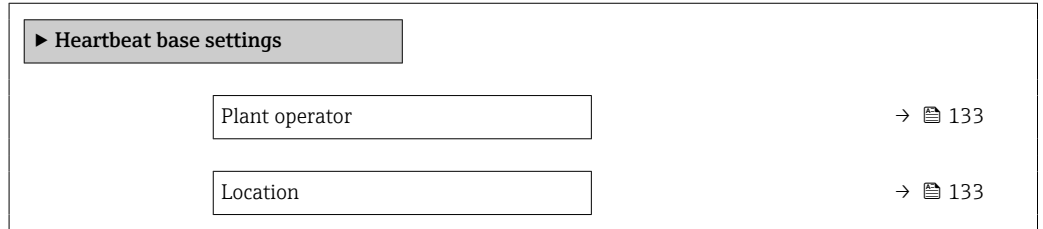

Parameter overview with brief description

Parameter	Description	Selection / User entry	Factory setting
Record application reference data	Record the actual device values as reference basis for monitoring and verification.	<ul style="list-style-type: none"> ■ Cancel ■ Start 	Cancel
Record application reference data	Record the actual device values as reference basis for monitoring and verification.	<ul style="list-style-type: none"> ■ Cancel ■ Start 	Cancel
Plant operator	Enter the plant operator.	Max. 32 characters such as letters, numbers or special characters (e.g. @, %, /)	–
Location	Enter the location.	Max. 32 characters such as letters, numbers or special characters (e.g. @, %, /)	–

10.6.9 Configuration management

After commissioning, you can save the current device configuration or restore the previous device configuration. The device configuration is managed via the **Configuration management** parameter.

Navigation

"Setup" menu → Advanced setup → Configuration backup

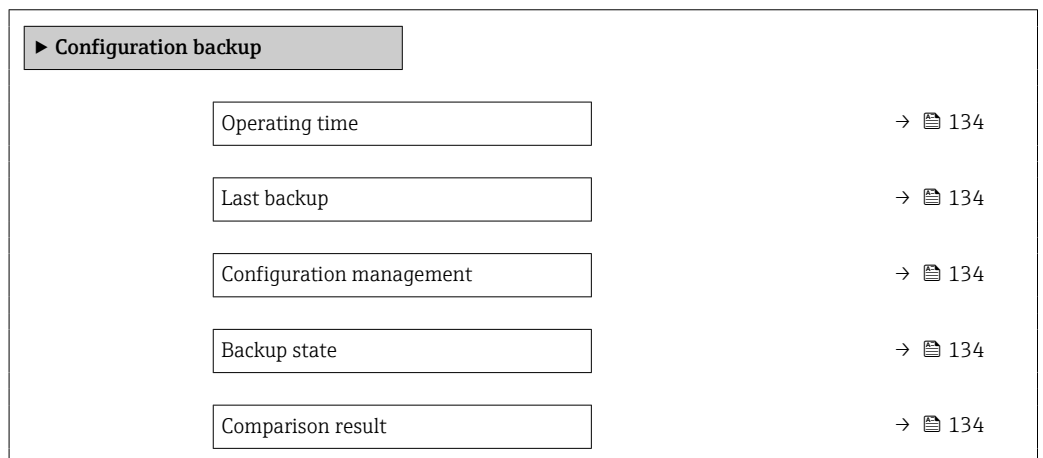

Parameter overview with brief description

Parameter	Description	User interface / Selection	Factory setting
Operating time	Indicates how long the device has been in operation.	Days (d), hours (h), minutes (m) and seconds (s)	–
Last backup	Shows when the last data backup was saved to HistoROM backup.	Days (d), hours (h), minutes (m) and seconds (s)	–
Configuration management	Select action for managing the device data in the HistoROM backup.	<ul style="list-style-type: none"> ■ Cancel ■ Execute backup ■ Restore * ■ Compare * ■ Clear backup data 	Cancel
Backup state	Shows the current status of data saving or restoring.	<ul style="list-style-type: none"> ■ None ■ Backup in progress ■ Restoring in progress ■ Delete in progress ■ Compare in progress ■ Restoring failed ■ Backup failed 	None
Comparison result	Comparison of current device data with HistoROM backup.	<ul style="list-style-type: none"> ■ Settings identical ■ Settings not identical ■ No backup available ■ Backup settings corrupt ■ Check not done ■ Dataset incompatible 	Check not done

* Visibility depends on order options or device settings

Function range of "Configuration management" parameter

Options	Description
Cancel	No action is executed and the user exits the parameter.
Execute backup	A backup copy of the current device configuration is saved from the HistoROM backup to the memory of the device. The backup copy includes the transmitter data of the device.
Restore	The last backup copy of the device configuration is restored from the display module from the device memory to the device's HistoROM backup. The backup copy includes the transmitter data of the device.
Compare	The device configuration saved in the device memory is compared with the current device configuration of the HistoROM backup.
Clear backup data	The backup copy of the device configuration is deleted from the memory of the device.



HistoROM backup

A HistoROM is a "non-volatile" device memory in the form of an EEPROM.



While this action is in progress, the configuration cannot be edited via the local display and a message on the processing status appears on the display.

10.6.10 Using parameters for device administration

The **Administration** submenu systematically guides the user through all the parameters that can be used for device administration purposes.

Navigation

"Setup" menu → Advanced setup → Administration

▶ Administration

▶ Define access code → ⓘ 135

▶ Reset access code → ⓘ 135

Device reset → ⓘ 136

Using the parameter to define the access code

Complete this wizard to specify an access code for the Maintenance role.

Navigation

"Setup" menu → Advanced setup → Administration → Define access code

▶ Define access code

Define access code → ⓘ 135

Confirm access code → ⓘ 135

Parameter overview with brief description

Parameter	Description	User entry
Define access code	Specify an access code that is required to obtain the access rights for the Maintenance role.	Max. 16-digit character string comprising numbers, letters and special characters
Confirm access code	Confirm the access code entered for the Maintenance role.	Max. 16-digit character string comprising numbers, letters and special characters

Using the parameter to reset the access code

Navigation

"Setup" menu → Advanced setup → Administration → Reset access code

▶ Reset access code

Operating time → ⓘ 136

Reset access code → ⓘ 136

Parameter overview with brief description

Parameter	Description	User interface / User entry	Factory setting
Operating time	Indicates how long the device has been in operation.	Days (d), hours (h), minutes (m) and seconds (s)	-
Reset access code	<p>Enter the code provided by Endress+Hauser Technical Support to reset the Maintenance code.</p> <p> For a reset code, contact your Endress+Hauser service organization.</p> <p>The reset code can only be entered via:</p> <ul style="list-style-type: none"> ▪ Web browser ▪ DeviceCare, FieldCare (via CDI-RJ45 service interface) ▪ Fieldbus 	Character string comprising numbers, letters and special characters	0x00

Using the parameter to reset the device

Navigation

"Setup" menu → Advanced setup → Administration

Parameter overview with brief description

Parameter	Description	Selection	Factory setting
Device reset	Reset the device configuration - either entirely or in part - to a defined state.	<ul style="list-style-type: none"> ▪ Cancel ▪ To delivery settings ▪ Restart device ▪ Restore S-DAT backup * 	Cancel





* Visibility depends on order options or device settings

10.7 Simulation



Via the **Simulation** submenu, it is possible to simulate various process variables in the process and the device alarm mode and verify downstream signal chains (switching valves or closed-control loops). The simulation can be performed without a real measurement (no flow of medium through the device).

Navigation

"Diagnostics" menu → Simulation

▶ Simulation	
▶ Process value simulation	→  138
▶ Input simulation	→  138
▶ Output simulation	→  139
▶ Diagnostic event simulation	→  140

Parameter overview with brief description

Parameter	Prerequisite	Description	Selection / User entry	Factory setting
Input signal level	In the Simulation status input parameter, the On option is selected.	Select the signal level for the simulation of the status input.	<ul style="list-style-type: none"> ■ High ■ Low 	High
Current input simulation	–	Switch simulation of the current input on and off.	<ul style="list-style-type: none"> ■ Off ■ On 	Off
Value current input	In the Current input 1 to n simulation parameter, the On option is selected.	Enter the current value for simulation.	0 to 22.5 mA	0 mA
Current output simulation	–	Switch the simulation of the current output on and off.	<ul style="list-style-type: none"> ■ Off ■ On 	Off
Current output value	In the Current output 1 to n simulation parameter, the On option is selected.	Enter the current value for simulation.	3.59 to 22.5 mA	3.59 mA
Frequency output simulation	In the Operating mode parameter, the Frequency option is selected.	Switch the simulation of the frequency output on and off.	<ul style="list-style-type: none"> ■ Off ■ On 	Off
Frequency output value	In the Frequency simulation 1 to n parameter, the On option is selected.	Enter the frequency value for the simulation.	0.0 to 12 500.0 Hz	0.0 Hz
Pulse output simulation	In the Operating mode parameter, the Pulse option is selected.	Set and switch off the pulse output simulation.  For Fixed value option: Pulse width parameter (→  110) defines the pulse width of the pulses output.	<ul style="list-style-type: none"> ■ Off ■ Fixed value ■ Down-counting value 	Off
Pulse value	In the Pulse output simulation 1 to n parameter, the Down-counting value option is selected.	Enter the number of pulses for simulation.	0 to 65 535	0
Switch output simulation	In the Operating mode parameter, the Switch option is selected.	Switch the simulation of the switch output on and off.	<ul style="list-style-type: none"> ■ Off ■ On 	Off
Switch state	–	Select the status of the status output for the simulation.	<ul style="list-style-type: none"> ■ Open ■ Closed 	Open
Relay output simulation	–	Switch simulation of the relay output on and off.	<ul style="list-style-type: none"> ■ Off ■ On 	Off
Switch state	The On option is selected in the Switch output simulation 1 to n parameter parameter.	Select status of the relay output for the simulation.	<ul style="list-style-type: none"> ■ Open ■ Closed 	Open
Pulse output simulation	–	Set and switch off the pulse output simulation.  For Fixed value option: Pulse width parameter defines the pulse width of the pulses output.	<ul style="list-style-type: none"> ■ Off ■ Fixed value ■ Down-counting value 	Off
Pulse value	In the Pulse output simulation parameter, the Down-counting value option is selected.	Set and switch off the pulse output simulation.	0 to 65 535	0

10.7.1 Process value simulation

Navigation

"Diagnostics" menu → Simulation → Process value simulation

▶ Process value simulation

Process variable simulation

→ 138

Process value

→ 138

Parameter overview with brief description

Parameter	Prerequisite	Description	Selection / User entry	Factory setting
Process variable simulation	–	Select a process variable for the simulation process that is activated.	<ul style="list-style-type: none"> ▪ Off ▪ Volume flow ▪ Mass flow ▪ Corrected volume flow ▪ Flow velocity* ▪ Conductivity* ▪ Corrected conductivity* ▪ Temperature* 	Off
Process value	A process variable is selected in the Assign simulation process variable parameter (→ 138).	Enter the simulation value for the selected process variable.	Depends on the process variable selected	0

* Visibility depends on order options or device settings

10.7.2 Simulation input

Navigation

"Diagnostics" menu → Simulation → Input simulation

▶ Input simulation

Current input 1 to n simulation

→ 139

Value current input 1 to n

→ 139

Status input simulation

→ 139

Input signal level

→ 139

Parameter overview with brief description

Parameter	Prerequisite	Description	Selection / User entry	Factory setting
Current input 1 to n simulation	–	Switch simulation of the current input on and off.	<ul style="list-style-type: none"> ■ Off ■ On 	Off
Value current input 1 to n	In the Current input 1 to n simulation parameter, the On option is selected.	Enter the current value for simulation.	0 to 22.5 mA	0 mA
Status input simulation	–	Switch simulation of the status input on and off.	<ul style="list-style-type: none"> ■ Off ■ On 	Off
Input signal level	–	Select the signal level for the simulation of the status input.	<ul style="list-style-type: none"> ■ High ■ Low 	High



10.7.3 Output simulation

Navigation

"Diagnostics" menu → Simulation → Output simulation

► Output simulation	
Current output 1 to n simulation	→ 140
Current output 1 to n value	→ 140
Frequency output 1 to n simulation	→ 140
Frequency output 1 to n value	→ 140
Pulse output simulation 1 to n	→ 140
Pulse value 1 to n	→ 140
Switch output simulation 1 to n	→ 140
Switch state 1 to n	→ 140
Relay output 1 to n simulation	→ 140
Switch state 1 to n	→ 140
Pulse output simulation	→ 140
Pulse value	→ 140

Parameter overview with brief description



Parameter	Prerequisite	Description	Selection / User entry	Factory setting
Current output 1 to n simulation	–	Switch the simulation of the current output on and off.	<ul style="list-style-type: none"> ▪ Off ▪ On 	Off
Current output 1 to n value	In the Current output 1 to n simulation parameter, the On option is selected.	Enter the current value for simulation.	3.59 to 22.5 mA	3.59 mA
Frequency output 1 to n simulation	In the Operating mode parameter, the Frequency option is selected.	Switch the simulation of the frequency output on and off.	<ul style="list-style-type: none"> ▪ Off ▪ On 	Off
Frequency output 1 to n value	In the Frequency simulation 1 to n parameter, the On option is selected.	Enter the frequency value for the simulation.	0.0 to 12 500.0 Hz	0.0 Hz
Pulse output simulation 1 to n	In the Operating mode parameter, the Pulse option is selected.	Set and switch off the pulse output simulation.  For Fixed value option: Pulse width parameter (→  110) defines the pulse width of the pulses output.	<ul style="list-style-type: none"> ▪ Off ▪ Fixed value ▪ Down-counting value 	Off
Pulse value 1 to n	In the Pulse output simulation 1 to n parameter, the Down-counting value option is selected.	Enter the number of pulses for simulation.	0 to 65 535	0
Switch output simulation 1 to n	In the Operating mode parameter, the Switch option is selected.	Switch the simulation of the switch output on and off.	<ul style="list-style-type: none"> ▪ Off ▪ On 	Off
Switch state 1 to n	–	Select the status of the status output for the simulation.	<ul style="list-style-type: none"> ▪ Open ▪ Closed 	Open
Relay output 1 to n simulation	–	Switch simulation of the relay output on and off.	<ul style="list-style-type: none"> ▪ Off ▪ On 	Off
Switch state 1 to n	The On option is selected in the Switch output simulation 1 to n parameter parameter.	Select status of the relay output for the simulation.	<ul style="list-style-type: none"> ▪ Open ▪ Closed 	Open
Pulse output simulation	–	Set and switch off the pulse output simulation.  For Fixed value option: Pulse width parameter defines the pulse width of the pulses output.	<ul style="list-style-type: none"> ▪ Off ▪ Fixed value ▪ Down-counting value 	Off
Pulse value	In the Pulse output simulation parameter, the Down-counting value option is selected.	Set and switch off the pulse output simulation.	0 to 65 535	0

10.7.4 Diagnostic event simulation

Navigation

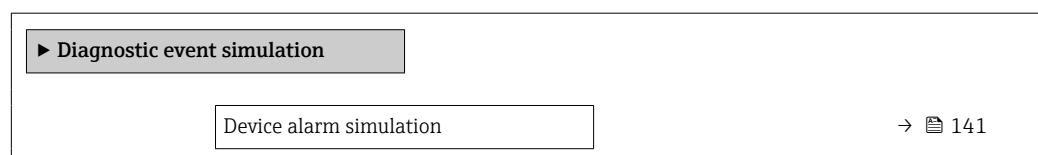
"Diagnostics" menu → Simulation → Diagnostic event simulation





Diagnostic event category	→  141
Diagnostic event simulation	→  141

Parameter overview with brief description

Parameter	Description	Selection / User entry	Factory setting
Device alarm simulation	Switch the device alarm on and off.	<ul style="list-style-type: none"> ▪ Off ▪ On 	Off
Diagnostic event simulation	Enter service ID of diagnostic event to simulate this event.	Positive integer	-
Diagnostic event category	Select a diagnostic event category.	<ul style="list-style-type: none"> ▪ Sensor ▪ Electronics ▪ Configuration ▪ Process 	Process
Diagnostic event simulation	Select a diagnostic event to simulate this event.	<ul style="list-style-type: none"> ▪ Off ▪ Diagnostic event picklist (depends on the category selected) 	Off

10.8 Protecting settings from unauthorized access

The following write protection options exist in order to protect the configuration of the measuring device from unintentional modification:



- Protect access to parameters via access code →  141
- Protect access to local operation via key locking →  81
- Protect access to measuring device via write protection switch →  142

10.8.1 Write protection via access code





The effects of the user-specific access code are as follows:

- Via local operation, the parameters for the measuring device configuration are write-protected and their values can no longer be changed.
- Device access is protected via the Web browser, as are the parameters for the measuring device configuration.
- Device access is protected via FieldCare or DeviceCare (via CDI-RJ45 service interface), as are the parameters for the measuring device configuration.

Defining the access code via the local display

1. Navigate to the **Define access code** parameter (→  135).
2. Maximum of 16-digit character string comprising numbers, letters and special characters as the access code.
3. Enter the access code again in the **Confirm access code** parameter (→  135) to confirm.

↳ The  symbol appears in front of all write-protected parameters.







-  ▪ Disabling parameter write protection via access code →  80.
- If the access code is lost: Resetting the access code →  142.
- The user role with which the user is currently logged in is displayed in **Access status** parameter.
 - Navigation path: Operation → Access status
 - User roles and their access rights →  80

- The device automatically locks the write-protected parameters again if a key is not pressed for 10 minutes in the navigation and editing view.
- The device locks the write-protected parameters automatically after 60 s if the user skips back to the operational display mode from the navigation and editing view.

Parameters which can always be modified via the local display

Certain parameters that do not affect the measurement are excepted from parameter write protection via the local display. Despite the user-specific access code, they can always be modified, even if the other parameters are locked.

Defining the access code via the web browser





1. Navigate to the **Define access code** parameter (→  135).
 2. Define a 16-digit (max.) numeric code as the access code.
 3. Enter the access code again in the **Confirm access code** parameter (→  135) to confirm.
 - ↳ The web browser switches to the login page.
-  ▪ Disabling parameter write protection via access code →  80.
 - If the access code is lost: Resetting the access code →  142.
 - The **Access status** parameter shows which user role the user is currently logged in with.
 - Navigation path: Operation → Access status
 - User roles and their access rights →  80

If no action is performed for 10 minutes, the web browser automatically returns to the login page.

Resetting the access code

If you misplace the user-specific access code, it is possible to reset the code to the factory setting. A reset code must be entered for this purpose. The user-specific access code can then be defined again afterwards.

Via Web browser, FieldCare, DeviceCare (via CDI-RJ45 service interface), fieldbus

-  You can only obtain a reset code from your local Endress+Hauser service organization. The code must be calculated explicitly for every device.
1. Note down the serial number of the device.
 2. Read off the **Operating time** parameter.
 3. Contact the local Endress+Hauser service organization and tell them the serial number and the operating time.
 - ↳ Get the calculated reset code.
 4. Enter the reset code in the **Reset access code** parameter (→  136).
 - ↳ The access code has been reset to the factory setting **0000**. It can be redefined →  141.
-  For IT security reasons, the calculated reset code is only valid for 96 hours from the specified operating time and for the specific serial number. If you cannot return to the device within 96 hours, you should either increase the operating time you read out by a few days or switch off the device.

10.8.2 Write protection via write protection switch

Unlike parameter write protection via a user-specific access code, this allows the user to lock write access to the entire operating menu - apart from the **"Contrast display" parameter**.

The parameter values are now read only and cannot be edited any more (exception "Contrast display" parameter):
Via local display

Proline 500 – digital

Enable/disable write protection

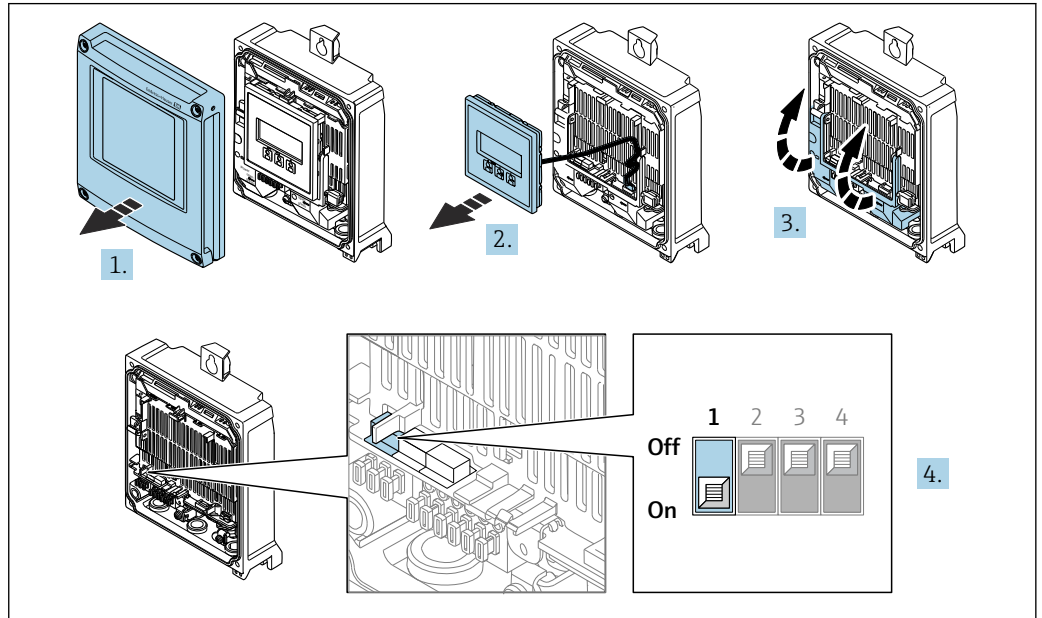

A0029673

1. Open the housing cover.
2. Remove the display module.
3. Fold open the terminal cover.
4. **Enable or disable write protection:**

Setting the write protection (WP) switch on the main electronics module to the **ON** position enables hardware write protection/setting to **OFF** (factory setting) disables hardware write protection.

↳ In the **Locking status** parameter, the **Hardware locked** option is displayed → 145. When hardware write protection is enabled, the  symbol appears in the header of the measured value display and in the navigation view in front of the parameters.

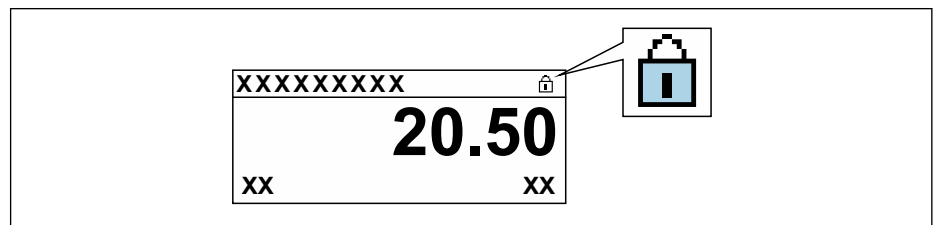

A0029425

5. Insert the display module.
6. Close the housing cover.
7. **NOTICE**

Excessive tightening torque applied to the fixing screws!

Risk of damaging the plastic transmitter.

- ▶ Tighten the fixing screws as per the tightening torque: 2.5 Nm (1.8 lbf ft)

Tighten the fixing screws.

Proline 500

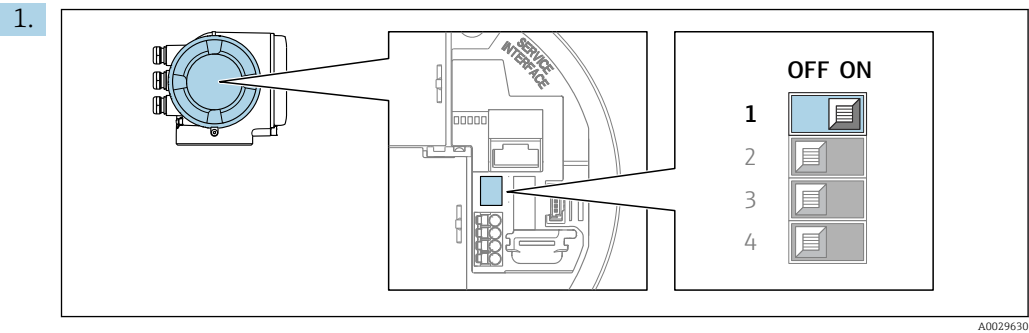

Setting the write protection (WP) switch on the main electronics module to the **ON** position enables hardware write protection.

- ↳ In the **Locking status** parameter, the **Hardware locked** option is displayed → 145. In addition, on the local display the  symbol appears in front of the parameters in the header of the operational display and in the navigation view.

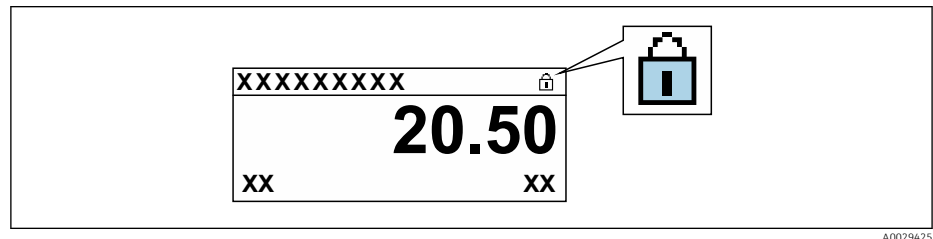

2. Setting the write protection (WP) switch on the main electronics module to the **OFF** position (factory setting) disables hardware write protection.

- ↳ No option is displayed in the **Locking status** parameter → 145. On the local display, the  symbol disappears from in front of the parameters in the header of the operational display and in the navigation view.





11 Operation

11.1 Reading the device locking status

Device active write protection: **Locking status** parameter

Operation → Locking status

Function scope of the "Locking status" parameter





Options	Description
None	The access authorization displayed in the Access status parameter applies →  80. Only appears on local display.
Hardware locked	The DIP switch for hardware locking is activated on the PCB board. This locks write access to the parameters (e.g. via local display or operating tool) →  142.
CT active - all parameters	The DIP switch for custody transfer mode is activated on the PCB board. Locks the parameters that are relevant for custody transfer and also parameters that are predefined by Endress+Hauser and are not relevant for custody transfer (e.g. on local display or operating tool).  For detailed information on custody transfer mode, see the Special Documentation for the device
CT active - defined parameters	The DIP switch for the custody transfer mode is activated on the PCB board. Only locks the parameters that are relevant for custody transfer (e.g. on the local display or operating tool).  For detailed information on custody transfer mode, see the Special Documentation for the device
Temporarily locked	Write access to the parameters is temporarily locked on account of internal processes running in the device (e.g. data upload/download, reset, etc.). Once the internal processing has been completed, the parameters can be changed again.

11.2 Reading off measured values

With the **Measured values** submenu, it is possible to read all the measured values.

Navigation

"Diagnostics" menu → Measured values

▶ Measured values	
▶ Process variables	→  145
▶ Input values	→  147
▶ Output values	→  148
▶ Totalizers	→  150

11.2.1 "Process variables" submenu

The **Process variables** submenu contains all the parameters needed to display the current measured values for each process variable.

Navigation

"Diagnostics" menu → Measured values → Process variables

► Process variables	
Volume flow	→ ⓘ 146
Mass flow	→ ⓘ 146
Corrected volume flow	→ ⓘ 146
Flow velocity	→ ⓘ 146
Conductivity	→ ⓘ 146
Corrected conductivity	→ ⓘ 146
Temperature	→ ⓘ 147
Density	→ ⓘ 147

Parameter overview with brief description

Parameter	Prerequisite	Description	User interface
Volume flow	–	Displays the volume flow that is currently measured. <i>Dependency</i> The unit is taken from: Volume flow unit parameter (→ ⓘ 101)	Signed floating-point number
Mass flow	–	Displays the mass flow that is currently calculated. <i>Dependency</i> The unit is taken from the Mass flow unit parameter (→ ⓘ 101).	Signed floating-point number
Corrected volume flow	–	Displays the corrected volume flow that is currently calculated. <i>Dependency</i> The unit is taken from: Corrected volume flow unit parameter (→ ⓘ 102)	Signed floating-point number
Flow velocity	–	Displays the flow velocity that is currently calculated.	Signed floating-point number
Conductivity	–	Displays the conductivity that is currently measured. <i>Dependency</i> The unit is taken from the Conductivity unit parameter (→ ⓘ 101).	Signed floating-point number
Corrected conductivity	One of the following conditions is met: <ul style="list-style-type: none"> ■ Order code for "Sensor option", option CI "Medium temperature measurement" or ■ The temperature is read into the flowmeter from an external device. 	Displays the conductivity currently corrected. <i>Dependency</i> The unit is taken from: Conductivity unit parameter (→ ⓘ 101)	Positive floating-point number

Parameter	Prerequisite	Description	User interface
Temperature	One of the following conditions is met: <ul style="list-style-type: none"> Order code for "Sensor option", option CI "Medium temperature measurement" or The temperature is read into the flowmeter from an external device. 	Displays the temperature that is currently calculated. <i>Dependency</i> The unit is taken from: Temperature unit parameter (→ 101)	Positive floating-point number
Density	–	Displays the current fixed density or density read in from an external device. <i>Dependency</i> The unit is taken from: Density unit parameter	Signed floating-point number

11.2.2 "Input values" submenu

The **Input values** submenu guides you systematically to the individual input values.

Navigation

"Diagnostics" menu → Measured values → Input values

▶ Input values	
▶ Current input 1 to n	→ 147
▶ Status input 1 to n	→ 147

Input values of current input

The **Current input 1 to n** submenu contains all the parameters needed to display the current measured values for every current input.

Navigation

"Diagnostics" menu → Measured values → Input values → Current input 1 to n

▶ Current input 1 to n	
Measured values 1 to n	→ 147
Measured current 1 to n	→ 147

Parameter overview with brief description

Parameter	Description	User interface
Measured values 1 to n	Displays the current input value.	Signed floating-point number
Measured current 1 to n	Displays the current value of the current input.	0 to 22.5 mA

Input values of status input

The **Status input 1 to n** submenu contains all the parameters needed to display the current measured values for every status input.

Navigation

"Diagnostics" menu → Measured values → Input values → Status input 1 to n

▶ Status input 1 to n

Value status input

→ ⓘ 148

Parameter overview with brief description

Parameter	Description	User interface	Factory setting
Value status input	Shows the current input signal level.	<ul style="list-style-type: none"> ▪ High ▪ Low 	Low

11.2.3 Output values

The **Output values** submenu contains all the parameters needed to display the current measured values for every output.

Navigation

"Diagnostics" menu → Measured values → Output values

▶ Output values

▶ Current output 1 to n

→ ⓘ 148

▶ Pulse/frequency/switch output 1 to n

→ ⓘ 149

▶ Relay output 1 to n

→ ⓘ 149

▶ Double pulse output

→ ⓘ 150

Output values of current output

The **Value current output** submenu contains all the parameters needed to display the current measured values for every current output.

Navigation

"Diagnostics" menu → Measured values → Output values → Value current output 1 to n

▶ Current output 1 to n

Output current

→ ⓘ 149

Measured current

→ ⓘ 149

Parameter overview with brief description

Parameter	Description	User interface
Output current	Displays the current value currently calculated for the current output.	3.59 to 22.5 mA
Measured current	Displays the current value currently measured for the current output.	0 to 30 mA

Output values for pulse/frequency/switch output

The **Pulse/frequency/switch output 1 to n** submenu contains all the parameters needed to display the current measured values for every pulse/frequency/switch output.

Navigation

"Diagnostics" menu → Measured values → Output values → Pulse/frequency/switch output 1 to n

▶ **Pulse/frequency/switch output 1 to n**

Output frequency	→ ⓘ 149
Pulse output	→ ⓘ 149
Switch state	→ ⓘ 149

Parameter overview with brief description

Parameter	Prerequisite	Description	User interface
Output frequency	In the Operating mode parameter, the Frequency option is selected.	Displays the value currently measured for the frequency output.	0.0 to 12 500.0 Hz
Pulse output	The Pulse option is selected in the Operating mode parameter parameter.	Displays the pulse frequency currently output.	Positive floating-point number
Switch state	The Switch option is selected in the Operating mode parameter.	Displays the current switch output status.	<ul style="list-style-type: none"> ▪ Open ▪ Closed

Output values for relay output

The **Relay output 1 to n** submenu contains all the parameters needed to display the current measured values for every relay output.

Navigation

"Diagnostics" menu → Measured values → Output values → Relay output 1 to n

▶ **Relay output 1 to n**

Switch state	→ ⓘ 150
Switch cycles	→ ⓘ 150
Max. switch cycles number	→ ⓘ 150

Parameter overview with brief description

Parameter	Description	User interface
Switch state	Indicates the current switch state of the output.	<ul style="list-style-type: none"> ▪ Open ▪ Closed
Switch cycles	Shows number of all performed switch cycles.	Positive integer
Max. switch cycles number	Shows the maximal number of guaranteed switch cycles.	Positive integer

Output values for double pulse output

The **Double pulse output** submenu contains all the parameters needed to display the current measured values for every double pulse output.

Navigation

"Diagnostics" menu → Measured values → Output values → Double pulse output

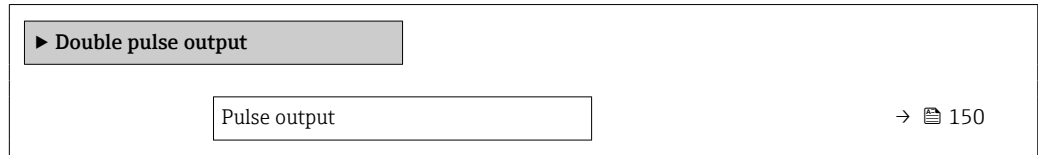

Parameter overview with brief description

Parameter	Description	User interface
Pulse output	Shows the currently output pulse frequency.	Positive floating-point number

11.2.4 Totalizer

The **Totalizer** submenu contains all the parameters needed to display the current measured values for every totalizer.

Navigation

"Diagnostics" menu → Measured values → Totalizer

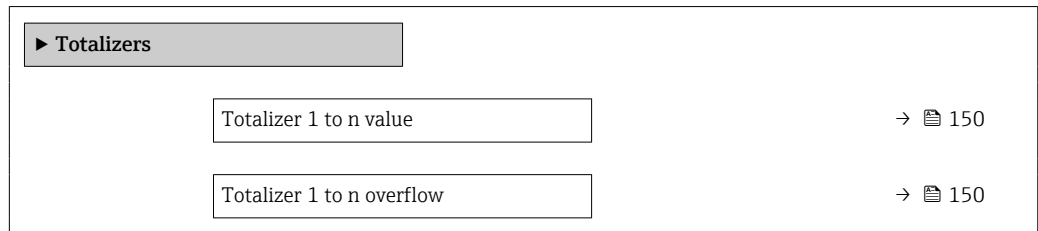



Parameter overview with brief description

Parameter	Description	User interface	Factory setting
Totalizer value	Displays the current totalizer counter value.	Signed floating-point number	0
Totalizer overflow	Displays the current totalizer overflow.	-32 000.0 to 32 000.0	0

11.3 Adapting the measuring device to the process conditions

The following are available for this purpose:

- Basic settings using the **Setup** menu (→  96)
- Advanced settings using the **Advanced setup** submenu (→  122)

11.4 Performing a totalizer reset

The totalizers are reset in the **Operation** submenu:



- Control Totalizer
- Reset all totalizers

Navigation

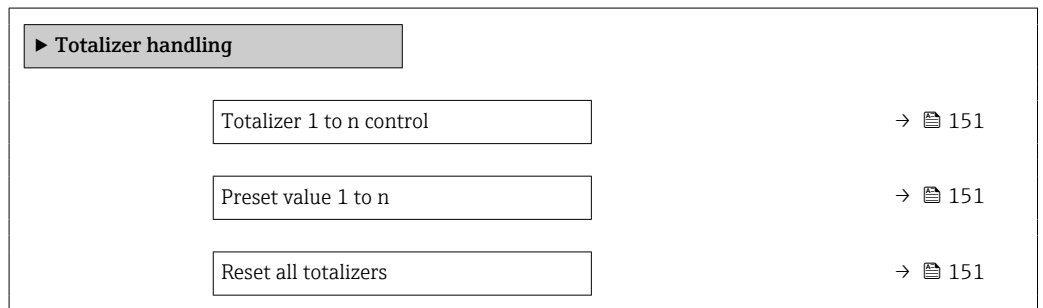
"Operation" menu → Totalizer handling



Parameter overview with brief description

Parameter	Prerequisite	Description	Selection / User entry	Factory setting
Totalizer 1 to n control	A process variable is selected in the Assign process variable parameter (→  123) of the Totalizer 1 to n submenu.	Operate the totalizer.	<ul style="list-style-type: none"> ■ Totalize ■ Reset + hold * ■ Preset + hold * ■ Reset + totalize ■ Preset + totalize * ■ Hold * 	Totalize
Preset value 1 to n	A process variable is selected in the Assign process variable parameter (→  123) of the Totalizer 1 to n submenu.	Specify start value for totalizer. <i>Dependency</i> 	Signed floating-point number	01
Reset all totalizers	–	Reset all totalizers to 0 and start.	<ul style="list-style-type: none"> ■ Cancel ■ Reset + totalize 	Cancel

* Visibility depends on order options or device settings

11.4.1 Function scope of "Control Totalizer" parameter

Options	Description
Totalize	The totalizer is started or continues running.
Reset + hold	The totaling process is stopped and the totalizer is reset to 0.
Preset + hold ¹⁾	The totaling process is stopped and the totalizer is set to its defined start value from the Preset value parameter.
Reset + totalize	The totalizer is reset to 0 and the totaling process is restarted.

Options	Description
Preset + totalize ¹⁾	The totalizer is set to the defined start value in the Preset value parameter and the totaling process is restarted.
Hold	Totalizing is stopped.

1) Visible depending on the order options or device settings

11.4.2 Function range of "Reset all totalizers" parameter

Options	Description
Cancel	No action is executed and the user exits the parameter.
Reset + totalize	Resets all totalizers to 0 and restarts the totaling process. This deletes all the previously aggregated flow values.

12 Diagnostics and troubleshooting

12.1 General troubleshooting

For local display

Fault	Possible causes	Remedial action
Local display is dark, but signal output is within the valid range	The cable of the display module is not plugged in correctly.	Insert the plug correctly into the main electronics module and display module.
Local display dark and no output signals	Supply voltage does not match the voltage specified on the nameplate.	Apply the correct supply voltage .
Local display dark and no output signals	Supply voltage has incorrect polarity.	Reverse polarity of supply voltage.
Local display dark and no output signals	No contact between connecting cables and terminals.	Check the electrical contact between the cable and terminals and correct if necessary.
Local display dark and no output signals	<ul style="list-style-type: none"> ▪ Terminals are not plugged into the I/O electronics module correctly. ▪ Terminals are not plugged into the main electronics module correctly. 	Check terminals.
Local display dark and no output signals	<ul style="list-style-type: none"> ▪ I/O electronics module is defective. ▪ Main electronics module is defective. 	Order spare part → ☰ 175.
Local display dark and no output signals	The connector between the main electronics module and display module is not plugged in correctly.	Check the connection and correct if necessary.
Local display dark and no output signals	The connecting cable is not plugged in correctly.	<ol style="list-style-type: none"> 1. Check the connection of the electrode cable and correct if necessary. 2. Check the connection of the coil current cable and correct if necessary.
Local display cannot be read, but signal output is within the valid range	Display is set too bright or too dark.	<ul style="list-style-type: none"> ▪ Set the display brighter by simultaneously pressing ☐ + ☐. ▪ Set the display darker by simultaneously pressing ☐ + ☐.
Local display is dark, but signal output is within the valid range	Display module is defective.	Order spare part → ☰ 175.
Backlighting of local display is red	Diagnostic event with "Alarm" diagnostic behavior has occurred.	Take remedial actions → ☰ 163
Text on local display appears in a language that cannot be understood.	The selected operating language cannot be understood.	<ol style="list-style-type: none"> 1. Press ☐ + ☐ for 2 s ("home position"). 2. Press ☐. 3. Configure the required language in the Display language parameter (→ ☰ 117).
Message on local display: "Communication Error" "Check Electronics"	Communication between the display module and the electronics is interrupted.	<ul style="list-style-type: none"> ▪ Check the cable and the connector between the main electronics module and display module. ▪ Order spare part → ☰ 175.

For output signals

Fault	Possible causes	Remedial action
Signal output outside the valid range	Main electronics module is defective.	Order spare part → ☰ 175.
Device shows correct value on local display, but signal output is incorrect, though in the valid range.	Parameter configuration error	Check and adjust parameter configuration.
Device is measuring incorrectly.	Configuration error or device is operated outside the application.	<ol style="list-style-type: none"> 1. Check and correct parameter configuration. 2. Observe limit values specified in the "Technical Data".

For access

Fault	Possible causes	Remedial action
Write access to parameters is not possible.	Hardware write protection is enabled.	Set the write protection switch on the main electronics module to the OFF position → ☰ 142.
Write access to parameters is not possible.	Current user role has limited access authorization.	1. Check user role → ☰ 80. 2. Enter correct customer-specific access code → ☰ 80.
Connection to the web server is not possible.	Web server is disabled.	Use the "FieldCare" or "DeviceCare" operating tool to check if the web server of the device is enabled and enable if necessary → ☰ 87.
	The Ethernet interface on the PC is incorrectly configured.	<ul style="list-style-type: none"> ▶ Check the properties of the Internet protocol (TCP/IP) → ☰ 83. ▶ Check the network settings with the IT manager.
Connection to the web server is not possible.	WLAN access data are incorrect.	<ul style="list-style-type: none"> ▪ Check WLAN network status. ▪ Log on to the device again using WLAN access data. ▪ Check that WLAN is enabled on the measuring instrument and operating unit → ☰ 83.
	WLAN communication is disabled.	–
Unable to connect to web server, FieldCare or DeviceCare.	WLAN network is not available.	<ul style="list-style-type: none"> ▪ Check if WLAN reception is present: LED on display module is lit blue. ▪ Check if WLAN connection is enabled: LED on display module flashes blue. ▪ Switch on instrument function.
Network connection not present or unstable	WLAN network is weak.	<ul style="list-style-type: none"> ▪ Operating unit outside reception range: Check network status on operating unit. ▪ To improve network performance, use an external WLAN antenna.
	Parallel WLAN and Ethernet communication	<ul style="list-style-type: none"> ▪ Check network settings. ▪ Temporarily enable only the WLAN as an interface.
Web browser is frozen and operation no longer possible	Data transfer is active.	Wait until data transfer or current action is finished.
	Connection lost	<ul style="list-style-type: none"> ▶ Check cable connection and power supply. ▶ Refresh the web browser and restart if necessary.
Display of web browser content is difficult to read or incomplete.	Web browser version used is not optimal.	<ul style="list-style-type: none"> ▶ Use correct web browser version → ☰ 82. ▶ Empty the web browser cache. ▶ Restart the web browser.
	Unsuitable view settings.	Change the font size/display ratio of the web browser.
Incomplete or no display of content in the web browser	<ul style="list-style-type: none"> ▪ JavaScript is not enabled. ▪ JavaScript cannot be enabled. 	<ul style="list-style-type: none"> ▶ Enable JavaScript. ▶ Enter http://XXX.XXX.X.XX/servlet/basic.html as the IP address.
Operation with FieldCare or DeviceCare via service interface CDI-RJ45 (port 8000) is not possible.	Firewall of the PC or network is blocking communication.	Depending on the settings of the firewall used on the PC or in the network, the firewall must be adapted or disabled to allow FieldCare/ DeviceCare access.
Flashing the firmware with FieldCare or DeviceCare via service interface CDI-RJ45 (port 8000 or TFTP ports) is not possible.	Firewall of the PC or network is blocking communication.	Depending on the settings of the firewall used on the PC or in the network, the firewall must be adapted or disabled to allow FieldCare/ DeviceCare access.

12.2 Diagnostic information via LEDs

12.2.1 Transmitter

Proline 500 – digital

Various LEDs in the transmitter provide information on the device status.

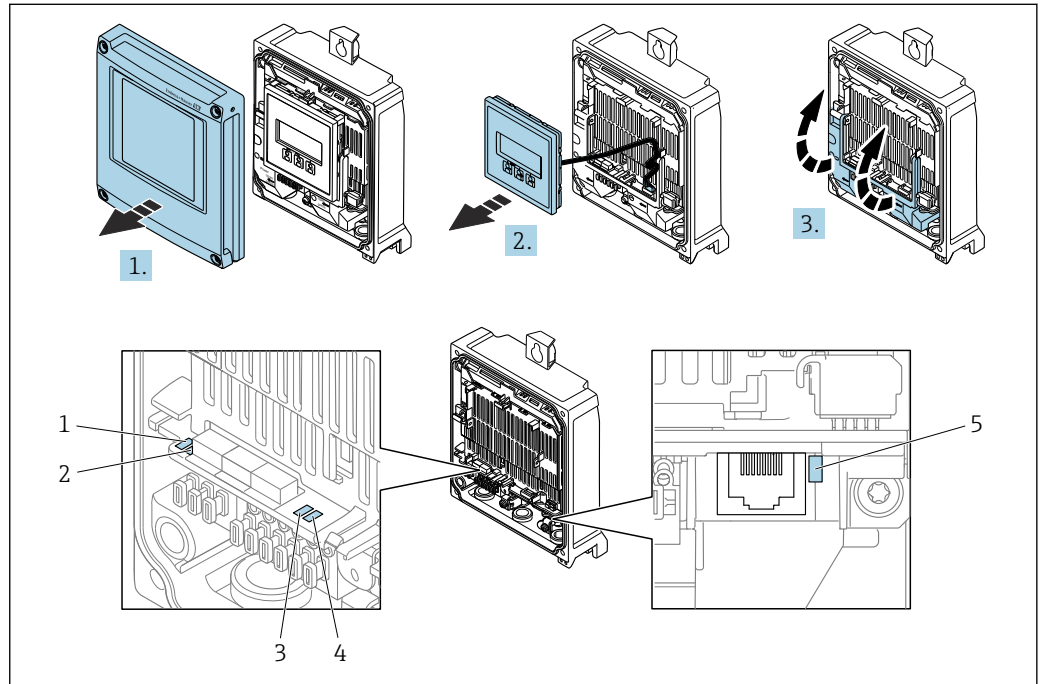

A0029689

- 1 Supply voltage
- 2 Device status
- 3 Not used
- 4 Communication
- 5 Service interface (CDI) active

1. Open the housing cover.
2. Remove the display module.
3. Fold open the terminal cover.

Proline 500

Various LEDs in the transmitter provide information on the device status.

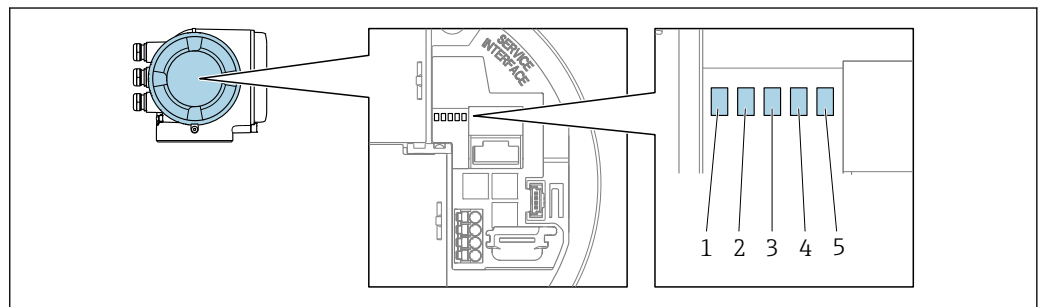

A0029629

- 1 Supply voltage
- 2 Device status
- 3 Network status
- 4 Port 1: communication
- 5 Port 2 active: service interface (CDI)

LED	Color	Meaning
1 Supply voltage	Off	Supply voltage is off or too low.
	Green	Supply voltage is OK.
2 Device status (normal operation)	Off	Firmware error
	Green	Device status is OK.
	Flashing green	Device is not configured.
	Red	A diagnostic event with "Alarm" diagnostic behavior has occurred.
	Flashing red	A diagnostic event with "Warning" diagnostic behavior has occurred.
2 Device status (during start-up)	Flashes red slowly	If > 30 seconds: problem with the boot loader.
	Flashes red quickly	If > 30 seconds: compatibility problem when reading the firmware.
	Flashing red/green	The device restarts.
3 Network status	Off	<ul style="list-style-type: none"> ■ Device does not receive any Modbus TCP data. ■ No Modbus TCP client connected.
	Green	At least one Modbus TCP client is connected (Modbus TCP only).
	Flashing red	500 ms off, 500 ms on
4 Communication	Off	Communication not active.
	White	Communication active.
5 Service interface (CDI)	Off	Not connected or no connection established.
	Yellow	Connected and connection established.
	Flashing yellow	Service interface active.

12.2.2 Sensor connection housing

Proline 500 – digital

Various LEDs on the ISEM electronics unit (intelligent sensor electronics module) in the sensor connection housing provide information about the device status.

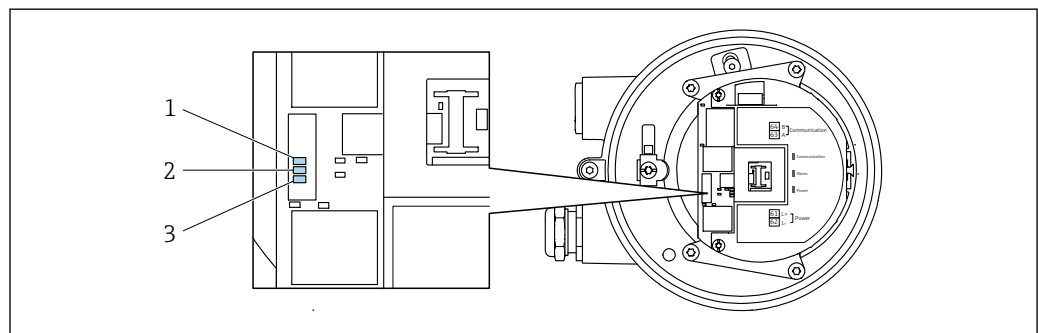

A0029699

- 1 Communication
- 2 Device status
- 3 Supply voltage

LED	Color	Meaning
1 Communication	White	Communication active.
2 Device status (normal operation)	Red	Fault
	Flashing red	Warning

LED	Color	Meaning
2 Device status (during start-up)	Flashes red slowly	If > 30 seconds: problem with the boot loader.
	Flashes red quickly	If > 30 seconds: compatibility problem when reading the firmware.
3 Supply voltage	Green	Supply voltage is OK.
	Off	Supply voltage is off or too low.

12.3 Diagnostic information on local display

12.3.1 Diagnostic message

Faults detected by the self-monitoring system of the measuring instrument are displayed as a diagnostic message in alternation with the operational display.

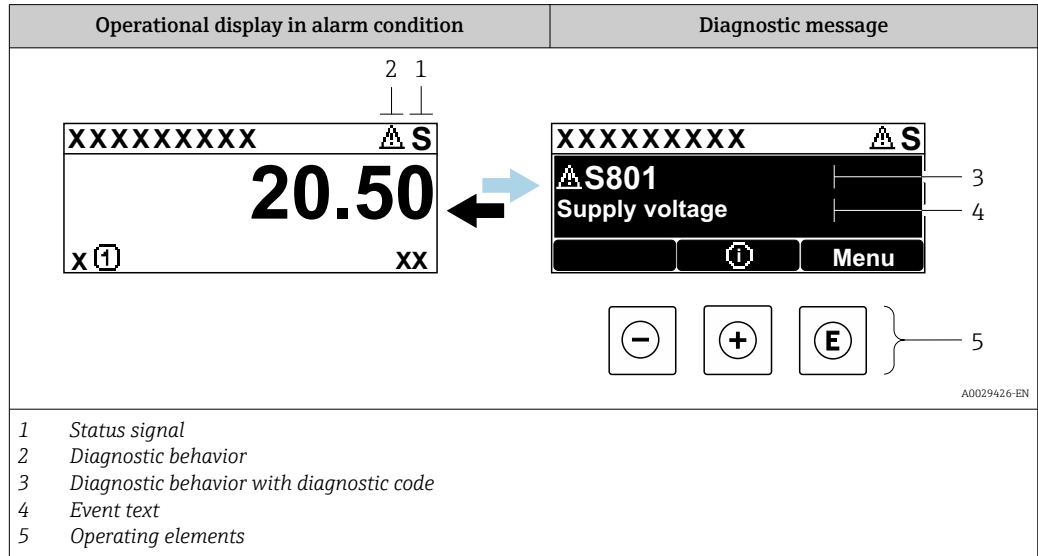

If two or more diagnostic events are pending simultaneously, only the message of the diagnostic event with the highest priority is shown.

- i Other diagnostic events that have occurred can be displayed in the **Diagnostics** menu:
 - Via parameter → 168
 - Via submenus → 168



Status signals

The status signals provide information on the state and reliability of the device by categorizing the cause of the diagnostic information (diagnostic event).

- i The status signals are categorized in accordance with VDI/VDE 2650 and NAMUR Recommendation NE 107:
 - F = Failure
 - C = Function Check
 - S = Out of Specification
 - M = Maintenance Required

Symbol	Meaning
F	Failure A device error has occurred. The measured value is no longer valid.
C	Function check The device is in the service mode (e.g. during a simulation).
S	Out of specification The device is being operated: Outside its technical specification limits (e.g. outside the process temperature range)
M	Maintenance required Maintenance is required. The measured value remains valid.



Diagnostic behavior

Symbol	Meaning
	Alarm <ul style="list-style-type: none"> ▪ Measurement is interrupted. ▪ Signal outputs and totalizers assume the defined alarm condition. ▪ A diagnostic message is generated.
	Warning <ul style="list-style-type: none"> ▪ Measurement is resumed. ▪ The signal outputs and totalizers are not affected. ▪ A diagnostic message is generated.

Diagnostic information

The fault can be identified using the diagnostic information. The short text helps you by providing information about the fault. In addition, the corresponding symbol for the diagnostic behavior is displayed in front of the diagnostic information on the local display.

Operating elements

Operating key	Meaning
	Plus key <i>In menu, submenu</i> Opens the message about the remedial measures.
	Enter key <i>In menu, submenu</i> Opens the operating menu.

12.3.2 Calling up remedial actions

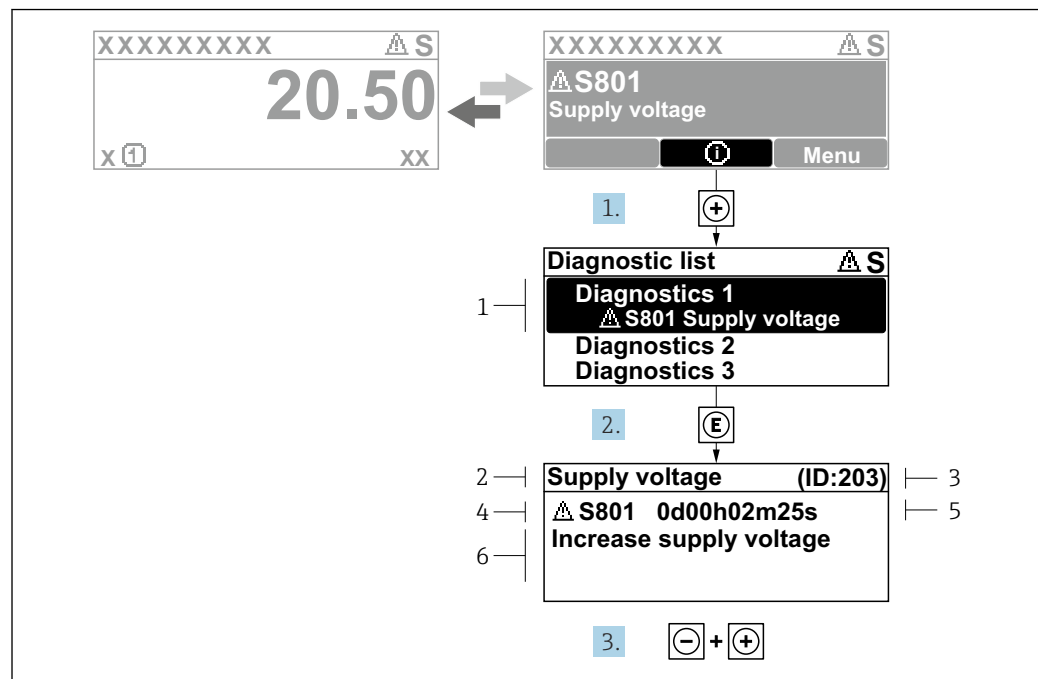

A0029431-EN

34 Message for remedial actions

- 1 Diagnostic information
- 2 Event text
- 3 Service ID
- 4 Diagnostic behavior with diagnostic code
- 5 Operating time of occurrence
- 6 Remedial actions

1. The user is in the diagnostic message.
Press \oplus (ⓘ symbol).
↳ The **Diagnostic list** submenu opens.
2. Select the desired diagnostic event with \oplus or \ominus and press \boxminus .
↳ The message about the remedial measures opens.
3. Press $\ominus + \oplus$ simultaneously.
↳ The message about the remedial measures closes.

The user is in the **Diagnostics** menu in the **Diagnostic list** submenu. A list of active diagnostics is displayed. The user can select a diagnostic event.

1. Press \boxminus .
↳ The message for the remedial actions for the selected diagnostic event opens.
2. Press $\ominus + \oplus$ simultaneously.
↳ The message about the remedial actions closes.

12.4 Diagnostic information in the web browser

12.4.1 Diagnostic options

Any faults detected by the measuring device are displayed in the Web browser on the home page once the user has logged on.

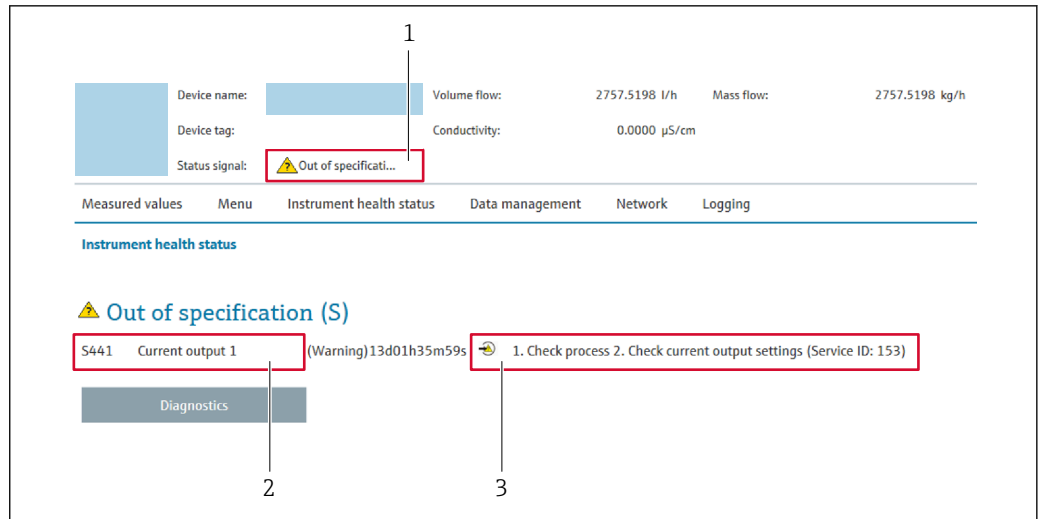

- 1 Status area with status signal
- 2 Diagnostic information
- 3 Remedial measures with service ID

i In addition, diagnostic events which have occurred can be shown in the **Diagnostics** menu:

- Via parameter → 168
- Via submenu → 168

Status signals

The status signals provide information on the state and reliability of the device by categorizing the cause of the diagnostic information (diagnostic event).

Symbol	Meaning
	Failure A device error has occurred. The measured value is no longer valid.
	Function check The device is in service mode (e.g. during a simulation).
	Out of specification The device is being operated: Outside its technical specification limits (e.g. outside the process temperature range)
	Maintenance required Maintenance is required. The measured value remains valid.

i The status signals are categorized in accordance with VDI/VDE 2650 and NAMUR Recommendation NE 107.

12.4.2 Calling up remedial actions

Remedial actions are provided for each diagnostic event to ensure that problems can be rectified quickly. These actions are displayed along with the diagnostic event and the related diagnostic information.

12.5 Diagnostic information in FieldCare or DeviceCare

12.5.1 Diagnostic options

Any faults detected by the measuring device are displayed on the home page of the operating tool once the connection has been established.

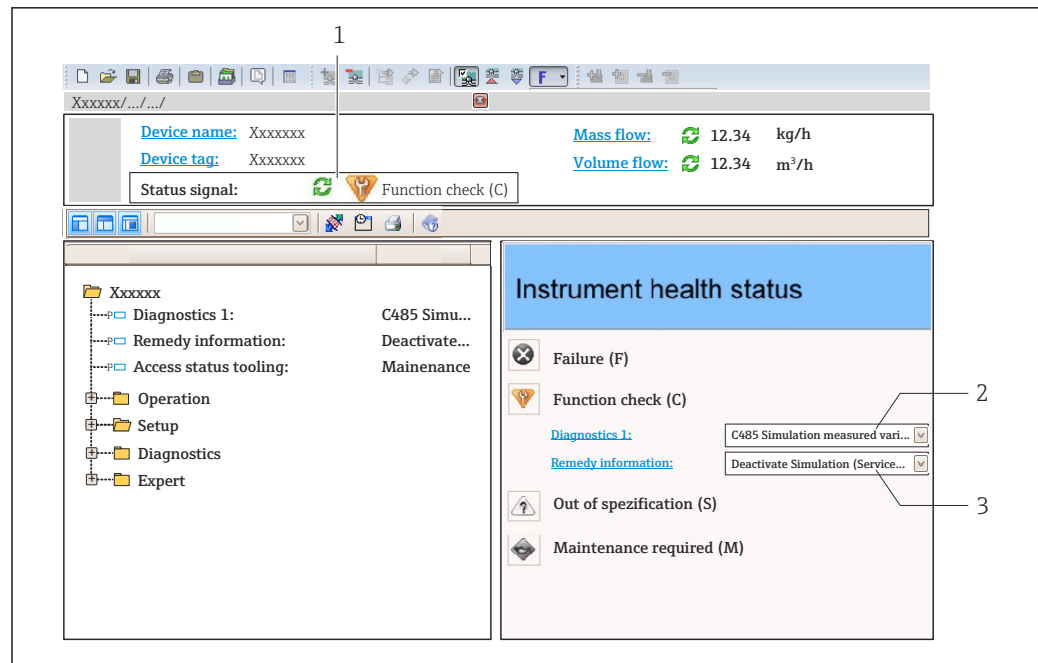

- 1 Status area with status signal → 158
 2 Diagnostic information → 159
 3 Remedial actions with service ID

i In addition, diagnostic events which have occurred can be shown in the **Diagnostics** menu:

- Via parameter → 168
- Via submenu → 168

Diagnostic information

The fault can be identified using the diagnostic information. The short text helps you by providing information about the fault. In addition, the corresponding symbol for the diagnostic behavior is displayed in front of the diagnostic information on the local display.

12.5.2 Calling up remedy information

Remedy information is provided for every diagnostic event to ensure that problems can be rectified quickly:

- On the home page
Remedy information is displayed in a separate field below the diagnostics information.
- In the **Diagnostics** menu
Remedy information can be called up in the working area of the user interface.

The user is in the **Diagnostics** menu.

1. Call up the desired parameter.
2. On the right in the working area, mouse over the parameter.
 - ↳ A tool tip with remedy information for the diagnostic event appears.

12.6 Diagnostic information via communication interface

12.6.1 Reading out diagnostic information

Diagnostic information can be read out via the Modbusregister addresses.

- Via register address **6821** (data type = string): diagnostic code, e.g. F270
- Via register address **6859** (data type = integer): diagnostic number, e.g. 270

 For an overview of diagnostic events with diagnosis number and diagnosis code
 →  163



12.6.2 Configuring error response mode

The error response mode for Modbus communication can be configured in the **Modbus configuration** submenu using 1 parameter.

Navigation path

Setup → Communication

Parameter overview with brief description

Parameter	Description	Selection	Factory setting
Failure mode	Select measured value output behavior when a diagnostic message occurs via Modbus communication.  The effect of this parameter depends on the option selected in the Assign diagnostic behavior parameter.	<ul style="list-style-type: none"> ▪ NaN value ▪ Last valid value  NaN ≙ not a number	NaN value

12.7 Adapting the diagnostic information

12.7.1 Adapting the diagnostic behavior

Each item of diagnostic information is assigned a specific diagnostic behavior at the factory. The user can change this assignment for specific diagnostic information in the **Diagnostic behavior** submenu.

Expert → System → Diagnostic handling → Diagnostic behavior

You can assign the following options to the diagnostic number as the diagnostic behavior:

Options	Description
Alarm	The background lighting changes to red.
Warning	
Logbook entry only	The device continues to measure. The diagnostic message is only displayed in the Event logbook submenu (Event list submenu) and is not displayed in alternating sequence with the operational display.
Off	The diagnostic event is ignored, and no diagnostic message is generated or entered.

12.8 Overview of diagnostic information

 The amount of diagnostic information and the number of measured variables affected increase if the measuring device has one or more application packages.

Diagnostic number	Short text	Remedy instructions	Status signal [from the factory]	Diagnostic behavior [from the factory]
Diagnostic of sensor				
043	Sensor 1 short circuit detected	1. Check sensor cable and sensor 2. Execute Heartbeat Verification 3. Replace sensor cable or sensor	S	Warning ¹⁾
082	Data storage inconsistent	Check module connections	F	Alarm
083	Memory content inconsistent	1. Restart device 2. Restore S-DAT data 3. Replace S-DAT	F	Alarm
143	HBSI limit exceeded	1. Check if external magnetic interference is present 2. Check flow value 3. Replace sensor	M	Warning ¹⁾
168	Buildup limit exceeded	Clean measuring tube	M	Warning
169	Conductivity measurement failed	1. Check grounding conditions 2. Deactivate conductivity measurement	M	Warning
170	Coil resistance faulty	Check ambient and process temperature	F	Alarm
180	Temperature sensor defective	1. Check sensor connections 2. Replace sensor cable or sensor 3. Turn off temperature measurement	F	Warning
181	Sensor connection faulty	1. Check sensor cable and sensor 2. Execute Heartbeat Verification 3. Replace sensor cable or sensor	F	Alarm
Diagnostic of electronic				
201	Electronics faulty	1. Restart device 2. Replace electronics	F	Alarm
242	Firmware incompatible	1. Check firmware version 2. Flash or replace electronic module	F	Alarm
252	Module incompatible	1. Check electronic modules 2. Check if correct modules are available (e.g. NEx, Ex) 3. Replace electronic modules	F	Alarm
262	Module connection interrupted	1. Check or replace connection cable between sensor electronic module (ISEM) and main electronics 2. Check or replace ISEM or main electronics	F	Alarm
270	Main electronics defective	1. Restart device 2. Replace main electronic module	F	Alarm
271	Main electronics faulty	1. Restart device 2. Replace main electronic module	F	Alarm
272	Main electronics faulty	Restart device	F	Alarm
273	Main electronics defective	1. Pay attention to display emergency operation 2. Replace main electronics	F	Alarm
275	I/O module 1 to n defective	Change I/O module	F	Alarm
276	I/O module 1 to n faulty	1. Restart device 2. Change I/O module	F	Alarm
283	Memory content inconsistent	Restart device	F	Alarm

Diagnostic number	Short text	Remedy instructions	Status signal [from the factory]	Diagnostic behavior [from the factory]
302	Device verification active	Device verification in progress, please wait.	C	Warning ¹⁾
303	I/O 1 to n configuration changed	1. Apply I/O module configuration (parameter "Apply I/O configuration") 2. Afterwards reload device description and check wiring	M	Warning
311	Sensor electronics (ISEM) faulty	Maintenance required! Do not reset device	M	Warning
330	Flash file invalid	1. Update firmware of device 2. Restart device	M	Warning
331	Firmware update failed	1. Update firmware of device 2. Restart device	F	Warning
332	Writing in HistoROM backup failed	1. Replace user interface board 2. Ex d/XP: replace transmitter	F	Alarm
361	I/O module 1 to n faulty	1. Restart device 2. Check electronic modules 3. Change I/O module or main electronics	F	Alarm
372	Sensor electronics (ISEM) faulty	1. Restart device 2. Check if failure recurs 3. Replace sensor electronic module (ISEM)	F	Alarm
373	Sensor electronics (ISEM) faulty	Transfer data or reset device	F	Alarm
375	I/O- 1 to n communication failed	1. Restart device 2. Check if failure recurs 3. Replace module rack inclusive electronic modules	F	Alarm
376	Sensor electronics (ISEM) faulty	1. Replace sensor electronic module (ISEM) 2. Turn off diagnostic message	S	Warning ¹⁾
377	Electrode signal faulty	1. Activate empty pipe detection 2. Check partial filled pipe and installation direction 3. Check sensor cabling 4. Deactivate diagnostics 377	S	Warning ¹⁾
378	Supply voltage ISEM faulty	1. If available: Check connection cable between sensor and transmitter 2. Replace main electronic module 3. Replace sensor electronic module (ISEM)	F	Alarm
382	Data storage	1. Insert T-DAT 2. Replace T-DAT	F	Alarm
383	Memory content	Reset device	F	Alarm
387	HistoROM data faulty	Contact service	F	Alarm
Diagnostic of configuration				
410	Data transfer failed	1. Retry data transfer 2. Check connection	F	Alarm
412	Processing download	Download is being processed, please wait.	C	Warning
431	Trim 1 to n required	Carry out trim	M	Warning

Diagnostic number	Short text	Remedy instructions	Status signal [from the factory]	Diagnostic behavior [from the factory]
437	Parameterization incompatible	1. Update firmware 2. Execute factory reset	F	Alarm
438	Dataset different	1. Check dataset file 2. Check device parameterization 3. Download new device parameterization	M	Warning
441	Current output 1 to n saturated	1. Check current output settings 2. Check process	S	Warning ¹⁾
442	Frequency output 1 to n saturated	1. Check frequency output settings 2. Check process	S	Warning ¹⁾
443	Pulse output 1 to n saturated	1. Check pulse output settings 2. Check process	S	Warning ¹⁾
444	Current input 1 to n saturated	1. Check current input settings 2. Check connected device 3. Check process	S	Warning ¹⁾
453	Flow override active	Deactivate flow override	C	Warning
484	Failure mode simulation active	Deactivate simulation	C	Alarm
485	Process variable simulation active	Deactivate simulation	C	Warning
486	Current input 1 to n simulation active	Deactivate simulation	C	Warning
491	Current output 1 to n simulation active	Deactivate simulation	C	Warning
492	Frequency output 1 to n simulation active	Deactivate simulation frequency output	C	Warning
493	Pulse output 1 to n simulation active	Deactivate simulation pulse output	C	Warning
494	Switch output 1 to n simulation active	Deactivate simulation switch output	C	Warning
495	Diagnostic event simulation active	Deactivate simulation	C	Warning
496	Status input 1 to n simulation active	Deactivate status input simulation	C	Warning
502	CT activation/deactivation failed	Follow the sequence of the custody transfer activation/deactivation: First authorized user login, then set the DIP switch on the main electronic module	C	Warning
511	Sensor setting error	1. Check measuring period and integration time 2. Check sensor properties	C	Alarm
512	ECC recovery time exceeded	1. Check ECC recovery time 2. Turn off ECC	F	Alarm
520	I/O 1 to n hardware configuration invalid	1. Check I/O hardware configuration 2. Replace wrong I/O module 3. Plug the module of double pulse output on correct slot	F	Alarm
530	Electrode cleaning active	Switch off electrode cleaning	C	Warning
531	Empty pipe adjustment faulty	Execute EPD adjustment	S	Warning ¹⁾
537	Configuration	1. Check IP addresses in network 2. Change IP address	F	Warning





Diagnostic number	Short text	Remedy instructions	Status signal [from the factory]	Diagnostic behavior [from the factory]
540	Custody transfer mode failed	1. Power off device and toggle DIP switch 2. Deactivate custody transfer mode 3. Reactivate custody transfer mode 4. Check electronic components	F	Alarm
543	Double pulse output	1. Check process 2. Check pulse output settings	S	Warning ¹⁾
593	Double pulse output 1 simulation	Deactivate simulation pulse output	C	Warning
594	Relay output 1 to n simulation active	Deactivate simulation switch output	C	Warning
599	Custody transfer logbook full	1. Deactivate custody transfer mode 2. Clear custody transfer logbook (all 30 entries) 3. Activate custody transfer mode	F	Warning
Diagnostic of process				
803	Loop current 1 faulty	1. Check wiring 2. Change I/O module	F	Alarm
811	APL connection faulty	Connect field device only to APL spur port	F	Alarm
832	Electronics temperature too high	Reduce ambient temperature	S	Warning ¹⁾
833	Electronics temperature too low	Increase ambient temperature	S	Warning ¹⁾
834	Process temperature too high	Reduce process temperature	S	Warning ¹⁾
835	Process temperature too low	Increase process temperature	S	Warning ¹⁾
842	Process value below limit	Low flow cut off active! Check low flow cut off configuration	S	Warning ¹⁾
882	Input signal faulty	1. Check input signal parameterization 2. Check external device 3. Check process conditions	F	Alarm
937	Sensor symmetry	1. Eliminate external magnetic field near sensor 2. Turn off diagnostic message	S	Warning ¹⁾
938	Coil current not stable	1. Check if external magnetic interference is present 2. Perform Heartbeat Verification 3. Check flow value	F	Alarm ¹⁾
961	Electrode potential out of specification	1. Check process conditions 2. Check ambient conditions	S	Warning ¹⁾
962	Pipe empty	1. Perform full pipe adjustment 2. Perform empty pipe adjustment 3. Turn off empty pipe detection	S	Warning ¹⁾



1) Diagnostic behavior can be changed.

12.9 Pending diagnostic events

The **Diagnostics** menu allows the user to view the current diagnostic event and the previous diagnostic event separately.





 Accessing the remedial action for a diagnostic event:

- Via local display →  158
- Via web browser →  160
- Via "FieldCare" operating tool →  161
- Via "DeviceCare" operating tool →  161

 Other pending diagnostic events can be displayed in the **Diagnostic list** submenu →  168.

Navigation

"Diagnostics" menu

 Diagnostics	
Actual diagnostics	→  168
Previous diagnostics	→  168
Operating time from restart	→  168
Operating time	→  168

Parameter overview with brief description

Parameter	Prerequisite	Description	User interface
Actual diagnostics	A diagnostic event has occurred.	Shows the current occurred diagnostic event along with its diagnostic information.  If two or more messages occur simultaneously, the message with the highest priority is shown on the display.	Symbol for diagnostic behavior, diagnostic code and short message.
Previous diagnostics	Two diagnostic events have already occurred.	Shows the diagnostic event that occurred prior to the current diagnostic event along with its diagnostic information.	Symbol for diagnostic behavior, diagnostic code and short message.
Operating time from restart	–	Shows the time the device has been in operation since the last device restart.	Days (d), hours (h), minutes (m) and seconds (s)
Operating time	–	Indicates how long the device has been in operation.	Days (d), hours (h), minutes (m) and seconds (s)

12.10 Diagnostic list

Up to 5 currently pending diagnostic events are displayed in the **Diagnostic list** submenu along with the associated diagnostic information. If more than 5 diagnostic events are pending, the events with the highest priority are shown on the display.

Navigation path

Diagnostics → Diagnostic list

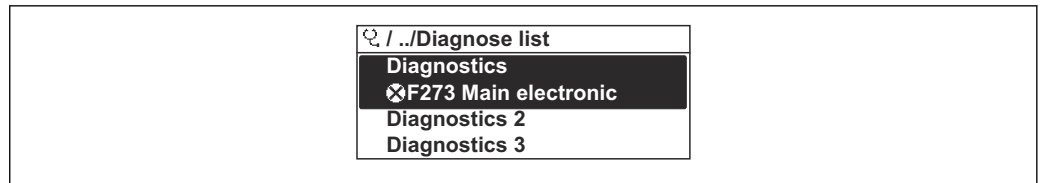

A0014006-EN

35 Using the example of the local display

Accessing the remedial action for a diagnostic event:

- Via local display → 158
- Via web browser → 160
- Via "FieldCare" operating tool → 161
- Via "DeviceCare" operating tool → 161

12.11 Event logbook

12.11.1 Reading out the event logbook

A chronological overview of the event messages that have occurred is provided in the **Event logbook** submenu.

Navigation path

Diagnostics menu → **Event logbook** submenu → Event logbook

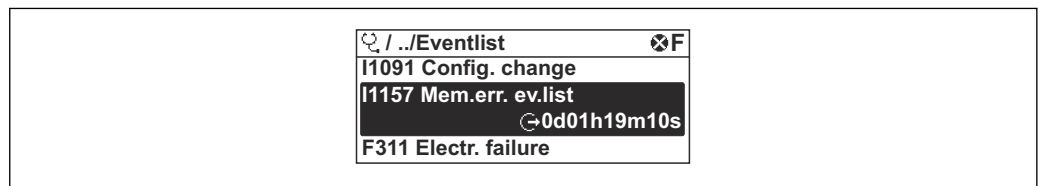

A0014008-EN

36 Using the example of the local display

- A maximum of 20 event messages can be displayed in chronological order.
- If the **Extended HistoROM** application package (order option) is enabled in the device, the event logbook can contain up to 100 entries.

The event history includes entries for:

- Diagnostic events → 163
- Information events → 170

In addition to the operating time when the event occurred, each event is also assigned a symbol that indicates whether the event has occurred or is finished:

- Diagnostic event
 - ⌚: Occurrence of the event
 - ⌚: End of the event
- Information event
 - ⌚: Occurrence of the event

Accessing the remedial action for a diagnostic event:

- Via local display → 158
- Via web browser → 160
- Via "FieldCare" operating tool → 161
- Via "DeviceCare" operating tool → 161

Filtering the displayed event messages → 170

12.11.2 Filtering the event logbook

Using the **Filter options** parameter you can define which category of event message is displayed in the **Events list** submenu.

Navigation path

Diagnostics → Event logbook → Filter options

Filter categories

- All
- Failure (F)
- Function check (C)
- Out of specification (S)
- Maintenance required (M)
- Information (I)

12.11.3 Overview of information events

Unlike a diagnostic event, an information event is displayed in the event logbook only and not in the diagnostic list.

Info number	Info name
I1000	----- (Device ok)
I1079	Sensor changed
I1089	Power on
I1090	Configuration reset
I1091	Configuration changed
I1092	HistoROM backup deleted
I1137	Electronics changed
I1151	History reset
I1155	Reset electronics temperature
I1156	Memory error trend
I1157	Memory error event list
I1256	Display: access status changed
I1278	I/O module restarted
I1335	Firmware changed
I1351	Empty pipe detection adjustment failure
I1353	Empty pipe detection adjustment ok
I1361	Web server: login failed
I1397	Fieldbus: access status changed
I1398	CDI: access status changed
I1443	Buildup thickness not determined
I1444	Device verification passed
I1445	Device verification failed
I1457	Measurement error verification failed
I1459	I/O module verification failed
I1461	Sensor verification failed
I1462	Sensor electronic module verific. failed
I1512	Download started
I1513	Download finished

Info number	Info name
I1514	Upload started
I1515	Upload finished
I1517	Custody transfer active
I1518	Custody transfer inactive
I1618	I/O module 2 replaced
I1619	I/O module 3 replaced
I1621	I/O module 4 replaced
I1622	Calibration changed
I1624	All totalizers reset
I1625	Write protection activated
I1626	Write protection deactivated
I1627	Web server: login successful
I1628	Display: login successful
I1629	CDI: login successful
I1631	Web server access changed
I1632	Display: login failed
I1633	CDI: login failed
I1634	Reset to factory settings
I1635	Reset to delivery settings
I1639	Max. switch cycles number reached
I1643	Custody transfer logbook cleared
I1649	Hardware write protection activated
I1650	Hardware write protection deactivated
I1651	Custody transfer parameter changed
I1712	New flash file received
I1725	Sensor electronic module (ISEM) changed
I1726	Configuration backup failed

12.12 Resetting the device

The entire device configuration or some of the configuration can be reset to a defined state with the **Device reset** parameter (→  136).

12.12.1 Function scope of the "Device reset" parameter

Options	Description
Cancel	No action is executed and the user exits the parameter.
To delivery settings	Every parameter for which a customer-specific default setting was ordered is reset to the customer-specific value. All other parameters are reset to the factory setting.
Restart device	The restart resets every parameter with data stored in volatile memory (RAM) to the factory setting (e.g. measured value data). The device configuration remains unchanged.

12.13 Device information



The **Device information** submenu contains all parameters that display different information for device identification.



Navigation

"Diagnostics" menu → Device information

▶ Device information	
Device tag	→ ⓘ 172
Serial number	→ ⓘ 172
Firmware version	→ ⓘ 172
Device name	→ ⓘ 172
Manufacturer	→ ⓘ 172
Order code	→ ⓘ 172
Extended order code 1	→ ⓘ 173
Extended order code 2	→ ⓘ 173
Extended order code 3	→ ⓘ 173
ENP version	→ ⓘ 173



Parameter overview with brief description

Parameter	Description	User interface	Factory setting
Device tag	Shows name of measuring point.	Character string comprising numbers, letters and special characters	Promag
Serial number	Shows the serial number of the measuring device.	Max. 11-digit character string comprising letters and numbers.	–
Firmware version	Shows the device firmware version installed.	Character string in the format xx.yy.zz	–
Device name	Shows the name of the transmitter.  The name can be found on the nameplate of the transmitter.	Promag 300/500	–
Manufacturer	Displays the manufacturer.	Character string comprising numbers, letters and special characters	Endress+Hauser
Order code	Shows the device order code.  The order code can be found on the nameplate of the sensor and transmitter in the "Order code" field.	Character string composed of letters, numbers and certain punctuation marks (e.g. /).	–

Parameter	Description	User interface	Factory setting
Extended order code 1	Shows the 1st part of the extended order code.  The extended order code can also be found on the nameplate of the sensor and transmitter in the "Ext. ord. cd." field.	Character string	–
Extended order code 2	Shows the 2nd part of the extended order code.  The extended order code can also be found on the nameplate of the sensor and transmitter in the "Ext. ord. cd." field.	Character string	–
Extended order code 3	Shows the 3rd part of the extended order code.  The extended order code can also be found on the nameplate of the sensor and transmitter in the "Ext. ord. cd." field.	Character string	–
ENP version	Shows the version of the electronic nameplate (ENP).	Character string	2.02.00

12.14 Firmware history

Release date	Firmware version	Order code for "Firmware version"	Firmware Changes	Documentation type	Documentation
09.2025	01.00.zz	Option 62	-	Operating Instructions	BA02394D/06/EN/01.25

-  It is possible to flash the firmware to the current version or an existing previous version via the service interface. For the compatibility of the firmware version, see the "Device history and compatibility" section
-  For the compatibility of the firmware version with the installed device description files and operating tools, observe the information about the device in the "Manufacturer's information" document.
-  The manufacturer's information is available:
 - In the Download Area of the Endress+Hauser Web site: www.endress.com → Downloads
 - Specify the following details:
 - Product root: e.g. 5H5B
The product root is the first part of the order code: see the nameplate on the device.
 - Text search: Manufacturer's information
 - Media type: Documentation – Technical Documentation

13 Maintenance

13.1 Maintenance tasks

No special maintenance work is required.

13.1.1 Cleaning

Cleaning of surfaces not in contact with the medium

1. Recommendation: Use a lint-free cloth that is either dry or slightly dampened using water.
2. Do not use sharp objects or aggressive cleaning agents that could damage surfaces (e.g. displays, housing) and seals.
3. Do not use high-pressure steam.
4. Ensure compliance with the protection class of the device.

NOTICE

Cleaning agents can damage the surfaces!

Incorrect cleaning agents can damage the surfaces!

- ▶ Do not use cleaning agents containing concentrated mineral acids, alkalis or organic solvents e.g. benzyl alcohol, methylene chloride, xylene, concentrated glycerol cleaners or acetone.

Cleaning of surfaces in contact with the medium

Note the following for cleaning and sterilization in place (CIP/SIP):

- Use only cleaning agents to which the materials in contact with the medium are sufficiently resistant.
- Observe the permitted maximum medium temperature.

13.1.2 Replacing seals

The sensor's seals (particularly aseptic molded seals) must be replaced periodically.

The interval between changes depends on the frequency of the cleaning cycles, the cleaning temperature and the medium temperature.

Replacement seals (accessory part) →  208

13.2 Measuring and test equipment

Endress+Hauser offers a variety of measuring and testing equipment, such as Netilion or device tests.

 Your Endress+Hauser Sales Center can provide detailed information on the services.

List of some of the measuring and testing equipment: →  179

13.3 Maintenance services

Endress+Hauser offers a wide variety of services for maintenance such as recalibration, maintenance service or device tests.

 Your Endress+Hauser Sales Center can provide detailed information on the services.

14 Repair

14.1 General notes

14.1.1 Repair and conversion concept

The Endress+Hauser repair and conversion concept provides for the following:

- The measuring devices have a modular design.
- Spare parts are grouped into logical kits with the associated Installation Instructions.
- Repairs are carried out by Endress+Hauser Service or by appropriately trained customers.
- Certified devices can only be converted to other certified devices by Endress+Hauser Service or at the factory.

14.1.2 Notes for repair and conversion



For repair and conversion of a measuring device, observe the following notes:

- ▶ Use only original Endress+Hauser spare parts.
- ▶ Carry out the repair according to the Installation Instructions.
- ▶ Observe the applicable standards, federal/national regulations, Ex documentation (XA) and certificates.
- ▶ Document all repairs and conversions and enter the details in Netilion Analytics.

14.2 Spare parts

Device Viewer (www.endress.com/deviceviewer):

All the spare parts for the measuring device, along with the order code, are listed here and can be ordered. If available, users can also download the associated Installation Instructions.

-  Measuring device serial number:
 - Is located on the nameplate of the device.
 - Can be read out via the **Serial number** parameter (→  172) in the **Device information** submenu.

14.3 Repair services

Endress+Hauser offers a wide range of services.

-  Your Endress+Hauser Sales Center can provide detailed information on the services.

14.4 Return

The requirements for safe device return can vary depending on the device type and national legislation.

1. Refer to the web page for information: <https://www.endress.com>
2. If returning the device, pack the device in such a way that it is reliably protected against impact and external influences. The original packaging offers the best protection.

14.5 Disposal

 If required by the Directive 2012/19/EU on waste electrical and electronic equipment (WEEE), the product is marked with the depicted symbol in order to minimize the disposal of WEEE as unsorted municipal waste. Do not dispose of products bearing this marking as unsorted municipal waste. Instead, return them to the manufacturer for disposal under the applicable conditions.

14.5.1 Removing the measuring instrument

1. Switch off the device.

 **WARNING**

Danger to persons from process conditions!

- ▶ Beware of hazardous process conditions such as pressure in the measuring instrument, high temperatures or aggressive media.

2. Carry out the installation and connection steps from the "Installing the device" and "Connecting the device" sections in reverse order. Observe the safety instructions.

14.5.2 Disposing of the measuring instrument

 **WARNING**

Danger to personnel and environment from fluids that are hazardous to health.

- ▶ Ensure that the measuring device and all cavities are free of fluid residues that are hazardous to health or the environment, e.g. substances that have permeated into crevices or diffused through plastic.

Observe the following notes during disposal:













- ▶ Observe valid federal/national regulations.
- ▶ Ensure proper separation and reuse of the device components.





15 Accessories

Various accessories, which can be ordered with the device or subsequently from Endress+Hauser, are available for the device. Detailed information on the order code in question is available from your local Endress+Hauser sales center or on the product page of the Endress+Hauser website: www.endress.com.



15.1 Device-specific accessories

15.1.1 For the transmitter



Accessory	Description
Transmitter <ul style="list-style-type: none"> ▪ Proline 500 – digital ▪ Proline 500 	Transmitter for replacement or storage. Use the order code to define the following specifications: <ul style="list-style-type: none"> ▪ Approvals ▪ Output ▪ Input ▪ Display/operation ▪ Housing ▪ Software <ul style="list-style-type: none">  ▪ Proline 500 – digital transmitter: Order number: 5X5BXX-*****A ▪ Proline 500 transmitter: Order number: 5X5BXX-*****B <ul style="list-style-type: none">  Proline 500 transmitter for replacement: It is essential to specify the serial number of the current transmitter when ordering. On the basis of the serial number, the device-specific data (e.g. calibration factors) of the replaced device can be used for the new transmitter. <ul style="list-style-type: none">  ▪ Proline 500 – digital transmitter: Installation Instructions EA01151D ▪ Proline 500 transmitter: Installation Instructions EA01152D
External WLAN antenna	External WLAN antenna with 1.5 m (59.1 in) connecting cable and two angle brackets. Order code for "Accessory enclosed", option P8 "Wireless antenna wide area". <ul style="list-style-type: none">  ▪ The external WLAN antenna is not suitable for use in hygienic applications. ▪ Further information on the WLAN interface →  91. <ul style="list-style-type: none">  Order number: 71351317 <ul style="list-style-type: none">  Installation Instructions EA01238D
Pipe mounting set	Pipe mounting set for transmitter. <ul style="list-style-type: none">  Proline 500 – digital transmitter Order number: 71346427 <ul style="list-style-type: none">  Installation Instructions EA01195D <ul style="list-style-type: none">  Proline 500 transmitter Order number: 71346428
Protective cover Transmitter <ul style="list-style-type: none"> ▪ Proline 500 – digital ▪ Proline 500 	Is used to protect the measuring instrument from the effects of the weather: e.g. rainwater, excess heating from direct sunlight. <ul style="list-style-type: none">  ▪ Proline 500 – digital transmitter Order number: 71343504 ▪ Proline 500 transmitter Order number: 71343505 <ul style="list-style-type: none">  Installation Instructions EA01191D

Display guard Proline 500 – digital	Is used to protect the display against impact or scoring, for example from sand in desert areas.  Order number: 71228792  Installation Instructions EA01093D
Connecting cable Proline 500 – digital Sensor – Transmitter	The connecting cable can be ordered directly with the measuring instrument (order code for "Cable, sensor connection") or as an accessory (order number DK5012). The following cable lengths are available: order code for "Cable, sensor connection" <ul style="list-style-type: none"> ■ Option B: 20 m (65 ft) ■ Option E: User-configurable up to max. 50 m ■ Option F: User-configurable up to max. 165 ft  Maximum possible cable length for a Proline 500 – digital connecting cable: 300 m (1 000 ft)
Connecting cable Proline 500 Sensor – Transmitter	The connecting cable can be ordered directly with the measuring instrument (order code for "Cable, sensor connection") or as an accessory (order number DK5012). The following cable lengths are available: order code for "Cable, sensor connection" <ul style="list-style-type: none"> ■ Option 1: 5 m (16 ft) ■ Option 2: 10 m (32 ft) ■ Option 3: 20 m (65 ft) ■ Option 4: User-configurable cable length (m) ■ Option 5: User-configurable cable length (ft)  Possible cable length for a Proline 500 connecting cable: depending on the medium conductivity, max. 200 m (660 ft)



15.1.2 For the sensor

Accessory	Description
Adapter set	Adapter connections for installing a Promag H instead of a Promag 30/33 A or Promag 30/33 H (DN 25). Scope of delivery: <ul style="list-style-type: none"> ■ 2 process connections ■ Screws ■ Seals
Seal set	For the regular replacement of seals for the sensor.
Spacer	If replacing a DN 80/100 sensor in an existing installation, a spacer is needed if the new sensor is shorter.
Welding jig	Welding nipple as process connection: welding jig for installation in pipe.
Grounding rings	Used to ground the medium in lined measuring tubes to ensure proper measurement.  Grounding rings can be ordered via the device order structure or configured and ordered as an accessory via the DK5HR order structure.
Ground disks	Used to ground the medium in lined measuring tubes to ensure proper measurement.  For details, see Installation Instructions EA00070D
Mounting kit	Scope of delivery: <ul style="list-style-type: none"> ■ 2 process connections ■ Screws ■ Seals
Wall mounting kit	Wall mounting kit for measuring instrument (only DN 2 to 25 (1/12 to 1"))

15.2 Service-specific accessories

Accessories	Description
Applicator	<p>Software for selecting and sizing Endress+Hauser measuring instruments:</p> <ul style="list-style-type: none"> ▪ Choice of measuring instruments for industrial requirements ▪ Calculation of all the necessary data for identifying the optimum flowmeter: e.g. nominal diameter, pressure loss, flow velocity and measurement accuracy. ▪ Graphic display of the calculation results ▪ Determining the partial order code. Administration, documentation and access to all project-related data and parameters over the entire life cycle of a project. <p>Applicator is available: Via the Internet: https://portal.endress.com/webapp/applicator</p>
Netilion	<p>IIoT ecosystem: Unlock knowledge</p> <p>With the Netilion IIoT ecosystem, Endress+Hauser allows you to optimize your plant performance, digitize workflows, share knowledge, and enhance collaboration.</p> <p>Drawing on decades of experience in process automation, Endress+Hauser offers process industries an IIoT ecosystem that provides customers with data-driven insights. These insights can be used to optimize processes, leading to increased plant availability, efficiency, and reliability - ultimately resulting in a more profitable plant.</p> <p>www.netilion.endress.com</p>
FieldCare	<p>FDT-based plant asset management tool from Endress+Hauser. It can configure all intelligent field units in your system and helps you manage them. By using the status information, it is also a simple but effective way of checking their status and condition.</p> <p> Operating Instructions BA00027S and BA00059S</p>
DeviceCare	<p>Tool to connect and configure Endress+Hauser field devices.</p> <p> <ul style="list-style-type: none"> ▪ Technical Information: TI01134S ▪ Innovation brochure: IN01047S </p>

15.3 System components

Accessories	Description
Memograph M graphic data manager	<p>The Memograph M graphic data manager provides information on all the relevant measured variables. Measured values are recorded correctly, limit values are monitored and measuring points analyzed. The data are stored in the 256 MB internal memory and also on a SD card or USB stick.</p> <p> <ul style="list-style-type: none"> ▪ Technical Information TI00133R ▪ Operating Instructions BA00247R </p>
iTEMP	<p>The temperature transmitters can be used in all applications and are suitable for the measurement of gases, steam and liquids. They can be used to read in the medium temperature.</p> <p> "Fields of Activity" document FA00006T</p>

16 Technical data

16.1 Application

The measuring device is intended only for the flow measurement of liquids with a minimum conductivity of 5 µS/cm.

Depending on the version ordered, the measuring device can also measure potentially explosive, flammable, poisonous and oxidizing media.

To ensure that the device remains in proper operating condition for its service life, use the measuring device only for media against which the process-wetted materials are sufficiently resistant.

16.2 Function and system design

Measuring principle Electromagnetic flow measurement on the basis of *Faraday's law of magnetic induction*.

Measuring system The measuring system consists of a transmitter and a sensor. The transmitter and sensor are mounted in physically separate locations. They are interconnected by connecting cables.

For information on the structure of the measuring instrument →  14

16.3 Input

Measured variable **Direct measured variables**

- Volume flow (proportional to induced voltage)
- Temperature ¹⁾
- Electrical conductivity

Calculated measured variables

- Mass flow
- Corrected volume flow
- Corrected electrical conductivity ¹⁾

Measuring range Typically $v = 0.01$ to 10 m/s (0.03 to 33 ft/s) with the specified measurement accuracy

Flow characteristic values in SI units: DN 2 to 125 (1/12 to 5")

Nominal diameter		Recommended flow min./max. full scale value ($v \sim 0.3/10$ m/s) [dm ³ /min]	Factory settings		
[mm]	[in]		Full scale value current output ($v \sim 2.5$ m/s) [dm ³ /min]	Pulse value (~ 2 pulse/s) [dm ³]	Low flow cut off ($v \sim 0.04$ m/s) [dm ³ /min]
2	1/12	0.06 to 1.8	0.5	0.005	0.01
4	5/32	0.25 to 7	2	0.025	0.05

1) Available only for nominal diameters DN 15 to 150 (1/2 to 6") and with the order code for "Sensor option", option CI "Medium temperature measurement".

Nominal diameter		Recommended flow min./max. full scale value (v ~ 0.3/10 m/s) [dm ³ /min]	Factory settings		
[mm]	[in]		Full scale value current output (v ~ 2.5 m/s) [dm ³ /min]	Pulse value (~ 2 pulse/s) [dm ³]	Low flow cut off (v ~ 0.04 m/s) [dm ³ /min]
8	5/16	1 to 30	8	0.1	0.1
15	1/2	4 to 100	25	0.2	0.5
25 ¹⁾	1	9 to 300	75	0.5	1
40	1 1/2	25 to 700	200	1.5	3
50	2	35 to 1 100	300	2.5	5
65	–	60 to 2 000	500	5	8
80	3	90 to 3 000	750	5	12
100	4	145 to 4 700	1200	10	20
125	5	220 to 7 500	1850	15	30

1) The values apply for the product version: 5HxB26

Flow characteristic values in SI units: DN 150 (6")

Nominal diameter		Recommended flow min./max. full scale value (v ~ 0.3/10 m/s) [m ³ /h]	Factory settings		
[mm]	[in]		Full scale value current output (v ~ 2.5 m/s) [m ³ /h]	Pulse value (~ 2 pulse/s) [m ³]	Low flow cut off (v ~ 0.04 m/s) [m ³ /h]
150	6	20 to 600	150	0.03	2.5



Flow characteristic values in US units: 1/12 - 6" (DN 2 - 150)

Nominal diameter		Recommended flow min./max. full scale value (v ~ 0.3/10 m/s) [gal/min]	Factory settings		
[in]	[mm]		Full scale value current output (v ~ 2.5 m/s) [gal/min]	Pulse value (~ 2 pulse/s) [gal]	Low flow cut off (v ~ 0.04 m/s) [gal/min]
1/12	2	0.015 to 0.5	0.1	0.001	0.002
1/32	4	0.07 to 2	0.5	0.005	0.008
5/16	8	0.25 to 8	2	0.02	0.025
1/2	15	1 to 27	6	0.05	0.1
1 ¹⁾	25	2.5 to 80	18	0.2	0.25
1 1/2	40	7 to 190	50	0.5	0.75
2	50	10 to 300	75	0.5	1.25
3	80	24 to 800	200	2	2.5
4	100	40 to 1 250	300	2	4

Nominal diameter		Recommended flow min./max. full scale value (v ~ 0.3/10 m/s) [gal/min]	Full scale value current output (v ~ 2.5 m/s) [gal/min]	Factory settings	
[in]	[mm]			Pulse value (~ 2 pulse/s) [gal]	Low flow cut off (v ~ 0.04 m/s) [gal/min]
5	125	60 to 1950	450	5	7
6	150	90 to 2 650	600	5	12

1) The values apply for the product version: 5HxB26

Recommended measuring range

 Flow limit →  197



Operable flow range Over 1000 : 1

Input signal

External measured values

To increase the measurement accuracy of certain measured variables or to calculate the mass flow, the automation system can continuously write different measured values to the measuring instrument:

- Medium temperature enables temperature-compensated conductivity measurement (e.g. iTEMP)
- Reference density for calculating the mass flow

 Various pressure and temperature measuring devices can be ordered from Endress +Hauser: see "Accessories" section →  179

It is recommended to read in external measured values to calculate the corrected volume flow.

Current input

The measured values are written from the automation system to the measuring device via the current input →  182.

Digital communication

The measured values are written by the automation system via Modbus TCP-Ethernet-APL.

Current input 0/4 to 20 mA

Current input	0/4 to 20 mA (active/passive)
Current span	<ul style="list-style-type: none"> ■ 4 to 20 mA (active) ■ 0/4 to 20 mA (passive)
Resolution	1 µA
Voltage drop	Typically: 0.6 to 2 V for 3.6 to 22 mA (passive)
Maximum input voltage	≤ 30 V (passive)
Open-circuit voltage	≤ 28.8 V (active)
Possible input variables	<ul style="list-style-type: none"> ■ Temperature ■ Density

Status input

Maximum input values	<ul style="list-style-type: none">▪ DC -3 to 30 V▪ If status input is active (ON): $R_i > 3 \text{ k}\Omega$
Response time	Configurable: 5 to 200 ms
Input signal level	<ul style="list-style-type: none">▪ Low signal: DC -3 to +5 V▪ High signal: DC 12 to 30 V
Assignable functions	<ul style="list-style-type: none">▪ Off▪ Reset the individual totalizers separately▪ Reset all totalizers▪ Flow override

16.4 Output

Output signal

Modbus TCP over Ethernet-APL

Port 1: Modbus TCP over Ethernet-APL 10 Mbit/s	
Device usage	<p>Device connection to an APL field switch (terminal 26/27) The device may only be operated according to the following APL port classifications:</p> <ul style="list-style-type: none"> ▪ If used in hazardous areas: SLAA or SLAC ¹⁾ ▪ If used in non-hazardous areas: SLAX <p>Connection values of APL field switch (corresponds to APL port classification SPCC or SPAA, for instance):</p> <ul style="list-style-type: none"> ▪ Maximum input voltage: 15 V_{DC} ▪ Minimum output values: 0.54 W <p>Device connection to an SPE switch</p> <ul style="list-style-type: none"> ▪ In non-hazardous areas, the device can be used with an appropriate SPE switch: <ul style="list-style-type: none"> ▪ Maximum output voltage: 30 V_{DC} ▪ Minimum output power: 1.85 W ▪ The SPE switch must support the 10BASE-T1L standard and PoDL power classes 10, 11 or 12 and have a function to disable power class detection.
Standards	According to IEEE 802.3cg, APL port profile specification v1.0, galvanically isolated
Data transfer	Full-duplex (APL/SPE)
Current consumption	Terminal 26/27 max. approx. 45 mA
Permitted supply voltage	9 to 30 V
Bus connection	Terminal 26/27 with integrated reverse polarity protection

1) For more information on using the device in the hazardous area, see the Ex-specific Safety Instructions

Port 2: Modbus TCP over Ethernet 100 Mbit/s	
Device usage	<p>Device connection to a Fast Ethernet (RJ45) switch In non-hazardous areas, the Ethernet switch must support the standard 100BASE-TX.</p>
Standards	In accordance with IEEE 802.3u
Data transfer	Half-duplex, full-duplex
Current consumption	-
Permitted supply voltage	-
Bus connection	Service interface (RJ45)

Current output 4 to 20 mA

Signal mode	Can be set to: <ul style="list-style-type: none"> ▪ Active ▪ Passive
Current range	Can be set to: <ul style="list-style-type: none"> ▪ 4 to 20 mA NAMUR ▪ 4 to 20 mA US ▪ 4 to 20 mA ▪ 0 to 20 mA (only if the signal mode is active) ▪ Fixed current
Maximum output values	22.5 mA
Open-circuit voltage	DC 28.8 V (active)

Maximum input voltage	DC 30 V (passive)
Load	0 to 700 Ω
Resolution	0.38 μ A
Damping	Configurable: 0 to 999.9 s
Assignable measured variables	<ul style="list-style-type: none"> ▪ Volume flow ▪ Mass flow ▪ Corrected volume flow ▪ Flow velocity ▪ Conductivity ▪ Corrected conductivity ▪ Temperature ▪ Electronics temperature

Pulse/frequency/switch output

Function	Can be configured as pulse, frequency or switch output
Version	Open collector Can be set to: <ul style="list-style-type: none"> ▪ Active ▪ Passive ▪ Passive NAMUR  Ex-i, passive
Maximum input values	DC 30 V, 250 mA (passive)
Open-circuit voltage	DC 28.8 V (active)
Voltage drop	For 22.5 mA: \leq DC 2 V
Pulse output	
Maximum input values	DC 30 V, 250 mA (passive)
Maximum output current	22.5 mA (active)
Open-circuit voltage	DC 28.8 V (active)
Pulse width	Configurable: 0.05 to 2 000 ms
Maximum pulse rate	10 000 Impulse/s
Pulse value	Configurable
Assignable measured variables	<ul style="list-style-type: none"> ▪ Volume flow ▪ Mass flow ▪ Corrected volume flow
Frequency output	
Maximum input values	DC 30 V, 250 mA (passive)
Maximum output current	22.5 mA (active)
Open-circuit voltage	DC 28.8 V (active)
Output frequency	Configurable: end value frequency 2 to 10 000 Hz ($f_{\max} = 12\,500$ Hz)
Damping	Configurable: 0 to 999.9 s
Pulse/pause ratio	1:1
Assignable measured variables	<ul style="list-style-type: none"> ▪ Volume flow ▪ Mass flow ▪ Corrected volume flow ▪ Flow velocity ▪ Conductivity ▪ Corrected conductivity ▪ Temperature ▪ Electronics temperature
Switch output	

Maximum input values	DC 30 V, 250 mA (passive)
Open-circuit voltage	DC 28.8 V (active)
Switching behavior	Binary, conductive or non-conductive
Switching delay	Configurable: 0 to 100 s
Number of switching cycles	Unlimited
Assignable functions	<ul style="list-style-type: none"> ▪ OFF ▪ ON ▪ Diagnostic behavior ▪ Limit value: <ul style="list-style-type: none"> ▪ OFF ▪ Volume flow ▪ Mass flow ▪ Corrected volume flow ▪ Flow velocity ▪ Conductivity ▪ Corrected conductivity ▪ Totalizer 1-3 ▪ Temperature ▪ Electronics temperature ▪ Flow direction monitoring ▪ Status <ul style="list-style-type: none"> ▪ Empty pipe detection ▪ Buildup index ▪ HBSI limit value exceeded ▪ Low flow cut off

Double pulse output

Function	Double pulse
Version	Open collector Can be set to: <ul style="list-style-type: none"> ▪ Active ▪ Passive ▪ Passive NAMUR
Maximum input values	DC 30 V, 250 mA (passive)
Open-circuit voltage	DC 28.8 V (active)
Voltage drop	For 22.5 mA: ≤ DC 2 V
Output frequency	Configurable: 0 to 1 000 Hz
Damping	Configurable: 0 to 999 s
Pulse/pause ratio	1:1
Assignable measured variables	<ul style="list-style-type: none"> ▪ Volume flow ▪ Mass flow ▪ Corrected volume flow ▪ Flow velocity ▪ Conductivity ▪ Corrected conductivity ▪ Temperature ▪ Electronics temperature

Relay output

Function	Switching output
Version	Relay output, galvanically isolated
Switching behavior	Can be set to: <ul style="list-style-type: none"> ▪ NO (normally open), factory setting ▪ NC (normally closed)

Maximum switching capacity (passive)	<ul style="list-style-type: none"> ▪ DC 30 V, 0.1 A ▪ AC 30 V, 0.5 A
Assignable functions	<ul style="list-style-type: none"> ▪ OFF ▪ ON ▪ Diagnostic behavior ▪ Limit value: <ul style="list-style-type: none"> ▪ OFF ▪ Volume flow ▪ Mass flow ▪ Corrected volume flow ▪ Flow velocity ▪ Conductivity ▪ Corrected conductivity ▪ Totalizer 1-3 ▪ Temperature ▪ Electronics temperature ▪ Flow direction monitoring ▪ Status <ul style="list-style-type: none"> ▪ Empty pipe detection ▪ Buildup index ▪ HBSI limit value exceeded ▪ Low flow cut off

User-configurable input/output

One specific input or output is assigned to a user-configurable input/output (configurable I/O) during device commissioning.

The following inputs and outputs are available for assignment:

- Choice of current output: 4 to 20 mA (active), 0/4 to 20 mA (passive)
- Pulse/frequency/switch output
- Choice of current input: 4 to 20 mA (active), 0/4 to 20 mA (passive)
- Status input

Signal on alarm

Depending on the interface, failure information is displayed as follows:

Modbus TCP over Ethernet-APL/SPE/Fast Ethernet

Failure mode	Choose from: <ul style="list-style-type: none"> ▪ NaN value instead of current value ▪ Last valid value
---------------------	---

Current output

Current output 4-20 mA	
Failure mode	Configurable: <ul style="list-style-type: none"> ▪ 4 to 20 mA in accordance with NAMUR recommendation NE 43 ▪ 4 to 20 mA in accordance with US ▪ Min. value: 3.59 mA ▪ Max. value: 22.5 mA ▪ Definable value between: 3.59 to 22.5 mA ▪ Actual value ▪ Last valid value
Current output 4-20 mA	
Failure mode	Configurable: <ul style="list-style-type: none"> ▪ Maximum alarm: 22 mA ▪ Definable value between: 0 to 20.5 mA

Pulse/frequency/switch output

Pulse output	
Failure mode	Configurable: <ul style="list-style-type: none"> ■ Actual value ■ No pulses
Frequency output	
Failure mode	Configurable: <ul style="list-style-type: none"> ■ Actual value ■ 0 Hz ■ Definable value between: 2 to 12 500 Hz
Switch output	
Failure mode	Configurable: <ul style="list-style-type: none"> ■ Current status ■ Open ■ Closed

Relay output

Failure mode	Choose from: <ul style="list-style-type: none"> ■ Current status ■ Open ■ Closed
--------------	---

Local display

Plain text display	With information on cause and remedial measures
Backlight	Red lighting indicates a device error.

 Status signal as per NAMUR recommendation NE 107



Interface/protocol

- Via digital communication:
 - Modbus TCP over Ethernet-APL
- Via service interface
 - Via service interface/port 2: (RJ45)
 - WLAN interface
- Plain text display
 - With information on cause and remedial actions
 - Modbus TCP

Web browser

Plain text display	With information on cause and remedial measures
--------------------	---

LEDs

Status information	Status indicated by various LEDs The following information is displayed depending on the device version: <ul style="list-style-type: none"> ▪ Supply voltage active ▪ Data transmission active ▪ Device alarm/error has occurred ▪ Network available ▪ Connection established ▪ Diagnostic status  Diagnostic information via LEDs →  155
---------------------------	--

Low flow cut off The switch points for low flow cut off are user-selectable.

Galvanic isolation The outputs are galvanically isolated:

- from the power supply
- from one another
- from the protective ground connection (PE)

Modbus TCP over Ethernet-APL

Port 1: Modbus TCP over Ethernet-APL 10 Mbit/s, SPE 10 Mbit/s	
Protocol	<ul style="list-style-type: none"> ▪ Modbus application protocol V1.1 ▪ TCP
Response times	On Modbus client request: Typically 3 to 5 ms
TCP port	502
Modbus TCP connections	Maximum 4
Communication type	Ethernet Advanced Physical Layer 10BASE-T1L
Data transfer	Full-duplex
Polarity	Automatic correction of crossed "APL signal +" and "APL signal -" signal lines
Device type	Address
Device type ID	0xC43C
Function codes	<ul style="list-style-type: none"> ▪ 03: Read holding register ▪ 04: Read input register ▪ 06: Write single registers ▪ 16: Write multiple registers ▪ 23: Read/write multiple registers ▪ 43: Read device identification
Broadcast support for function codes	<ul style="list-style-type: none"> ▪ 06: Write single registers ▪ 16: Write multiple registers ▪ 23: Read/write multiple registers ▪ 43: Read device identification
Supported transfer speed	10 Mbit/s (Ethernet-APL)
Supported features	Address can be configured using DHCP, web server or software
Device description files (FDI)	Information and files available at: www.endress.com → Downloads area
Configuration options for measuring instrument	<ul style="list-style-type: none"> ▪ Asset management software (FieldCare, DeviceCare, Field Expert) ▪ Integrated web server via web browser and IP address ▪ Onsite operation

Supported functions	<ul style="list-style-type: none"> ▪ Device identification using: Nameplate ▪ Measured value status The process variables are communicated with a measured value status ▪ Blinking feature via the local display for simple device identification and assignment ▪ Device operation via asset management software (e.g. FieldCare, DeviceCare)
System integration	<p>Information regarding system integration .</p> <ul style="list-style-type: none"> ▪ Overview and description of the supported function codes ▪ Status coding ▪ Factory setting

Port 2: Modbus TCP over Ethernet 100 Mbit/s	
Protocol	<ul style="list-style-type: none"> ▪ Modbus application protocol V1.1 ▪ TCP
Response times	On Modbus client request: Typically 3 to 5 ms
TCP port	502
Modbus TCP connections	Maximum 4
Communication type	<ul style="list-style-type: none"> ▪ 10BASE-T ▪ 100BASE-TX
Data transfer	Half-duplex, full-duplex
Polarity	Auto-MDIX
Device type	Address
Device type ID	0xC43C
Function codes	<ul style="list-style-type: none"> ▪ 03: Read holding register ▪ 04: Read input register ▪ 06: Write single registers ▪ 16: Write multiple registers ▪ 23: Read/write multiple registers ▪ 43: Read device identification
Broadcast support for function codes	<ul style="list-style-type: none"> ▪ 06: Write single registers ▪ 16: Write multiple registers ▪ 23: Read/write multiple registers ▪ 43: Read device identification
Supported transfer speed	<ul style="list-style-type: none"> ▪ 10 Mbit/s ▪ 100 Mbit/s (Fast-Ethernet)
Supported features	Address can be configured using DHCP, web server or software
Device description files (FDI)	Information and files available at: www.endress.com → Downloads area
Configuration options for measuring instrument	<ul style="list-style-type: none"> ▪ Asset management software (FieldCare, DeviceCare, Field Expert) ▪ Integrated web server via web browser and IP address ▪ Onsite operation
Supported functions	<ul style="list-style-type: none"> ▪ Device identification using: Nameplate ▪ Measured value status The process variables are communicated with a measured value status ▪ Device operation via asset management software (e.g. FieldCare, DeviceCare)
System integration	<p>Information regarding system integration .</p> <ul style="list-style-type: none"> ▪ Overview and description of the supported function codes ▪ Status coding ▪ Factory setting

16.5 Power supply

Terminal assignment →  42

Supply voltage	Order code "Power supply"	Terminal voltage		Frequency range
	Option D	DC 24 V	±20%	–
Option E	AC 100 to 240 V	–15...+10%	50/60 Hz, ±4 Hz	
Option I	DC 24 V	±20%	–	
	AC 100 to 240 V	–15...+10%	50/60 Hz, ±4 Hz	

Power consumption

Transmitter

Max. 10 W (active power)

switch-on current	Max. 36 A (<5 ms) as per NAMUR Recommendation NE 21
--------------------------	---

Current consumption

Transmitter

- Max. 400 mA (24 V)
- Max. 200 mA (110 V, 50/60 Hz; 230 V, 50/60 Hz)

Power supply failure



- Totalizers stop at the last value measured.
- Depending on the device version, the configuration is retained in the device memory or in the plug-in memory (HistoROM DAT).
- Error messages (incl. total operated hours) are stored.

Overcurrent protection element

The device must be operated with a dedicated circuit breaker, as it does not have an ON/OFF switch of its own.

- The circuit breaker must be easy to reach and labeled accordingly.
- Permitted nominal current of the circuit breaker: 2 A up to maximum 10 A.

Electrical connection

- →  48
- →  56

Potential equalization

Terminals

Spring-loaded terminals: Suitable for strands and strands with ferrules.
Conductor cross-section 0.2 to 2.5 mm² (24 to 12 AWG).

Cable entries

- Cable gland: M20 × 1.5 with cable Ø 6 to 12 mm (0.24 to 0.47 in)
- Thread for cable entry:
 - NPT ½"
 - G ½"
 - M20
- Device plug for connecting cable: M12
A device plug is always used for the device version with the order code for "Sensor connection housing", option C "Ultra-compact, hygienic, stainless".

Cable specification → 38

Overvoltage protection	Mains voltage fluctuations	→ 191
	Overvoltage category	Overvoltage category II
	Short-term, temporary overvoltage	Between cable and ground up to 1200 V, for max. 5 s
	Long-term, temporary overvoltage	Between cable and ground up to 500 V

16.6 Performance characteristics

- Reference operating conditions
- Error limits following DIN EN 29104, in future ISO 20456
 - Water, typically: +15 to +45 °C (+59 to +113 °F); 0.5 to 7 bar (73 to 101 psi)
 - Data as indicated in the calibration protocol
 - Accuracy based on accredited calibration rigs according to ISO 17025
 - Reference temperature for conductivity measurement: 25 °C (77 °F)

Maximum measurement error o.r. = of reading

Maximum permissible error under reference operating conditions

Volume flow

- ±0.5 % o.r. ± 1 mm/s (0.04 in/s)
- Optional: ±0.2 % o.r. ± 2 mm/s (0.08 in/s)

i Fluctuations in the supply voltage have no effect within the specified range.

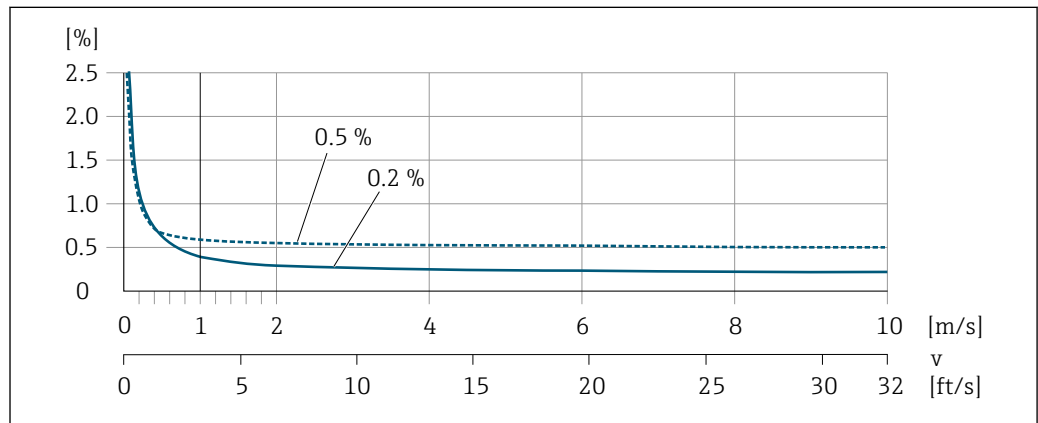

37 Maximum measurement error in % o.r.

Temperature

±3 °C (±5.4 °F)

Electrical conductivity

The values apply for:

- Devices with stainless steel process connections
- Proline 500 – digital device version
- Measurements at a reference temperature of 25 °C (77 °F). At different temperatures, attention must be paid to the temperature coefficient of the medium (typically 2.1 %/K)

Conductivity [$\mu\text{S}/\text{cm}$]	Nominal diameter		Measurement error [%] of reading
	[mm]	[in]	
5 to 20	15 to 150	$\frac{1}{2}$ to 6	$\pm 20\%$
> 20 to 50	15 to 150	$\frac{1}{2}$ to 6	$\pm 10\%$
> 50 to 10000	2 to 8	$\frac{1}{12}$ to $\frac{5}{16}$	$\pm 10\%$
	15 to 150	$\frac{1}{2}$ to 6	<ul style="list-style-type: none"> ■ Standard: $\pm 10\%$ ■ Optional ¹⁾: $\pm 5\%$
> 10000 to 20000	2 to 150	$\frac{1}{12}$ to 6	$\pm 10\%$
> 20000 to 100000	2 to 150	$\frac{1}{12}$ to 6	$\pm 20\%$

1) Order code for "Calibrated conductivity measurement", option CW

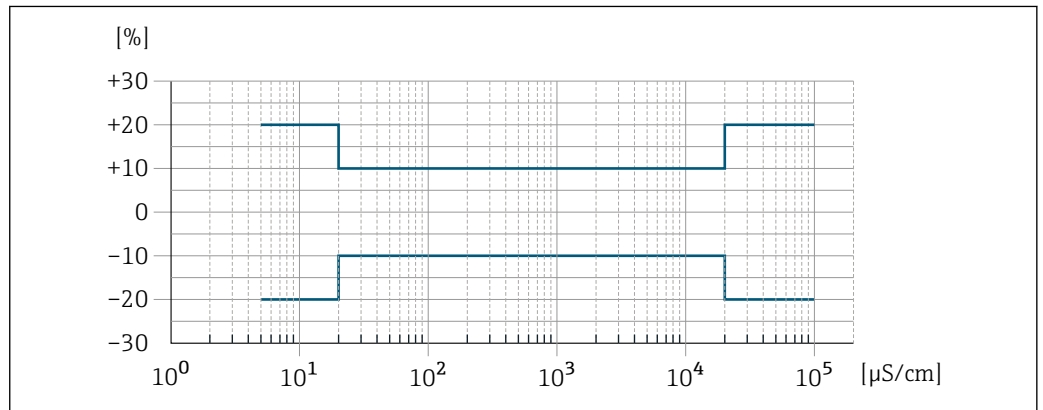

38 Measurement error (standard)

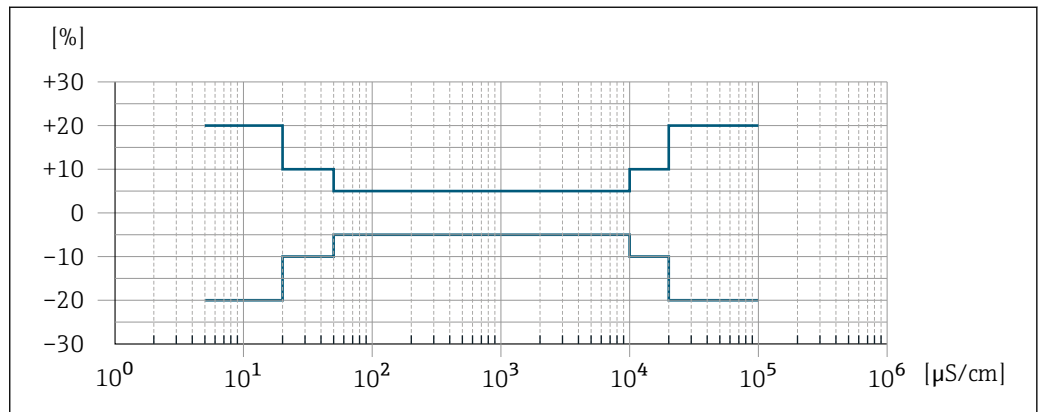

39 Measurement error (optional: order code for "Calibrated conductivity measurement", option CW)

Repeatability

o.r. = of reading

Volume flow

Max. $\pm 0.1\%$ o.r. ± 0.5 mm/s (0.02 in/s)

Temperature

± 0.5 °C (± 0.9 °F)

Electrical conductivity

■ Max. $\pm 5\%$ o.r.

■ Max. $\pm 1\%$ o.r. for DN 15 to 150 in conjunction with process connections made of stainless steel 1.4404 (F316L)

Temperature measurement response time $T_{90} < 15 \text{ s}$

Influence of ambient temperature

Current output

Temperature coefficient	Max. $1 \mu\text{A}/^\circ\text{C}$
-------------------------	-------------------------------------

Pulse/frequency output

Temperature coefficient	No additional effect. Included in accuracy.
-------------------------	---

16.7 Installation

Installation requirements →  22

16.8 Environment

Ambient temperature range →  28

Temperature tables

 Observe the interdependencies between the permitted ambient and fluid temperatures when operating the device in hazardous areas.

 For detailed information on the temperature tables, see the separate document entitled "Safety Instructions" (XA) for the device.

Storage temperature

The storage temperature corresponds to the operating temperature range of the transmitter and the sensor →  28.

- Protect the measuring device against direct sunlight during storage in order to avoid unacceptably high surface temperatures.
- Select a storage location where moisture cannot collect in the measuring device as fungus or bacteria infestation can damage the liner.
- If protection caps or protective covers are mounted these should never be removed before installing the measuring device.

Atmosphere

Additional protection against condensation and moisture: the sensor housing is potted with a gel.

Order code for "Sensor option", option CF "Harsh environment".

Relative humidity

The device is suitable for use in outdoor and indoor areas with a relative humidity of 4 to 95%.



Operating height

According to EN 61010-1
 $\leq 2\,000 \text{ m}$ (6 562 ft)

Degree of protection	<p>Transmitter</p> <ul style="list-style-type: none"> ■ IP66/67, Type 4X enclosure, suitable for pollution degree 4 ■ When the housing is open: IP20, Type 1 enclosure, suitable for pollution degree 2 ■ Display module: IP20, Type 1 enclosure, suitable for pollution degree 2 <p>Sensor</p> <ul style="list-style-type: none"> ■ IP66/67, Type 4X enclosure, suitable for pollution degree 4 ■ When the housing is open: IP20, Type 1 enclosure, suitable for pollution degree 2 <p>External WLAN antenna</p> <p>IP66/67, type 4X enclosure</p>
----------------------	---

Vibration resistance and shock resistance	<p>Sinusoidal vibration similar to IEC 60068-2-6</p> <ul style="list-style-type: none"> ■ 2 to 8.4 Hz, 7.5 mm peak ■ 8.4 to 2 000 Hz, 2 g peak <p>Broadband random vibration similar to IEC 60068-2-64</p> <ul style="list-style-type: none"> ■ 10 to 200 Hz, 0.01 g²/Hz ■ 200 to 2 000 Hz, 0.003 g²/Hz ■ Total: 2.70 g rms <p>Half-sine shocks similar to IEC 60068-2-27</p> <p>6 ms 50 g</p> <p>Rough handling shocks similar to IEC 60068-2-31</p>
---	--

Mechanical load	<p>Transmitter housing and sensor connection housing:</p> <ul style="list-style-type: none"> ■ Protect against mechanical effects, such as shock or impact ■ Do not use as a ladder or climbing aid
-----------------	---

Electromagnetic compatibility (EMC)	<p> Details are provided in the Declaration of Conformity.</p> <p> This unit is not intended for use in residential environments and cannot guarantee adequate protection of the radio reception in such environments.</p> <p> The selection of a sensor with a steel housing is recommended for use in the vicinity of electrical power supply lines with strong currents.</p>
-------------------------------------	--

16.9 Process

Medium temperature range	-20 to +150 °C (-4 to +302 °F)
--------------------------	--------------------------------

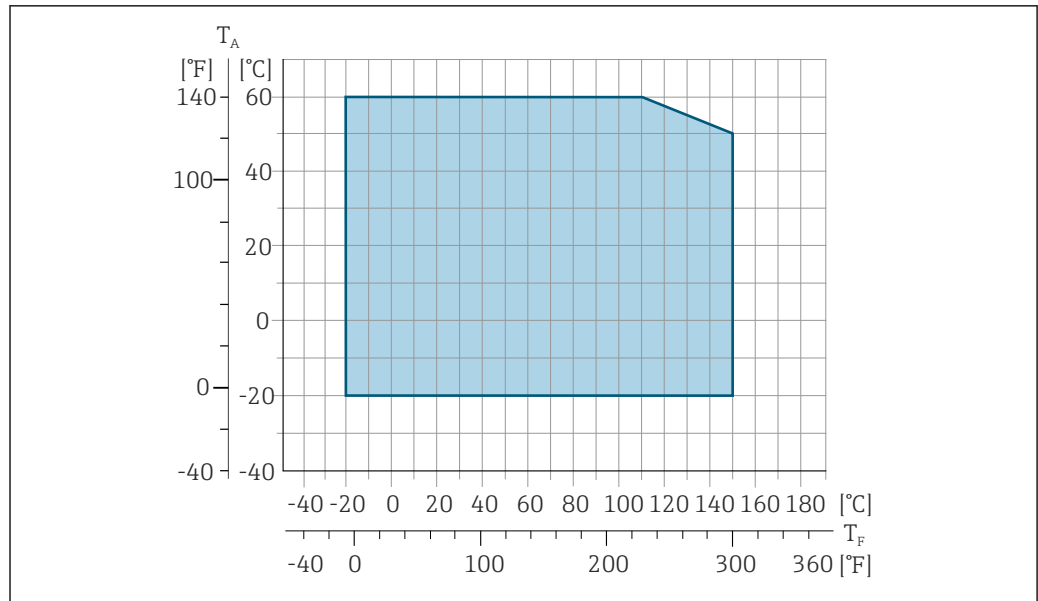

A0027806

40 Promag 500 - digital

T_A Ambient temperature range

T_F Fluid temperature

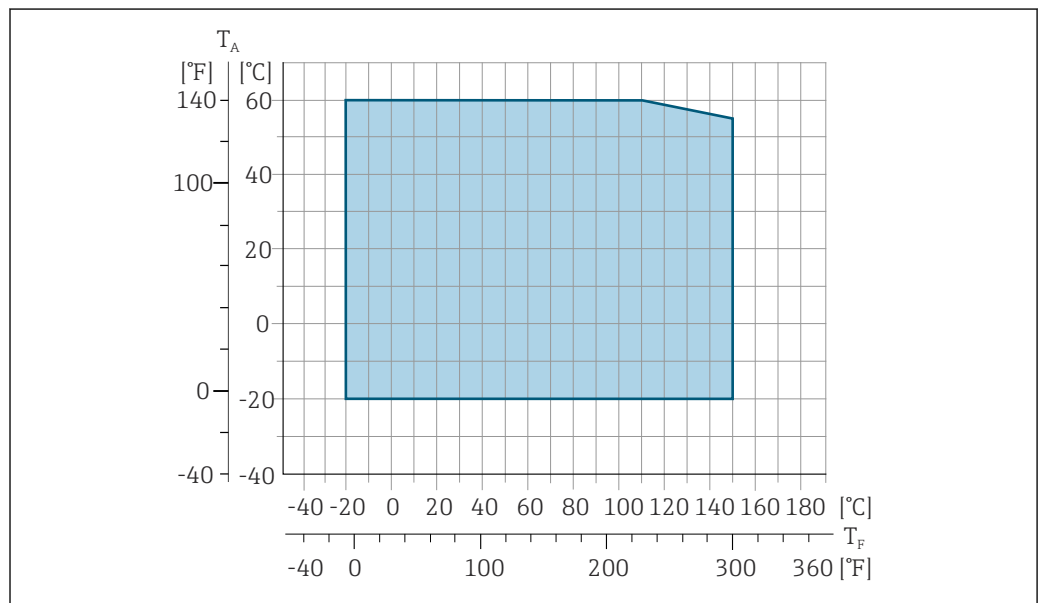

A0027450

41 Promag 500

T_A Ambient temperature range

T_F Fluid temperature

i The permitted fluid temperature in custody transfer is 0 to +50 °C (+32 to +122 °F).

Conductivity

≥5 μS/cm for liquids in general.

i Proline 500

The necessary minimum conductivity also depends on the length of the connecting cable → 29.

Pressure/temperature ratings  For an overview of the pressure/temperature ratings for the process connections, see the Technical Information

Pressure tightness *Liner: PFA*

Nominal diameter		Limit values for absolute pressure in [mbar] ([psi]) for medium temperatures:				
[mm]	[in]	+25 °C (+77 °F)	+80 °C (+176 °F)	+100 °C (+212 °F)	+130 °C (+266 °F)	+150 °C (+302 °F)
2 to 150	1/12 to 6	0 (0)	0 (0)	0 (0)	0 (0)	0 (0)

Flow limit The diameter of the pipe and the flow rate determine the nominal diameter of the sensor. The optimum velocity of flow is between 2 to 3 m/s (6.56 to 9.84 ft/s). Also match the velocity of flow (v) to the physical properties of the medium:

- v < 2 m/s (6.56 ft/s): for low conductivity values
- v > 2 m/s (6.56 ft/s): for media producing buildup (e.g. milk with a high fat content)
-  ▪ A necessary increase in the flow velocity can be achieved by reducing the sensor nominal diameter.
 - In the case of media with a high solids content, a sensor with a nominal diameter > DN 8 (3/8") can improve the signal stability and cleanability due to the larger electrodes.

Pressure loss

- No pressure loss occurs as of nominal diameter DN 8 (5/16") if the sensor is installed in a pipe with the same nominal diameter.
- Pressure losses for configurations incorporating adapters according to DIN EN 545 →  28

System pressure →  28

Internal cleaning

- CIP cleaning
- SIP cleaning

Vibrations →  28

16.10 Mechanical construction

Design, dimensions  For the dimensions and installed lengths of the device, see the "Technical Information" document, "Mechanical construction" section

Weight All values (weight exclusive of packaging material) refer to devices with flanges of the standard pressure rating. The weight may be lower than indicated depending on the pressure rating and design.

Transmitter

- Proline 500 – digital polycarbonate: 1.4 kg (3.1 lbs)
- Proline 500 – digital aluminum: 2.4 kg (5.3 lbs)
- Proline 500 aluminum: 6.5 kg (14.3 lbs)

Sensor

Sensor with aluminum connection housing version:

Nominal diameter		Weight	
[mm]	[in]	[kg]	[lbs]
2	1/12	2.00	4.41
4	5/32	2.00	4.41
8	5/16	2.00	4.41
15	½	1.90	4.19
25	1	2.80	6.17
40	1 ½	4.10	9.04
50	2	4.60	10.1
65	–	5.40	11.9
80	3	6.00	13.2
100	4	7.30	16.1
125	5	12.7	28.0
150	6	15.1	33.3

Measuring tube specification

Nominal diameter		Pressure rating ¹⁾	Process connection internal diameter	
[mm]	[in]	EN (DIN)	PFA	
		[bar]	[mm]	[in]
2	1/12	PN 16/40	2.25	0.09
4	5/32	PN 16/40	4.5	0.18
8	5/16	PN 16/40	9.0	0.35
15	½	PN 16/40	16.0	0.63
–	1	PN 16/40	22.6 ²⁾	0.89 ²⁾
25	–	PN 16/40	26.0 ³⁾	1.02 ³⁾
40	1 ½	PN 16/25/40	34.8	1.37
50	2	PN 16/25	47.5	1.87
65	–	PN 16/25	60.2	2.37
80	3	PN 16/25	72.9	2.87
100	4	PN 16/25	97.4	3.83
125	5	PN 10/16	120.0	4.72
150	6	PN 10/16	146.9	5.78

- 1) Depending on process connection and seals used
- 2) Order code 5H**22
- 3) Order code 5H**26

Materials

Transmitter housing

Housing of Proline 500 – digital transmitter

Order code for "Transmitter housing":

- Option **A** "Aluminum coated": aluminum, AlSi10Mg, coated
- Option **D** "Polycarbonate": polycarbonate

Housing of Proline 500 transmitter

Order code for "Transmitter housing":

- Option **A** "Aluminum coated": aluminum, AlSi10Mg, coated

Window material

Order code for "Transmitter housing":

- Option **A** "Aluminum, coated": glass
- Option **D** "Polycarbonate": plastic

Sensor connection housing

Order code for "Sensor connection housing":

- Option **A** "Aluminum coated": aluminum, AlSi10Mg, coated
- Option **B** "Stainless, hygienic":
Stainless steel 1.4301 (304)
- Option **C** "Ultra-compact hygienic, stainless":
Stainless steel 1.4301 (304)

Cable entries/cable glands

Cable entries and adapters	Material
Cable gland M20 × 1.5	Plastic
<ul style="list-style-type: none"> ■ Adapter for cable entry with female thread G ½" ■ Adapter for cable entry with female thread NPT ½" <p> Only available for certain device versions:</p> <ul style="list-style-type: none"> ■ Order code for "Transmitter housing": <ul style="list-style-type: none"> ■ Option A "Aluminum, coated" ■ Option D "Polycarbonate" ■ Order code for "Sensor connection housing": <ul style="list-style-type: none"> ■ Proline 500 – digital: Option A "Aluminum coated" Option B "Stainless" ■ Proline 500: Option A "Aluminum coated" Option C "Stainless, hygienic" 	Nickel-plated brass

Connecting cable

 UV radiation can impair the cable outer sheath. Protect the cable from exposure to sun as much as possible.

Connecting cable for sensor - Proline 500 – digital transmitter

PVC cable with copper shield

Connecting cable for sensor - Proline 500 transmitter

PVC cable with copper shield

Sensor housing

Stainless steel 1.4301 (304)

Measuring tubes

Stainless steel 1.4301 (304)

Liner

PFA

Process connections

- Stainless steel, 1.4404 (F316L)
- PVDF
- PVC adhesive sleeve

Electrodes

- Standard: stainless steel, 1.4435 (316 L)
- Optional: Alloy C22, 2.4602 (UNS N06022); tantalum (Ta 2.5 W); platinum (Pt/Ir 20%) (only up to DN 25 (1"))

Seals

- O-ring seal, DN 2 to 25 (1/12 to 1"): EPDM, FKM, Kalrez
- Aseptic²⁾ gasket seal, DN 2 to 150 (1/12 to 6"): EPDM, FKM, VMQ (silicone)

Accessories

Protective cover

Stainless steel, 1.4404 (316L)

External WLAN antenna

- Antenna: ASA plastic (acrylonitrile styrene acrylate) and nickel-plated brass
- Adapter: Stainless steel and nickel-plated brass
- Cable: Polyethylene
- Plug: Nickel-plated brass
- Angle bracket: Stainless steel

Grounding rings

- Standard: 1.4435 (316L)
- Optional: Alloy C22, tantalum

Wall mounting kit

Stainless steel, 1.4301 (304)³⁾

Spacer

1.4435 (F316L)

Fitted electrodes

- Working electrodes for signal detection
- Medium monitoring electrode for empty pipe detection/temperature measurement (DN 15 to 150 (½ to 6") only)

Process connections

With O-ring seal:

- Welding nipple
- Flange
- Male thread
- Female thread
- Hose connection
- PVC adhesive sleeve

With aseptic gasket seal:

- Clamp
- Coupling
- Flange

- i**
 - For information on the different materials used in the process connections →  199
 - For information on the mechanical construction of the process connections

2) In this context, aseptic means hygienic design

3) Does not meet the hygienic design installation guidelines.

Surface roughness	<p>Electrodes:</p> <ul style="list-style-type: none"> ■ Stainless steel, 1.4435 (316 L) electropolished $\leq 0.5 \mu\text{m}$ (19.7 μin) ■ Alloy C22, 2.4602 (UNS N06022); Tantal (Ta 2,5W) $\leq 0.5 \mu\text{m}$ (19.7 μin); Platin (Pt/Ir 20%) $\leq 0.5 \mu\text{m}$ (19.7 μin) <p>(All data refer to parts in contact with the medium).</p> <p>Liner with PFA:</p> <p>$\leq 0.4 \mu\text{m}$ (15.7 μin)</p> <p>(All data refer to parts in contact with the medium).</p> <p>Stainless steel process connections:</p> <ul style="list-style-type: none"> ■ With O-ring seal: $\leq 1.6 \mu\text{m}$ (63 μin) ■ With aseptic seal: $Ra_{\text{max}} = 0.76 \mu\text{m}$ (31.5 μin) Optional: $Ra_{\text{max}} = 0.38 \mu\text{m}$ (15 μin) electropolished <p>(All data refer to parts in contact with the medium).</p>
-------------------	--

16.11 User interface

Languages	<p>Can be operated in the following languages:</p> <ul style="list-style-type: none"> ■ Via local operation English, German, French, Spanish, Italian, Dutch, Portuguese, Polish, Russian, Turkish, Chinese, Japanese, Korean, Vietnamese, Czech, Swedish ■ Via web browser English, German, French, Spanish, Italian, Dutch, Portuguese, Polish, Russian, Turkish, Chinese, Japanese, Vietnamese, Czech, Swedish ■ Via "FieldCare", "DeviceCare" operating tool: English, German, French, Spanish, Italian, Chinese, Japanese
-----------	---

Onsite operation	<p>Via display module</p> <p>Equipment level:</p> <ul style="list-style-type: none"> ■ Order code for "Display; operation", option F "4-line, illuminated, graphic display; touch control" ■ Order code for "Display; operation", option G "4-line, illuminated, graphic display; touch control + WLAN"
------------------	--

 Information about WLAN interface →  91

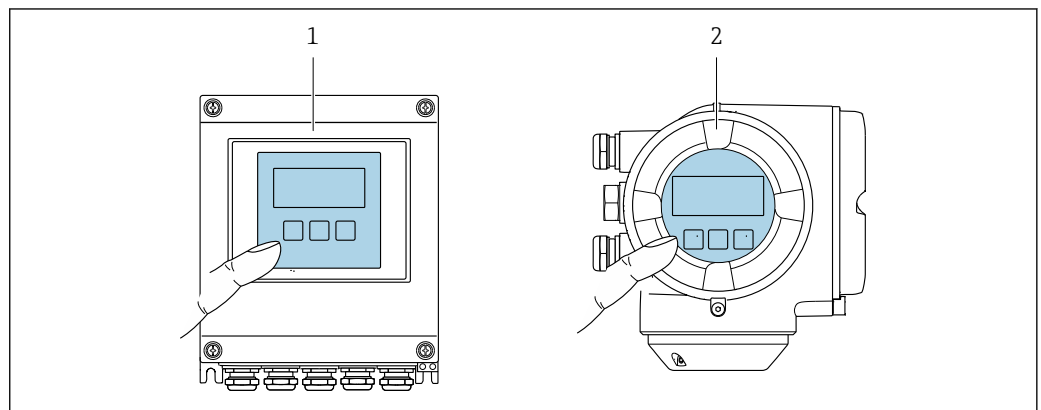

 42 Operation with touch control



- 1 Proline 500 – digital
- 2 Proline 500

A0028232

Display elements

- 4-line, illuminated, graphic display
- White background lighting; switches to red in event of device errors
- Format for displaying measured variables and status variables can be individually configured



Operating elements

- External operation via touch control (3 optical keys) without opening the housing: , , 
- Operating elements also accessible in the various zones of the hazardous area

Remote operation →  89

Service interface →  90

Supported operating tools Different operating tools can be used for local or remote access to the measuring device. Depending on the operating tool used, access is possible with different operating units and via a variety of interfaces.

Supported operating tools	Operating unit	Interface	Additional information
Web browser	Notebook, PC or tablet with web browser	<ul style="list-style-type: none"> ■ Service interface CDI-RJ45 ■ WLAN interface ■ Ethernet-based fieldbus (EtherNet/IP, PROFINET, Modbus TCP over Ethernet-APL) 	Special Documentation for device
DeviceCare SFE100	Notebook, PC or tablet with Microsoft Windows system	<ul style="list-style-type: none"> ■ Service interface CDI-RJ45 ■ WLAN interface ■ Fieldbus protocol ■ Modbus TCP over Ethernet-APL 	→  179
FieldCare SFE500	Notebook, PC or tablet with Microsoft Windows system	<ul style="list-style-type: none"> ■ Service interface CDI-RJ45 ■ WLAN interface ■ Fieldbus protocol 	→  179
Field Xpert	SMT70/77/50	<ul style="list-style-type: none"> ■ All fieldbus protocols ■ WLAN interface ■ Bluetooth ■ Service interface CDI-RJ45 	Operating Instructions BA01202S Device description files: Use update function of handheld terminal

 Other operating tools based on FDT technology with a device driver such as DTM/iDTM or DD/EDD can be used for device operation. These operating tools are available from the individual manufacturers. Integration into the following operating tools, among others, is supported:

- Emersons TREX → www.emerson.com
- Field Device Manager (FDM) from Honeywell → www.process.honeywell.com
- FieldMate from Yokogawa → www.yokogawa.com
- PACTWare → www.pactware.com

The related device description files are available: www.endress.com → Download Area



Web server

The integrated web server can be used to operate and configure the device via a web browser via Ethernet-APL, service interface (CDI) or via WLAN interface . The structure of the operating menu is the same as for the local display. In addition to the measured values, status information on the device is displayed and can be used to monitor device health. Furthermore the device data can be managed and the network parameters can be configured.

A device that has a WLAN interface (can be ordered as an option) is required for the WLAN connection: order code for "Display; Operation", option G "4-line, illuminated; touch control + WLAN". The device acts as an Access Point and enables communication by computer or a mobile handheld terminal.

Supported functions

Data exchange between the operating unit (such as a notebook, for example,) and measuring instrument:

- Upload the configuration from the measuring instrument (XML format, configuration backup)
- Save the configuration to the measuring instrument (XML format, restore configuration)
- Export event list (.csv file)
- Export parameter settings (.csv file or PDF file, document the measuring point configuration)
- Export the Heartbeat Technology verification report (PDF file, only available with the **Heartbeat Verification** →  207 application package)
- Flash firmware version for device firmware upgrade, for example
- Download driver for system integration
- Visualize up to 1000 saved measured values (only available with the **Extended HistoROM** application package →  207)

HistoROM data management

The measuring instrument features HistoROM data management. HistoROM data management comprises both the storage and import/export of key device and process data, making operation and servicing far more reliable, secure and efficient.

 When the device is delivered, the factory settings of the configuration data are stored as a backup in the device memory. This memory can be overwritten with an updated data record, for example after commissioning.

Additional information on the data storage concept

There are different types of data storage units in which device data are stored and used by the device:

	HistoROM backup	T-DAT	S-DAT
Available data	<ul style="list-style-type: none"> ▪ Event logbook, e.g. diagnostic events ▪ Parameter data record backup ▪ Device firmware package 	<ul style="list-style-type: none"> ▪ Measured value logging ("Extended HistoROM" order option) ▪ Current parameter data record (used by firmware at run time) ▪ Indicator (minimum/maximum values) ▪ Totalizer value 	<ul style="list-style-type: none"> ▪ Sensor data: e.g. nominal diameter ▪ Serial number ▪ Calibration data ▪ Device configuration (e.g. SW options, fixed I/O or multi I/O)
Storage location	Fixed on the user interface PC board in the connection compartment	Can be plugged into the user interface PC board in the connection compartment	In the sensor plug in the transmitter neck part

Data backup

Automatic

- The most important device data (sensor and transmitter) are automatically saved in the DAT modules
- If the transmitter or measuring device is replaced: once the T-DAT containing the previous device data has been exchanged, the new measuring device is ready for operation again immediately without any errors
- If the sensor is replaced: once the sensor has been replaced, new sensor data are transferred from the S-DAT in the measuring device and the measuring device is ready for operation again immediately without any errors
- If exchanging the electronics module (e.g. I/O electronics module): Once the electronics module has been replaced, the software of the module is compared against the current device firmware. The module software is upgraded or downgraded where necessary. The electronics module is available for use immediately afterwards and no compatibility problems occur.

Manual

Additional parameter data record (complete parameter settings) in the integrated device memory HistoROM backup for:

- Data backup function
Backup and subsequent restoration of a device configuration in the device memory HistoROM backup
- Data comparison function
Comparison of the current device configuration with the device configuration saved in the device memory HistoROM backup

Data transmission

Manual

Transfer of a device configuration to another device using the export function of the specific operating tool, e.g. with FieldCare, DeviceCare or web server: to duplicate the configuration or to store in an archive (e.g. for backup purposes)

Event list

Automatic

- Chronological display of up to 20 event messages in the events list
- If the **Extended HistoROM** application package (order option) is enabled: up to 100 event messages are displayed in the events list along with a time stamp, plain text description and remedial measures
- The events list can be exported and displayed via a variety of interfaces and operating tools e.g. DeviceCare, FieldCare or Web server

Data logging

Manual

If the **Extended HistoROM** application package (order option) is enabled:

- Recording of 1 to 4 channels of up to 1 000 measured values (up to 250 measured values per channel)
- User configurable recording interval
- Export the measured value log via a variety of interfaces and operating tools e.g. FieldCare, DeviceCare or web server

16.12 Certificates and approvals

Current certificates and approvals for the product are available at www.endress.com on the relevant product page:

1. Select the product using the filters and search field.

2. Open the product page.
3. Select **Downloads**.

CE mark	<p>The device meets the legal requirements of the applicable EU Directives. These are listed in the corresponding EU Declaration of Conformity along with the standards applied.</p> <p>Endress+Hauser confirms successful testing of the device by affixing to it the CE mark.</p>
UKCA marking	<p>The device meets the legal requirements of the applicable UK regulations (Statutory Instruments). These are listed in the UKCA Declaration of Conformity along with the designated standards. By selecting the order option for UKCA marking, Endress+Hauser confirms a successful evaluation and testing of the device by affixing the UKCA mark.</p> <p>Contact address Endress+Hauser UK: Endress+Hauser Ltd. Floats Road Manchester M23 9NF United Kingdom www.uk.endress.com</p>
Ex-approval	<p>The devices are certified for use in hazardous areas and the relevant safety instructions are provided in the separate "Safety Instructions" (XA) document. Reference is made to this document on the nameplate.</p>
Sanitary compatibility	<ul style="list-style-type: none"> ■ 3-A approval <ul style="list-style-type: none"> ■ Confirmation by affixing the 3-A symbol for measuring instruments with the order code for "Additional approval", option LP "3-A". ■ When installing the measuring instrument, ensure that no liquid can accumulate on the outside of the measuring instrument. Remote transmitters must be installed in accordance with the 3-A Standard. ■ Accessories and process connections (e.g. weather protection cover, wall holder unit) must be selected and installed in accordance with the 3-A Standard. Each accessory can be cleaned. Disassembly may be necessary under certain circumstances. ■ EHEDG-certified (Type EL Class I) <ul style="list-style-type: none"> ■ Confirmation by affixing the EHEDG symbol for measuring instruments with the order code for "Additional approval", option LT "EHEDG". ■ EPDM is not a suitable seal material for media with a fat content > 8 %. ■ To meet the requirements for EHEDG certification, the device must be used with process connections in accordance with the EHEDG position paper entitled "Easy cleanable Pipe couplings and Process connections" (www.ehedg.org). ■ The EHEDG cleanability test requires a flow velocity of 1.5 m/s in the process line. This velocity must be ensured for EHEDG-compliant cleaning. ■ The requirements of the Food Contact Material Regulations must be observed when selecting the materials used. ■ FDA 21 CFR 177.1550 ■ Food Contact Materials Regulation (EC) 1935/2004 ■ Food Contact Materials Regulation GB 4806 ■ Pasteurized Milk Ordinance (PMO) <p> Binding information on the applicable conformities can be found in the relevant applicable Declaration of Conformity.</p>

Pharmaceutical compatibility

- USP <87>
 - USP <88> Class VI 121 °C
 - TSE/BSE Certificate of Suitability
 - cGMP

Devices with the order code for "Test, certificate", option JG "Conformity with cGMP-derived requirements, declaration" comply with the requirements of cGMP with regard to the surfaces of parts in contact with the medium, design, material conformity, USP Class VI tests and TSE/BSE conformity.

A serial number-specific declaration is generated.
-  Binding information on the applicable conformities can be found in the relevant applicable Declaration of Conformity.

Radio approval

The measuring instrument has radio approval.

 For detailed information on the radio approval, see the Special Documentation

Pressure Equipment Directive

- With the marking
 - a) PED/G1/x (x = category) or
 - b) PESR/G1/x (x = category)

on the sensor nameplate, Endress+Hauser confirms compliance with the "Essential Safety Requirements"

 - a) specified in Annex I of the Pressure Equipment Directive 2014/68/EU or
 - b) Schedule 2 of Statutory Instruments 2016 No. 1105.
- Devices not bearing this marking (without PED or PESR) are designed and manufactured according to sound engineering practice. They meet the requirements of
 - a) Art. 4, Section 3 of the Pressure Equipment Directive 2014/68/EU or
 - b) Part 1, Section 8 of Statutory Instruments 2016 No. 1105.

The scope of application is indicated

 - a) in diagrams 6 to 9 in Annex II of the Pressure Equipment Directive 2014/68/EU or
 - b) in Schedule 3, Section 2 of Statutory Instruments 2016 No. 1105.

Additional certification

Marine approval

Currently valid certificates are available:

- In the Downloads area of the Endress+Hauser website: www.endress.com → Downloads
- Specify the following details:
 - Product root: e.g. 5H5B
 - Search: Approval & Certificates → Marine

PWIS-free

PWIS = paint-wetting impairment substances

Order code for "Service":

- Option **HC**: PWIS-free (version A)
- Option **HD**: PWIS-free (version B)
- Option **HE**: PWIS-free (version C)

 For more information on PWIS-free certification, see "Test specification" document TS01028D

Tests and certificates

- EN10204-3.1 material certificate, wetted parts and sensor housing (order code for "Test, certificate", option JA)
- Pressure test, internal process, test report (order code for "Test, certificate", option JB)

External standards and guidelines	<ul style="list-style-type: none"> ■ EN 60529 Degrees of protection provided by enclosure (IP code) ■ EN 61010-1 Safety requirements for electrical equipment for measurement, control and laboratory use - general requirements ■ GB 30439.5 Safety requirements for industrial automation products - Part 5: Flowmeter safety requirements ■ EN 61326-1/-2-3 EMC requirements for electrical equipment for measurement, control and laboratory use ■ NAMUR NE 21 Electromagnetic compatibility (EMC) of industrial process and laboratory control equipment ■ NAMUR NE 32 Data retention in the event of a power failure in field and control instruments with microprocessors ■ NAMUR NE 43 Standardization of the signal level for the breakdown information of digital transmitters with analog output signal. ■ NAMUR NE 53 Software of field devices and signal-processing devices with digital electronics ■ NAMUR NE 105 Specifications for integrating fieldbus devices in engineering tools for field devices ■ NAMUR NE 107 Self-monitoring and diagnostics of field devices ■ NAMUR NE 131 Requirements for field devices for standard applications ■ ETSI EN 300 328 Guidelines for 2.4 GHz radio components. ■ EN 301489 Electromagnetic compatibility and radio spectrum matters (ERM).
-----------------------------------	--

16.13 Application packages

Many different application packages are available to enhance the functionality of the device. Such packages might be needed to address safety aspects or specific application requirements.

The application packages can be ordered with the device or subsequently from Endress+Hauser. Detailed information on the order code in question is available from your local Endress+Hauser sales center or on the product page of the Endress+Hauser website: www.endress.com.

Diagnostic functionality	<p>Order code for "Application package", option EA "Extended HistoROM"</p> <p>Comprises extended functions concerning the event log and the activation of the measured value memory.</p> <p>Event log: Memory volume is extended from 20 message entries (standard version) to up to 100 entries.</p>
--------------------------	---

Data logging (line recorder):

- Memory capacity for up to 1000 measured values is activated.
- 250 measured values can be output via each of the 4 memory channels. The recording interval can be defined and configured by the user.
- Measured value logs can be accessed via the local display or operating tool e.g. FieldCare, DeviceCare or Web server.



For detailed information, see the Operating Instructions for the device.

Heartbeat Technology

Order code for "Application package", option EB "Heartbeat Verification + Monitoring"

Heartbeat Verification

Meets the requirement for traceable verification in accordance with DIN ISO 9001:2015 Clause 7.6 a) "Control of monitoring and measuring equipment".

- Functional testing in the installed state without interrupting the process.
- Traceable verification results on request, including a report.
- Simple testing process via local operation or other operating interfaces.
- Clear measuring point assessment (pass/fail) with high total test coverage within the framework of manufacturer specifications.
- Extension of calibration intervals according to operator's risk evaluation.

Heartbeat Monitoring

Continuously supplies data, which are characteristic of the measuring principle, to an external condition monitoring system for the purpose of preventive maintenance or process analysis. These data enable the operator to:

- Draw conclusions - using these data and other information - about the impact the process influences (e.g. buildup, magnetic field interferences) have on measuring performance over time.
- Schedule servicing in time.
- Monitor the process or product quality.



Detailed information on Heartbeat Technology:
Special Documentation → 209

Cleaning

Order code for "Application package", option EC "ECC electrode cleaning "

The electrode cleaning circuit (ECC) function has been developed to have a solution for applications where magnetite (Fe_3O_4) deposits frequently occur (e.g. hot water). Since magnetite is highly conductive this build up leads to measuring errors and ultimately to the loss of signal. The application package is designed to avoid build-up of very conductive matter and thin layers (typical of magnetite).



For detailed information, see the Operating Instructions for the device.

16.14 Accessories



Overview of accessories available to order → 177

16.15 Documentation



For an overview of the scope of the associated Technical Documentation, refer to the following:

- *Device Viewer* (www.endress.com/deviceviewer): Enter the serial number from the nameplate
- *Endress+Hauser Operations app*: Enter serial number from nameplate or scan matrix code on nameplate.

Standard documentation **Brief Operating Instructions***Brief Operating Instructions for the sensor*

Measuring device	Documentation code
Proline Promag H	KA01289D

Brief operating instructions for transmitter

Measuring instrument	Documentation code
Proline 500	KA01734D
Proline 500 – digital	KA01735D

Technical Information

Measuring device	Documentation code
Promag H 500	TI01225D

Description of Device Parameters

Measuring instrument	Documentation code
Promag 500	GP01237D

Device-dependent
additional documentation**Safety instructions**

Safety instructions for electrical equipment for hazardous areas.



Contents	Documentation code
ATEX/IECEX Ex ia	XA01522D
ATEX/IECEX Ex ec	XA01523D
cCSAus IS	XA01524D
cCSAus Ex e ia	XA01525D
cCSAus Ex ec	XA01526D
EAC Ex Ex ia	XA01658D
EAC Ex ec	XA01659D
JPN Ex ia	XA01776D
KCs Ex ia	XA03281D
INMETRO Ex ia	XA01527D
INMETRO Ex ec	XA01528D
NEPSI Ex ia	XA01529D
NEPSI Ex ec	XA01530D
UKEX Ex ia	XA02560D
UKEX Ex ec	XA02561D

Special Documentation

Contents	Documentation code
Information on the Pressure Equipment Directive	SD01614D
Radio approvals for WLAN interface for A309/A310 display module	SD01793D

Contents	Documentation code
Heartbeat Technology	SD03346D
Modbus TCP system integration	SD03383D

Installation instructions

Contents	Comment
Installation instructions for spare part sets and accessories	<ul style="list-style-type: none"> ▪ Access the overview of all the available spare part sets via <i>Device Viewer</i> →  175 ▪ Accessories available for order with Installation Instructions →  177

Index

A

- Access authorization to parameters
 - Read access 80
 - Write access 80
- Access code 80
 - Incorrect input 80
- Adapters 28
- Adapting the diagnostic behavior 163
- Additional certification 206
- Ambient conditions
 - Ambient temperature 28
 - Mechanical load 195
 - Operating height 194
 - Relative humidity 194
- Ambient temperature
 - Influence 194
- Ambient temperature range 28, 194
- Application 180
- Applicator 180
- Approvals 204
- Attaching the connecting cable
 - Proline 500 transmitter 58

C

- Cable entries
 - Technical data 191
- Cable entry
 - Degree of protection 65
- CE mark 10, 205
- Certifications 204
- cGMP 206
- Check
 - Connection 66
 - Received goods 16
- Checklist
 - Post-connection check 66
 - Post-installation check 37
- CIP cleaning 197
- Commissioning 95
 - Advanced settings 122
 - Configuring the device 96
- Conductivity 196
- Configuring error response mode, Modbus RS485 . . 163
- Connecting the connecting cable
 - Proline 500 – digital transmitter 52
 - Proline 500 terminal assignment 56
 - Sensor connection housing, Proline 500 56
 - Sensor connection housing, Proline 500 – digital . . 48
 - Terminal assignment of Proline 500 – digital 48
- Connecting the device
 - Proline 500 56
 - Proline 500 – digital 48
- Connecting the signal cable/supply voltage cable
 - Proline 500 – digital transmitter 53
- Connection
 - see Electrical connection

- Connection cable 38
- Connection examples, potential equalization 59
- Connection preparations 44
- Connection tool 38
- Context menu
 - Calling up 76
 - Closing 76
 - Explanation 76
- Current consumption 191

D

- Declaration of Conformity 10
- Defining the access code 141, 142
- Degree of protection 65, 195
- Design
 - Measuring device 14
- Device
 - Configuring 96
 - Preparing for electrical connection 44
- Device components 14
- Device description files 94
- Device locking, status 145
- Device name
 - Sensor 19
 - Transmitter 17
- Device repair 175
- Device revision 94
- Device type ID 94
- Device Viewer 175
- DeviceCare 93
 - Device description file 94
- Diagnostic behavior
 - Explanation 159
 - Symbols 159
- Diagnostic information
 - Communication interface 162
 - Design, description 159, 162
 - DeviceCare 161
 - FieldCare 161
 - LED 155
 - Local display 158
 - Overview 163
 - Remedial actions 163
 - Web browser 160
- Diagnostic list 168
- Diagnostic message 158
- Diagnostics
 - Symbols 158
- DIP switch
 - see Write protection switch
- Direct access 78
- Disabling write protection 141
- Display
 - see Local display
- Display area
 - For operational display 71

In the navigation view	72
Display values	
For locking status	145
Disposal	176
Document	
Function	6
Symbols	6
Document function	6
Documentation	208
Down pipe	23
E	
ECC	130
Editing view	74
Input screen	75
Using operating elements	74, 75
Electrical connection	
Computer with web browser	89
Degree of protection	65
Measuring instrument	38
Operating tool (e.g. FieldCare, DeviceCare, AMS Device Manager, SIMATIC PDM)	89
Operating tools	
Via Modbus TCP over Ethernet-APL protocol	89
Via service interface (CDI-RJ45)	90
Via WLAN interface	91
Web server	90
WLAN interface	91
Electromagnetic compatibility	195
Electronics module	14
Enabling write protection	141
Enabling/disabling the keypad lock	81
Environment	
Storage temperature	194
Environmental conditions	
Vibration resistance and shock resistance	195
Error messages	
see Diagnostic messages	
Event logbook	169
Ex-approval	205
Extended order code	
Sensor	19
Transmitter	17
F	
Field of application	
Residual risks	10
FieldCare	93
Device description file	94
Function	93
Filtering the event logbook	170
Firmware	
Release date	94
Version	94
Firmware history	173
Fitted electrodes	200
Flow direction	25
Flow limit	197

Functions	
see Parameters	
G	
Galvanic isolation	189
H	
Hardware write protection	142
Help text	
Calling up	79
Closing	79
Explanation	79
HistoROM	133
I	
Identifying the measuring instrument	16
Incoming acceptance	16
Indication	
Current diagnostic event	168
Previous diagnostic event	168
Influence	
Ambient temperature	194
Information about this document	6
Inlet runs	26
Input	180
Inspection	
Installation	37
Installation	22
Installation conditions	
System pressure	28
Installation dimensions	28
Installation location	22
Installation requirements	
Adapters	28
Down pipe	23
Inlet and outlet runs	26
Installation dimensions	28
Installation location	22
Length of connecting cable	29
Orientation	25
Partially filled pipe	23
Intended use	9
Internal cleaning	197
L	
Languages, operation options	201
Length of connecting cable	29
Local display	201
Navigation view	72
see Diagnostic message	
see In alarm condition	
see Operational display	
Text editor	74
Low flow cut off	189
M	
Main electronics module	14
Maintenance tasks	174
Replacing seals	174
Managing the device configuration	133

- Manufacturer ID 94
 - Manufacturing date 17, 19
 - Materials 198
 - Maximum measurement error 192
 - Measured values
 - Calculated 180
 - Measured 180
 - see Process variables
 - Measuring and test equipment 174
 - Measuring device
 - Conversion 175
 - Design 14
 - Preparing for mounting 31
 - Repairs 175
 - Measuring instrument
 - Disposal 176
 - Installing the sensor 31
 - Installing grounding rings 32
 - Installing the seals 32
 - Welding nipple 31
 - Integrating via communication protocol 94
 - Removing 176
 - Switch on 95
 - Measuring principle 180
 - Measuring range 180
 - Measuring system 180
 - Measuring tube specification 198
 - Mechanical load 195
 - Medium temperature range 195
 - Menu
 - Diagnostics 168
 - Setup 96
 - Menus
 - For device configuration 96
 - For specific settings 122
 - Modbus RS485
 - Configuring error response mode 163
 - Diagnostic information 162
 - Mounting dimensions
 - see Installation dimensions
 - Mounting preparations 31
 - Mounting requirements
 - Vibrations 28
 - Mounting tool 30
- N**
- Nameplate
 - Sensor 19
 - Transmitter 17
 - Navigation path (navigation view) 72
 - Navigation view
 - In the submenu 72
 - In the wizard 72
 - Netilion 174
 - Numeric editor 74
- O**
- Onsite display
 - Numeric editor 74
 - Operable flow range 182
 - Operating elements 76, 159
 - Operating height 194
 - Operating keys
 - see Operating elements
 - Operating menu
 - Menus, submenus 68
 - Structure 68
 - Submenus and user roles 69
 - Operating philosophy 69
 - Operation 145
 - Operation options 67
 - Operational display 70
 - Operational safety 10
 - Order code 17, 19
 - Orientation (vertical, horizontal) 25
 - Outlet runs 26
 - Output signal 184
 - Output variables 184
- P**
- Packaging disposal 22
 - Parameter
 - Changing 79
 - Entering values or text 79
 - Parameter settings
 - Administration (Submenu) 136
 - Advanced setup (Submenu) 122
 - APL port (Submenu) 98
 - Communication (Submenu) 97
 - Configuration backup (Submenu) 133
 - Configure flow damping (Wizard) 120
 - Current input 103
 - Current input 1 to n (Submenu) 147
 - Current input 1 to n (Wizard) 103
 - Current output 105
 - Current output (Wizard) 105
 - Custody transfer activation (Wizard) 126
 - Custody transfer deactivation (Wizard) 124
 - Define access code (Wizard) 135
 - Device information (Submenu) 172
 - Diagnostic event simulation (Submenu) 140
 - Diagnostics (Menu) 168
 - Display (Submenu) 128
 - Display (Wizard) 115
 - Double pulse output 114
 - Double pulse output (Submenu) 150
 - Double pulse output (Wizard) 114
 - Electrode cleaning cycle (Submenu) 130
 - Empty pipe detection (Wizard) 119
 - Heartbeat base settings (Submenu) 133
 - I/O configuration 102
 - I/O configuration (Submenu) 102
 - Input simulation (Submenu) 138
 - Low flow cutoff (Wizard) 118
 - Network diagnostics (Submenu) 100
 - Output simulation (Submenu) 139
 - Process value simulation (Submenu) 138
 - Process variables (Submenu) 145

- Pulse/frequency/switch output 1 to n (Submenu) 149
- Pulse/frequency/switch output 1 to n (Wizard) . . 108
- Relay output 112
- Relay output 1 to n (Submenu) 149
- Relay output 1 to n (Wizard) 112
- Reset access code (Submenu) 135
- Sensor adjustment (Submenu) 122
- Service interface (Submenu) 99
- Setup (Menu) 96
- Simulation (Submenu) 136
- Status input 104
- Status input 1 to n (Submenu) 147
- Status input 1 to n (Wizard) 104
- System units (Submenu) 100
- Totalizer (Submenu) 150
- Totalizer 1 to n (Submenu) 123
- Totalizer handling (Submenu) 151
- Value current output 1 to n (Submenu) 148
- Web server (Submenu) 87
- WLAN settings (Wizard) 131
- Partially filled pipe 23
- Performance characteristics 192
- Pharmaceutical compatibility 206
- Post-connection check 95
- Post-connection check (checklist) 66
- Post-installation check 95
- Post-installation check (checklist) 37
- Potential equalization 58
- Power consumption 191
- Power supply failure 191
- Pressure Equipment Directive 206
- Pressure loss 197
- Pressure tightness 197
- Pressure/temperature ratings 197
- Process conditions
 - Conductivity 196
 - Flow limit 197
 - Fluid temperature 195
 - Pressure loss 197
 - Pressure tightness 197
- Process connections 200
- Product safety 10
- Proline 500 – digital transmitter
 - Connecting the signal cable/supply voltage cable . . 53
- Proline 500 connecting cable terminal assignment
 - Sensor connection housing 56
- Protecting parameter settings 141
- R**
- Radio approval 206
- Read access 80
- Reading off measured values 145
- Reading out diagnostic information, Modbus RS485 162
- Recalibration 174
- Reference operating conditions 192
- Registered trademarks 8
- Remedial actions
 - Calling up 160
 - Closing 160
- Remote operation 202
- Repair 175
 - Notes 175
- Repair of a device 175
- Repeatability 193
- Replacement
 - Device components 175
- Replacing seals 174
- Requirements for personnel 9
- Return 175
- S**
- Safety 9
- Sanitary compatibility 205
- Sensor
 - Installing 31
- Serial number 17, 19
- Services
 - Maintenance 174
 - Repair 175
- Setting the operating language 95
- Settings
 - Adapting the measuring device to the process
 - conditions 151
 - Administration 134
 - Advanced display configurations 128
 - Communication interface 97
 - Current input 103
 - Current output 105
 - Double pulse output 114
 - Electrode cleaning circuit (ECC) 130
 - Empty pipe detection (EPD) 119
 - I/O configuration 102
 - Local display 115
 - Low flow cut off 118
 - Managing the device configuration 133
 - Operating language 95
 - Relay output 112
 - Resetting the device 171
 - Resetting the totalizer 151
 - Sensor adjustment 122
 - Simulation 136
 - Status input 104
 - System units 100
 - Totalizer 123
 - Totalizer reset 151
 - WLAN 131
- Signal on alarm 187
- SIP cleaning 197
- Software release 94
- Spare part 175
- Spare parts 175
- Special connection instructions 60
- Special mounting instructions
 - Hygienic compatibility 30
- Standards and guidelines 207
- Status area
 - For operational display 70
 - In the navigation view 72

- Status signals 158, 161
- Storage concept 203
- Storage conditions 21
- Storage temperature 21
- Storage temperature range 194
- Structure
 - Operating menu 68
- Submenu
 - Administration 134, 136
 - Advanced setup 122
 - APL port 98
 - Communication 97
 - Configuration backup 133
 - Current input 1 to n 147
 - Device information 172
 - Diagnostic event simulation 140
 - Display 128
 - Double pulse output 150
 - Electrode cleaning cycle 130
 - Event logbook 169
 - Heartbeat base settings 133
 - I/O configuration 102
 - Input simulation 138
 - Input values 147
 - Measured values 145
 - Network diagnostics 100
 - Output simulation 139
 - Output values 148
 - Overview 69
 - Process value simulation 138
 - Process variables 145
 - Pulse/frequency/switch output 1 to n 149
 - Relay output 1 to n 149
 - Reset access code 135
 - Sensor adjustment 122
 - Service interface 99
 - Simulation 136
 - Status input 1 to n 147
 - System units 100
 - Totalizer 150
 - Totalizer 1 to n 123
 - Totalizer handling 151
 - Value current output 1 to n 148
 - Web server 87
- Supply voltage 191
- Surface roughness 201
- Switching output 186
- Symbols
 - Controlling data entries 75
 - For communication 70
 - For diagnostic behavior 70
 - For locking 70
 - For measured variable 71
 - For measurement channel number 71
 - For menus 72
 - For parameters 72
 - For status signal 70
 - For submenu 72
 - For wizards 72
- In the status area of the local display 70
- Input screen 75
- Operating elements 74
- System design
 - Measuring system 180
 - see Measuring device design
- System integration 94
- System pressure 28
- T**
 - Technical data, overview 180
 - Temperature measurement response time 194
 - Temperature range
 - Ambient temperature for display 201
 - Storage temperature 21
 - Terminal assignment 42
 - Terminal assignment of connecting cable for Proline 500- digital
 - Sensor connection housing 48
 - Terminals 191
 - Tests and certificates 206
 - Text editor 74
 - Tool
 - For electrical connection 38
 - For mounting 30
 - Transportation 21
 - Tool tip
 - see Help text
 - Totalizer
 - Assign process variable 150
 - Configuring 123
 - Transmitter
 - Turning the display module 36
 - Turning the housing 36
 - Transporting the measuring instrument 21
 - Troubleshooting
 - General 153
 - TSE/BSE Certificate of Suitability 206
 - Turning the display module 36
 - Turning the electronics housing
 - see Turning the transmitter housing
 - Turning the transmitter housing 36
- U**
 - UKCA marking 205
 - Use of the measuring instrument
 - Borderline cases 9
 - Incorrect use 9
 - see Intended use
 - User roles 69
 - USP Class VI 206
- V**
 - Version data for the device 94
 - Vibration resistance and shock resistance 195
 - Vibrations 28
- W**
 - W@M Device Viewer 16

Weight	
Transport (notes)	21
Wizard	
Configure flow damping	120
Current input 1 to n	103
Current output	105
Custody transfer activation	126
Custody transfer deactivation	124
Define access code	135
Display	115
Double pulse output	114
Empty pipe detection	119
Low flow cutoff	118
Pulse/frequency/switch output 1 to n	108
Relay output 1 to n	112
Status input 1 to n	104
WLAN settings	131
WLAN settings	131
Workplace safety	10
Write access	80
Write protection	
Via access code	141
Via write protection switch	142
Write protection switch	142



www.addresses.endress.com
