

# Brief Operating Instructions

## **Proline Promag P 200**

Electromagnetic flowmeter

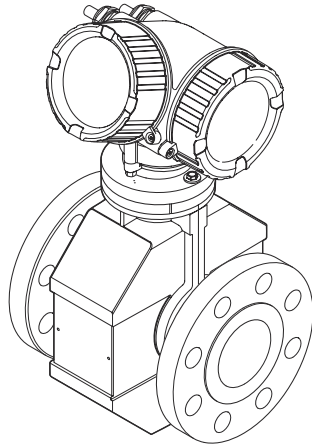

These are Brief Operating Instructions; they do not replace the Operating Instructions included in the scope of supply.

These Brief Operating Instructions contain all of the information on the sensor. Please also follow the Brief Operating Instructions for the transmitter during commissioning .

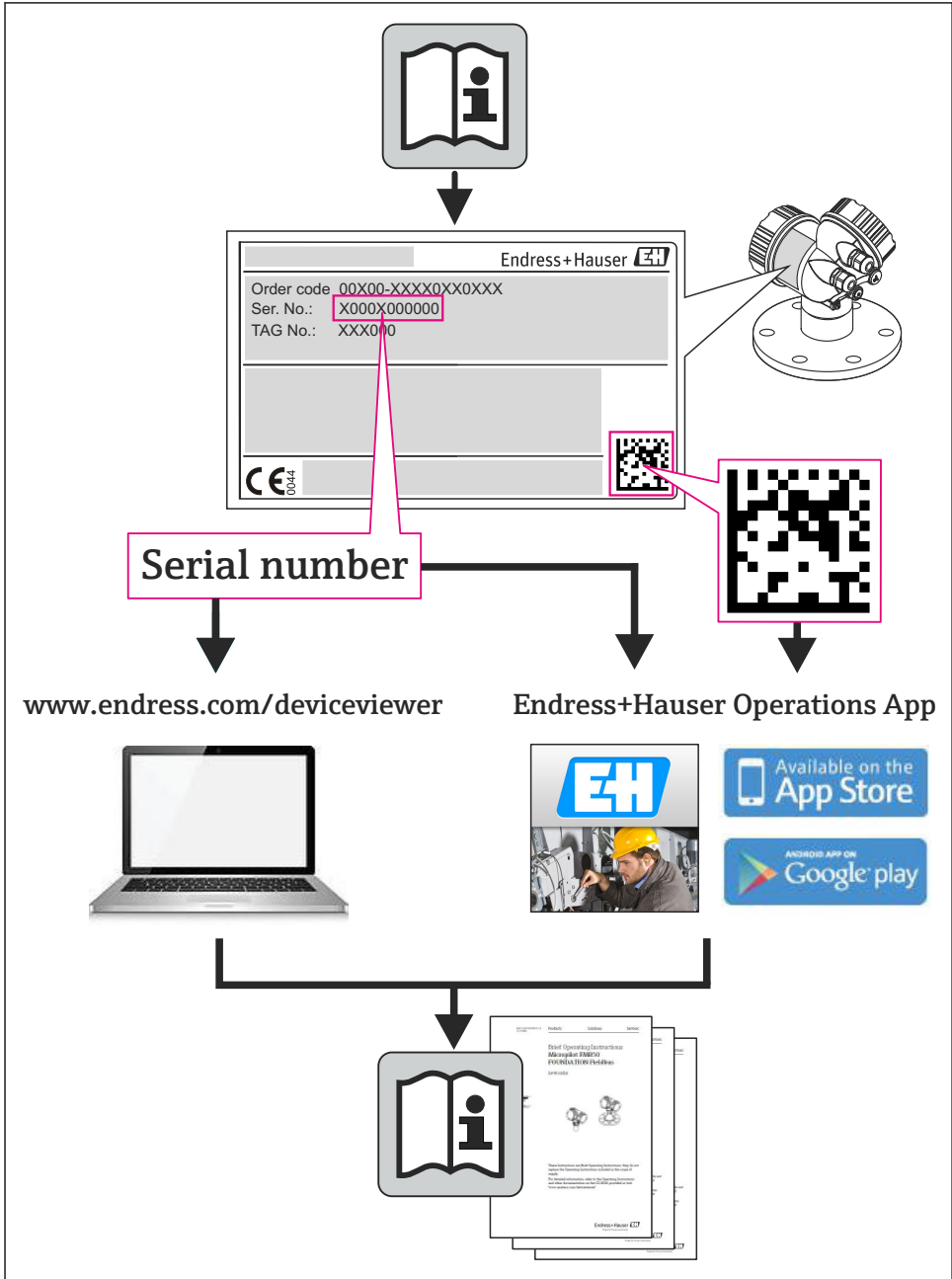

A0023555





# Table of contents

|           |   |           |
|-----------|---|-----------|
| <b>1</b>  | <b>Document information</b>                           | <b>4</b>  |
| 1.1       | Symbols used  | 4         |
| <b>2</b>  | <b>Basic safety instructions</b>                      | <b>5</b>  |
| 2.1       | Requirements for the personnel                        | 5         |
| 2.2       | Designated use  | 6         |
| 2.3       | Workplace safety                                      | 7         |
| 2.4       | Operational safety                                    | 7         |
| 2.5       | Product safety  | 7         |
| 2.6       | IT security   | 7         |
| <b>3</b>  | <b>Product description</b>                            | <b>7</b>  |
| 3.1       | Product design  | 8         |
| <b>4</b>  | <b>Incoming acceptance and product identification</b> | <b>9</b>  |
| 4.1       | Incoming acceptance                                   | 9         |
| 4.2       | Product identification                                | 10        |
| <b>5</b>  | <b>Storage and transport</b>                          | <b>10</b> |
| 5.1       | Storage conditions                                    | 10        |
| 5.2       | Transporting the product                              | 10        |
| <b>6</b>  | <b>Installation</b>                                   | <b>12</b> |
| 6.1       | Installation conditions                               | 12        |
| 6.2       | Mounting the measuring device                         | 16        |
| 6.3       | Post-installation check                               | 19        |
| <b>7</b>  | <b>Electrical connection</b>                          | <b>20</b> |
| 7.1       | Connection conditions                                 | 20        |
| 7.2       | Connecting the measuring device                       | 26        |
| 7.3       | Hardware settings                                     | 28        |
| 7.4       | Ensuring the degree of protection                     | 30        |
| 7.5       | Post-connection check                                 | 30        |
| <b>8</b>  | <b>Operation options</b>                              | <b>31</b> |
| 8.1       | Structure and function of the operating menu          | 31        |
| 8.2       | Access to the operating menu via the local display    | 32        |
| 8.3       | Access to the operating menu via the operating tool   | 36        |
| <b>9</b>  | <b>System integration</b>                             | <b>36</b> |
| 9.1       | FOUNDATION Fieldbus cyclic data transmission          | 36        |
| 9.2       | Cyclic data transfer PROFIBUS PA                      | 39        |
| <b>10</b> | <b>Commissioning</b>                                  | <b>42</b> |
| 10.1      | Function check  | 42        |
| 10.2      | Switching on the measuring device                     | 43        |
| 10.3      | Setting the operating language                        | 43        |
| 10.4      | Configuring the measuring device                      | 43        |
| 10.5      | Defining the tag name                                 | 44        |
| 10.6      | Protecting settings from unauthorized access          | 44        |
| <b>11</b> | <b>Diagnostic information</b>                         | <b>45</b> |







# 1 Document information

## 1.1 Symbols used





### 1.1.1 Safety symbols

| Symbol   | Meaning  |
|--|--|
|  | <b>DANGER!</b><br>This symbol alerts you to a dangerous situation. Failure to avoid this situation will result in serious or fatal injury. |
|  | <b>WARNING!</b><br>This symbol alerts you to a dangerous situation. Failure to avoid this situation can result in serious or fatal injury. |
|  | <b>CAUTION!</b><br>This symbol alerts you to a dangerous situation. Failure to avoid this situation can result in minor or medium injury.  |
|  | <b>NOTE!</b><br>This symbol contains information on procedures and other facts which do not result in personal injury.                     |









### 1.1.2 Electrical symbols

| Symbol   | Meaning  | Symbol  | Meaning  |
|--|--|---|--|
|    | Direct current   |    | Alternating current  |
|    | Direct current and alternating current   |    | <b>Ground connection</b><br>A grounded terminal which, as far as the operator is concerned, is grounded via a grounding system.  |
|  | <b>Protective ground connection</b><br>A terminal which must be connected to ground prior to establishing any other connections. |  | <b>Equipotential connection</b><br>A connection that has to be connected to the plant grounding system: This may be a potential equalization line or a star grounding system depending on national or company codes of practice. |



### 1.1.3 Tool symbols

| Symbol   | Meaning                   | Symbol  | Meaning                |
|--|---------------------------|---|------------------------|
|  | Torx screwdriver          |  | Flat blade screwdriver |
|  | Phillips head screwdriver |  | Allen key              |
|  | Open-ended wrench         |   |                        |

### 1.1.4 Symbols for certain types of information

| Symbol  | Meaning  | Symbol  | Meaning  |
|---|--|---|--|
|  | <b>Permitted</b><br>Procedures, processes or actions that are permitted. |  | <b>Preferred</b><br>Procedures, processes or actions that are preferred. |
|  | <b>Forbidden</b><br>Procedures, processes or actions that are forbidden. |  | <b>Tip</b><br>Indicates additional information.                          |
|  | Reference to documentation   |  | Reference to page  |
|  | Reference to graphic   | 1. 2. 3. ...  | Series of steps  |
|  | Result of a step   |  | Visual inspection  |

### 1.1.5 Symbols in graphics

| Symbol  | Meaning        | Symbol  | Meaning                        |
|---|----------------|---|--------------------------------|
| 1, 2, 3, ...  | Item numbers   | 1. 2. 3. ...  | Series of steps                |
| A, B, C, ...  | Views          | A-A, B-B, C-C, ...  | Sections                       |
|  | Hazardous area |  | Safe area (non-hazardous area) |
|  | Flow direction |   |                                |

## 2 Basic safety instructions

### 2.1 Requirements for the personnel

The personnel must fulfill the following requirements for its tasks:

- ▶ Trained, qualified specialists must have a relevant qualification for this specific function and task
- ▶ Are authorized by the plant owner/operator
- ▶ Are familiar with federal/national regulations
- ▶ Before beginning work, the specialist staff must have read and understood the instructions in the Operating Instructions and supplementary documentation as well as in the certificates (depending on the application)
- ▶ Following instructions and basic conditions

## 2.2 Designated use

### Application and media

The measuring device is only suitable for flow measurement of liquids with a minimum conductivity of 20  $\mu\text{S}/\text{cm}$ .

Depending on the version ordered, the measuring device can also measure potentially explosive, flammable, poisonous and oxidizing media.

Measuring devices for use in hazardous areas, in hygienic applications or in applications where there is an increased risk due to process pressure, are labeled accordingly on the nameplate.

To ensure that the measuring device remains in proper condition for the operation time:

- ▶ Only use the measuring device in full compliance with the data on the nameplate and the general conditions listed in the Operating Instructions and supplementary documentation.
- ▶ Check the nameplate to verify if the device ordered can be put to its intended use in the approval-related area (e.g. explosion protection, pressure vessel safety).
- ▶ Use the measuring device only for media against which the process-wetted materials are adequately resistant.
- ▶ If the measuring device is not operated at atmospheric temperature, compliance with the relevant basic conditions specified in the associated device documentation is absolutely essential.
- ▶ Protect the measuring device permanently against corrosion from environmental influences.

### Incorrect use

Non-designated use can compromise safety. The manufacturer is not liable for damage caused by improper or non-designated use.

### WARNING

#### **Danger of breakage of the sensor due to corrosive or abrasive fluids or from environmental conditions!**

- ▶ Verify the compatibility of the process fluid with the sensor material.
- ▶ Ensure the resistance of all fluid-wetted materials in the process.
- ▶ Keep within the specified pressure and temperature range.

Verification for borderline cases:

- ▶ For special fluids and fluids for cleaning, Endress+Hauser is glad to provide assistance in verifying the corrosion resistance of fluid-wetted materials, but does not accept any warranty or liability as minute changes in the temperature, concentration or level of contamination in the process can alter the corrosion resistance properties.

### Residual risks

The external surface temperature of the housing can increase by max. 10 K due to the power consumption of the electronic components. Hot process fluids passing through the measuring device will further increase the surface temperature of the housing. The surface of the sensor, in particular, can reach temperatures which are close to the fluid temperature.

Possible burn hazard due to fluid temperatures!

- ▶ For elevated fluid temperature, ensure protection against contact to prevent burns.

## 2.3 Workplace safety

For work on and with the device:

- ▶ Wear the required personal protective equipment according to federal/national regulations.

For welding work on the piping:

- ▶ Do not ground the welding unit via the measuring device.

If working on and with the device with wet hands:

- ▶ It is recommended to wear gloves on account of the higher risk of electric shock.

## 2.4 Operational safety

Risk of injury.

- ▶ Operate the device in proper technical condition and fail-safe condition only.
- ▶ The operator is responsible for interference-free operation of the device.

## 2.5 Product safety

This measuring device is designed in accordance with good engineering practice to meet state-of-the-art safety requirements, has been tested, and left the factory in a condition in which it is safe to operate.

It meets general safety standards and legal requirements. It also complies with the EC directives listed in the device-specific EC Declaration of Conformity. Endress+Hauser confirms this by affixing the CE mark to the device.

## 2.6 IT security

We only provide a warranty if the device is installed and used as described in the Operating Instructions. The device is equipped with security mechanisms to protect it against any inadvertent changes to the device settings.

IT security measures in line with operators' security standards and designed to provide additional protection for the device and device data transfer must be implemented by the operators themselves.

# 3 Product description

The device consists of a transmitter and a sensor.

The device is available as a compact version:

The transmitter and sensor form a mechanical unit.



For detailed information on the product description, see the Operating Instructions for the device.

### 3.1 Product design

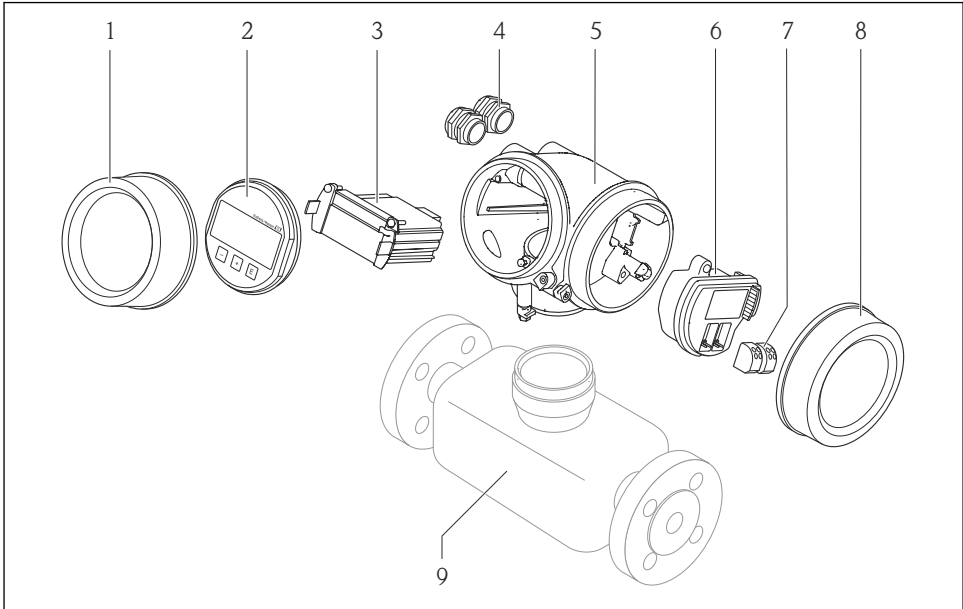

A0014056

#### 1 Important components of a measuring device

- 1 Electronics compartment cover
- 2 Display module
- 3 Main electronics module
- 4 Cable glands
- 5 Transmitter housing (incl. integrated HistoROM)
- 6 I/O electronics module
- 7 Terminals (pluggable spring terminals)
- 8 Connection compartment cover
- 9 Sensor

# 4 Incoming acceptance and product identification

## 4.1 Incoming acceptance



1  
+  
2



1  
+  
2

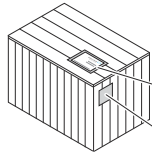

Are the order codes on the delivery note (1) and the product sticker (2) identical?

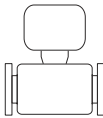
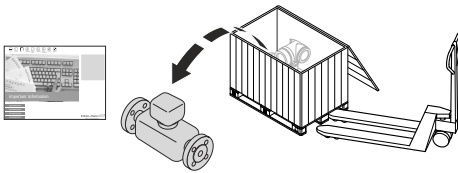

Are the goods undamaged?

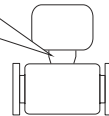
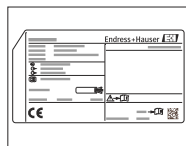
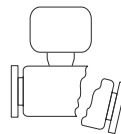

Do the nameplate data match the ordering information on the delivery note?



Is the CD-ROM with the Technical Documentation (depends on device version) and documents present?



- If one of the conditions is not satisfied, contact your Endress+Hauser Sales Center.
- Depending on the device version, the CD-ROM might not be part of the delivery! The Technical Documentation is available via the Internet or via the *Endress+Hauser Operations App*.

## 4.2 Product identification

The following options are available for identification of the measuring device:

- Nameplate specifications
- Order code with breakdown of the device features on the delivery note
- Enter serial numbers from nameplates in *W@M Device Viewer* ([www.endress.com/deviceviewer](http://www.endress.com/deviceviewer)): All information about the measuring device is displayed.
- Enter the serial number from the nameplates into the *Endress+Hauser Operations App* or scan the 2-D matrix code (QR code) on the nameplate with the *Endress+Hauser Operations App*: all the information for the measuring device is displayed.

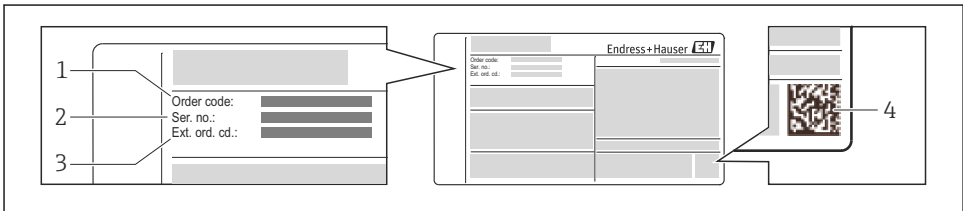

A0021952

### 2 Example of a nameplate

- 1 Order code
- 2 Serial number (Ser. no.)
- 3 Extended order code (Ext. ord. cd.)
- 4 2-D matrix code (QR code)

 For detailed information on the breakdown of the specifications on the nameplate, see the Operating Instructions for the device .

## 5 Storage and transport

### 5.1 Storage conditions

Observe the following notes for storage:

- Store in original packaging.
- Do not remove protective covers or protective caps installed on process connections.
- Protect from direct sunlight.
- Select a storage location where moisture cannot collect in the measuring device.
- Store in a dry and dust-free place.
- Do not store outdoors.

Storage temperature →  12

### 5.2 Transporting the product

Transport the measuring device to the measuring point in the original packaging.

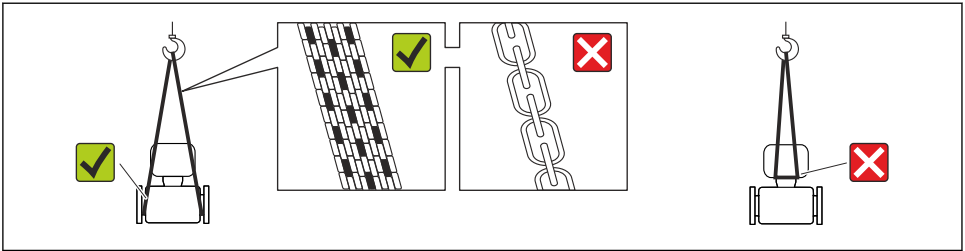

A0015604

**i** Do not remove protective covers or caps installed on process connections. They prevent mechanical damage to the sealing surfaces and contamination in the measuring tube.

### 5.2.1 Measuring devices without lifting lugs

#### **⚠ WARNING**

**Center of gravity of the measuring device is higher than the suspension points of the webbing slings.**

Risk of injury if the measuring device slips.

- ▶ Secure the measuring device against slipping or turning.
- ▶ Observe the weight specified on the packaging (stick-on label).

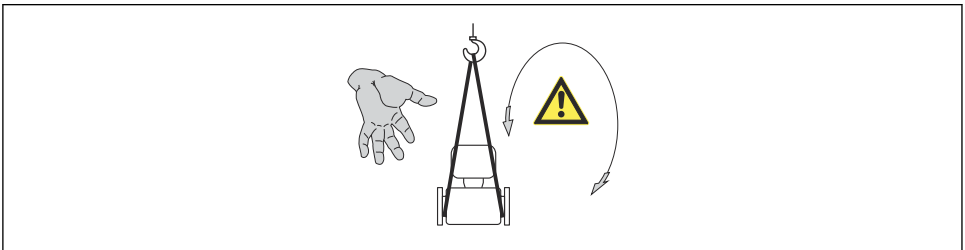

A0015606

### 5.2.2 Measuring devices with lifting lugs

#### **⚠ CAUTION**

**Special transportation instructions for devices with lifting lugs**

- ▶ Only use the lifting lugs fitted on the device or flanges to transport the device.
- ▶ The device must always be secured at two lifting lugs at least.

### 5.2.3 Transporting with a fork lift

If transporting in wood crates, the floor structure enables the crates to be lifted lengthwise or at both sides using a forklift.

**CAUTION**

**Risk of damaging the magnetic coil**

- ▶ If transporting by forklift, do not lift the sensor by the metal casing.
- ▶ This would buckle the casing and damage the internal magnetic coils.

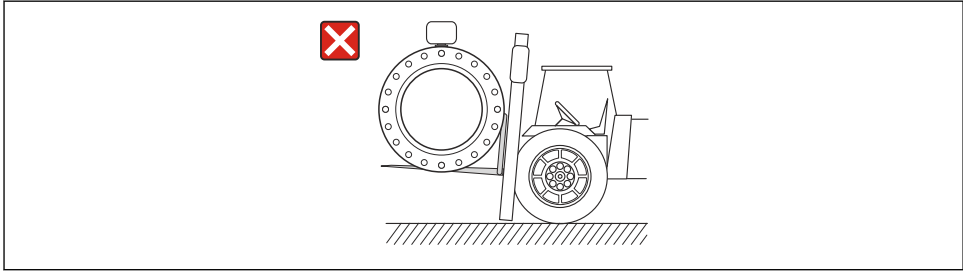

A0023726

## 6 Installation

### 6.1 Installation conditions

#### 6.1.1 Mounting position

##### Mounting location

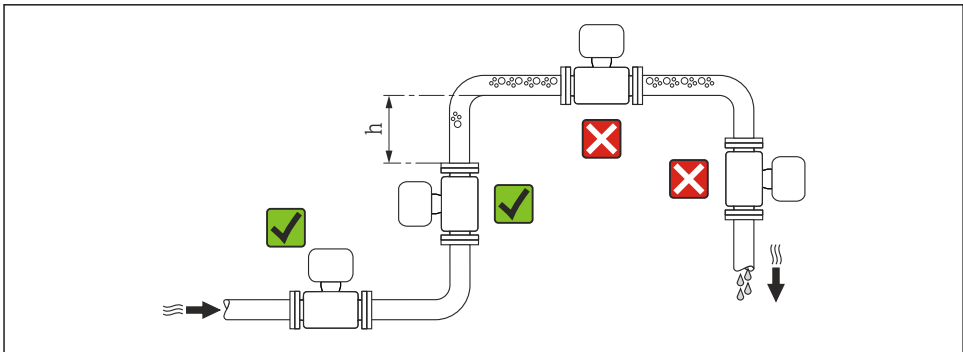

A0023343

$$h \geq 2 \times DN$$

##### Installation in down pipes

Install a siphon with a vent valve downstream of the sensor in down pipes whose length  $h \geq 5 \text{ m}$  (16.4 ft). This precaution is to avoid low pressure and the consequent risk of damage to the measuring tube. This measure also prevents the system losing prime.

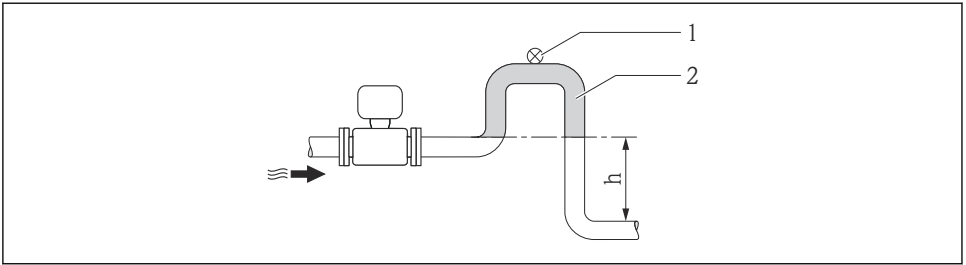

A0017064

3 Installation in a down pipe

- 1 Vent valve
- 2 Pipe siphon
- h Length of down pipe

Installation in partially filled pipes

A partially filled pipe with a gradient necessitates a drain-type configuration.

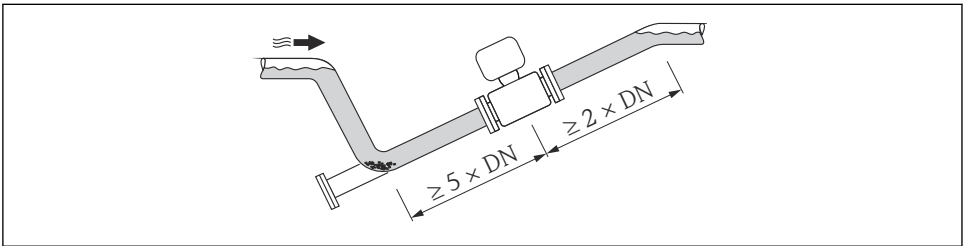

A0017063

**Orientation**

The direction of the arrow on the sensor nameplate helps you to install the sensor according to the flow direction.

An optimum orientation position helps avoid gas and air accumulations and deposits in the measuring tube.

*Vertical*

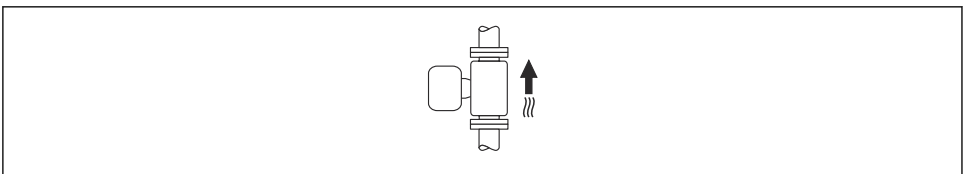

A0015591

Optimum for self-emptying pipe systems and for use in conjunction with empty pipe detection.

### Horizontal

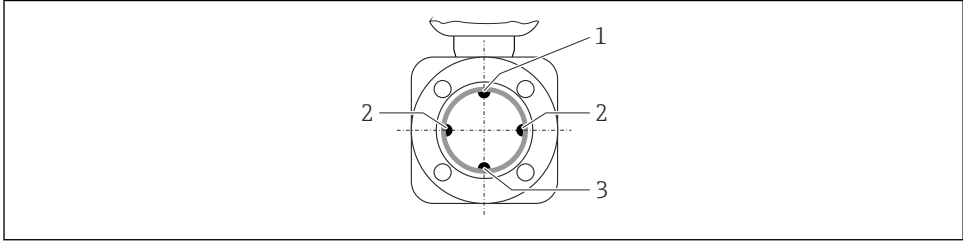

A0016260

- 1 EPD electrode for empty pipe detection
- 2 Measuring electrodes for signal detection
- 3 Reference electrode for potential equalization

-  The measuring electrode plane must be horizontal. This prevents brief insulation of the two measuring electrodes by entrained air bubbles.
- Empty pipe detection only works if the transmitter housing is pointing upwards as otherwise there is no guarantee that the empty pipe detection function will actually respond to a partially filled or empty measuring tube.

### Inlet and outlet runs

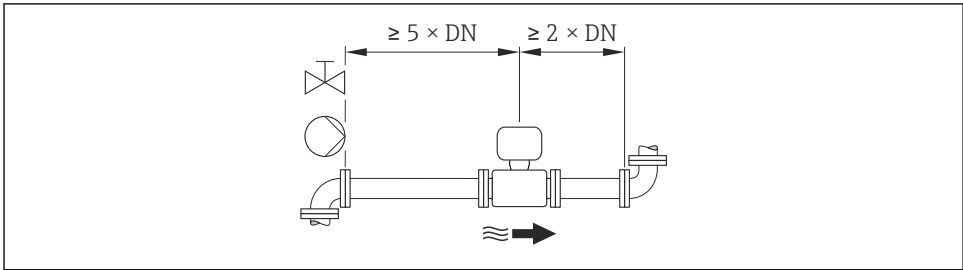

A0016275

-  For the dimensions and installation lengths of the device, see the "Technical Information" document, "Mechanical construction" section

## 6.1.2 Requirements from environment and process

### Ambient temperature range

-  For detailed information on the ambient temperature range, see the Operating Instructions for the device.

If operating outdoors:

- Install the measuring device in a shady location.
- Avoid direct sunlight, particularly in warm climatic regions.
- Avoid direct exposure to weather conditions.

### Temperature tables



Observe the interdependencies between the permitted ambient and fluid temperatures when operating the device in hazardous areas.



For detailed information on the temperature tables, see the separate document entitled "Safety Instructions" (XA) for the device.

### System pressure

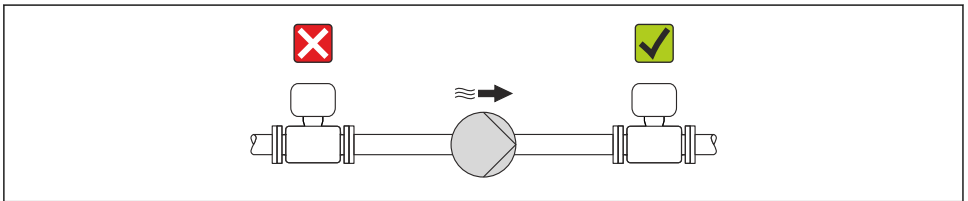

A0015594



Furthermore, install pulse dampers if reciprocating, diaphragm or peristaltic pumps are used.

### Vibrations

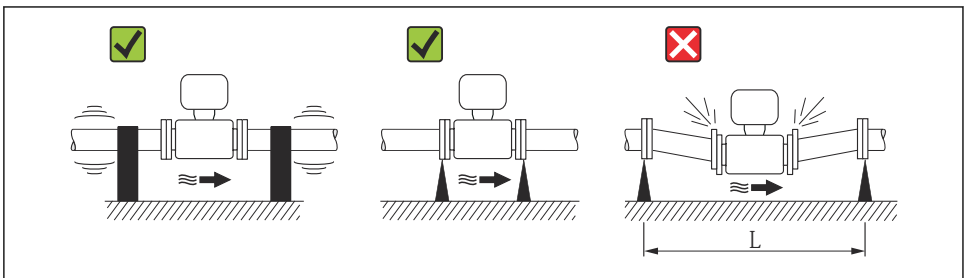

A0016266

- 4 Measures to avoid device vibrations ( $L > 10\text{ m (33 ft)}$ )

## Adapters

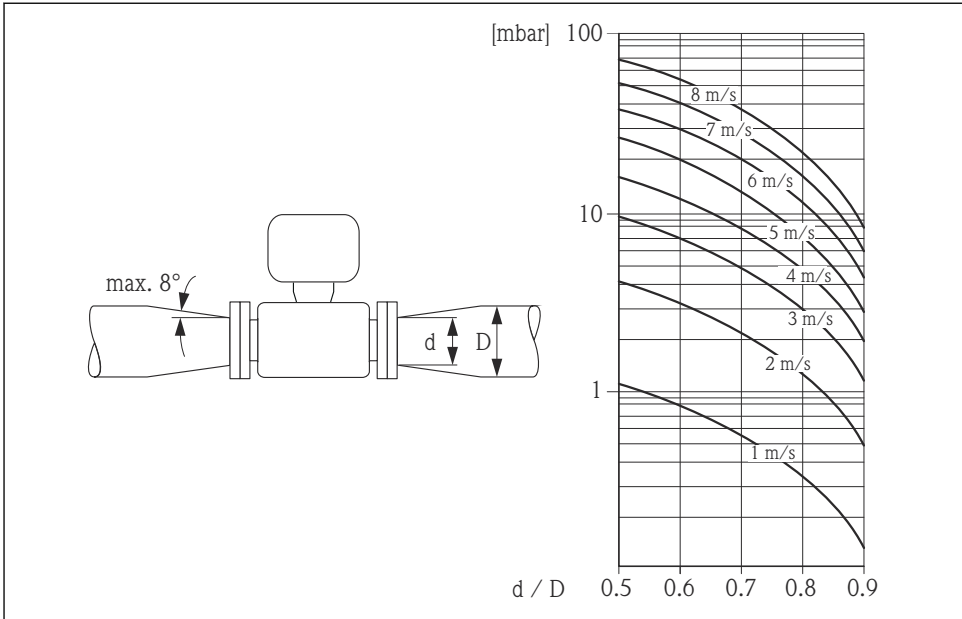

A0016359

### 6.1.3 Special mounting instructions

#### Display protection

- To ensure that the optional display protection can be easily opened, maintain the following minimum head clearance: 350 mm (13.8 in)

## 6.2 Mounting the measuring device

### 6.2.1 Required tools

#### For transmitter

- For turning the transmitter housing: Open-ended wrench 8 mm
- For opening the securing clamps: Allen key 3 mm

#### For sensor

For flanges and other process connections:

- Screws, nuts, seals etc. are not included in the scope of supply and must be provided by the customer.
- Appropriate mounting tools

### 6.2.2 Preparing the measuring device

1. Remove all remaining transport packaging.
2. Remove any protective covers or protective caps present from the sensor.
3. Remove stick-on label on the electronics compartment cover.

### 6.2.3 Mounting the sensor

#### **⚠ WARNING**

#### **Danger due to improper process sealing!**

- ▶ Ensure that the inside diameters of the gaskets are greater than or equal to that of the process connections and piping.
  - ▶ Ensure that the gaskets are clean and undamaged.
  - ▶ Install the gaskets correctly.
1. Ensure that the direction of the arrow on the sensor matches the flow direction of the medium.
  2. To ensure compliance with device specifications, install the measuring device between the pipe flanges in a way that it is centered in the measurement section.
  3. If using ground disks, comply with the Installation Instructions provided.
  4. Observe required screw tightening torques →  18.
  5. Install the measuring device or turn the transmitter housing so that the cable entries do not point upwards.

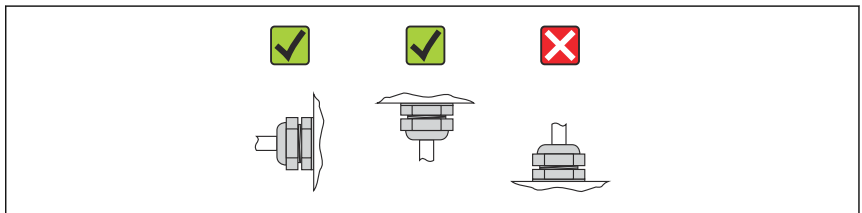

A0013964

### Mounting the seals

#### **⚠ CAUTION**

#### **An electrically conductive layer could form on the inside of the measuring tube!**

Risk of measuring signal short circuit.

- ▶ Do not use electrically conductive sealing compounds such as graphite.

Comply with the following instructions when installing seals:

- Make sure that the seals do not protrude into the piping cross-section.
- For DIN flanges: only use seals according to DIN EN 1514-1.
- For "PFA" lining: generally additional seals are **not** required.
- For "PTFE" lining: generally additional seals are **not** required.

## Mounting the ground cable/ground disks

Comply with the information on potential equalization and detailed mounting instructions for the use of ground cables/ground disks →  28.

## Screw tightening torques

 For detailed information on the screw tightening torques, see the "Mounting the sensor" section of the Operating Instructions for the device

### 6.2.4 Turning the transmitter housing

To provide easier access to the connection compartment or display module, the transmitter housing can be turned.

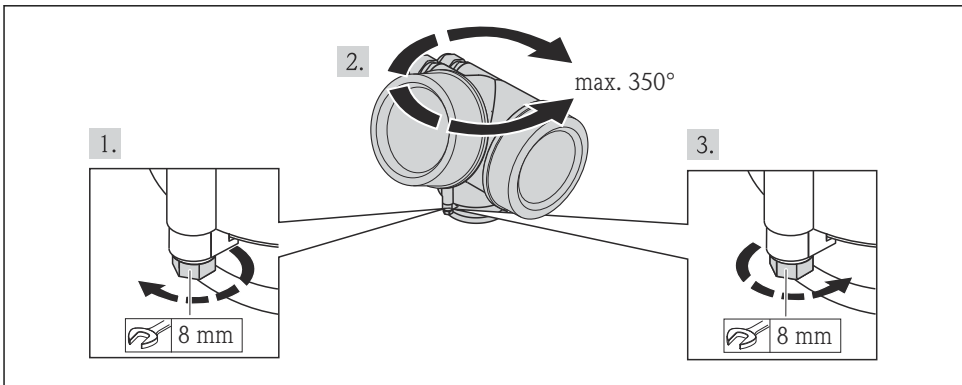

A0013713

### 6.2.5 Turning the display module

The display module can be turned to optimize display readability and operability.

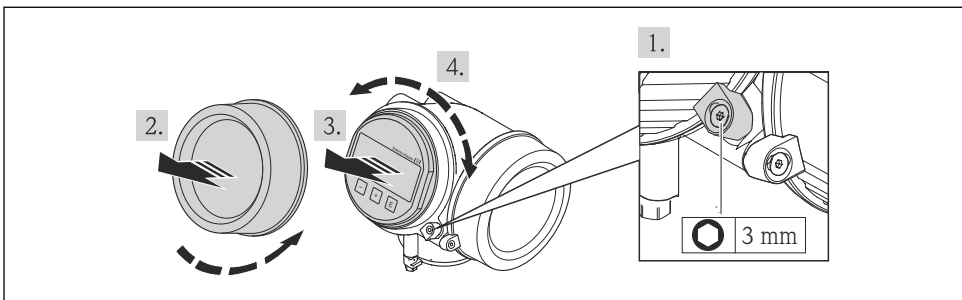

A0013905

## 6.3 Post-installation check

|   |                          |
|---|--------------------------|
| Is the device undamaged (visual inspection)?  | <input type="checkbox"/> |
| Does the measuring device conform to the measuring point specifications?<br>For example:<br><ul style="list-style-type: none"> <li>▪ Process temperature</li> <li>▪ Process pressure (refer to the section on "Pressure-temperature ratings" in the "Technical Information" document on the CD-ROM provided)</li> <li>▪ Ambient temperature</li> <li>▪ Measuring range</li> </ul> | <input type="checkbox"/> |
| Has the correct orientation for the sensor been selected ?<br><ul style="list-style-type: none"> <li>▪ According to sensor type</li> <li>▪ According to medium temperature</li> <li>▪ According to medium properties (outgassing, with entrained solids)</li> </ul>   | <input type="checkbox"/> |
| Does the arrow on the sensor nameplate match the direction of flow of the fluid through the piping ?  | <input type="checkbox"/> |
| Are the measuring point identification and labeling correct (visual inspection)?  | <input type="checkbox"/> |
| Is the device adequately protected from precipitation and direct sunlight?  | <input type="checkbox"/> |
| Have the fixing screws been tightened with the correct tightening torque?   | <input type="checkbox"/> |

## 7 Electrical connection



The measuring device does not have an internal circuit breaker. For this reason, assign the measuring device a switch or power-circuit breaker so that the power supply line can be easily disconnected from the mains.

### 7.1 Connection conditions

#### 7.1.1 Required tools

- For cable entries: Use corresponding tools
- For securing clamp: Allen key 3 mm
- Wire stripper
- When using stranded cables: crimping tool for ferrule
- For removing cables from terminal: flat blade screwdriver  $\leq 3$  mm (0.12 in)

#### 7.1.2 Connecting cable requirements

The connecting cables provided by the customer must fulfill the following requirements.

#### Electrical safety

In accordance with applicable federal/national regulations.

#### Permitted temperature range

- $-40$  °C ( $-40$  °F) to  $+80$  °C ( $+176$  °F)
- Minimum requirement: cable temperature range  $\geq$  ambient temperature  $+20$  K

#### Signal cable

##### *Current output*

For 4-20 mA HART: Shielded cable recommended. Observe grounding concept of the plant.

##### *Pulse/frequency/switch output*

Standard installation cable is sufficient.

##### *FOUNDATION Fieldbus*

Twisted, shielded two-wire cable.



For further information on planning and installing FOUNDATION Fieldbus networks see:

- Operating Instructions for "FOUNDATION Fieldbus Overview" (BA00013S)
- FOUNDATION Fieldbus Guideline
- IEC 61158-2 (MBP)

## PROFIBUS PA

Twisted, shielded two-wire cable. Cable type A is recommended.



For further information on planning and installing PROFIBUS PA networks see:

- Operating Instructions "PROFIBUS DP/PA: Guidelines for planning and commissioning" (BA00034S)
- PNO Directive 2.092 "PROFIBUS PA User and Installation Guideline"
- IEC 61158-2 (MBP)

### Cable diameter

- Cable glands supplied:  
M20 × 1.5 with cable  $\phi$  6 to 12 mm (0.24 to 0.47 in)
- Plug-in spring terminals for device version without integrated overvoltage protection: wire cross-sections 0.5 to 2.5 mm<sup>2</sup> (20 to 14 AWG)
- Screw terminals for device version with integrated overvoltage protection: wire cross-sections 0.2 to 2.5 mm<sup>2</sup> (24 to 14 AWG)

### 7.1.3 Terminal assignment

#### Transmitter

##### Connection versions

|   |   |
|---|---|
| <p style="text-align: right;">A0013570</p>  | <p style="text-align: right;">A0018161</p>  |
| <p><i>Maximum number of terminals, without integrated overvoltage protection</i></p>  | <p><i>Maximum number of terminals, with integrated overvoltage protection</i></p> |
| <p>1 Output 1 (passive): supply voltage and signal transmission<br/>                 2 Output 2 (passive): supply voltage and signal transmission<br/>                 3 Ground terminal for cable shield</p> |   |

| Order code for "Output"          | Terminal numbers       |       |   |       |
|----------------------------------|------------------------|-------|---|-------|
|                                  | Output 1               |       | Output 2                                |       |
|                                  | 1 (+)                  | 2 (-) | 3 (+)                                   | 4 (-) |
| Option <b>A</b>                  | 4-20 mA HART (passive) |       | -                                       |       |
| Option <b>B</b> <sup>1)</sup>    | 4-20 mA HART (passive) |       | Pulse/frequency/switch output (passive) |       |
| Option <b>E</b> <sup>1) 2)</sup> | FOUNDATION Fieldbus    |       | Pulse/frequency/switch output (passive) |       |
| Option <b>G</b> <sup>1) 3)</sup> | PROFIBUS PA            |       | Pulse/frequency/switch output (passive) |       |

- 1) Output 1 must always be used; output 2 is optional.
- 2) FOUNDATION Fieldbus with integrated reverse polarity protection.
- 3) PROFIBUS PA with integrated reverse polarity protection.

### 7.1.4 Pin assignment, device plug

#### PROFIBUS PA

Device plug for signal transmission (device side)

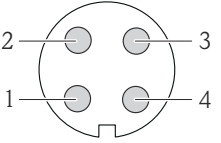
| <br>A0019021 | Pin | Assignment | Coding | Plug/socket |               |
|---|-----|------------|--------|-------------|---------------|
|   | 1   | +          |        |             | PROFIBUS PA + |
|   | 2   |            |        |             | Grounding     |
|   | 3   | -          |        |             | PROFIBUS PA - |
|   | 4   |            |        |             | Not assigned  |

#### FOUNDATION Fieldbus

Device plug for signal transmission (device side)

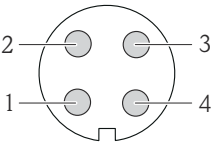
| <br>A0019021 | Pin | Assignment | Coding | Plug/socket |              |
|---|-----|------------|--------|-------------|--------------|
|   | 1   | +          |        |             | Signal +     |
|   | 2   | -          |        |             | Signal -     |
|   | 3   |            |        |             | Not assigned |
|   | 4   |            |        |             | Grounding    |

### 7.1.5 Shielding and grounding

#### PROFIBUS PA and FOUNDATION Fieldbus

Optimum electromagnetic compatibility (EMC) of the fieldbus system can only be guaranteed if the system components and, in particular, the lines are shielded and the shield forms as complete a cover as possible. A shield coverage of 90% is ideal.

- To ensure an optimum EMC protective effect, connect the shield as often as possible to the reference ground.
- For reasons of explosion protection, you should refrain from grounding however.

To comply with both requirements, the fieldbus system allows three different types of shielding:

- Shielding at both ends.
- Shielding at one end on the feed side with capacitance termination at the field device.
- Shielding at one end on the feed side.

Experience shows that the best results with regard to EMC are achieved in most cases in installations with one-sided shielding on the feed side (without capacitance termination at the field device). Appropriate measures with regard to input wiring must be taken to allow unrestricted operation when EMC interference is present. These measures have been taken into account for this device. Operation in the event of disturbance variables as per NAMUR NE21 is thus guaranteed.

Where applicable, national installation regulations and guidelines must be observed during the installation!

Where there are large differences in potential between the individual grounding points, only one point of the shielding is connected directly with the reference ground. In systems without

potential equalization, therefore, cable shielding of fieldbus systems should only be grounded on one side, for example at the fieldbus supply unit or at safety barriers.

### NOTICE

**In systems without potential matching, the multiple grounding of the cable shield causes mains frequency equalizing currents!**

Damage to the bus cable shield.

- Only ground the bus cable shield to either the local ground or the protective ground at one end. Insulate the shield that is not connected.

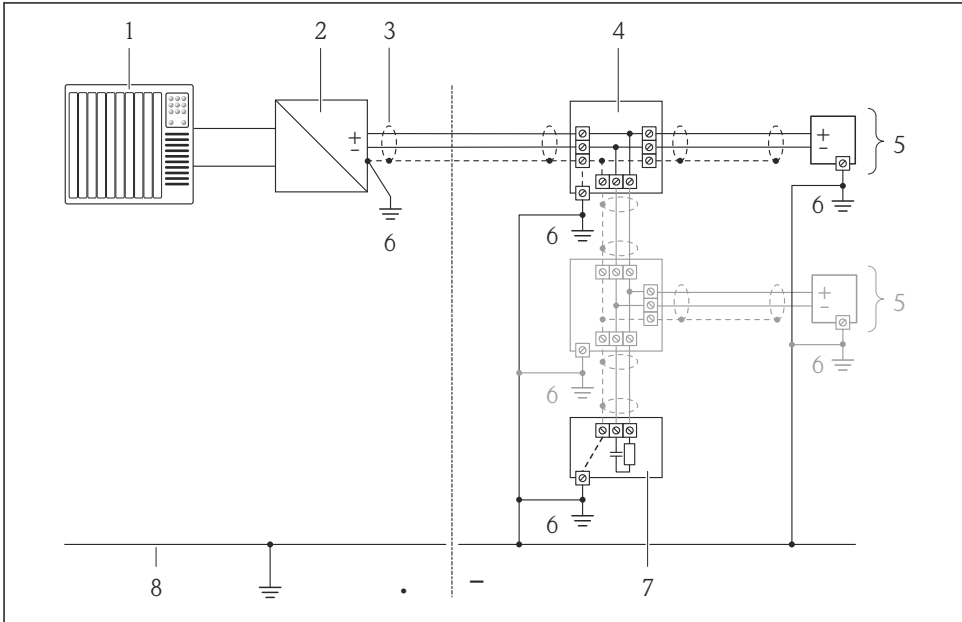

A0019004

- 1 Controller (e.g. PLC)
- 2 Segment coupler PROFIBUS DP/PA or Power Conditioner (FOUNDATION Fieldbus)
- 3 Cable shield
- 4 T-box
- 5 Measuring device
- 6 Local grounding
- 7 Bus terminator
- 8 Potential matching line

## 7.1.6 Requirements for the supply unit

### Supply voltage

#### Transmitter

| Order code for "Output"  | Minimum terminal voltage  | Maximum terminal voltage |
|--|---|--------------------------|
| Option <b>A</b> <sup>1) 2)</sup> : 4-20 mA HART                                    | <ul style="list-style-type: none"> <li>■ For 4 mA: <math>\geq</math> DC 18 V</li> <li>■ For 20 mA: <math>\geq</math> DC 14 V</li> </ul> | DC 35 V                  |
| Option <b>B</b> <sup>1) 2)</sup> : 4-20 mA HART, pulse/frequency/switch output     | <ul style="list-style-type: none"> <li>■ For 4 mA: <math>\geq</math> DC 18 V</li> <li>■ For 20 mA: <math>\geq</math> DC 14 V</li> </ul> | DC 35 V                  |
| Option <b>E</b> <sup>3)</sup> : FOUNDATION Fieldbus, pulse/frequency/switch output | $\geq$ DC 9 V   | DC 32 V                  |
| Option <b>G</b> <sup>3)</sup> : PROFIBUS PA, pulse/frequency/switch output         | $\geq$ DC 9 V   | DC 32 V                  |

- 1) External supply voltage of the power supply unit with load.
- 2) For device versions with SD03 local display: The terminal voltage must be increased by DC 2 V if backlighting is used.
- 3) For device version with SD03 local display: The terminal voltage must be increased by DC 0.5 V if backlighting is used.

### Load

Load for current output: 0 to 500  $\Omega$ , depending on the external supply voltage of the power supply unit

#### Calculation of the maximum load

Depending on the supply voltage of the power supply unit ( $U_S$ ), the maximum load ( $R_B$ ) including line resistance must be observed to ensure adequate terminal voltage at the device. In doing so, observe the minimum terminal voltage

- For  $U_S = 18$  to 18.9 V:  $R_B \leq (U_S - 18 \text{ V}): 0.0036 \text{ A}$
- For  $U_S = 18.9$  to 24.5 V:  $R_B \leq (U_S - 13.5 \text{ V}): 0.022 \text{ A}$
- For  $U_S = 24.5$  to 30 V:  $R_B \leq 500 \text{ } \Omega$

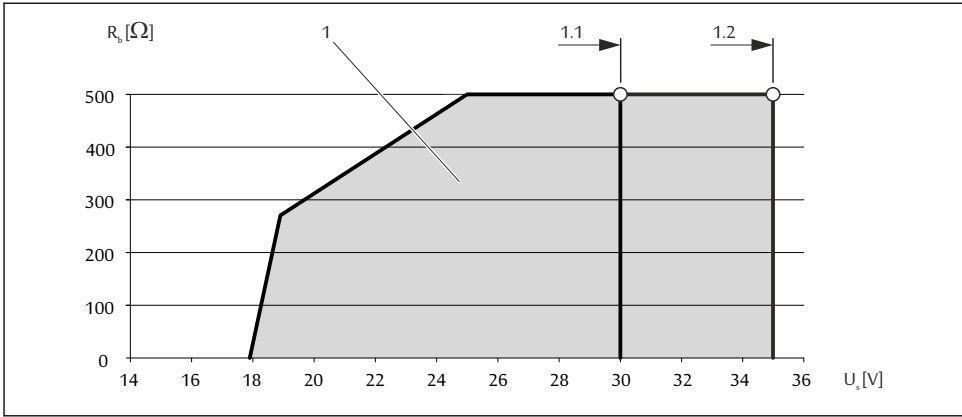

### 1 Operating range

- 1.1 For order code for "Output", option A "4-20 mA HART"/option B "4-20 mA HART, pulse/frequency/switch output" with Ex i
- 1.2 For order code for "Output", option A "4-20 mA HART"/option B "4-20 mA HART, pulse/frequency/switch output" with non-Ex and Ex d

## Sample calculation

Supply voltage of the power supply unit:  $U_S = 19 \text{ V}$

Maximum load:  $R_B \leq (19 \text{ V} - 13.5 \text{ V}) : 0.022 \text{ A} = 250 \Omega$

### 7.1.7 Preparing the measuring device

1. Remove dummy plug if present.

2. **NOTICE**

#### Insufficient sealing of the housing!

Operational reliability of the measuring device could be compromised.

- ▶ Use suitable cable glands corresponding to the degree of protection.

If measuring device is delivered without cable glands:

Provide suitable cable gland for corresponding connecting cable .

3. If measuring device is delivered with cable glands:

Observe cable specification .

## 7.2 Connecting the measuring device

### NOTICE

#### Limitation of electrical safety due to incorrect connection!

- ▶ For use in potentially explosive atmospheres, observe the information in the device-specific Ex documentation.

### 7.2.1 Connecting the transmitter

The connection of the transmitter depends on the following order codes:

Connection version: terminals or device plug

#### Connection via terminals

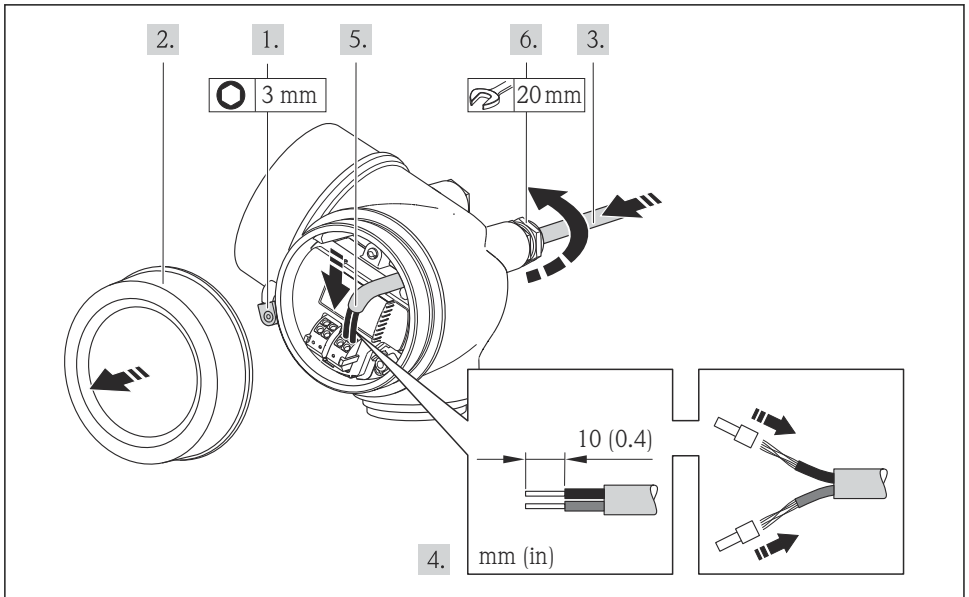

A0013836

- Connect the cable in accordance with the terminal assignment . For HART communication: when connecting the cable shielding to the ground terminal, observe the grounding concept of the facility.

#### Connection via device plug

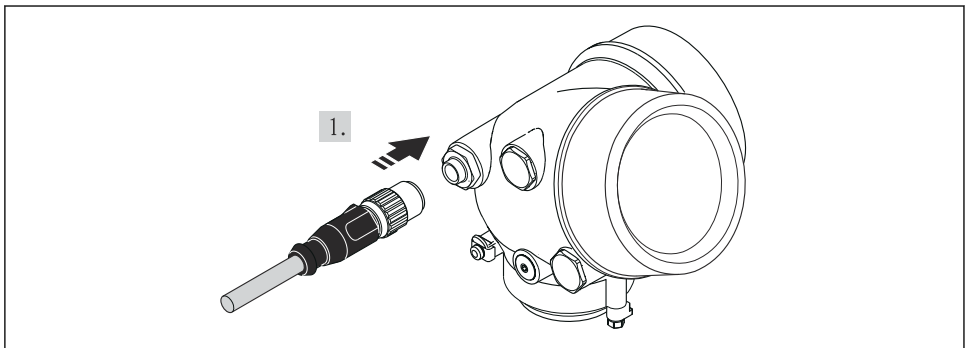

A0019147

- Plug in the device plug and tighten firmly.

## 7.2.2 Ensuring potential equalization

### Requirements

#### **⚠ CAUTION**

#### **Electrode damage can result in the complete failure of the device!**

- ▶ Same electrical potential for the fluid and sensor
- ▶ Company-internal grounding concepts
- ▶ Pipe material and grounding



For devices intended for use in hazardous locations, please observe the guidelines in the Ex documentation (XA).

### Connection example, standard scenario

*Metal, grounded pipe*

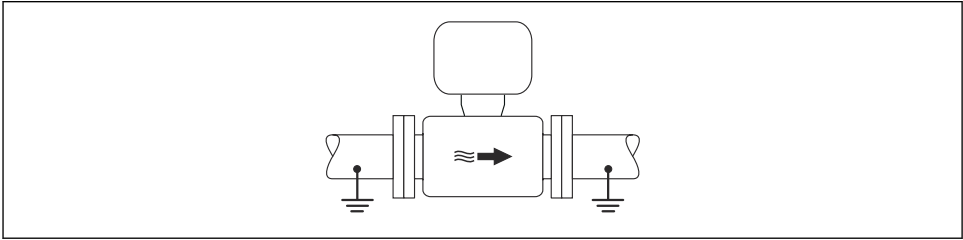

A0016315

 5 *Potential equalization via measuring tube*

### Connection example in special situations



For detailed information on special cases, see the Operating Instructions for the device.

- Unlined and ungrounded metal pipe
- Plastic pipe or pipe with insulating liner
- Pipe with a cathodic protection unit

## 7.3 Hardware settings

### 7.3.1 Setting the device address

#### **PROFIBUS PA**

The address must always be configured for a PROFIBUS DP/PA device. The valid address range is between 1 and 126. In a PROFIBUS DP/PA network, each address can only be assigned once. If an address is not configured correctly, the device is not recognized by the master. All measuring devices are delivered from the factory with the device address 126 and with the software addressing method.

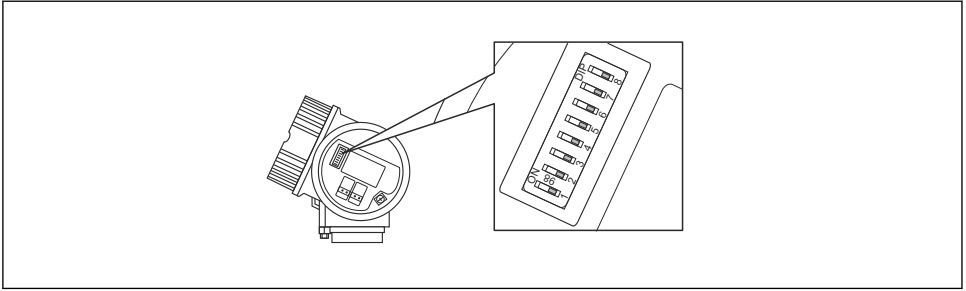

A0015686

6 Address switch in the connection compartment

Hardware addressing

1. Set switch 8 to the "OFF" position.
2. Using switches 1 to 7, set the address as indicated in the table below.

The change of address takes effect after 10 seconds. The device is restarted.

| Switch                  | 1 | 2 | 3 | 4 | 5  | 6  | 7  |
|-------------------------|---|---|---|---|----|----|----|
| Value in "ON" position  | 1 | 2 | 4 | 8 | 16 | 32 | 64 |
| Value in "OFF" position | 0 | 0 | 0 | 0 | 0  | 0  | 0  |

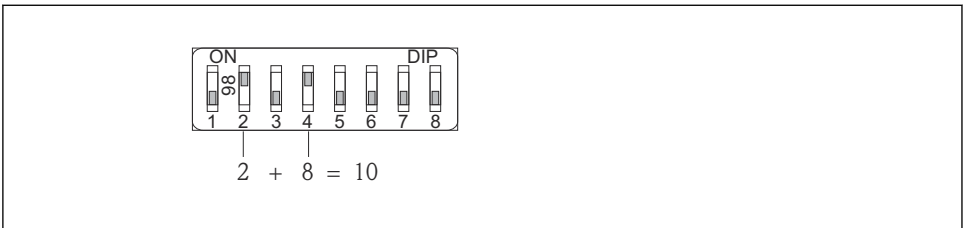

A0015902

7 Example of hardware addressing; switch 8 is set to the "OFF" position; switches 1 to 7 define the address.

Software addressing

1. Set switch 8 to "ON".
  - ↳ The device restarts automatically and reports the current address (factory setting: 126).
2. Configuring the address via the operating menu: **Setup** menu → **Communication** submenu → **Device address** parameter

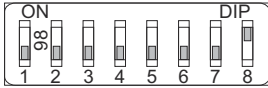

A0015903

- 8 Example of software addressing; switch 8 is set to the "ON" position; the address is defined in the operating menu ("Setup" menu → "Communication" submenu → "Device address" parameter).

## 7.4 Ensuring the degree of protection

The measuring device fulfills all the requirements for the IP66/67 degree of protection, Type 4X enclosure.

To guarantee IP66/67 degree of protection, Type 4X enclosure, carry out the following steps after the electrical connection:

1. Check that the housing seals are clean and fitted correctly. Dry, clean or replace the seals if necessary.
2. Tighten all housing screws and screw covers.
3. Firmly tighten the cable glands.
4. To ensure that moisture does not enter the cable entry, route the cable so that it loops down before the cable entry ("water trap").

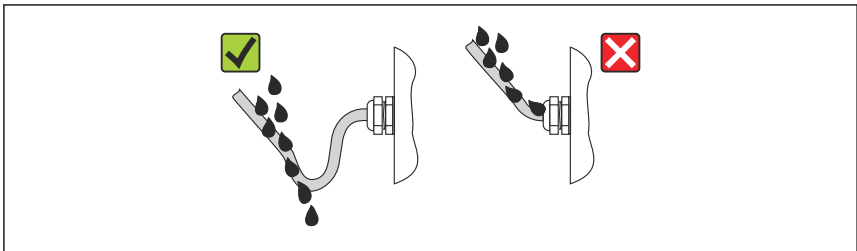

A0013960

5. Insert dummy plugs into unused cable entries.

## 7.5 Post-connection check

|   |                          |
|---|--------------------------|
| Are cables or the device undamaged (visual inspection)?   | <input type="checkbox"/> |
| Do the cables comply with the requirements ?  | <input type="checkbox"/> |
| Do the cables have adequate strain relief?  | <input type="checkbox"/> |
| Are all the cable glands installed, firmly tightened and leak-tight? Cable run with "water trap" → 30 ? | <input type="checkbox"/> |
| Depending on the device version: are all the device plugs firmly tightened ?                            | <input type="checkbox"/> |
| Does the supply voltage match the specifications on the transmitter nameplate ?                         | <input type="checkbox"/> |
| Is the terminal assignment correct ?  | <input type="checkbox"/> |
| Is the terminal assignment or the pin assignment of the device plug correct?                            | <input type="checkbox"/> |
| If supply voltage is present, do values appear on the display module?                                   | <input type="checkbox"/> |

|   |                          |
|---|--------------------------|
| Is the potential equalization established correctly →  28? | <input type="checkbox"/> |
| Are all housing covers installed and firmly tightened?  | <input type="checkbox"/> |
| Is the securing clamp tightened correctly?  | <input type="checkbox"/> |

## 8 Operation options

### 8.1 Structure and function of the operating menu

#### 8.1.1 Structure of the operating menu

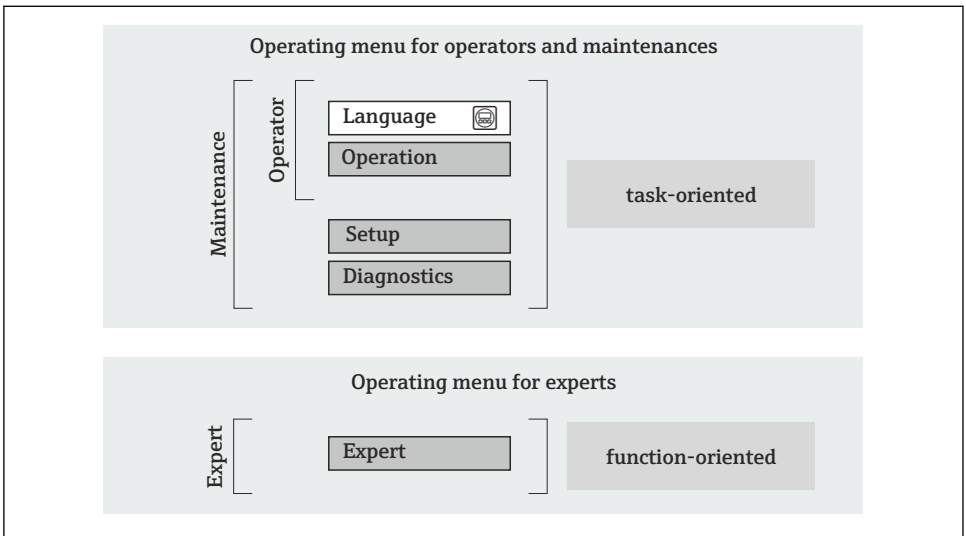

A0014058-EN

 9 Schematic structure of the operating menu

#### 8.1.2 Operating philosophy

The individual parts of the operating menu are assigned to certain user roles (operator, maintenance etc.). Each user role contains typical tasks within the device lifecycle.



For detailed information on the operating philosophy, see the Operating Instructions for the device.

## 8.2 Access to the operating menu via the local display

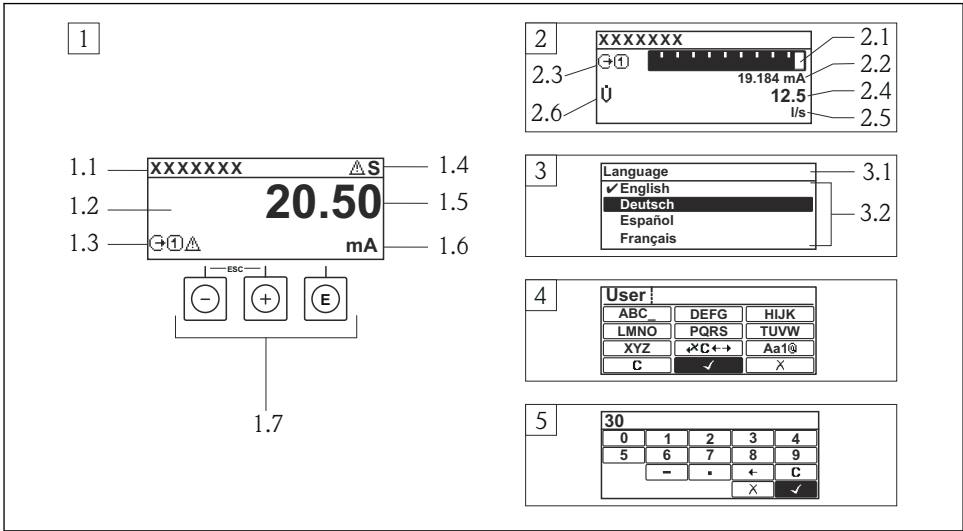





A0014013

- 1 Operational display with measured value shown as "1 value, max." (example)
  - 1.1 Device tag
  - 1.2 Display area for measured values (4-line)
  - 1.3 Explanatory symbols for measured value: Measured value type, measuring channel number, symbol for diagnostic behavior
  - 1.4 Status area
  - 1.5 Measured value
  - 1.6 Unit for the measured value
  - 1.7 Operating elements
- 2 Operational display with measured value shown as "1 bar graph + 1 value" (example)
  - 2.1 Bar graph display for measured value 1
  - 2.2 Measured value 1 with unit
  - 2.3 Explanatory symbols for measured value 1: measured value type, measuring channel number
  - 2.4 Measured value 2
  - 2.5 Unit for measured value 2
  - 2.6 Explanatory symbols for measured value 2: measured value type, measuring channel number
- 3 Navigation view: picklist of a parameter
  - 3.1 Navigation path and status area
  - 3.2 Display area for navigation: ✓ designates the current parameter value
- 4 Editing view: text editor with input mask
- 5 Editing view: numeric editor with input mask











## 8.2.1 Operational display

### Status area

The following symbols appear in the status area of the operational display at the top right:

- Status signals
  - **F**: Failure
  - **C**: Function check
  - **S**: Out of specification
  - **M**: Maintenance required
- Diagnostic behavior
  - : Alarm
  - : Warning
- : Locking (the device is locked via the hardware)
- : Communication (communication via remote operation is active)

### Display area

- Measured variables (depending on the device version), e.g.:
  - : Volume flow
  - : Mass flow
  - : Density
  - **G**: Conductivity
  - : Temperature
- : Totalizer (the measurement channel number indicates which totalizer is displayed)
- : Output (the measurement channel number indicates which output is displayed)
- : Input
-  ... : Measurement channel number (if more than one channel is present for the same measured variable type)
- Diagnostic behavior (for a diagnostic event that concerns the displayed measured variable)
  - : Alarm
  - : Warning









## 8.2.2 Navigation view

### Status area

The following appears in the status area of the navigation view in the top right corner:

- Of the submenu
  - The direct access code for the parameter you are navigating to (e.g. 0022-1)
  - If a diagnostic event is present, the diagnostic behavior and status signal
- In the wizard
  - If a diagnostic event is present, the diagnostic behavior and status signal







## Display area

- Icons for menus
  - : Operation
  - : Setup
  - : Diagnostics
  - : Expert
- : Submenus
- : Wizards
- : Parameters within a wizard
- : Parameter locked





### 8.2.3 Editing view

#### Input mask



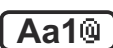

##### *Operating symbols in the numeric editor*

| Key  | Meaning                                       | Key   | Meaning  |
|--|---|---|--|
|  | Confirms selection.                           |  | Moves the input position one position to the left. |
|  | Exits the input without applying the changes. |  | Inserts decimal separator at the input position.   |
|  | Inserts minus sign at the input position.     |  | Clears all entered characters.                     |













##### *Operating symbols in the text editor*

| Key  | Meaning   | Key   | Meaning  |
|--|---|---|--|
|   | Confirms selection.   |   | Switches to the selection of the correction tools. |
|  | Exits the input without applying the changes.   |  | Clears all entered characters.                     |
|  | Toggle <ul style="list-style-type: none"> <li>▪ Between upper-case and lower-case letters</li> <li>▪ For entering numbers</li> <li>▪ For entering special characters</li> </ul> |   |  |

##### *Correction symbols under*

| Key  | Meaning   | Key   | Meaning  |
|--|---|---|--|
|  | Clears all entered characters.                      |  | Moves the input position one position to the left.                   |
|  | Moves the input position one position to the right. |  | Deletes one character immediately to the left of the input position. |

## 8.2.4 Operating elements

| Keys and meaning  |
|---|
| <p> <b>Minus key</b></p> <ul style="list-style-type: none"> <li>▪ <i>In a menu, submenu:</i> Moves the selection bar upwards in a choose list.</li> <li>▪ <i>With a wizard:</i> Confirms the parameter value and goes to the previous parameter.</li> <li>▪ <i>With a text and numeric editor:</i> Moves the selection bar to the left (backwards) in an input screen.</li> </ul>  |
| <p> <b>Plus key</b></p> <ul style="list-style-type: none"> <li>▪ <i>In a menu, submenu:</i> Moves the selection bar downwards in a choose list.</li> <li>▪ <i>With a wizard:</i> Confirms the parameter value and goes to the next parameter.</li> <li>▪ <i>With a text and numeric editor:</i> Moves the selection bar to the right (forwards) in an input screen.</li> </ul>   |
| <p> <b>Enter key</b></p> <p><i>For operational display</i></p> <ul style="list-style-type: none"> <li>▪ Pressing the key briefly opens the operating menu.</li> <li>▪ Pressing the key for 2 s opens the context menu.</li> </ul> <p><i>In a menu, submenu</i></p> <ul style="list-style-type: none"> <li>▪ Pressing the key briefly: <ul style="list-style-type: none"> <li>▪ Opens the selected menu, submenu or parameter.</li> <li>▪ Starts the wizard.</li> <li>▪ If help text is open, closes the help text of the parameter.</li> </ul> </li> <li>▪ Pressing the key for 2 s for parameter: If present, opens the help text for the function of the parameter.</li> </ul> <p><i>With a wizard:</i> Opens the editing view of the parameter.</p> <p><i>With a text and numeric editor:</i></p> <ul style="list-style-type: none"> <li>▪ Pressing the key briefly: <ul style="list-style-type: none"> <li>▪ Opens the selected group.</li> <li>▪ Carries out the selected action.</li> </ul> </li> <li>▪ Pressing the key for 2 s confirms the edited parameter value.</li> </ul> |
| <p>+ <b>Escape key combination (press keys simultaneously)</b></p> <p><i>In a menu, submenu</i></p> <ul style="list-style-type: none"> <li>▪ Pressing the key briefly: <ul style="list-style-type: none"> <li>▪ Exits the current menu level and takes you to the next higher level.</li> <li>▪ If help text is open, closes the help text of the parameter.</li> </ul> </li> <li>▪ Pressing the key for 2 s for the parameter: Returns you to the operational display ("home position").</li> </ul> <p><i>With a wizard:</i> Exits the wizard and takes you to the next higher level.</p> <p><i>With a text and numeric editor:</i> Closes the text or numeric editor without applying changes.</p>  |
| <p>+ <b>Minus/Enter key combination (press the keys simultaneously)</b></p> <p>Reduces the contrast (brighter setting).</p>   |
| <p>+ <b>Plus/Enter key combination (press and hold down the keys simultaneously)</b></p> <p>Increases the contrast (darker setting).</p>  |
| <p>++ <b>Minus/Plus/Enter key combination (press the keys simultaneously)</b></p> <p><i>For operational display:</i> Enables or disables the keypad lock (only SD02 display module).</p>   |

### 8.2.5 Further information



For further information on the following topics, see the Operating Instructions for the device

- Calling up help text
- User roles and related access authorization
- Disabling write protection via access code
- Enabling and disabling the keypad lock

## 8.3 Access to the operating menu via the operating tool



For detailed information about access to the operating menu via operating tool, refer to the Operating Instructions for the device .

# 9 System integration



For detailed information on system integration, see the Operating Instructions for the device.

## 9.1 FOUNDATION Fieldbus cyclic data transmission

### 9.1.1 Cyclic data transmission

Cyclic data transmission when using the device master file (GSD).

#### Block model

The block model shows which input and output data the measuring device makes available for cyclic data exchange. Cyclic data exchange takes place with a FOUNDATION Fieldbus master (Class 1), e.g. a control system etc.

| Display text (xxxx... = serial number) | Base index | Description                             |
|--|------------|---|
| RESOURCE_ xxxxxxxxxxxx                 | 400        | Resource block                          |
| SETUP_ xxxxxxxxxxxx                    | 600        | "Setup" Transducer block                |
| ADVANCED_SETUP_ xxxxxxxxxxxx           | 800        | "Advanced setup" Transducer block       |
| DISPLAY_ xxxxxxxxxxxx                  | 1000       | "Display" Transducer block              |
| HISTOROM_ xxxxxxxxxxxx                 | 1200       | "HistoROM" Transducer block             |
| DIAGNOSTIC_ xxxxxxxxxxxx               | 1400       | "Diagnostic" Transducer block           |
| EXPERT_CONFIG_ xxxxxxxxxxxx            | 1600       | "Expert configuration" Transducer block |
| EXPERT_INFO_ xxxxxxxxxxxx              | 1800       | "Expert information" Transducer block   |
| SERVICE_SENSOR_ xxxxxxxxxxxx           | 2000       | "Service sensor" Transducer block       |
| SERVICE_INFO_ xxxxxxxxxxxx             | 2200       | "Service info" Transducer block         |
| TOTAL_INVENTORY_COUNTER_ xxxxxxxxxxxx  | 2400       | "Totalizer" Transducer block            |

| Display text (xxxx... = serial number) | Base index | Description                            |
|--|------------|--|
| HEARTBEAT_RESULTS1_XXXXXXXXXX          | 2600       | "Heartbeat results 1" Transducer block |
| HEARTBEAT_RESULTS2_XXXXXXXXXX          | 2800       | "Heartbeat results 2" Transducer block |
| HEARTBEAT_RESULTS3_XXXXXXXXXX          | 3000       | "Heartbeat results 3" Transducer block |
| HEARTBEAT_RESULTS4_XXXXXXXXXX          | 3200       | "Heartbeat results 4" Transducer block |
| HEARTBEAT_TECHNOLOGY_XXXXXXXXXX        | 3400       | "Heartbeat" Transducer block           |
| ANALOG_INPUT_1_XXXXXXXXXX              | 3600       | Analog Input function block 1 (AI)     |
| ANALOG_INPUT_2_XXXXXXXXXX              | 3800       | Analog Input function block 2 (AI)     |
| ANALOG_INPUT_3_XXXXXXXXXX              | 4000       | Analog Input function block 3 (AI)     |
| ANALOG_INPUT_4_XXXXXXXXXX              | 4200       | Analog Input function block 4 (AI)     |
| DIGITAL_INPUT_1_XXXXXXXXXX             | 4400       | Digital Input function block 1 (DI)    |
| DIGITAL_INPUT_2_XXXXXXXXXX             | 4600       | Digital Input function block 2 (DI)    |
| MULTI_DIGITAL_OUTPUT_XXXXXXXXXX        | 4800       | Multiple Digital Output block (MDO)    |
| PID_XXXXXXXXXX                         | 5000       | PID function block (PID)               |
| INTEGRATOR_XXXXXXXXXX                  | 5200       | Integrator function block (INTG)       |

### Assignment of the measured values in the function blocks

The input value of a function block is defined via the CHANNEL parameter.

#### AI module (Analog Input)

##### Description

Four Analog Input blocks are available.

| CHANNEL | Measured variable               |
|---------|---------------------------------|
| 0       | Uninitialized (factory setting) |
| 7       | Temperature                     |
| 9       | Volume flow                     |
| 11      | Mass flow                       |
| 16      | Totalizer 1                     |
| 17      | Totalizer 2                     |
| 18      | Totalizer 3                     |

#### DI module (Discrete Input)

Two Discrete Input blocks are available.

*Description*

| CHANNEL | Device function                   | State               |
|---------|-----------------------------------|---------------------|
| 0       | Uninitialized (factory setting)   | -                   |
| 101     | Switch output state               | 0 = off, 1 = active |
| 102     | Empty pipe detection              | 0 = full, 1 = empty |
| 103     | Low flow cut off                  | 0 = off, 1 = active |
| 105     | Status verification <sup>1)</sup> | 0 = good, 1 = bad   |

1) Only available with the Heartbeat Verification application package

*MDO module (Multiple Discrete Output)**Description*

| Channel | Name       |
|---------|------------|
| 122     | Channel_DO |

*Structure*

| Channel_DO |         |         |         |         |         |         |         |
|------------|---------|---------|---------|---------|---------|---------|---------|
| Value 1    | Value 2 | Value 3 | Value 4 | Value 5 | Value 6 | Value 7 | Value 8 |
|            |         |         |         |         |         |         |         |

| Value   | Device function                            | State                |
|---------|--|----------------------|
| Value 1 | Reset totalizer 1                          | 0 = off, 1 = execute |
| Value 2 | Reset totalizer 2                          | 0 = off, 1 = execute |
| Value 3 | Reset totalizer 3                          | 0 = off, 1 = execute |
| Value 4 | Flow override                              | 0 = off, 1 = active  |
| Value 5 | Start heartbeat verification <sup>1)</sup> | 0 = off, 1 = start   |
| Value 6 | Status switch output                       | 0 = off, 1 = on      |
| Value 7 | Not assigned                               | -                    |
| Value 8 | Not assigned                               | -                    |

1) Only available with the Heartbeat Verification application package

## 9.2 Cyclic data transfer PROFIBUS PA

### 9.2.1 Cyclic data transmission

Cyclic data transmission when using the device master file (GSD).

#### Block model

The block model shows which input and output data the measuring device makes available for cyclic data exchange. Cyclic data exchange takes place with a PROFIBUS master (Class 1), e.g. a control system etc.

| Measuring device             |                             |                 |                       | Control system     |
|------------------------------|-----------------------------|-----------------|-----------------------|--------------------|
| <b>Transducer Block</b>      | Analog Input block 1 to 2   | → 40            | Output value AI       | →                  |
|                              |                             |                 | Output value TOTAL    | →                  |
|                              | Totalizer block 1 to 3      | → 40            | Controller SETTOT     | ←                  |
|                              |                             |                 | Configuration MODETOT | ←                  |
|                              | Discrete Input block 1 to 2 | → 41            | Output values DI      | →                  |
| Discrete Output block 1 to 3 | → 42                        | Input values DO | ←                     |                    |
|                              |                             |                 |                       | <b>PROFIBUS PA</b> |

#### Defined order of modules

The modules are permanently assigned to the slots, i.e. when configuring the modules, the order and the arrangement of the modules must be respected.

| Slot   | Module  | Function block               |
|--------|---|------------------------------|
| 1...2  | AI  | Analog Input block 1 to 2    |
| 3      | TOTAL or<br>SETTOT_TOTAL or<br>SETTOT_MODETOT_TOTAL | Totalizer block 1            |
| 4      |   | Totalizer block 2            |
| 5      |   | Totalizer block 3            |
| 6...7  | DI  | Discrete Input block 1 to 2  |
| 8...10 | DO  | Discrete Output block 1 to 3 |

To optimize the data throughput rate of the PROFIBUS network, it is advisable to only configure modules that are processed in the PROFIBUS master system. If this results in gaps between the configured modules, these gaps must be assigned to the EMPTY\_MODULE.

#### Description of the modules



The data structure is described from the perspective of the PROFIBUS master:

- Input data: Are sent from the measuring device to the PROFIBUS master.
- Output data: Are sent from the PROFIBUS master to the measuring device.

*AI module (Analog Input)*

Transmit an input variable from the measuring device to the PROFIBUS master (Class 1).

*Selection: input variable*

The input variable can be specified using the CHANNEL parameter.

| CHANNEL | Input variable |
|---------|----------------|
| 9       | Volume flow    |
| 11      | Mass flow      |

*Factory setting*

| Function block | Factory setting |
|----------------|-----------------|
| AI 1           | Volume flow     |
| AI 2           | Mass flow       |

*TOTAL module*

Transmit a totalizer value from the measuring device to the PROFIBUS master (Class 1).

*Selection: totalizer value*

The totalizer value can be specified using the CHANNEL parameter.

| CHANNEL | Input variable |
|---------|----------------|
| 9       | Mass flow      |
| 11      | Volume flow    |

*Factory setting*

| Function block       | Factory setting: TOTAL |
|----------------------|------------------------|
| Totalizer 1, 2 and 3 | Volume flow            |

*SETTOT\_TOTAL module*

The module combination consists of the SETTOT and TOTAL functions:

- SETTOT: Control the totalizers via the PROFIBUS master.
- TOTAL: Transmit totalizer value, along with the status, to the PROFIBUS master.

*Selection: control totalizer*

| Value SETTOT | Control totalizer               |
|--------------|---------------------------------|
| 0            | Totalize                        |
| 1            | Resetting                       |
| 2            | Adopt totalizer initial setting |

*Factory setting*

| Function block       | Factory setting: Value SETTOT (meaning) |
|----------------------|---|
| Totalizer 1, 2 and 3 | 0 (totalizing)                          |

*SETTOT\_MODETOT\_TOTAL module*

The module combination consists of the SETTOT, MODETOT and TOTAL functions:

- SETTOT: Control the totalizers via the PROFIBUS master.
- MODETOT: Configure the totalizers via the PROFIBUS master.
- TOTAL: Transmit totalizer value, along with the status, to the PROFIBUS master.

*Selection: totalizer configuration*

| MODETOT value | Totalizer configuration   |
|---------------|---------------------------|
| 0             | Balancing                 |
| 1             | Balance the positive flow |
| 2             | Balance the negative flow |
| 3             | Stop totalizing           |

*Factory setting*

| Function block       | Factory setting: Value MODETOT (meaning) |
|----------------------|--|
| Totalizer 1, 2 and 3 | 0 (balancing)                            |

*DI module (Discrete Input)*

Transmit discrete input values from the measuring device to the PROFIBUS master (Class 1).

*Selection: device function*

The device function can be specified using the CHANNEL parameter.

| CHANNEL | Device function      | Factory setting: Status (meaning)  |
|---------|----------------------|--|
| 893     | Status switch output | <ul style="list-style-type: none"> <li>■ 0 (device function not active)</li> <li>■ 1 (device function active)</li> </ul> |
| 894     | Empty pipe detection |  |

| CHANNEL | Device function                   | Factory setting: Status (meaning) |
|---------|-----------------------------------|-----------------------------------|
| 895     | Low flow cut off                  |                                   |
| 1430    | Status verification <sup>1)</sup> |                                   |

1) Only available with the Heartbeat Verification application package

### Factory setting

| Function block | Factory setting      | Function block | Factory setting  |
|----------------|----------------------|----------------|------------------|
| DI 1           | Empty pipe detection | DI 2           | Low flow cut off |

### DO module (Discrete Output)

Transmit discrete output values from the PROFIBUS master (Class 1) to the measuring device.

### Assigned device functions

A device function is permanently assigned to the individual Discrete Output blocks.

| CHANNEL | Function block | Device function                  | Values: control (meaning)   |
|---------|----------------|----------------------------------|---|
| 891     | DO 1           | Flow override                    | <ul style="list-style-type: none"> <li>▪ 0 (disable device function)</li> <li>▪ 1 (enable device function)</li> </ul> |
| 253     | DO 2           | Pulse/freq./switch output        |   |
| 1429    | DO 3           | Start verification <sup>1)</sup> |   |

1) Only available with the Heartbeat Verification application package

### EMPTY\_MODULE module

This module is used to assign empty spaces arising from modules not being used in the slots



→  39.

## 10 Commissioning

### 10.1 Function check

Before commissioning the measuring device:

► Make sure that the post-installation and post-connection checks have been performed.

- "Post-installation check" checklist →  19
- "Post-connection check" checklist →  30

## 10.2 Switching on the measuring device

- ▶ After a successful function check, switch on the measuring device.
  - ↳ After a successful startup, the local display switches automatically from the startup display to the operational display.



If nothing appears on the local display or a diagnostic message is displayed, refer to the Operating Instructions for the device → 2

## 10.3 Setting the operating language

Factory setting: English or ordered local language

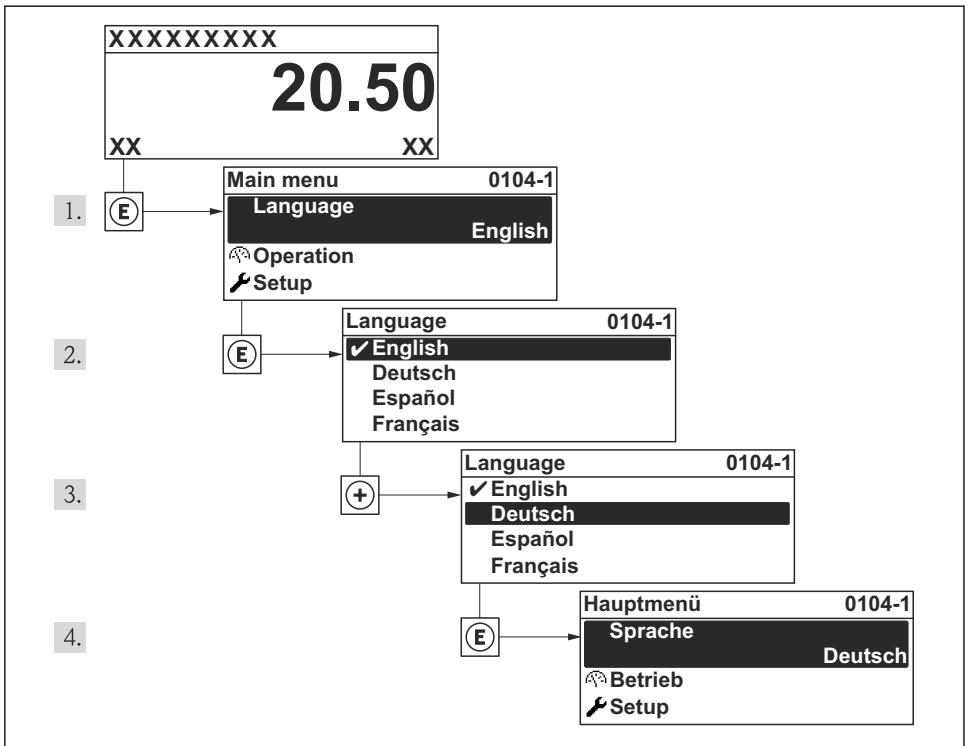

A0013996

10 Taking the example of the local display

## 10.4 Configuring the measuring device

The **Setup** menu with its **System units** submenu and various guided wizards enable fast commissioning of the measuring device.

The desired units can be selected in the **System units** submenu. The wizards systematically guide the user through all the parameters required for configuration, such as parameters for measurement or outputs.

 The wizards available in the particular device can vary on account of the device version (e.g. communication method).

| Wizard                        | Meaning                              |
|-------------------------------|--------------------------------------|
| Current output 1              | Set current output 1                 |
| Pulse/frequency/switch output | Configure the selected output type   |
| Analog inputs                 | Configure the analog inputs          |
| Display                       | Configure the measured value display |
| Output conditioning           | Define the output conditioning       |
| Low flow cut off              | Set the low flow cut off             |

## 10.5 Defining the tag name

To enable fast identification of the measuring point within the system, you can enter a unique designation using the **Device tag** parameter and thus change the factory setting.

### Navigation

"Setup" menu → Device tag

### Parameter overview with brief description

| Parameter  | Description                             | User entry  |
|------------|---|---|
| Device tag | Enter the name for the measuring point. | Max. 32 characters such as letters, numbers or special characters (e.g. @, %, /). |

## 10.6 Protecting settings from unauthorized access

The following options exist for protecting the configuration of the measuring device from unintentional modification after commissioning:

- Write protection via access code
- Write protection via write protection switch
- Write protection via keypad lock
- FOUNDATION Fieldbus: write protection via block operation

 For detailed information on protecting the settings against unauthorized access, see the Operating Instructions for the device.

## 11 Diagnostic information

Faults detected by the self-monitoring system of the measuring device are displayed as a diagnostic message in alternation with the operational display. The message on remedial measures can be called up from the diagnostic messages, and contains important information on the fault.

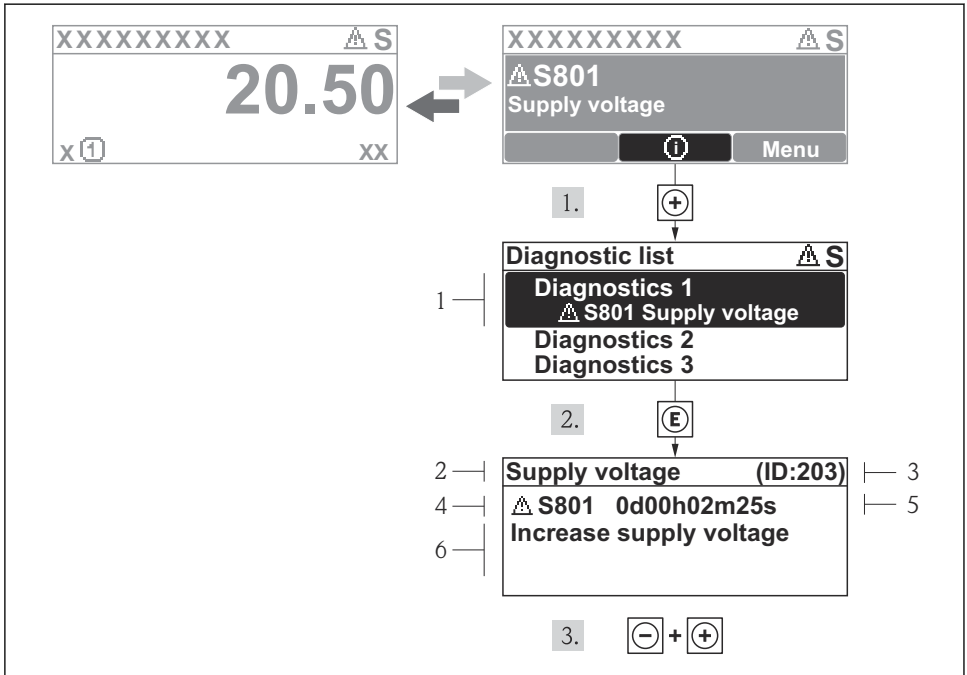

A0013940-EN

### 11 Message for remedial measures

- 1 Diagnostic information
- 2 Short text
- 3 Service ID
- 4 Diagnostic behavior with diagnostic code
- 5 Operation time of occurrence
- 6 Remedial measures

The user is in the diagnostic message.

1. Press **+** (ⓘ symbol).
  - ↳ The **Diagnostic list** submenu opens.
2. Select the desired diagnostic event with **+** or **-** and press **⏎**.
  - ↳ The message for the remedial measures for the selected diagnostic event opens.
3. Press **-** + **+** simultaneously.
  - ↳ The message for the remedial measures closes.







71767983

[www.addresses.endress.com](http://www.addresses.endress.com)

---