

Operating Instructions

Dosimag

Electromagnetic flowmeter



- Make sure the document is stored in a safe place such that it is always available when working on or with the device.
- To avoid danger to individuals or the facility, read the "Basic safety instructions" section carefully, as well as all other safety instructions in the document that are specific to working procedures.
- The manufacturer reserves the right to modify technical data without prior notice. Your Endress+Hauser sales organization will supply you with current information and updates to this manual.

Table of contents

1	About this document	5		
1.1	Document function	5		
1.2	Symbols	5		
1.2.1	Safety symbols	5		
1.2.2	Electrical symbols	5		
1.2.3	Symbols for certain types of information	5		
1.2.4	Symbols in graphics	6		
1.3	Documentation	6		
1.4	Registered trademarks	7		
2	Safety instructions	8		
2.1	Requirements for the personnel	8		
2.2	Intended use	8		
2.3	Workplace safety	9		
2.4	Operational safety	9		
2.5	Product safety	9		
2.6	IT security	9		
3	Product description	10		
3.1	Product design	10		
4	Incoming acceptance and product identification	11		
4.1	Incoming acceptance	11		
4.2	Product identification	11		
4.2.1	Measuring instrument nameplate ...	12		
4.2.2	Symbols on the device	12		
5	Storage and transport	13		
5.1	Storage conditions	13		
5.2	Transporting the product	13		
5.3	Packaging disposal	13		
6	Mounting	14		
6.1	Mounting requirements	14		
6.1.1	Mounting position	14		
6.1.2	Environmental and process requirements	19		
6.1.3	Special mounting instructions	19		
6.2	Mounting the measuring instrument	21		
6.2.1	Required tools	21		
6.2.2	Preparing the measuring instrument .	22		
6.2.3	Mounting the measuring instrument	22		
6.3	Post-mounting check	24		
7	Electrical connection	25		
7.1	Electrical safety	25		
7.2	Connecting requirements	25		
7.2.1	Requirements for connection cable ...	25		
7.2.2	Terminal assignment	25		
7.2.3	Available device plugs	25		
7.2.4	Requirements for the supply unit ...	26		
7.3	Connecting the device	27		
7.3.1	Connection via device plug	27		
7.3.2	Grounding	27		
7.4	Ensuring potential equalization	28		
7.4.1	Requirements	28		
7.4.2	Metal process connections	28		
7.4.3	Plastic process connections	28		
7.5	Ensuring the degree of protection	29		
7.6	Post-connection check	30		
8	Operation options	31		
8.1	Overview of operation options	31		
8.2	Access to the operating menu via the operating tool	31		
8.2.1	Connecting the operating tool	31		
8.2.2	FieldCare	32		
8.2.3	DeviceCare	33		
9	System integration	34		
9.1	Overview of device description files	34		
9.1.1	Current version data for the device ...	34		
9.1.2	Operating tools	34		
10	Commissioning	35		
10.1	Post-mounting and post-connection check ...	35		
10.2	Switching on the measuring device	35		
10.3	Connecting via FieldCare	35		
10.4	Configuring the measuring instrument	35		
11	Operation	36		
11.1	Reading the device locking status	36		
11.2	Reading access authorization status on operating software	36		
11.3	Reading measured values	36		
11.4	Adapting the measuring instrument to the process conditions	36		
11.5	Performing a totalizer reset	37		
12	Diagnostics and troubleshooting ...	38		
12.1	General troubleshooting	38		
12.2	Diagnostic information in FieldCare or DeviceCare	38		
12.2.1	Diagnostic options	38		
12.2.2	Calling up remedy information	39		
12.3	Adapting the diagnostic information	39		
12.3.1	Adapting the diagnostic behavior ...	39		
12.4	Overview of diagnostic information	40		
12.5	Pending diagnostic events	42		
12.6	Actual diagnostics	42		

12.7	Event logbook	43
12.7.1	Event history	43
12.7.2	Overview of information events	43
12.8	Resetting the measuring device	43
12.9	Device	44
12.10	Firmware history	45
13	Maintenance	47
13.1	Maintenance work	47
13.1.1	Cleaning of surfaces not in contact with the medium	47
13.1.2	Cleaning of surfaces in contact with the medium	47
13.1.3	Cleaning with pigs	47
13.1.4	Replacing seals	47
13.2	Measuring and test equipment	47
13.3	Endress+Hauser services	48
14	Repair	49
14.1	General information	49
14.1.1	Repair and conversion concept	49
14.2	Endress+Hauser services	49
14.3	Return	49
14.4	Disposal	49
14.4.1	Removing the measuring device	49
14.4.2	Disposing of the measuring device	50
15	Accessories	51
15.1	Device-specific accessories	51
15.2	Communication-specific accessories	51
15.3	Service-specific accessories	52
16	Technical data	53
16.1	Application	53
16.2	Function and system design	53
16.3	Input	53
16.4	Output	54
16.5	Power supply	55
16.6	Performance characteristics	56
16.7	Mounting	57
16.8	Environment	57
16.9	Process	58
16.10	Mechanical construction	60
16.11	Operability	62
16.12	Certificates and approvals	62
16.13	Accessories	64
16.14	Documentation	64
Index	66	

1 About this document

1.1 Document function

These Operating Instructions contain all the information required in the various life cycle phases of the device: from product identification, incoming acceptance and storage, to installation, connection, operation and commissioning, through to troubleshooting, maintenance and disposal.

1.2 Symbols

1.2.1 Safety symbols

 DANGER

This symbol alerts you to a dangerous situation. Failure to avoid this situation will result in serious or fatal injury.

 WARNING

This symbol alerts you to a potentially dangerous situation. Failure to avoid this situation can result in serious or fatal injury.





 CAUTION

This symbol alerts you to a potentially dangerous situation. Failure to avoid this situation can result in minor or medium injury.



NOTICE











This symbol alerts you to a potentially harmful situation. Failure to avoid this situation can result in damage to the product or something in its vicinity.

1.2.2 Electrical symbols





Symbol	Meaning
	Direct current
	Alternating current
	Direct current and alternating current
	Ground connection A grounded terminal which, as far as the operator is concerned, is grounded via a grounding system.
	Protective earth (PE) Ground terminals that must be connected to ground prior to establishing any other connections. The ground terminals are located on the interior and exterior of the device: <ul style="list-style-type: none"> ▪ Interior ground terminal: protective earth is connected to the mains supply. ▪ Exterior ground terminal: device is connected to the plant grounding system.

1.2.3 Symbols for certain types of information

Symbol	Meaning
	Permitted Procedures, processes or actions that are permitted.
	Preferred Procedures, processes or actions that are preferred.

Symbol	Meaning
	Forbidden Procedures, processes or actions that are forbidden.
	Tip Indicates additional information.
	Reference to documentation
	Reference to page
	Reference to graphic
	Notice or individual step to be observed
	Series of steps
	Result of a step
	Help in the event of a problem
	Visual inspection

1.2.4 Symbols in graphics

Symbol	Meaning
1, 2, 3, ...	Item numbers
	Series of steps
A, B, C, ...	Views
A-A, B-B, C-C, ...	Sections
	Hazardous area
	Safe area (non-hazardous area)
	Flow direction

1.3 Documentation

 For an overview of the scope of the associated Technical Documentation, refer to the following:

- *Device Viewer* (www.endress.com/deviceviewer): Enter the serial number from the nameplate
- *Endress+Hauser Operations app*: Enter serial number from nameplate or scan matrix code on nameplate.

The following document types are available in the Downloads area of the Endress+Hauser website (www.endress.com/downloads), depending on the product configuration:

Document type	Purpose and content of the document
Technical Information (TI)	Planning aid This document contains all the technical data on the product and provides an overview of everything that can be ordered with the product.
Brief Operating Instructions (KA)	Quick guide to obtaining the first measured value The Operating Instructions contain all the essential information about the product from incoming acceptance to initial commissioning.

Document type	Purpose and content of the document
Operating Instructions (BA)	<p>Reference The Operating Instructions contain the information that is required in the various phases of the life cycle of the product: From product identification, incoming acceptance and storage, to mounting, connection, operation and commissioning through to troubleshooting, maintenance and disposal.</p>
Description of Device Parameters (GP)	<p>Reference for parameters The document contains detailed explanations of readable or configurable parameters in the product. The description is aimed at those who work with the product over its entire life cycle and perform specific configurations.</p>
Safety Instructions (XA)	<p>Safety Instructions for electrical equipment in hazardous areas are supplied with the product depending on the approval. These are an integral part of the Operating Instructions.</p> <p> The nameplate indicates the Safety Instructions (XA) that are relevant to the product.</p>
Supplementary device-dependent documentation (SD/FY)	<p>Always comply strictly with the instructions in the relevant supplementary documentation. The supplementary documentation is an integral part of the product documentation.</p>

1.4 Registered trademarks

KALREZ®

Registered trademarks of DuPont Performance Elastomers L.L.C., Wilmington, DE USA

TRI-CLAMP®

Registered trademark of Ladish & Co., Inc., Kenosha, USA

2 Safety instructions

2.1 Requirements for the personnel

The personnel for installation, commissioning, diagnostics and maintenance must fulfill the following requirements:

- ▶ Trained, qualified specialists must have a relevant qualification for this specific function and task.
- ▶ Are authorized by the plant owner/operator.
- ▶ Are familiar with federal/national regulations.
- ▶ Before starting work, read and understand the instructions in the manual and supplementary documentation as well as the certificates (depending on the application).
- ▶ Follow instructions and comply with basic conditions.

The operating personnel must fulfill the following requirements:

- ▶ Are instructed and authorized according to the requirements of the task by the facility's owner-operator.
- ▶ Follow the instructions in this manual.

2.2 Intended use

Application and media

Depending on the version ordered, the measuring instrument can also be used to measure potentially explosive ¹⁾, flammable, toxic and oxidizing media.

Measuring instruments for use in hazardous areas, in hygienic applications, or where there is an increased risk due to pressure, are specially labeled on the nameplate.

To ensure that the measuring instrument is in perfect condition during operation:

- ▶ Only use the measuring instrument in full compliance with the data on the nameplate and the general conditions listed in the Operating Instructions and supplementary documentation.
- ▶ Using the nameplate, check whether the ordered device is permitted for the intended use in the hazardous area (e.g. explosion protection, pressure vessel safety).
- ▶ Use the measuring instrument only for media to which the process-wetted materials are sufficiently resistant.
- ▶ Keep within the specified pressure and temperature range.
- ▶ Keep within the specified ambient temperature range.
- ▶ Protect the measuring instrument permanently against corrosion from environmental influences.

Incorrect use

Non-designated use can compromise safety. The manufacturer is not liable for damage caused by improper or non-designated use.

WARNING

Danger of breakage due to corrosive or abrasive fluids and ambient conditions!

- ▶ Verify the compatibility of the process fluid with the sensor material.
- ▶ Ensure the resistance of all fluid-wetted materials in the process.
- ▶ Keep within the specified pressure and temperature range.

1) Not applicable for IO-Link measuring instruments

NOTICE**Verification for borderline cases:**

- ▶ For special fluids and fluids for cleaning, Endress+Hauser is glad to provide assistance in verifying the corrosion resistance of fluid-wetted materials, but does not accept any warranty or liability as minute changes in the temperature, concentration or level of contamination in the process can alter the corrosion resistance properties.

Residual risks**⚠ CAUTION**

Risk of hot or cold burns! The use of media and electronics with high or low temperatures can produce hot or cold surfaces on the device.

- ▶ Mount suitable touch protection.

2.3 Workplace safety

When working on and with the device:

- ▶ Wear the required personal protective equipment as per national regulations.

2.4 Operational safety

Damage to the device!

- ▶ Operate the device in proper technical condition and fail-safe condition only.
- ▶ The operator is responsible for the interference-free operation of the device.

Modifications to the device

Unauthorized modifications to the device are not permitted and can lead to unforeseeable dangers!

- ▶ If modifications are nevertheless required, consult with the manufacturer.

Repair

To ensure continued operational safety and reliability:

- ▶ Carry out repairs on the device only if they are expressly permitted.
- ▶ Observe federal/national regulations pertaining to the repair of an electrical device.
- ▶ Use only original spare parts and accessories.

2.5 Product safety

This measuring device is designed in accordance with good engineering practice to meet state-of-the-art safety requirements, has been tested, and left the factory in a condition in which it is safe to operate.

It meets general safety standards and legal requirements. It also complies with the EU directives listed in the device-specific EU Declaration of Conformity. The manufacturer confirms this by affixing the CE mark to the device..

2.6 IT security

Our warranty is valid only if the product is installed and used as described in the Operating Instructions. The product is equipped with security mechanisms to protect it against any inadvertent changes to the settings.

IT security measures, which provide additional protection for the product and associated data transfer, must be implemented by the operators themselves in line with their security standards.

3 Product description

Compact version – transmitter and sensor form a mechanical unit in a fully welded housing.

3.1 Product design

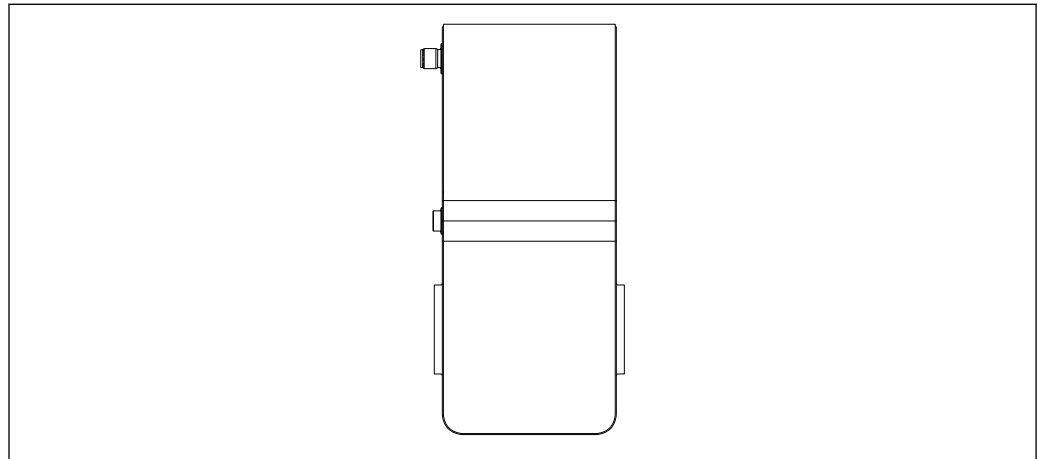

A0055041

 1 *Measuring instrument*

4 Incoming acceptance and product identification

4.1 Incoming acceptance

On receipt of the delivery:

1. Check the packaging for damage.
 - ↳ Report all damage immediately to the manufacturer.
Do not install damaged components.
2. Check the scope of delivery using the delivery note.
3. Compare the data on the nameplate with the order specifications on the delivery note.
4. Check the technical documentation and all other necessary documents, e.g. certificates, to ensure they are complete.

 If one of the conditions is not satisfied, contact the manufacturer.

4.2 Product identification

The device can be identified in the following ways:

- Nameplate
- Order code with details of the device features on the delivery note
- Enter the serial numbers from the nameplates in the *Device Viewer* (www.endress.com/deviceviewer): all the information about the device is displayed.
- Enter the serial numbers from the nameplates into the *Endress+Hauser Operations app* or scan the DataMatrix code on the nameplate with the *Endress+Hauser Operations app*: all the information about the device is displayed.

For an overview of the scope of the associated Technical Documentation, refer to the following:

- The "Additional standard device documentation" and "Supplementary device-dependent documentation" sections
- The *Device Viewer*: Enter the serial number from the nameplate (www.endress.com/deviceviewer)
- The *Endress+Hauser Operations app*: Enter the serial number from the nameplate or scan the DataMatrix code on the nameplate.

4.2.1 Measuring instrument nameplate

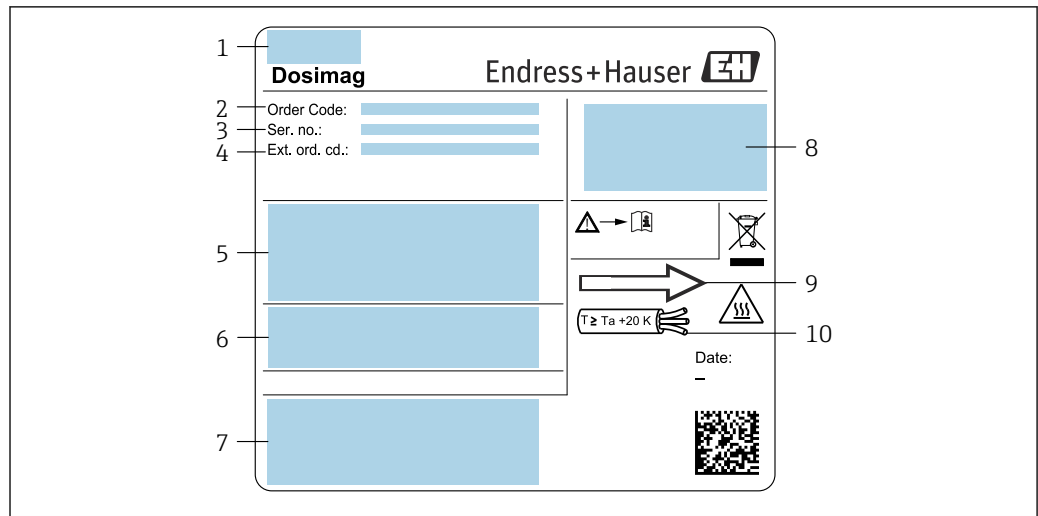

A0054879

2 Example of measuring instrument nameplate

- 1 Manufacturer address/certificate holder
- 2 Order code
- 3 Serial number (Ser. no.)
- 4 Extended order code (Ext. ord. cd.): See the specifications on the order confirmation for the meanings of the individual letters and digits
- 5 Supply voltage; power consumption; process connection
- 6 Nominal diameter of sensor; pressure rating (PN = PS); materials in contact with medium; permitted medium temperature (Tm); permitted ambient temperature (Ta)
- 7 Space reserved for additional information on the device version (approvals, certificates, etc.)
- 8 Degree of protection
- 9 Flow direction
- 10 Cable temperature

i Order code

The measuring device is reordered using the order code.

Extended order code

- The device type (product root) and basic specifications (mandatory features) are always listed.
- Of the optional specifications (optional features), only the safety and approval-related specifications are listed (e.g. LA). If other optional specifications are also ordered, these are indicated collectively using the # placeholder symbol (e.g. #LA#).
- If the ordered optional specifications do not include any safety and approval-related specifications, they are indicated by the + placeholder symbol (e.g. XXXXXX-ABCDE+).

4.2.2 Symbols on the device

Symbol	Meaning
	WARNING! This symbol alerts you to a dangerous situation. Failure to avoid this situation can result in serious or fatal injury. Please consult the documentation for the measuring instrument to discover the type of potential danger and measures to avoid it.
	Reference to documentation Refers to the corresponding device documentation.
	Ground connection A grounded terminal which, as far as the operator is concerned, is grounded via a grounding system.

5 Storage and transport

5.1 Storage conditions

Observe the following notes for storage:

- ▶ Store in the original packaging to ensure protection from shock.
- ▶ Do not remove protective covers or protective caps installed on process connections. They prevent mechanical damage to the sealing surfaces and contamination in the measuring tube.
- ▶ Protect from direct sunlight. Avoid unacceptably high surface temperatures.
- ▶ Select a storage location that excludes the possibility of condensation forming on the measuring device. Fungi and bacteria can damage the liner.
- ▶ Store in a dry and dust-free place.
- ▶ Do not store outdoors.

Storage temperature →  57

5.2 Transporting the product

Transport the measuring instrument to the measuring point in the original packaging.

-  Do not remove protective covers or caps installed on process connections. They prevent mechanical damage to the sealing surfaces and contamination in the measuring tube.

5.3 Packaging disposal

All packaging materials are environmentally friendly and 100% recyclable:

- Outer packaging of device
 - Stretch wrap made of polymer in accordance with EU Directive 2002/95/EC (RoHS)
- Packaging
 - Wood crate treated in accordance with ISPM 15 standard, confirmed by IPPC logo
 - Cardboard box in accordance with European packaging guideline 94/62/EC, recyclability confirmed by Resy symbol
- Transport material and fastening fixtures
 - Disposable plastic pallet
 - Plastic straps
 - Plastic adhesive strips
- Filler material
 - Paper pads

6 Mounting

6.1 Mounting requirements

6.1.1 Mounting position

Mounting location

- Do not install the device at the highest point of the pipe.
- Do not install the device upstream from a free pipe outlet in a down pipe.

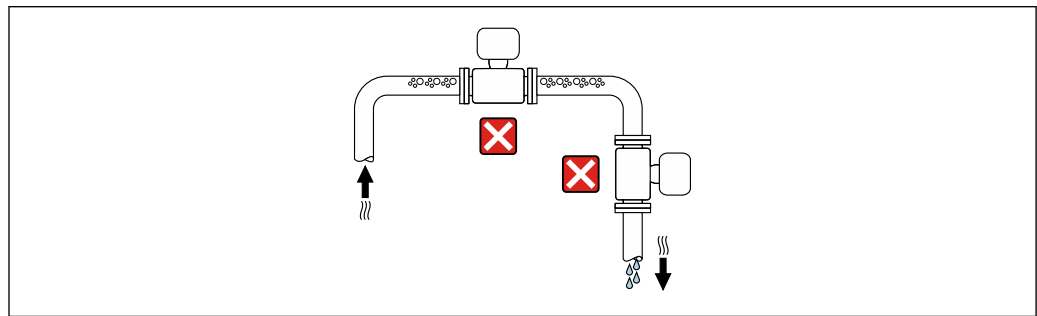

A0042131

The device should ideally be installed in an ascending pipe.

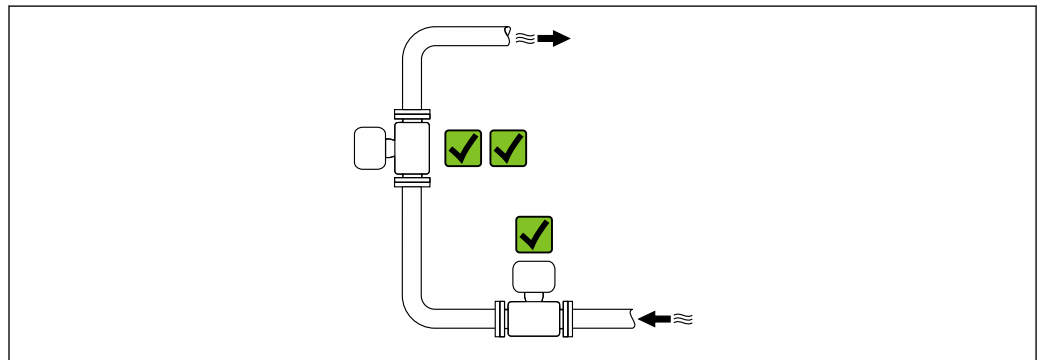

A0042317

Installation upstream from a down pipe

NOTICE

Negative pressure in the measuring pipe can damage the liner!

- ▶ If installing upstream of down pipes whose length $h \geq 5$ m (16.4 ft): install a siphon with a vent valve downstream of the device.

i This arrangement prevents the flow of liquid stopping in the pipe and air entrainment.

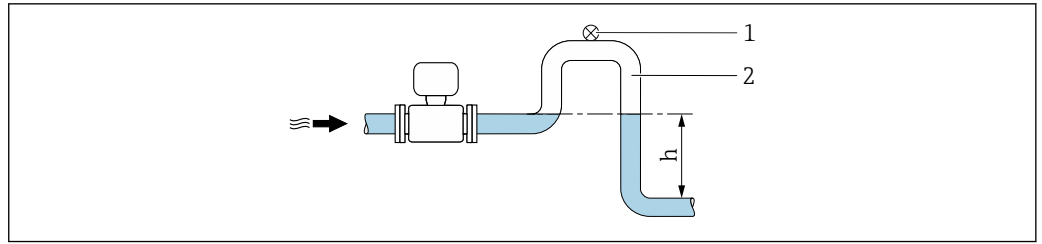

A0028981

- 1 Vent valve
- 2 Pipe siphon
- h Length of down pipe

Installation with partially filled pipes

- Partially filled pipes with a gradient require a drain-type configuration.
- The installation of a cleaning valve is recommended.

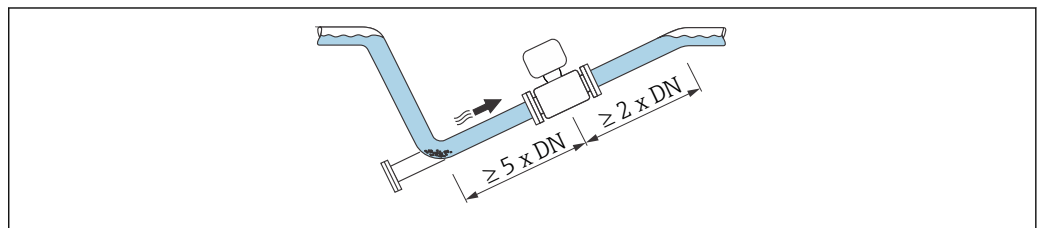

A0041088

Installation near pumps

NOTICE

Negative pressure in the measuring tube can damage the liner!

- ▶ In order to maintain the system pressure, install the device in the flow direction downstream from the pump.
- ▶ Install pulsation dampers if reciprocating, diaphragm or peristaltic pumps are used.

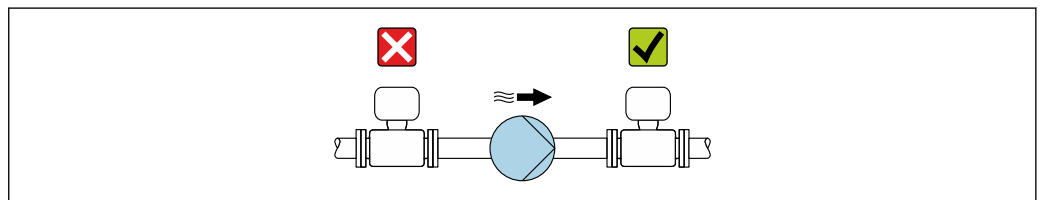

A0041083

- i
 - Information on the liner's resistance to partial vacuum → 59
 - Information on the measuring system's resistance to vibration and shock → 58

Installation in event of pipe vibrations



NOTICE

Pipe vibrations can damage the device!

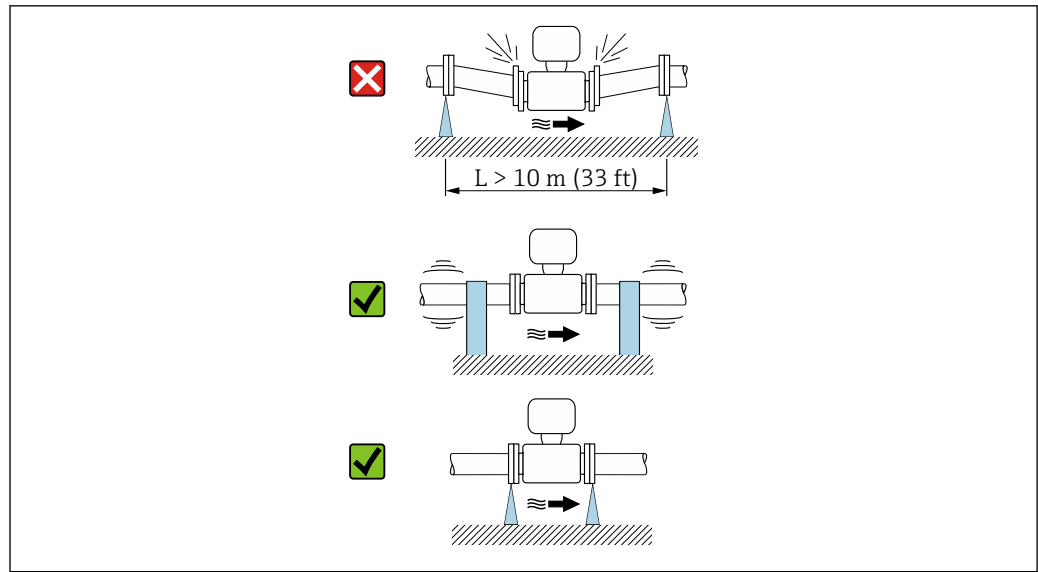
- ▶ Do not expose the device to strong vibrations.
- ▶ Support the pipe and fix it in place.
- ▶ Support the device and fix it in place.











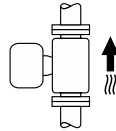

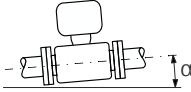
A0041092

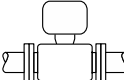
 Information on the measuring system's resistance to vibration and shock →  58

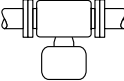
Orientation

The direction of the arrow on the nameplate helps you to install the measuring device according to the flow direction (direction of medium flow through the piping).

Orientation		Recommendation
Vertical orientation	 <p style="text-align: right; font-size: small;">A0015591</p>	
Horizontal orientation	 <p style="text-align: right; font-size: small;">A0041328</p>	 ¹⁾
Horizontal orientation, transmitter at top	 <p style="text-align: right; font-size: small;">A0015589</p>	 ²⁾
Horizontal orientation, transmitter at bottom	 <p style="text-align: right; font-size: small;">A0015590</p>	 ^{3) 4)}
Horizontal orientation, transmitter at side	 <p style="text-align: right; font-size: small;">A0015592</p>	

- 1) The measuring device should be self-draining for hygiene applications. A vertical orientation is recommended for this. If only a horizontal orientation is possible, an angle of inclination $\alpha \geq 10^\circ$ is recommended.
- 2) Applications with low process temperatures may reduce the ambient temperature. To maintain the minimum ambient temperature for the transmitter, this orientation is recommended.
- 3) Applications with high process temperatures may increase the ambient temperature. To maintain the maximum ambient temperature for the transmitter, this orientation is recommended.
- 4) To prevent the electronics from overheating in the event of strong heat formation (e.g. CIP or SIP cleaning process), install the device with the transmitter part pointing downwards.

Horizontal

Ideally, the measuring electrode plane should be horizontal. This prevents brief insulation of the measuring electrodes by entrained air bubbles.

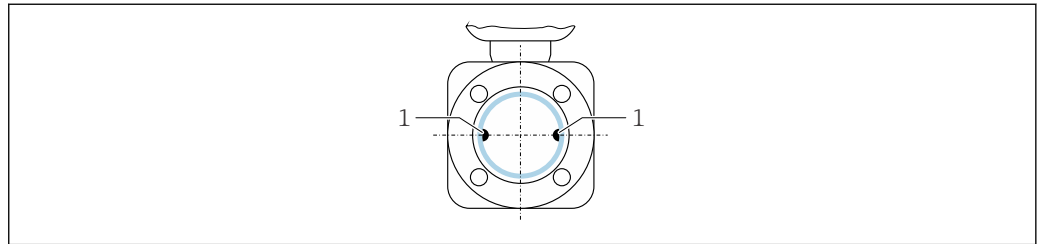

A0025817

1 Measuring electrodes for signal detection

Valves

Never install the measuring device downstream from a filling valve. Completely emptying the measuring device results in a high distortion of the measured value.

i Correct measurement is possible only if the piping is completely filled. Perform sample fillings before commencing filling in production.

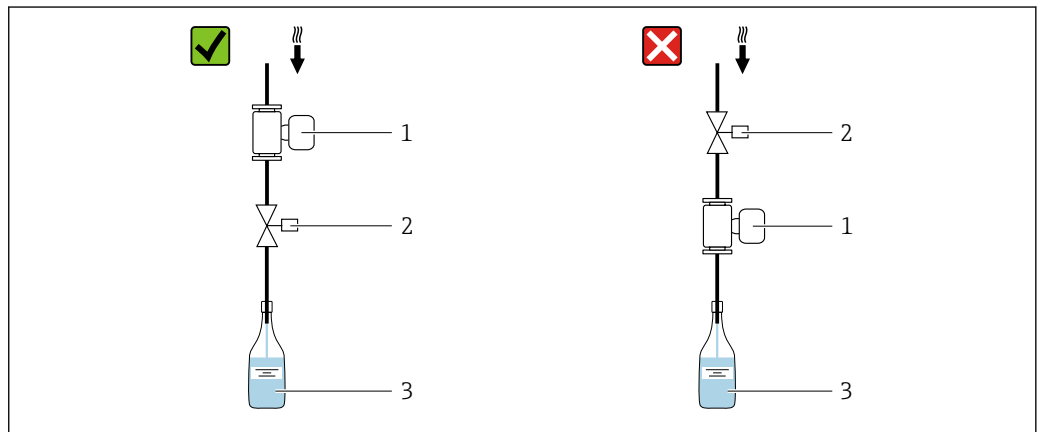

A0003768

1 Measuring device
 2 Filling valve
 3 Vessel

Filling systems

The pipe system must be completely full to ensure optimum measurement.

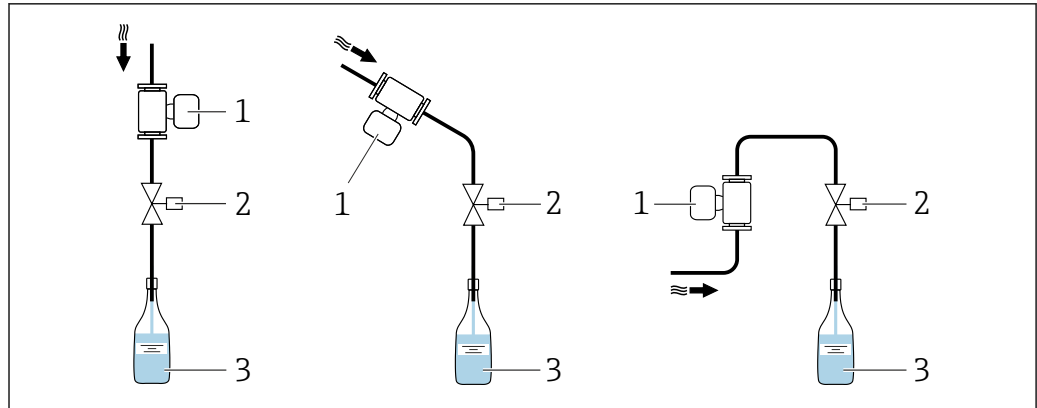

A0003795

3 Filling system

- 1 Measuring device
- 2 Filling valve
- 3 Vessel

Inlet and outlet runs

Installation with inlet and outlet runs

To avoid a vacuum and to maintain the specified level of measurement accuracy, install the device upstream from assemblies that produce turbulence (e.g. valves, T-sections) and downstream from pumps.

Maintain straight, unimpeded inlet and outlet runs.

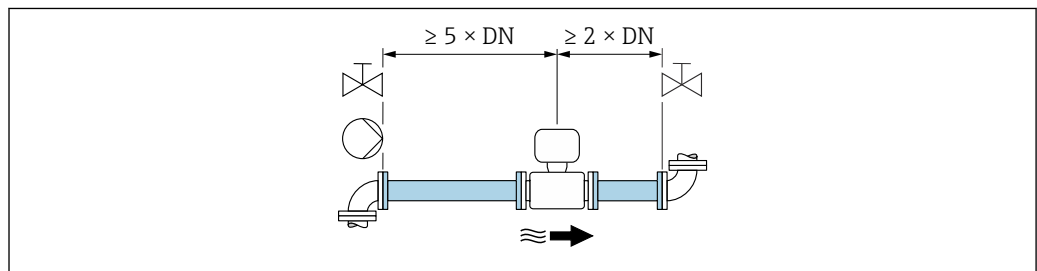

A0028997

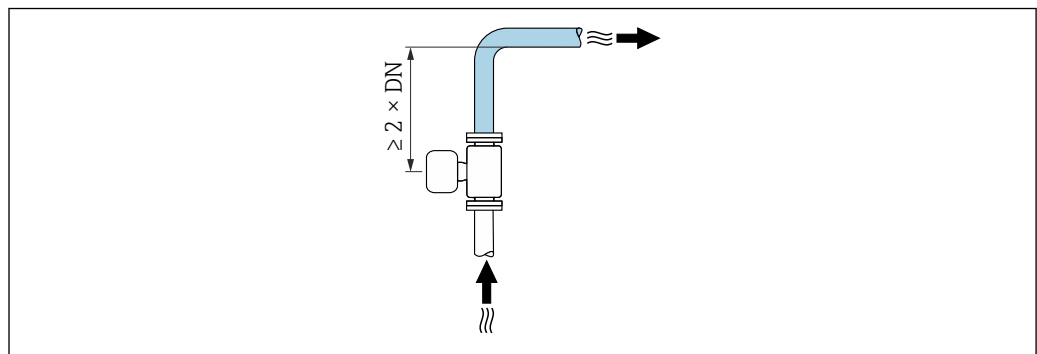

A0042132

Installation dimensions

For the dimensions and installation lengths of the device, see the "Technical Information" document, "Mechanical construction" section

6.1.2 Environmental and process requirements

Ambient temperature range

Measuring instrument	-40 to +60 °C (-40 to +140 °F) Install the measuring instrument in a shady location. Avoid direct sunlight, particularly in warm climatic regions.
Liner	Do not exceed or fall below the permitted temperature range of the liner → 58.

System pressure

Installation near pumps → 15

Vibrations

Installation in event of pipe vibrations → 15

Adapters

The measuring device can also be installed in larger-diameter pipes with the aid of suitable adapters according to DIN EN 545 (double-flange reducers). The resultant increase in the rate of flow improves measuring accuracy with very slow-moving fluids. The nomogram shown here can be used to calculate the pressure loss caused by reducers and expanders.

- i** The nomogram only applies to liquids with a viscosity similar to that of water.
- If the medium has a high viscosity, a larger measuring tube diameter can be considered in order to reduce pressure loss.

1. Calculate the ratio of the diameters d/D .
2. From the nomogram read off the pressure loss as a function of flow velocity (downstream from the reduction) and the d/D ratio.

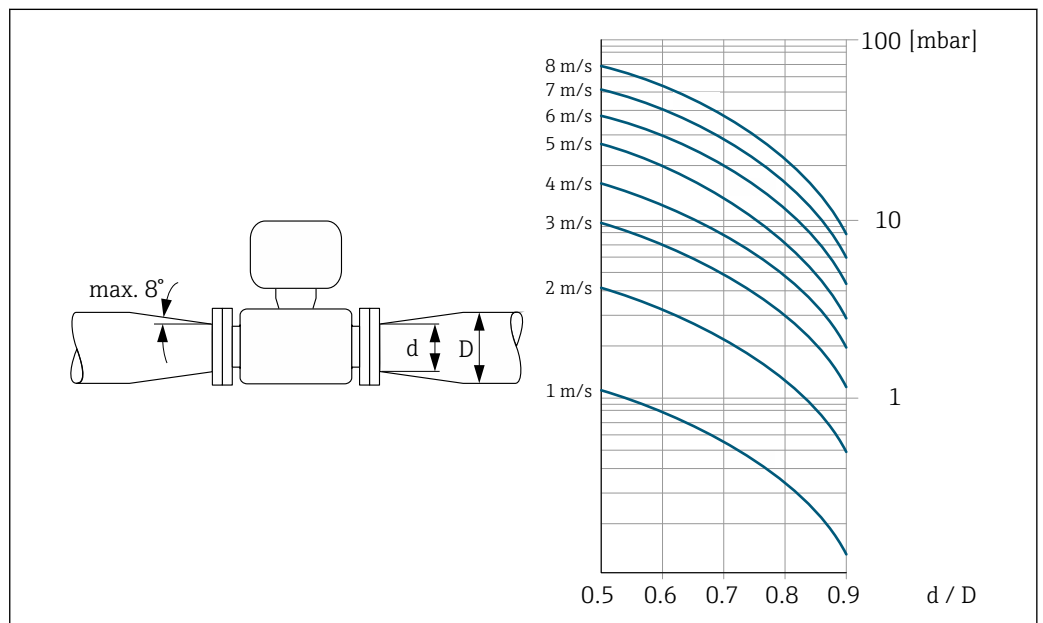

6.1.3 Special mounting instructions

Information for filling systems

Correct measurement is only possible if the pipe is completely full. We therefore recommend that some test batches be carried out prior to production batching.

Circular filling system

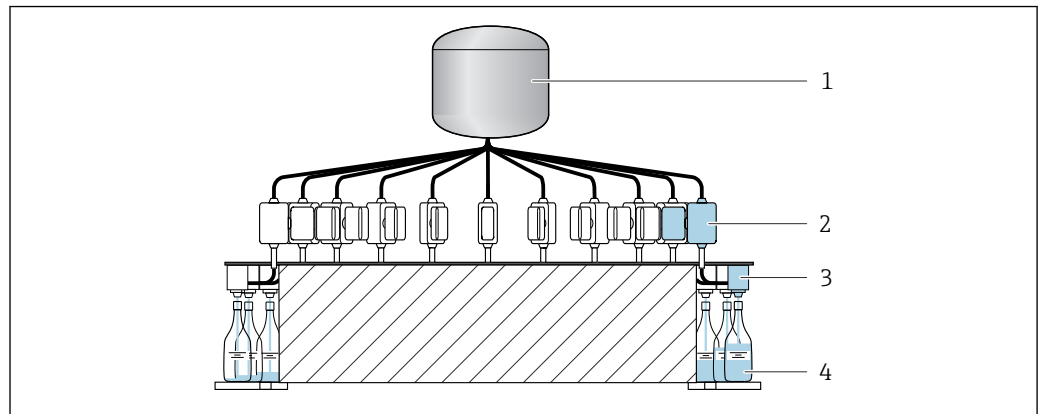

A0003761

- 1 Tank
- 2 Measuring instrument
- 3 Filling valve
- 4 Vessel

Linear filling system

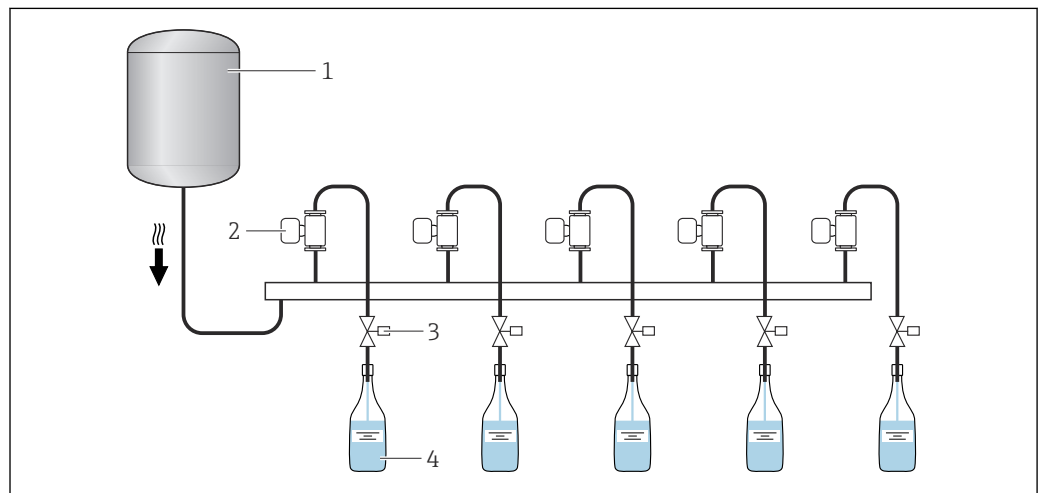

A0003762

- 1 Tank
- 2 Measuring instrument
- 3 Filling valve
- 4 Vessel

Hygienic compatibility

i When installing in hygienic applications, please refer to the information in the "Certificates and approvals/hygienic compatibility" section → 63

Wall mounting kit

i Depending on the application and pipe length, the measuring instrument may need to be supported or additionally secured. In particular, it is absolutely essential to secure the measuring instrument additionally if plastic process connections are used. An appropriate wall mounting kit can be ordered separately as an accessory from Endress +Hauser. → 51

Zero adjustment

The **Sensor adjustment** submenu contains parameters required for zero adjustment.



Detailed information on the "**Sensor adjustment** submenu": Device parameters → 64

NOTICE

All Dosimag measuring instruments are calibrated in accordance with state-of-the-art technology. Calibration takes place under reference conditions .

Zero adjustment is therefore not required for the Dosimag as a general rule.

- ▶ Experience shows that a zero adjustment is advisable only in special cases.
- ▶ When maximum measurement accuracy is required and flow rates are very low.



Detailed information on reference operating conditions → 56

Prerequisites for zero adjustment

Note the following points before performing the adjustment:

- A zero adjustment can be performed only with fluids that contain no gas or solid contents.
- Zero adjustment is performed with the measuring tubes completely filled and at zero flow ($v = 0 \text{ m/s}$ (0 ft/s)). Shutoff valves, for example, may be provided for this purpose or existing valves and sliders can be used.
 - Normal operation → Valve 1 open
 - Zero adjustment → Valve 1 closed

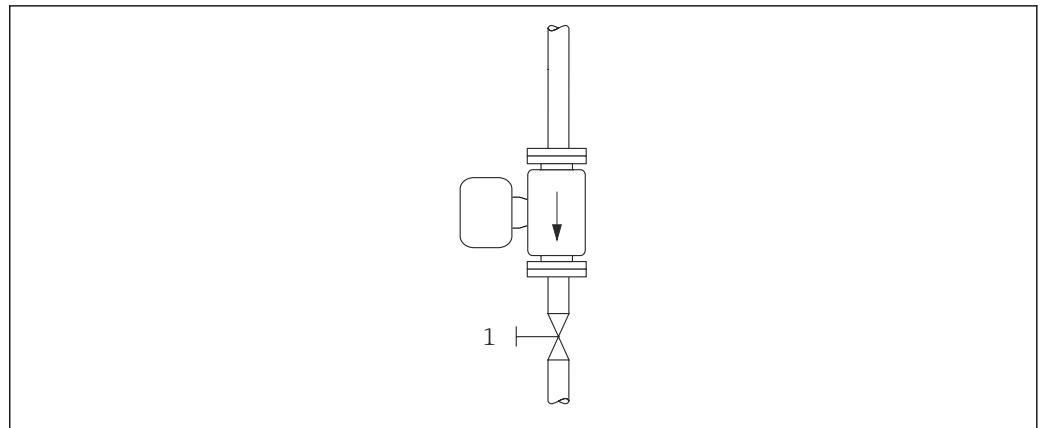

4

Performing the zero adjustment

1. Let the system run until normal operating conditions are present.
2. Stop the flow ($v = 0 \text{ m/s}$ (0 ft/s)).
3. Check the shutoff valves for leaks.
4. Perform adjustment using the **Zero point adjustment control** function.

6.2 Mounting the measuring instrument

6.2.1 Required tools

For process connections, use the appropriate installation tool

6.2.2 Preparing the measuring instrument

1. Remove all remaining transport packaging.
2. Remove any protective covers or protective caps present from the measuring instrument.

6.2.3 Mounting the measuring instrument



⚠ WARNING

Danger due to improper process sealing!

- ▶ Ensure that the inside diameters of the gaskets are greater than or equal to that of the process connections and piping.
- ▶ Ensure that the seals are clean and undamaged.
- ▶ Secure the seals correctly.

The measuring instrument is supplied to order, with or without pre-installed process connections. Pre-installed process connections are secured to the measuring instrument using 4 hexagonal-headed bolts.



- ▶ Ensure that the direction of the arrow on the nameplate of the measuring instrument matches the flow direction of the medium. →  12

-  Depending on the application and pipe length, the measuring instrument may need to be supported or additionally secured. →  51

Welding the measuring instrument into the pipe (welding nipples)

⚠ WARNING

Risk of destroying the electronics!

- ▶ Make sure that the welding system is not earthed via the measuring instrument.
1. Tack-weld the measuring instrument to secure it in the pipe. A suitable welding jig can be ordered separately as an accessory. →  64
 2. Loosen the screws on the process connection flange and remove the measuring instrument, along with the seal, from the pipe.
 3. Weld the process connection into the pipe.
 4. Reinstall the measuring instrument in the pipe, and in doing so make sure that the seal is clean and in the right position.
- 
 - If thin-walled pipes carrying food are welded correctly, the seal is not damaged by the heat even when mounted. However, it is recommended to disassemble the measuring instrument and seal.
 - It must be possible to open the pipe by at least 8 mm (0.31 in) for disassembly.



Mounting the seals

Comply with the following instructions when installing seals:

1. The seals should be dry, clean, undamaged and correctly centered.
2. In the case of metal process connections, the screws must be tightened securely. The process connection forms a metal connection with the measuring instrument, which ensures a defined compression of the seal.
3. With regard to process connections made of plastic material, comply with the max. torques for lubricated threads: 7 Nm (5.2 lbf ft).
4. Depending on the application, the seals should be replaced periodically, particularly if molded seals are used (aseptic version). The interval between changes depends on the frequency of the cleaning cycles, the cleaning temperature and the medium temperature. Replacement seals can be ordered as an accessory.

Mounting grounding rings

In the case of plastic process connections (e.g. external thread), the potential equalization between the measuring instrument/medium and the additional ground rings must be ensured. If grounding rings are not installed, this can affect the measurement accuracy or cause the destruction of the measuring instrument as a result of the electrochemical decomposition of the electrodes.

 Pay attention to the information on potential equalization →  28.

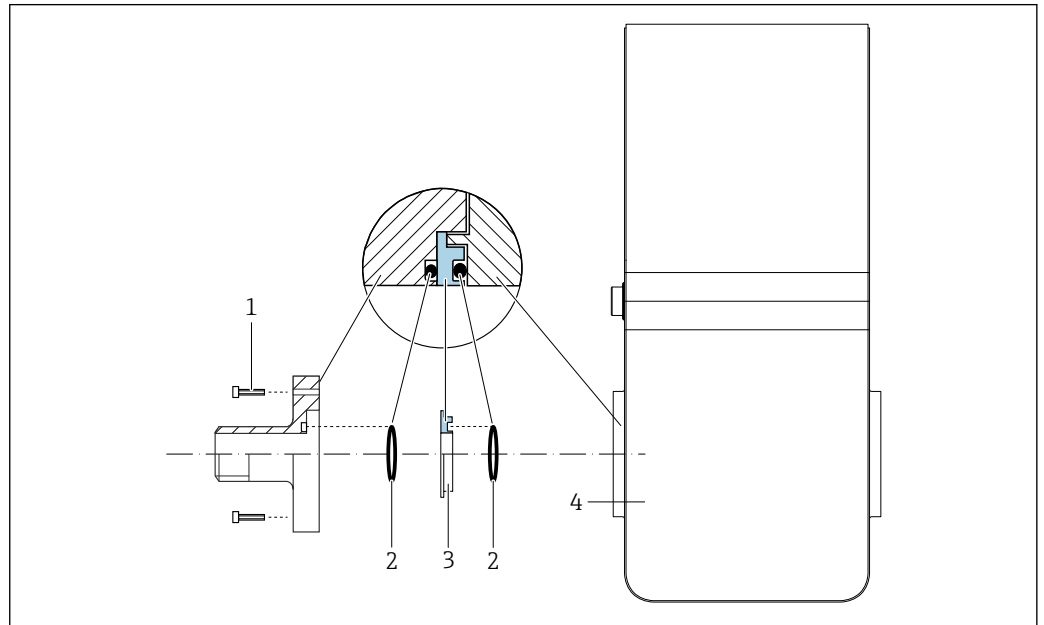

A0053324

5 Installing grounding rings

- 1 Hexagonal-headed bolts of process connection
- 2 O-ring seals
- 3 Grounding ring or plastic disk (spacer)
- 4 Measuring instrument

1. Release 4 hexagonal-headed bolts (1) and remove the process connection from the measuring instrument (4).
2. Remove the plastic disk (3), along with the two O-ring seals (2), from the process connection.
3. Place the first O-ring seal (2) back into the groove of the process connection.
4. Fit the metal grounding ring (3) in the process connection as illustrated.
5. Place the second O-ring seal (2) into the groove of the grounding ring.
6. Mount the process connection back on the measuring instrument. When doing so, make sure to observe the maximum screw tightening torques for lubricated threads: 7 Nm (5.2 lbf ft)

6.3 Post-mounting check

Is the measuring instrument undamaged (visual inspection)?	<input type="checkbox"/>
Does the measuring instrument conform to the measuring point specifications? For example: <ul style="list-style-type: none"> ▪ Process temperature → 58 ▪ Process pressure → 60 ▪ Ambient temperature → 57 ▪ Measuring range → 53 	<input type="checkbox"/>
Horizontal position of the measuring electrode plane → 17?	<input type="checkbox"/>
Has the correct orientation been selected for the measuring instrument → 16? <ul style="list-style-type: none"> ▪ As per measuring instrument type ▪ According to medium temperature ▪ According to medium properties (outgassing, with entrained solids) 	<input type="checkbox"/>
Does the arrow on the measuring instrument nameplate match the direction of flow of the medium through the piping → 12?	<input type="checkbox"/>
Are the measuring point identification and labeling correct (visual inspection)?	<input type="checkbox"/>
Is the measuring instrument adequately protected against vibration (attachment, support) → 15?	<input type="checkbox"/>
Are the inlet and outlet runs to respected → 18?	<input type="checkbox"/>

7 Electrical connection

WARNING

Live parts! Incorrect work performed on the electrical connections can result in an electric shock.

- ▶ Set up a disconnecting device (switch or power-circuit breaker) to easily disconnect the device from the supply voltage.
- ▶ In addition to the device fuse, include an overcurrent protection unit with max. 16 A in the plant installation.

7.1 Electrical safety

In accordance with applicable national regulations.

7.2 Connecting requirements

7.2.1 Requirements for connection cable

The connecting cables provided by the customer must fulfill the following requirements.

Permitted temperature range

- The installation guidelines that apply in the country of installation must be observed.
- The cables must be suitable for the minimum and maximum temperatures to be expected.

Signal cable

 Cables are not included in the scope of delivery.

 Please note the following with regard to cable loading:
Voltage drop due to the cable length and cable type.

Pulse/frequency/switch output

Standard installation cable is sufficient.

7.2.2 Terminal assignment

Connection is solely by means of device plug →  25.

7.2.3 Available device plugs

Device version: 2 pulse/frequency/switch outputs

Order code for "Output, input": option AA:
2 pulse/frequency/switch outputs

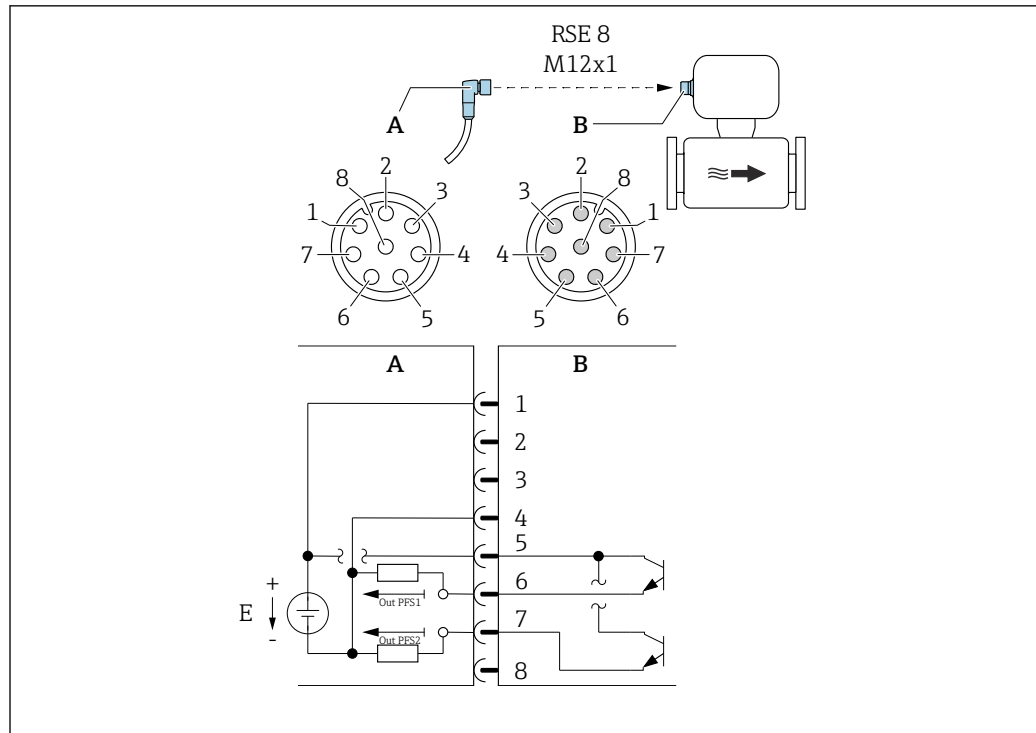

A0054873

6 Connection to device

- A Coupling: Supply voltage, pulse/freq./switch output
 B Connector: Supply voltage, pulse/freq./switch output
 E PELV or SELV power supply
 1 to 8 Pin assignment

Pin assignment

Connection: Coupling (A) – Connector (B)		
Pin	Assignment	
1	L+	Supply voltage
2	+	Service interface RX
3	+	Service interface TX
4	L-	Supply voltage
5	+	Pulse/frequency/switch output 1 and 2
6	-	Pulse/frequency/switch output 1
7	-	Pulse/frequency/switch output 2
8	-	Service interface GND

7.2.4 Requirements for the supply unit

Supply voltage

DC 24 V (nominal voltage: DC 18 to 30 V)

- i** The power unit must be tested to ensure that it meets safety requirements (e.g. PELV/SELV Class II limited energy).
- The equipment is classified as Class III.

7.3 Connecting the device

NOTICE

An incorrect connection compromises electrical safety!

- ▶ Only properly trained specialist staff may perform electrical connection work.
- ▶ Observe applicable federal/national installation codes and regulations.
- ▶ Comply with local workplace safety regulations.
- ▶ When using in potentially explosive atmospheres, observe the information in the device-specific Ex documentation.

7.3.1 Connection via device plug

Connection is solely by means of device plug.

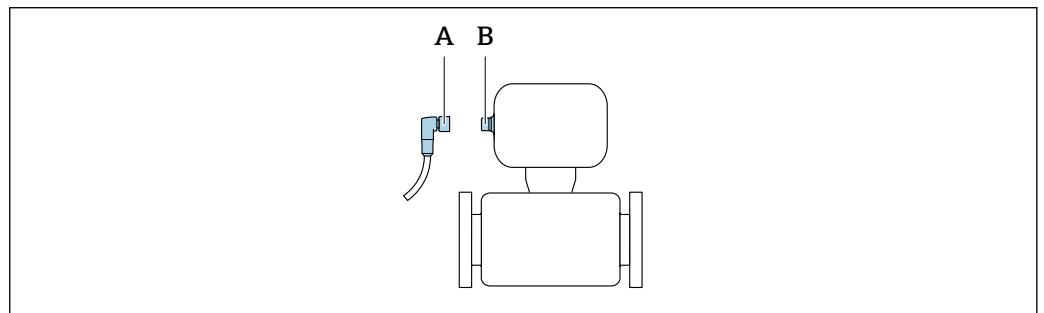

A0032652

- A Coupling
- B Plug

7.3.2 Grounding

Grounding is by means of a cable socket.

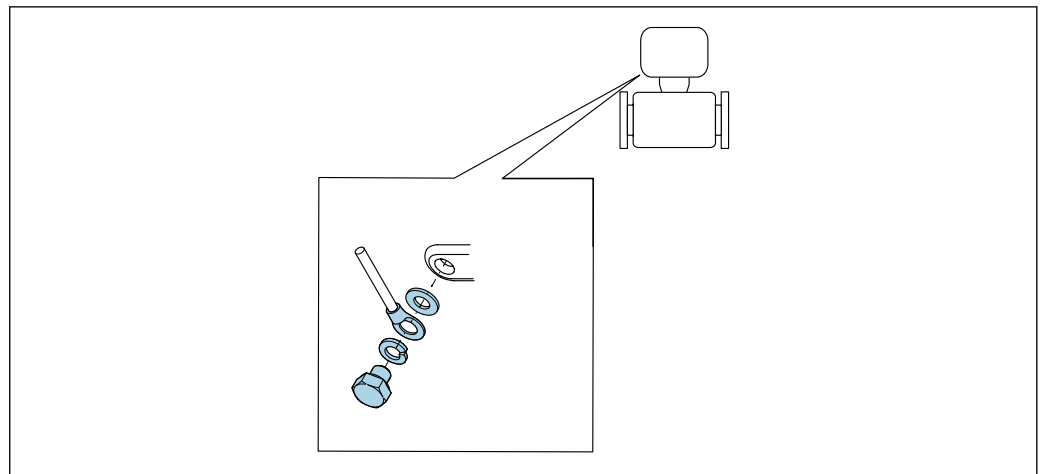

A0053306

7.4 Ensuring potential equalization

7.4.1 Requirements

For potential equalization:

- Pay attention to in-house grounding concepts
- Take account of operating conditions like the pipe material and grounding
- Connect the medium and measuring instrument to the same electric potential
- Use a ground cable with a minimum cross-section of 6 mm² (0.0093 in²) and a cable lug for potential equalization connections



For devices intended for use in hazardous locations, please observe the guidelines in the Ex documentation (XA).



7.4.2 Metal process connections

Potential equalization is via the metal process connections that are in contact with the medium and mounted directly on the measuring instrument.

7.4.3 Plastic process connections



Note the following when using grounding rings:

- Depending on the option ordered, plastic disks are used instead of grounding rings on some process connections. The plastic disks act as "spacers" and do not have any potential equalization function. They perform a significant sealing function at the measuring instrument and process connection interfaces. In the case of process connections without metal grounding rings, the plastic disks and seals must never be removed. Plastic disks and seals must always be installed.
- Grounding rings can be ordered separately as an accessory from Endress+Hauser →  64. The grounding rings must be compatible with the electrode material, as otherwise there is the danger that the electrodes could be destroyed by electrochemical corrosion. Material specifications →  60.
- Grounding rings, including seals, are installed inside the process connections. This does not affect the installed length.

Potential equalization via additional grounding ring

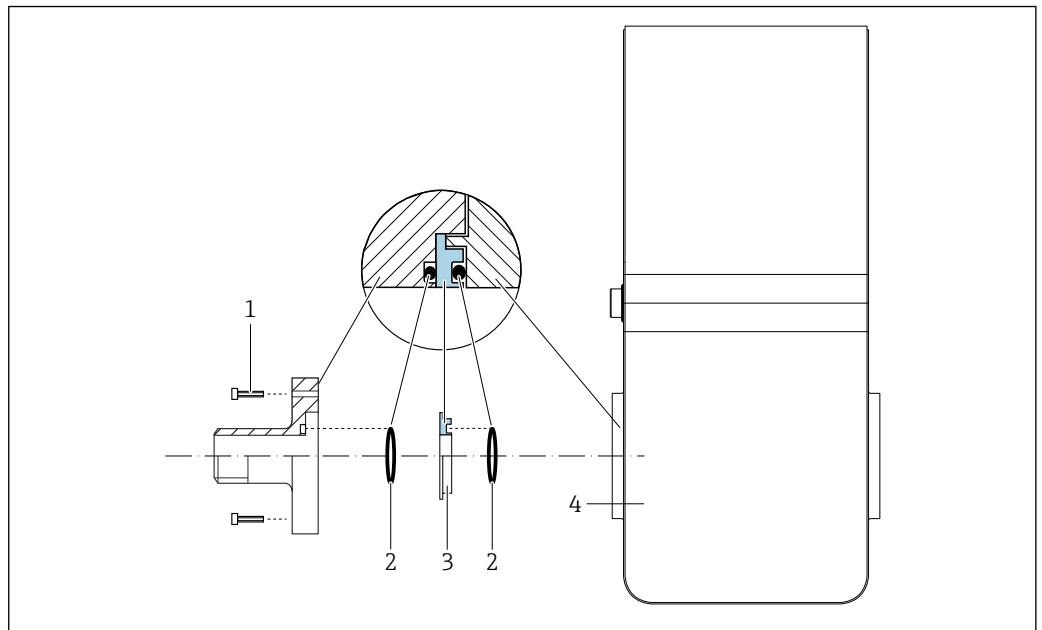

A0053324

- 1 Hexagonal-headed bolts of process connection
- 2 O-ring seals
- 3 Plastic disk (spacer) or grounding ring
- 4 Measuring instrument

Potential equalization via grounding electrodes on process connection

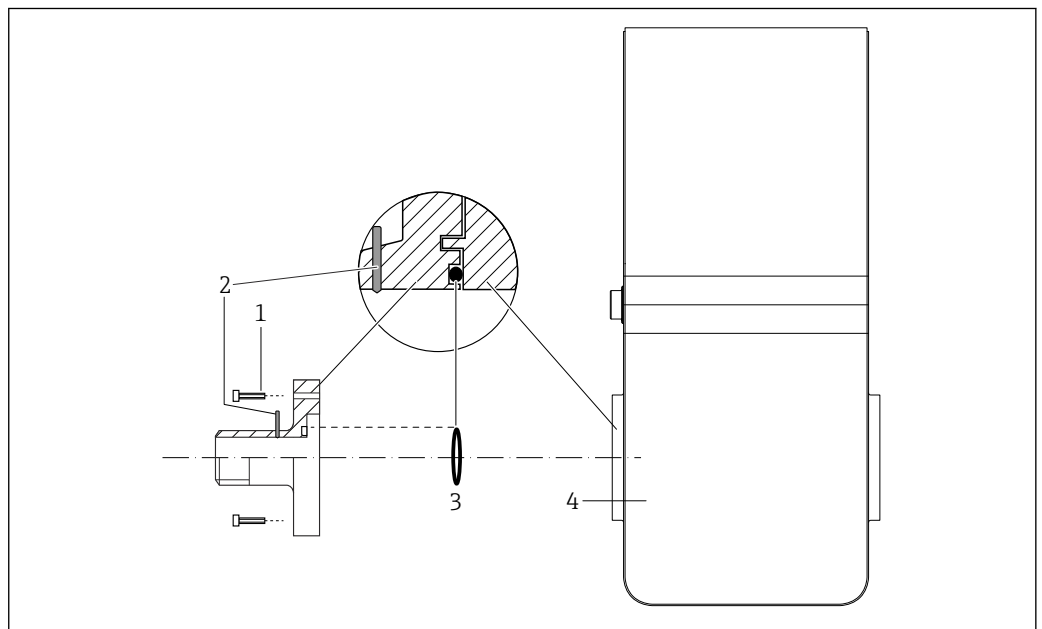

A0053325

- 1 Hexagonal-headed bolts of process connection
- 2 Integrated grounding electrodes
- 3 O-ring seal
- 4 Measuring instrument







7.5 Ensuring the degree of protection

The measuring device fulfills all the requirements for IP67 degree of protection, Type 4X enclosure.

To guarantee IP67 degree of protection, Type 4X enclosure, carry out the following steps after the electrical connection:

- ▶ Tighten all device plugs.

7.6 Post-connection check

Is the device undamaged (visual inspection)?	<input type="checkbox"/>
Does the supply voltage match the specifications on the transmitter nameplate →  12?	<input type="checkbox"/>
Do the cables used meet the requirements →  25?	<input type="checkbox"/>
Are the mounted cables strain relieved?	<input type="checkbox"/>
Is the terminal assignment correct →  25?	<input type="checkbox"/>
Is the protective earthing established correctly →  27?	<input type="checkbox"/>
Is the potential equalization established correctly →  28?	<input type="checkbox"/>
Are the maximum values for voltage and current observed at the pulse/frequency/switch outputs →  54?	<input type="checkbox"/>

8 Operation options

8.1 Overview of operation options

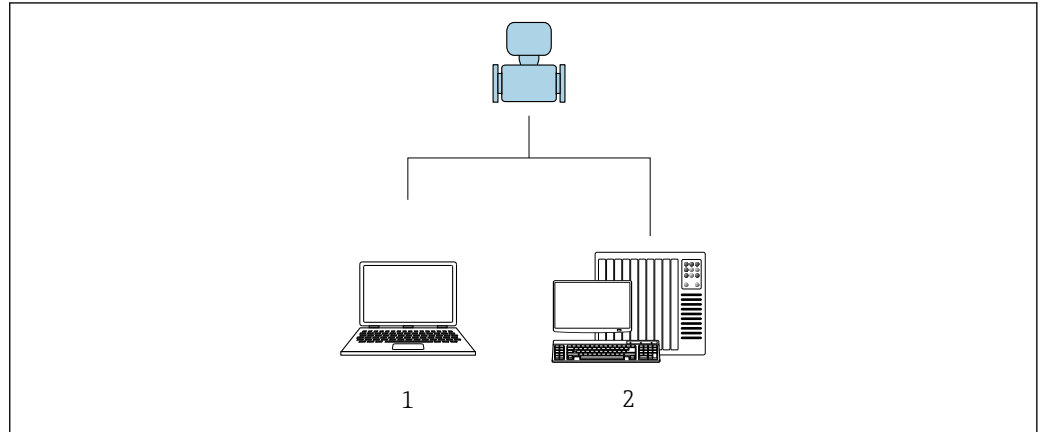

A0017760

- 1 Computer with "FieldCare" or "DeviceCare" operating tool
- 2 Control system (e.g. PLC)

8.2 Access to the operating menu via the operating tool

8.2.1 Connecting the operating tool

Using service adapter and Commubox FXA291

Operation and configuration can be performed using the Endress+Hauser FieldCare or DeviceCare service and configuration software.

The device is connected to the USB port of the computer via the service adapter and Commubox FXA291.

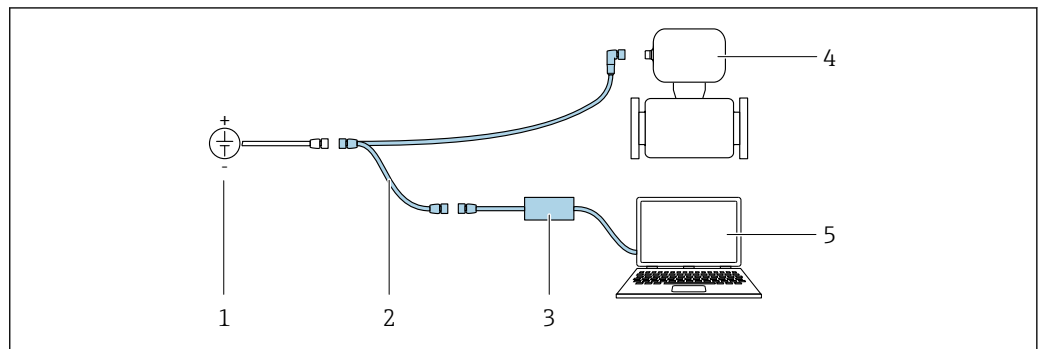

A0032567

- 1 Supply voltage 24 V DC
- 2 Service adapter
- 3 Commubox FXA291
- 4 Dosimag
- 5 Computer with "FieldCare" or "DeviceCare" operating tool

i The service adapter, cable and Commubox FXA291 are not included in the delivery. These components can be ordered as accessories → 51.

8.2.2 FieldCare

Function range

FDT-based (Field Device Technology) plant asset management tool from Endress+Hauser. It can configure all smart field units in a system and helps you manage them. By using the status information, it is also a simple but effective way of checking their status and condition.

Access is via:

Service adapter and Commubox FXA291

Typical functions:

- Transmitter parameter configuration
- Loading and saving of device data (upload/download)
- Documentation of the measuring point
- Visualization of the measured value memory (line recorder) and event logbook



- Operating Instructions BA00027S
- Operating Instructions BA00059S



Source for device description files →  34

Establishing a connection

Service adapter, Commubox FXA291 and "FieldCare" operating tool

1. Start FieldCare and launch the project.
2. In the network: Add a device.
 - ↳ The **Add device** window opens.
3. Select the **CDI Communication FXA291** option from the list and press **OK** to confirm.
4. Right-click **CDI Communication FXA291** and select the **Add device** option in the context menu that opens.
5. Select the desired device from the list and press **OK** to confirm.
6. Establish the online connection to the device.



- Operating Instructions BA00027S
- Operating Instructions BA00059S

User interface

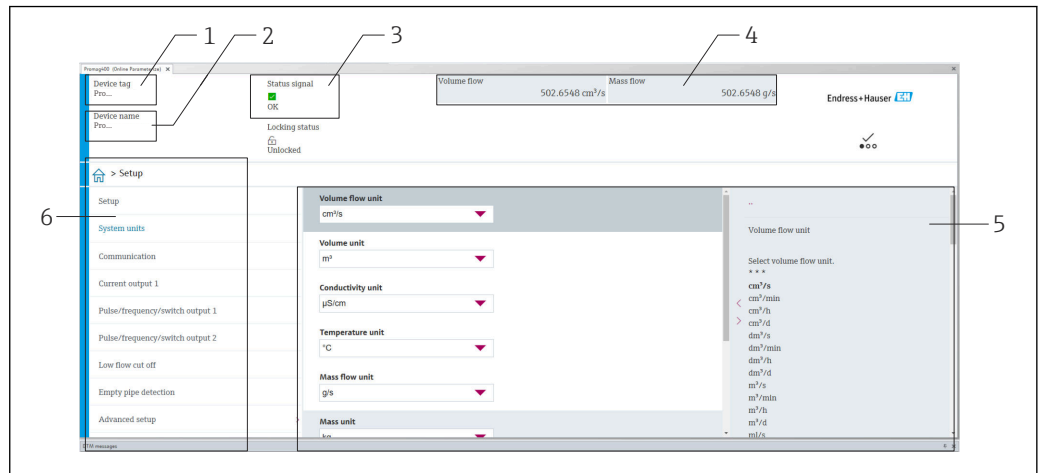

A0008200

- 1 Device name
- 2 Device tag
- 3 Status area with status signal → 38
- 4 Display area for current measured values
- 5 Editing toolbar with other functions
- 6 Navigation area with operating menu structure

8.2.3 DeviceCare

Function range

Tool for connecting and configuring Endress+Hauser field devices.

The fastest way to configure Endress+Hauser field devices is with the dedicated "DeviceCare" tool. Together with the device type managers (DTMs) it presents a convenient, comprehensive solution.



Innovation brochure IN01047S





Source for device description files → 34

9 System integration

9.1 Overview of device description files

9.1.1 Current version data for the device

Firmware version	04.00.zz	<ul style="list-style-type: none"> ▪ On the title page of the manual ▪ On the measuring instrument nameplate →  12 ▪ Firmware version System → Information → Device → Firmware version
Release date of firmware version	06.2024	---

 For an overview of the various firmware versions for the device →  45

9.1.2 Operating tools



The suitable device description file for the individual operating tools is listed in the table below, along with information on where the file can be acquired.

Operating tool	Sources for obtaining device descriptions
FieldCare	<ul style="list-style-type: none"> ▪ www.endress.com → Downloads area ▪ USB stick (contact Endress+Hauser) ▪ DVD (contact Endress+Hauser)
DeviceCare	<ul style="list-style-type: none"> ▪ www.endress.com → Downloads area ▪ CD-ROM (contact Endress+Hauser) ▪ DVD (contact Endress+Hauser)

10 Commissioning

10.1 Post-mounting and post-connection check

Before commissioning the device:

- ▶ Make sure that the post-installation and post-connection checks have been performed successfully.
- Checklist for "Post-mounting" check →  24
- Checklist for "Post-connection check" →  30

10.2 Switching on the measuring device

- ▶ The function check has been completed successfully.
Switch on the supply voltage.
 - ↳ The measuring device runs through internal test functions.

The device is operational and operation commences.

 If the device does not start up successfully, depending on the cause, a diagnostic message is displayed in the system asset management tool "FieldCare".

10.3 Connecting via FieldCare

- For connecting FieldCare →  31
- For connecting via FieldCare →  32
- For user interface of FieldCare →  33

10.4 Configuring the measuring instrument

 The device-specific parameters are configured via the "**Commissioning** wizard".

 For detailed information on the "**Commissioning** wizard": Separate "Description of Device Parameters"(GP) document →  64

11 Operation

11.1 Reading the device locking status

Navigation

"System" menu → Device management → Locking status

Parameter overview with brief description

Parameter	Description	User interface
Locking status	Indicates the write protection with the highest priority that is currently active.	Temporarily locked

11.2 Reading access authorization status on operating software

Navigation

"System" menu → User management → User role

Parameter overview with brief description

Parameter	Description	User interface
User role	Displays the role the user is currently logged on in. The role determines the user's access rights for the parameters. The access rights can be changed via the "Enter access code" parameter.	<ul style="list-style-type: none"> ▪ Operator ▪ Maintenance ▪ Service ▪ Production ▪ Development

11.3 Reading measured values

Navigation

"Application" menu → Measured values



Parameter overview with brief description

Parameter	Description	User interface
Volume flow	Shows the volume flow currently measured.	Signed floating-point number

11.4 Adapting the measuring instrument to the process conditions

The following menus are available for this purpose:

- Guidance
- Application

 Detailed information on "**Guidance** menu" and "**Application** menu": Device parameters →  64

11.5 Performing a totalizer reset

Navigation

"Application" menu → Totalizers → Totalizer handling → Reset all totalizers

Parameter overview with brief description

Parameter	Description	Selection
Reset all totalizers	Reset all totalizers to "0" and restart the totalizers. The counter readings are not logged prior to the reset.	<ul style="list-style-type: none">▪ Cancel▪ Reset + totalize

12 Diagnostics and troubleshooting

12.1 General troubleshooting

For access

Error	Possible causes	Remedial action
Write access to parameter not possible.	Current user role has limited access authorization.	Check the access authorization status → 36.
Connection via the service adapter is not possible.	<ul style="list-style-type: none"> The USB port on the PC is incorrectly configured. The driver is not installed correctly. 	Observe the documentation for the Commubox FXA291:  Technical Information TI00405C

12.2 Diagnostic information in FieldCare or DeviceCare

12.2.1 Diagnostic options

Any faults detected by the measuring device are displayed on the home page of the operating tool once the connection has been established.

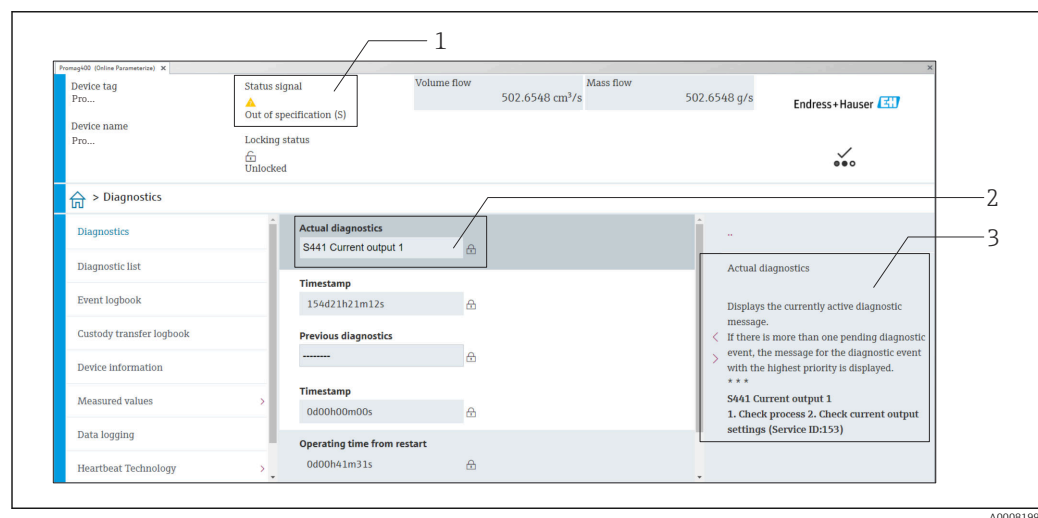





- 1 Status area with status signal
- 2 Diagnostic information → 39
- 3 Remedial measures with service ID

 In addition, diagnostic events which have occurred can be shown in the **Diagnostics** menu:

- Via parameter
- Via submenu

Status signals

The status signals provide information on the state and reliability of the device by categorizing the cause of the diagnostic information (diagnostic event).

Symbol	Meaning
	Failure A device error has occurred. The measured value is no longer valid.
	Function check The device is in service mode (e.g. during a simulation).
	Out of specification The device is being operated: Outside its technical specification limits (e.g. outside the process temperature range)
	Maintenance required Maintenance is required. The measured value remains valid.

 The status signals are categorized in accordance with VDI/VDE 2650 and NAMUR Recommendation NE 107.

Diagnostic information

The fault can be identified using the diagnostic information. The short text helps you by providing information about the fault.

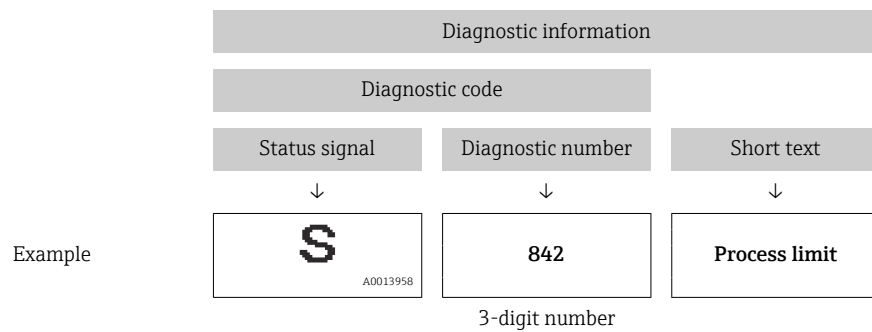

12.2.2 Calling up remedy information

Remedy information is provided for every diagnostic event to ensure that problems can be rectified quickly:

- On the home page
Remedy information is displayed in a separate field below the diagnostics information.
- In the **Diagnostics** menu
Remedy information can be called up in the working area of the user interface.

The user is in the **Diagnostics** menu.

1. Call up the desired parameter.
2. On the right in the working area, mouse over the parameter.
 - ↳ A tool tip with remedy information for the diagnostic event appears.

12.3 Adapting the diagnostic information

12.3.1 Adapting the diagnostic behavior



Each item of diagnostic information is assigned a specific diagnostic behavior at the factory. The user can change this assignment for specific diagnostic information in the **Diagnostic settings** submenu.

Diagnostics → Diagnostic settings

You can assign the following options to the diagnostic number as the diagnostic behavior:

Options	Description
Alarm	The device stops measurement. The signal outputs and totalizers assume the defined alarm condition. A diagnostic message is generated.
Warning	The device continues to measure. The signal outputs and totalizers are not affected. A diagnostic message is generated.
Logbook entry only	The device continues to measure. The diagnostic message is entered only in the Event logbook submenu.
Off	The diagnostic event is ignored, and no diagnostic message is generated or entered.

12.4 Overview of diagnostic information

 In the case of some items of diagnostic information, the diagnostic behavior can be changed. Adapting the diagnostic information →  39



Diagnostic number	Short text	Remedy instructions	Status signal [from the factory]	Diagnostic behavior [from the factory]
Diagnostic of sensor				
004	Sensor defective	Change sensor	S	Warning
082	Data storage inconsistent	1. Restart device 2. Replace device	F	Alarm
083	Memory content inconsistent	1. Restart device 2. Restore S-DAT	F	Alarm
180	Temperature sensor defective	1. Check sensor connections 2. Replace sensor cable or sensor 3. Turn off temperature measurement	F	Warning
181	Sensor connection faulty	Replace device	F	Alarm
Diagnostic of electronic				
201	Electronics faulty	1. Restart device 2. Replace device	F	Alarm
242	Firmware incompatible	1. Check firmware version 2. Flash device	F	Alarm
252	Module incompatible	Replace device	F	Alarm
270	Main electronics defective	1. Restart device 2. Replace device	F	Alarm
271	Main electronics faulty	1. Restart device 2. Replace device	F	Alarm
272	Electronic module faulty	Restart device	F	Alarm
273	Main electronics defective	1. Restart device 2. Replace device	F	Alarm
283	Memory content inconsistent	Restart device	F	Alarm
311	Electronic module faulty	Maintenance required! Do not reset device	M	Warning
331	Firmware update failed in module 1 to n	1. Update firmware of device 2. Restart device	F	Warning
Diagnostic of configuration				
410	Data transfer failed	1. Retry data transfer 2. Check connection	F	Alarm

Diagnostic number	Short text	Remedy instructions	Status signal [from the factory]	Diagnostic behavior [from the factory]
412	Processing download	Download active, please wait	C	Warning
437	Configuration incompatible	1. Update firmware 2. Execute factory reset	F	Alarm
438	Dataset different	1. Check dataset file 2. Check device parameterization 3. Download new device parameterization	M	Warning
442	Frequency output 1 to n saturated	1. Check frequency output settings 2. Check process	S	Warning ¹⁾
443	Pulse output 1 to n saturated	1. Check pulse output settings 2. Check process	S	Warning ¹⁾
453	Flow override active	Deactivate flow override	C	Warning
484	Failure mode simulation active	Deactivate simulation	C	Alarm
485	Process variable simulation active	Deactivate simulation	C	Warning
492	Frequency output 1 to n simulation active	Deactivate simulation frequency output	C	Warning
493	Pulse output simulation active	Deactivate simulation pulse output	C	Warning
494	Switch output 1 to n simulation active	Deactivate simulation switch output	C	Warning
495	Diagnostic event simulation active	Deactivate simulation	C	Warning
496	Status input 1 simulation active	Deactivate status input simulation	C	Warning
Diagnostic of process				
834	Process temperature too high	Reduce process temperature	S	Warning ¹⁾
835	Process temperature too low	Increase process temperature	S	Warning ¹⁾
842	Process value below limit	Low flow cut off active! Check low flow cut off configuration	S	Warning ¹⁾
880	Output overloaded	Reduce load at the outputs	S	Warning
937	Sensor symmetry	1. Eliminate external magnetic field near sensor 2. Turn off diagnostic message	S	Warning ¹⁾
938	Coil current not stable	1. Check if external magnetic interference is present 2. Check flow value	F	Alarm ¹⁾
961	Electrode potential out of specification	1. Check process conditions 2. Check ambient conditions	S	Warning ¹⁾
991	Batch process aborted	Check process conditions	F	Alarm ¹⁾
992	Batch start failed	1. Check fill quantity 2. Check device status 3. Complete last batch 4. Check switch output configuration	F	Warning ¹⁾

1) Diagnostic behavior can be changed.







12.5 Pending diagnostic events

The **Diagnostics** menu allows the user to view the current diagnostic event and the previous diagnostic event separately.

-  To call up the measures to rectify a diagnostic event:
- Via "FieldCare" operating tool →  39
 - Via "DeviceCare" operating tool →  39

Navigation

"Diagnostics" menu → Active diagnostics

▶ Active diagnostics	
Actual diagnostics	→  42
Timestamp	→  42
Previous diagnostics	→  42
Timestamp	→  42
Operating time from restart	→  42
Operating time	→  42

Parameter overview with brief description



Parameter	Description	User interface
Actual diagnostics	Displays the currently active diagnostic message. If there is more than one pending diagnostic event, the message for the diagnostic event with the highest priority is displayed.	Positive integer
Timestamp	Displays the timestamp for the currently active diagnostic message.	Days (d), hours (h), minutes (m), seconds (s)
Previous diagnostics	Displays the diagnostic message for the last diagnostic event that has ended.	Positive integer
Timestamp	Displays the timestamp of the diagnostic message generated for the last diagnostic event that has ended.	Days (d), hours (h), minutes (m), seconds (s)
Operating time from restart	Indicates how long the device has been in operation since the last time the device was restarted.	Days (d), hours (h), minutes (m), seconds (s)
Operating time	Indicates how long the device has been in operation.	Days (d), hours (h), minutes (m), seconds (s)

12.6 Actual diagnostics

The current diagnostic message is displayed under Actual diagnostics. If several diagnostic events are pending at the same time, only the diagnostic message with the highest priority is displayed.



Navigation path

Diagnostics → Active diagnostics → Actual diagnostics

-  To call up the measures to rectify a diagnostic event:
- Via "FieldCare" operating tool →  39
 - Via "DeviceCare" operating tool →  39

12.7 Event logbook

12.7.1 Event history

-  To call up the measures to rectify a diagnostic event:
- Via "FieldCare" operating tool →  39
 - Via "DeviceCare" operating tool →  39

12.7.2 Overview of information events

Unlike a diagnostic event, an information event is displayed in the event logbook only and not in the diagnostic list.

Info number	Info name
I1000	----- (Device ok)
I1089	Power on
I1090	Configuration reset
I1091	Configuration changed
I1151	History reset
I1157	Memory error event list
I1335	Firmware changed
I1397	Fieldbus: access status changed
I1398	CDI: access status changed
I1512	Download started
I1513	Download finished
I1514	Upload started
I1515	Upload finished
I1622	Calibration changed
I1624	All totalizers reset
I1629	CDI: login successful
I1635	Reset to delivery settings

12.8 Resetting the measuring device

The entire device configuration or some of the configuration can be reset to a defined state with the **Device reset** parameter (→  43).

Navigation

"System" menu → Device management → Device reset

Parameter overview with brief description

Parameter	Description	Selection
Device reset	Reset the device configuration - either entirely or in part - to a defined state.	<ul style="list-style-type: none"> ■ Cancel ■ To delivery settings ■ Restart device ■ Restore S-DAT backup * ■ Create T-DAT backup ■ Restore T-DAT backup *

* Visibility depends on order options or device settings

12.9 Device

The **Device** submenu contains all the parameters that display different information for identifying the device.

Navigation

"System" menu → Information → Device

▶ Device

Device name	→ ⓘ 44
Device tag	→ ⓘ 44
Serial number	→ ⓘ 44
Order code	→ ⓘ 44
Firmware version	→ ⓘ 44
Extended order code 1	→ ⓘ 45
Extended order code 2	→ ⓘ 45
Extended order code 3	→ ⓘ 45
ENP version	→ ⓘ 45
Manufacturer	→ ⓘ 45

Parameter overview with brief description

Parameter	Description	User interface / User entry
Device name	Displays the name of the transmitter. The transmitter name is also provided on the nameplate of the transmitter.	Character string comprising numbers, letters and special characters
Device tag	Enter a unique designation for the measuring point to be able to easily identify it within the plant.	Character string comprising numbers, letters and special characters (32)
Serial number	Displays the serial number of the measuring device. The serial number is also provided on the nameplate of the sensor and of the transmitter. The serial number can also be used to retrieve further device-related information and documentation via the Operations app or the Device Viewer on the Endress+Hauser website.	Character string comprising numbers, letters and special characters
Order code	Displays the device order code. The order code is used for instance to order a replacement or spare device or to verify that the device features specified on the order form match the shipping note.	Character string comprising numbers, letters and special characters
Firmware version	Displays the device firmware version installed.	Character string comprising numbers, letters and special characters

Parameter	Description	User interface / User entry
Extended order code 1	Displays the first, second and/or third part of the extended order code. Due to character length restrictions, the extended order code is split into a maximum of 3 parameters. The extended order code indicates for each feature in the product structure the selected option, thereby uniquely identifying the device model. The extended order code can also be found on the nameplate.	Character string comprising numbers, letters and special characters
Extended order code 2	Displays the first, second and/or third part of the extended order code. Due to character length restrictions, the extended order code is split into a maximum of 3 parameters. The extended order code indicates for each feature in the product structure the selected option, thereby uniquely identifying the device model. The extended order code can also be found on the nameplate.	Character string comprising numbers, letters and special characters
Extended order code 3	Displays the first, second and/or third part of the extended order code. Due to character length restrictions, the extended order code is split into a maximum of 3 parameters. The extended order code indicates for each feature in the product structure the selected option, thereby uniquely identifying the device model. The extended order code can also be found on the nameplate.	Character string comprising numbers, letters and special characters
ENP version	Displays the version of the electronic nameplate (ENP).	Character string comprising numbers, letters and special characters
Manufacturer	Displays the manufacturer.	Character string comprising numbers, letters and special characters

12.10 Firmware history

Release date	Firmware version	Order code for "Firmware version"	Firmware Changes	Documentation type	Documentation
06.2024	04.00.zz	Option 76	<ul style="list-style-type: none"> ▪ New original firmware ▪ Can be operated via FieldCare and DeviceCare 	Operating Instructions	BA02344D/06/EN/01.24-00
09.2015	03.00.zz	Option A	No change in firmware	Operating Instructions	BA00098D/06/EN/14.15
08.2014	03.00.zz	Option A	<ul style="list-style-type: none"> ▪ New original firmware ▪ Can be operated via FieldCare and DeviceCare 	Operating Instructions	BA00098D/06/EN/13.14
08.2012	01.01.zz	–	No change in firmware	Operating Instructions	BA00097D/06/EN/14.12
05.2006	02.02.zz	–	New functionality: <ul style="list-style-type: none"> ▪ Automatic pulse width ▪ On-value and off-value, status output 	Operating Instructions	BA098D/06/EN/05.06

Release date	Firmware version	Order code for "Firmware version"	Firmware Changes	Documentation type	Documentation
07.2005	02.01.zz	–	Additional "Symmetry" option for pulse output.	Operating Instructions	BA098D/06/EN/10.05
12.2003	01.00.zz	–	<ul style="list-style-type: none"> ▪ Original firmware ▪ Can be operated via FieldCare 	Operating Instructions	BA098D/06/EN/04.04

 For the compatibility of the firmware version with the previous version, the installed device description files and operating tools, observe the information about the device in the "Manufacturer's information" document.

-  The manufacturer's information is available:
- In the Download Area of the Endress+Hauser web site: www.endress.com → Downloads
 - Specify the following details:
 - Product root: e.g. D5AB
The product root is the first part of the order code: see the nameplate on the device.
 - Text search: Manufacturer's information
 - Media type: Documentation – Technical Documentation

13 Maintenance

13.1 Maintenance work

No special maintenance work is required.

13.1.1 Cleaning of surfaces not in contact with the medium

1. Recommendation: Use a lint-free cloth that is either dry or slightly dampened using water.
2. Do not use any sharp objects or aggressive cleaning agents that corrode the surfaces (displays, housing, for example) and seals.
3. Do not use high-pressure steam.
4. Observe the degree of protection of the device.

NOTICE

Cleaning agents can damage the surfaces!

Incorrect cleaning agents can damage the surfaces!

- ▶ Do not use cleaning agents with concentrated mineral acids, bases or organic solvents e.g. benzyl alcohol, methylene chloride, xylene, concentrated glycerol cleaners or acetone.

13.1.2 Cleaning of surfaces in contact with the medium

Note the following for cleaning and sterilization in place (CIP/SIP):

- Use only cleaning agents to which the materials in contact with the medium are sufficiently resistant.
- Observe the permitted maximum medium temperature.

13.1.3 Cleaning with pigs

It is essential to take the internal diameters of the measuring tube and process connection into account when cleaning with pigs. All the dimensions and lengths of the measuring instrument are provided in the separate "Technical Information" document.

13.1.4 Replacing seals

The measuring instrument seals (particularly aseptic molded seals) must be replaced periodically.

The interval between changes depends on the frequency of the cleaning cycles, the cleaning temperature and the medium temperature.

Replacement seals (accessory) →  64

13.2 Measuring and test equipment

Endress+Hauser offers a variety of measuring and testing equipment, such as Netilion or device tests.

 Your Endress+Hauser Sales Center can provide detailed information on the services.

List of some of the measuring and testing equipment: →  52

13.3 Endress+Hauser services

Endress+Hauser offers a wide variety of services for maintenance such as recalibration, maintenance service or device tests.



Your Endress+Hauser Sales Center can provide detailed information on the services.

14 Repair

14.1 General information

14.1.1 Repair and conversion concept

The Endress+Hauser repair and conversion concept provides for the following:

- The measuring device cannot be converted.
- If the measuring device is defective, the entire device is replaced.
- It is possible to replace seals.

14.2 Endress+Hauser services

Endress+Hauser offers a wide range of services.

 Your Endress+Hauser Sales Center can provide detailed information on the services.

14.3 Return

The requirements for safe device return can vary depending on the device type and national legislation.

1. Refer to the web page for information:
<https://www.endress.com/support/return-material>
↳ Select the region.
2. If returning the device, pack the device in such a way that it is reliably protected against impact and external influences. The original packaging offers the best protection.

14.4 Disposal

 If required by the Directive 2012/19/EU on waste electrical and electronic equipment (WEEE), the product is marked with the depicted symbol in order to minimize the disposal of WEEE as unsorted municipal waste. Do not dispose of products bearing this marking as unsorted municipal waste. Instead, return them to the manufacturer for disposal under the applicable conditions.

14.4.1 Removing the measuring device

1. Switch off the device.

WARNING

Danger to persons from process conditions!

- ▶ Beware of hazardous process conditions such as pressure in the measuring device, high temperatures or aggressive media.
2. Carry out the mounting and connection steps from the "Mounting the measuring device" and "Connecting the measuring device" sections in reverse order. Observe the safety instructions.

14.4.2 Disposing of the measuring device

WARNING

Danger to personnel and environment from fluids that are hazardous to health.

- ▶ Ensure that the measuring device and all cavities are free of fluid residues that are hazardous to health or the environment, e.g. substances that have permeated into crevices or diffused through plastic.

Observe the following notes during disposal:

- ▶ Observe valid federal/national regulations.
- ▶ Ensure proper separation and reuse of the device components.



15 Accessories

Various accessories, which can be ordered with the device or subsequently from Endress+Hauser, are available for the device. Detailed information on the order code in question is available from your local Endress+Hauser sales center or on the product page of the Endress+Hauser website: www.endress.com.

15.1 Device-specific accessories

Accessory	Description	Order code
Seal set	For regular replacement of the seals on the process connections	DK5G**-***
Wall mounting kit	For all applications with increased safety or load requirements	DK5HM**
Mounting kit	Consists of: <ul style="list-style-type: none"> ▪ 2 process connections ▪ Screws ▪ Seals 	DKH**-****

15.2 Communication-specific accessories

Accessory	Description
FieldCare	FDT-based plant asset management tool from Endress+Hauser. It can configure all smart field units in your system and helps you manage them. By using the status information, it is also a simple but effective way of checking their status and condition.  Operating Instructions BA00027S and BA00059S
DeviceCare	Tool to connect and configure Endress+Hauser field devices.  Innovation brochure IN01047S
Commubox FXA291	Connects Endress+Hauser field devices with a CDI interface (= Endress+Hauser Common Data Interface) and the USB port of a computer or laptop.  Technical Information TI00405C
Adapter connection	Adapter connections for installation on other electrical connections: Adapter FXA291 (order number: 71035809)

15.3 Service-specific accessories

Accessories	Description
Applicator	<p>Software for selecting and sizing Endress+Hauser measuring devices:</p> <ul style="list-style-type: none"> ▪ Choice of measuring devices for industrial requirements ▪ Calculation of all the necessary data for identifying the optimum flowmeter: e.g. nominal diameter, pressure loss, flow velocity and accuracy. ▪ Graphic illustration of the calculation results ▪ Determination of the partial order code, administration, documentation and access to all project-related data and parameters over the entire life cycle of a project. <p>Applicator is available:</p> <ul style="list-style-type: none"> ▪ Via the Internet: https://portal.endress.com/webapp/applicator ▪ As a downloadable DVD for local PC installation.
Commubox FXA291	<p>Connects Endress+Hauser field devices with a CDI interface (= Endress +Hauser Common Data Interface) and the USB port of a computer or laptop.</p> <p> Technical Information TI00405C</p>

16 Technical data

16.1 Application

To ensure that the device remains in proper operating condition for its service life, use the measuring device only for media against which the process-wetted materials are sufficiently resistant.

16.2 Function and system design

Measuring principle Electromagnetic flow measurement on the basis of *Faraday's law of magnetic induction*.

Measuring system Compact version – transmitter and sensor form a mechanical unit in a fully welded housing.

For information on the structure of the measuring instrument →  10

16.3 Input

Measured variable **Direct measured variables**
Volume flow (proportional to induced voltage)

Measuring range Typically $v = 0.01$ to 10 m/s (0.03 to 33 ft/s) with the specified measurement accuracy

Flow characteristic values in SI units

Nominal diameter [mm]	Recommended Flow rate Maximum full scale value [l/s]	Factory settings	
		Pulse value [ml]	Low flow cut off ($v \sim 0.04$ m/s) [ml/s]
4	0.14	0.005	0.5
8	0.5	0.02	2
15K ¹⁾	1.2	0.1	7
15	1.66	0.1	7
25	5	0.2	16

1) Conical version (corresponds to DN 12)



Flow characteristic values in US units

Nominal diameter [in]	Recommended Flow rate Maximum full scale value [gal/s]	Factory settings	
		Pulse value [oz fl]	Low flow cut off ($v \sim 0.13$ ft/s) [oz fl/s]
$\frac{5}{32}$	0.035	0.0002	0.02
$\frac{5}{16}$	0.13	0.001	0.08

Nominal diameter	Recommended Flow rate	Factory settings	
		Pulse value	Low flow cut off (v ~ 0.13 ft/s)
[in]	Maximum full scale value [gal/s]	[oz fl]	[oz fl/s]
½K ¹⁾	0.32	0.004	0.25
½	0.44	0.004	0.25
1	1.33	0.007	0.53

1) Conical version (corresponds to DN 12)

Recommended measuring range

 Flow limit →  59

Operable flow range

Over 1000 : 1

16.4 Output

Output signal

Pulse/frequency/switch output

Function	Can be set to: <ul style="list-style-type: none"> ▪ Pulse Quantity-proportional pulse with pulse width to be configured. ▪ Automatic pulse Quantity-proportional pulse with on/off ratio of 1:1 ▪ Frequency Flow-proportional frequency output with 1:1 on/off ratio ▪ Switch Contact for displaying a status
Version	Option AA: 2 pulse/frequency/switch outputs Passive, high-side
Maximum output values	Option AA: 2 pulse/frequency/switch outputs <ul style="list-style-type: none"> ▪ DC 30 V ▪ 30 mA
Voltage drop	Option AA: 2 pulse/frequency/switch outputs At 25 mA: ≤ DC 3 V
Pulse output	
Pulse width	Configurable: 0.05 to 2 000 ms
Maximum pulse rate	10 000 Impulse/s
Pulse value	Configurable
Assignable measured variables	Volume flow
Frequency output	
Output frequency	Configurable: 0 to 10 000 Hz
Damping	Configurable: 0 to 999.9 s
Pulse/pause ratio	1:1
Assignable measured variables	Volume flow
Switch output	
Switching behavior	Binary, conductive or non-conductive

Number of switching cycles	Unlimited
Assignable functions	<ul style="list-style-type: none"> ▪ Off ▪ On ▪ Diagnostic behavior <ul style="list-style-type: none"> ▪ Alarm ▪ Alarm and warning ▪ Warning ▪ Limit value: <ul style="list-style-type: none"> ▪ Off ▪ Volume flow ▪ Flow velocity ▪ Status <ul style="list-style-type: none"> Low flow cut off

Signal on alarm Depending on the interface, failure information is displayed as follows.

Pulse/frequency/switch output

Pulse output	
Failure mode	Choose from: <ul style="list-style-type: none"> ▪ Actual value ▪ No pulses
Frequency output	
Failure mode	Choose from: <ul style="list-style-type: none"> ▪ Actual value ▪ 0 Hz ▪ Definable value between: 0 to 10 000 Hz
Switch output	
Failure mode	Choose from: <ul style="list-style-type: none"> ▪ Current status ▪ Open ▪ Closed

Low flow cut off The switch points for low flow cut off are user-selectable.

Galvanic isolation Device version: 2 pulse/frequency/switch outputs
 (Order code for "Output, input": option AA)

- Pulse/frequency/switch outputs galvanically isolated from supply potential.
- Pulse/frequency/switch outputs not galvanically isolated from each other.

16.5 Power supply

Terminal assignment →  25

Supply voltage DC 24 V (nominal voltage: DC 18 to 30 V)



- The power unit must be tested to ensure that it meets safety requirements (e.g. PELV/SELV Class II limited energy).
- The equipment is classified as Class III.

Power consumption 4.0 W (no outputs)

Current consumption	Order code for "Output, input"	Maximum Current consumption
	Option AA: 2 pulse/frequency/switch outputs	250 mA

Switch-on current

Option AA: 2 pulse/frequency/switch outputs
 Max. 1.2 A (< 15 ms)

- Power supply failure
- Totalizers stop at the last value measured.
 - Configuration is retained in the device memory.
 - Error messages (incl. total operated hours) are stored.

Electrical connection →  27

Potential equalization →  28

Cable specification →  25

16.6 Performance characteristics

- Reference operating conditions
- Maximum permissible error according to DIN EN 29104
 - Water at +15 to +45 °C (+59 to +113 °F)
 - Medium conductivity: 400 µS/cm ±100 µS/cm
 - Ambient temperature: +22 ±2 °C (+72 ±4 °F)
 - Warm-up period: 30 min
 - Data as indicated in the calibration certificate
 - Measurement error based on accredited calibration rigs according to ISO 17025

Installation

- Inlet run > 10 × DN
- Outlet run > 5 × DN
- Measuring instrument is grounded.
- The measuring instrument is centered in the pipe.

Maximum measurement error **Maximum permissible error under reference operating conditions**
 o.r. = of reading

Volume flow

±0.25 % o.r. in the 1 to 4 m/s (3.3 to 13 ft/s) range

 Fluctuations in the supply voltage do not have any effect within the specified range.

Accuracy of outputs

The outputs have the following base accuracy specifications.

Pulse/frequency output

o.r. = of reading

Temperature accuracy	Max. ±100 ppm/K o.r. (over the entire ambient temperature range)
-----------------------------	--

Long-term accuracy	Max. ±0.05 %/Jahr o.r.
---------------------------	------------------------

Repeatability

DN 25 (500 ml/s), DN 15 (200 ml/s), DN 8 (50 ml/s), DN 4 (10 ml/s); 400 µS/cm

Dosing time _a [s]	Relative standard deviation in relation to the batched volume [%]
1.5 s < t _a < 3 s	0.4
3 s < t _a < 5 s	0.2
5 s < t _a	0.1

DN 15K¹⁾ (200 ml/s); 400 µS/cm

Dosing time _a [s]	Relative standard deviation in relation to the batched volume [%]
1.5 s < t _a < 3 s	0.25
3 s < t _a < 5 s	0.12
5 s < t _a	0.08

1) Conical version (corresponds to DN 12)

Influence of ambient temperature

Pulse/frequency output

Temperature coefficient	No additional effect. Included in accuracy.
--------------------------------	---

16.7 Mounting

Mounting requirements

→  14

16.8 Environment

Ambient temperature range

→  19

Temperature tables

 Observe the interdependencies between the permitted ambient and fluid temperatures when operating the device in hazardous areas.

 For detailed information on the temperature tables, see the separate document entitled "Safety Instructions" (XA) for the device.

Storage temperature

The storage temperature corresponds to the ambient temperature range →  19.

- Protect the measuring instrument against direct sunlight during storage in order to avoid unacceptably high surface temperatures.
- Select a storage location where moisture cannot collect in the measuring instrument as fungus or bacteria infestation can damage the liner.
- If protective caps or protective covers are mounted, only remove them immediately before mounting the measuring instrument.

Degree of protection

Standard: IP67, Type 4X enclosure, suitable for pollution degree 4

Relative humidity The device is suitable for use in outdoor and indoor areas (damp and wet areas) with a relative humidity of up to 95%.

Operating altitude According to EN 61010-1
 ≤ 2 000 m (6 562 ft)

Vibration-resistance and shock-resistance

Vibration sinusoidal, in accordance with IEC 60068-2-6

- 2 to 8.4 Hz, 7.5 mm peak
- 8.4 to 2 000 Hz, 2 g peak

Vibration broad-band random, according to IEC 60068-2-64

- 10 to 200 Hz, 0.01 g²/Hz
- 200 to 2 000 Hz, 0.003 g²/Hz
- Total: 2.70 g rms



Shock half-sine, according to IEC 60068-2-27

6 ms 50 g

Rough handling shocks according to IEC 60068-2-31

Internal cleaning

- CIP cleaning
- SIP cleaning

 Observe the maximum medium temperatures →  58

Electromagnetic compatibility (EMC)

As per IEC/EN 61326

 Details are provided in the Declaration of Conformity.

 This unit is not intended for use in residential environments and cannot guarantee adequate protection of the radio reception in such environments.

 The selection of a sensor with a steel housing is recommended for use in the vicinity of electrical power supply lines with strong currents.

Overvoltage protection

Overvoltage category
 Overvoltage category II, no connection to the mains supply

16.9 Process

Medium temperature range

Measuring instrument
 -20 to +130 °C (-4 to +266 °F)

Cleaning
 Process connections with aseptic molded seal and Tri-Clamp: +150 °C (+302 °F) max.
 60 min for CIP and SIP processes

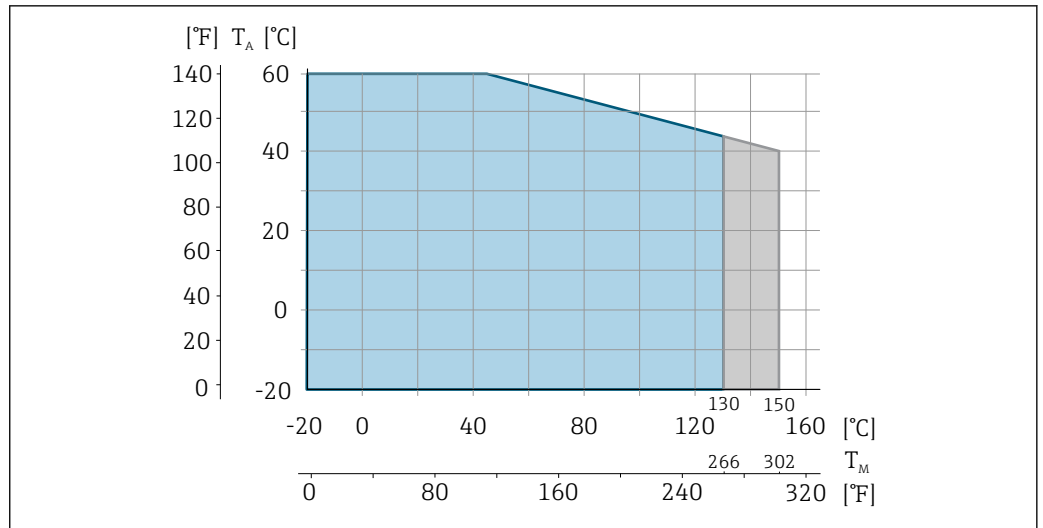

T_A Ambient temperature

T_M Medium temperature

Blue area: Standard medium temperature range

Gray area: Medium temperature range for cleaning (max. 60 min)

A0004805

- Conductivity
- ≥ 5 μS/cm for liquids in general
 - ≥ 10 μS/cm for demineralized water

Pressure-temperature ratings For an overview of the pressure-temperature ratings for the process connections, see the Technical Information

Pressure tightness *Liner: PFA*

Nominal diameter		Limit values for absolute pressure in [mbar] ([psi]) for fluid temperatures:	
[mm]	[in]	+25 °C (+77 °F)	+150 °C (+302 °F)
4 to 25	5/32 to 1	> 1 mbar (0.402 inH ₂ O) (0)	> 1 mbar (0.402 inH ₂ O) (0)

Flow limit

The diameter of the pipe and the flow rate determine the nominal diameter of the measuring instrument. The optimum flow velocity is between 2 to 3 m/s (6.56 to 9.84 ft/s). Also match the flow velocity (v) to the physical properties of the medium:

- v < 2 m/s (6.56 ft/s): for abrasive media (e.g. cleaning agents)
- v > 2 m/s (6.56 ft/s): for media producing buildup (e.g. liquids containing oil and sugar)

A necessary increase in the flow velocity can be achieved by reducing the measuring instrument nominal diameter.

- In the case of media with a high solids content, a measuring instrument with a nominal diameter > DN (8 3/8") can improve the signal stability and cleanability due to the larger electrodes.

- Pressure loss
- For DN 8 (5/16"), DN 15 (1/2") and DN 25 (1"), there is no pressure loss if the measuring device is installed in a pipe with the same nominal diameter.
 - Pressure losses for configurations incorporating adapters according to DIN EN 545
→ 19

System pressure → 19

Vibrations → 19

Magnetism and static electricity

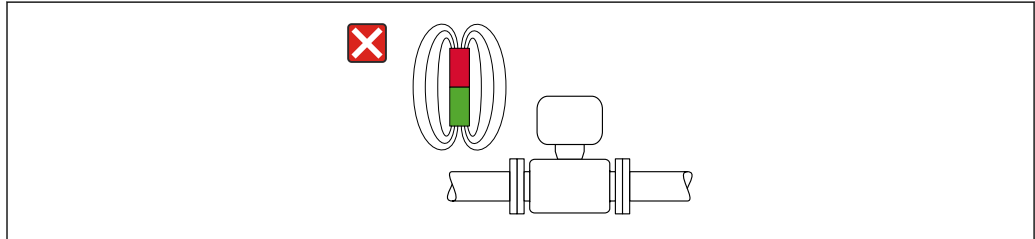

A0042152

7 Avoid magnetic fields

16.10 Mechanical construction

Design, dimensions

For the dimensions and installation lengths of the device, see the "Technical Information" document, "Mechanical construction" section

Weight

Weight in SI units

DN [mm]	Weight [kg]
4	1.8
8	1.8
15K ¹⁾ 15	1.8
25	2.3

1) Conical version (corresponds to DN 12)

Weight in US units

DN [in]	Weight [lbs]
$\frac{5}{32}$	4.0
$\frac{5}{16}$	4.0
$\frac{1}{2}$ K ¹⁾ $\frac{1}{2}$	4.0
1	5.1

1) Conical version (corresponds to DN 12)

Materials

Measuring instrument housing

- Acid and alkali-resistant outer surface
- Stainless steel, 1.4404 (316/316L)

Device plug

Electrical connection	Material
M12x1 plug	<ul style="list-style-type: none"> ▪ Socket: Polyamide contact support ▪ Connector: Contact support made of thermoplastic polyurethane (TPU-GF) ▪ Contacts: Gold-plated brass

Measuring tube

Stainless steel 1.4301 (304)

Liner



PFA (USP Class VI, FDA 21 CFR 177.2600)

Electrodes

- 1.4435 (316L)
- Alloy C22, 2.4602 (UNS N06022)
- Platinum
- Tantalum

Process connections

- Welding nipple:
Stainless steel, 1.4404 (316L)
- Clamp connections:
Stainless steel, 1.4404 (316L)
- Tri-Clamp:
Stainless steel, 1.4404 (316L)
- Glands:
PVDF

 Available process connections →  62

Seals

Molded seal: FFKM (Kalrez), EPDM, FKM, VMQ (silicone)

Accessories

Wall mounting kit

Stainless steel, 1.4404 (316L)

Does not meet the hygienic design installation guidelines.

Fitted electrodes

- Standard: stainless steel 1.4435 (316L)
- Optional: Alloy C22, 2.4602 (UNS N06022), platinum, tantalum

Process connections

With aseptic molded seal

Welding nipple

- EN 10357 (series A)
- ASME BPE (DIN 11866 series C)

Clamp connections

Clamp according to DIN 32676 (series A)

Tri-Clamp

- Tri-Clamp (ASME BPE)
- 3/4" Tri-Clamp L14 AM7
- 1" Tri-Clamp L14 AM7

With O-ring seal

Gland

G1" external thread (EN ISO 228/EN 10226)

 Process connection materials →  61

Surface roughness

Data relate to surfaces in contact with the medium.
 Stainless steel electrodes, 1.4435 (316L); Alloy C22, 2.4602 (UNS N06022), platinum, tantalum:
 ≤ 0.3 to 0.5 µm (11.8 to 19.7 µin)
 Liner with PFA:
 ≤ 0.4 µm (15.7 µin)
 Stainless steel process connections:
 ■ With O-ring seal: Ra ≤ 1.6 µm (63 µin)
 ■ With aseptic molded seal: R_{amax} = 0.76 µm (30 µin)

16.11 Operability

Languages

Can be operated in the following languages:
 Via "FieldCare", "DeviceCare" operating tool: English, German, French, Spanish, Italian, Chinese, Japanese

Local operation

This device cannot be operated locally using a display or operating elements.

Remote operation

→  31

16.12 Certificates and approvals

Current certificates and approvals for the product are available at www.endress.com on the relevant product page:

1. Select the product using the filters and search field.
2. Open the product page.
3. Select **Downloads**.

CE mark

The device meets the legal requirements of the applicable EU Directives. These are listed in the corresponding EU Declaration of Conformity along with the standards applied.
 Endress+Hauser confirms successful testing of the device by affixing to it the CE mark.

UKCA marking

The device meets the legal requirements of the applicable UK regulations (Statutory Instruments). These are listed in the UKCA Declaration of Conformity along with the designated standards. By selecting the order option for UKCA marking, Endress+Hauser confirms a successful evaluation and testing of the device by affixing the UKCA mark.

Contact address Endress+Hauser UK:
 Endress+Hauser Ltd.
 Floats Road
 Manchester M23 9NF
 United Kingdom
www.uk.endress.com

RCM marking	The measuring system meets the EMC requirements of the "Australian Communications and Media Authority (ACMA)".
cULus listed	The device is UL-listed in the product category "Process Control Equipment, Electrical".
Ex-approval	<ul style="list-style-type: none"> ■ Only measuring instruments with the order code for "Approval", option "BT", "FC" and "US" have an Ex approval. ■ The devices are certified for use in hazardous areas and the relevant safety instructions are provided in the separate "Safety Instructions" (XA) document. Reference is made to this document on the nameplate.
Hygienic compatibility	<ul style="list-style-type: none"> ■ 3-A SSI 28-06 or more recent <ul style="list-style-type: none"> ■ Confirmation by affixing the 3-A logo. ■ The 3-A approval refers to the measuring instrument. ■ When installing the measuring instrument, ensure that no liquid can accumulate on the outside of the measuring instrument. ■ EHEDG Type EL Class I <ul style="list-style-type: none"> ■ Confirmation by affixing the EHEDG symbol. ■ EPDM is not a suitable seal material for media with a fat content > 8 %. ■ To meet the requirements for EHEDG certification, the device must be used with process connections in accordance with the EHEDG position paper entitled "Easy cleanable Pipe couplings and Process connections" (www.ehedg.org). ■ Seals: FDA-compliant (except Kalrez seals) ■ Pasteurized Milk Ordinance (PMO)
Pressure Equipment Directive	<ul style="list-style-type: none"> ■ With the marking <ol style="list-style-type: none"> a) PED/G1/x (x = category) or b) PESR/G1/x (x = category) on the sensor nameplate, Endress+Hauser confirms compliance with the "Essential Safety Requirements" <ol style="list-style-type: none"> a) specified in Annex I of the Pressure Equipment Directive 2014/68/EU or b) Schedule 2 of Statutory Instruments 2016 No. 1105. ■ Devices not bearing this marking (without PED or PESR) are designed and manufactured according to sound engineering practice. They meet the requirements of <ol style="list-style-type: none"> a) Art. 4 Para. 3 of the Pressure Equipment Directive 2014/68/EU or b) Part 1, Para. 8 of Statutory Instruments 2016 No. 1105. The scope of application is indicated <ol style="list-style-type: none"> a) in diagrams 6 to 9 in Annex II of the Pressure Equipment Directive 2014/68/EU or b) Schedule 3, Para. 2 of Statutory Instruments 2016 No. 1105.

External standards and guidelines

- EN 60529
Degrees of protection provided by enclosure (IP code)
- EN 61010-1
Safety Requirements for Electrical Equipment for Measurement, Control and Laboratory Use
- GB 30439.5
Safety requirements for industrial automation products - Part 5: Flowmeter safety requirements
- EN 61326-1/-2-3
EMC requirements for electrical equipment for measurement, control and laboratory use
- CAN/CSA C22.2 No. 61010-1-12
Safety Requirements for Electrical Equipment for Measurement, Control and Laboratory Use, Part 1: General Requirements
- ANSI/ISA-61010-1 (82.02.01)
Safety Requirements for Electrical Equipment for Measurement, Control and Laboratory Use – Part 1: General Requirements

16.13 Accessories

 Overview of accessories available to order →  51

16.14 Documentation

-  For an overview of the scope of the associated Technical Documentation, refer to the following:
 - *Device Viewer* (www.endress.com/deviceviewer): Enter the serial number from the nameplate
 - *Endress+Hauser Operations app*: Enter serial number from nameplate or scan matrix code on nameplate.

Standard documentation **Brief Operating Instructions**

Measuring instrument	Documentation code
Dosimag	KA01687D

Description of device parameters

Measuring instrument	Documentation code
Dosimag	GP01217D

Technical Information

Measuring instrument	Documentation code
Dosimag	TI01784D

Supplementary device-
dependent documentation

Safety instructions

Contents	Documentation code
ATEX Ex ec	XA03265D
UL Class I, Division 2	XA03266D
UKEX Ex ec	XA03267D

Installation instructions

Contents	Note
Installation instructions for spare part sets and accessories	<ul style="list-style-type: none"> ▪ Access the overview of all the available spare part sets via <i>Device Viewer</i> ▪ Accessories available for order with Installation Instructions → 📄 51

Index

A

Adapters	19
Adapting the diagnostic behavior	39
Ambient conditions	
Ambient temperature	19
Storage temperature	57
Vibration-resistance and shock-resistance	58
Ambient temperature	
Influence	57
Ambient temperature range	19, 58
Application	53
Resetting the totalizer	37
Totalizer reset	37
Approvals	62

C

CE mark	9, 62
Certificates	62
Check	
Mounting	24
Received goods	11
Checklist	
Post-connection check	30
Post-mounting check	24
CIP cleaning	58
Commissioning	35
Configuring the measuring instrument	35
Conductivity	59
Connecting requirements	25
Connecting the device	
Device plug	27
Connecting the measuring instrument	
Grounding	27
Connection	
see Electrical connection	
Connection cable	25
Current consumption	56

D

Date of manufacture	12
Declaration of Conformity	9
Degree of protection	29, 57
Design	
Measuring instrument	10
Device components	10
Device description files	34
Device locking, status	36
Device name	
Measuring instrument	12
Device Viewer	11
DeviceCare	33
Device description file	34
Diagnostic information	
Design, description	39
DeviceCare	38
FieldCare	38

Overview	40
Remedial measures	40
Diagnostic list	42
Display	
Current diagnostic event	42
Previous diagnostic event	42
Display values	
For locking status	36
Disposal	49
Document	
Function	5
Symbols	5
Document function	5
Documentation	64
Down pipe	14

E

Electrical connection	
Degree of protection	29
Measuring instrument	25
Electromagnetic compatibility	58
Endress+Hauser services	
Maintenance	48
Repair	49
Environmental conditions	
Operating altitude	58
Relative humidity	58
Error messages	
see Diagnostic messages	
Event history	43
Event list	43
Ex-approval	63
Extended order code	
Measuring instrument	12

F

Field of application	
Residual risks	9
FieldCare	32
Device description file	34
Establishing a connection	32
Function	32
User interface	33
Firmware	
Release date	34
Version	34
Firmware history	45
Fitted electrodes	61
Flow direction	16
Flow limit	59
Functions	
see Parameter	

G

Galvanic isolation	55
------------------------------	----

H	
Hygienic compatibility	63
I	
Identifying the measuring instrument	11
Incoming acceptance	11
Influence	
Ambient temperature	57
Information about this document	5
Inlet runs	18
Input	53
Inspection	
Connection	30
Installation	
Mounting	21
Installation conditions	
Partially filled pipe	15
System pressure	19
Installation dimensions	18
Intended use	8
Internal cleaning	58
L	
Languages, operation options	62
Local operation	62
Low flow cut off	55
M	
Magnetism	60
Maintenance work	47
Replacing seals	47
Materials	60
Maximum measurement error	56
Measured variables	
Measured	53
see Process variables	
Measuring and test equipment	47
Measuring device	
Conversion	49
Disposal	50
Removing	49
Repair	49
Switching on	35
Measuring instrument	34
Configuring	35
Design	10
Mounting the measuring instrument	
Cleaning with pigs	47
Mounting grounding rings	23
Mounting the seals	22
Welding nipple	22
Preparing for mounting	22
Measuring principle	53
Measuring range	53
Measuring system	53
Medium temperature range	58
Menus	
For measuring instrument configuration	35
Mounting	14
Mounting dimensions	
see Installation dimensions	
Mounting location	14
Mounting preparations	22
Mounting requirements	
Adapters	19
Down pipe	14
Inlet and outlet runs	18
Installation dimensions	18
Mounting location	14
Orientation	16
Vibrations	19
Mounting tool	21
N	
Nameplate	
Measuring instrument	12
Netilion	47
O	
Operable flow range	54
Operating altitude	58
Operation	36
Operation options	31
Operational safety	9
Order code	12
Orientation	
Filling systems	17
Orientation (vertical, horizontal)	16
Outlet runs	18
Output signal	54
Output variables	54
P	
Packaging disposal	13
Parameter settings	
Active diagnostics (Submenu)	42
Device (Submenu)	44
Device management (Submenu)	36, 43
Measured values (Submenu)	36
Totalizer handling (Submenu)	37
User management (Submenu)	36
Partially filled pipe	15
Performance characteristics	56
Pin assignment, device plug	25
Post-connection check	35
Post-connection check (checklist)	30
Post-mounting check	35
Post-mounting check (checklist)	24
Potential equalization	28
Power consumption	55
Power supply failure	56
Pressure Equipment Directive	63
Pressure loss	59
Pressure tightness	59
Pressure-temperature ratings	59
Process conditions	
Conductivity	59
Flow limit	59

Medium temperature	58	Temperature range	
Pressure loss	59	Storage temperature	13
Pressure tightness	59	Terminal assignment	25
Process connections	61	Tool	
Product safety	9	Mounting	21
R		Transporting	13
RCM marking	63	Transporting the measuring instrument	13
Reading measured values	36	Troubleshooting	
Recalibration	48	General	38
Reference operating conditions	56	U	
Registered trademarks	7	UKCA marking	62
Remote operation	62	Use of measuring device	
Repair	49	Borderline cases	8
Repeatability	57	Incorrect use	8
Replacement		Use of measuring instrument	
Device components	49	see Intended use	
Replacing seals	47	V	
Requirements for personnel	8	Vibration-resistance and shock-resistance	58
Return	49	Vibrations	19
S		W	
Safety	8	Weight	
Serial number	12	SI units	60
Settings		Transport (notes)	13
Adapting the measuring instrument to the process		US units	60
conditions	36	Workplace safety	9
Resetting the device	43		
Signal on alarm	55		
SIP cleaning	58		
Special mounting instructions			
Hygienic compatibility	20		
Standards and guidelines	64		
Static electricity	60		
Status signals	38		
Storage conditions	13		
Storage temperature	13		
Storage temperature range	57		
Submenu			
Active diagnostics	42		
Device	44		
Device management	36, 43		
Event list	43		
Measured values	36		
Totalizer handling	37		
User management	36		
Supply unit			
Requirements	26		
Supply voltage	26, 55		
Surface roughness	62		
System design			
Measuring system	53		
see Measuring instrument design			
System integration	34		
System pressure	19		
T			
Technical data, overview	53		



www.addresses.endress.com
