

Brief Operating Instructions

Proline Promag

Part 1 of 2
Electromagnetic sensor



These are Brief Operating Instructions; they do not replace the Operating Instructions included in the scope of supply.

These Brief Operating Instructions contain all of the information on the sensor. Please also follow the Brief Operating Instructions for the transmitter during commissioning →  3.

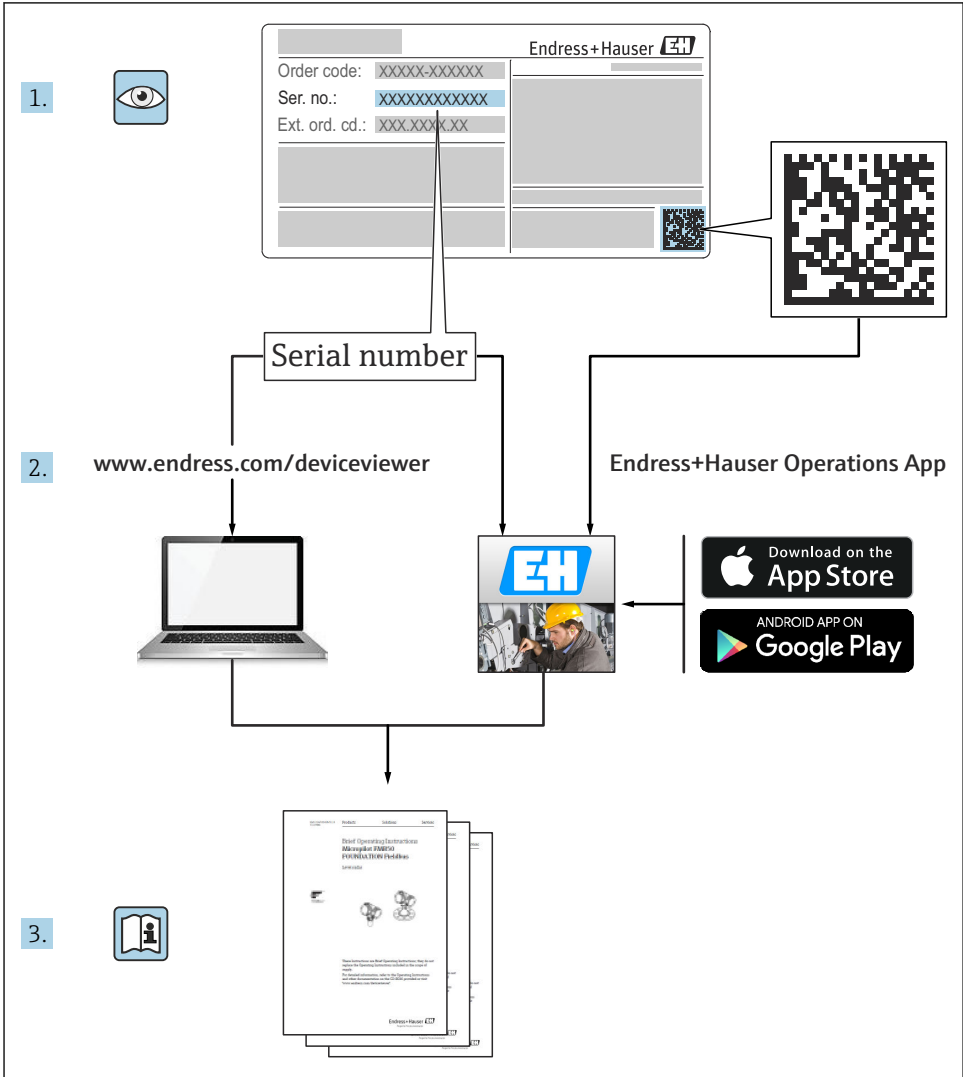

A0023555

Brief Operating Instructions for the device

The device consists of a transmitter and a sensor.

The process of commissioning these two components is described in two separate manuals:

- Sensor Brief Operating Instructions
- Transmitter Brief Operating Instructions

Please refer to both Brief Operating Instructions when commissioning the device as the contents of the manuals complement one another:

Sensor Brief Operating Instructions

The Sensor Brief Operating Instructions are aimed at specialists with responsibility for installing the measuring device.

- Incoming acceptance and product identification
- Storage and transport
- Installation

Transmitter Brief Operating Instructions

The Transmitter Brief Operating Instructions are aimed at specialists with responsibility for commissioning, configuring and parameterizing the measuring device (until the first measured value).

- Product description
- Installation
- Electrical connection
- Operation options
- System integration
- Commissioning
- Diagnostic information

Additional device documentation



These Brief Operating Instructions are the **Sensor Brief Operating Instructions**.

The "Transmitter Brief Operating Instructions" are available via:

- Internet: www.endress.com/deviceviewer
- Smart phone/tablet: *Endress+Hauser Operations App*

Detailed information about the device can be found in the Operating Instructions and the other documentation:

- Internet: www.endress.com/deviceviewer
- Smart phone/tablet: *Endress+Hauser Operations App*





Table of contents

1	Document information	5
1.1	Symbols used	5
2	Basic safety instructions	7
2.1	Requirements for the personnel	7
2.2	Designated use	7
2.3	Workplace safety	8
2.4	Operational safety	8
2.5	Product safety	8
2.6	IT security	9
3	Incoming acceptance and product identification	9
3.1	Incoming acceptance	9
3.2	Product identification	10
4	Storage and transport	11
4.1	Storage conditions	11
4.2	Transporting the product	11
5	Installation	13
5.1	Installation conditions	13
5.2	Mounting the measuring device	20
5.3	Post-installation check	32
6	Disposal	32
6.1	Removing the measuring device	32
6.2	Disposing of the measuring device	32
7	Appendix	33
7.1	Screw tightening torques	33











1 Document information

1.1 Symbols used





1.1.1 Safety symbols



Symbol	Meaning
	DANGER! This symbol alerts you to a dangerous situation. Failure to avoid this situation will result in serious or fatal injury.
	WARNING! This symbol alerts you to a dangerous situation. Failure to avoid this situation can result in serious or fatal injury.
	CAUTION! This symbol alerts you to a dangerous situation. Failure to avoid this situation can result in minor or medium injury.
	NOTE! This symbol contains information on procedures and other facts which do not result in personal injury.

1.1.2 Symbols for certain types of information





Symbol	Meaning	Symbol	Meaning
	Permitted Procedures, processes or actions that are permitted.		Preferred Procedures, processes or actions that are preferred.
	Forbidden Procedures, processes or actions that are forbidden.		Tip Indicates additional information.
	Reference to documentation		Reference to page
	Reference to graphic		Series of steps
	Result of a step		Visual inspection

1.1.3 Electrical symbols





Symbol	Meaning	Symbol	Meaning
	Direct current		Alternating current
	Direct current and alternating current		Ground connection A grounded terminal which, as far as the operator is concerned, is grounded via a grounding system.

Symbol	Meaning
	Protective ground connection A terminal which must be connected to ground prior to establishing any other connections.
	Equipotential connection A connection that has to be connected to the plant grounding system: This may be a potential equalization line or a star grounding system depending on national or company codes of practice.





1.1.4 Communication symbols

Symbol	Meaning	Symbol	Meaning
	Wireless Local Area Network (WLAN) Communication via a wireless, local network.		Bluetooth Wireless data transmission between devices over a short distance.
	LED Light emitting diode is off.		LED Light emitting diode is on.
	LED Light emitting diode is flashing.		

1.1.5 Tool symbols

Symbol	Meaning	Symbol	Meaning
	Torx screwdriver		Flat blade screwdriver
	Cross-head screwdriver		Allen key
	Open-ended wrench		

1.1.6 Symbols in graphics

Symbol	Meaning	Symbol	Meaning
1, 2, 3,...	Item numbers		Series of steps
A, B, C, ...	Views	A-A, B-B, C-C, ...	Sections
	Hazardous area		Safe area (non-hazardous area)
	Flow direction		

2 Basic safety instructions

2.1 Requirements for the personnel

The personnel must fulfill the following requirements for its tasks:

- ▶ Trained, qualified specialists must have a relevant qualification for this specific function and task.
- ▶ Are authorized by the plant owner/operator.
- ▶ Are familiar with federal/national regulations.
- ▶ Before starting work, read and understand the instructions in the manual and supplementary documentation as well as the certificates (depending on the application).
- ▶ Follow instructions and comply with basic conditions.

2.2 Designated use

Application and media

The measuring device is only suitable for flow measurement of liquids with a minimum conductivity of 5 $\mu\text{S}/\text{cm}$.

Depending on the version ordered, the measuring device can also measure potentially explosive, flammable, poisonous and oxidizing media.

Measuring devices for use in hazardous areas, in hygienic applications or where there is an increased risk due to process pressure, are labeled accordingly on the nameplate.

To ensure that the measuring device remains in proper condition for the operation time:

- ▶ Only use the measuring device in full compliance with the data on the nameplate and the general conditions listed in the Operating Instructions and supplementary documentation.
- ▶ Based on the nameplate, check whether the ordered device is permitted for the intended use in the hazardous area (e.g. explosion protection, pressure vessel safety).
- ▶ Use the measuring device only for media to which the process-wetted materials are sufficiently resistant.
- ▶ If the measuring device is not operated at atmospheric temperature, compliance with the relevant basic conditions specified in the associated device documentation is absolutely essential: "Documentation" section..
- ▶ Protect the measuring device permanently against corrosion from environmental influences.

Incorrect use

Non-designated use can compromise safety. The manufacturer is not liable for damage caused by improper or non-designated use.

WARNING

Danger of breakage due to corrosive or abrasive fluids!

- ▶ Verify the compatibility of the process fluid with the sensor material.
- ▶ Ensure the resistance of all fluid-wetted materials in the process.
- ▶ Keep within the specified pressure and temperature range.

NOTICE**Verification for borderline cases:**

- ▶ For special fluids and fluids for cleaning, Endress+Hauser is glad to provide assistance in verifying the corrosion resistance of fluid-wetted materials, but does not accept any warranty or liability as minute changes in the temperature, concentration or level of contamination in the process can alter the corrosion resistance properties.

Residual risks**⚠ WARNING****The electronics and the medium may cause the surfaces to heat up. This presents a burn hazard!**

- ▶ For elevated fluid temperatures, ensure protection against contact to prevent burns.

2.3 Workplace safety

For work on and with the device:

- ▶ Wear the required personal protective equipment according to federal/national regulations.

For welding work on the piping:

- ▶ Do not ground the welding unit via the measuring device.

If working on and with the device with wet hands:

- ▶ Due to the increased risk of electric shock, gloves must be worn.

2.4 Operational safety

Risk of injury!

- ▶ Operate the device in proper technical condition and fail-safe condition only.
- ▶ The operator is responsible for interference-free operation of the device.

Environmental requirements

If a plastic transmitter housing is permanently exposed to certain steam and air mixtures, this can damage the housing.

- ▶ If you are unsure, please contact your Endress+Hauser Sales Center for clarification.
- ▶ If used in an approval-related area, observe the information on the nameplate.

2.5 Product safety

This measuring device is designed in accordance with good engineering practice to meet state-of-the-art safety requirements, has been tested, and left the factory in a condition in which it is safe to operate.

It meets general safety standards and legal requirements. It also complies with the EU directives listed in the device-specific EU Declaration of Conformity. Endress+Hauser confirms this by affixing the CE mark to the device.

2.6 IT security

We only provide a warranty if the device is installed and used as described in the Operating Instructions. The device is equipped with security mechanisms to protect it against any inadvertent changes to the device settings.

IT security measures in line with operators' security standards and designed to provide additional protection for the device and device data transfer must be implemented by the operators themselves.

3 Incoming acceptance and product identification

3.1 Incoming acceptance



A0028673



1
2



1
2

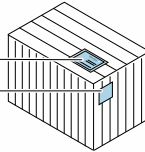

Are the order codes on the delivery note (1) and the product sticker (2) identical?

A0029314

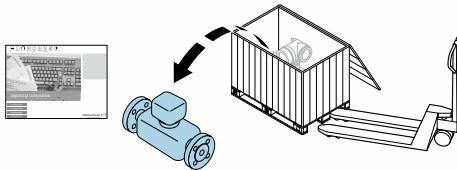

A0029315



A0028673

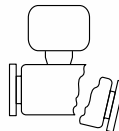
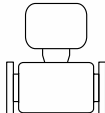

Are the goods undamaged?

A0029316



A0028673

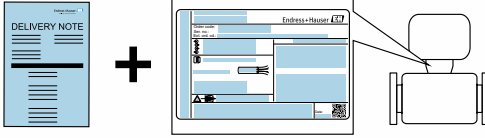

Do the nameplate data match the ordering information on the delivery note?

A0029317



A0028673



Is the CD-ROM with the Technical Documentation (depends on device version) and documents present?

A0029318

- 
i
 ■ If one of the conditions is not satisfied, contact your Endress+Hauser Sales Center.
- Depending on the device version, the CD-ROM might not be part of the delivery! The Technical Documentation is available via the Internet or via the *Endress+Hauser Operations App*.

3.2 Product identification

The following options are available for identification of the measuring device:

- Nameplate specifications
- Order code with breakdown of the device features on the delivery note
- Enter serial numbers from nameplates in *W@M Device Viewer* (www.endress.com/deviceviewer): All information about the measuring device is displayed.
- Enter the serial number from the nameplates into the *Endress+Hauser Operations App* or scan the 2-D matrix code (QR code) on the nameplate with the *Endress+Hauser Operations App*: all the information for the measuring device is displayed.

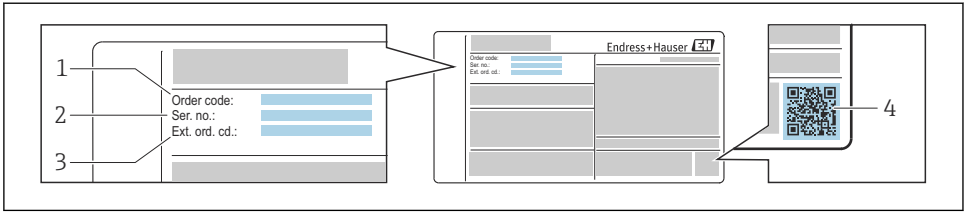

A0030196

1 Example of a nameplate

- 1 Order code
- 2 Serial number (Ser. no.)
- 3 Extended order code (Ext. ord. cd.)
- 4 2-D matrix code (QR code)



For detailed information on the breakdown of the specifications on the nameplate, see the Operating Instructions for the device .

4 Storage and transport

4.1 Storage conditions

Observe the following notes for storage:

- ▶ Store in the original packaging to ensure protection from shock.
- ▶ Do not remove protective covers or protective caps installed on process connections. They prevent mechanical damage to the sealing surfaces and contamination in the measuring tube.
- ▶ Protect from direct sunlight to avoid unacceptably high surface temperatures.
- ▶ Select a storage location where moisture cannot collect in the measuring device as fungus and bacteria infestation can damage the lining.
- ▶ Store in a dry and dust-free place.
- ▶ Do not store outdoors.

4.2 Transporting the product

Transport the measuring device to the measuring point in the original packaging.

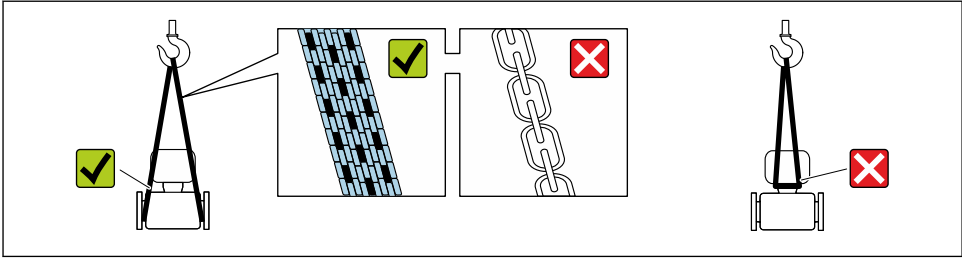

A0029252

i Do not remove protective covers or caps installed on process connections. They prevent mechanical damage to the sealing surfaces and contamination in the measuring tube.

4.2.1 Measuring devices without lifting lugs

⚠ WARNING

Center of gravity of the measuring device is higher than the suspension points of the webbing slings.

Risk of injury if the measuring device slips.

- ▶ Secure the measuring device against slipping or turning.
- ▶ Observe the weight specified on the packaging (stick-on label).

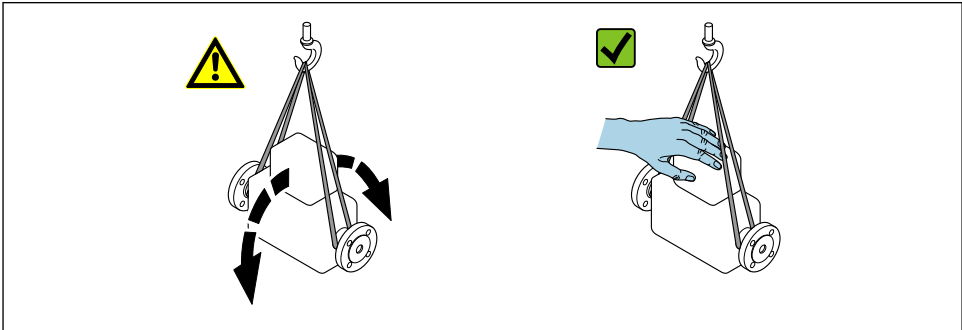

A0029214

4.2.2 Measuring devices with lifting lugs

⚠ CAUTION

Special transportation instructions for devices with lifting lugs

- ▶ Only use the lifting lugs fitted on the device or flanges to transport the device.
- ▶ The device must always be secured at two lifting lugs at least.

4.2.3 Transporting with a fork lift

If transporting in wood crates, the floor structure enables the crates to be lifted lengthwise or at both sides using a forklift.

⚠ CAUTION**Risk of damaging the magnetic coil**

- ▶ If transporting by forklift, do not lift the sensor by the metal casing.
- ▶ This would buckle the casing and damage the internal magnetic coils.

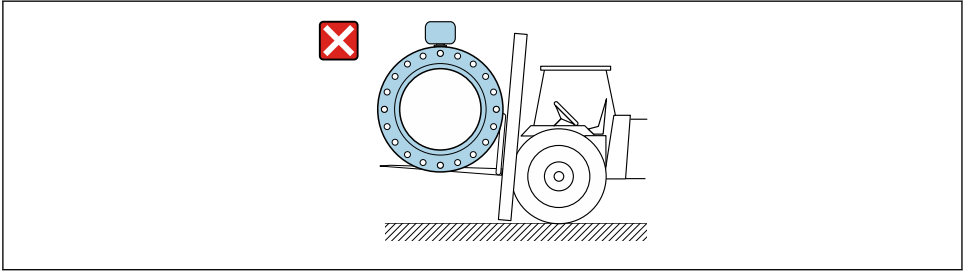

A0029319

5 Installation

5.1 Installation conditions

5.1.1 Mounting position

Mounting location

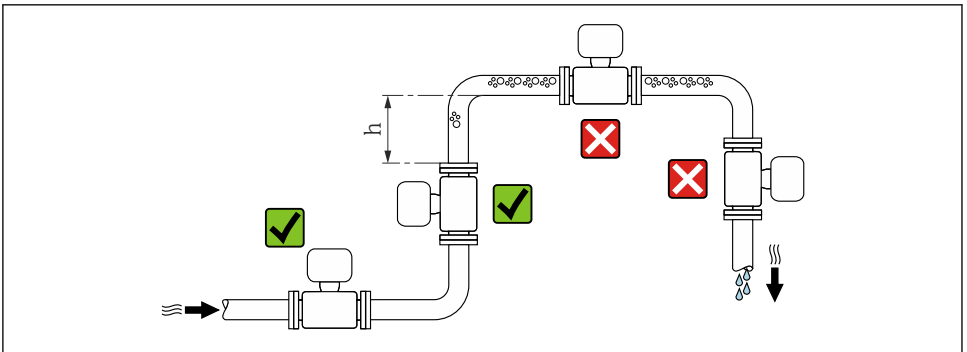

A0029343

$$h \geq 2 \times DN$$

Installation in down pipes

Install a siphon with a vent valve downstream of the sensor in down pipes whose length $h \geq 5 \text{ m}$ (16.4 ft). This precaution is to avoid low pressure and the consequent risk of damage to the measuring tube. This measure also prevents the system losing prime.

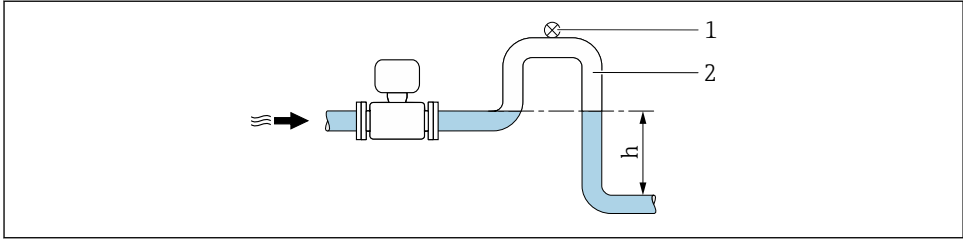

A0028981

2 Installation in a down pipe

1 Vent valve

2 Pipe siphon

h Length of down pipe

Installation in partially filled pipes

A partially filled pipe with a gradient necessitates a drain-type configuration.

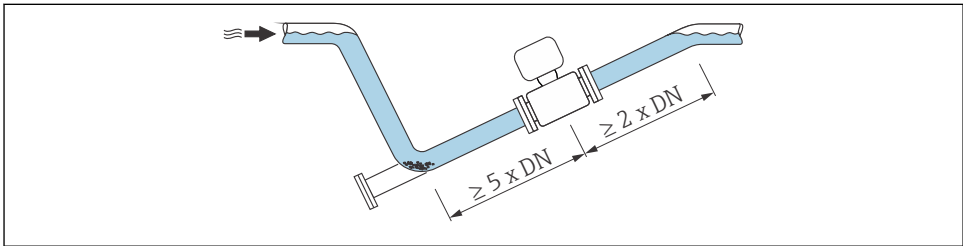

A0029257

Orientation

The direction of the arrow on the sensor nameplate helps you to install the sensor according to the flow direction.

An optimum orientation position helps avoid gas and air accumulations and deposits in the measuring tube.

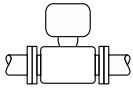
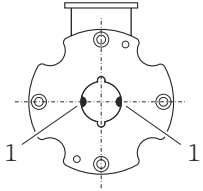
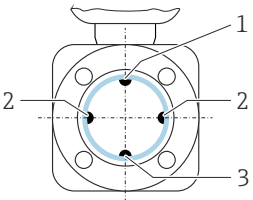
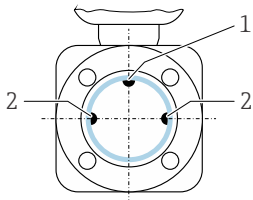
Horizontal orientation (transmitter at top)			
	 <p style="text-align: right;">A0015589</p> <p style="text-align: right;">A0017195</p>		
<p>3</p> <p>Promag D</p> <p><i>1 Measuring electrodes for signal detection</i></p>			
 <p style="text-align: right;">A0029344</p>	 <p style="text-align: right;">A0028998</p>		
<p>4</p> <p>Promag E, L, P, W</p> <p><i>1 EPD electrode for empty pipe detection</i> <i>2 Measuring electrodes for signal detection</i> <i>3 Reference electrode for potential equalization</i></p>		<p>5</p> <p>Promag H</p> <p><i>1 EPD electrode for empty pipe detection</i> <i>2 Measuring electrodes for signal detection</i></p>	
<p>The measuring electrode plane must be horizontal. This prevents brief insulation of the two measuring electrodes by entrained air bubbles. Empty pipe detection (Promag E, H, L, P, W) only works if the transmitter housing is pointing upwards as otherwise there is no guarantee that the empty pipe detection function will actually respond to a partially filled or empty measuring tube.</p>			

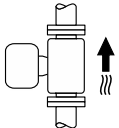
Vertical orientation
 <p style="text-align: right;">A0015591</p>
<p>Optimum for self-emptying pipe systems. Optimum if using empty pipe detection (Promag E, H, L, P, W).</p>

Inlet and outlet runs

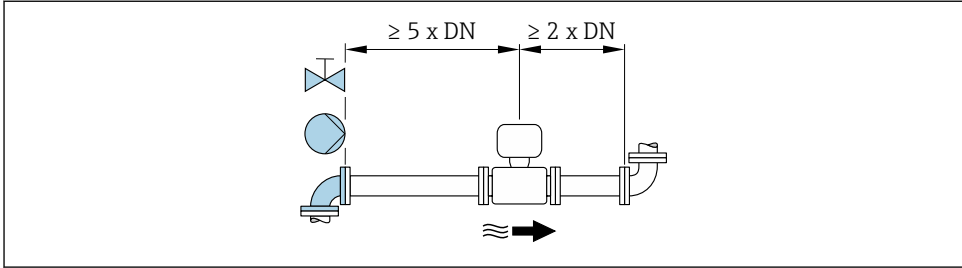

A0028997

Promag W 400

To keep within the in-service maximum permissible errors for custody transfer no additional requirements apply with regard to the graphic illustrated above.

 For the dimensions and installation lengths of the device, see the "Technical Information" document, "Mechanical construction" section

5.1.2 Requirements from environment and process

Ambient temperature range

 For detailed information on the ambient temperature range, see the Operating Instructions for the device.

If operating outdoors:

- Install the measuring device in a shady location.
- Avoid direct sunlight, particularly in warm climatic regions.
- Avoid direct exposure to weather conditions.

Temperature tables

 For detailed information on the temperature tables, see the separate document entitled "Safety Instructions" (XA) for the device.

System pressure

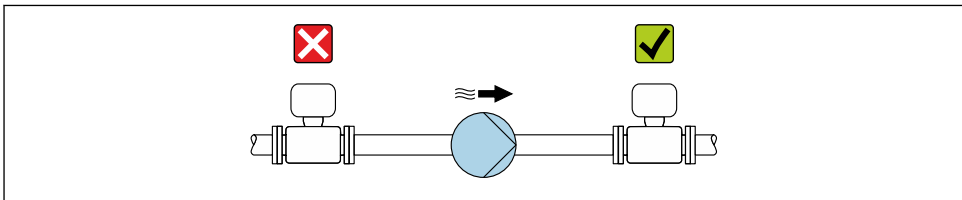

A0028777

 Furthermore, install pulse dampers if reciprocating, diaphragm or peristaltic pumps are used.

Thermal insulation Promag P 300/500

Pipes generally have to be insulated if they carry very hot fluids to avoid energy losses and prevent accidental contact with pipes at temperatures that could cause injury. Guidelines regulating the insulation of pipes have to be taken into account.

⚠ WARNING

Electronics overheating on account of thermal insulation!

- ▶ The housing support dissipates heat and its entire surface area must remain uncovered. Make sure that the sensor insulation does not extend past the top of the two sensor half-shells.

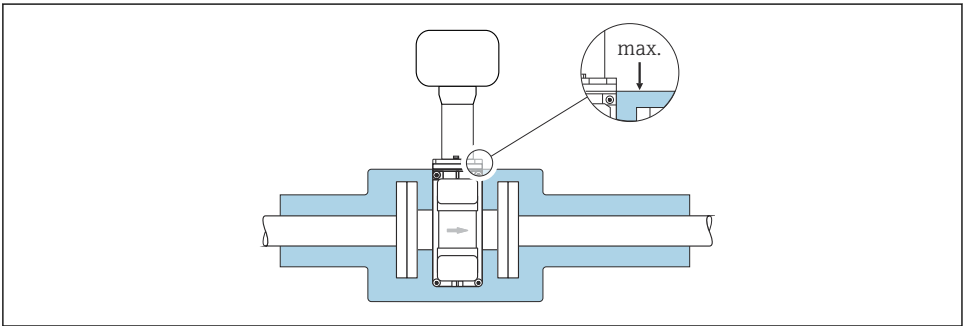

A0031216

Vibrations

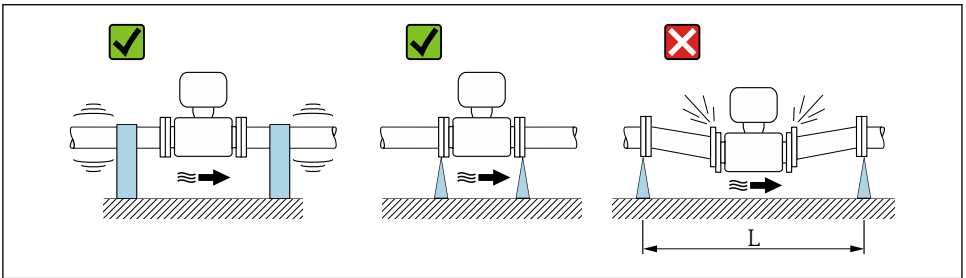

A0029004

6 Measures to avoid device vibrations ($L > 10\text{ m}$ (33 ft))

Adapters

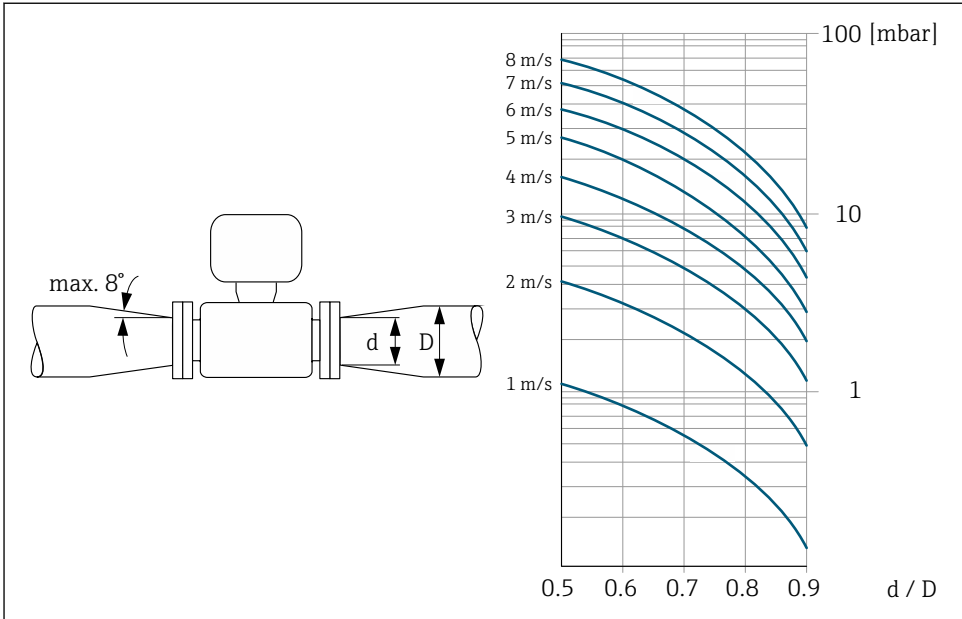

A0029002

5.1.3 Special mounting instructions

Promag 200, 400

Display protection

- To ensure that the optional display guard can be easily opened, maintain the following minimum head clearance: 350 mm (13.8 in)

Promag L 400

Temporary immersion in water

A remote version with IP67 protection, Type 6 is optionally available for temporary immersion in water for up to 168 hours at ≤ 3 m (10 ft) or in exceptional cases for use for up to 48 hours at ≤ 10 m (30 ft).

Compared with the standard degree of protection IP67, Type 4X enclosure, the version IP67, Type 6 enclosure has been designed to withstand short-term or temporary flooding.

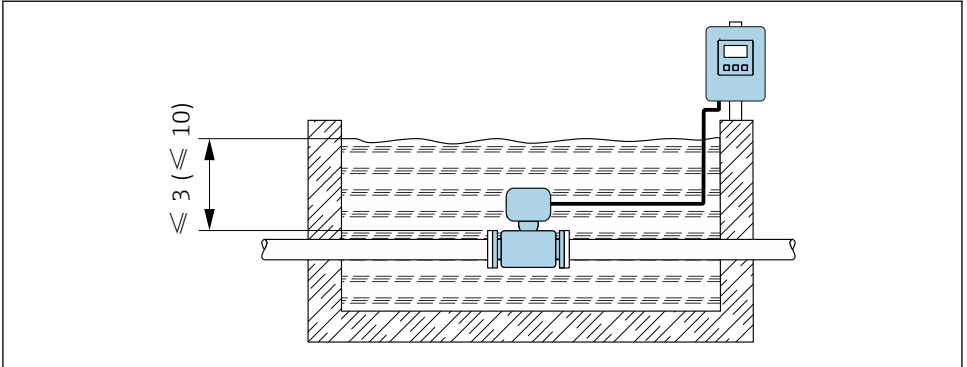

A0029320

7 Engineering unit in m(ft)



For detailed information on replacing the cable gland on the connection housing, see the Transmitter Brief Operating Instructions.

Promag W 400, W 500

Permanent immersion in water

A fully welded remote version with IP68 protection is optionally available for permanent immersion in water ≤ 3 m (10 ft) or in exceptional cases for use for up to 48 hours at ≤ 10 m (30 ft). The measuring device meets the requirements of corrosion categories C5-M and Im1/Im2/Im3. The fully welded design along with the connection compartment sealing system ensure that moisture cannot enter the measuring device.

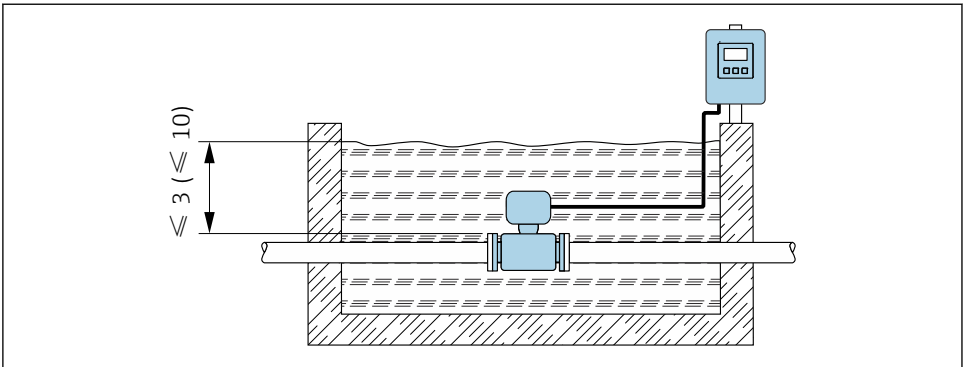

A0029320

8 Engineering unit in m(ft)



For detailed information on replacing the cable gland on the connection housing, see the Transmitter Brief Operating Instructions.

Buried applications

A remote version with IP68 protection is optionally available for buried applications. The measuring device meets the requirements of certified corrosion protection Im1/Im2/Im3 according to EN ISO 12944. It can be used directly in buried applications without having to take any additional precautions for the measuring device. The device is mounted in accordance with the usual regional installation regulations (e.g. EN DIN 1610).

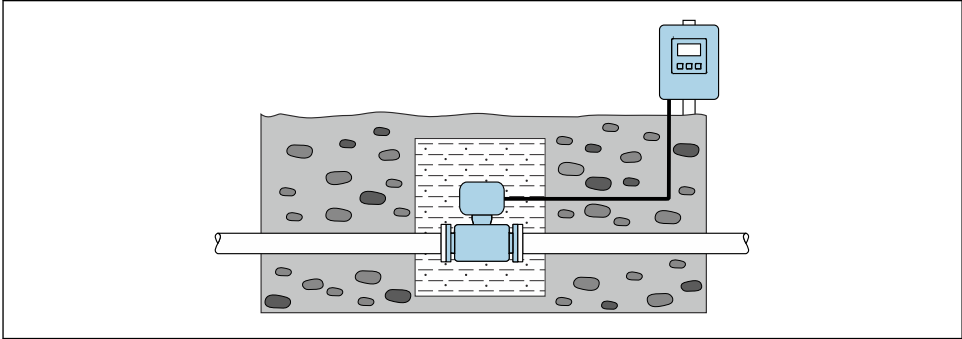

A0029321

5.2 Mounting the measuring device

5.2.1 Required tools

For transmitter

- For turning the transmitter housing: Open-ended wrench 8 mm
- For opening the securing clamps: Allen key 3 mm
- For turning the transmitter housing: Open-ended wrench 8 mm
- For opening the securing clamps: Allen key 3 mm
- Torque wrench
- For wall mounting:
 - Open-ended wrench for hexagonal screw max. M5
- For pipe mounting:
 - Open-ended wrench AF 8
 - Phillips head screwdriver PH 2
- For turning the transmitter housing (compact version):
 - Phillips head screwdriver PH 2
 - Torx screwdriver TX 20
 - Open-ended wrench AF 7

For mounting on a post:

For wall mounting:

Drill with drill bit \varnothing 6.0 mm

For sensor

For flanges and other process connections:

- Screws, nuts, seals etc. are not included in the scope of supply and must be provided by the customer.
- Appropriate mounting tools

5.2.2 Preparing the measuring device

1. Remove all remaining transport packaging.
2. Remove any protective covers or protective caps present from the sensor.
3. Remove stick-on label on the electronics compartment cover.

5.2.3 Mounting the sensor

WARNING

An electrically conductive layer could form on the inside of the measuring tube!

Risk of measuring signal short circuit.

- ▶ Ensure that the inside diameters of the gaskets are greater than or equal to that of the process connections and piping.
- ▶ Ensure that the gaskets are clean and undamaged.
- ▶ Install the gaskets correctly.
- ▶ Do not use electrically conductive sealing compounds such as graphite.

WARNING

Danger due to improper process sealing!

- ▶ Ensure that the inside diameters of the gaskets are greater than or equal to that of the process connections and piping.
- ▶ Ensure that the gaskets are clean and undamaged.
- ▶ Install the gaskets correctly.

1. Ensure that the direction of the arrow on the sensor matches the flow direction of the medium.
2. To ensure compliance with device specifications, install the measuring device between the pipe flanges in a way that it is centered in the measurement section.
3. If using ground disks, comply with the Installation Instructions provided.
4. Observe required screw tightening torques.

5. Install the measuring device or turn the transmitter housing so that the cable entries do not point upwards.

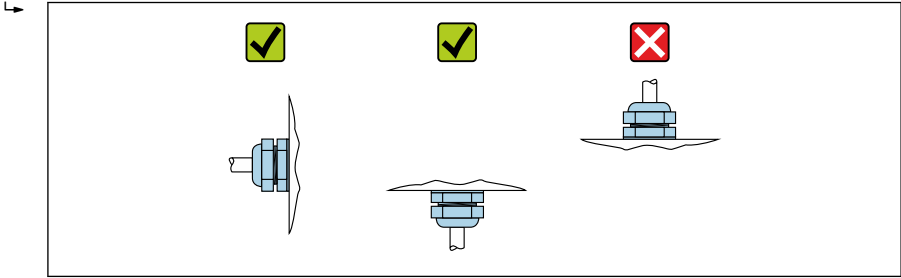

A0029263

Promag D

Seals

Comply with the following instructions when installing seals:

- Use seals with a hardness rating of 70° Shore.
- For DIN flanges: only use seals according to DIN EN 1514-1.

Mounting the ground cable

For information on potential equalization and detailed mounting instructions for the use of ground cables, see the Transmitter Brief Operating Instructions.

Mounting kit

The sensor is installed between the pipe flanges using a mounting kit. The device is centered using the recesses on the sensor. Centering sleeves are also provided depending on the flange standard or the diameter of the pitch circle.



A mounting kit – consisting of mounting bolts, seals, nuts and washers – can be ordered separately (see "Accessories" section).

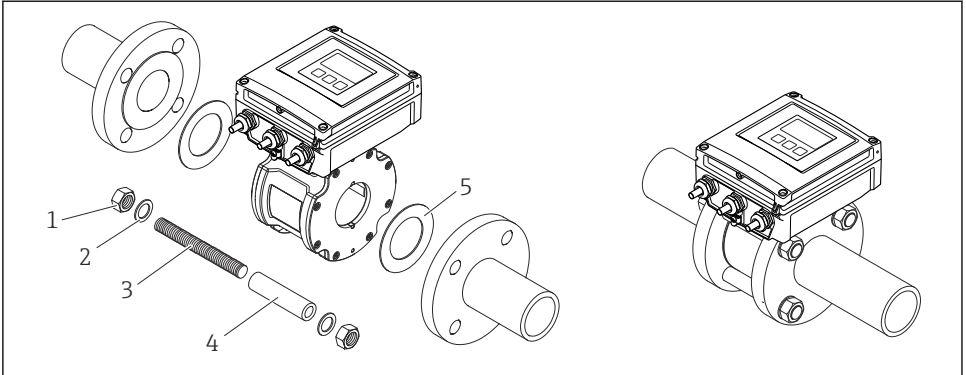

A0018060

9 *Mounting the sensor*

- 1 Nut
- 2 Washer
- 3 Mounting bolts
- 4 Centering sleeve
- 5 Seal

Arranging the mounting bolts and centering sleeves

The device is centered using recesses on the sensor. The arrangement of the mounting bolts and the use of the centering sleeves supplied depend on the nominal diameter, the flange standard and the diameter of the pitch circle.

Nominal diameter		Process connection		
[mm]	[in]	EN 1092-1 (DIN 2501)	ASME B16.5	JIS B2220
25...40	1...1 1/2	<p>A0029490</p>	<p>A0029491</p>	<p>A0029490</p>
50	2	<p>A0029492</p>	<p>A0029493</p>	<p>A0029493</p>

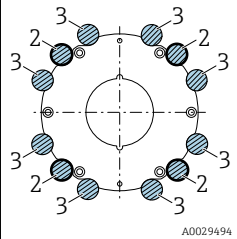
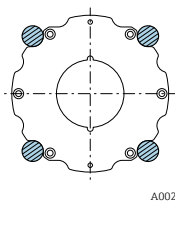
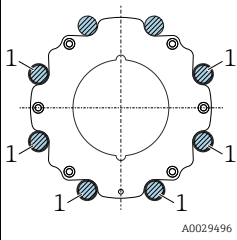
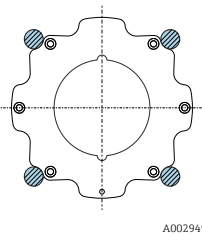
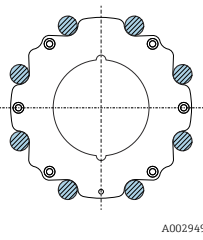
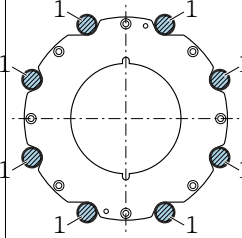
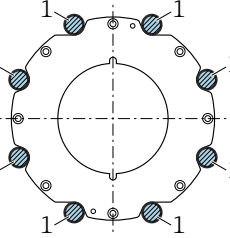
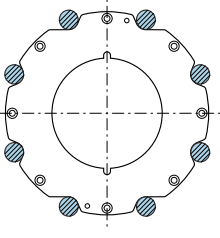
Nominal diameter		Process connection		
[mm]	[in]5	EN 1092-1 (DIN 2501)	ASME B16.5	JIS B2220
65	2 ½	 A0029494	-	 A0029495
80	3	 A0029496	 A0029497	 A0029498
100	4	 A0029499	 A0029499	 A0029500
1 = Mounting bolts with centering sleeves 2 = EN (DIN) flange: 4-hole → with centering sleeves 3 = EN (DIN) flange: 8-hole → without centering sleeves				

Screw tightening torques

→ 📖 33

Promag E, L, P, W

Seals

Comply with the following instructions when installing seals:

	E	L	P	W
For DIN flanges: only use seals according to DIN EN 1514-1.	✓	✓	✓	✓
For "PTFE" lining: generally additional seals are not required.	✓	✓	✓	✗
For "hard rubber" lining: additional seals are always required.	✗	✓	✗	✓

	E	L	P	W
For "polyurethane" lining: generally additional seals are not required.	✘	✔	✘	✔
For "PFA" lining: generally additional seals are not required.	✘	✘	✔	✘

Mounting the ground cable/ground disks

For information on potential equalization and detailed mounting instructions for the use of ground cables/ground disks, see the Transmitter Brief Operating Instructions.

Screw tightening torques

→  33

Promag H

Process connections

The sensor is supplied to order, with or without pre-installed process connections. Pre-installed process connections are firmly secured to the sensor by 4 or 6 hexagonal-headed bolts.



The sensor may need to be supported or additionally secured depending on the application and pipe length. In particular, it is absolutely essential to secure the sensor additionally if plastic process connections are used. An appropriate wall mounting kit can be ordered separately as an accessory from Endress+Hauser.

Seals

- In the case of metal process connections, the screws must be tightened securely. The process connection forms a metal connection with the sensor, which ensures a defined compression of the seal.
- In the case of plastic process connections, observe the maximum torques for lubricated threads: 7 Nm (5.2 lbf ft); always insert a seal between the connection and the counterflange.
- Depending on the application the seals should be replaced periodically, particularly if molded seals are used (aseptic version)! The interval between changes depends on the frequency of the cleaning cycles, the cleaning temperature and the medium temperature. Replacement seals can be ordered as an accessory.
- For "PFA" lining: additional seals are **always** required (Promag 200).

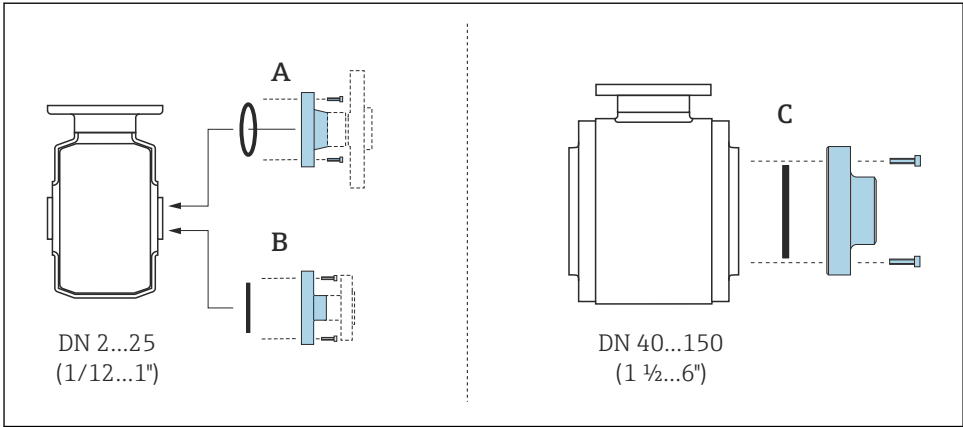

A0019804

10 Seals of process connections, Promag H 100

- A Process connections with O-ring seal
- B Process connections with aseptic molded seal, DN 2 to 25 (1/12 to 1")
- C Process connections with aseptic molded seal, DN 40 to 150 (1 1/2 to 6")

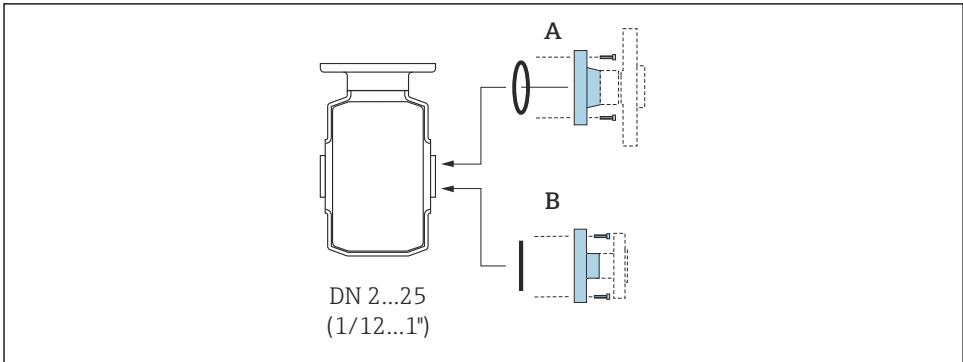

A0018782

11 Seals of process connections, Promag H 200

- A Process connections with O-ring seal
- B Process connections with aseptic gasket seal

Mounting grounding rings, DN 2 to 25 (1/12 to 1")

i For information on potential equalization, see the Transmitter Brief Operating Instructions.

In the case of plastic process connections (e.g. flange connections or adhesive fittings), additional ground rings must be used to ensure potential matching between the sensor and the fluid. If grounding rings are not installed, this can affect the measuring accuracy or cause

the destruction of the sensor as a result of the electrochemical decomposition of the electrodes.



- Depending on the option ordered, plastic disks are used instead of grounding rings on some process connections. These plastic disks only act as "spacers" and do not have any potential matching function. Furthermore, they also perform a significant sealing function at the sensor/process connection interface. Therefore, in the case of process connections without metal grounding rings, these plastic disks/seals should never be removed and should always be installed!
- Grounding rings can be ordered separately as an accessory from Endress+Hauser . When ordering make sure that the grounding rings are compatible with the material used for the electrodes, as otherwise there is the danger that the electrodes could be destroyed by electrochemical corrosion!
- Grounding rings, including seals, are mounted inside the process connections. Therefore the installation length is not affected.

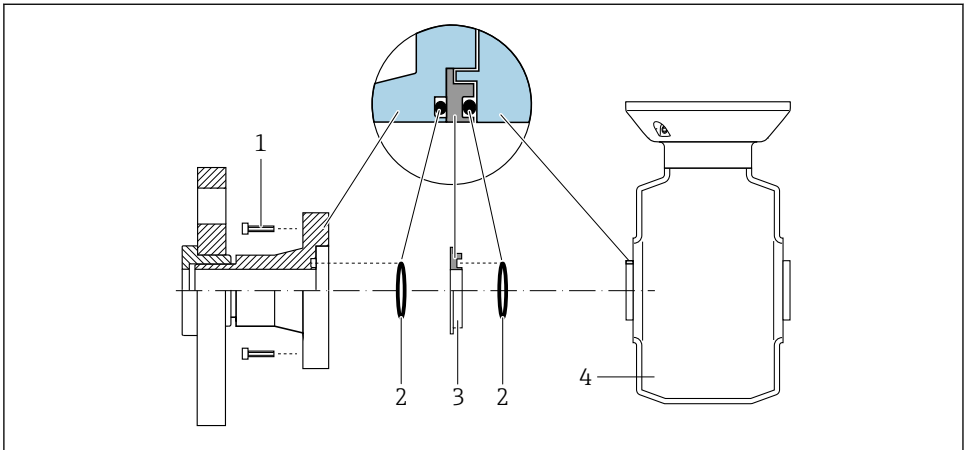

A0028971

12 *Installing grounding rings*

- 1 *Hexagonal-headed bolts of process connection*
- 2 *O-ring seals*
- 3 *Grounding ring or plastic disk (spacer)*
- 4 *Sensor*

1. Release the 4 or 6 hexagonal-headed bolts (1) and remove the process connection from the sensor (4).
2. Remove the plastic disk (3), along with the two O-ring seals (2), from the process connection.
3. Place the first O-ring seal (2) back into the groove of the process connection.
4. Fit the metal grounding ring (3) in the process connection as illustrated.
5. Place the second O-ring seal (2) into the groove of the grounding ring.

6. Mount the process connection back on the sensor. When doing so, make sure to observe the maximum screw tightening torques for lubricated threads: 7 Nm (5.2 lbf ft)

Welding the sensor into the pipe (welding connections)

⚠ WARNING

Risk of destroying the electronics!

- ▶ Make sure that the welding system is not grounded via the sensor or transmitter.

1. Tack-weld the sensor to secure it in the pipe. A suitable welding aid can be ordered separately as an accessory.
2. Release the screws on the process connection flange and remove the sensor, along with the seal, from the pipe.
3. Weld the process connection into the pipe.
4. Reinstall the sensor in the pipe, and in doing so make sure that the seal is clean and in the right position.



- If thin-walled pipes carrying food are welded correctly, the seal is not damaged by the heat even when mounted. However, it is recommended to disassemble the sensor and seal.
- It must be possible to open the pipe by approx. 8 mm (0.31 in) for disassembly.

Cleaning with pigs

It is essential to take the internal diameters of the measuring tube and process connection into account when cleaning with pigs. All the dimensions and lengths of the sensor and transmitter are provided in the separate "Technical Information" document.

5.2.4 Mounting the transmitter of the remote version: Promag 400, Proline 500 – digital

⚠ CAUTION

Ambient temperature too high!

Danger of electronics overheating and housing deformation.

- ▶ Do not exceed the permitted maximum ambient temperature .
- ▶ If operating outdoors: Avoid direct sunlight and exposure to weathering, particularly in warm climatic regions.

⚠ CAUTION

Excessive force can damage the housing!

- ▶ Avoid excessive mechanical stress.

Wall mounting

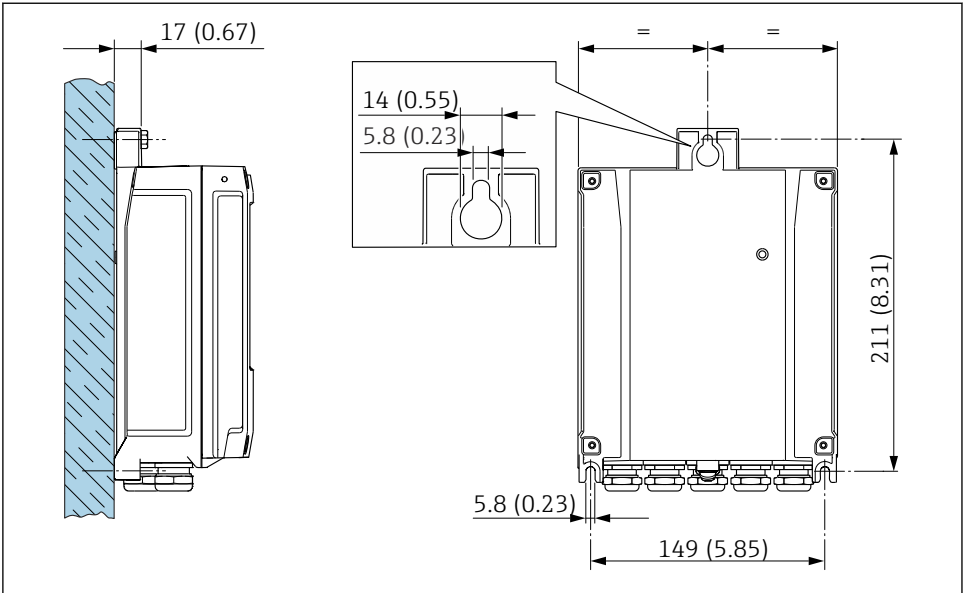

A0029054

13 Engineering unit mm (in)

Post mounting

⚠ WARNING

Excessive tightening torque applied to the fixing screws on plastic housing!
Risk of damaging the plastic transmitter.

- ▶ Tighten the fixing screws as per the tightening torque: 2 Nm (1.5 lbf ft)

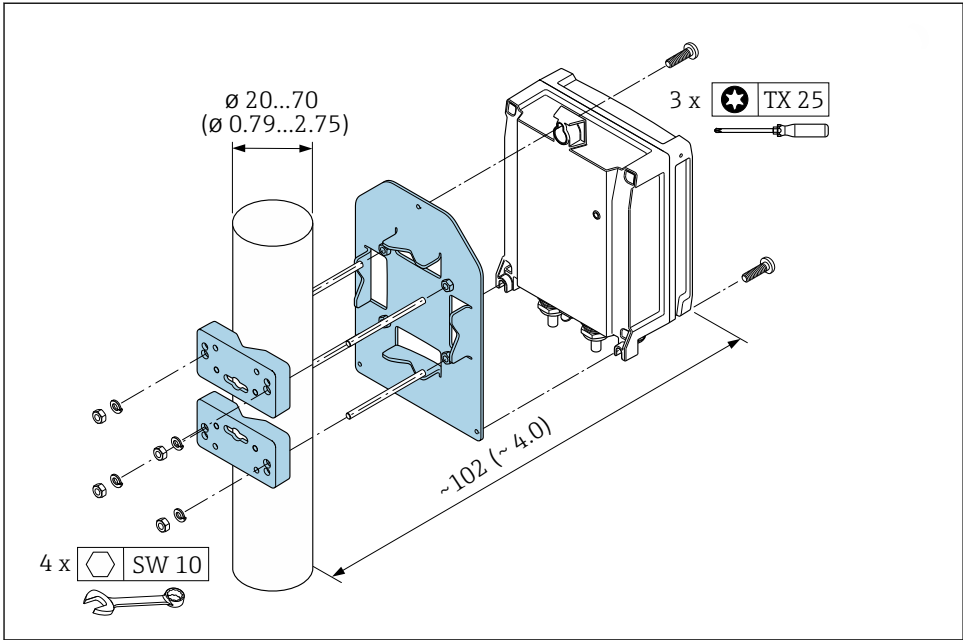

A0029051

14 Engineering unit mm (in)

5.2.5 Mounting the transmitter housing

CAUTION

Ambient temperature too high!

Danger of electronics overheating and housing deformation.

- ▶ Do not exceed the permitted maximum ambient temperature .
- ▶ If operating outdoors: Avoid direct sunlight and exposure to weathering, particularly in warm climatic regions.

CAUTION

Excessive force can damage the housing!

- ▶ Avoid excessive mechanical stress.

Post mounting

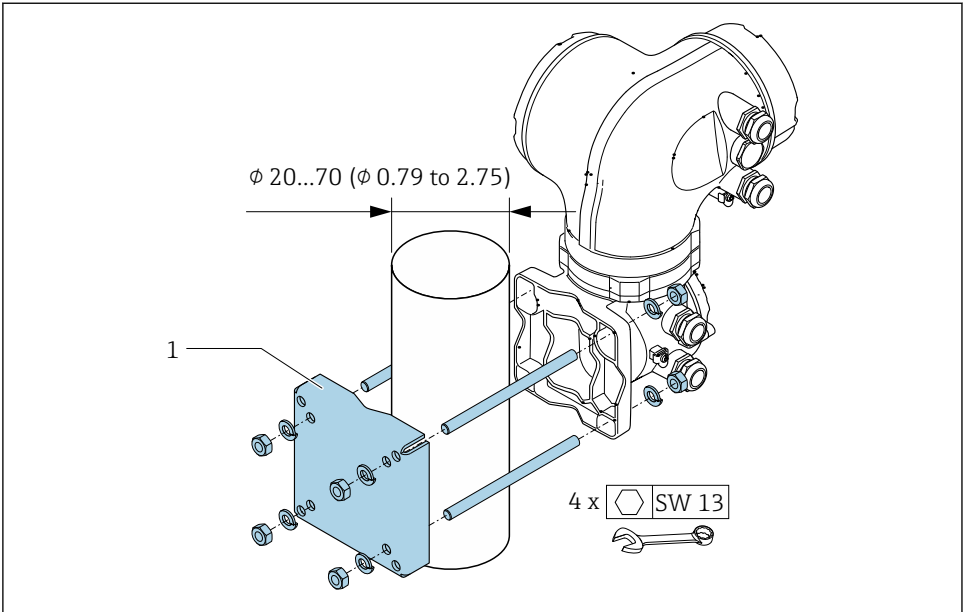

A0029057

15 Engineering unit mm (in)

Wall mounting

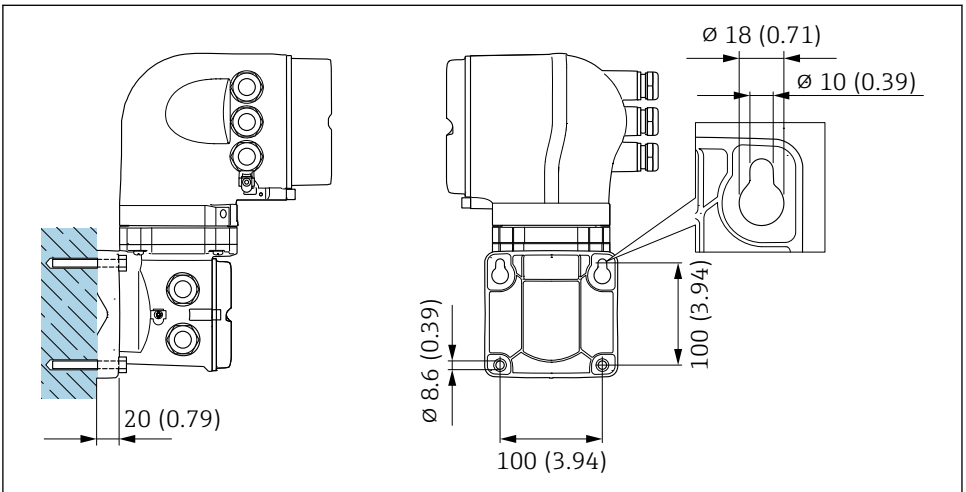

A0029068

16 Engineering unit mm (in)

5.3 Post-installation check

Is the device undamaged (visual inspection)?	<input type="checkbox"/>
Does the measuring device conform to the measuring point specifications? For example: <ul style="list-style-type: none"> ▪ Process temperature ▪ Process pressure (refer to the section on "Pressure-temperature ratings" in the "Technical Information" document on the CD-ROM provided) ▪ Ambient temperature ▪ Measuring range 	<input type="checkbox"/>
Has the correct orientation for the sensor been selected ? <ul style="list-style-type: none"> ▪ According to sensor type ▪ According to medium temperature ▪ According to medium properties (outgassing, with entrained solids) 	<input type="checkbox"/>
Does the arrow on the sensor nameplate match the direction of flow of the fluid through the piping ?	<input type="checkbox"/>
Are the measuring point identification and labeling correct (visual inspection)?	<input type="checkbox"/>
Is the device adequately protected from precipitation and direct sunlight?	<input type="checkbox"/>
Have the fixing screws been tightened with the correct tightening torque?	<input type="checkbox"/>

6 Disposal

6.1 Removing the measuring device

1. Switch off the device.

WARNING

Danger to persons from process conditions.

- ▶ Beware of hazardous process conditions such as pressure in the measuring device, high temperatures or aggressive fluids.

2. Carry out the mounting and connection steps from the "Mounting the measuring device" and "Connecting the measuring device" sections in reverse order. Observe the safety instructions.

6.2 Disposing of the measuring device

WARNING

Danger to personnel and environment from fluids that are hazardous to health.

- ▶ Ensure that the measuring device and all cavities are free of fluid residues that are hazardous to health or the environment, e.g. substances that have permeated into crevices or diffused through plastic.

Observe the following notes during disposal:

- ▶ Observe valid federal/national regulations.
- ▶ Ensure proper separation and reuse of the device components.

7 Appendix

7.1 Screw tightening torques



For detailed information on the screw tightening torques, see the "Mounting the sensor" section of the Operating Instructions for the device

Please note the following:

- The screw tightening torques listed below apply only to lubricated threads and to pipes not subjected to tensile stress.
- Tighten the screws uniformly and in diagonally opposite sequence.
- Overtightening the screws will deform the sealing faces or damage the seals.

7.1.1 Promag D

The tightening torques apply to situations where an EPDM soft material flat seal (e.g. 70° Shore) is used.

Screw tightening torques, mounting bolts and centering sleeves for EN 1092-1 (DIN 2501); PN 16

Nominal diameter [mm]	Mounting bolts [mm]	Length Centering sleeve [mm]	Max. screw tightening torque [Nm] for a process flange with ...	
			smooth seal face	Raised face
25	4 × M12 × 145	54	19	19
40	4 × M16 × 170	68	33	33
50	4 × M16 × 185	82	41	41
65 ¹⁾	4 × M16 × 200	92	44	44
65 ²⁾	8 × M16 × 200	– ³⁾	29	29
80	8 × M16 × 225	116	36	36
100	8 × M16 × 260	147	40	40

1) EN (DIN) flange: 4-hole → with centering sleeves

2) EN (DIN) flange: 8-hole → without centering sleeves

3) A centering sleeve is not required. The device is centered directly via the sensor housing.

Screw tightening torques, mounting bolts and centering sleeves for ASME B16.5; Class 150

Nominal diameter		Mounting bolts [in]	Length Centering sleeve [in]	Max. screw tightening torque [Nm] ([lbf · ft]) for a process flange with ...	
[mm]	[in]			smooth seal face	Raised face
25	1	4 × UNC ½" × 5.70	– ¹⁾	19 (14)	10 (7)
40	1 ½	4 × UNC ½" × 6.50	– ¹⁾	29 (21)	19 (14)
50	2	4 × UNC 5/8" × 7.50	– ¹⁾	41 (30)	37 (27)

Nominal diameter		Mounting bolts [in]	Length Centering sleeve [in]	Max. screw tightening torque [Nm] ([lbf · ft]) for a process flange with ...	
[mm]	[in]			smooth seal face	Raised face
80	3	4 × UNC 5/8" × 9.25	– ¹⁾	43 (31)	43 (31)
100	4	8 × UNC 5/8" × 10.4	5.79	38 (28)	38 (28)

1) A centering sleeve is not required. The device is centered directly via the sensor housing.

Screw tightening torques, mounting bolts and centering sleeves for JIS B2220; 10K

Nominal diameter [mm]	Mounting bolts [mm]	Length Centering sleeve [mm]	Max. screw tightening torque [Nm] for a process flange with ...	
			smooth seal face	Raised face
25	4 × M16 × 170	54	24	24
40	4 × M16 × 170	68	32	25
50	4 × M16 × 185	– ¹⁾	38	30
65	4 × M16 × 200	– ¹⁾	42	42
80	8 × M16 × 225	– ¹⁾	36	28
100	8 × M16 × 260	– ¹⁾	39	37

1) A centering sleeve is not required. The device is centered directly via the sensor housing.

7.1.2 Promag E, P

Screw tightening torques for EN 1092-1 (DIN 2501); PN 25, 40

Nominal diameter [mm]	Pressure rating [bar]	Screws [mm]	Max. screw tightening torque [Nm]	
			PTFE	PFA
15	PN 40	4 × M12	11	–
25	PN 40	4 × M12	26	20
32	PN 40	4 × M16	41	35
40	PN 40	4 × M16	52	47
50	PN 40	4 × M16	65	59
65 ¹⁾	PN 16	8 × M16	43	40
65	PN 40	8 × M16	43	40
80	PN 16	8 × M16	53	48
80	PN 40	8 × M16	53	48
100	PN 16	8 × M16	57	51
100	PN 40	8 × M20	78	70

Nominal diameter [mm]	Pressure rating [bar]	Screws [mm]	Max. screw tightening torque [Nm]	
			PTFE	PFA
125	PN 16	8 × M16	75	67
125	PN 40	8 × M24	111	99
150	PN 16	8 × M20	99	85
150	PN 40	8 × M24	136	120
200	PN 10	8 × M20	141	101
200	PN 16	12 × M20	94	67
200	PN 25	12 × M24	138	105
250	PN 10	12 × M20	110	–
250	PN 16	12 × M24	131	–
250	PN 25	12 × M27	200	–
300	PN 10	12 × M20	125	–
300	PN 16	12 × M24	179	–
300	PN 25	16 × M27	204	–
350	PN 10	16 × M20	188	–
350	PN 16	16 × M24	254	–
350	PN 25	16 × M30	380	–
400	PN 10	16 × M24	260	–
400	PN 16	16 × M27	330	–
400	PN 25	16 × M33	488	–
450	PN 10	20 × M24	235	–
450	PN 16	20 × M27	300	–
450	PN 25	20 × M33	385	–
500	PN 10	20 × M24	265	–
500	PN 16	20 × M30	448	–
500	PN 25	20 × M33	533	–
600	PN 10	20 × M27	345	–
600	PN 16	20 × M33	658	–
600	PN 25	20 × M36	731	–

1) Designed acc. to EN 1092-1 (not to DIN 2501)

Screw tightening torques for ASME B16.5; Class 150, 300

Nominal diameter		Pressure rating	Screws	Max. screw tightening torque [Nm] ([lbf · ft])	
[mm]	[in]			[psi]	[in]
15	½	Class 150	4 × ½	6 (4)	- (-)
15	½	Class 300	4 × ½	6 (4)	- (-)
25	1	Class 150	4 × ½	11 (8)	10 (7)
25	1	Class 300	4 × 5/8	14 (10)	12 (9)
40	1 ½	Class 150	4 × ½	24 (18)	21 (15)
40	1 ½	Class 300	4 × ¾	34 (25)	31 (23)
50	2	Class 150	4 × 5/8	47 (35)	44 (32)
50	2	Class 300	8 × 5/8	23 (17)	22 (16)
80	3	Class 150	4 × 5/8	79 (58)	67 (49)
80	3	Class 300	8 × ¾	47 (35)	42 (31)
100	4	Class 150	8 × 5/8	56 (41)	50 (37)
100	4	Class 300	8 × ¾	67 (49)	59 (44)
150	6	Class 150	8 × ¾	106 (78)	86 (63)
150	6	Class 300	12 × ¾	73 (54)	67 (49)
200	8	Class 150	8 × ¾	143 (105)	109 (80)
250	10	Class 150	12 × 7/8	135 (100)	- (-)
300	12	Class 150	12 × 7/8	178 (131)	- (-)
350	14	Class 150	12 × 1	260 (192)	- (-)
400	16	Class 150	16 × 1	246 (181)	- (-)
450	18	Class 150	16 × 1 1/8	371 (274)	- (-)
500	20	Class 150	20 × 1 1/8	341 (252)	- (-)
600	24	Class 150	20 × 1 ¼	477 (352)	- (-)

Screw tightening torques for JIS B2220; 10, 20K

Nominal diameter	Pressure rating	Screws	Max. screw tightening torque [Nm]	
			PTFE	PFA
[mm]	[bar]	[mm]		
25	10K	4 × M16	32	27
25	20K	4 × M16	32	27
32	10K	4 × M16	38	-
32	20K	4 × M16	38	-

Nominal diameter [mm]	Pressure rating [bar]	Screws [mm]	Max. screw tightening torque [Nm]	
			PTFE	PFA
40	10K	4 × M16	41	37
40	20K	4 × M16	41	37
50	10K	4 × M16	54	46
50	20K	8 × M16	27	23
65	10K	4 × M16	74	63
65	20K	8 × M16	37	31
80	10K	8 × M16	38	32
80	20K	8 × M20	57	46
100	10K	8 × M16	47	38
100	20K	8 × M20	75	58
125	10K	8 × M20	80	66
125	20K	8 × M22	121	103
150	10K	8 × M20	99	81
150	20K	12 × M22	108	72
200	10K	12 × M20	82	54
200	20K	12 × M22	121	88
250	10K	12 × M22	133	–
250	20K	12 × M24	212	–
300	10K	16 × M22	99	–
300	20K	16 × M24	183	–

Screw tightening torques for AS 2129; Table E

Nominal diameter [mm]	Screws [mm]	Max. screw tightening torque [Nm]
		PTFE
25	4 × M12	21
50	4 × M16	42

Screw tightening torques for AS 4087; PN 16

Nominal diameter [mm]	Screws [mm]	Max. screw tightening torque [Nm]
		PTFE
50	4 × M16	42

7.1.3 Promag L

Screw tightening torques for EN 1092-1 (DIN 2501); PN 6, 10, 16

Nominal diameter [mm]	Pressure rating [bar]	Screws [mm]	Max. screw tightening torque [Nm]		
			Hard rubber	Polyurethane	PTFE
25	PN 10/16	4 × M12	–	6	11
32	PN 10/16	4 × M16	–	16	27
40	PN 10/16	4 × M16	–	16	29
50	PN 10/16	4 × M16	–	15	40
65 ¹⁾	PN 10/16	8 × M16	–	10	22
80	PN 10/16	8 × M16	–	15	30
100	PN 10/16	8 × M16	–	20	42
125	PN 10/16	8 × M16	–	30	55
150	PN 10/16	8 × M20	–	50	90
200	PN 16	12 × M20	–	65	87
250	PN 16	12 × M24	–	126	151
300	PN 16	12 × M24	–	139	177
350	PN 6	12 × M20	111	120	–
350	PN 10	16 × M20	112	118	–
350	PN 16	16 × M24	152	165	–
400	PN 6	16 × M20	90	98	–
400	PN 10	16 × M24	151	167	–
400	PN 16	16 × M27	193	215	–
450	PN 6	16 × M20	112	126	–
450	PN 10	20 × M24	153	133	–
500	PN 6	20 × M20	119	123	–
500	PN 10	20 × M24	155	171	–
500	PN 16	20 × M30	275	300	–
600	PN 6	20 × M24	139	147	–
600	PN 10	20 × M27	206	219	–
600	PN 16	20 × M33	415	443	–
700	PN 6	24 × M24	148	139	–
700	PN 10	24 × M27	246	246	–
700	PN 16	24 × M33	278	318	–

Nominal diameter [mm]	Pressure rating [bar]	Screws [mm]	Max. screw tightening torque [Nm]		
			Hard rubber	Polyurethane	PTFE
800	PN 6	24 × M27	206	182	–
800	PN 10	24 × M30	331	316	–
800	PN 16	24 × M36	369	385	–
900	PN 6	24 × M27	230	637	–
900	PN 10	28 × M30	316	307	–
900	PN 16	28 × M36	353	398	–
1000	PN 6	28 × M27	218	208	–
1000	PN 10	28 × M33	402	405	–
1000	PN 16	28 × M39	502	518	–
1200	PN 6	32 × M30	319	299	–
1200	PN 10	32 × M36	564	568	–
1200	PN 16	32 × M45	701	753	–
1400	PN 6	36 × M33	430	–	–
1400	PN 10	36 × M39	654	–	–
1400	PN 16	36 × M45	729	–	–
1600	PN 6	40 × M33	440	–	–
1600	PN 10	40 × M45	946	–	–
1600	PN 16	40 × M52	1007	–	–
1800	PN 6	44 × M36	547	–	–
1800	PN 10	44 × M45	961	–	–
1800	PN 16	44 × M52	1108	–	–
2000	PN 6	48 × M39	629	–	–
2000	PN 10	48 × M45	1047	–	–
2000	PN 16	48 × M56	1324	–	–
2200	PN 6	52 × M39	698	–	–
2200	PN 10	52 × M52	1217	–	–
2400	PN 6	56 × M39	768	–	–
2400	PN 10	56 × M52	1229	–	–

1) Designed acc. to EN 1092-1 (not to DIN 2501)

Screw tightening torques for ASME B16.5; Class 150

Nominal diameter		Screws [in]	Max. screw tightening torque [Nm] ([lbf · ft])		
[mm]	[in]		Hard rubber	Polyurethane	PTFE
25	1	4 × 5/8	–	5 (4)	14 (13)
40	1 ½	8 × 5/8	–	10 (7)	21 (15)
50	2	4 × 5/8	–	15 (11)	40 (29)
80	3	4 × 5/8	–	25 (18)	65 (48)
100	4	8 × 5/8	–	20 (15)	44 (32)
150	6	8 × ¾	–	45 (33)	90 (66)
200	8	8 × ¾	–	65 (48)	87 (64)
250	10	12 × 7/8	–	126 (93)	151 (112)
300	12	12 × 7/8	–	146 (108)	177 (131)
350	14	12 × 1	135 (100)	158 (117)	–
400	16	16 × 1	128 (94)	150 (111)	–
450	18	16 × 1 1/8	204 (150)	234 (173)	–
500	20	20 × 1 1/8	183 (135)	217 (160)	–
600	24	20 × 1 ¼	268 (198)	307 (226)	–

Screw tightening torques for AWWA C207; Class D

Nominal diameter		Screws [in]	Max. screw tightening torque [Nm] ([lbf · ft])		
[mm]	[in]		Hard rubber	Polyurethane	PTFE
700	28	28 × 1 ¼	247 (182)	292 (215)	–
750	30	28 × 1 ¼	287 (212)	302 (223)	–
800	32	28 × 1 ½	394 (291)	422 (311)	–
900	36	32 × 1 ½	419 (309)	430 (317)	–
1000	40	36 × 1 ½	420 (310)	477 (352)	–
1050	42	36 × 1 ½	528 (389)	518 (382)	–
1200	48	44 × 1 ½	552 (407)	531 (392)	–
1350	54	44 × 1 ¾	730 (538)	–	–
1500	60	52 × 1 ¾	758 (559)	–	–
1650	66	52 × 1 ¾	946 (698)	–	–
1800	72	60 × 1 ¾	975 (719)	–	–
2000	78	64 × 2	853 (629)	–	–

Nominal diameter		Screws [in]	Max. screw tightening torque [Nm] ((lbf · ft))		
[mm]	[in]		Hard rubber	Polyurethane	PTFE
2 150	84	64 × 2	931 (687)	–	–
2 300	90	68 × 2 ¼	1048 (773)	–	–

Screw tightening torques for AS 2129; Table E

Nominal diameter [mm]	Screws [mm]	Max. screw tightening torque [Nm]		
		Hard rubber	Polyurethane	PTFE
350	12 × M24	203	–	–
400	12 × M24	226	–	–
450	16 × M24	226	–	–
500	16 × M24	271	–	–
600	16 × M30	439	–	–
700	20 × M30	355	–	–
750	20 × M30	559	–	–
800	20 × M30	631	–	–
900	24 × M30	627	–	–
1000	24 × M30	634	–	–
1200	32 × M30	727	–	–

Screw tightening torques for AS 4087; PN 16

Nominal diameter [mm]	Screws [mm]	Max. screw tightening torque [Nm]		
		Hard rubber	Polyurethane	PTFE
350	12 × M24	203	–	–
375	12 × M24	137	–	–
400	12 × M24	226	–	–
450	12 × M24	301	–	–
500	16 × M24	271	–	–
600	16 × M27	393	–	–
700	20 × M27	330	–	–
750	20 × M30	529	–	–
800	20 × M33	631	–	–
900	24 × M33	627	–	–

Nominal diameter [mm]	Screws [mm]	Max. screw tightening torque [Nm]		
		Hard rubber	Polyurethane	PTFE
1000	24 × M33	595	-	-
1200	32 × M33	703	-	-

7.1.4 Promag W

Screw tightening torques for EN 1092-1 (DIN 2501); PN 6, 10, 16, 25, 40

Nominal diameter [mm]	Pressure rating [bar]	Screws [mm]	Max. screw tightening torque [Nm]	
			Hard rubber	Polyurethane
25	PN 40	4 × M12	-	15
32	PN 40	4 × M16	-	24
40	PN 40	4 × M16	-	31
50	PN 40	4 × M16	48	40
65 ¹⁾	PN 16	8 × M16	32	27
65	PN 40	8 × M16	32	27
80	PN 16	8 × M16	40	34
80	PN 40	8 × M16	40	34
100	PN 16	8 × M16	43	36
100	PN 40	8 × M20	59	50
125	PN 16	8 × M16	56	48
125	PN 40	8 × M24	83	71
150	PN 16	8 × M20	74	63
150	PN 40	8 × M24	104	88
200	PN 10	8 × M20	106	91
200	PN 16	12 × M20	70	61
200	PN 25	12 × M24	104	92
250	PN 10	12 × M20	82	71
250	PN 16	12 × M24	98	85
250	PN 25	12 × M27	150	134
300	PN 10	12 × M20	94	81
300	PN 16	12 × M24	134	118
300	PN 25	16 × M27	153	138
350	PN 6	12 × M20	111	120

Nominal diameter [mm]	Pressure rating [bar]	Screws [mm]	Max. screw tightening torque [Nm]	
			Hard rubber	Polyurethane
350	PN 10	16 × M20	112	118
350	PN 16	16 × M24	152	165
350	PN 25	16 × M30	227	252
400	PN 6	16 × M20	90	98
400	PN 10	16 × M24	151	167
400	PN 16	16 × M27	193	215
400	PN 25	16 × M33	289	326
450	PN 6	16 × M20	112	126
450	PN 10	20 × M24	153	133
450	PN 16	20 × M27	198	196
450	PN 25	20 × M33	256	253
500	PN 6	20 × M20	119	123
500	PN 10	20 × M24	155	171
500	PN 16	20 × M30	275	300
500	PN 25	20 × M33	317	360
600	PN 6	20 × M24	139	147
600	PN 10	20 × M27	206	219
600	PN 16	20 × M33	415	443
600	PN 25	20 × M36	431	516
700	PN 6	24 × M24	148	139
700	PN 10	24 × M27	246	246
700	PN 16	24 × M33	278	318
700	PN 25	24 × M39	449	507
800	PN 6	24 × M27	206	182
800	PN 10	24 × M30	331	316
800	PN 16	24 × M36	369	385
800	PN 25	24 × M45	664	721
900	PN 6	24 × M27	230	637
900	PN 10	28 × M30	316	307
900	PN 16	28 × M36	353	398
900	PN 25	28 × M45	690	716
1000	PN 6	28 × M27	218	208

Nominal diameter [mm]	Pressure rating [bar]	Screws [mm]	Max. screw tightening torque [Nm]	
			Hard rubber	Polyurethane
1000	PN 10	28 × M33	402	405
1000	PN 16	28 × M39	502	518
1000	PN 25	28 × M52	970	971
1200	PN 6	32 × M30	319	299
1200	PN 10	32 × M36	564	568
1200	PN 16	32 × M45	701	753
1400	PN 6	36 × M33	430	398
1400	PN 10	36 × M39	654	618
1400	PN 16	36 × M45	729	762
1600	PN 6	40 × M33	440	417
1600	PN 10	40 × M45	946	893
1600	PN 16	40 × M52	1007	1100
1800	PN 6	44 × M36	547	521
1800	PN 10	44 × M45	961	895
1800	PN 16	44 × M52	1108	1003
2000	PN 6	48 × M39	629	605
2000	PN 10	48 × M45	1047	1092
2000	PN 16	48 × M56	1324	1261

1) Designed acc. to EN 1092-1 (not to DIN 2501)

Screw tightening torques for ASME B16.5; Class 150, 300

Nominal diameter		Pressure rating [psi]	Screws [in]	Max. screw tightening torque [Nm] ([lbf · ft])	
[mm]	[in]			Hard rubber	Polyurethane
25	1	Class 150	4 × ½	–	7 (5)
25	1	Class 300	4 × 5/8	–	8 (6)
40	1 ½	Class 150	4 × ½	–	10 (7)
40	1 ½	Class 300	4 × ¾	–	15 (11)
50	2	Class 150	4 × 5/8	35 (26)	22 (16)
50	2	Class 300	8 × 5/8	18 (13)	11 (8)
80	3	Class 150	4 × 5/8	60 (44)	43 (32)
80	3	Class 300	8 × ¾	38 (28)	26 (19)

Nominal diameter		Pressure rating [psi]	Screws [in]	Max. screw tightening torque [Nm] ([lbf · ft])	
[mm]	[in]			Hard rubber	Polyurethane
100	4	Class 150	8 × 5/8	42 (31)	31 (23)
100	4	Class 300	8 × ¾	58 (43)	40 (30)
150	6	Class 150	8 × ¾	79 (58)	59 (44)
150	6	Class 300	12 × ¾	70 (52)	51 (38)
200	8	Class 150	8 × ¾	107 (79)	80 (59)
250	10	Class 150	12 × 7/8	101 (74)	75 (55)
300	12	Class 150	12 × 7/8	133 (98)	103 (76)
350	14	Class 150	12 × 1	135 (100)	158 (117)
400	16	Class 150	16 × 1	128 (94)	150 (111)
450	18	Class 150	16 × 1 1/8	204 (150)	234 (173)
500	20	Class 150	20 × 1 1/8	183 (135)	217 (160)
600	24	Class 150	20 × 1 ¼	268 (198)	307 (226)

Screw tightening torques for AWWA C207; Class D

Nominal diameter		Screws [in]	Max. screw tightening torque [Nm] ([lbf · ft])	
[mm]	[in]		Hard rubber	Polyurethane
700	28	28 × 1 ¼	247 (182)	292 (215)
750	30	28 × 1 ¼	287 (212)	302 (223)
800	32	28 × 1 ½	394 (291)	422 (311)
900	36	32 × 1 ½	419 (309)	430 (317)
1000	40	36 × 1 ½	420 (310)	477 (352)
1050	42	36 × 1 ½	528 (389)	518 (382)
1200	48	44 × 1 ½	552 (407)	531 (392)
1350	54	44 × 1 ¾	730 (538)	-
1500	60	52 × 1 ¾	758 (559)	-
1650	66	52 × 1 ¾	946 (698)	-
1800	72	60 × 1 ¾	975 (719)	-
2000	78	64 × 2	853 (629)	-

Screw tightening torques for AS 2129; Table E

Nominal diameter [mm]	Screws [mm]	Max. screw tightening torque [Nm]	
		Hard rubber	Polyurethane
50	4 × M16	32	–
80	4 × M16	49	–
100	8 × M16	38	–
150	8 × M20	64	–
200	8 × M20	96	–
250	12 × M20	98	–
300	12 × M24	123	–
350	12 × M24	203	–
400	12 × M24	226	–
450	16 × M24	226	–
500	16 × M24	271	–
600	16 × M30	439	–
700	20 × M30	355	–
750	20 × M30	559	–
800	20 × M30	631	–
900	24 × M30	627	–
1000	24 × M30	634	–
1200	32 × M30	727	–

Screw tightening torques for AS 4087; PN 16

Nominal diameter [mm]	Screws [mm]	Max. screw tightening torque [Nm]	
		Hard rubber	Polyurethane
50	4 × M16	32	–
80	4 × M16	49	–
100	4 × M16	76	–
150	8 × M20	52	–
200	8 × M20	77	–
250	8 × M20	147	–
300	12 × M24	103	–
350	12 × M24	203	–
375	12 × M24	137	–

Nominal diameter [mm]	Screws [mm]	Max. screw tightening torque [Nm]	
		Hard rubber	Polyurethane
400	12 × M24	226	-
450	12 × M24	301	-
500	16 × M24	271	-
600	16 × M27	393	-
700	20 × M27	330	-
750	20 × M30	529	-
800	20 × M33	631	-
900	24 × M33	627	-
1000	24 × M33	595	-
1200	32 × M33	703	-

Screw tightening torques for JIS B2220; 10, 20K

Nominal diameter [mm]	Pressure rating [bar]	Screws [mm]	Max. screw tightening torque [Nm]	
			Hard rubber	Polyurethane
25	10K	4 × M16	-	19
25	20K	4 × M16	-	19
32	10K	4 × M16	-	22
32	20K	4 × M16	-	22
40	10K	4 × M16	-	24
40	20K	4 × M16	-	24
50	10K	4 × M16	40	33
50	20K	8 × M16	20	17
65	10K	4 × M16	55	45
65	20K	8 × M16	28	23
80	10K	8 × M16	29	23
80	20K	8 × M20	42	35
100	10K	8 × M16	35	29
100	20K	8 × M20	56	48
125	10K	8 × M20	60	51
125	20K	8 × M22	91	79
150	10K	8 × M20	75	63
150	20K	12 × M22	81	72

Nominal diameter [mm]	Pressure rating [bar]	Screws [mm]	Max. screw tightening torque [Nm]	
			Hard rubber	Polyurethane
200	10K	12 × M20	61	52
200	20K	12 × M22	91	80
250	10K	12 × M22	100	87
250	20K	12 × M24	159	144
300	10K	16 × M22	74	63
300	20K	16 × M24	138	124



71767980

www.addresses.endress.com
