

# Operating Instructions

## Proline Cubemass C 100

### Ethernet/IP

Coriolis flowmeter

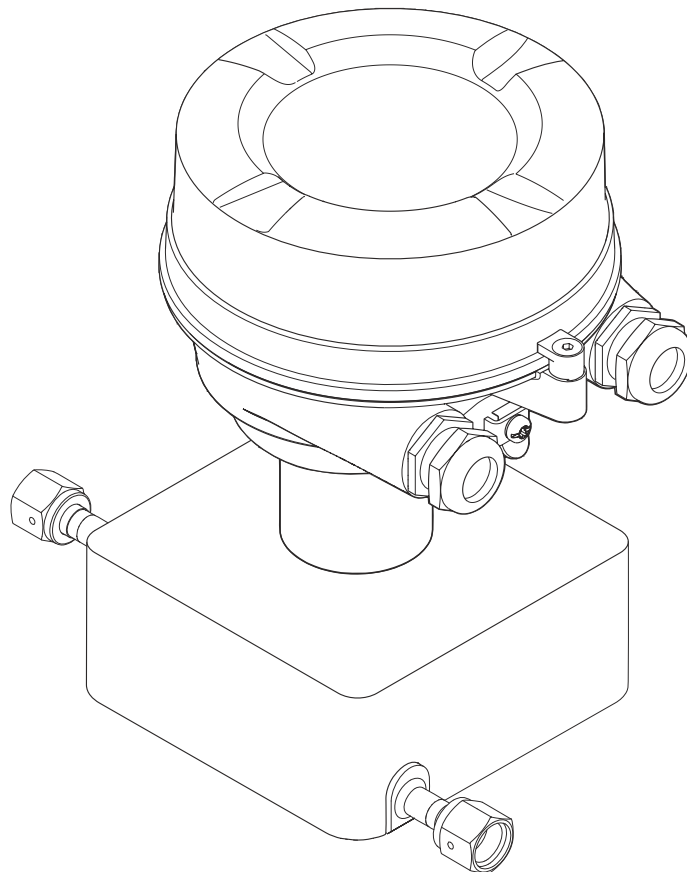

- Make sure the document is stored in a safe place such that it is always available when working on or with the device.
- To avoid danger to individuals or the facility, read the "Basic safety instructions" section carefully, as well as all other safety instructions in the document that are specific to working procedures.
- The manufacturer reserves the right to modify technical data without prior notice. Your Endress+Hauser sales organization will supply you with current information and updates to this manual.

## Table of contents

<b>1</b>	<b>About this document</b> . . . . .	<b>6</b>		
1.1	Document function . . . . .	6		
1.2	Symbols . . . . .	6		
1.2.1	Safety symbols . . . . .	6		
1.2.2	Electrical symbols . . . . .	6		
1.2.3	Tool symbols . . . . .	6		
1.2.4	Symbols for certain types of information . . . . .	7		
1.2.5	Symbols in graphics . . . . .	7		
1.3	Documentation . . . . .	7		
1.4	Registered trademarks . . . . .	8		
<b>2</b>	<b>Safety instructions</b> . . . . .	<b>9</b>		
2.1	Requirements for the personnel . . . . .	9		
2.2	Intended use . . . . .	9		
2.3	Workplace safety . . . . .	10		
2.4	Operational safety . . . . .	10		
2.5	Product safety . . . . .	10		
2.6	IT security . . . . .	11		
<b>3</b>	<b>Product description</b> . . . . .	<b>12</b>		
3.1	Product design . . . . .	12		
3.1.1	Device version with EtherNet/IP communication protocol . . . . .	12		
<b>4</b>	<b>Incoming acceptance and product identification</b> . . . . .	<b>13</b>		
4.1	Incoming acceptance . . . . .	13		
4.2	Product identification . . . . .	13		
4.2.1	Transmitter nameplate . . . . .	14		
4.2.2	Sensor nameplate . . . . .	15		
4.2.3	Symbols on the device . . . . .	16		
<b>5</b>	<b>Storage and transport</b> . . . . .	<b>17</b>		
5.1	Storage conditions . . . . .	17		
5.2	Transporting the product . . . . .	17		
5.2.1	Measuring devices without lifting lugs . . . . .	17		
5.2.2	Measuring devices with lifting lugs . . . . .	18		
5.2.3	Transporting with a fork lift . . . . .	18		
5.3	Packaging disposal . . . . .	18		
<b>6</b>	<b>Installation</b> . . . . .	<b>19</b>		
6.1	Installation requirements . . . . .	19		
6.1.1	Installation position . . . . .	19		
6.1.2	Environmental and process requirements . . . . .	21		
6.1.3	Special installation instructions . . . . .	22		
6.2	Installing the device . . . . .	25		
6.2.1	Required tools . . . . .	25		
6.2.2	Preparing the measuring instrument . . . . .	25		
6.2.3	Installing the measuring instrument . . . . .	25		
6.2.4	Turning the display module . . . . .	25		
6.3	Post-installation check . . . . .	26		
<b>7</b>	<b>Electrical connection</b> . . . . .	<b>27</b>		
7.1	Electrical safety . . . . .	27		
7.2	Connecting requirements . . . . .	27		
7.2.1	Required tools . . . . .	27		
7.2.2	Requirements for connection cable . . . . .	27		
7.2.3	Terminal assignment . . . . .	28		
7.2.4	Pin assignment, device plug . . . . .	29		
7.2.5	Preparing the device . . . . .	29		
7.3	Connecting the device . . . . .	29		
7.3.1	Connecting the transmitter . . . . .	30		
7.4	Potential equalization . . . . .	32		
7.4.1	Requirements . . . . .	32		
7.5	Special connection instructions . . . . .	32		
7.5.1	Connection examples . . . . .	32		
7.6	Hardware settings . . . . .	32		
7.6.1	Setting the device address . . . . .	32		
7.7	Ensuring the degree of protection . . . . .	33		
7.8	Post-connection check . . . . .	34		
<b>8</b>	<b>Operation options</b> . . . . .	<b>35</b>		
8.1	Overview of operation options . . . . .	35		
8.2	Structure and function of the operating menu . . . . .	36		
8.2.1	Structure of the operating menu . . . . .	36		
8.2.2	Operating philosophy . . . . .	37		
8.3	Displaying the measured values via the local display (optionally available) . . . . .	38		
8.3.1	Operational display . . . . .	38		
8.3.2	User roles and related access authorization . . . . .	39		
8.4	Access to the operating menu via the web browser . . . . .	40		
8.4.1	Function range . . . . .	40		
8.4.2	Prerequisites . . . . .	40		
8.4.3	Connecting the device . . . . .	42		
8.4.4	Logging on . . . . .	43		
8.4.5	User interface . . . . .	44		
8.4.6	Disabling the Web server . . . . .	45		
8.4.7	Logging out . . . . .	45		
8.5	Access to the operating menu via the operating tool . . . . .	46		
8.5.1	Connecting the operating tool . . . . .	46		
8.5.2	FieldCare . . . . .	47		
8.5.3	DeviceCare . . . . .	47		
<b>9</b>	<b>System integration</b> . . . . .	<b>48</b>		
9.1	Overview of device description files . . . . .	48		
9.1.1	Current version data for the device . . . . .	48		
9.1.2	Operating tools . . . . .	48		
9.2	Overview of system files . . . . .	48		

9.3	Integrating the device in the system . . . . .	49	12.4	Diagnostic information in FieldCare or DeviceCare . . . . .	79
9.4	Cyclic data transmission . . . . .	49	12.4.1	Diagnostic options . . . . .	79
9.4.1	Block model . . . . .	49	12.4.2	Calling up remedy information . . . . .	80
9.4.2	Input and output groups . . . . .	49	12.5	Diagnostic information via communication interface . . . . .	81
<b>10</b>	<b>Commissioning . . . . .</b>	<b>53</b>	12.5.1	Reading out diagnostic information . . . . .	81
10.1	Post-installation and post-connection check . . . . .	53	12.6	Adapting the diagnostic information . . . . .	81
10.2	Configuring the device address via software . . . . .	53	12.6.1	Adapting the diagnostic behavior . . . . .	81
10.2.1	Ethernet network and web server . . . . .	53	12.7	Overview of diagnostic information . . . . .	81
10.3	Setting the operating language . . . . .	53	12.7.1	Diagnostic of sensor . . . . .	82
10.4	Configuring the device . . . . .	53	12.7.2	Diagnostic of electronic . . . . .	83
10.4.1	Defining the tag name . . . . .	54	12.7.3	Diagnostic of configuration . . . . .	86
10.4.2	Setting the system units . . . . .	54	12.7.4	Diagnostic of process . . . . .	88
10.4.3	Selecting and setting the medium . . . . .	57	12.8	Pending diagnostic events . . . . .	92
10.4.4	Configuration of the communication interface . . . . .	58	12.9	Diagnostic list . . . . .	93
10.4.5	Configuring the low flow cut off . . . . .	60	12.10	Event logbook . . . . .	93
10.4.6	Partially filled pipe detection . . . . .	61	12.10.1	Reading out the event logbook . . . . .	93
10.5	Advanced settings . . . . .	62	12.10.2	Filtering the event logbook . . . . .	93
10.5.1	Using the parameter to enter the access code . . . . .	62	12.10.3	Overview of information events . . . . .	94
10.5.2	Calculated process variables . . . . .	62	12.11	Resetting the device . . . . .	95
10.5.3	Carrying out a sensor adjustment . . . . .	64	12.11.1	Function scope of the "Device reset" parameter . . . . .	95
10.5.4	Configuring the totalizer . . . . .	65	12.12	Device information . . . . .	95
10.5.5	Using parameters for device administration . . . . .	66	12.13	Firmware history . . . . .	97
10.6	Simulation . . . . .	67	<b>13</b>	<b>Maintenance . . . . .</b>	<b>98</b>
10.7	Protecting settings from unauthorized access . . . . .	68	13.1	Maintenance work . . . . .	98
10.7.1	Write protection via access code . . . . .	68	13.1.1	Cleaning . . . . .	98
10.7.2	Write protection via write protection switch . . . . .	69	13.2	Measuring and test equipment . . . . .	98
<b>11</b>	<b>Operation . . . . .</b>	<b>70</b>	13.3	Maintenance services . . . . .	98
11.1	Read out and modify current Ethernet settings . . . . .	70	<b>14</b>	<b>Repair . . . . .</b>	<b>99</b>
11.2	Reading the device locking status . . . . .	70	14.1	General notes . . . . .	99
11.3	Adjusting the operating language . . . . .	71	14.1.1	Repair and conversion concept . . . . .	99
11.4	Reading off measured values . . . . .	71	14.1.2	Notes for repair and conversion . . . . .	99
11.4.1	"Measured variables" submenu . . . . .	71	14.2	Spare parts . . . . .	99
11.4.2	"Totalizer" submenu . . . . .	73	14.3	Repair services . . . . .	99
11.5	Adapting the measuring device to the process conditions . . . . .	74	14.4	Return . . . . .	99
11.6	Performing a totalizer reset . . . . .	74	14.5	Disposal . . . . .	100
11.6.1	Function scope of "Control Totalizer" parameter . . . . .	75	14.5.1	Removing the measuring instrument . . . . .	100
11.6.2	Function range of "Reset all totalizers" parameter . . . . .	75	14.5.2	Disposing of the measuring instrument . . . . .	100
<b>12</b>	<b>Diagnostics and troubleshooting . . . . .</b>	<b>76</b>	<b>15</b>	<b>Accessories . . . . .</b>	<b>101</b>
12.1	General troubleshooting . . . . .	76	15.1	Device-specific accessories . . . . .	101
12.2	Diagnostic information via LEDs . . . . .	77	15.2	Communication-specific accessories . . . . .	101
12.2.1	Transmitter . . . . .	77	15.3	Service-specific accessories . . . . .	102
12.3	Diagnostic information in the web browser . . . . .	78	15.4	System components . . . . .	102
12.3.1	Diagnostic options . . . . .	78	<b>16</b>	<b>Technical data . . . . .</b>	<b>103</b>
12.3.2	Calling up remedial actions . . . . .	79	16.1	Application . . . . .	103
			16.2	Function and system design . . . . .	103
			16.3	Input . . . . .	104
			16.4	Output . . . . .	105

16.5	Power supply . . . . .	109
16.6	Performance characteristics . . . . .	110
16.7	Installation . . . . .	113
16.8	Environment . . . . .	113
16.9	Process . . . . .	114
16.10	Mechanical construction . . . . .	117
16.11	Operability . . . . .	119
16.12	Certificates and approvals . . . . .	121
16.13	Application packages . . . . .	123
16.14	Accessories . . . . .	124
16.15	Documentation . . . . .	124
<b>Index</b>	. . . . .	<b>126</b>

# 1 About this document

## 1.1 Document function

These Operating Instructions contain all the information required in the various life cycle phases of the device: from product identification, incoming acceptance and storage, to installation, connection, operation and commissioning, through to troubleshooting, maintenance and disposal.

## 1.2 Symbols

### 1.2.1 Safety symbols

#### DANGER

This symbol alerts you to a dangerous situation. Failure to avoid this situation will result in serious or fatal injury.

#### WARNING

This symbol alerts you to a potentially dangerous situation. Failure to avoid this situation can result in serious or fatal injury.





#### CAUTION

This symbol alerts you to a potentially dangerous situation. Failure to avoid this situation can result in minor or medium injury.



#### NOTICE

This symbol alerts you to a potentially harmful situation. Failure to avoid this situation can result in damage to the product or something in its vicinity.













### 1.2.2 Electrical symbols

Symbol	Meaning
	Direct current
	Alternating current
	Direct current and alternating current
	<b>Ground connection</b> A grounded terminal which, as far as the operator is concerned, is grounded via a grounding system.
	<b>Protective earth (PE)</b> Ground terminals that must be connected to ground prior to establishing any other connections.  The ground terminals are located on the interior and exterior of the device: <ul style="list-style-type: none"> <li>▪ Interior ground terminal: protective earth is connected to the mains supply.</li> <li>▪ Exterior ground terminal: device is connected to the plant grounding system.</li> </ul>



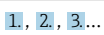

### 1.2.3 Tool symbols

Symbol	Meaning
	Allen key
	Open-end wrench

### 1.2.4 Symbols for certain types of information

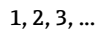
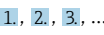
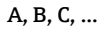
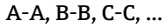
Symbol	Meaning
	<b>Permitted</b> Procedures, processes or actions that are permitted.
	<b>Preferred</b> Procedures, processes or actions that are preferred.
	<b>Forbidden</b> Procedures, processes or actions that are forbidden.
	<b>Tip</b> Indicates additional information.
	Reference to documentation
	Reference to page
	Reference to graphic
	Notice or individual step to be observed
	Series of steps
	Result of a step
	Help in the event of a problem
	Visual inspection

### 1.2.5 Symbols in graphics

Symbol	Meaning
	Item numbers
	Series of steps
	Views
	Sections
	Hazardous area
	Safe area (non-hazardous area)
	Flow direction

## 1.3 Documentation

 For an overview of the scope of the associated Technical Documentation, refer to the following:

- *Device Viewer* ([www.endress.com/deviceviewer](http://www.endress.com/deviceviewer)): Enter the serial number from the nameplate
- *Endress+Hauser Operations app*: Enter serial number from nameplate or scan matrix code on nameplate.

The following document types are available in the Downloads area of the Endress+Hauser website ([www.endress.com/downloads](http://www.endress.com/downloads)), depending on the device version:

Document type	Purpose and content of the document
Technical Information (TI)	<b>Planning aid for your device</b> The document contains all the technical data on the device and provides an overview of the accessories and other products that can be ordered for the device.
Brief Operating Instructions (KA)	<b>Guide that takes you quickly to the 1st measured value</b> The Brief Operating Instructions contain all the essential information from incoming acceptance to initial commissioning.
Operating Instructions (BA)	<b>Your reference document</b> The Operating Instructions contain all the information that is required in various phases of the life cycle of the device: from product identification, incoming acceptance and storage, to mounting, connection, operation and commissioning through to troubleshooting, maintenance and disposal.
Description of Device Parameters (GP)	<b>Reference for your parameters</b> The document provides a detailed explanation of each individual parameter. The description is aimed at those who work with the device over the entire life cycle and perform specific configurations.
Safety instructions (XA)	Depending on the approval, safety instructions for electrical equipment in hazardous areas are also supplied with the device. These are an integral part of the Operating Instructions.  The nameplate indicates which Safety Instructions (XA) apply to the device.
Supplementary device-dependent documentation (SD/FY)	Always comply strictly with the instructions in the relevant supplementary documentation. The supplementary documentation is a constituent part of the device documentation.

## 1.4 Registered trademarks

### Ethernet/IP™

Trademark of ODVA, Inc.

### TRI-CLAMP®

Registered trademark of Ladish & Co., Inc., Kenosha, USA

## 2 Safety instructions

### 2.1 Requirements for the personnel

The personnel for installation, commissioning, diagnostics and maintenance must fulfill the following requirements:

- ▶ Trained, qualified specialists must have a relevant qualification for this specific function and task.
- ▶ Are authorized by the plant owner/operator.
- ▶ Are familiar with federal/national regulations.
- ▶ Before starting work, read and understand the instructions in the manual and supplementary documentation as well as the certificates (depending on the application).
- ▶ Follow instructions and comply with basic conditions.

The operating personnel must fulfill the following requirements:

- ▶ Are instructed and authorized according to the requirements of the task by the facility's owner-operator.
- ▶ Follow the instructions in this manual.

### 2.2 Intended use

#### Application and media

The measuring instrument described in this manual is intended only for the flow measurement of liquids and gases.

Depending on the version ordered, the measuring instrument can also measure potentially explosive, flammable, poisonous and oxidizing media.

Measuring instruments for use in hazardous areas, in hygienic applications, or where there is an increased risk due to pressure, are specially labeled on the nameplate.

To ensure that the measuring instrument remains in proper condition during the operating time:

- ▶ Only use the measuring instrument in full compliance with the data on the nameplate and the general conditions listed in the manual and supplementary documentation.
- ▶ Using the nameplate, check whether the ordered device is permitted for the intended use in the hazardous area (e.g. explosion protection, pressure vessel safety).
- ▶ Use the measuring instrument only for media against which the materials in contact with the process are sufficiently resistant.
- ▶ Keep within the specified pressure and temperature range.
- ▶ Keep within the specified ambient temperature range.
- ▶ Protect the measuring instrument permanently against corrosion from environmental influences.

#### Incorrect use

Non-designated use can compromise safety. The manufacturer is not liable for damage caused by improper or non-designated use.

#### **WARNING**

#### **Danger of breakage due to corrosive or abrasive fluids and ambient conditions!**

- ▶ Verify the compatibility of the process fluid with the sensor material.
- ▶ Ensure the resistance of all wetted materials during the process.
- ▶ Keep within the specified pressure and temperature range.

**NOTICE****Verification for borderline cases:**

- ▶ For special fluids and fluids for cleaning, Endress+Hauser is glad to provide assistance in verifying the corrosion resistance of fluid-wetted materials, but does not accept any warranty or liability as minute changes in the temperature, concentration or level of contamination in the process can alter the corrosion resistance properties.

**Residual risks****⚠ WARNING****Risk of hot or cold burns! The use of media and electronics with high or low temperatures can produce hot or cold surfaces on the device.**

- ▶ Mount suitable touch protection.

**⚠ WARNING****Danger of housing breaking due to measuring tube breakage!**

If a measuring tube ruptures, the pressure inside the sensor housing will rise according to the operating process pressure.

- ▶ Use a rupture disk.

**⚠ WARNING****Danger from medium escaping!**

For device versions with a rupture disk: medium escaping under pressure can cause injury or material damage.

- ▶ Take precautions to prevent injury and material damage if the rupture disk is actuated.

## 2.3 Workplace safety

For work on and with the device:

- ▶ Wear the required personal protective equipment according to federal/national regulations.

## 2.4 Operational safety

Damage to the device!

- ▶ Operate the device in proper technical condition and fail-safe condition only.
- ▶ The operator is responsible for the interference-free operation of the device.

**Modifications to the device**

Unauthorized modifications to the device are not permitted and can lead to unforeseeable dangers!

- ▶ If modifications are nevertheless required, consult with the manufacturer.

**Repair**

To ensure continued operational safety and reliability:

- ▶ Carry out repairs on the device only if they are expressly permitted.
- ▶ Observe federal/national regulations pertaining to the repair of an electrical device.
- ▶ Use only original spare parts and accessories.

## 2.5 Product safety

This state-of-the-art device is designed and tested in accordance with good engineering practice to meet operational safety standards. It left the factory in a condition in which it is safe to operate.

It meets general safety standards and legal requirements. It also complies with the EU directives listed in the device-specific EU declaration of conformity. The manufacturer confirms this by affixing the CE mark.

## **2.6 IT security**

The manufacturer warranty is valid only if the product is installed and used as described in the Operating Instructions. The product is equipped with security mechanisms to protect it against any inadvertent changes to the settings.

IT security measures, which provide additional protection for the product and associated data transfer, must be implemented by the operators themselves in line with their security standards.

### 3 Product description

The device consists of a transmitter and a sensor.

The device is available as a compact version:

The transmitter and sensor form a mechanical unit.

#### 3.1 Product design

##### 3.1.1 Device version with EtherNet/IP communication protocol

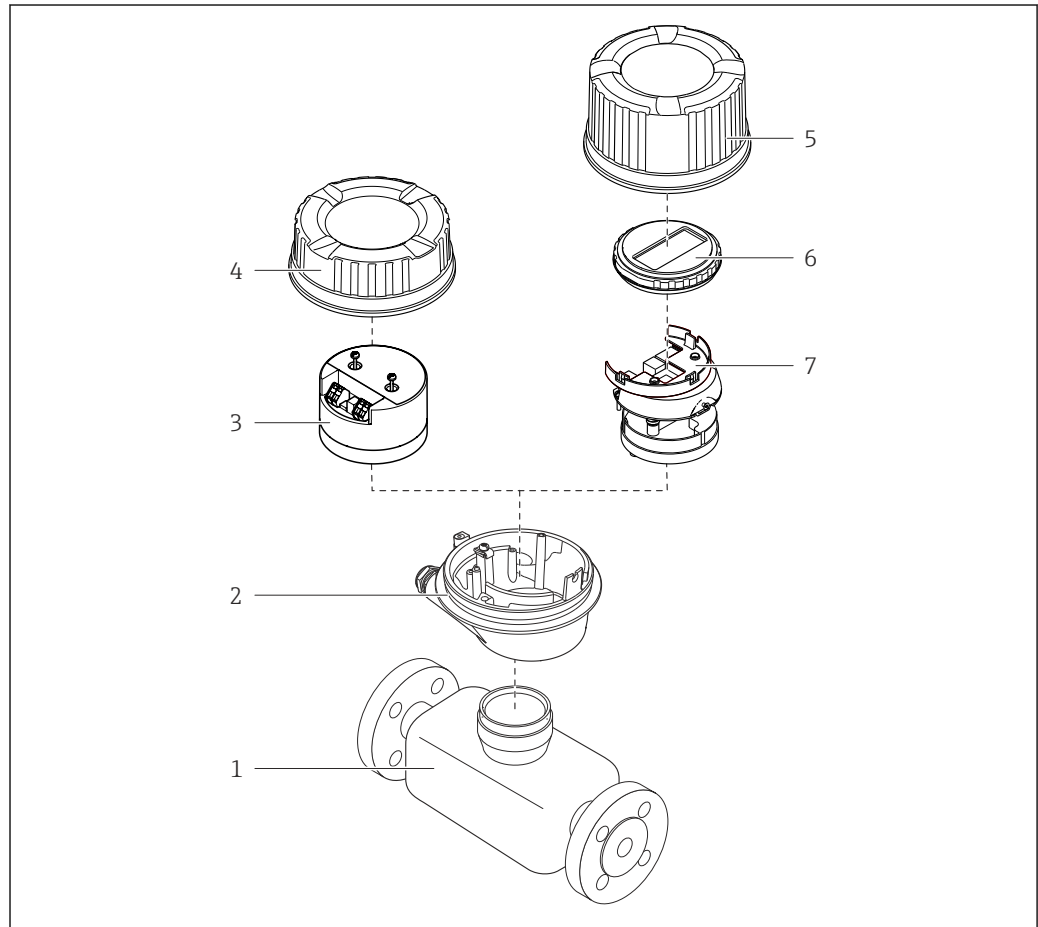

A0023153

1 Important components of a measuring device

- 1 Sensor
- 2 Transmitter housing
- 3 Main electronics module
- 4 Transmitter housing cover
- 5 Transmitter housing cover (version for optional local display)
- 6 Local display (optional)
- 7 Main electronics module (with bracket for optional local display)

## 4 Incoming acceptance and product identification

### 4.1 Incoming acceptance

On receipt of the delivery:

1. Check the packaging for damage.
  - ↳ Report all damage immediately to the manufacturer.  
Do not install damaged components.
2. Check the scope of delivery using the delivery note.
3. Compare the data on the nameplate with the order specifications on the delivery note.
4. Check the technical documentation and all other necessary documents, e.g. certificates, to ensure they are complete.



If one of the conditions is not satisfied, contact the manufacturer.

### 4.2 Product identification

The device can be identified in the following ways:

- Nameplate
- Order code with details of the device features on the delivery note
- Enter the serial numbers from the nameplates in the *Device Viewer* ([www.endress.com/deviceviewer](http://www.endress.com/deviceviewer)): all the information about the device is displayed.
- Enter the serial numbers from the nameplates into the *Endress+Hauser Operations app* or scan the DataMatrix code on the nameplate with the *Endress+Hauser Operations app*: all the information about the device is displayed.

For an overview of the scope of the associated Technical Documentation, refer to the following:

- The "Additional standard device documentation" and "Supplementary device-dependent documentation" sections
- The *Device Viewer*: Enter the serial number from the nameplate ([www.endress.com/deviceviewer](http://www.endress.com/deviceviewer))
- The *Endress+Hauser Operations app*: Enter the serial number from the nameplate or scan the DataMatrix code on the nameplate.

### 4.2.1 Transmitter nameplate

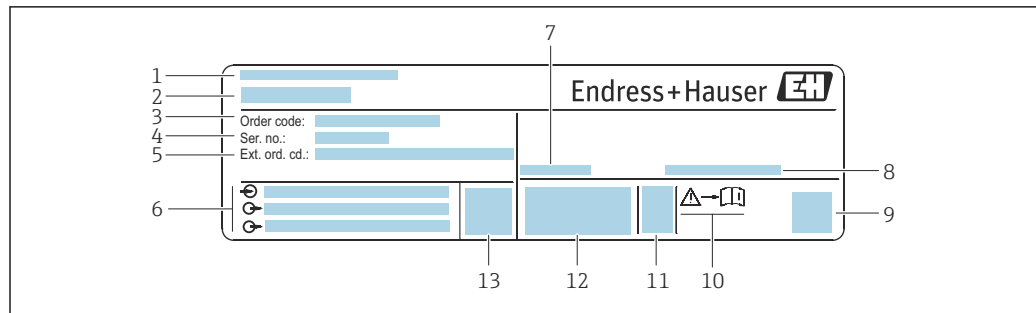

A0030222

2 Example of a transmitter nameplate

- 1 Manufacturer address/certificate holder
- 2 Name of the transmitter
- 3 Order code
- 4 Serial number
- 5 Extended order code
- 6 Electrical connection data, e.g. available inputs and outputs, supply voltage
- 7 Permitted ambient temperature ( $T_a$ )
- 8 Degree of protection
- 9 2-D matrix code
- 10 Document number of safety-related supplementary documentation → 124
- 11 Date of manufacture: year-month
- 12 CE mark, RCM-Tick mark
- 13 Firmware version (FW)

## 4.2.2 Sensor nameplate

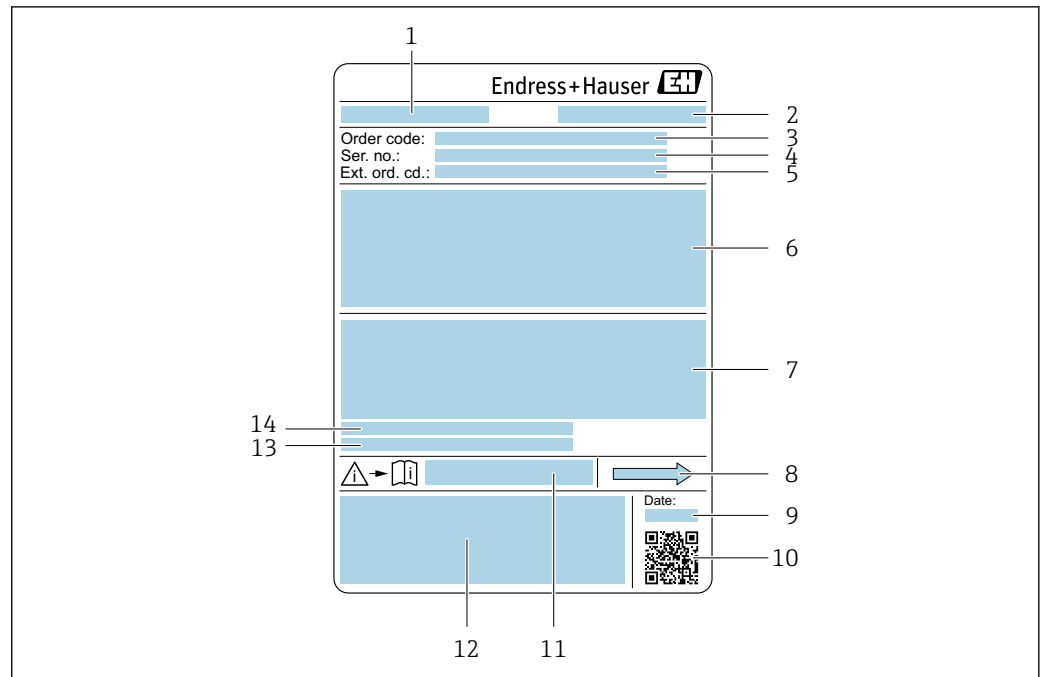

A0029199

3 Example of a sensor nameplate

- 1 Name of sensor
- 2 Manufacturer/certificate holder
- 3 Order code
- 4 Serial number (Ser. no.)
- 5 Extended order code (Ext. ord. cd.)
- 6 Nominal diameter of the sensor; flange nominal diameter/nominal pressure; sensor test pressure; medium temperature range; material of measuring tube and manifold; sensor-specific information: e.g. pressure range of sensor housing, wide-range density specification (special density calibration)
- 7 Approval information for explosion protection, Pressure Equipment Directive and degree of protection
- 8 Flow direction
- 9 Manufacturing date: year-month
- 10 2-D matrix code
- 11 Document number of safety-related supplementary documentation
- 12 CE mark, RCM symbol
- 13 Surface roughness
- 14 Permitted ambient temperature ( $T_a$ )



### Order code

The measuring device is reordered using the order code.

#### Extended order code

- The device type (product root) and basic specifications (mandatory features) are always listed.
- Of the optional specifications (optional features), only the safety and approval-related specifications are listed (e.g. LA). If other optional specifications are also ordered, these are indicated collectively using the # placeholder symbol (e.g. #LA#).
- If the ordered optional specifications do not include any safety and approval-related specifications, they are indicated by the + placeholder symbol (e.g. XXXXXX-ABCDE+).

### 4.2.3 Symbols on the device

Symbol	Meaning
	<b>WARNING!</b> This symbol alerts you to a dangerous situation. Failure to avoid this situation can result in serious or fatal injury. Please consult the documentation for the measuring instrument to discover the type of potential danger and measures to avoid it.
	<b>Reference to documentation</b> Refers to the corresponding device documentation.
	<b>Protective ground connection</b> A terminal that must be connected to the ground prior to establishing any other connections.

## 5 Storage and transport

### 5.1 Storage conditions

Observe the following notes for storage:

- ▶ Store in the original packaging to ensure protection from shock.
- ▶ Do not remove protective covers or protective caps installed on process connections. They prevent mechanical damage to the sealing surfaces and contamination in the measuring tube.
- ▶ Protect from direct sunlight. Avoid unacceptably high surface temperatures.
- ▶ Store in a dry and dust-free place.
- ▶ Do not store outdoors.

Storage temperature →  113

### 5.2 Transporting the product

Transport the measuring device to the measuring point in the original packaging.



A0029252

-  Do not remove protective covers or caps installed on process connections. They prevent mechanical damage to the sealing surfaces and contamination in the measuring tube.

#### 5.2.1 Measuring devices without lifting lugs

##### WARNING

**Center of gravity of the measuring device is higher than the suspension points of the webbing slings.**

Risk of injury if the measuring device slips.

- ▶ Secure the measuring device against slipping or turning.
- ▶ Observe the weight specified on the packaging (stick-on label).

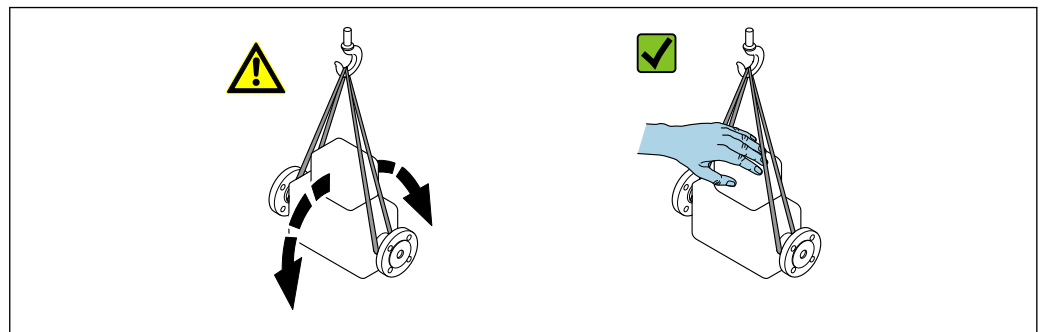

A0029214

## 5.2.2 Measuring devices with lifting lugs

### **⚠ CAUTION**

#### **Special transportation instructions for devices with lifting lugs**

- ▶ Only use the lifting lugs fitted on the device or flanges to transport the device.
- ▶ The device must always be secured at two lifting lugs at least.

## 5.2.3 Transporting with a fork lift

If transporting in wood crates, the floor structure enables the crates to be lifted lengthwise or at both sides using a forklift.

## 5.3 Packaging disposal

All packaging materials are environmentally friendly and 100% recyclable:

- Outer packaging of device
  - Stretch wrap made of polymer in accordance with EU Directive 2002/95/EC (RoHS)
- Packaging
  - Wood crate treated in accordance with ISPM 15 standard, confirmed by IPPC logo
  - Cardboard box in accordance with European packaging guideline 94/62/EC, recyclability confirmed by Resy symbol
- Transport material and fastening fixtures
  - Disposable plastic pallet
  - Plastic straps
  - Plastic adhesive strips
- Filler material
  - Paper pads

## 6 Installation

### 6.1 Installation requirements

#### 6.1.1 Installation position

##### Mounting location

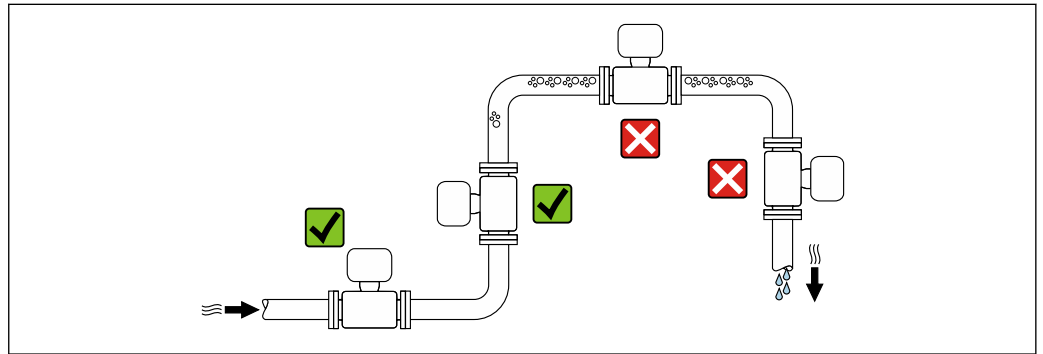

A0028772

To avoid measurement errors caused by gas bubble formation in the measuring tube, avoid the following installation locations in the pipe:

- Highest point of a pipeline
- Directly upstream of a free pipe outlet in a down pipe

##### Installation in down pipes

However, the following installation suggestion allows for installation in an open vertical pipeline. Pipe restrictions or the use of an orifice with a smaller cross-section than the nominal diameter prevent the sensor running empty while measurement is in progress.

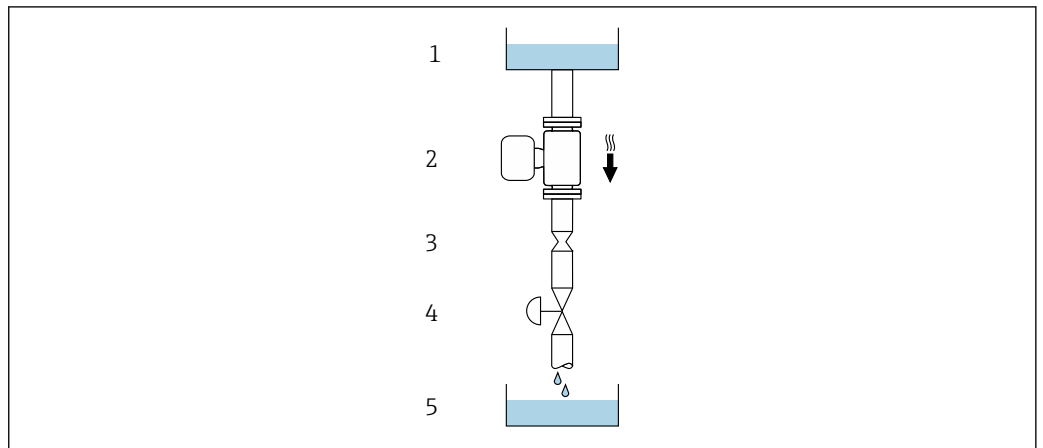

A0028773



4 Installation in a down pipe (e.g. for batching applications)

- 1 Supply tank
- 2 Sensor
- 3 Orifice plate, pipe restriction
- 4 Valve
- 5 Filling container

DN/NPS		Ø orifice plate, pipe restriction	
[mm]	[in]	[mm]	[in]
1	1/24	0.8	0.03
2	1/12	1.5	0.06
4	1/8	3.0	0.12
6	1/4	5.0	0.20

**Orientation**

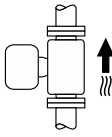
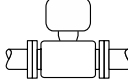
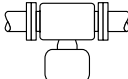
The direction of the arrow on the sensor nameplate helps you to install the sensor according to the flow direction (direction of medium flow through the piping).

Orientation			Recommendation
<b>A</b>	Vertical orientation	 A0015591	☑☑
<b>B</b>	Horizontal orientation, transmitter at top	 A0015589	☑☑ <sup>1)</sup>
<b>C</b>	Horizontal orientation, transmitter at bottom	 A0015590	☑☑ <sup>2)</sup>
<b>D</b>	Horizontal orientation, transmitter at side	 A0015592	☒

- 1) Applications with low process temperatures may reduce the ambient temperature. To maintain the minimum ambient temperature for the transmitter, this orientation is recommended.
- 2) Applications with high process temperatures may increase the ambient temperature. To maintain the maximum ambient temperature for the transmitter, this orientation is recommended.

**Inlet and outlet runs**

No special precautions need to be taken for fittings that create turbulence, such as valves, elbows or T-pieces, as long as no cavitation occurs → 21.

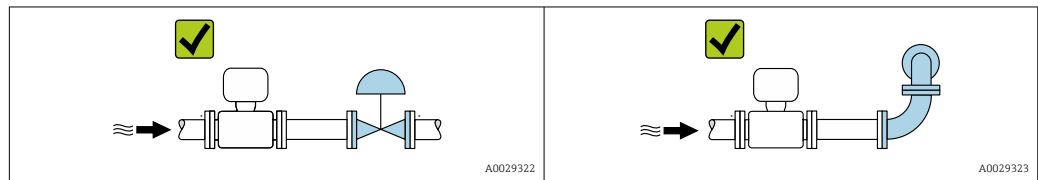

*Installation dimensions*

 For the dimensions and installed lengths of the device, see the "Technical Information" document, "Mechanical construction" section

## 6.1.2 Environmental and process requirements

### Ambient temperature range

Measuring instrument	<ul style="list-style-type: none"> <li>■ -40 to +60 °C (-40 to +140 °F)</li> <li>■ Order code for "Test, certificate", option JM: -50 to +60 °C (-58 to +140 °F)</li> </ul>
----------------------	---

- ▶ If operating outdoors:  
Avoid direct sunlight, particularly in warm climatic regions.

### Static pressure

It is important that cavitation does not occur, or that gases entrained in the liquids do not outgas.

Cavitation is caused if the pressure drops below the vapor pressure:

- In liquids that have a low boiling point (e.g. hydrocarbons, solvents, liquefied gases)
- In suction lines
- ▶ Ensure the static pressure is sufficiently high to prevent cavitation and outgassing.

For this reason, the following mounting locations are recommended:

- At the lowest point in a vertical pipe
- Downstream from pumps (no danger of vacuum)

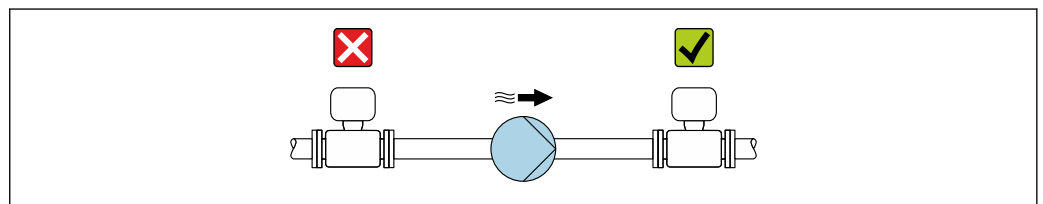

A0028777

### Thermal insulation

In the case of some fluids, it is important to keep the heat radiated from the sensor to the transmitter to a low level. A wide range of materials can be used for the required insulation.

#### NOTICE

#### Electronics overheating on account of thermal insulation!

- ▶ Recommended orientation: horizontal orientation, transmitter housing pointing downwards.
- ▶ Do not insulate the transmitter housing .
- ▶ Maximum permissible temperature at the lower end of the transmitter housing: 80 °C (176 °F)
- ▶ Thermal insulation with exposed extension neck: We recommend that you do not insulate the extension neck in order to ensure optimum dissipation of heat.

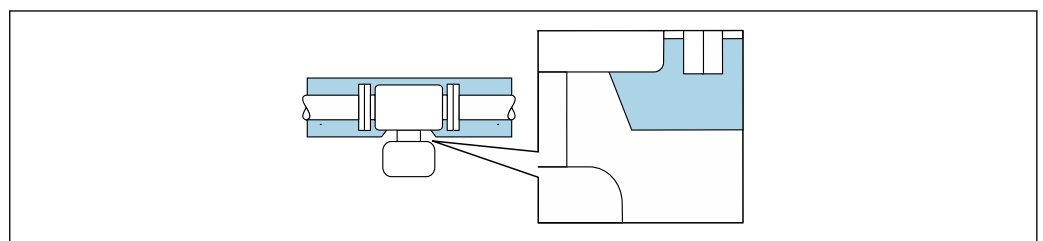

A0034391

5 Thermal insulation with exposed extension neck

## Heating

### NOTICE

#### Electronics can overheat due to elevated ambient temperature!

- ▶ Observe maximum permitted ambient temperature for the transmitter.
- ▶ Depending on the medium temperature, take the device orientation requirements into account.

### NOTICE

#### Danger of overheating when heating

- ▶ Ensure that the temperature at the lower end of the transmitter housing does not exceed 80 °C (176 °F).
- ▶ Ensure that sufficient convection takes place at the transmitter neck.
- ▶ Ensure that a sufficiently large area of the transmitter neck remains exposed. The uncovered part serves as a radiator and protects the electronics from overheating and excessive cooling.
- ▶ When using in potentially explosive atmospheres, observe the information in the device-specific Ex documentation. For detailed information on the temperature tables, see the separate document entitled "Safety Instructions" (XA) for the device.

#### Heating options

If a medium requires that no heat loss should occur at the sensor, users can avail of the following heating options:

- Electrical heating, e.g. with electric band heaters <sup>1)</sup>
- Via pipes carrying hot water or steam
- Via heating jackets

## Vibrations

The high oscillation frequency of the measuring tubes ensures that the correct operation of the measuring system is not influenced by plant vibrations.

## 6.1.3 Special installation instructions

### Hygienic compatibility

 When installing in hygienic applications, please refer to the information in the "Certificates and approvals/hygienic compatibility" section

### Rupture disk

Process-related information: →  115.

### WARNING

#### Danger from medium escaping!

Medium escaping under pressure can cause injury or material damage.

- ▶ Take precautions to prevent danger to persons and damage if the rupture disk is actuated.
- ▶ Observe the information on the rupture disk sticker.
- ▶ Make sure that the function and operation of the rupture disk is not impeded through the installation of the device.
- ▶ Do not use a heating jacket.
- ▶ Do not remove or damage the rupture disk.

The position of the rupture disk is indicated by a sticker affixed beside it.

---

1) The use of parallel electric band heaters is generally recommended (bidirectional electricity flow). Particular considerations must be made if a single-wire heating cable is to be used. Additional information is provided in the document EA01339D "Installation instructions for electrical trace heating systems".

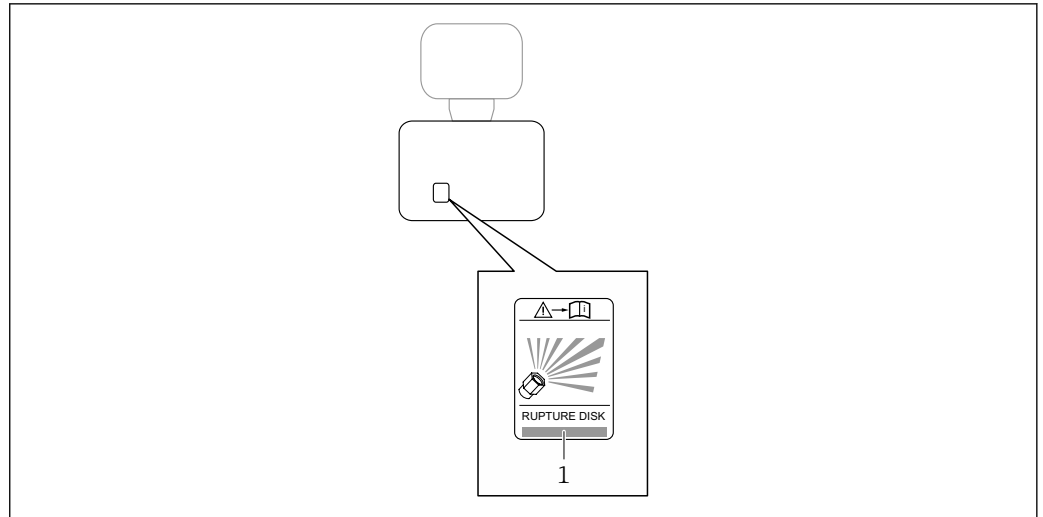

A0029940

1 Rupture disk label

### Zero point verification and zero adjustment

All measuring instruments are calibrated in accordance with state-of-the-art technology. Calibration takes place under reference conditions → 110. Therefore, a zero adjustment in the field is generally not required.

Experience shows that zero adjustment is advisable only in special cases:

- To achieve maximum measurement accuracy even with low flow rates.
- Under extreme process or operating conditions (e.g. very high process temperatures or very high-viscosity media).
- For gas applications with low pressure.

**i** To achieve the highest possible measurement accuracy at low flow rates, the installation must protect the sensor from mechanical stress during operation.

To get a representative zero point, ensure that

- any flow in the device is prevented during the adjustment
- the process conditions (e.g. pressure, temperature) are stable and representative

Verification and adjustment cannot be performed if the following process conditions are present:

- Gas pockets

Ensure that the system has been sufficiently flushed with the medium. Repeat flushing can help to eliminate gas pockets

- Thermal circulation

In the event of temperature differences (e.g. between the measuring tube inlet and outlet section), induced flow can occur even if the valves are closed due to thermal circulation in the device

- Leaks at the valves

If the valves are not leak-tight, flow is not sufficiently prevented when determining the zero point

If these conditions cannot be avoided, it is advisable to keep the factory setting for the zero point.

### Wall mounting

#### **⚠ WARNING**

#### **Incorrect sensor mounting**

Risk of injury if measuring tube breaks

- ▶ The sensor should never be installed in a pipe in a way that it is freely suspended
- ▶ Using the base plate, mount the sensor directly on the floor, wall or ceiling.
- ▶ Support the sensor on a securely mounted support base (e.g. angle bracket).

The following mounting versions are recommended for the installation.

**Vertical**

- Mounted directly on a wall using the base plate, or
- Device supported on an angle bracket mounted on the wall

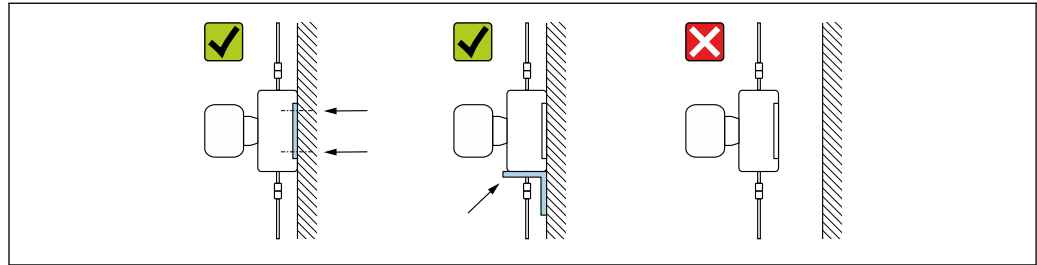

A0030286

**Horizontal**

Device standing on a solid support base

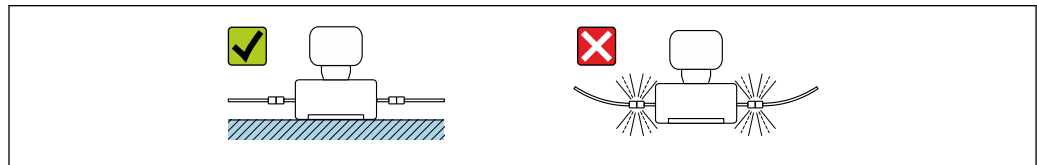

A0030287

**Mounting plate**

The universal mounting plate can be used to affix or place the unit on a flat surface (order code for "Accessories", option PA).

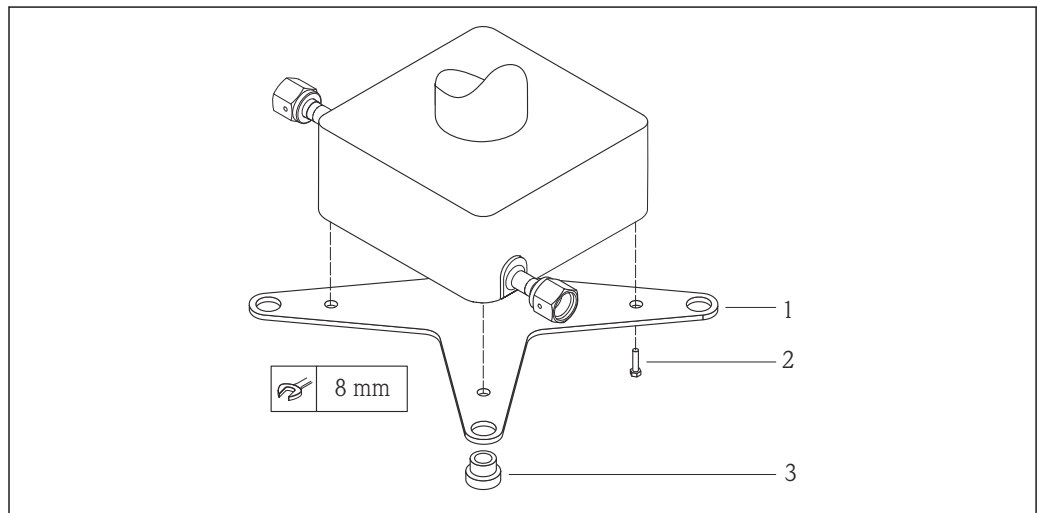

A0019768

■ 6 Mounting kit for Cubemass mounting plate

- 1 1 x Cubemass mounting plate
- 2 4 x screw M5 x 8
- 3 4 x grommet

## 6.2 Installing the device

### 6.2.1 Required tools

#### For sensor

For flanges and other process connections: Use a suitable mounting tool.

### 6.2.2 Preparing the measuring instrument

1. Remove all remaining transport packaging.
2. Remove any protective covers or protective caps present from the sensor.
3. Remove stick-on label on the electronics compartment cover.

### 6.2.3 Installing the measuring instrument

#### **⚠ WARNING**

#### **Danger due to improper process sealing!**

- ▶ Ensure that the inside diameters of the gaskets are greater than or equal to that of the process connections and piping.
- ▶ Ensure that the seals and sealing surfaces are clean and undamaged.
- ▶ Secure the seals correctly.

1. Ensure that the direction of the arrow on the nameplate of the sensor matches the flow direction of the medium.
2. Install the measuring instrument or turn the transmitter housing so that the cable entries do not point upwards.

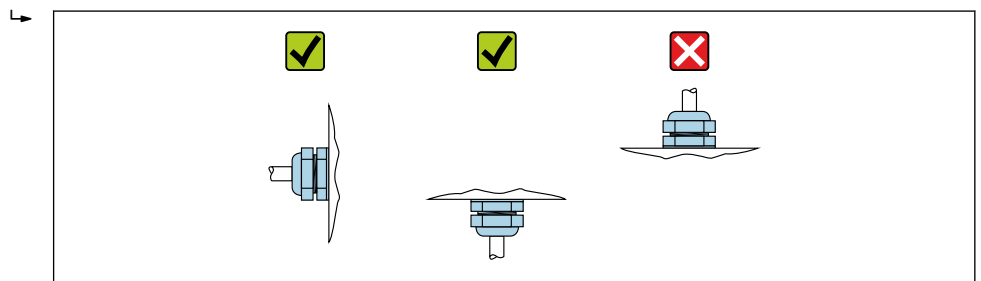

A0029263

### 6.2.4 Turning the display module

The local display is only available with the following device version:  
Order code for "Display; Operation", option **B**: 4-line; lit, via communication

The display module can be turned to optimize display readability.

**Aluminum housing version, AlSi10Mg, coated**

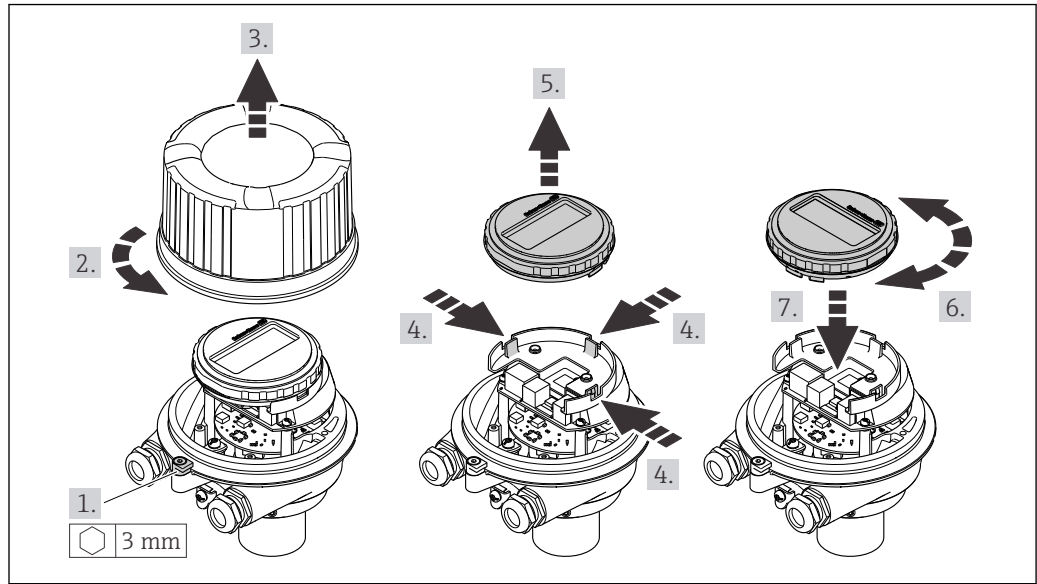

A0023192

**Compact and ultra-compact housing version, hygienic, stainless**

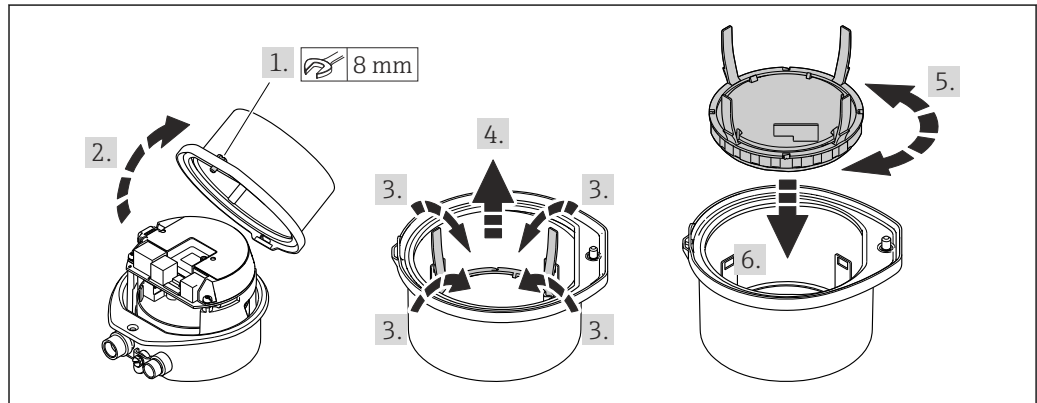

A0023195

**6.3 Post-installation check**

Is the device undamaged (visual inspection)?	<input type="checkbox"/>
Does the measuring instrument correspond to the measuring point specifications? For example: <ul style="list-style-type: none"> <li>■ Process temperature → 114</li> <li>■ Pressure (refer to the "Pressure-temperature ratings" section of the "Technical Information" document).</li> <li>■ Ambient temperature → 113</li> <li>■ Measuring range</li> </ul>	<input type="checkbox"/>
Has the correct orientation for the sensor been selected → 20? <ul style="list-style-type: none"> <li>■ According to sensor type</li> <li>■ According to medium temperature</li> <li>■ According to medium properties (outgassing, with entrained solids)</li> </ul>	<input type="checkbox"/>
Does the arrow on the sensor match the direction of flow of the medium? → 20?	<input type="checkbox"/>
Is the tag name and labeling correct (visual inspection)?	<input type="checkbox"/>
Is the device sufficiently protected from precipitation and direct sunlight?	<input type="checkbox"/>
Are the securing screw and securing clamp tightened securely?	<input type="checkbox"/>

## 7 Electrical connection

### WARNING

**Live parts! Incorrect work performed on the electrical connections can result in an electric shock.**

- ▶ Set up a disconnecting device (switch or power-circuit breaker) to easily disconnect the device from the supply voltage.
- ▶ In addition to the device fuse, include an overcurrent protection unit with max. 16 A in the plant installation.

### 7.1 Electrical safety

In accordance with applicable national regulations.

### 7.2 Connecting requirements

#### 7.2.1 Required tools

- For cable entries: Use corresponding tools
- For securing clamp (on aluminum housing): Allen screw 3 mm
- For securing screw (for stainless steel housing): open-ended wrench 8 mm
- Wire stripper
- When using stranded cables: crimper for wire end ferrule

#### 7.2.2 Requirements for connection cable

The connecting cables provided by the customer must fulfill the following requirements.

##### Permitted temperature range

- The installation guidelines that apply in the country of installation must be observed.
- The cables must be suitable for the minimum and maximum temperatures to be expected.

##### Power supply cable (incl. conductor for the inner ground terminal)

Standard installation cable is sufficient.

##### Signal cable

*Pulse/frequency/switch output*

Standard installation cable is sufficient.

*EtherNet/IP*

Twisted-pair Ethernet CAT 5 or better.



See <https://www.odva.org> "EtherNet/IP Media Planning & Installation Manual".

##### Cable diameter

- Cable glands supplied:  
M20 × 1.5 with cable  $\varnothing$  6 to 12 mm (0.24 to 0.47 in)
- Spring terminals:  
Wire cross-sections 0.5 to 2.5 mm<sup>2</sup> (20 to 14 AWG)

### 7.2.3 Terminal assignment

#### Transmitter

*EtherNet/IP connection version*

Order code for "Output", option **N**

Depending on the housing version, the transmitters can be ordered with terminals or device plugs.

Order code for "Housing"	Connection methods available		Possible options for order code "Electrical connection"
	Output	Power supply	
Options <b>A, B</b>	Device plug → 29	Terminals	<ul style="list-style-type: none"> <li>▪ Option <b>L</b>: plug M12x1 + thread NPT ½"</li> <li>▪ Option <b>N</b>: plug M12x1 + coupling M20</li> <li>▪ Option <b>P</b>: plug M12x1 + thread G ½"</li> <li>▪ Option <b>U</b>: plug M12x1 + thread M20</li> </ul>
Options <b>A, B, C</b>	Device plug → 29	Device plug → 29	Option <b>Q</b> : 2 x plug M12x1
Order code for "Housing": <ul style="list-style-type: none"> <li>▪ Option <b>A</b>: compact, coated aluminum</li> <li>▪ Option <b>B</b>: compact, hygienic, stainless</li> <li>▪ Option <b>C</b>: ultra-compact, hygienic, stainless</li> </ul>			

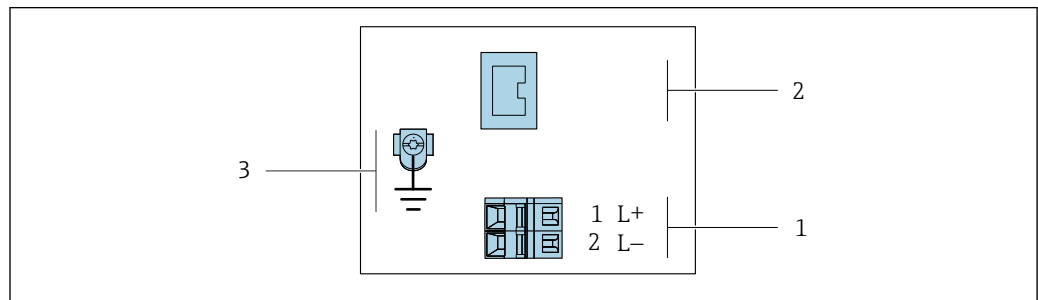

A0017054

7 EtherNet/IP terminal assignment

- 1 Power supply: DC 24 V
- 2 EtherNet/IP
- 3 Connection for cable shield (IO signals) if present and/or protective ground from the supply voltage if present. Not for option C "Ultra-compact, hygienic, stainless".

Order code for "Output"	Terminal number		Output Device plug M12x1
	Power supply 2 (L-)	1 (L+)	
Option <b>N</b>	DC 24 V		EtherNet/IP
Order code for "Output": Option <b>N</b> : EtherNet/IP			

### 7.2.4 Pin assignment, device plug

#### Supply voltage

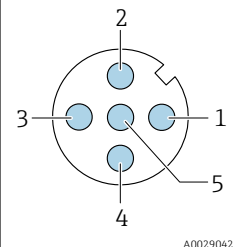
	Pin	Assignment	
	1	L+	DC 24 V
	2		Not used
	3		Not used
	4	L-	DC 24 V
	5		Grounding/shielding <sup>1)</sup>
Coding		Plug/socket	
A		Plug	

- 1) Connection for protective ground and/or shielding from the supply voltage if present. Not for option C "Ultra-compact, hygienic, stainless". Note: There is a metallic connection between the union nut of the M12 cable and the transmitter housing.

#### Device plug for signal transmission (device side)

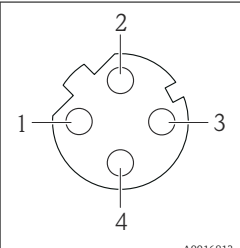
	Pin	Assignment	
	1	+	Tx
	2	+	Rx
	3	-	Tx
	4	-	Rx
	Coding		Plug/socket
D		Socket	

### 7.2.5 Preparing the device

#### NOTICE

#### Insufficient sealing of the housing!

Operational reliability of the measuring device could be compromised.

- ▶ Use suitable cable glands corresponding to the degree of protection.

1. Remove dummy plug if present.
2. If the measuring instrument is supplied without cable glands:  
Provide suitable cable gland for corresponding connecting cable.
3. If the measuring instrument is supplied with cable glands:  
Observe requirements for connecting cables →  27.

## 7.3 Connecting the device

#### NOTICE

#### An incorrect connection compromises electrical safety!

- ▶ Only properly trained specialist staff may perform electrical connection work.
- ▶ Observe applicable federal/national installation codes and regulations.
- ▶ Comply with local workplace safety regulations.
- ▶ Always connect the protective ground cable  before connecting additional cables.
- ▶ When using in potentially explosive atmospheres, observe the information in the device-specific Ex documentation.

### 7.3.1 Connecting the transmitter

The connection of the transmitter depends on the following order codes:

- Housing version: compact or ultra-compact
- Connection version: device plug or terminals

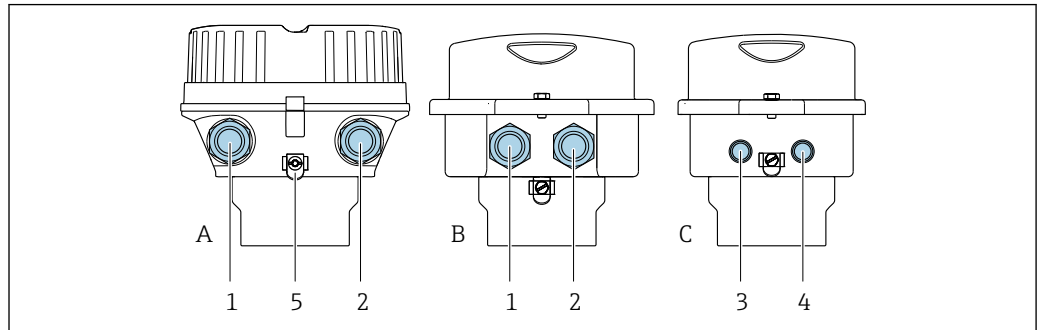

A0016924

#### 8 Housing versions and connection versions

A Housing version: compact, coated, aluminum

B Housing version: compact, hygienic, stainless

C Housing version: ultra-compact, hygienic, stainless

1 Cable entry or device plug for signal transmission

2 Cable entry or device plug for supply voltage

3 Device plug for signal transmission

4 Device plug for supply voltage

5 Ground terminal. Cable lugs, pipe clips or ground disks are recommended for optimization of the grounding/shielding.

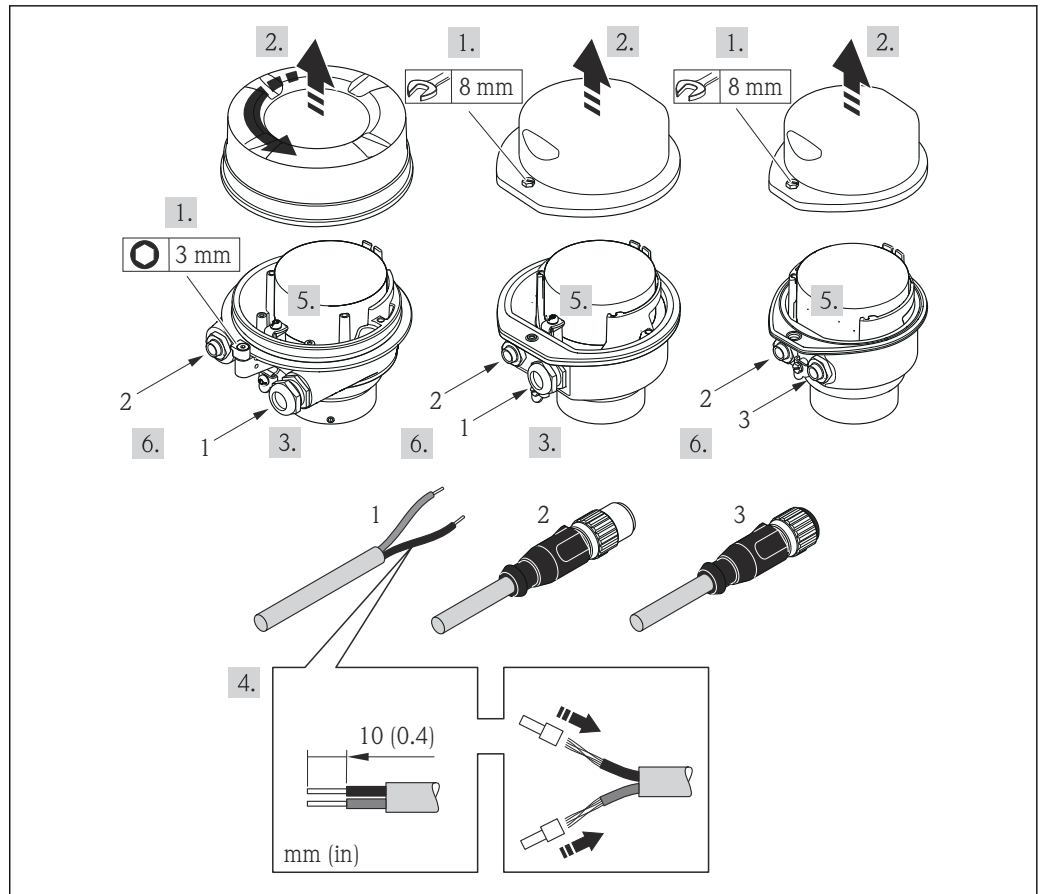

9 Device versions with connection examples

- 1 Cable
- 2 Device plug for signal transmission
- 3 Device plug for supply voltage

For device version with device plug: follow step 6 only.

1. Depending on the housing version, loosen the securing clamp or fixing screw of the housing cover.
2. Depending on the housing version, unscrew or open the housing cover and disconnect the local display from the main electronics module where necessary → 119.
3. Push the cable through the cable entry . To ensure tight sealing, do not remove the sealing ring from the cable entry.
4. Strip the cable and cable ends. In the case of stranded cables, also fit wire end ferrules.
5. Connect the cable in accordance with the terminal assignment or the device plug pin assignment .
6. Depending on the device version, tighten the cable glands or insert the device plug and tighten .
7. **NOTICE**  
**Housing degree of protection voided due to insufficient sealing of the housing.**
  - ▶ Screw in the screw without using any lubricant. The threads on the cover are coated with a dry lubricant.

Reassemble the transmitter in the reverse order.

## 7.4 Potential equalization

### 7.4.1 Requirements

For potential equalization:

- Pay attention to in-house grounding concepts
- Take account of operating conditions like the pipe material and grounding
- Connect the medium, sensor and transmitter to the same electric potential
- Use a ground cable with a minimum cross-section of 6 mm<sup>2</sup> (10 AWG) and a cable lug for potential equalization connections

## 7.5 Special connection instructions

### 7.5.1 Connection examples

#### Pulse output/frequency output/switch output

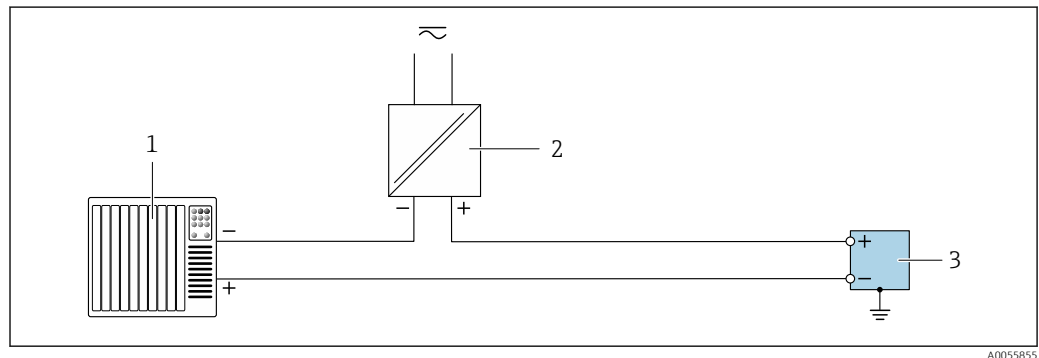

10 Connection example for pulse output/frequency output/switch output (passive)

- 1 Automation system with pulse input/frequency input/switch input (e.g. PLC)
- 2 Power supply
- 3 Transmitter with pulse output/frequency output/switch output (passive)

### EtherNet/IP

See <https://www.odva.org> "EtherNet/IP Media Planning & Installation Manual".

## 7.6 Hardware settings

### 7.6.1 Setting the device address

#### EtherNet/IP

The IP address of the measuring device can be configured for the network via DIP switches.

#### Addressing data

IP address and configuration options			
1st octet	2nd octet	3rd octet	4th octet
192.	168.	1.	XXX

↓  
Can only be configured via software addressing

↓  
Can be configured via software addressing and hardware addressing

<b>IP address range</b>	1 to 254 (4th octet)
<b>IP address broadcast</b>	255
<b>Addressing mode ex works</b>	Software addressing; all DIP switches for hardware addressing are set to OFF.
<b>IP address ex works</b>	DHCP server active

 For device addressing via software

### Setting the address

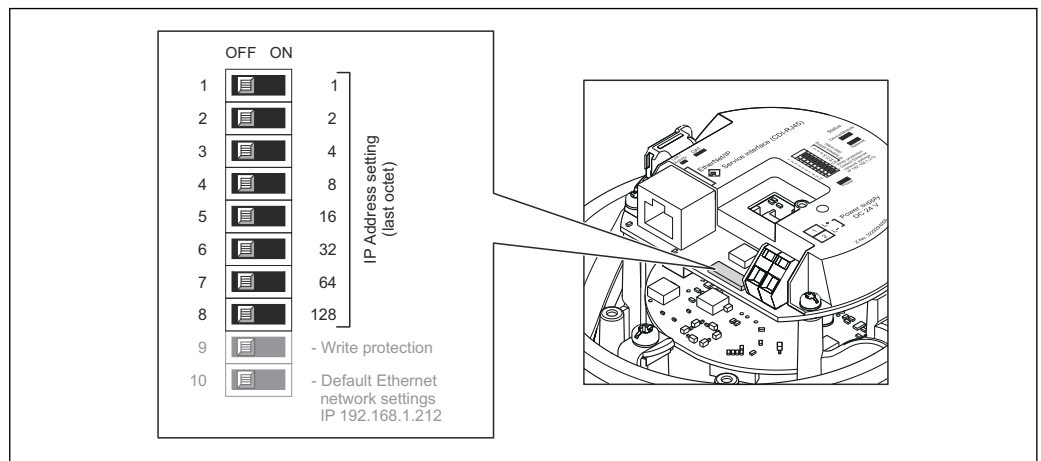

1. Depending on the housing version, loosen the securing clamp or fixing screw of the housing cover.
2. Depending on the housing version, unscrew or open the housing cover and disconnect the local display from the main electronics module where necessary →  119.
3. Set the desired IP address using the corresponding DIP switches on the I/O electronics module.
  - ↳ Hardware addressing with the configured IP address is enabled after 10 s.
4. Reverse the removal procedure to reassemble the transmitter.

## 7.7 Ensuring the degree of protection

The measuring instrument fulfills all the requirements for the degree of protection IP66/67, Type 4X enclosure.

To ensure degree of protection IP66/67, Type 4X enclosure, carry out the following steps after making the electrical connection:

1. Check that the housing seals are clean and fitted correctly.
2. Dry, clean or replace the seals if necessary.
3. Tighten all housing screws and screw covers.
4. Firmly tighten the cable glands.

5. To ensure that moisture does not enter the cable entry:  
Route the cable so that it loops down before the cable entry ("water trap").

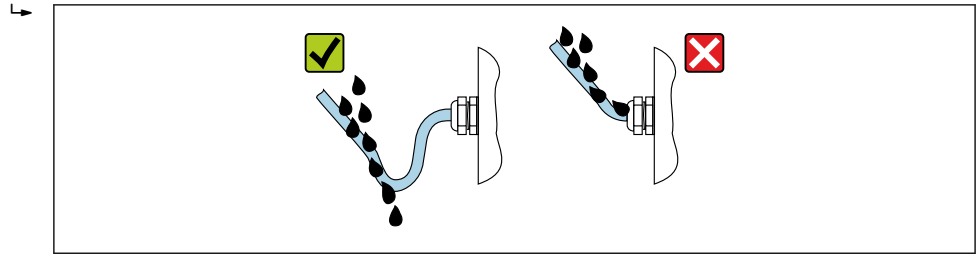

A0029278

6. The supplied cable glands and plastic dummy plugs used for the threaded cable entries do not ensure degree of protection IP66/67, Type 4X enclosure. To achieve this degree of protection, cable glands and plastic dummy plugs that are not used must be replaced by threaded dummy plugs with the degree of protection IP66/67, Type 4X enclosure.

## 7.8 Post-connection check

Are the device and cable undamaged (visual inspection)?	<input type="checkbox"/>
Do the cables used meet the requirements → 27?	<input type="checkbox"/>
Are the mounted cables strain-relieved and fixed securely in place?	<input type="checkbox"/>
Are all cable glands installed, securely tightened and leak-tight? Cable run with "water trap" → 33?	<input type="checkbox"/>
Depending on the device version: Are all the device plugs firmly tightened → 30?	<input type="checkbox"/>
Does the supply voltage match the specifications on the transmitter nameplate → 109?	<input type="checkbox"/>
Is the terminal assignment → 28 or the device plug pin assignment → 29 correct?	<input type="checkbox"/>
If supply voltage is present: Is the power LED on the electronics module of the transmitter lit green → 12?	<input type="checkbox"/>
Depending on the device version: <ul style="list-style-type: none"> <li>▪ Have the fixing screws been tightened with the correct tightening torque?</li> <li>▪ Is the securing clamp securely tightened?</li> </ul>	<input type="checkbox"/>

## 8 Operation options

### 8.1 Overview of operation options

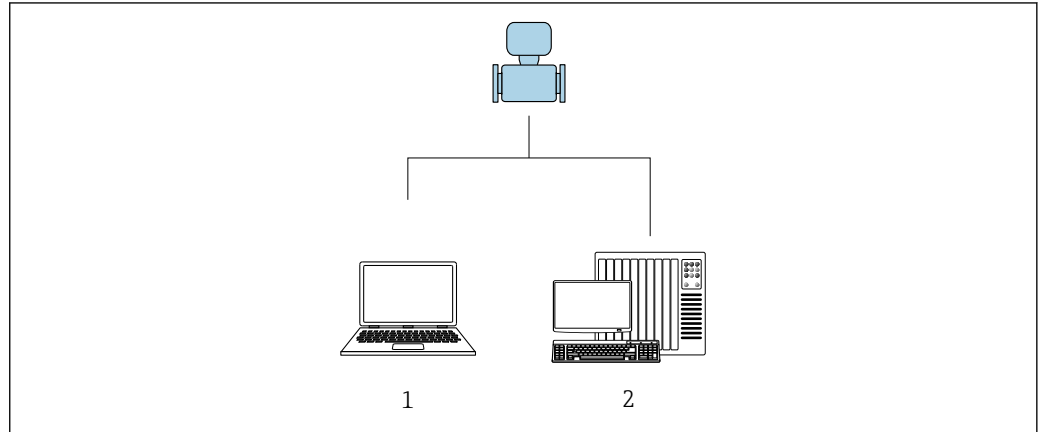



A0017760

- 1 Computer with web browser or with "FieldCare" operating tool
- 2 Automation system, e.g. "RSLogix" (Rockwell Automation) and work station for measuring instrument operation with Add-on Profile Level 3 for "RSLogix 5000" software (Rockwell Automation)

## 8.2 Structure and function of the operating menu

### 8.2.1 Structure of the operating menu

 For an overview of the operating menu for experts: see the "Description of Device Parameters" document supplied with the device →  124

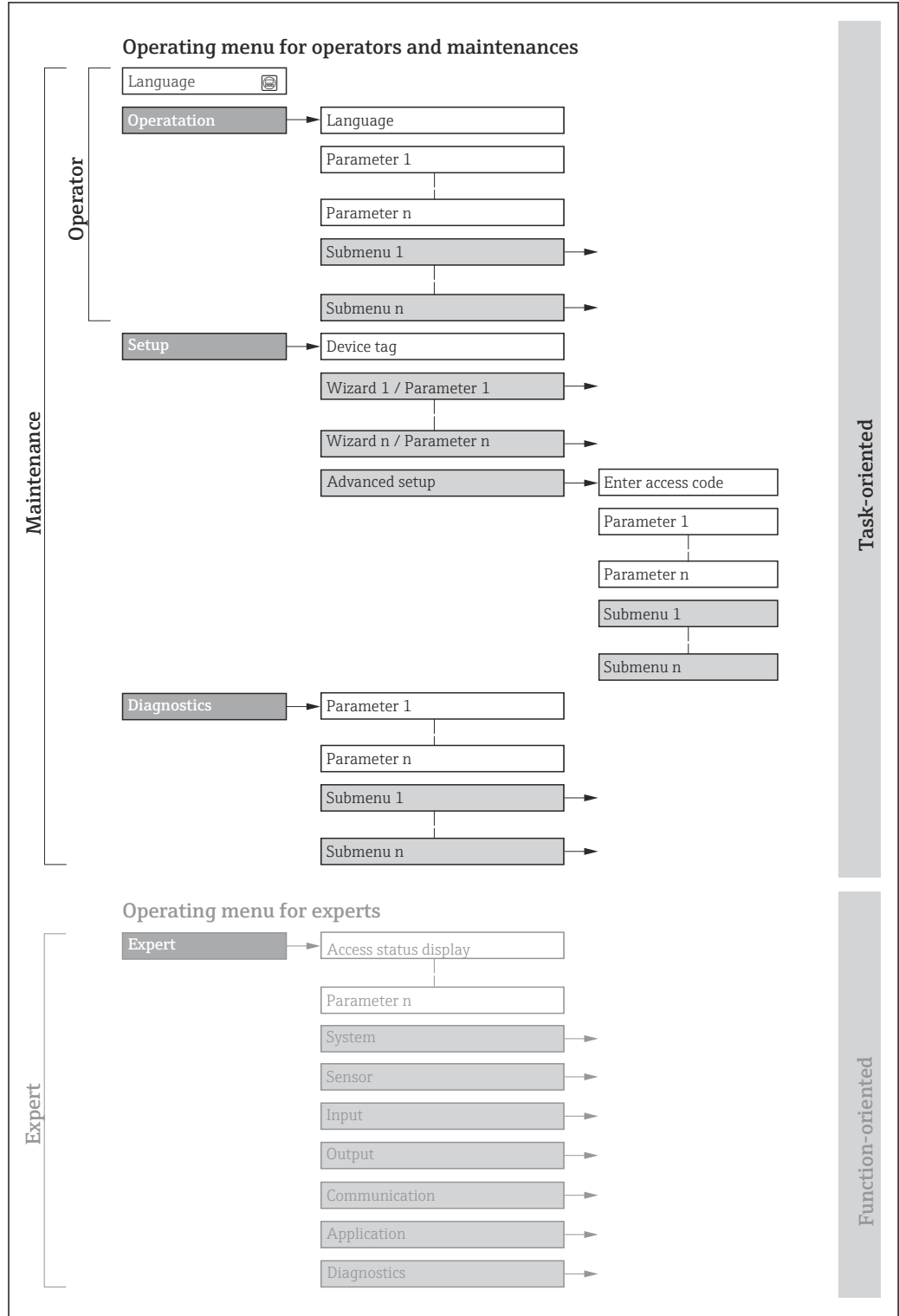

 11 Schematic structure of the operating menu

A0018237-EN

### 8.2.2 Operating philosophy

The individual parts of the operating menu are assigned to certain user roles (e.g. operator, maintenance etc.). Each user role contains typical tasks within the device life cycle.

Menu/parameter		User role and tasks	Content/meaning
Language	Task-oriented	<b>Role "Operator", "Maintenance"</b> Tasks during operation: <ul style="list-style-type: none"> <li>▪ Configuring the operational display</li> <li>▪ Reading measured values</li> </ul>	Defining the operating language
Operation			<ul style="list-style-type: none"> <li>▪ Defining the operating language</li> <li>▪ Defining the web server operating language</li> <li>▪ Resetting and controlling totalizers</li> <li>▪ Configuring the operational display (e.g. display format, display contrast)</li> <li>▪ Resetting and controlling totalizers</li> </ul>
Setup		<b>"Maintenance" role</b> Commissioning: <ul style="list-style-type: none"> <li>▪ Configuring the measurement</li> <li>▪ Configuring the communication interface</li> </ul>	Submenus for fast commissioning: <ul style="list-style-type: none"> <li>▪ Configuring the system units</li> <li>▪ Defining the medium</li> <li>▪ Configuring the digital communication interface</li> <li>▪ Configuring the operational display</li> <li>▪ Configuring the low flow cut off</li> <li>▪ Configuring the detection of partially filled and empty pipes</li> </ul> Advanced setup <ul style="list-style-type: none"> <li>▪ For more customized configuration of the measurement (adaptation to special measuring conditions)</li> <li>▪ Configuring totalizers</li> <li>▪ Administration (define access code, reset measuring instrument)</li> </ul>
Diagnostics		<b>"Maintenance" role</b> Troubleshooting: <ul style="list-style-type: none"> <li>▪ Diagnostics and elimination of process and device errors</li> <li>▪ Measured value simulation</li> </ul>	Contains all parameters for error detection and analyzing process and device errors: <ul style="list-style-type: none"> <li>▪ Diagnostic list Contains up to 5 currently pending diagnostic messages.</li> <li>▪ Event logbook Contains event messages that have occurred.</li> <li>▪ Device information Contains information for identifying the device.</li> <li>▪ Measured values Contains all current measured values.</li> <li>▪ Heartbeat Technology The functionality of the device is checked on demand and the verification results are documented.</li> <li>▪ Simulation Used to simulate measured values or output values.</li> <li>▪ Testpoints</li> </ul>
Expert	Function-oriented	Tasks that require detailed knowledge of the function of the device: <ul style="list-style-type: none"> <li>▪ Commissioning measurements under difficult conditions</li> <li>▪ Optimal adaptation of the measurement to difficult conditions</li> <li>▪ Detailed configuration of the communication interface</li> <li>▪ Error diagnostics in difficult cases</li> </ul>	Contains all the parameters of the device and makes it possible to access these parameters directly using an access code. The structure of this menu is based on the function blocks of the device: <ul style="list-style-type: none"> <li>▪ System Contains all higher-level device parameters that do not affect measurement or measured value communication.</li> <li>▪ Sensor Configuring the measurement.</li> <li>▪ Communication Configuring the digital communication interface and the web server.</li> <li>▪ Application Configuring the functions that go beyond the actual measurement (e.g. totalizer).</li> <li>▪ Diagnostics Error detection and analysis of process and device errors and for device simulation and the Heartbeat Technology menu.</li> </ul>

## 8.3 Displaying the measured values via the local display (optionally available)

### 8.3.1 Operational display

 The local display is optionally available:

Order code for "Display; operation", option B "4-line, illuminated; via communication".

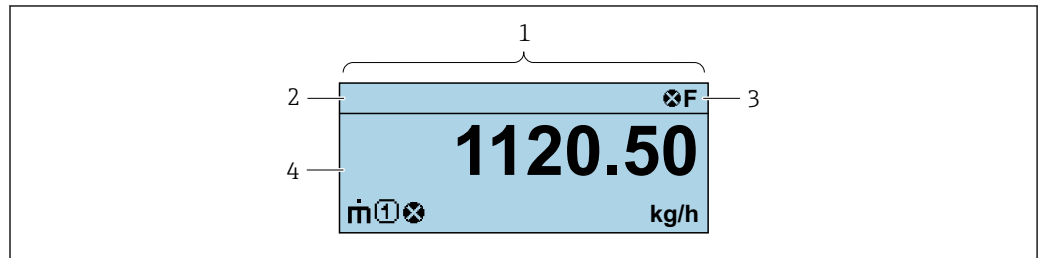





A0037831

- 1 Operational display
- 2 Tag name
- 3 Status area
- 4 Display area for measured values (4-line)

#### Status area

The following symbols appear in the status area of the operational display at the top right:

- Status signals
  - **F**: Failure
  - **C**: Function check
  - **S**: Out of specification
  - **M**: Maintenance required
- Diagnostic behavior
  - : Alarm
  - : Warning
  - : Locking (the device is locked via the hardware )
  - : Communication (communication via remote operation is active)



#### Display area

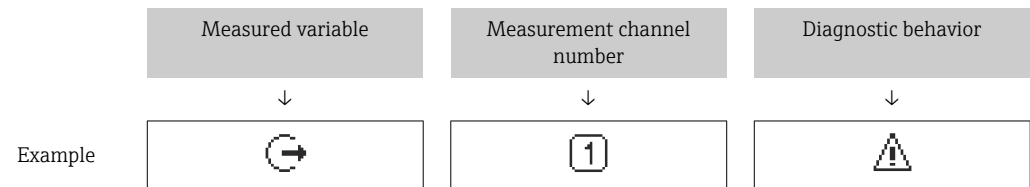





In the display area, each measured value is prefaced by certain symbol types for further description:



Appears only if a diagnostics event is present for this measured variable.

#### Measured variables

Symbol	Meaning
	Mass flow
	<ul style="list-style-type: none"> <li>▪ Volume flow</li> <li>▪ Corrected volume flow</li> </ul>

	<ul style="list-style-type: none"> <li>▪ Density</li> <li>▪ Reference density</li> </ul>
	Temperature
	Totalizer  The measurement channel number indicates which of the three totalizers is displayed.
	Output 

*Measurement channel numbers*

Symbol	Meaning
	Measurement channel 1 to 4
The measurement channel number is displayed only if more than one channel is present for the same measured variable type (e.g. Totalizer 1 to 3).	

*Diagnostic behavior*

The diagnostic behavior pertains to a diagnostic event that is relevant to the displayed measured variable. For information on the symbols

 The number and display format of the measured values can only be configured via the control system or Web server.

### 8.3.2 User roles and related access authorization

The two user roles "Operator" and "Maintenance" have different write access to the parameters if the customer defines a user-specific access code. This protects the device configuration from unauthorized access .

#### Defining access authorization for user roles

An access code is not yet defined when the device is delivered from the factory. Access authorization (read and write access) to the device is not restricted and corresponds to the "Maintenance" user role.

- ▶ Define the access code.
  - ↳ The "Operator" user role is redefined in addition to the "Maintenance" user role. Access authorization differs for the two user roles.

*Access authorization to parameters: "Maintenance" user role*

Access code status	Read access	Write access
An access code has not yet been defined (factory setting).	✓	✓
After an access code has been defined.	✓	✓ <sup>1)</sup>

1) The user only has write access after entering the access code.

*Access authorization to parameters: "Operator" user role*

Access code status	Read access	Write access
After an access code has been defined.	✓	– 1)

- 1) Despite the defined access code, certain parameters can always be modified and thus are excluded from the write protection as they do not affect the measurement: write protection via access code

 The user role with which the user is currently logged on is indicated by the .  
Navigation path:

## 8.4 Access to the operating menu via the web browser

### 8.4.1 Function range

The integrated web server can be used to operate and configure the device via a web browser service interface (CDI-RJ45) . In addition to the measured values, status information on the device is displayed and can be used to monitor device health. Furthermore the device data can be managed and the network parameters can be configured.



 For additional information on the web server, see the Special Documentation for the device.

### 8.4.2 Prerequisites

*Computer hardware*

Hardware	Interface	
	CDI-RJ45	WLAN
Interface	The computer must have an RJ45 interface.	The operating unit must have a WLAN interface.
Connection	Standard Ethernet cable with RJ45 connector.	Connection via Wireless LAN.
Display	Recommended size: ≥12" (depends on the screen resolution)	

*Computer software*





Software	Interface	
	CDI-RJ45	WLAN
Recommended operating systems	<ul style="list-style-type: none"> <li>▪ Microsoft Windows 8 or higher.</li> <li>▪ Mobile operating systems:                             <ul style="list-style-type: none"> <li>▪ iOS</li> <li>▪ Android</li> </ul> </li> </ul> <p> Microsoft Windows XP is supported.</p> <p> Microsoft Windows 7 is supported.</p>	
Web browsers supported	<ul style="list-style-type: none"> <li>▪ Microsoft Internet Explorer 8 or higher</li> <li>▪ Microsoft Edge</li> <li>▪ Mozilla Firefox</li> <li>▪ Google Chrome</li> <li>▪ Safari</li> </ul>	

*Computer settings*

User rights	Appropriate user rights (e.g. administrator rights) for TCP/IP and proxy server settings are necessary (for adjusting the IP address, subnet mask etc.).
Proxy server settings of the Web browser	The web browser setting <i>Use a Proxy Server for Your LAN</i> must be <b>deselected</b> .
JavaScript	JavaScript must be enabled.  If JavaScript cannot be enabled: Enter <code>http://XXX.XXX.X.XX/servlet/basic.html</code> in the address bar of the web browser, e.g. <code>http://192.168.1.212/servlet/basic.html</code> . A fully functional but simplified version of the operating menu structure starts in the web browser.
Network connections	Only the active network connections to the measuring device should be used. Switch off all other network connections.

 In the event of connection problems: →  76

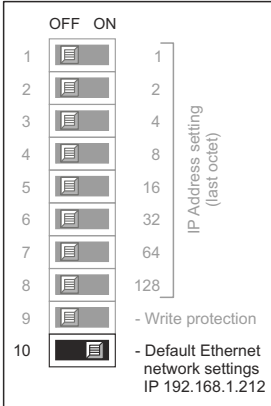
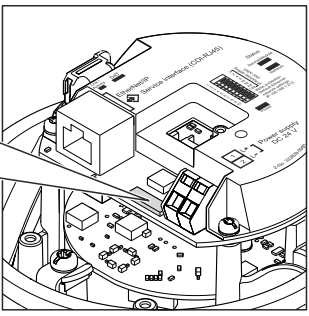
*Measuring device: Via CDI-RJ45 service interface*

Device	CDI-RJ45 service interface
Measuring device	The measuring device has an RJ45 interface.
Web server	Web server must be enabled; factory setting: ON  For information on enabling the Web server →  45
IP address	<p>If the IP address of the device is not known, communication with the Web server can be established via the default IP address 192.168.1.212. The DHCP function is enabled in the device at the factory, i.e. the device expects an IP address to be assigned by the network. This function can be disabled and the device can be set to the default IP address 192.168.1.212: set DIP switch No. 10 from <b>OFF</b> → <b>ON</b>.</p> <div style="display: flex; align-items: center;">   </div> <p style="text-align: right; font-size: small;">A0017965</p> <p> <ul style="list-style-type: none"> <li>▪ Once the DIP switch has been activated, the device must be restarted before the device uses the default IP address.</li> <li>▪ If the default IP address is used (DIP switch No. 10 = ON), there is no connection to the EtherNet/IP network.</li> </ul> </p>

### 8.4.3 Connecting the device

#### Via service interface (CDI-RJ45)

##### *Preparing the measuring device*

##### *Configuring the Internet protocol of the computer*

The IP address can be assigned to the measuring device in a variety of ways:

- Dynamic Host Configuration Protocol (DHCP), factory setting:  
The IP address is automatically assigned to the measuring device by the automation system (DHCP server).
- Hardware addressing:  
The IP address is set via DIP switches .
- Software addressing:  
The IP address is entered via the **IP address** parameter (→  59) .
- DIP switch for "Default IP address":  
To establish the network connection via the service interface (CDI-RJ45); the fixed IP address 192.168.1.212 is used .

The device works with the Dynamic Host Configuration Protocol (DHCP) ex-works, i.e. the IP address of the measuring device is automatically assigned by the automation system (DHCP server).

To establish a network connection via the service interface (CDI-RJ45): set the "Default IP address" DIP switch to **ON**. The measuring device then has the fixed IP address: 192.168.1.212. The fixed IP address 192.168.1.212 can now be used to establish the connection to the network.

1. Via DIP switch 2, activate the default IP address 192.168.1.212: .
2. Switch on the measuring device.
3. Connect the computer to the RJ45 plug via the standard Ethernet cable →  120.
4. If a 2nd network card is not used, close all the applications on the notebook.
  - ↳ Applications requiring Internet or a network, such as e-mail, SAP applications, Internet or Windows Explorer.
5. Close any open Internet browsers.
6. Configure the properties of the Internet protocol (TCP/IP) as defined in the table:

<b>IP address</b>	192.168.1.XXX; for XXX all numerical sequences except: 0, 212 and 255 → e.g. 192.168.1.213
<b>Subnet mask</b>	255.255.255.0
<b>Default gateway</b>	192.168.1.212 or leave cells empty

#### Starting the web browser

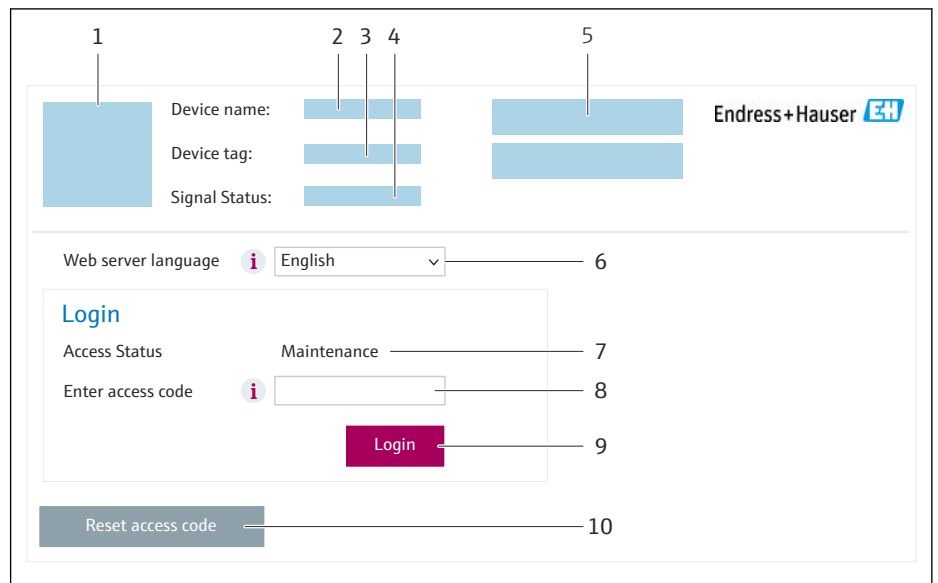

1. Start the web browser on the computer.

2. Enter the IP address of the web server in the address line of the web browser:  
192.168.1.212  
↳ The login page appears.



A0053670

- 1 Picture of device
- 2 Device name
- 3 Device tag
- 4 Status signal
- 5 Current measured values
- 6 Operating language
- 7 User role
- 8 Access code
- 9 Login
- 10 Reset access code

 If a login page does not appear, or if the page is incomplete →  76

### 8.4.4 Logging on

1. Select the preferred operating language for the Web browser.
2. Enter the user-specific access code.
3. Press **OK** to confirm your entry.

<b>Access code</b>	0000 (factory setting); can be changed by customer
--------------------	--

 If no action is performed for 10 minutes, the Web browser automatically returns to the login page.

### 8.4.5 User interface

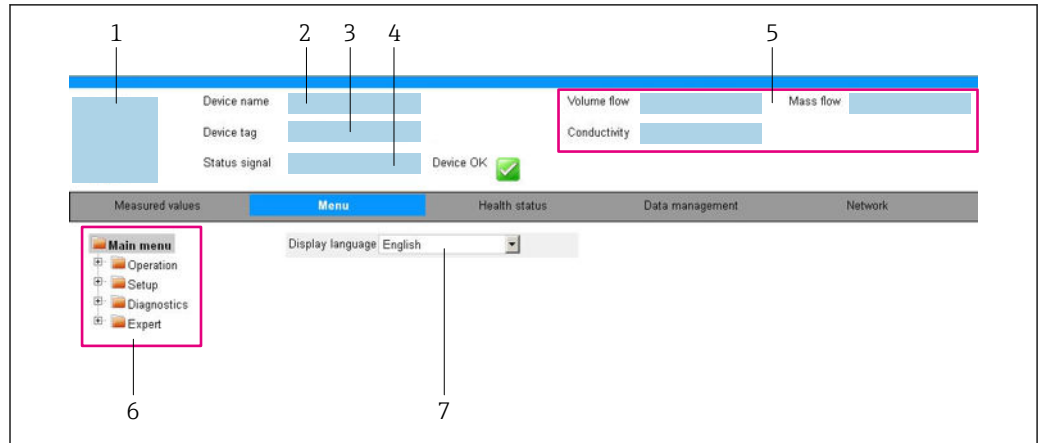

A0032879

- 1 Picture of device
- 2 Device name
- 3 Device tag
- 4 Status signal
- 5 Current measured values
- 6 Navigation area
- 7 Local display language

#### Header

The following information appears in the header:

- Device name
- Device tag
- Device status with status signal → 📄 78
- Current measured values

#### Function row

Functions	Meaning
Measured values	Displays the measured values of the measuring instrument
Menu	<ul style="list-style-type: none"> <li>■ Access to the operating menu from the measuring instrument</li> <li>■ The structure of the operating menu is the same as for the operating tools</li> </ul>  Detailed information on the "Description of Device Parameters" operating menu
Device status	Displays the diagnostic messages currently pending, listed in order of priority
Data management	Data exchange between computer and measuring instrument: <ul style="list-style-type: none"> <li>■ Device configuration:               <ul style="list-style-type: none"> <li>■ Load settings from the device (XML format, save configuration)</li> <li>■ Save settings to the device (XML format, restore configuration)</li> </ul> </li> <li>■ Logbook - Export Event logbook (.csv file)</li> <li>■ Documents - Export documents:               <ul style="list-style-type: none"> <li>■ Export backup data record (.csv file, create documentation of the measuring point configuration)</li> <li>■ Verification report (PDF file, only available with the "Heartbeat Verification" application package)</li> </ul> </li> <li>■ File for system integration - If using fieldbuses, upload device drivers for system integration from the measuring instrument: EtherNet/IP: EDS file</li> </ul>

Functions	Meaning
Network	Configuration and checking of all the parameters required for establishing the connection to the measuring instrument: <ul style="list-style-type: none"> <li>▪ Network settings (e.g. IP address, MAC address)</li> <li>▪ Device information (e.g. serial number, firmware version)</li> </ul>
Logout	End the operation and call up the login page

### Navigation area

The menus, the associated submenus and parameters can be selected in the navigation area.

### Working area

Depending on the selected function and the related submenus, various actions can be performed in this area:

- Configuring parameters
- Reading measured values
- Calling up help text
- Starting an upload/download

## 8.4.6 Disabling the Web server

The Web server of the measuring device can be switched on and off as required using the **Web server functionality** parameter.

### Navigation

"Expert" menu → Communication → Web server

### Parameter overview with brief description

Parameter	Description	Selection
Web server functionality	Switch the Web server on and off.	<ul style="list-style-type: none"> <li>▪ Off</li> <li>▪ On</li> </ul>

### Function scope of the "Web server functionality" parameter

Option	Description
Off	<ul style="list-style-type: none"> <li>▪ The Web server is completely disabled.</li> <li>▪ Port 80 is locked.</li> </ul>
On	<ul style="list-style-type: none"> <li>▪ The complete Web server functionality is available.</li> <li>▪ JavaScript is used.</li> <li>▪ The password is transferred in an encrypted state.</li> <li>▪ Any change to the password is also transferred in an encrypted state.</li> </ul>

### Enabling the Web server

If the Web server is disabled it can only be re-enabled with the **Web server functionality** parameter via the following operating options:

- Via Bedientool "FieldCare"
- Via "DeviceCare" operating tool

## 8.4.7 Logging out



Before logging out, perform a data backup via the **Data management** function (upload configuration from device) if necessary.

1. Select the **Logout** entry in the function row.  
↳ The home page with the Login box appears.
2. Close the Web browser.
3. If no longer needed:  
Reset the modified properties of the Internet protocol (TCP/IP) → 42.

**i** If communication with the web server was established via the default IP address 192.168.1.212, DIP switch no. 10 must be reset (from **ON** → **OFF**). Afterwards, the IP address of the device is active again for network communication.

## 8.5 Access to the operating menu via the operating tool

### 8.5.1 Connecting the operating tool

#### Via EtherNet/IP network

This communication interface is available in device versions with EtherNet/IP.

*Star topology*

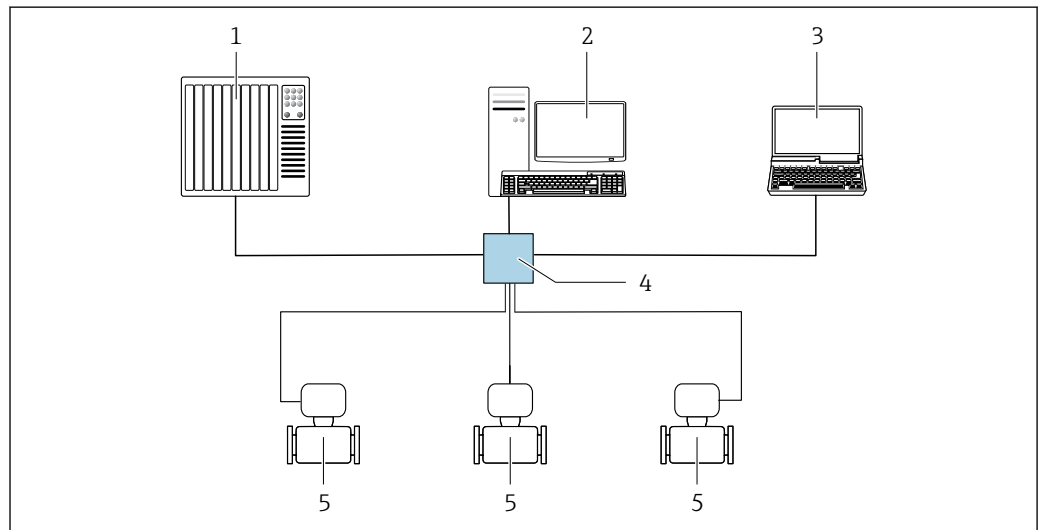

A0032078

**12** Options for remote operation via Ethernet/IP network: star topology

- 1 Automation system, z. B. "RSLogix" (Rockwell Automation)
- 2 Workstation for measuring instrument operation: with Custom Add-On Profile for "RSLogix 5000" (Rockwell Automation) or with Electronic Data Sheet (EDS)
- 3 Computer with web browser for accessing the integrated web server or computer with operating tool (e.g. FieldCare, DeviceCare) with COM DTM "CDI Communication TCP/IP"
- 4 Standard Ethernet switch, e.g. Scalance X204 (Siemens)
- 5 Measuring instrument

#### Via service interface (CDI-RJ45)

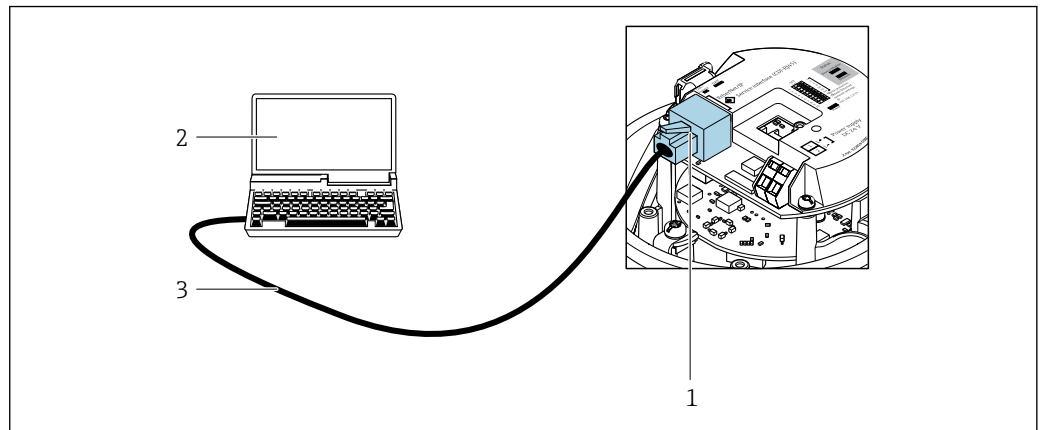
*EtherNet/IP*

 13 Connection for order code for "Output", option N: EtherNet/IP

- 1 Service interface (CDI-RJ45) and EtherNet/IP interface of the measuring instrument with access to the integrated web server
- 2 Computer with web browser for accessing the integrated web server or with FieldCare operating tool with COM DTM "CDI Communication TCP/IP"
- 3 Standard Ethernet connecting cable with RJ45 plug

A0016940

## 8.5.2 FieldCare

### Function range



FDT-based (Field Device Technology) plant asset management tool from Endress+Hauser. It can configure all smart field units in a system and helps you manage them. By using the status information, it is also a simple but effective way of checking their status and condition.

Access is via:  
CDI-RJ45 service interface

Typical functions:

- Transmitter parameter configuration
- Loading and saving of device data (upload/download)
- Documentation of the measuring point
- Visualization of the measured value memory (line recorder) and event logbook

-  ▪ Operating Instructions BA00027S
- Operating Instructions BA00059S

 Source for device description files →  48

## 8.5.3 DeviceCare

### Function range

Tool for connecting and configuring Endress+Hauser field devices.

The fastest way to configure Endress+Hauser field devices is with the dedicated "DeviceCare" tool. Together with the device type managers (DTMs) it presents a convenient, comprehensive solution.

-  Innovation brochure IN01047S

 Source for device description files →  48

## 9 System integration

### 9.1 Overview of device description files

#### 9.1.1 Current version data for the device

Firmware version	01.02.zz	<ul style="list-style-type: none"> <li>▪ On the title page of the manual</li> <li>▪ On the transmitter nameplate</li> <li>▪ Firmware version Diagnostics → Device information → Firmware version</li> </ul>
Release date of firmware version	10.2014	---
Manufacturer ID	0x49E	Manufacturer ID Diagnostics → Device information → Manufacturer ID
Device type code	0x104A	Device type Diagnostics → Device information → Device type
Device revision	<ul style="list-style-type: none"> <li>▪ Major revision 2</li> <li>▪ Minor revision 1</li> </ul>	<ul style="list-style-type: none"> <li>▪ On the transmitter nameplate</li> <li>▪ Device revision Diagnostics → Device information → Device revision</li> </ul>
Device profile	Generic device (product type: 0x2B)	



For an overview of the various firmware versions for the device

#### 9.1.2 Operating tools

The suitable device description file for the individual operating tools is listed in the table below, along with information on where the file can be acquired.

Operating tool via Service interface (CDI-RJ45)	Sources for obtaining device descriptions
FieldCare	<ul style="list-style-type: none"> <li>▪ <a href="http://www.endress.com">www.endress.com</a> → Downloads area</li> <li>▪ USB stick (contact Endress+Hauser)</li> <li>▪ E-mail → Downloads area</li> </ul>
DeviceCare	<ul style="list-style-type: none"> <li>▪ <a href="http://www.endress.com">www.endress.com</a> → Downloads area</li> <li>▪ E-mail → Downloads area</li> </ul>

### 9.2 Overview of system files

System files	Version	Description	How to acquire
Electronic Data Sheet (EDS system file)	2.1	Certified in accordance with the following ODVA guidelines: <ul style="list-style-type: none"> <li>▪ Conformance test</li> <li>▪ Performance test</li> <li>▪ PlugFest</li> </ul> Embedded EDS Support (File Object 0x37)	<ul style="list-style-type: none"> <li>▪ <a href="http://www.endress.com">www.endress.com</a> → Download Area</li> <li>▪ EDS system file integrated in the device: can be downloaded via the web browser</li> </ul>
Add-on Profile	<ul style="list-style-type: none"> <li>▪ Major revision 2</li> <li>▪ Minor revision 1</li> </ul>	System file for "Studio 5000" software (Rockwell Automation)	<a href="http://www.endress.com">www.endress.com</a> → Download Area

### 9.3 Integrating the device in the system

 For detailed information on system integration, see the Operating Instructions for the device



A detailed description of the integration of the device into an automation system (e.g. a Rockwell Automation system) is available in a separate document:  
[www.endress.com](http://www.endress.com) → Select country → Solutions → Fieldbus planning  
 → Fieldbus technologies → EtherNet/IP

### 9.4 Cyclic data transmission

Cyclic data transmission when using the device master file (GSD).

#### 9.4.1 Block model

The block model shows which input and output data the measuring device makes available for implicit messaging. Cyclical data exchange is performed using an EtherNet/IP scanner, e.g. a distributed control system etc.

Measuring device				Control system
Transducer Block	Input Assembly Fix (Assem100) 44 Byte	→  50	Permanently assigned input group	→
	Output Assembly Fix (Assem102) 64 Byte	→  51	Permanently assigned output group	←
	Input Assembly Configurable (Assem101) 88 Byte	→  51	Configurable input group	→
				EtherNet/IP

#### 9.4.2 Input and output groups

##### Possible configurations

*Configuration 1: Exclusive Owner Multicast*

Input Assembly Fix		Instance	Size (byte)	Min. RPI (ms)
Input Assembly Configurable	Configuration	0 x 64	398	-
Output Assembly Fix	O → T Configuration	0 x 66	64	5
Input Assembly Fix	T → O Configuration	0 x 64	44	5

*Configuration 2: Input Only Multicast*

Input Assembly Fix		Instance	Size (byte)	Min. RPI (ms)
Input Assembly Configurable	Configuration	0 x 68	398	-
Output Assembly Fix	O → T Configuration	0 x C7	-	-
Input Assembly Fix	T → O Configuration	0 x 64	44	5

*Configuration 3: Exclusive Owner Multicast*

Input Assembly Configurable		Instance	Size (byte)	Min. RPI (ms)
Input Assembly Configurable	Configuration	0 x 68	398	-
Output Assembly Fix	O → T Configuration	0 x 66	64	5
Input Assembly Fix	T → O Configuration	0 x 65	88	5

*Configuration 4: Input Only Multicast*

Input Assembly Configurable		Instance	Size (byte)	Min. RPI (ms)
Input Assembly Configurable	Configuration	0 x 68	398	–
Output Assembly Fix	O → T Configuration	0 x C7	–	–
Input Assembly Fix	T → O Configuration	0 x 64	88	5

*Configuration 5: Exclusive Owner Multicast*

Input Assembly Fix		Instance	Size (byte)	Min. RPI (ms)
Input Assembly Configurable	Configuration	0 x 69	–	–
Output Assembly Fix	O → T Configuration	0 x 66	64	5
Input Assembly Fix	T → O Configuration	0 x 64	44	5

*Configuration 6: Input Only Multicast*

Input Assembly Fix		Instance	Size (byte)	Min. RPI (ms)
Input Assembly Configurable	Configuration	0 x 69	–	–
Output Assembly Fix	O → T Configuration	0 x C7	–	–
Input Assembly Fix	T → O Configuration	0 x 65	44	5

*Configuration 7: Exclusive Owner Multicast*

Input Assembly Configurable		Instance	Size (byte)	Min. RPI (ms)
Input Assembly Configurable	Configuration	0 x 69	–	–
Output Assembly Fix	O → T Configuration	0 x 66	64	5
Input Assembly Fix	T → O Configuration	0 x 64	88	5

*Configuration 8: Input Only Multicast*

Input Assembly Configurable		Instance	Size (byte)	Min. RPI (ms)
Input Assembly Configurable	Configuration	0 x 69	–	–
Output Assembly Fix	O → T Configuration	0 x C7	–	–
Input Assembly Fix	T → O Configuration	0 x 65	88	5

**Permanently assigned input group**

Input Assembly Fix (Assem100) 44 Byte

Name	Description	Byte
Input Assembly Fix	1. File header (not visible)	1...4
	2. Current diagnosis <sup>1)</sup>	5...8
	3. Mass flow	9...12
	4. Volume flow	13...16
	5. Corrected volume flow	17...20
	6. Temperature	21...24
	7. Density	25...28
	8. Reference density	29...32
	9. Totalizer 1	33...36

Name	Description	Byte
	10. Totalizer 2	37...40
	11. Totalizer 3	41...44

1) Structure: Code, number, description (e.g.: 16777265 F882 input signal)



Detailed description:

- Diagnostic information → 81
- Information events → 94

### Configurable input group

Input Assembly Configurable (Assem101) 88 Byte

Name	Description	Format
Input Assembly Configurable	1. - 10. Input values 1 to 10	Real
	11. - 20. Input values 11 to 20	Double integer

#### Possible input values

Possible input values 1 to 10:		
▪ Off	▪ Temperature	▪ Tube damping fluctuation 0
▪ Mass flow	▪ Carrier tube temperature <sup>2)</sup>	▪ Exciter current 0
▪ Volume flow	▪ Electronics temperature	▪ Monitoring of exciter current 0
▪ Corrected volume flow	▪ Oscillation frequency 0	▪ Totalizer 1
▪ Target mass flow <sup>1)</sup>	▪ Oscillation amplitude 0	▪ Totalizer 2
▪ Carrier mass flow <sup>1)</sup>	▪ Oscillation frequency 0	▪ Totalizer 3
▪ Density	▪ Oscillation damping 0	
▪ Reference density	▪ Signal shift	
▪ Concentration <sup>1)</sup>		

- 1) Only available with the Concentration application package  
 2) Only available with the Heartbeat Verification application package

Possible input values 11 to 20:		
▪ Off	▪ Temperature unit	▪ Totalizer 1 unit
▪ Current diagnostics	▪ Density unit	▪ Totalizer 2 unit
▪ Previous diagnostics	▪ Reference density unit	▪ Totalizer 3 unit
▪ Mass flow unit	▪ Concentration unit	▪ Verification result
▪ Volume flow unit	▪ Current unit	
▪ Corrected volume flow unit	▪ Verification status	

### Permanently assigned output group

Output Assembly Fix (Assem102) 64 Byte



Name	Description (format)	Byte	Bit	Value
Output Assembly Fix	1. Totalizer 1	1	1	<ul style="list-style-type: none"> <li>▪ 0: Disable</li> <li>▪ 1: Enable</li> </ul>
	2. Totalizer 2		2	
	3. Totalizer 3		3	
	4. Pressure compensation		4	
	5. Reference density compensation		5	
	6. Temperature compensation		6	
	7. Verification		7	

Name	Description (format)	Byte	Bit	Value
	8. Not used		8	-
	9. Not used	2...4	0...8	-
	10. Control totalizer 1 (integer)	5...6	0...8	<ul style="list-style-type: none"> <li>▪ -32226: Add</li> <li>▪ -32490: Reset and stop</li> <li>▪ -32228: Default value and stop</li> <li>▪ 198: Reset and add</li> <li>▪ 199: Default value and add</li> </ul>
	11. Not used	7...8	0...8	-
	12. Control totalizer 2 (integer)	9...10	0...8	See totalizer 1
	13. Not used	11...12	0...8	-
	14. Control totalizer 3 (integer)	13...14	0...8	See totalizer 1
	15. Not used	15...16	0...8	-
	16. External pressure (real)	17...20	0...8	Data format: Byte 1 to 4: External pressure Floating-point number (IEEE754)
	17. External pressure unit (integer)	21...22	0...8	<ul style="list-style-type: none"> <li>▪ 2165: Pa a</li> <li>▪ 2116: kPa a</li> <li>▪ 2137: MPa a</li> <li>▪ 4871: bar a</li> <li>▪ 2166: Pa g</li> <li>▪ 2117: kPa a</li> <li>▪ 2138: MPa a</li> <li>▪ 2053: bar g</li> <li>▪ 2182: Psi a</li> <li>▪ 2183: Psi g</li> <li>▪ 2244: Customer-specific</li> </ul>
	18. Not used	23...24	0...8	-
	19. External reference density (real)	25...28	0...8	Data format: Byte 1 to 4: External ref. density Floating-point number (IEEE754)
	20. External reference density unit (integer)	29...30	0...8	<ul style="list-style-type: none"> <li>▪ 2112: kg/Nm<sup>3</sup></li> <li>▪ 2113: kg/Nl</li> <li>▪ 2092: g/Scm<sup>3</sup></li> <li>▪ 2114: kg/Scm<sup>3</sup></li> <li>▪ 2181: lb/Sft<sup>3</sup></li> </ul>
	21. Not used	31...32	0...8	-
	22. External temperature (real)	33...36	0...8	Data format: Byte 1 to 4: External temperature Floating-point number (IEEE754)
	23. External temperature unit (integer)	37...38	0...8	<ul style="list-style-type: none"> <li>▪ 4608: °C</li> <li>▪ 4609: °F</li> <li>▪ 4610: K</li> <li>▪ 4611: °R</li> </ul>
	24. Not used	39...40	0...8	-
	25. Start verification (integer)	41...42	0...8	<ul style="list-style-type: none"> <li>▪ 32378: Start</li> <li>▪ 32713: Cancel</li> </ul>
	26. Not used	43...64	0...8	-

## 10 Commissioning

### 10.1 Post-installation and post-connection check

Before commissioning the device:



- ▶ Make sure that the post-installation and post-connection checks have been performed successfully.
- Checklist for "Post-installation" check →  26
- Checklist for "Post-connection" check →  34

### 10.2 Configuring the device address via software

#### 10.2.1 Ethernet network and web server

The DHCP client functionality is enabled ex works and the IP address, subnet mask and default gateway are set automatically →  58.

Identification is via the MAC address of the device.

-  ▪ If hardware addressing is active, software addressing is disabled.
- If a switch is made to hardware addressing, the address configured via software addressing is retained for the first 9 places (the first three octets).
- If the IP address of the device is not known, the device address currently configured can be read out →  70.

### 10.3 Setting the operating language

Factory setting: English or ordered local language

The operating language can be set in FieldCare, DeviceCare or via the Web server:  
Operation → Display language

### 10.4 Configuring the device

The **Setup** menu with its submenus contains all the parameters needed for standard operation.

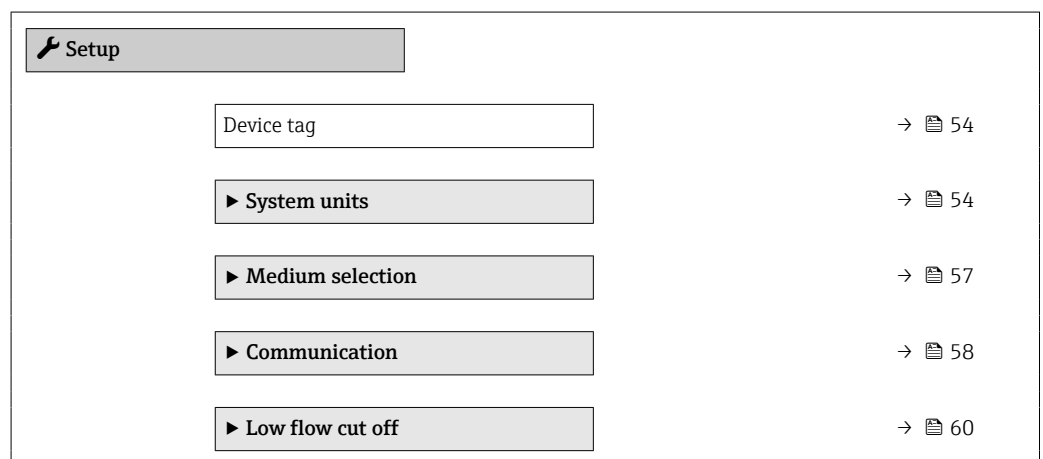

▶ Partially filled pipe detection

▶ Advanced setup

→ 62

### 10.4.1 Defining the tag name

To enable fast identification of the measuring point within the system, you can enter a unique designation using the **Device tag** parameter and thus change the factory setting.

Enter the tag name in the "FieldCare" operating tool

#### Navigation

"Setup" menu → Device tag

#### Parameter overview with brief description

Parameter	Description	User entry	Factory setting
Device tag	Enter the name for the measuring point.	Max. 32 characters, such as letters, numbers or special characters (e.g. @, %, /).	Promass 100

### 10.4.2 Setting the system units

In the **System units** submenu the units of all the measured values can be set.

The number of submenus and parameters can vary depending on the device version. Certain submenus and parameters in these submenus are not described in the Operating Instructions. Instead a description is provided in the Special Documentation for the device ("Supplementary documentation").

#### Navigation

"Setup" menu → Advanced setup → System units

▶ System units

Mass flow unit

→ 55

Mass unit

→ 55

Volume flow unit

→ 55

Volume unit

→ 55

Corrected volume flow unit

→ 55

Corrected volume unit



→ 55

Density unit

→ 55

Reference density unit

→ 55

Temperature unit	→  56
Pressure unit	→  56

### Parameter overview with brief description

Parameter	Description	Selection	Factory setting
Mass flow unit	Select mass flow unit. <i>Effect</i> The selected unit applies to: <ul style="list-style-type: none"> <li>▪ Output</li> <li>▪ Low flow cut off</li> <li>▪ Simulation process variable</li> </ul>	Unit choose list	Country-specific: <ul style="list-style-type: none"> <li>▪ kg/h</li> <li>▪ lb/min</li> </ul>
Mass unit	Select mass unit.	Unit choose list	Country-specific: <ul style="list-style-type: none"> <li>▪ kg</li> <li>▪ lb</li> </ul>
Volume flow unit	Select volume flow unit. <i>Effect</i> The selected unit applies to: <ul style="list-style-type: none"> <li>▪ Output</li> <li>▪ Low flow cut off</li> <li>▪ Simulation process variable</li> </ul>	Unit choose list	Country-specific: <ul style="list-style-type: none"> <li>▪ l/h</li> <li>▪ gal/min (us)</li> </ul>
Volume unit	Select volume unit.	Unit choose list	Country-specific: <ul style="list-style-type: none"> <li>▪ l</li> <li>▪ gal (us)</li> </ul>
Corrected volume flow unit	Select corrected volume flow unit. <i>Effect</i> The selected unit applies to: <b>Corrected volume flow</b> parameter (→  72)	Unit choose list	Country-specific: <ul style="list-style-type: none"> <li>▪ NI/h</li> <li>▪ Sft<sup>3</sup>/min</li> </ul>
Corrected volume unit	Select corrected volume unit.	Unit choose list	Country-specific: <ul style="list-style-type: none"> <li>▪ NI</li> <li>▪ Sft<sup>3</sup></li> </ul>
Reference density unit	Select reference density unit.	Unit choose list	Country-specific <ul style="list-style-type: none"> <li>▪ kg/NI</li> <li>▪ lb/Sft<sup>3</sup></li> </ul>
Density unit	Select density unit. <i>Effect</i> The selected unit applies to: <ul style="list-style-type: none"> <li>▪ Output</li> <li>▪ Simulation process variable</li> <li>▪ Density adjustment (<b>Expert</b> menu)</li> </ul>	Unit choose list	Country-specific: <ul style="list-style-type: none"> <li>▪ kg/l</li> <li>▪ lb/ft<sup>3</sup></li> </ul>
Density 2 unit	Select second density unit.	Unit choose list	Country-specific: <ul style="list-style-type: none"> <li>▪ kg/l</li> <li>▪ lb/ft<sup>3</sup></li> </ul>

Parameter	Description	Selection	Factory setting
Temperature unit	<p>Select temperature unit.</p> <p><i>Effect</i></p> <p>The selected unit applies to:</p> <ul style="list-style-type: none"> <li>▪ <b>Electronic temperature</b> parameter (6053)</li> <li>▪ <b>Maximum value</b> parameter (6051)</li> <li>▪ <b>Minimum value</b> parameter (6052)</li> <li>▪ <b>External temperature</b> parameter (6080)</li> <li>▪ <b>Maximum value</b> parameter (6108)</li> <li>▪ <b>Minimum value</b> parameter (6109)</li> <li>▪ <b>Carrier pipe temperature</b> parameter (6027)</li> <li>▪ <b>Maximum value</b> parameter (6029)</li> <li>▪ <b>Minimum value</b> parameter (6030)</li> <li>▪ <b>Reference temperature</b> parameter (1816)</li> <li>▪ <b>Temperature</b> parameter</li> </ul>	Unit choose list	<p>Country-specific:</p> <ul style="list-style-type: none"> <li>▪ °C</li> <li>▪ °F</li> </ul>
Pressure unit	<p>Select process pressure unit.</p> <p><i>Effect</i></p> <p>The unit is taken from:</p> <ul style="list-style-type: none"> <li>▪ <b>Pressure value</b> parameter (→ 58)</li> <li>▪ <b>External pressure</b> parameter (→ 58)</li> <li>▪ Pressure value</li> </ul>	Unit choose list	<p>Country-specific:</p> <ul style="list-style-type: none"> <li>▪ bar a</li> <li>▪ psi a</li> </ul>

### 10.4.3 Selecting and setting the medium

The **Select medium** wizard submenu contains parameters that must be configured in order to select and set the medium.

#### Navigation

"Setup" menu → Medium selection

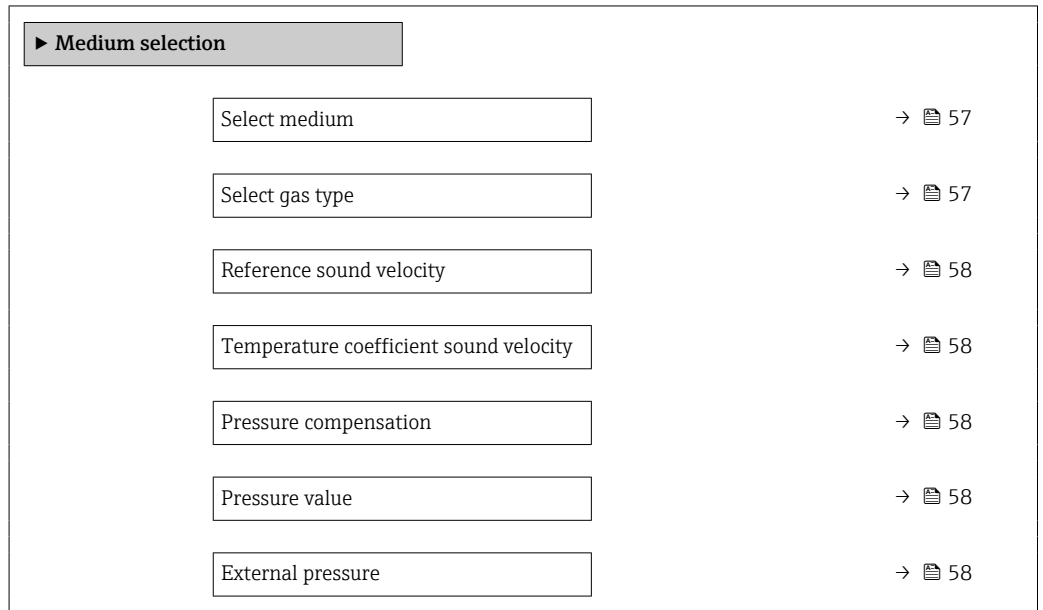

#### Parameter overview with brief description

Parameter	Prerequisite	Description	Selection / User entry
Select medium	–	Use this function to select the type of medium: "Gas" or "Liquid". Select the "Other" option in exceptional cases in order to enter the properties of the medium manually (e.g. for highly compressive liquids such as sulfuric acid).	<ul style="list-style-type: none"> <li>■ Liquid</li> <li>■ Gas</li> </ul>
Select gas type	In the <b>Medium selection</b> submenu, the <b>Gas</b> option is selected.	Select measured gas type.	<ul style="list-style-type: none"> <li>■ Air</li> <li>■ Ammonia NH3</li> <li>■ Argon Ar</li> <li>■ Sulfur hexafluoride SF6</li> <li>■ Oxygen O2</li> <li>■ Ozone O3</li> <li>■ Nitrogen oxide NOx</li> <li>■ Nitrogen N2</li> <li>■ Nitrous oxide N2O</li> <li>■ Methane CH4</li> <li>■ Hydrogen H2</li> <li>■ Helium He</li> <li>■ Hydrogen chloride HCl</li> <li>■ Hydrogen sulfide H2S</li> <li>■ Ethylene C2H4</li> <li>■ Carbon dioxide CO2</li> <li>■ Carbon monoxide CO</li> <li>■ Chlorine Cl2</li> <li>■ Butane C4H10</li> <li>■ Propane C3H8</li> <li>■ Propylene C3H6</li> <li>■ Ethane C2H6</li> <li>■ Others</li> </ul>

Parameter	Prerequisite	Description	Selection / User entry
Reference sound velocity	In the <b>Select gas type</b> parameter, the <b>Others</b> option is selected.	Enter sound velocity of gas at 0 °C (32 °F).	1 to 99 999.9999 m/s
Temperature coefficient sound velocity	In the <b>Select gas type</b> parameter, the <b>Others</b> option is selected.	Enter temperature coefficient for the gas sound velocity.	Positive floating-point number
Pressure compensation	–	Select pressure compensation type.	<ul style="list-style-type: none"> <li>■ Off</li> <li>■ Fixed value</li> <li>■ External value</li> </ul>
Pressure value	In the <b>Pressure compensation</b> parameter, the <b>Fixed value</b> option or the <b>Current input 1...n</b> option is selected.	Enter process pressure to be used for pressure correction.	Positive floating-point number
External pressure	In the <b>Pressure compensation</b> parameter, the <b>External value</b> option is selected.		

#### 10.4.4 Configuration of the communication interface

The **Communication** submenu guides you systematically through all the parameters that have to be configured for selecting and setting the communication interface.

##### Navigation

"Setup" menu → Communication

► Communication	
MAC address	→ ⓘ 58
Default network settings	→ ⓘ 58
DHCP client	→ ⓘ 59
IP address	→ ⓘ 59
Subnet mask	→ ⓘ 59
Default gateway	→ ⓘ 59

##### Parameter overview with brief description

Parameter	Description	User interface / Selection / User entry	Factory setting
MAC address	Displays the MAC address of the measuring instrument.  MAC = Media Access Control	Unique 12-digit character string comprising letters and numbers, e.g.: 00:07:05:10:01:5F	Each measuring instrument is given an individual address.
Default network settings	Select whether to restore network settings.	<ul style="list-style-type: none"> <li>■ Off</li> <li>■ On</li> </ul>	–

Parameter	Description	User interface / Selection / User entry	Factory setting
DHCP client	<p>Select to activate/deactivate DHCP client functionality.</p> <p><b>Result</b> If the DHCP client functionality of the web server is activated, the IP address, Subnet mask and Default gateway are set automatically.</p> <p> Identification is via the MAC address of the measuring device.</p> <ul style="list-style-type: none"> <li>▪ The IP address in the <b>IP address</b> parameter is ignored as long as the <b>DHCP client</b> parameter is active. This is also the case, in particular, if the DHCP server cannot be reached. The IP address in the parameter of the same name is only used if the <b>DHCP client</b> parameter is inactive.</li> </ul>	<ul style="list-style-type: none"> <li>▪ Off</li> <li>▪ On</li> </ul>	On
IP address	<p>IP address of the Web server integrated in the measuring instrument.</p> <p>If the DHCP client and write access are switched off, the IP address can also be entered.</p> <p>Enter the IP address of the service interface (port 2).</p>	4 octet: 0 to 255 (in the particular octet)	–
Subnet mask	<p>Displays the subnet mask.</p> <p>If the DHCP client and write access are switched off, the Subnet mask can also be entered.</p>	4 octet: 0 to 255 (in the particular octet)	–
Default gateway	<p>Displays the default gateway.</p> <p>If the DHCP client and write access are switched off, the Default gateway can also be entered.</p>	4 octet: 0 to 255 (in the particular octet)	–

### 10.4.5 Configuring the low flow cut off

The **Low flow cut off** submenu contains the parameters that must be set in order to configure the low flow cut off.

#### Navigation

"Setup" menu → Low flow cut off

► Low flow cut off	
Assign process variable	→ 60
On value low flow cutoff	→ 60
Off value low flow cutoff	→ 60
Pressure shock suppression	→ 60

#### Parameter overview with brief description

Parameter	Prerequisite	Description	Selection / User entry	Factory setting
Assign process variable	–	Select process variable for low flow cut off.	<ul style="list-style-type: none"> <li>■ Off</li> <li>■ Mass flow</li> <li>■ Volume flow</li> <li>■ Corrected volume flow</li> </ul>	–
On value low flow cutoff	A process variable is selected in the <b>Assign process variable</b> parameter (→ 60).	Enter on value for low flow cut off.	Positive floating-point number	Depends on country and nominal diameter
Off value low flow cutoff	A process variable is selected in the <b>Assign process variable</b> parameter (→ 60).	Enter off value for low flow cut off.	0 to 100.0 %	–
Pressure shock suppression	A process variable is selected in the <b>Assign process variable</b> parameter (→ 60).	Enter time frame for signal suppression (= active pressure shock suppression).	0 to 100 s	–

### 10.4.6 Partially filled pipe detection

The **Partially filled pipe detection** submenu contains parameters that have to be set for configuring empty pipe detection.

#### Navigation

"Setup" menu → Partially filled pipe detection

▶ **Partially filled pipe detection**

Assign process variable	→  61
Low value partial filled pipe detection	→  61
High value partial filled pipe detection	→  61
Response time part. filled pipe detect.	→  61

#### Parameter overview with brief description

Parameter	Prerequisite	Description	Selection / User entry	Factory setting
Assign process variable	–	Select process variable for partially filled pipe detection.	<ul style="list-style-type: none"> <li>■ Off</li> <li>■ Density</li> <li>■ Reference density</li> </ul>	Density
Low value partial filled pipe detection	A process variable is selected in the <b>Assign process variable</b> parameter (→  61).	Enter lower limit value for deactivating partialy filled pipe detection.	Signed floating-point number	Depends on country: <ul style="list-style-type: none"> <li>■ 200 kg/m<sup>3</sup></li> <li>■ 12.5 lb/ft<sup>3</sup></li> </ul>
High value partial filled pipe detection	A process variable is selected in the <b>Assign process variable</b> parameter (→  61).	Enter upper limit value for deactivating partialy filled pipe detection.	Signed floating-point number	Depends on country: <ul style="list-style-type: none"> <li>■ 6 000 kg/m<sup>3</sup></li> <li>■ 374.6 lb/ft<sup>3</sup></li> </ul>
Response time part. filled pipe detect.	A process variable is selected in the <b>Assign process variable</b> parameter (→  61).	Use this function to enter the minimum time (hold time) the signal must be present before diagnostic message S962 "Pipe only partly filled" is triggered in the event of a partially filled or empty measuring pipe.	0 to 100 s	–

## 10.5 Advanced settings

The **Advanced setup** submenu with its submenus contains parameters for specific settings.

 The number of submenus can vary depending on the device version, e.g. viscosity is available only with the Promass I.

### Navigation

"Setup" menu → Advanced setup

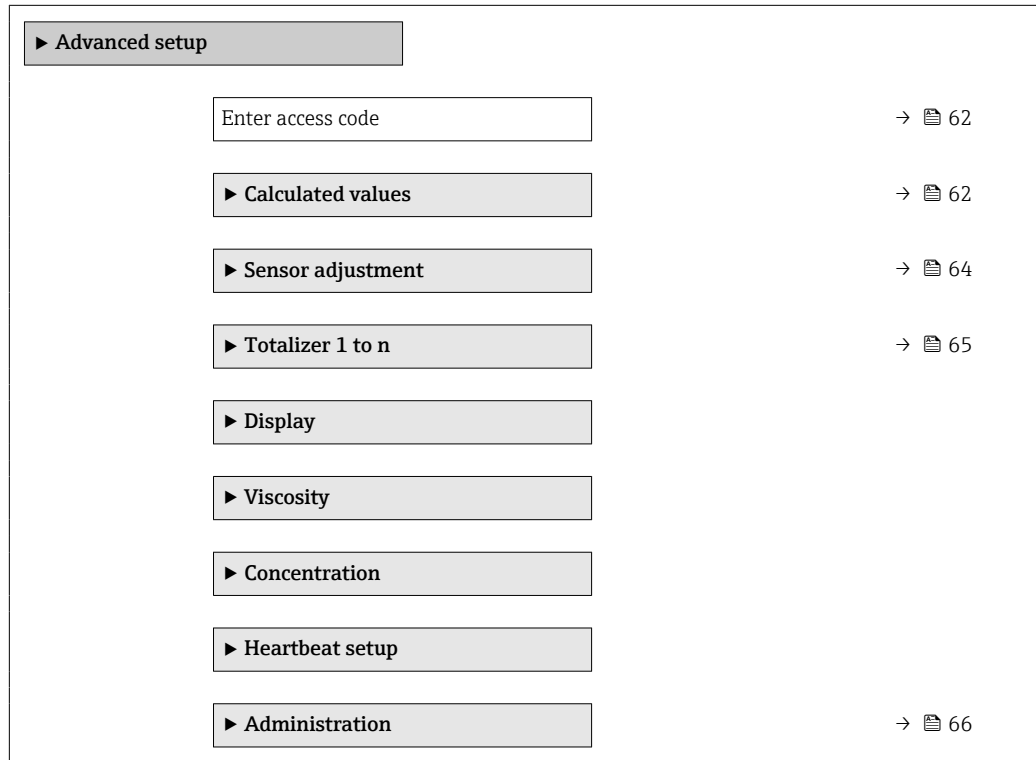

### 10.5.1 Using the parameter to enter the access code

#### Navigation

"Setup" menu → Advanced setup

#### Parameter overview with brief description

Parameter	Description	User entry
Enter access code	Enter access code to disable write protection of parameters.	Max. 16-digit character string comprising numbers, letters and special characters

### 10.5.2 Calculated process variables

The **Calculated values** submenu contains parameters for calculating the corrected volume flow.

**Navigation**

"Setup" menu → Advanced setup → Calculated values

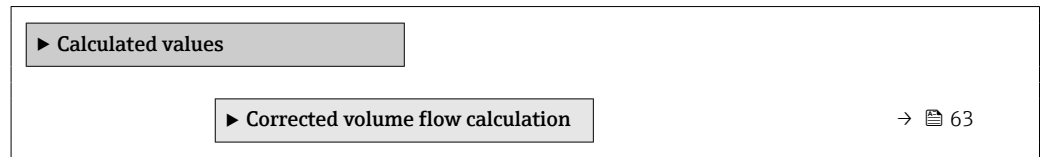

**"Corrected volume flow calculation" submenu**

**Navigation**

"Setup" menu → Advanced setup → Calculated values → Corrected volume flow calculation

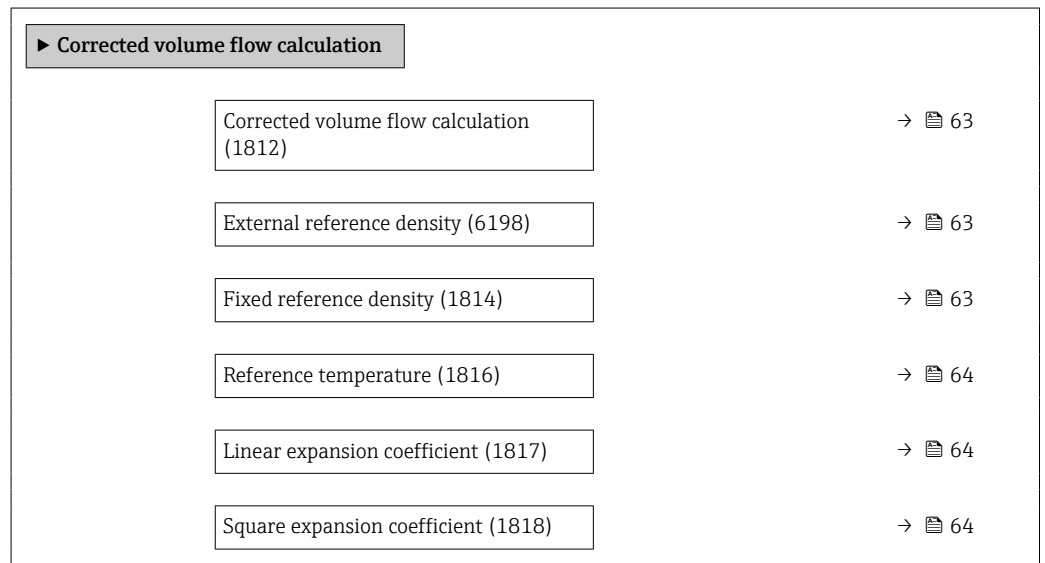

**Parameter overview with brief description**

Parameter	Prerequisite	Description	Selection / User interface / User entry	Factory setting
Corrected volume flow calculation	–	Select reference density for calculating the corrected volume flow.	<ul style="list-style-type: none"> <li>■ Fixed reference density</li> <li>■ Calculated reference density</li> <li>■ Reference density by API table 53</li> <li>■ External reference density</li> </ul>	–
External reference density	In the <b>Corrected volume flow calculation</b> parameter, the <b>External reference density</b> option is selected.	Shows external reference density.	Floating point number with sign	–
Fixed reference density	The <b>Fixed reference density</b> option is selected in the <b>Corrected volume flow calculation</b> parameter.	Enter fixed value for reference density.	Positive floating-point number	–

Parameter	Prerequisite	Description	Selection / User interface / User entry	Factory setting
Reference temperature	The <b>Calculated reference density</b> option is selected in the <b>Corrected volume flow calculation</b> parameter parameter.	Enter reference temperature for calculating the reference density.	-273.15 to 99 999 °C	Country-specific: <ul style="list-style-type: none"> <li>■ +20 °C</li> <li>■ +68 °F</li> </ul>
Linear expansion coefficient	The <b>Calculated reference density</b> option is selected in the <b>Corrected volume flow calculation</b> parameter parameter.	Enter linear, medium-specific expansion coefficient for calculating the reference density.	Signed floating-point number	-
Square expansion coefficient	The <b>Calculated reference density</b> option is selected in the <b>Corrected volume flow calculation</b> parameter parameter.	For media with a non-linear expansion pattern: enter the quadratic, medium-specific expansion coefficient for calculating the reference density.	Signed floating-point number	-

### 10.5.3 Carrying out a sensor adjustment

The **Sensor adjustment** submenu contains parameters that pertain to the functionality of the sensor.

#### Navigation

"Setup" menu → Advanced setup → Sensor adjustment

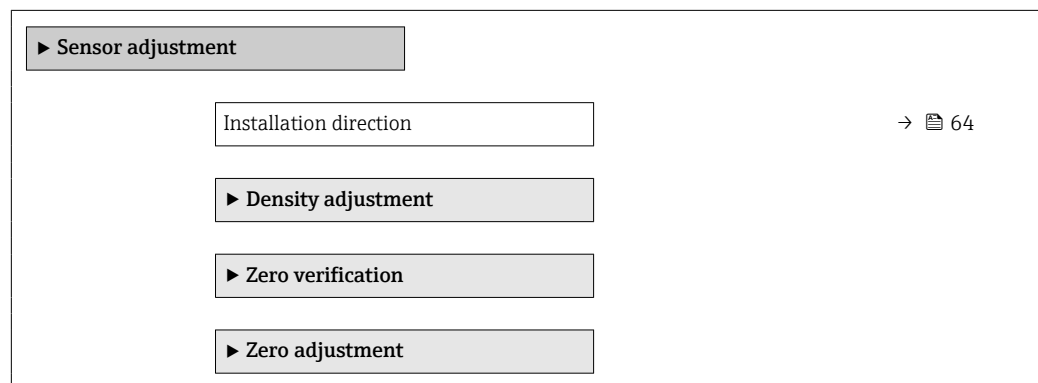

#### Parameter overview with brief description

Parameter	Description	Selection
Installation direction	Set sign of flow direction to match the direction of the arrow on the sensor.	<ul style="list-style-type: none"> <li>■ Flow in arrow direction</li> <li>■ Flow against arrow direction</li> </ul>

#### Zero verification and zero adjustment

All measuring instruments are calibrated in accordance with state-of-the-art technology. Calibration takes place under reference conditions → 110. Therefore, a zero adjustment in the field is generally not required.

Experience shows that zero adjustment is advisable only in special cases:

- To achieve maximum measurement accuracy even with low flow rates.
- Under extreme process or operating conditions (e.g. very high process temperatures or very high-viscosity media).
- For gas applications with low pressure.

 To achieve the highest possible measurement accuracy at low flow rates, the installation must protect the sensor from mechanical stress during operation.

To get a representative zero point, ensure that:

- any flow in the device is prevented during the adjustment
- the process conditions (e.g. pressure, temperature) are stable and representative

Zero verification and zero adjustment cannot be performed if the following process conditions are present:

- Gas pockets  
Ensure that the system has been sufficiently flushed with the medium. Repeat flushing can help to eliminate gas pockets
- Thermal circulation  
In the event of temperature differences (e.g. between the measuring tube inlet and outlet section), induced flow can occur even if the valves are closed due to thermal circulation in the device
- Leaks at the valves  
If the valves are not leak-tight, flow is not sufficiently prevented when determining the zero point

If these conditions cannot be avoided, it is advisable to keep the factory setting for the zero point.

**Navigation**

"Setup" menu → Advanced setup → Sensor adjustment → Zero point adjustment

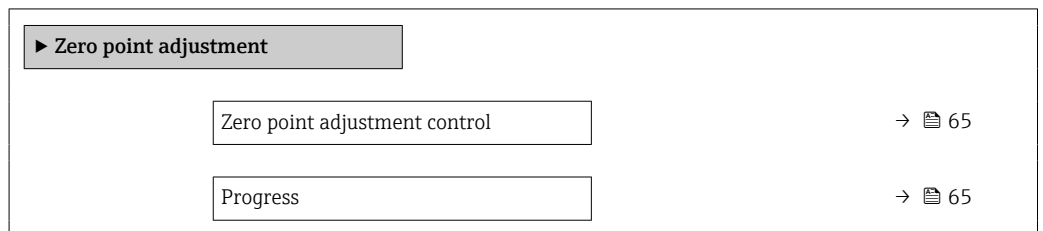

**Parameter overview with brief description**

Parameter	Description	Selection / User interface	Factory setting
Zero point adjustment control	Start zero point adjustment.	<ul style="list-style-type: none"> <li>■ Cancel</li> <li>■ Busy</li> <li>■ Zero point adjust failure</li> <li>■ Start</li> </ul>	–
Progress	Shows the progress of the process.	0 to 100 %	–

**10.5.4 Configuring the totalizer**

In the "Totalizer 1 to n" submenu, you can configure the specific totalizer.

**Navigation**

"Setup" menu → Advanced setup → Totalizer 1 to n

▶ <b>Totalizer 1 to n</b>	
Assign process variable	→ 66
Unit totalizer	→ 66
Totalizer operation mode	→ 66
Failure mode	→ 66

**Parameter overview with brief description**

Parameter	Prerequisite	Description	Selection	Factory setting
Assign process variable	–	Select process variable for totalizer.	<ul style="list-style-type: none"> <li>▪ Off</li> <li>▪ Volume flow</li> <li>▪ Mass flow</li> <li>▪ Corrected volume flow</li> <li>▪ Target mass flow<sup>*</sup></li> <li>▪ Carrier mass flow<sup>*</sup></li> </ul>	–
Unit totalizer	A process variable is selected in the <b>Assign process variable</b> parameter (→ 66) of the <b>Totalizer 1 to n</b> submenu.	Select process variable totalizer unit.	Unit choose list	Depends on country: <ul style="list-style-type: none"> <li>▪ kg</li> <li>▪ lb</li> </ul>
Totalizer operation mode	A process variable is selected in the <b>Assign process variable</b> parameter (→ 66) of the <b>Totalizer 1 to n</b> submenu.	Select totalizer calculation mode.	<ul style="list-style-type: none"> <li>▪ Net flow total</li> <li>▪ Forward flow total</li> <li>▪ Reverse flow total</li> </ul>	–
Failure mode	A process variable is selected in the <b>Assign process variable</b> parameter (→ 66) of the <b>Totalizer 1 to n</b> submenu.	Define totalizer behavior in alarm condition.	<ul style="list-style-type: none"> <li>▪ Stop</li> <li>▪ Actual value</li> <li>▪ Last valid value</li> </ul>	–

\* Visibility depends on order options or device settings

**10.5.5 Using parameters for device administration**

The **Administration** submenu systematically guides the user through all the parameters that can be used for device administration purposes.

**Navigation**

"Setup" menu → Advanced setup → Administration

▶ <b>Administration</b>	
Define access code	→ 67
Device reset	→ 67

**Parameter overview with brief description**

Parameter	Description	User entry / Selection
Define access code	Define release code for write access to parameters.	0 to 9999
Device reset	Reset the device configuration - either entirely or in part - to a defined state.	<ul style="list-style-type: none"> <li>■ Cancel</li> <li>■ To delivery settings</li> <li>■ Restart device</li> </ul>

## 10.6 Simulation

Via the **Simulation** submenu, it is possible to simulate various process variables in the process and the device alarm mode and verify downstream signal chains (switching valves or closed-control loops). The simulation can be performed without a real measurement (no flow of medium through the device).

### Navigation

"Diagnostics" menu → Simulation

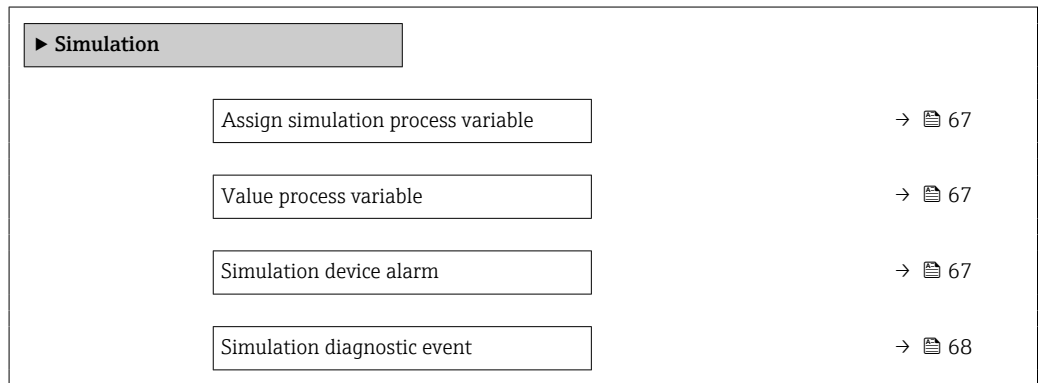

**Parameter overview with brief description**



Parameter	Prerequisite	Description	Selection / User entry
Assign simulation process variable	-	Select a process variable for the simulation process that is activated.	<ul style="list-style-type: none"> <li>■ Off</li> <li>■ Mass flow</li> <li>■ Volume flow</li> <li>■ Corrected volume flow</li> <li>■ Density</li> <li>■ Reference density</li> <li>■ Temperature</li> <li>■ Concentration *</li> <li>■ Target mass flow *</li> <li>■ Carrier mass flow *</li> </ul>
Value process variable	A process variable is selected in the <b>Assign simulation process variable</b> parameter (→ 67).	Enter the simulation value for the selected process variable.	Depends on the process variable selected
Simulation device alarm	-	Switch the device alarm on and off.	<ul style="list-style-type: none"> <li>■ Off</li> <li>■ On</li> </ul>

Parameter	Prerequisite	Description	Selection / User entry
Diagnostic event category	–	Select a diagnostic event category.	<ul style="list-style-type: none"> <li>■ Sensor</li> <li>■ Electronics</li> <li>■ Configuration</li> <li>■ Process</li> </ul>
Simulation diagnostic event	–	Select a diagnostic event for the simulation process that is activated.	<ul style="list-style-type: none"> <li>■ Off</li> <li>■ Diagnostic event picklist (depends on the category selected)</li> </ul>

\* Visibility depends on order options or device settings

## 10.7 Protecting settings from unauthorized access

The following options exist for protecting the configuration of the measuring device from unintentional modification after commissioning:

- Write protection via access code for Web browser →  68
- Write protection via write protection switch →  69

### 10.7.1 Write protection via access code

With the customer-specific access code, access to the measuring instrument via the Web browser is protected, as are the parameters for the measuring instrument configuration.

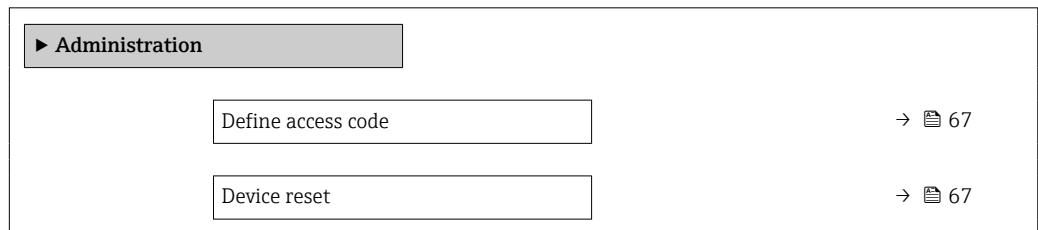

#### Navigation

"Setup" menu → Advanced setup → Administration → Define access code



#### Defining the access code via the web browser

1. Navigate to the **Define access code** parameter.
2. Define a 16-digit (max.) numeric code as the access code.
3. Enter the access code again in the to confirm.
  - ↳ The web browser switches to the login page.

- 
  - Disabling parameter write protection via access code .
  - If the access code is lost: Resetting the access code .
  - The **Access status tooling** parameter shows which user role the user is currently logged in with.
    - Navigation path: Operation → Access status tooling
    - User roles and their access rights →  39

If no action is performed for 10 minutes, the web browser automatically returns to the login page.

### 10.7.2 Write protection via write protection switch

The write protection switch makes it possible to block write access to the entire operating menu with the exception of the following parameters:

- External pressure
- External temperature
- Reference density
- All parameters for configuring the totalizer

The parameter values are now read only and cannot be edited any more:

- Via service interface (CDI-RJ45)
- Via Ethernet network

1. Depending on the housing version, loosen the securing clamp or fixing screw of the housing cover.
2. Depending on the housing version, unscrew or open the housing cover and disconnect the local display from the main electronics module where necessary → 119.
- 3.

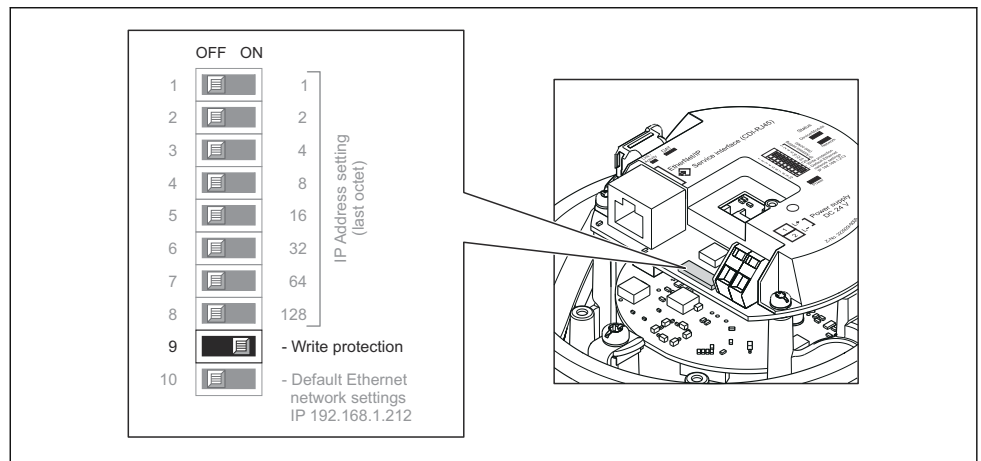

Setting the write protection switch on the I/O electronics module to the **On** position enables the hardware write protection. Setting the write protection switch on the I/O electronics module to the **Off** position (factory setting) disables the hardware write protection.

↳ If hardware write protection is enabled: the **Locking status** parameter displays the **Hardware locked** option ; if disabled, the **Locking status** parameter does not display any option .

4. Reverse the removal procedure to reassemble the transmitter.

## 11 Operation

### 11.1 Read out and modify current Ethernet settings

If the Ethernet settings such as the IP address of the measuring device are unknown, they can be read out and modified as explained in the following example for an IP address.

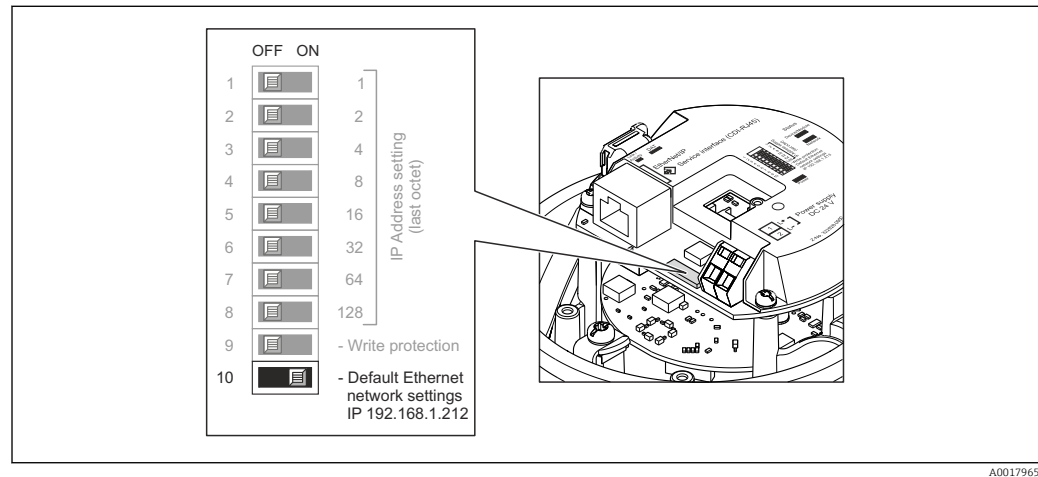

A0017965

#### Prerequisite

- Software addressing is enabled: All the DIP switches for hardware addressing are set to **OFF**.
- Measuring device is switched on.

1. Set the DIP switch for "Default Ethernet network settings, IP 192.168.1.212" from **OFF** → **ON**.
2. Restart the device.
  - ↳ The device's Ethernet settings are reset to their factory settings:  
IP address: 192.168.1.212; Subnet mask: 255.255.255.0; Default gateway: 192.168.1.212
3. Enter the default setting for the IP address in the address line of the Web browser.
4. Navigate in the operating menu to the **IP address** parameter: Setup → Communication → IP address
  - ↳ The parameter displays the configured IP address.
5. Change the IP address of the device if necessary.
6. Set the DIP switch for "Default Ethernet network settings, IP 192.168.1.212" from **ON** → **OFF**.
7. Restart the device.
  - ↳ The modified IP address of the device is now enabled.

### 11.2 Reading the device locking status

Device active write protection: **Locking status** parameter

**Navigation**



"Operation" menu → Locking status

*Function scope of "Locking status" parameter*

Options	Description
Hardware locked	The write protection switch (DIP switch) for hardware locking is activated on the I/O electronic module. This prevents write access to the parameters .
Temporarily locked	Write access to the parameters is temporarily locked on account of internal processes running in the device (e.g. data upload/download, reset etc.). Once the internal processing has been completed, the parameters can be changed once again.

### 11.3 Adjusting the operating language

 Detailed information:



- To configure the operating language →  53
- For information on the operating languages supported by the measuring device →  121

### 11.4 Reading off measured values

With the **Measured values** submenu, it is possible to read all the measured values.

**Navigation**

"Diagnostics" menu → Measured values





▶ Measured values	
▶ Process variables	→  71
▶ Totalizer	→  73











#### 11.4.1 "Measured variables" submenu

The **Process variables** submenu contains all the parameters needed to display the current measured values for each process variable.







**Navigation**



"Diagnostics" menu → Measured values → Measured variables

▶ Measured variables	
Mass flow	→  72
Volume flow	→  72
Corrected volume flow	→  72
Density	→  72

Reference density	→  72
Temperature	→  72
Pressure	→  73
Concentration	→  73
Target mass flow	→  73
Carrier mass flow	→  73
Target corrected volume flow	→  73
Carrier corrected volume flow	→  73
Target volume flow	→  73
Carrier volume flow	→  73

**Parameter overview with brief description**

Parameter	Prerequisite	Description	User interface
Mass flow	–	Displays the mass flow that is currently measured. <i>Dependency</i> The unit is taken from: <b>Mass flow unit</b> parameter (→  55)	Signed floating-point number
Volume flow	–	Displays the volume flow that is currently calculated. <i>Dependency</i> The unit is taken from the <b>Volume flow unit</b> parameter (→  55).	Signed floating-point number
Corrected volume flow	–	Displays the corrected volume flow that is currently calculated. <i>Dependency</i> The unit is taken from: <b>Corrected volume flow unit</b> parameter (→  55)	Signed floating-point number
Density	–	Shows the density currently measured. <i>Dependency</i> The unit is taken from the <b>Density unit</b> parameter (→  55).	Signed floating-point number
Reference density	–	Displays the reference density that is currently calculated. <i>Dependency</i> The unit is taken from: <b>Reference density unit</b> parameter (→  55)	Signed floating-point number
Temperature	–	Shows the medium temperature currently measured. <i>Dependency</i> The unit is taken from: <b>Temperature unit</b> parameter (→  56)	Signed floating-point number

Parameter	Prerequisite	Description	User interface
Pressure value	–	Displays either a fixed or external pressure value. <i>Dependency</i> The unit is taken from the <b>Pressure unit</b> parameter (→ 56).	Signed floating-point number
Concentration	For the following order code: Order code for "Application package", option <b>ED</b> "Concentration"  The software options currently enabled are displayed in the <b>Software option overview</b> parameter.	Displays the concentration that is currently calculated. <i>Dependency</i> The unit is taken from the <b>Concentration unit</b> parameter.	Signed floating-point number
Target mass flow	With the following conditions: Order code for "Application package", option <b>ED</b> "Concentration"  The software options currently enabled are displayed in the <b>Software option overview</b> parameter.	Displays the mass flow that is currently measured for the target medium. <i>Dependency</i> The unit is taken from: <b>Mass flow unit</b> parameter (→ 55)	Signed floating-point number
Carrier mass flow	With the following conditions: Order code for "Application package", option <b>ED</b> "Concentration"  The software options currently enabled are displayed in the <b>Software option overview</b> parameter.	Displays the mass flow of the carrier medium that is currently measured. <i>Dependency</i> The unit is taken from: <b>Mass flow unit</b> parameter (→ 55)	Signed floating-point number
Target corrected volume flow	–		Signed floating-point number
Carrier corrected volume flow	–		Signed floating-point number
Target volume flow	–		Signed floating-point number
Carrier volume flow	–		Signed floating-point number

### 11.4.2 "Totalizer" submenu

The **Totalizer** submenu contains all the parameters needed to display the current measured values for every totalizer.

#### Navigation

"Diagnostics" menu → Measured values → Totalizer

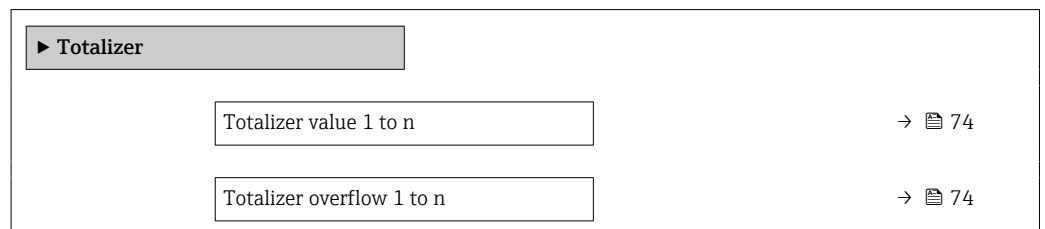

**Parameter overview with brief description**

Parameter	Prerequisite	Description	User interface
Totalizer value 1 to n	One of the following options is selected in the <b>Assign process variable</b> parameter (→ 66) of the <b>Totalizer 1 to n</b> submenu: <ul style="list-style-type: none"> <li>▪ Volume flow</li> <li>▪ Mass flow</li> <li>▪ Corrected volume flow</li> <li>▪ Target mass flow *</li> <li>▪ Carrier mass flow *</li> </ul>	Displays the current totalizer counter value.	Signed floating-point number
Totalizer overflow 1 to n	One of the following options is selected in the <b>Assign process variable</b> parameter (→ 66) of the <b>Totalizer 1 to n</b> submenu: <ul style="list-style-type: none"> <li>▪ Volume flow</li> <li>▪ Mass flow</li> <li>▪ Corrected volume flow</li> <li>▪ Target mass flow *</li> <li>▪ Carrier mass flow *</li> </ul>	Displays the current totalizer overflow.	Integer with sign

\* Visibility depends on order options or device settings

## 11.5 Adapting the measuring device to the process conditions

The following are available for this purpose:

- Basic settings using the **Setup** menu (→ 53)
- Advanced settings using the **Advanced setup** submenu (→ 62)

## 11.6 Performing a totalizer reset

### Navigation

"Operation" menu → Totalizer handling

<b>▶ Totalizer handling</b>	
Control Totalizer 1 to n	→ 75
Preset value 1 to n	→ 75
Reset all totalizers	→ 75

### Parameter overview with brief description

Parameter	Prerequisite	Description	Selection / User entry	Factory setting
Control Totalizer 1 to n	A process variable is selected in the <b>Assign process variable</b> parameter (→ 66) of the <b>Totalizer 1 to n</b> submenu.	Control totalizer value.	<ul style="list-style-type: none"> <li>■ Totalize</li> <li>■ Reset + hold</li> <li>■ Preset + hold</li> <li>■ Reset + totalize</li> <li>■ Preset + totalize</li> </ul>	–
Preset value 1 to n	A process variable is selected in the <b>Assign process variable</b> parameter (→ 66) of the <b>Totalizer 1 to n</b> submenu.	Specify start value for totalizer. <i>Dependency</i>  The unit of the selected process variable is defined in the <b>Unit totalizer</b> parameter (→ 66) for the totalizer.	Signed floating-point number	Depends on country: <ul style="list-style-type: none"> <li>■ 0 kg</li> <li>■ 0 lb</li> </ul>
Reset all totalizers	–	Reset all totalizers to 0 and start.	<ul style="list-style-type: none"> <li>■ Cancel</li> <li>■ Reset + totalize</li> </ul>	–

#### 11.6.1 Function scope of "Control Totalizer" parameter

Options	Description
Totalize	The totalizer is started or continues running.
Reset + hold	The totaling process is stopped and the totalizer is reset to 0.
Preset + hold <sup>1)</sup>	The totaling process is stopped and the totalizer is set to its defined start value from the <b>Preset value</b> parameter.
Reset + totalize	The totalizer is reset to 0 and the totaling process is restarted.
Preset + totalize <sup>1)</sup>	The totalizer is set to the defined start value in the <b>Preset value</b> parameter and the totaling process is restarted.

1) Visible depending on the order options or device settings

#### 11.6.2 Function range of "Reset all totalizers" parameter

Options	Description
Cancel	No action is executed and the user exits the parameter.
Reset + totalize	Resets all totalizers to 0 and restarts the totaling process. This deletes all the previously aggregated flow values.

## 12 Diagnostics and troubleshooting

### 12.1 General troubleshooting

#### For local display



Fault	Possible causes	Remedial action
Local display is dark, but signal output is within the valid range	The cable of the display module is not plugged in correctly.	Insert the plug correctly into the main electronics module and display module.
Local display dark and no output signals	Supply voltage does not match the voltage specified on the nameplate.	Apply the correct supply voltage → 30.
Local display dark and no output signals	Supply voltage has incorrect polarity.	Reverse polarity of supply voltage.
Local display dark and no output signals	No contact between connecting cables and terminals.	Check the electrical contact between the cable and terminals and correct if necessary.
Local display dark and no output signals	Terminals are not plugged into the I/O electronics module correctly.	Check terminals.
Local display dark and no output signals	I/O electronics module is defective.	Order spare part → 99.
Local display cannot be read, but signal output is within the valid range	Display is set too bright or too dark.	<ul style="list-style-type: none"> <li>▪ Set the display brighter by simultaneously pressing  + .</li> <li>▪ Set the display darker by simultaneously pressing  + .</li> </ul>
Local display is dark, but signal output is within the valid range	Display module is defective.	Order spare part → 99.
Backlighting of local display is red	Diagnostic event with "Alarm" diagnostic behavior has occurred.	Take remedial actions → 81
Message on local display: "Communication Error" "Check Electronics"	Communication between the display module and the electronics is interrupted.	<ul style="list-style-type: none"> <li>▪ Check the cable and the connector between the main electronics module and display module.</li> <li>▪ Order spare part → 99.</li> </ul>

#### For output signals

Fault	Possible causes	Remedial action
Green power LED on the main electronics module of the transmitter is dark	Supply voltage does not match the voltage specified on the nameplate.	Apply the correct supply voltage → 30.
Device is measuring incorrectly.	Configuration error or device is operated outside the application.	<ol style="list-style-type: none"> <li>1. Check and correct parameter configuration.</li> <li>2. Observe limit values specified in the "Technical Data".</li> </ol>

#### For access

Fault	Possible causes	Remedial action
Write access to parameters is not possible.	Hardware write protection is enabled.	Set the write protection switch on the main electronics module to the <b>OFF</b> position → 69.
Connection via EtherNet/IP is not possible.	Device plug is connected incorrectly.	Check the pin assignment of the device plugs .
Connection to the web server is not possible.	Web server is disabled.	Use the "FieldCare" or "DeviceCare" operating tool to check if the web server of the device is enabled and enable if necessary → 45.
	The Ethernet interface on the PC is incorrectly configured.	<ul style="list-style-type: none"> <li>▶ Check the properties of the Internet protocol (TCP/IP) .</li> <li>▶ Check the network settings with the IT manager.</li> </ul>

Fault	Possible causes	Remedial action
Connection to the web server is not possible.	<ul style="list-style-type: none"> <li>▪ The IP address on the PC is incorrectly configured.</li> <li>▪ IP address is not known.</li> </ul>	<ul style="list-style-type: none"> <li>▶ If addressing via hardware: open the transmitter and check the configured IP address (last octet).</li> <li>▶ Check the IP address of the device with the IT specialist.</li> <li>▶ If the IP address is not known, set DIP switch no. 10 to ON, restart the device and enter the factory IP address 192.168.1.212.</li> </ul> <p> EtherNet/IP communication is interrupted by enabling the DIP switch.</p>
	The web browser setting "Use a proxy server for LAN" is enabled on the PC.	Disable the use of the proxy server in the LAN settings.
	Apart from the active network connection to the measuring instrument, other network connections are also being used.	<ul style="list-style-type: none"> <li>▪ Make sure that no other network connections are established by the computer and close other programs with network access to the computer.</li> <li>▪ If using a docking station for notebooks, make sure that a network connection to another network is not active.</li> </ul>
Web browser is frozen and operation no longer possible	Data transfer is active.	Wait until data transfer or current action is finished.
	Connection lost	<ul style="list-style-type: none"> <li>▶ Check cable connection and power supply.</li> <li>▶ Refresh the web browser and restart if necessary.</li> </ul>
Display of web browser content is difficult to read or incomplete.	Web browser version used is not optimal.	<ul style="list-style-type: none"> <li>▶ Use correct web browser version →  40.</li> <li>▶ Empty the web browser cache.</li> <li>▶ Restart the web browser.</li> </ul>
	Unsuitable view settings.	Change the font size/display ratio of the web browser.
Incomplete or no display of content in the web browser	<ul style="list-style-type: none"> <li>▪ JavaScript is not enabled</li> <li>▪ JavaScript cannot be enabled.</li> </ul>	<ul style="list-style-type: none"> <li>▶ Enable JavaScript.</li> <li>▶ Enter http://XXX.XXX.X.XXX/servlet/basic.html as the IP address.</li> </ul>
Operation with FieldCare or DeviceCare via service interface CDI-RJ45 (port 8000) is not possible.	Firewall of the PC or network is blocking communication.	Depending on the settings of the firewall used on the PC or in the network, the firewall must be adapted or disabled to allow FieldCare/ DeviceCare access.
Flashing the firmware with FieldCare or DeviceCare via service interface CDI-RJ45 (port 8000 or TFTP ports) is not possible.	Firewall of the PC or network is blocking communication.	Depending on the settings of the firewall used on the PC or in the network, the firewall must be adapted or disabled to allow FieldCare/ DeviceCare access.

## 12.2 Diagnostic information via LEDs

### 12.2.1 Transmitter

Various LEDs in the transmitter provide information on the device status.

LED	Color	Meaning
Supply voltage	OFF	Supply voltage is off or too low
	Green	Supply voltage is ok
Device status	Green	Device status is ok
	Flashing red	A device error of diagnostic behavior "Warning" has occurred
	Red	A device error of diagnostic behavior "Alarm" has occurred
	Alternately flashing red/green	Boot loader is active

LED	Color	Meaning
Network status	OFF	Device has no EtherNet/IP address
	Green	Device's EtherNet/IP connection is active
	Flashing green	Device has EtherNet/IP address but no EtherNet/IP connection
	Red	EtherNet/IP address of the device has been assigned twice
	Flashing red	Device's EtherNet/IP connection is in timeout mode
Link/Activity	Orange	Link available but no activity
	Flashing orange	Activity present

## 12.3 Diagnostic information in the web browser

### 12.3.1 Diagnostic options

Any faults detected by the measuring device are displayed in the Web browser on the home page once the user has logged on.

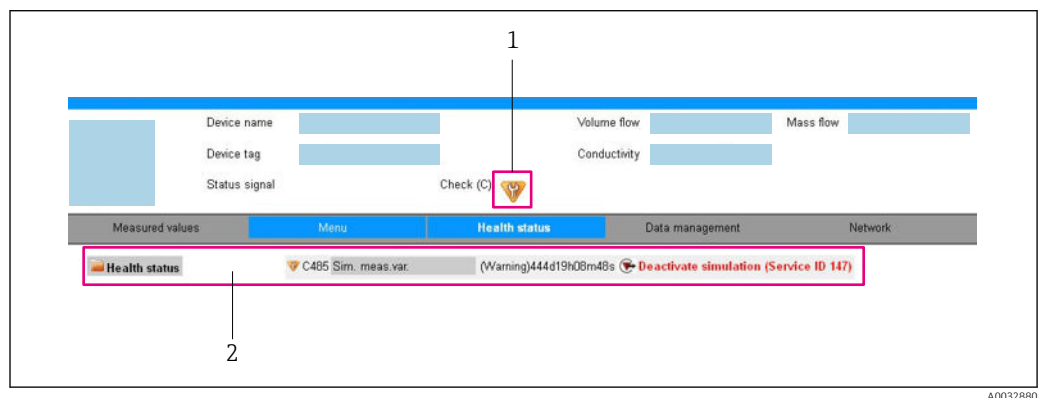

1 Status area with status signal

2 Diagnostics information → 79 and remedial measures with service ID



**i** In addition, diagnostic events which have occurred can be shown in the **Diagnostics** menu:

- Via parameter → 92
- Via submenu → 93

### Status signals

The status signals provide information on the state and reliability of the device by categorizing the cause of the diagnostic information (diagnostic event).

Symbol	Meaning
	<b>Failure</b> A device error has occurred. The measured value is no longer valid.
	<b>Function check</b> The device is in service mode (e.g. during a simulation).

Symbol	Meaning
	<b>Out of specification</b> The device is being operated: Outside its technical specification limits (e.g. outside the process temperature range)
	<b>Maintenance required</b> Maintenance is required. The measured value remains valid.

 The status signals are categorized in accordance with VDI/VDE 2650 and NAMUR Recommendation NE 107.

### Diagnostic information

The fault can be identified using the diagnostic information. The short text helps you by providing information about the fault.

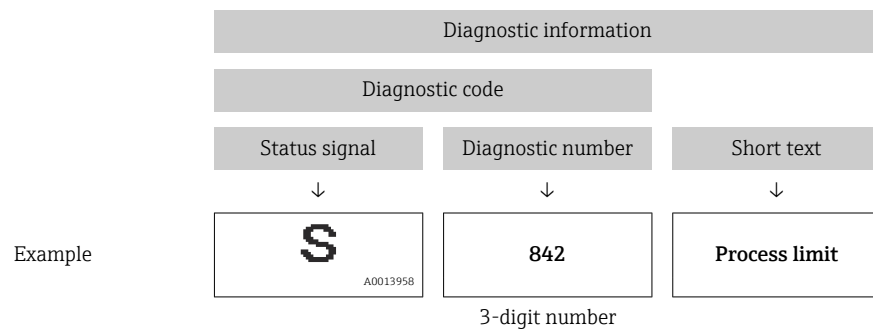

### 12.3.2 Calling up remedial actions

Remedial actions are provided for each diagnostic event to ensure that problems can be rectified quickly. These actions are displayed along with the diagnostic event and the related diagnostic information.

## 12.4 Diagnostic information in FieldCare or DeviceCare

### 12.4.1 Diagnostic options

Any faults detected by the measuring device are displayed on the home page of the operating tool once the connection has been established.

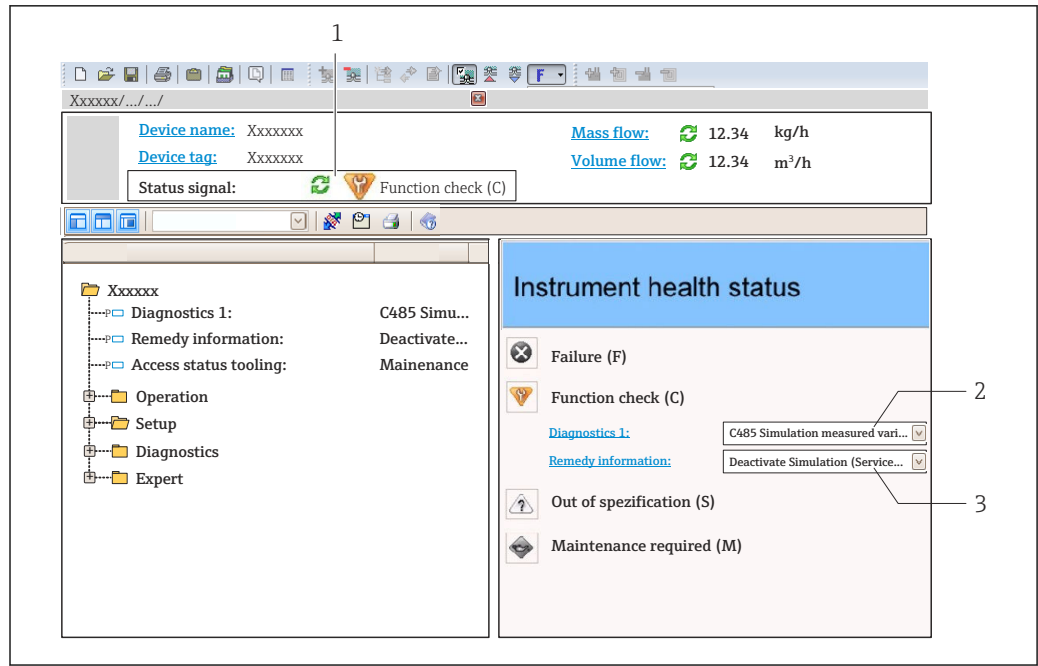

A0021799-EN

- 1 Status area with status signal
- 2 Diagnostic information → 79
- 3 Remedial actions with service ID

**i** In addition, diagnostic events which have occurred can be shown in the **Diagnostics** menu:

- Via parameter → 92
- Via submenu → 93

### Diagnostic information

The fault can be identified using the diagnostic information. The short text helps you by providing information about the fault.

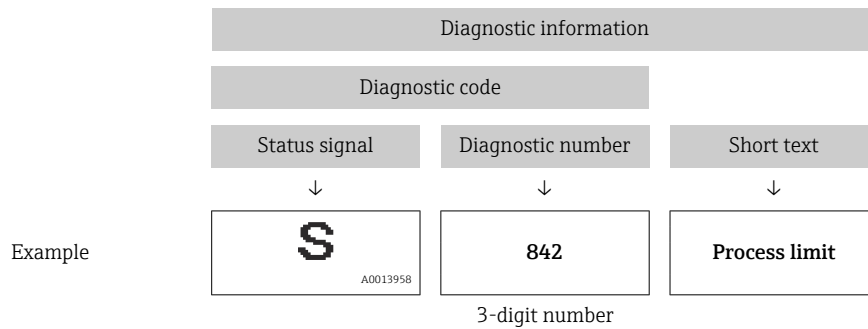

### 12.4.2 Calling up remedy information

Remedy information is provided for every diagnostic event to ensure that problems can be rectified quickly:

- On the home page  
Remedy information is displayed in a separate field below the diagnostics information.
- In the **Diagnostics** menu  
Remedy information can be called up in the working area of the user interface.

The user is in the **Diagnostics** menu.

1. Call up the desired parameter.

2. On the right in the working area, mouse over the parameter.
  - ↳ A tool tip with remedy information for the diagnostic event appears.

## 12.5 Diagnostic information via communication interface

### 12.5.1 Reading out diagnostic information

The current diagnostic event and associated diagnostic information can be read out: **Input Assembly Fix**

Input Fix Assembly byte 1 to 8							
1	2	3	4	5	6	7	8
File header (not visible)				Diagnostic number		Status signal	-

## 12.6 Adapting the diagnostic information

### 12.6.1 Adapting the diagnostic behavior

Each item of diagnostic information is assigned a specific diagnostic behavior at the factory. The user can change this assignment for specific diagnostic information in the **Diagnostic behavior** submenu.



Expert → System → Diagnostic handling → Diagnostic behavior

You can assign the following options to the diagnostic number as the diagnostic behavior:

Options	Description
Alarm	The device stops measurement. The totalizers assume the defined alarm condition. A diagnostic message is generated.
Warning	The device continues to measure. The totalizers are not affected. A diagnostic message is generated.
Logbook entry only	The device continues to measure. The diagnostic message is entered only in the <b>Event logbook</b> submenu ( <b>Event list</b> submenu) and is not displayed in alternating sequence with the measured value display.
Off	The diagnostic event is ignored, and no diagnostic message is generated or entered.

## 12.7 Overview of diagnostic information

-  The amount of diagnostic information and the number of measured variables affected increase if the measuring device has one or more application packages.
  - All of the measured variables affected in the entire Promass instrument family are always listed under "Measured variables affected". The measured variables available for the device in question depend on the device version. When assigning the measured variables to the device functions, for example to the individual outputs, all of the measured variables available for the device version in question are available for selection.

 In the case of some items of diagnostic information, the diagnostic behavior can be changed. Adapting the diagnostic information →  81

## 12.7.1 Diagnostic of sensor

Diagnostic information		Remedy instructions	Coding of diagnostic information (hex)	
No.	Short text			
022	Sensor temperature	1. Change main electronic module 2. Change sensor	<ul style="list-style-type: none"> <li>■ 0x10000BE</li> <li>■ 0x10000BF</li> <li>■ 0x10000D5</li> <li>■ 0x10000D6</li> </ul>	
	Status signal			F
	Diagnostic behavior			Alarm

Diagnostic information		Remedy instructions	Coding of diagnostic information (hex)	
No.	Short text			
046	Sensor limit exceeded	1. Inspect sensor 2. Check process condition	<ul style="list-style-type: none"> <li>■ 0x80000C8</li> <li>■ 0x80000CA</li> </ul>	
	Status signal			S
	Diagnostic behavior			Alarm

Diagnostic information		Remedy instructions	Coding of diagnostic information (hex)	
No.	Short text			
062	Sensor connection	1. Change main electronic module 2. Change sensor	<ul style="list-style-type: none"> <li>■ 0x10000DB</li> <li>■ 0x10000DC</li> <li>■ 0x1000113</li> <li>■ 0x1000114</li> </ul>	
	Status signal			F
	Diagnostic behavior			Alarm

Diagnostic information		Remedy instructions	Coding of diagnostic information (hex)	
No.	Short text			
082	Data storage	1. Check module connections 2. Contact service	0x10000E7	
	Status signal			F
	Diagnostic behavior			Alarm

Diagnostic information		Remedy instructions	Coding of diagnostic information (hex)	
No.	Short text			
083	Memory content	1. Restart device 2. Contact service	0x10000A0	
	Status signal			F
	Diagnostic behavior			Alarm

Diagnostic information		Remedy instructions	Coding of diagnostic information (hex)	
No.	Short text			
140	Sensor signal	1. Check or change main electronics 2. Change sensor	0x80000CC	
	Status signal			S
	Diagnostic behavior			Alarm

Diagnostic information		Remedy instructions	Coding of diagnostic information (hex)	
No.	Short text			
144	Measuring error too high	1. Check process conditions 2. Check or change sensor	0x10001C7	
	Status signal			F
	Diagnostic behavior			Alarm

Diagnostic information		Remedy instructions	Coding of diagnostic information (hex)	
No.	Short text			
190	Special event 1	Contact service	0x10000EA	
	Status signal			F
	Diagnostic behavior			Alarm

Diagnostic information		Remedy instructions	Coding of diagnostic information (hex)	
No.	Short text			
191	Special event 5	Contact service	0x1000129	
	Status signal			F
	Diagnostic behavior			Alarm

Diagnostic information		Remedy instructions	Coding of diagnostic information (hex)	
No.	Short text			
192	Special event 9	Contact service	0x1000150	
	Status signal			F
	Diagnostic behavior [from the factory] <sup>1)</sup>			Alarm

1) Diagnostic behavior can be changed.

### 12.7.2 Diagnostic of electronic

Diagnostic information		Remedy instructions	Coding of diagnostic information (hex)	
No.	Short text			
201	Device failure	1. Restart device 2. Contact service	0x100014B	
	Status signal			F
	Diagnostic behavior			Alarm

Diagnostic information		Remedy instructions	Coding of diagnostic information (hex)	
No.	Short text			
242	Software incompatible	1. Check software 2. Flash or change main electronics module	0x1000067	
	Status signal			F
	Diagnostic behavior			Alarm

Diagnostic information		Remedy instructions	Coding of diagnostic information (hex)	
No.	Short text			
252	Modules incompatible	1. Check electronic modules 2. Change electronic modules	0x100006B	
	Status signal			F
	Diagnostic behavior			Alarm

Diagnostic information		Remedy instructions	Coding of diagnostic information (hex)	
No.	Short text			
262	Module connection	1. Check module connections 2. Change main electronics	0x1000149	
	Status signal			F
	Diagnostic behavior			Alarm

Diagnostic information		Remedy instructions	Coding of diagnostic information (hex)	
No.	Short text			
270	Main electronic failure	Change main electronic module	<ul style="list-style-type: none"> <li>■ 0x100007C</li> <li>■ 0x100007F</li> <li>■ 0x1000080</li> <li>■ 0x100009F</li> <li>■ 0x10000A1</li> <li>■ 0x10000D4</li> </ul>	
	Status signal			F
	Diagnostic behavior			Alarm

Diagnostic information		Remedy instructions	Coding of diagnostic information (hex)	
No.	Short text			
271	Main electronic failure	1. Restart device 2. Change main electronic module	0x100007D	
	Status signal			F
	Diagnostic behavior			Alarm

Diagnostic information		Remedy instructions	Coding of diagnostic information (hex)	
No.	Short text			
272	Main electronic failure	1. Restart device 2. Contact service	0x1000079	
	Status signal			F
	Diagnostic behavior			Alarm

Diagnostic information		Remedy instructions	Coding of diagnostic information (hex)	
No.	Short text			
273	Main electronic failure	Change electronic	<ul style="list-style-type: none"> <li>■ 0x1000098</li> <li>■ 0x10000E5</li> <li>■ 0x100010B</li> </ul>	
	Status signal			F
	Diagnostic behavior			Alarm

Diagnostic information		Remedy instructions	Coding of diagnostic information (hex)	
No.	Short text			
274	Main electronic failure	Change electronic	<ul style="list-style-type: none"> <li>■ 0x80000CE</li> <li>■ 0x80000CF</li> </ul>	
	Status signal			S
	Diagnostic behavior			Warning

Diagnostic information		Remedy instructions	Coding of diagnostic information (hex)	
No.	Short text			
283	Memory content	<ol style="list-style-type: none"> <li>1. Reset device</li> <li>2. Contact service</li> </ol>	0x100016F	
	Status signal			F
	Diagnostic behavior			Alarm

Diagnostic information		Remedy instructions	Coding of diagnostic information (hex)	
No.	Short text			
311	Electronic failure	<ol style="list-style-type: none"> <li>1. Reset device</li> <li>2. Contact service</li> </ol>	0x10000E1	
	Status signal			F
	Diagnostic behavior			Alarm

Diagnostic information		Remedy instructions	Coding of diagnostic information (hex)	
No.	Short text			
311	Electronic failure	<ol style="list-style-type: none"> <li>1. Do not reset device</li> <li>2. Contact service</li> </ol>	0x40000E2	
	Status signal			M
	Diagnostic behavior			Warning

Diagnostic information		Remedy instructions	Coding of diagnostic information (hex)	
No.	Short text			
382	Data storage	<ol style="list-style-type: none"> <li>1. Insert DAT module</li> <li>2. Change DAT module</li> </ol>	0x100016D	
	Status signal			F
	Diagnostic behavior			Alarm

Diagnostic information		Remedy instructions	Coding of diagnostic information (hex)	
No.	Short text			
383	Memory content	<ol style="list-style-type: none"> <li>1. Restart device</li> <li>2. Check or change DAT module 3.</li> <li>Contact service</li> </ol>	0x100016E	
	Status signal			F
	Diagnostic behavior			Alarm

No.	Diagnostic information		Remedy instructions	Coding of diagnostic information (hex)
	Short text			
390	Special event 2		Contact service	0x1000112
	Status signal	F		
	Diagnostic behavior	Alarm		

No.	Diagnostic information		Remedy instructions	Coding of diagnostic information (hex)
	Short text			
391	Special event 6		Contact service	0x1000128
	Status signal	F		
	Diagnostic behavior	Alarm		

No.	Diagnostic information		Remedy instructions	Coding of diagnostic information (hex)
	Short text			
392	Special event 10		Contact service	0x1000151
	Status signal	F		
	Diagnostic behavior [from the factory] <sup>1)</sup>	Alarm		

1) Diagnostic behavior can be changed.

### 12.7.3 Diagnostic of configuration

No.	Diagnostic information		Remedy instructions	Coding of diagnostic information (hex)
	Short text			
410	Data transfer		1. Check connection 2. Retry data transfer	0x100008B
	Status signal	F		
	Diagnostic behavior	Alarm		

No.	Diagnostic information		Remedy instructions	Coding of diagnostic information (hex)
	Short text			
411	Up-/download active		Up-/download active, please wait	<ul style="list-style-type: none"> <li>■ 0x2000068</li> <li>■ 0x2000069</li> <li>■ 0x200006C</li> </ul>
	Status signal	C		
	Diagnostic behavior	Warning		

No.	Diagnostic information		Remedy instructions	Coding of diagnostic information (hex)
	Short text			
437	Configuration incompatible		1. Restart device 2. Contact service	0x1000060
	Status signal	F		
	Diagnostic behavior	Alarm		

Diagnostic information		Remedy instructions	Coding of diagnostic information (hex)	
No.	Short text			
438	Dataset	1. Check data set file 2. Check device configuration 3. Up- and download new configuration	0x400006A	
	Status signal			M
	Diagnostic behavior			Warning

Diagnostic information		Remedy instructions	Coding of diagnostic information (hex)	
No.	Short text			
453	Flow override	Deactivate flow override	0x2000094	
	Status signal			C
	Diagnostic behavior			Warning

Diagnostic information		Remedy instructions	Coding of diagnostic information (hex)	
No.	Short text			
484	Simulation failure mode	Deactivate simulation	0x2000090	
	Status signal			C
	Diagnostic behavior			Alarm

Diagnostic information		Remedy instructions	Coding of diagnostic information (hex)	
No.	Short text			
485	Simulation measured variable	Deactivate simulation	0x2000093	
	Status signal			C
	Diagnostic behavior			Warning

Diagnostic information		Remedy instructions	Coding of diagnostic information (hex)	
No.	Short text			
495	Simulation diagnostic event	Deactivate simulation	0x200015E	
	Status signal			C
	Diagnostic behavior			Warning

Diagnostic information		Remedy instructions	Coding of diagnostic information (hex)	
No.	Short text			
537	Configuration	1. Check IP addresses in network 2. Change IP address	0x100014A	
	Status signal			F
	Diagnostic behavior			Warning

Diagnostic information		Remedy instructions	Coding of diagnostic information (hex)	
No.	Short text			
590	Special event 3	Contact service	0x1000124	
	Status signal			F
	Diagnostic behavior			Alarm

Diagnostic information		Remedy instructions	Coding of diagnostic information (hex)	
No.	Short text			
591	Special event 7	Contact service	0x1000127	
	Status signal			F
	Diagnostic behavior			Alarm

Diagnostic information		Remedy instructions	Coding of diagnostic information (hex)	
No.	Short text			
592	Special event 11	Contact service	0x1000152	
	Status signal			F
	Diagnostic behavior [from the factory] <sup>1)</sup>			Alarm

1) Diagnostic behavior can be changed.

### 12.7.4 Diagnostic of process

Diagnostic information		Remedy instructions	Coding of diagnostic information (hex)	
No.	Short text			
825	Operating temperature	1. Check ambient temperature 2. Check process temperature	<ul style="list-style-type: none"> <li>■ 0x8000085</li> <li>■ 0x8000087</li> </ul>	
	Status signal			S
	Diagnostic behavior			Warning

Diagnostic information		Remedy instructions	Coding of diagnostic information (hex)	
No.	Short text			
825	Operating temperature	1. Check ambient temperature 2. Check process temperature	0x1000088	
	Status signal			F
	Diagnostic behavior			Alarm

Diagnostic information		Remedy instructions	Coding of diagnostic information (hex)	
No.	Short text			
830	Sensor temperature too high	Reduce ambient temp. around the sensor housing	0x80000C0	
	Status signal			S
	Diagnostic behavior			Warning

Diagnostic information		Remedy instructions	Coding of diagnostic information (hex)	
No.	Short text			
831	Sensor temperature too low	Increase ambient temp. around the sensor housing	0x80000C2	
	Status signal			S
	Diagnostic behavior			Warning

Diagnostic information		Remedy instructions	Coding of diagnostic information (hex)	
No.	Short text			
832	Electronic temperature too high	Reduce ambient temperature	0x80000C3	
	Status signal			S
	Diagnostic behavior [from the factory] <sup>1)</sup>			Warning

1) Diagnostic behavior can be changed.

Diagnostic information		Remedy instructions	Coding of diagnostic information (hex)	
No.	Short text			
833	Electronic temperature too low	Increase ambient temperature	0x80000C1	
	Status signal			S
	Diagnostic behavior [from the factory] <sup>1)</sup>			Warning

1) Diagnostic behavior can be changed.

Diagnostic information		Remedy instructions	Coding of diagnostic information (hex)	
No.	Short text			
834	Process temperature too high	Reduce process temperature	0x80000C5	
	Status signal			S
	Diagnostic behavior [from the factory] <sup>1)</sup>			Warning

1) Diagnostic behavior can be changed.

Diagnostic information		Remedy instructions	Coding of diagnostic information (hex)	
No.	Short text			
835	Process temperature too low	Increase process temperature	0x80000C6	
	Status signal			S
	Diagnostic behavior [from the factory] <sup>1)</sup>			Warning

1) Diagnostic behavior can be changed.

Diagnostic information		Remedy instructions	Coding of diagnostic information (hex)	
No.	Short text			
842	Process limit	Low flow cut off active! 1. Check low flow cut off configuration	0x8000091	
	Status signal			S
	Diagnostic behavior			Warning

Diagnostic information		Remedy instructions	Coding of diagnostic information (hex)	
No.	Short text			
843	Process limit	Check process conditions	0x8000123	
	Status signal			S
	Diagnostic behavior			Warning

Diagnostic information		Remedy instructions	Coding of diagnostic information (hex)	
No.	Short text			
862	Partly filled pipe	1. Check for gas in process 2. Adjust detection limits	0x8000092	
	Status signal			S
	Diagnostic behavior			Warning

Diagnostic information		Remedy instructions	Coding of diagnostic information (hex)	
No.	Short text			
882	Input signal	1. Check input configuration 2. Check external device or process conditions	<ul style="list-style-type: none"> <li>▪ 0x1000031</li> <li>▪ 0x1000257</li> </ul>	
	Status signal			F
	Diagnostic behavior			Alarm

Diagnostic information		Remedy instructions	Coding of diagnostic information (hex)	
No.	Short text			
910	Tubes not oscillating	1. Check electronic 2. Inspect sensor	0x1000050	
	Status signal			F
	Diagnostic behavior			Alarm

Diagnostic information		Remedy instructions	Coding of diagnostic information (hex)	
No.	Short text			
912	Medium inhomogeneous	1. Check process cond. 2. Increase system pressure	<ul style="list-style-type: none"> <li>▪ 0x80000C4</li> <li>▪ 0x80000DF</li> </ul>	
	Status signal			S
	Diagnostic behavior			Warning

Diagnostic information		Remedy instructions	Coding of diagnostic information (hex)	
No.	Short text			
912	Inhomogeneous	1. Check process cond. 2. Increase system pressure	<ul style="list-style-type: none"> <li>■ 0x8000115</li> <li>■ 0x8000162</li> </ul>	
	Status signal			S
	Diagnostic behavior			Warning

Diagnostic information		Remedy instructions	Coding of diagnostic information (hex)	
No.	Short text			
913	Medium unsuitable	1. Check process conditions 2. Check electronic modules or sensor	0x80000CD	
	Status signal			S
	Diagnostic behavior			Alarm

Diagnostic information		Remedy instructions	Coding of diagnostic information (hex)	
No.	Short text			
944	Monitoring failed	Check process conditions for Heartbeat Monitoring	0x80001C6	
	Status signal			S
	Diagnostic behavior			Warning

Diagnostic information		Remedy instructions	Coding of diagnostic information (hex)	
No.	Short text			
948	Tube damping too high	Check process conditions	0x8000168	
	Status signal			S
	Diagnostic behavior			Warning

Diagnostic information		Remedy instructions	Coding of diagnostic information (hex)	
No.	Short text			
990	Special event 4	Contact service	0x1000125	
	Status signal			F
	Diagnostic behavior			Alarm

Diagnostic information		Remedy instructions	Coding of diagnostic information (hex)	
No.	Short text			
991	Special event 8	Contact service	0x1000126	
	Status signal			F
	Diagnostic behavior			Alarm



No.	Diagnostic information		Remedy instructions	Coding of diagnostic information (hex)
	Short text			
992	Special event 12		Contact service	0x100011F
	Status signal	F		
	Diagnostic behavior [from the factory] <sup>1)</sup>	Alarm		



1) Diagnostic behavior can be changed.

## 12.8 Pending diagnostic events

The **Diagnostics** menu allows the user to view the current diagnostic event and the previous diagnostic event separately.





 Accessing the remedial action for a diagnostic event:

- Via web browser →  79
- Via "FieldCare" operating tool →  79
- Via "DeviceCare" operating tool →  79

 Other pending diagnostic events can be displayed in the **Diagnostic list** submenu →  93.

### Navigation

"Diagnostics" menu

Diagnostics	
Actual diagnostics	→  92
Previous diagnostics	→  92
Operating time from restart	→  93
Operating time	→  93

### Parameter overview with brief description

Parameter	Prerequisite	Description	User interface
Actual diagnostics	A diagnostic event has occurred.	Shows the current occurred diagnostic event along with its diagnostic information.  If two or more messages occur simultaneously, the message with the highest priority is shown on the display.	Symbol for diagnostic behavior, diagnostic code and short message.
Previous diagnostics	Two diagnostic events have already occurred.	Shows the diagnostic event that occurred prior to the current diagnostic event along with its diagnostic information.	Symbol for diagnostic behavior, diagnostic code and short message.

Parameter	Prerequisite	Description	User interface
Operating time from restart	–	Shows the time the device has been in operation since the last device restart.	Days (d), hours (h), minutes (m) and seconds (s)
Operating time	–	Indicates how long the device has been in operation.	Days (d), hours (h), minutes (m) and seconds (s)

## 12.9 Diagnostic list

Up to 5 currently pending diagnostic events are displayed in the **Diagnostic list** submenu along with the associated diagnostic information. If more than 5 diagnostic events are pending, the events with the highest priority are shown on the display.

### Navigation path

Diagnostics → Diagnostic list



Accessing the remedial action for a diagnostic event:

- Via web browser → 79
- Via "FieldCare" operating tool → 79
- Via "DeviceCare" operating tool → 79

## 12.10 Event logbook

### 12.10.1 Reading out the event logbook

A chronological overview of the event messages that have occurred is provided in the **Event logbook** submenu.

### Navigation path

Diagnostics menu → **Event logbook** submenu → Event logbook

The event history includes entries for:

- Diagnostic events → 81
- Information events → 94

In addition to the operating time when the event occurred, each event is also assigned a symbol that indicates whether the event has occurred or is finished:

- Diagnostic event
  - ☹: Occurrence of the event
  - ☺: End of the event
- Information event
  - ☹: Occurrence of the event



Accessing the remedial action for a diagnostic event:

- Via web browser → 79
- Via "FieldCare" operating tool → 79
- Via "DeviceCare" operating tool → 79



Filtering the displayed event messages → 93

### 12.10.2 Filtering the event logbook

Using the **Filter options** parameter you can define which category of event message is displayed in the **Events list** submenu.

### Navigation path

Diagnostics → Event logbook → Filter options

**Filter categories**

- All
- Failure (F)
- Function check (C)
- Out of specification (S)
- Maintenance required (M)
- Information (I)

**12.10.3 Overview of information events**

Unlike a diagnostic event, an information event is displayed in the event logbook only and not in the diagnostic list.

Info number	Info name
I1000	----- (Device ok)
I1089	Power on
I1090	Configuration reset
I1091	Configuration changed
I1110	Write protection switch changed
I1111	Density adjust failure
I1137	Electronic changed
I1151	History reset
I1155	Reset electronic temperature
I1157	Memory error event list
I1185	Display backup done
I1186	Restore via display done
I1187	Settings downloaded with display
I1188	Display data cleared
I1189	Backup compared
I1209	Density adjustment ok
I1221	Zero point adjust failure
I1222	Zero point adjustment ok
I1256	Display: access status changed
I1264	Safety sequence aborted
I1335	Firmware changed
I1361	Wrong web server login
I1397	Fieldbus: access status changed
I1398	CDI: access status changed
I1444	Device verification passed
I1445	Device verification failed
I1446	Device verification active
I1447	Record application reference data
I1448	Application reference data recorded
I1449	Recording application ref. data failed
I1450	Monitoring off
I1451	Monitoring on
I1457	Failed: Measured error verification

Info number	Info name
I1459	Failed: I/O module verification
I1460	Failed: Sensor integrity verification
I1461	Failed: Sensor verification
I1462	Failed:Sensor electronic module verific.

## 12.11 Resetting the device

The entire device configuration or some of the configuration can be reset to a defined state with the **Device reset** parameter (→  67).

### 12.11.1 Function scope of the "Device reset" parameter









Options	Description
Cancel	No action is executed and the user exits the parameter.
To delivery settings	Every parameter for which a customer-specific default setting was ordered is reset to the customer-specific value. All other parameters are reset to the factory setting.  This option is not visible if no customer-specific settings have been ordered.
Restart device	The restart resets every parameter with data stored in volatile memory (RAM) to the factory setting (e.g. measured value data). The device configuration remains unchanged.

## 12.12 Device information

The **Device information** submenu contains all parameters that display different information for device identification.





### Navigation

"Diagnostics" menu → Device information

▶ Device information 	
Device tag	→  96
Serial number	→  96
Firmware version	→  96
Device name	→  96
Order code	→  96
Extended order code 1	→  96
Extended order code 2	→  96
Extended order code 3	→  96

ENP version	→ 96
IP address	
Subnet mask	
Default gateway	

### Parameter overview with brief description

Parameter	Description	User interface	Factory setting
Device tag	Shows name of measuring point.	Max. 32 characters, such as letters, numbers or special characters (e.g. @, %, /).	–
Serial number	Shows the serial number of the measuring device.	Max. 11-digit character string comprising letters and numbers.	–
Firmware version	Shows the device firmware version installed.	Character string in the format xx.yy.zz	–
Device name	Shows the name of the transmitter.  The name can be found on the nameplate of the transmitter.	Max. 32 characters such as letters or numbers.	Cubemass 100
Order code	Shows the device order code.  The order code can be found on the nameplate of the sensor and transmitter in the "Order code" field.	Character string composed of letters, numbers and certain punctuation marks (e.g. /).	–
Extended order code 1	Shows the 1st part of the extended order code.  The extended order code can also be found on the nameplate of the sensor and transmitter in the "Ext. ord. cd." field.	Character string	–
Extended order code 2	Shows the 2nd part of the extended order code.  The extended order code can also be found on the nameplate of the sensor and transmitter in the "Ext. ord. cd." field.	Character string	–
Extended order code 3	Shows the 3rd part of the extended order code.  The extended order code can also be found on the nameplate of the sensor and transmitter in the "Ext. ord. cd." field.	Character string	–
ENP version	Shows the version of the electronic nameplate (ENP).	Character string	–

## 12.13 Firmware history

Release date	Firmware version	Order code for "Firmware version"	Firmware Changes	Documentation type	Documentation
06.2012	01.00.00	–	Original firmware	Operating instructions	–
04.2013	01.01.zz	Option 73	<ul style="list-style-type: none"> <li>▪ Fieldbus access level was changed from service to maintenance</li> <li>▪ Improved calculation: <ul style="list-style-type: none"> <li>▪ Target mass flow</li> <li>▪ Carrier mass flow</li> </ul> </li> <li>▪ Option to access application packages: <ul style="list-style-type: none"> <li>▪ Heartbeat Technology</li> <li>▪ Concentration</li> </ul> </li> </ul>	Operating instructions	BA01183D/06/EN/01.13
10.2014	01.02.zz	Option 71	<ul style="list-style-type: none"> <li>▪ Integration of optional local display</li> <li>▪ Heartbeat Technology functionality for Rockwell AOP</li> <li>▪ New unit "Beer Barrel (BBL)"</li> <li>▪ Monitoring of measuring tube damping</li> <li>▪ Simulation of diagnostic events</li> </ul>	Operating instructions	BA01183D/06/EN/02.14



It is possible to flash the firmware to the current version or an existing previous version via the service interface.



For the compatibility of the firmware version with the previous version, the installed device description files and operating tools, observe the information about the device in the "Manufacturer's information" document.



The manufacturer's information is available:

- In the Download Area of the Endress+Hauser Web site: [www.endress.com](http://www.endress.com) → Downloads
- Specify the following details:
  - Text search: Manufacturer's information
  - Media type: Documentation – Technical Documentation

## 13 Maintenance

### 13.1 Maintenance work

No special maintenance work is required.

#### 13.1.1 Cleaning

##### Cleaning of surfaces not in contact with the medium

1. Recommendation: Use a lint-free cloth that is either dry or slightly dampened using water.
2. Do not use sharp objects or aggressive cleaning agents that could damage surfaces (e.g. displays, housing) and seals.
3. Do not use high-pressure steam.
4. Ensure compliance with the protection class of the device.

##### NOTICE

##### Cleaning agents can damage the surfaces!

Incorrect cleaning agents can damage the surfaces!

- ▶ Do not use cleaning agents containing concentrated mineral acids, alkalis or organic solvents e.g. benzyl alcohol, methylene chloride, xylene, concentrated glycerol cleaners or acetone.

##### Cleaning of surfaces in contact with the medium

Note the following for cleaning and sterilization in place (CIP/SIP):

- Use only cleaning agents to which the materials in contact with the medium are sufficiently resistant.
- Observe the permitted maximum medium temperature.

### 13.2 Measuring and test equipment

Endress+Hauser offers a variety of measuring and testing equipment, such as Netilion or device tests.

 Your Endress+Hauser Sales Center can provide detailed information on the services.

List of some of the measuring and testing equipment: →  102

### 13.3 Maintenance services

Endress+Hauser offers a wide variety of services for maintenance such as recalibration, maintenance service or device tests.

 Your Endress+Hauser Sales Center can provide detailed information on the services.

## 14 Repair

### 14.1 General notes

#### 14.1.1 Repair and conversion concept

The Endress+Hauser repair and conversion concept provides for the following:

- The measuring devices have a modular design.
- Spare parts are grouped into logical kits with the associated Installation Instructions.
- Repairs are carried out by Endress+Hauser Service or by appropriately trained customers.
- Certified devices can only be converted to other certified devices by Endress+Hauser Service or at the factory.

#### 14.1.2 Notes for repair and conversion



For repair and conversion of a measuring device, observe the following notes:

- ▶ Use only original Endress+Hauser spare parts.
- ▶ Carry out the repair according to the Installation Instructions.
- ▶ Observe the applicable standards, federal/national regulations, Ex documentation (XA) and certificates.
- ▶ Document all repairs and conversions and enter the details in Netilion Analytics.

### 14.2 Spare parts

*Device Viewer* ([www.endress.com/deviceviewer](http://www.endress.com/deviceviewer)):

All the spare parts for the measuring device, along with the order code, are listed here and can be ordered. If available, users can also download the associated Installation Instructions.

-  Measuring device serial number:
  - Is located on the nameplate of the device.
  - Can be read out via the **Serial number** parameter (→  96) in the **Device information** submenu.

### 14.3 Repair services

Endress+Hauser offers a wide range of services.

-  Your Endress+Hauser Sales Center can provide detailed information on the services.

### 14.4 Return

The requirements for safe device return can vary depending on the device type and national legislation.

1. Refer to the web page for information: <https://www.endress.com>
2. If returning the device, pack the device in such a way that it is reliably protected against impact and external influences. The original packaging provides the best protection.

## 14.5 Disposal

 If required by the Directive 2012/19/EU on waste electrical and electronic equipment (WEEE), the product is marked with the depicted symbol in order to minimize the disposal of WEEE as unsorted municipal waste. Do not dispose of products bearing this marking as unsorted municipal waste. Instead, return them to the manufacturer for disposal under the applicable conditions.

### 14.5.1 Removing the measuring instrument

1. Switch off the device.

 **WARNING**

**Danger to persons from process conditions!**

- ▶ Beware of hazardous process conditions such as pressure in the measuring instrument, high temperatures or aggressive media.

2. Carry out the installation and connection steps from the "Installing the device" and "Connecting the device" sections in reverse order. Observe the safety instructions.

### 14.5.2 Disposing of the measuring instrument

 **WARNING**

**Danger to personnel and environment from fluids that are hazardous to health.**

- ▶ Ensure that the measuring device and all cavities are free of fluid residues that are hazardous to health or the environment, e.g. substances that have permeated into crevices or diffused through plastic.

Observe the following notes during disposal:





- ▶ Observe valid federal/national regulations.
- ▶ Ensure proper separation and reuse of the device components.

## 15 Accessories



Various accessories, which can be ordered with the device or subsequently from Endress+Hauser, are available for the device. Detailed information on the order code in question is available from your local Endress+Hauser sales center or on the product page of the Endress+Hauser website: [www.endress.com](http://www.endress.com).

### 15.1 Device-specific accessories



### 15.2 Communication-specific accessories

Accessories	Description
Commubox FXA291	<p>Connects Endress+Hauser field devices with a CDI interface (= Endress+Hauser Common Data Interface) and the USB port of a computer or laptop.</p> <p> Technical Information TI00405C</p>
Fieldgate FXA42	<p>Transmission of the measured values of connected 4 to 20 mA analog measuring instruments, as well as digital measuring instruments</p> <p> <ul style="list-style-type: none"> <li>▪ Technical Information TI01297S</li> <li>▪ Operating Instructions BA01778S</li> <li>▪ Product page: <a href="http://www.endress.com/fxa42">www.endress.com/fxa42</a></li> </ul> </p>
Field Xpert SMT50	<p>The Field Xpert SMT50 tablet PC for device configuration enables mobile plant asset management in non-hazardous areas. It is suitable for commissioning and maintenance staff to manage field instruments with a digital communication interface and to record progress.</p> <p>This tablet PC is designed as an all-in-one solution with a preinstalled driver library and is an easy-to-use, touch-sensitive tool which can be used to manage field instruments throughout their entire life cycle.</p> <p> <ul style="list-style-type: none"> <li>▪ Technical Information TI01555S</li> <li>▪ Operating Instructions BA02053S</li> <li>▪ Product page: <a href="http://www.endress.com/smt50">www.endress.com/smt50</a></li> </ul> </p>
Field Xpert SMT70	<p>The Field Xpert SMT70 tablet PC for device configuration enables mobile plant asset management in hazardous and non-hazardous areas. It is suitable for commissioning and maintenance staff to manage field instruments with a digital communication interface and to record progress.</p> <p>This tablet PC is designed as an all-in-one solution with a preinstalled driver library and is an easy-to-use, touch-sensitive tool which can be used to manage field instruments throughout their entire life cycle.</p> <p> <ul style="list-style-type: none"> <li>▪ Technical Information TI01342S</li> <li>▪ Operating Instructions BA01709S</li> <li>▪ Product page: <a href="http://www.endress.com/smt70">www.endress.com/smt70</a></li> </ul> </p>
Field Xpert SMT77	<p>The Field Xpert SMT77 tablet PC for device configuration enables mobile plant asset management in areas categorized as Ex Zone 1.</p> <p> <ul style="list-style-type: none"> <li>▪ Technical Information TI01418S</li> <li>▪ Operating Instructions BA01923S</li> <li>▪ Product page: <a href="http://www.endress.com/smt77">www.endress.com/smt77</a></li> </ul> </p>

## 15.3 Service-specific accessories

Accessory	Description
Applicator	<p>Software for selecting and sizing Endress+Hauser measuring instruments:</p> <ul style="list-style-type: none"> <li>▪ Choice of measuring instruments for industrial requirements</li> <li>▪ Calculation of all the necessary data for identifying the optimum flowmeter: e.g. nominal diameter, pressure loss, flow velocity and measurement accuracy.</li> <li>▪ Graphic display of the calculation results</li> <li>▪ Determining the partial order code. Administration, documentation and access to all project-related data and parameters over the entire life cycle of a project.</li> </ul> <p>Applicator is available: Via the Internet: <a href="https://portal.endress.com/webapp/applicator">https://portal.endress.com/webapp/applicator</a></p>
Netilion	<p>IIoT ecosystem: Unlock knowledge</p> <p>With the Netilion IIoT ecosystem, Endress+Hauser allows you to optimize your plant performance, digitize workflows, share knowledge, and enhance collaboration.</p> <p>Based on decades of experience in process automation, Endress+Hauser offers the process industry an IIoT ecosystem that enables you to gain useful insights from data. These insights can be used to optimize processes, leading to increased plant availability, efficiency, and reliability - ultimately resulting in a more profitable plant.</p> <p><a href="http://www.netilion.endress.com">www.netilion.endress.com</a></p>
FieldCare	<p>FDT-based plant asset management tool from Endress+Hauser. It can configure all intelligent field units in your system and helps you manage them. By using the status information, it is also a simple but effective way of checking their status and condition.</p> <p> Operating Instructions BA00027S and BA00059S</p>
DeviceCare	<p>Tool to connect and configure Endress+Hauser field devices.</p> <p> <ul style="list-style-type: none"> <li>▪ Technical Information: TI01134S</li> <li>▪ Innovation brochure: IN01047S</li> </ul> </p>

## 15.4 System components

Accessories	Description
Memograph M graphic data manager	<p>The Memograph M graphic data manager provides information on all the relevant measured variables. Measured values are recorded correctly, limit values are monitored and measuring points analyzed. The data are stored in the 256 MB internal memory and also on a SD card or USB stick.</p> <p> <ul style="list-style-type: none"> <li>▪ Technical Information TI00133R</li> <li>▪ Operating Instructions BA00247R</li> </ul> </p>
iTEMP	<p>The temperature transmitters can be used in all applications and are suitable for the measurement of gases, steam and liquids. They can be used to read in the medium temperature.</p> <p> "Fields of Activity" document FA00006T</p>

## 16 Technical data

### 16.1 Application

The measuring device is intended only for the flow measurement of liquids and gases.

Depending on the version ordered, the measuring device can also measure potentially explosive, flammable, poisonous and oxidizing media.

To ensure that the device remains in proper operating condition for its service life, use the measuring device only for media against which the process-wetted materials are sufficiently resistant.

### 16.2 Function and system design

---

Measuring principle	Mass flow measurement based on the Coriolis measuring principle
Measuring system	<p>The device consists of a transmitter and a sensor.</p> <p>The device is available as a compact version: The transmitter and sensor form a mechanical unit.</p> <p>For information on the structure of the measuring instrument →  12</p>

---

## 16.3 Input

Measured variable

### Direct measured variables

- Mass flow
- Density
- Temperature

### Calculated measured variables

- Volume flow
- Corrected volume flow
- Reference density

Measuring range

### Measuring range for liquids

DN		Measuring range full scale values $\dot{m}_{\min(F)}$ to $\dot{m}_{\max(F)}$	
[mm]	[in]	[kg/h]	[lb/min]
1	$\frac{1}{24}$	0 to 20	0 to 0.735
2	$\frac{1}{12}$	0 to 100	0 to 3.675
4	$\frac{1}{6}$	0 to 450	0 to 16.54
6	$\frac{1}{4}$	0 to 1 000	0 to 36.75

### Measuring range for gases

The full scale value depends on the density and the speed of sound of the gas used. The full scale value can be calculated with the following formulas:

$$\dot{m}_{\max(G)} = \text{minimum of } (\dot{m}_{\max(F)} \cdot \rho_G : x) \text{ and } (\rho_G \cdot (c_G/2) \cdot d_i^2 \cdot (\pi/4) \cdot 3600 \cdot n)$$



$\dot{m}_{\max(G)}$	Maximum full scale value for gas [kg/h]
$\dot{m}_{\max(F)}$	Maximum full scale value for liquid [kg/h]
$\dot{m}_{\max(G)} < \dot{m}_{\max(F)}$	$\dot{m}_{\max(G)}$ can never be greater than $\dot{m}_{\max(F)}$
$\rho_G$	Gas density in [kg/m <sup>3</sup> ] at operating conditions
$x$	Limitation constant for max. gas flow [kg/m <sup>3</sup> ]
$c_G$	Speed of sound (gas) [m/s]
$d_i$	Measuring tube internal diameter [m]
$\pi$	Pi
$n = 1$	Number of measuring tubes

DN		$x$
[mm]	[in]	[kg/m <sup>3</sup> ]
1	$\frac{1}{24}$	20
2	$\frac{1}{12}$	20
4	$\frac{1}{6}$	20
6	$\frac{1}{4}$	20

If calculating the full scale value using the two formulas:

1. Calculate the full scale value with both formulas.
2. The smaller value is the value that must be used.

**Recommended measuring range**

 Flow limit →  116

Operable flow range

Over 1000 : 1.

Flow rates above the preset full scale value do not override the electronics unit, with the result that the totalizer values are registered correctly.

Input signal

**External measured values**

To increase the measurement accuracy of certain measured variables or to calculate the corrected volume flow for gases, the automation system can continuously write different measured values to the measuring instrument:

- Operating pressure to increase measurement accuracy (Endress+Hauser recommends the use of a pressure measuring instrument for absolute pressure, e.g. Cerabar M or Cerabar S)
- Medium temperature to increase measurement accuracy (e.g. iTEMP)
- Reference density for calculating the corrected volume flow for gases

 Various pressure transmitters and temperature measuring instruments can be ordered from Endress+Hauser: see "Accessories" section →  102

It is recommended to read in external measured values to calculate the following measured variables:

- Mass flow
- Corrected volume flow

*Digital communication*

The measured values are written by the automation system via Ethernet/IP.

## 16.4 Output

Output signal

**EtherNet/IP**

<b>Standards</b>	In accordance with IEEE 802.3
------------------	-------------------------------

Signal on alarm

Depending on the interface, failure information is displayed as follows.

**EtherNet/IP**

<b>Device diagnostics</b>	Device condition can be read out in Input Assembly
---------------------------	--

**Local display**

<b>Plain text display</b>	With information on cause and remedial measures
<b>Backlight</b>	Red backlighting indicates a device error.

 Status signal as per NAMUR recommendation NE 107

**Interface/protocol**

- Via digital communication:  
EtherNet/IP
- Via service interface  
Service interface CDI-RJ45
- Plain text display  
With information on cause and remedial actions

**Web browser**

<b>Plain text display</b>	With information on cause and remedial measures
---------------------------	---

**LEDs**

<b>Status information</b>	<p>Status indicated by various LEDs</p> <p>The following information is displayed depending on the device version:</p> <ul style="list-style-type: none"> <li>■ Supply voltage active</li> <li>■ Data transmission active</li> <li>■ Device alarm/error has occurred</li> <li>■ Network available</li> <li>■ Connection established</li> </ul> <p> Diagnostic information via LEDs</p>
---------------------------	---

Low flow cut off                      The switch points for low flow cut off are user-selectable.

Galvanic isolation                    The following connections are galvanically isolated from each other:

- Outputs
- Power supply

Protocol-specific data                **protocol-specific data**

<b>Protocol</b>	<ul style="list-style-type: none"> <li>■ The CIP Networks Library Volume 1: Common Industrial Protocol</li> <li>■ The CIP Networks Library Volume 2: Ethernet/IP Adaptation of CIP</li> </ul>
<b>Communication type</b>	<ul style="list-style-type: none"> <li>■ 10Base-T</li> <li>■ 100Base-TX</li> </ul>
<b>Device profile</b>	Generic device (product type: 0x2B)
<b>Manufacturer ID</b>	0x49E
<b>Device type ID</b>	0x104A
<b>Baud rates</b>	Automatic <sup>10</sup> / <sub>100</sub> Mbit with half-duplex and full-duplex detection
<b>Polarity</b>	Auto-polarity for automatic correction of crossed TxD and RxD pairs
<b>Supported CIP connections</b>	Max. 3 connections
<b>Explicit connections</b>	Max. 6 connections

<b>I/O connections</b>	Max. 6 connections (scanner)		
<b>Configuration options for measuring instrument</b>	<ul style="list-style-type: none"> <li>■ DIP switches on the electronics module for IP addressing</li> <li>■ Manufacturer-specific software (FieldCare)</li> <li>■ Add-on Profile Level 3 for Rockwell Automation control systems</li> <li>■ Web browser</li> <li>■ Electronic Data Sheet (EDS) integrated in the measuring instrument</li> </ul>		
<b>Configuration of the EtherNet interface</b>	<ul style="list-style-type: none"> <li>■ Speed: 10 MBit, 100 MBit, auto (factory setting)</li> <li>■ Duplex: half-duplex, full-duplex, auto (factory setting)</li> </ul>		
<b>Configuration of the device address</b>	<ul style="list-style-type: none"> <li>■ DIP switches on the electronics module for IP addressing (last octet)</li> <li>■ DHCP</li> <li>■ Manufacturer-specific software (FieldCare)</li> <li>■ Add-on Profile Level 3 for Rockwell Automation control systems</li> <li>■ Web browser</li> <li>■ Ethernet/IP tools, e.g. RSLinx (Rockwell Automation)</li> </ul>		
<b>Device Level Ring (DLR)</b>	No		
<b>Fix input</b>			
<b>RPI</b>	5 ms to 10 s (factory setting: 20 ms)		
<b>Exclusive Owner Multicast</b>		Instance	Size [byte]
	Instance configuration:	0x68	398
	O → T configuration:	0x66	64
	T → O configuration:	0x64	44
<b>Exclusive Owner Multicast</b>		Instance	Size [byte]
	Instance configuration:	0x69	-
	O → T configuration:	0x66	64
	T → O configuration:	0x64	44
<b>Input only Multicast</b>		Instance	Size [byte]
	Instance configuration:	0x68	398
	O → T configuration:	0xC7	-
	T → O configuration:	0x64	44
<b>Input only Multicast</b>		Instance	Size [byte]
	Instance configuration:	0x69	-
	O → T configuration:	0xC7	-
	T → O configuration:	0x64	44
<b>Input Assembly</b>	<ul style="list-style-type: none"> <li>■ Current device diagnostics</li> <li>■ Mass flow</li> <li>■ Volume flow</li> <li>■ Corrected volume flow</li> <li>■ Density</li> <li>■ Reference density</li> <li>■ Temperature</li> <li>■ Totalizer 1</li> <li>■ Totalizer 2</li> <li>■ Totalizer 3</li> </ul>		
<b>Configurable Input</b>			
<b>RPI</b>	5 ms to 10 s (factory setting: 20 ms)		
<b>Exclusive Owner Multicast</b>		Instance	Size [byte]
	Instance configuration:	0x68	398
	O → T configuration:	0x66	64
	T → O configuration:	0x65	88
<b>Exclusive Owner Multicast</b>		Instance	Size [byte]
	Instance configuration:	0x69	-

	O → T configuration:	0x66	64
	T → O configuration:	0x65	88
<b>Input only Multicast</b>		Instance	Size [byte]
	Instance configuration:	0x68	398
	O → T configuration:	0xC7	-
	T → O configuration:	0x65	88
<b>Input only Multicast</b>		Instance	Size [byte]
	Instance configuration:	0x69	-
	O → T configuration:	0xC7	-
	T → O configuration:	0x65	88
<b>Configurable Input Assembly</b>	<ul style="list-style-type: none"> <li>▪ Current device diagnostics</li> <li>▪ Mass flow</li> <li>▪ Volume flow</li> <li>▪ Corrected volume flow</li> <li>▪ Density</li> <li>▪ Reference density</li> <li>▪ Temperature</li> <li>▪ Totalizer 1</li> <li>▪ Totalizer 2</li> <li>▪ Totalizer 3</li> </ul> <p> The range of options increases if the measuring device has one or more application packages.</p>		
<b>Fix output</b>			
<b>Output Assembly</b>	<ul style="list-style-type: none"> <li>▪ Activation of reset totalizers 1-3</li> <li>▪ Activation of pressure compensation</li> <li>▪ Activation of reference density compensation</li> <li>▪ Activation of temperature compensation</li> <li>▪ Reset totalizers 1-3</li> <li>▪ External pressure value</li> <li>▪ Pressure unit</li> <li>▪ External reference density</li> <li>▪ Reference density unit</li> <li>▪ External temperature</li> <li>▪ Temperature unit</li> </ul>		
<b>Configuration</b>			
<b>Configuration Assembly</b>	<p>Only the most common configurations are listed below.</p> <ul style="list-style-type: none"> <li>▪ Software write protection</li> <li>▪ Mass flow unit</li> <li>▪ Mass unit</li> <li>▪ Volume flow unit</li> <li>▪ Volume unit</li> <li>▪ Corrected volume flow unit</li> <li>▪ Corrected volume unit</li> <li>▪ Density unit</li> <li>▪ Reference density unit</li> <li>▪ Temperature unit</li> <li>▪ Pressure unit</li> <li>▪ Length</li> <li>▪ Totalizer 1-3:                             <ul style="list-style-type: none"> <li>▪ Assignment</li> <li>▪ Unit</li> <li>▪ Mode of operation</li> <li>▪ Failure mode</li> </ul> </li> <li>▪ Alarm delay</li> </ul>		

## 16.5 Power supply

Terminal assignment ■ → 28

Available device plugs ■ → 29

Supply voltage The power unit must be tested to ensure it meets safety requirements (e.g. PELV, SELV).

**Transmitter**  
DC 20 to 30 V

Power consumption **Transmitter**

Order code for "Output"	Maximum Power consumption
Option N: EtherNet/IP	3.5 W

Current consumption **Transmitter**

Order code for "Output"	Maximum current consumption	Maximum switch-on current
Option N: EtherNet/IP	145 mA	18 A (< 0.125 ms)

Device fuse Fine-wire fuse (slow-blow) T2A

Power supply failure

- Totalizers stop at the last value measured.
- Depending on the device version, the configuration is retained in the device memory or in the plug-in memory (HistoROM DAT).
- Error messages (incl. total operated hours) are stored.

Electrical connection → 29

Potential equalization → 32

Terminals **Transmitter**  
Spring terminals for wire cross-sections 0.5 to 2.5 mm<sup>2</sup> (20 to 14 AWG)



Cable entries

- Cable gland: M20 × 1.5 with cable Ø 6 to 12 mm (0.24 to 0.47 in)
- Thread for cable entry:
  - M20
  - G ½"
  - NPT ½"

Cable specification →  27

## 16.6 Performance characteristics

Reference operating conditions

- Error limits based on ISO 11631
  - Water
    - +15 to +45 °C (+59 to +113 °F)
    - 2 to 6 bar (29 to 87 psi)
  - Data as indicated in the calibration protocol
  - Accuracy based on accredited calibration rigs according to ISO 17025
-  To obtain measured errors, use the *Applicator* sizing tool →  102

Maximum measurement error

o.r. = of reading; 1 g/cm<sup>3</sup> = 1 kg/l; T = medium temperature

### Base accuracy

 Design fundamentals →  112

*Mass flow and volume flow (liquids)*

±0.10 % o.r.

*Mass flow (gases)*

±0.50 % o.r.

*Density (liquids)*

Under reference conditions [g/cm <sup>3</sup> ]	Standard density calibration <sup>1)</sup> [g/cm <sup>3</sup> ]	Wide-range Density specification <sup>2) 3)</sup> [g/cm <sup>3</sup> ]
±0.0005	±0.02	±0.002

- 1) Valid over the entire temperature and density range
- 2) Valid range for special density calibration: 0 to 2 g/cm<sup>3</sup>, +5 to +80 °C (+41 to +176 °F)
- 3) order code for "Application package", option EE "Special density"

*Temperature*

±0.5 °C ± 0.005 · T °C (±0.9 °F ± 0.003 · (T - 32) °F)

### Zero point stability

DN		Zero point stability	
[mm]	[in]	[kg/h]	[lb/min]
1	1/24	0.0008	0.00003
2	1/12	0.002	0.00007
4	1/8	0.014	0.0005
6	1/4	0.02	0.0007

### Flow values

Flow values as turndown parameters depending on nominal diameter.

*SI units*

DN	1:1	1:10	1:20	1:50	1:100	1:500
[mm]	[kg/h]	[kg/h]	[kg/h]	[kg/h]	[kg/h]	[kg/h]
1	20	2	1	0.4	0.2	0.04
2	100	10	5	2	1	0.2
4	450	45	22.5	9	4.5	0.9
6	1000	100	50	20	10	2

*US units*

DN	1:1	1:10	1:20	1:50	1:100	1:500
[inch]	[lb/min]	[lb/min]	[lb/min]	[lb/min]	[lb/min]	[lb/min]
$\frac{1}{24}$	0.735	0.074	0.037	0.015	0.007	0.001
$\frac{1}{12}$	3.675	0.368	0.184	0.074	0.037	0.007
$\frac{1}{8}$	16.54	1.654	0.827	0.331	0.165	0.033
$\frac{1}{4}$	36.75	3.675	1.838	0.735	0.368	0.074

**Accuracy of outputs**

 The output accuracy must be factored into the measurement error if analog outputs are used; but can be ignored for fieldbus outputs (e.g. Modbus RS485, EtherNet/IP).

The outputs have the following base accuracy specifications:

---

Repeatability o.r. = of reading;  $1 \text{ g/cm}^3 = 1 \text{ kg/l}$ ; T = medium temperature

**Base repeatability**

 Design fundamentals →  112

*Mass flow and volume flow (liquids)*

$\pm 0.05 \%$  o.r.

*Mass flow (gases)*

$\pm 0.25 \%$  o.r.

*Density (liquids)*

$\pm 0.00025 \text{ g/cm}^3$

*Temperature*

$\pm 0.25 \text{ }^\circ\text{C} \pm 0.0025 \cdot T \text{ }^\circ\text{C}$  ( $\pm 0.45 \text{ }^\circ\text{F} \pm 0.0015 \cdot (T-32) \text{ }^\circ\text{F}$ )

---

Response time The response time depends on the configuration (damping).

---

Influence of medium temperature

**Mass flow**

o.f.s. = of full scale value

If there is a difference between the temperature during zero adjustment and the process temperature, the additional measurement error of the sensors is typically  $\pm 0.0002 \%$  o.f.s./ $^\circ\text{C}$  ( $\pm 0.0001 \%$  o. f.s./ $^\circ\text{F}$ ).

The influence is reduced when the zero adjustment is performed at process temperature.

**Density**

- If there is a difference between the density calibration temperature and the process temperature, the measurement error of the sensors is typically  $\pm 0.00005 \text{ g/cm}^3/\text{°C}$  ( $\pm 0.000025 \text{ g/cm}^3/\text{°F}$ ). Field density adjustment is possible.

**Wide-range density specification (special density calibration)**

If the process temperature is outside the valid range ( $\rightarrow$   110) the measurement error is  $\pm 0.00005 \text{ g/cm}^3/\text{°C}$  ( $\pm 0.000025 \text{ g/cm}^3/\text{°F}$ )

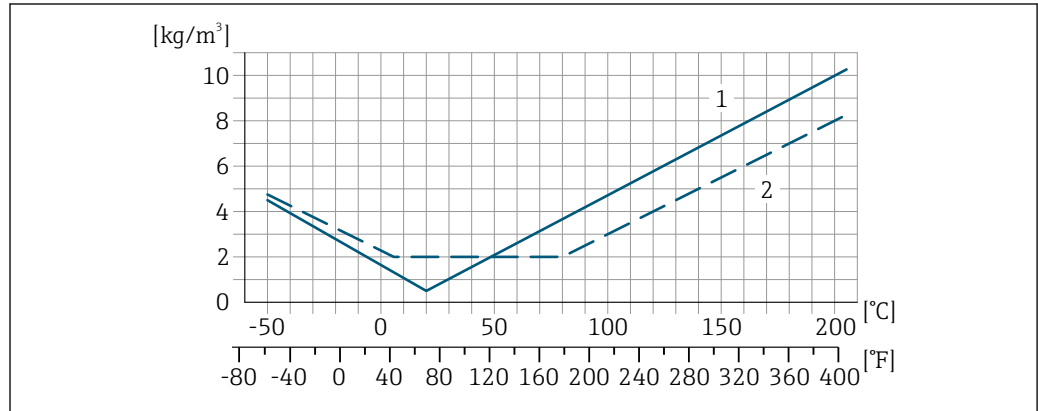

- 1 Field density adjustment, for example at +20 °C (+68 °F)
- 2 Special density calibration

**Temperature**

$\pm 0.005 \cdot T \text{ °C}$  ( $\pm 0.005 \cdot (T - 32) \text{ °F}$ )

**Influence of medium pressure**

The following shows how the process pressure (gauge pressure) affects the accuracy of the mass flow.

o.r. = of reading

-  It is possible to compensate for the effect by:
  - Reading in the current pressure measured value via the current input or a digital input.
  - Specifying a fixed value for the pressure in the device parameters.

 Operating Instructions .

DN		[% o.r./bar]	[% o.r./psi]
[mm]	[in]		
1	1/24	-0.001	-0.00007
2	1/12	0	0
4	1/6	-0.005	-0.0004
6	1/4	-0.003	-0.0002

**Design fundamentals**

o.r. = of reading, o.f.s. = of full scale value

BaseAccu = base accuracy in % o.r., BaseRepeat = base repeatability in % o.r.

MeasValue = measured value; ZeroPoint = zero point stability

Calculation of the maximum measured error as a function of the flow rate

Flow rate	Maximum measured error in % o.r.
$\geq \frac{\text{ZeroPoint}}{\text{BaseAccu}} \cdot 100$ <small>A0021332</small>	$\pm \text{BaseAccu}$ <small>A0021339</small>
$< \frac{\text{ZeroPoint}}{\text{BaseAccu}} \cdot 100$ <small>A0021333</small>	$\pm \frac{\text{ZeroPoint}}{\text{MeasValue}} \cdot 100$ <small>A0021334</small>

Calculation of the maximum repeatability as a function of the flow rate

Flow rate	Maximum repeatability in % o.r.
$\geq \frac{1/2 \cdot \text{ZeroPoint}}{\text{BaseRepeat}} \cdot 100$ <small>A0021335</small>	$\pm \text{BaseRepeat}$ <small>A0021340</small>
$< \frac{1/2 \cdot \text{ZeroPoint}}{\text{BaseRepeat}} \cdot 100$ <small>A0021336</small>	$\pm 1/2 \cdot \frac{\text{ZeroPoint}}{\text{MeasValue}} \cdot 100$ <small>A0021337</small>

Example of maximum measurement error

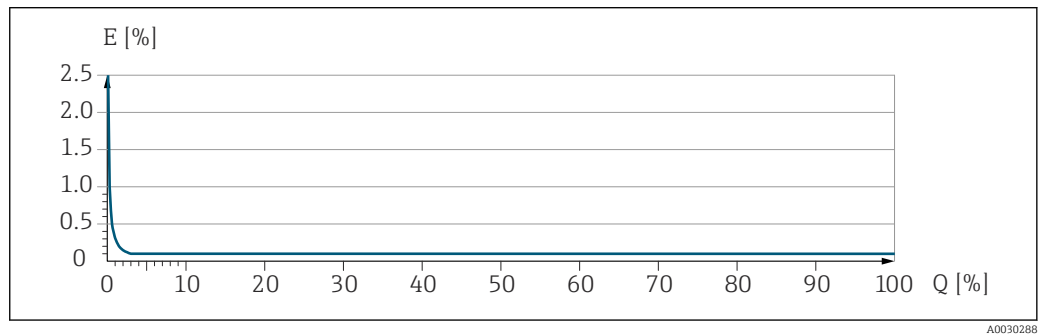

E Maximum measurement error in % o.r. (example)  
Q Flow rate in % of maximum full scale value

## 16.7 Installation

Installation requirements → 19

## 16.8 Environment

Ambient temperature range → 21 → 21

### Temperature tables

- Observe the interdependencies between the permitted ambient and fluid temperatures when operating the device in hazardous areas.
- For detailed information on the temperature tables, see the separate document entitled "Safety Instructions" (XA) for the device.

Storage temperature -40 to +80 °C (-40 to +176 °F), preferably at +20 °C (+68 °F) (standard version)  
-50 to +80 °C (-58 to +176 °F) (Order code for "Test, certificate", option JM)

---

Climate class                   DIN EN 60068-2-38 (test Z/AD)

---

Degree of protection       **Transmitter and sensor**

- Standard: IP66/67, Type 4X enclosure, suitable for pollution degree 4
- When the housing is open: IP20, Type 1 enclosure, suitable for pollution degree 2
- Display module: IP20, Type 1 enclosure, suitable for pollution degree 2

---

Vibration resistance and shock resistance   **Sinusoidal vibration similar to IEC 60068-2-6**

- 2 to 8.4 Hz, 3.5 mm peak
- 8.4 to 2 000 Hz, 1 g peak

**Broadband random vibration similar to IEC 60068-2-64**

- 10 to 200 Hz, 0.003 g<sup>2</sup>/Hz
- 200 to 2 000 Hz, 0.001 g<sup>2</sup>/Hz
- Total: 1.54 g rms

**Half-sine shocks similar to IEC 60068-2-27**

6 ms 30 g

**Rough handling shocks similar to IEC 60068-2-31**

---

Electromagnetic compatibility (EMC)

- As per IEC/EN 61326
- As per NAMUR Recommendation 21 (NE 21), NAMUR Recommendation 21 (NE 21) is fulfilled when the device is installed in accordance with NAMUR Recommendation 98 (NE 98).
- As per IEC/EN 61000-6-2 and IEC/EN 61000-6-4
- Complies with emission limits for industry as per EN 55011 (class A)

 Details are provided in the Declaration of Conformity.

 This unit is not intended for use in residential environments and cannot guarantee adequate protection of the radio reception in such environments.

---

## 16.9 Process

---

Medium temperature range   -50 to +205 °C (-58 to +401 °F)

**Dependency of ambient temperature on medium temperature**

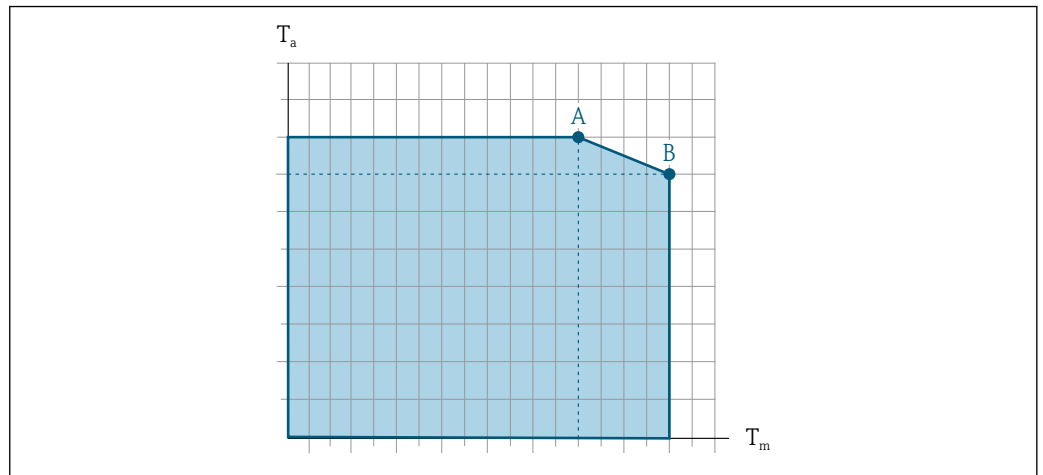

A0031121

14 Exemplary representation, values in the table below.

$T_a$  Ambient temperature

$T_m$  Medium temperature

A Maximum permitted medium temperature  $T_m$  at  $T_{a\max} = 60\text{ °C}$  (140 °F); higher medium temperatures  $T_m$  require a reduction in the ambient temperature  $T_a$

B Maximum permitted ambient temperature  $T_a$  for the maximum specified medium temperature  $T_m$  of the sensor



Values for devices that are used in the hazardous area:  
Separate Ex documentation (XA) for the device .

Not insulated				Insulated			
A		B		A		B	
$T_a$	$T_m$	$T_a$	$T_m$	$T_a$	$T_m$	$T_a$	$T_m$
60 °C (140 °F)	205 °C (401 °F)	-	-	60 °C (140 °F)	120 °C (248 °F)	55 °C (131 °F)	205 °C (401 °F)

**Seals**

For mounting sets with screwed-on connections:

- Viton: -15 to +200 °C (-5 to +392 °F)
- EPDM: -40 to +160 °C (-40 to +320 °F)
- Silicone: -60 to +200 °C (-76 to +392 °F)
- Kalrez: -20 to +275 °C (-4 to +527 °F)

Medium density 0 to 5 000 kg/m<sup>3</sup> (0 to 312 lb/cf)

Pressure/temperature ratings



For an overview of the pressure/temperature ratings for the process connections, see the Technical Information







Sensor housing

The sensor housing is filled with dry nitrogen gas and protects the electronics and mechanics inside.

Rupture disk

To guarantee the safety of the measuring instrument, the device version with a rupture disk with a triggering pressure of 10 to 15 bar (145 to 217.5 psi) is the standard version used. Special installation instructions → 22.

---

Internal cleaning	<ul style="list-style-type: none"><li>▪ CIP cleaning</li><li>▪ SIP cleaning</li></ul> <p><b>Options</b> Oil- and grease-free version for wetted parts, without declaration Order code for "Service", option HA <sup>2)</sup></p>
Flow limit	<p>Select the nominal diameter by optimizing between the required flow range and permissible pressure loss.</p> <p> For an overview of the full scale values for the measuring range, see the "Measuring range" section →  104</p> <ul style="list-style-type: none"><li>▪ The minimum recommended full scale value is approx. 1/20 of the maximum full scale value</li><li>▪ For the most common applications, 20 to 50 % of the maximum full scale value can be considered ideal</li><li>▪ A low full scale value must be selected for abrasive media (such as liquids with entrained solids): flow velocity &lt; 1 m/s (&lt; 3 ft/s).</li><li>▪ For gas measurement the following rules apply:<ul style="list-style-type: none"><li>▪ The flow velocity in the measuring tubes should not exceed half the speed of sound (0.5 Mach)</li><li>▪ The maximum mass flow depends on the density of the gas: formula</li></ul></li></ul> <p> To calculate the flow limit, use the <i>Applicator</i> sizing tool →  102</p>
Pressure loss	<p> To calculate the pressure loss, use the <i>Applicator</i> sizing tool →  102</p>
System pressure	→  21

---

2) Cleaning only refers to the measuring instrument. Any accessories that have been supplied are not cleaned.

## 16.10 Mechanical construction

### Design, dimensions



For the dimensions and installed lengths of the device, see the "Technical Information" document, "Mechanical construction" section

### Weight

All values (weight exclusive of packaging material) refer to devices with VCO couplings. Weight specifications including transmitter: order code for "Housing", option A "Compact, aluminum coated".

#### Weight in SI units

DN [mm]	Weight [kg]
1 to 6	3.5

#### Weight in US units

DN [in]	Weight [lbs]
$\frac{1}{24}$ to $\frac{1}{4}$	8

### Materials

#### Transmitter housing

- Order code for "Housing", option **A** "Compact, aluminum coated":  
Aluminum, AlSi10Mg, coated
- Order code for "Housing", option **B** "Compact, hygienic, stainless":  
Hygienic version, stainless steel 1.4301 (304)
- Order code for "Housing", option **C** "Ultra-compact, hygienic, stainless":  
Hygienic version, stainless steel 1.4301 (304)
- Window material for optional local display (→ 119):
  - For order code for "Housing", option **A**: glass
  - For order code for "Housing", option **B** and **C**: plastic

#### Cable entries/cable glands

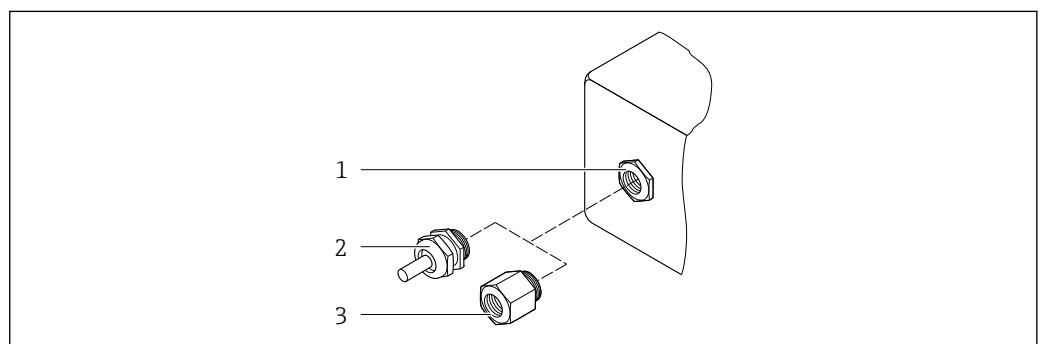

15 Possible cable entries/cable glands

- 1 Internal thread M20 × 1.5
- 2 Cable gland M20 × 1.5
- 3 Adapter for cable entry with internal thread G  $\frac{1}{2}$ " or NPT  $\frac{1}{2}$ "

A0020640

Order code for "Housing", option A "Compact, aluminum, coated"

The various cable entries are suitable for hazardous and non-hazardous areas.

Cable entry/cable gland	Material
Cable gland M20 × 1.5	Nickel-plated brass
Adapter for cable entry with female thread G ½"	
Adapter for cable entry with female thread NPT ½"	

Order code for "Housing", option B "Compact, hygienic, stainless"

The various cable entries are suitable for hazardous and non-hazardous areas.

Cable entry/cable gland	Material
Cable gland M20 × 1.5	Stainless steel, 1.4404 (316L)
Adapter for cable entry with female thread G ½"	
Adapter for cable entry with female thread NPT ½"	

**Device plug**

Electrical connection	Material
Plug M12x1	<ul style="list-style-type: none"> <li>▪ Socket: Stainless steel, 1.4404 (316L)</li> <li>▪ Contact housing: Polyamide</li> <li>▪ Contacts: Gold-plated brass</li> </ul>

**Sensor housing**

- Acid and alkali-resistant outer surface
- Stainless steel 1.4301 (304)

**Measuring tubes**

Stainless steel, 1.4539 (904L)

**Process connections**

VCO connection:



VCO connection: stainless steel, 1.4539 (904L)

Adapter for DN 15 flange similar to EN 1092-1 (DIN2501) / similar to ASME B 16.5 / as per JIS B2220:

Stainless steel, 1.4539 (904L)

NPTF adapter:

Stainless steel, 1.4539 (904L)

 Available process connections →  119

**Seals**

Welded process connections without internal seals

**Seals for mounting kit**

- Viton
- EPDM
- Silicone
- Kalrez

### Accessories

Safety Barrier Promass 100

Housing: Polyamide

#### Process connections

- Fixed flange connections:
  - EN 1092-1 (DIN 2512N) flange
  - ASME B16.5 flange
  - JIS B2220 flange
- VCO connections:
  - 4-VCO-4
  - 8-VCO-4
- Adapter for VCO connections:
  - Flange EN 1092-1 (DIN 2501)
  - Flange ASME B16.5
  - Flange JIS B2220
  - NPT



Process connection materials

#### Surface roughness

All data relate to parts in contact with medium.

The following surface roughness categories can be ordered:  
Not polished

## 16.11 Operability

#### Local display

The local display is only available with the following device order code:  
Order code for "Display; operation", option **B**: 4-line; illuminated, via communication

##### Display element

- 4-line liquid crystal display with 16 characters per line.
- White background lighting; switches to red in event of device errors.
- Format for displaying measured variables and status variables can be individually configured.
- Permitted ambient temperature for the display:  $-20$  to  $+60$  °C ( $-4$  to  $+140$  °F). The readability of the display may be impaired at temperatures outside the temperature range.

##### Disconnecting the local display from the main electronics module



In the case of the "Compact, aluminum coated" housing version, the local display must only be disconnected manually from the main electronics module. In the case of the "Compact, hygienic, stainless" and "Ultra-compact, hygienic, stainless" housing versions, the local display is integrated in the housing cover and is disconnected from the main electronics module when the housing cover is opened.

##### *"Compact, aluminum coated" housing version*

The local display is plugged onto the main electronics module. The electronic connection between the local display and main electronics module is established via a connecting cable.

For some work performed on the measuring device (e.g. electrical connection), it is advisable to disconnect the local display from the main electronics module:

1. Press in the side latches of the local display.

2. Remove the local display from the main electronics module. Pay attention to the length of the connecting cable when doing so.

Once the work is completed, plug the local display back on.

Remote operation

**Via EtherNet/IP network**

This communication interface is available in device versions with EtherNet/IP.

*Star topology*

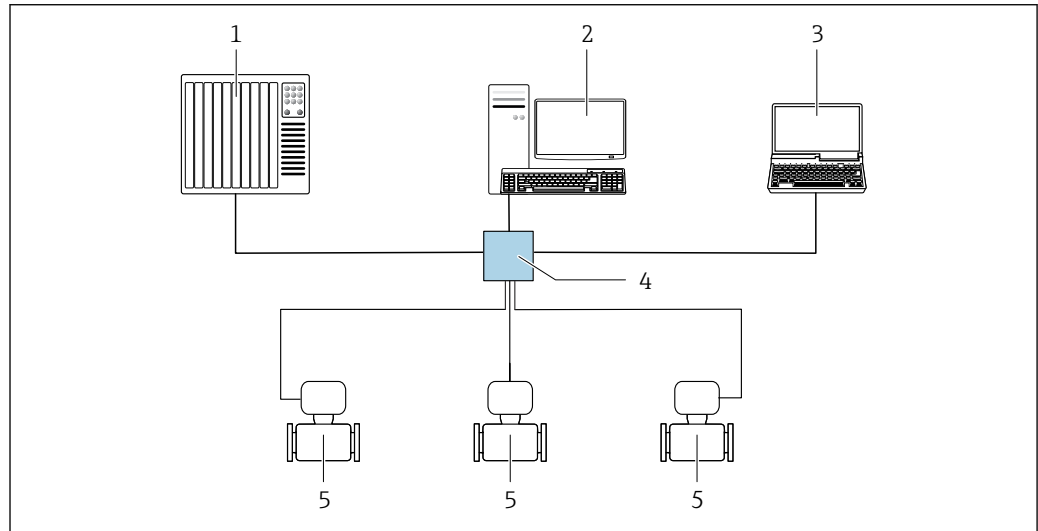

A0032078

16 Options for remote operation via Ethernet/IP network: star topology

- 1 Automation system, z. B. "RSLogix" (Rockwell Automation)
- 2 Workstation for measuring instrument operation: with Custom Add-On Profile for "RSLogix 5000" (Rockwell Automation) or with Electronic Data Sheet (EDS)
- 3 Computer with web browser for accessing the integrated web server or computer with operating tool (e.g. FieldCare, DeviceCare) with COM DTM "CDI Communication TCP/IP"
- 4 Standard Ethernet switch, e.g. Scalance X204 (Siemens)
- 5 Measuring instrument

Service interface

**Via service interface (CDI-RJ45)**

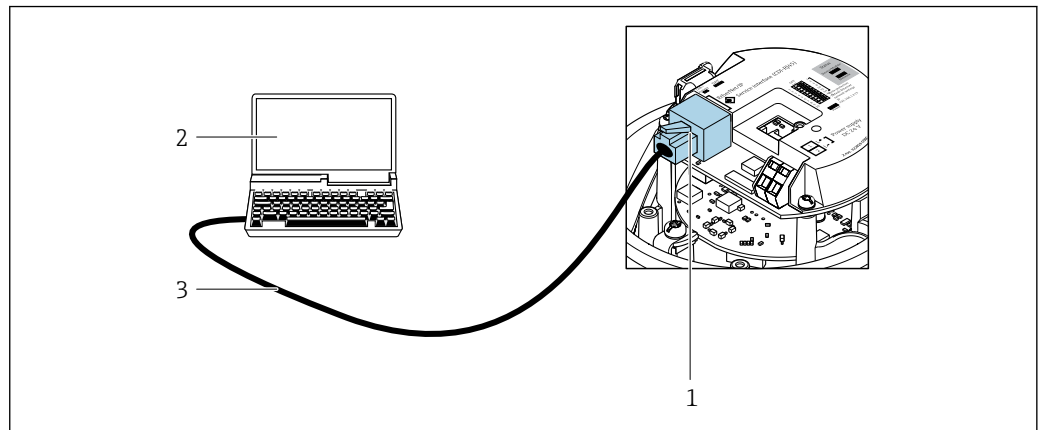
*EtherNet/IP*

A0016940

17 Connection for order code for "Output", option N: EtherNet/IP

- 1 Service interface (CDI-RJ45) and EtherNet/IP interface of the measuring instrument with access to the integrated web server
- 2 Computer with web browser for accessing the integrated web server or with FieldCare operating tool with COM DTM "CDI Communication TCP/IP"
- 3 Standard Ethernet connecting cable with RJ45 plug

## Languages

Can be operated in the following languages:

- Via "FieldCare" operating tool: English, German, French, Spanish, Italian, Chinese, Japanese
- Via web browser  
English, German, French, Spanish, Italian, Dutch, Portuguese, Polish, Russian, Turkish, Chinese, Japanese, Bahasa (Indonesian), Vietnamese, Czech, Swedish, Korean

## 16.12 Certificates and approvals

Current certificates and approvals for the product are available at [www.endress.com](http://www.endress.com) on the relevant product page:

1. Select the product using the filters and search field.
2. Open the product page.
3. Select **Downloads**.

## CE mark

The device meets the legal requirements of the applicable EU Directives. These are listed in the corresponding EU Declaration of Conformity along with the standards applied.

Endress+Hauser confirms successful testing of the device by affixing to it the CE mark.

## UKCA marking

The device meets the legal requirements of the applicable UK regulations (Statutory Instruments). These are listed in the UKCA Declaration of Conformity along with the designated standards. By selecting the order option for UKCA marking, Endress+Hauser confirms a successful evaluation and testing of the device by affixing the UKCA mark.

Contact address Endress+Hauser UK:



Endress+Hauser Ltd.  
Floats Road  
Manchester M23 9NF  
United Kingdom  
[www.uk.endress.com](http://www.uk.endress.com)



RCM marking	The measuring system meets the EMC requirements of the "Australian Communications and Media Authority (ACMA)".
Ex-approval	The devices are certified for use in hazardous areas and the relevant safety instructions are provided in the separate "Safety Instructions" (XA) document. Reference is made to this document on the nameplate.
EtherNet/IP certification	<p>The measuring device is certified and registered by the ODVA (Open Device Vendor Association). The measuring system meets all the requirements of the following specifications:</p> <ul style="list-style-type: none"> <li>■ Certified in accordance with the ODVA Conformance Test</li> <li>■ EtherNet/IP Performance Test</li> <li>■ EtherNet/IP PlugFest compliance</li> <li>■ The device can also be operated with certified devices of other manufacturers (interoperability)</li> </ul>
External standards and guidelines	<ul style="list-style-type: none"> <li>■ EN 60529 Degrees of protection provided by enclosure (IP code)</li> <li>■ IEC/EN 60068-2-6 Environmental influences: Test procedure - Test Fc: vibrate (sinusoidal).</li> <li>■ IEC/EN 60068-2-31 Environmental influences: Test procedure - Test Ec: shocks due to rough handling, primarily for devices.</li> <li>■ EN 61010-1 Safety requirements for electrical equipment for measurement, control and laboratory use - general requirements</li> <li>■ GB 30439.5 Safety requirements for industrial automation products - Part 5: Flowmeter safety requirements</li> <li>■ EN 61326-1/-2-3 EMC requirements for electrical equipment for measurement, control and laboratory use</li> <li>■ NAMUR NE 21 Electromagnetic compatibility (EMC) of industrial process and laboratory control equipment</li> <li>■ NAMUR NE 32 Data retention in the event of a power failure in field and control instruments with microprocessors</li> <li>■ NAMUR NE 43 Standardization of the signal level for the breakdown information of digital transmitters with analog output signal.</li> <li>■ NAMUR NE 53 Software of field devices and signal-processing devices with digital electronics</li> <li>■ NAMUR NE 105 Specifications for integrating fieldbus devices in engineering tools for field devices</li> <li>■ NAMUR NE 107 Self-monitoring and diagnostics of field devices</li> <li>■ NAMUR NE 131 Requirements for field devices for standard applications</li> <li>■ NAMUR NE 132 Coriolis mass meter</li> <li>■ ETSI EN 300 328 Guidelines for 2.4 GHz radio components.</li> <li>■ EN 301489 Electromagnetic compatibility and radio spectrum matters (ERM).</li> </ul>

## 16.13 Application packages

Many different application packages are available to enhance the functionality of the device. Such packages might be needed to address safety aspects or specific application requirements.

The application packages can be ordered with the device or subsequently from Endress+Hauser. Detailed information on the order code in question is available from your local Endress+Hauser sales center or on the product page of the Endress+Hauser website: [www.endress.com](http://www.endress.com).



 Detailed information on the application packages:  
Special Documentation →  124

Heartbeat Technology	<p>Order code for "Application package", option EB "Heartbeat Verification + Monitoring"</p> <p><b>Heartbeat Verification</b> Meets the requirement for traceable verification in accordance with DIN ISO 9001:2015 Clause 7.6 a) "Control of monitoring and measuring equipment".</p> <ul style="list-style-type: none"> <li>▪ Functional testing in the installed state without interrupting the process.</li> <li>▪ Traceable verification results on request, including a report.</li> <li>▪ Simple testing process via local operation or other operating interfaces.</li> <li>▪ Clear measuring point assessment (pass/fail) with high total test coverage within the framework of manufacturer specifications.</li> <li>▪ Extension of calibration intervals according to operator's risk evaluation.</li> </ul> <p><b>Heartbeat Monitoring</b> Continuously supplies data, which are characteristic of the measuring principle, to an external condition monitoring system for the purpose of preventive maintenance or process analysis. These data enable the operator to:</p> <ul style="list-style-type: none"> <li>▪ Draw conclusions - using these data and other information - about the impact the process influences (e.g. corrosion, abrasion, deposit buildup etc.) have on measuring performance over time.</li> <li>▪ Schedule servicing in time.</li> <li>▪ Monitor the process or product quality, e.g. gas pockets.</li> </ul> <p> Detailed information on Heartbeat Technology: Special Documentation →  124</p>
Concentration measurement	<p>Order code for "Application package", option ED "Concentration"</p> <p>Calculation and outputting of fluid concentrations.</p> <p>The measured density is converted to the concentration of a substance of a binary mixture using the "Concentration" application package: Concentration calculation from user-defined tables.</p> <p>The measured values are output via the digital and analog outputs of the measuring instrument.</p> <p> For detailed information, see the Special Documentation for the device.</p>
Special density	<p>Order code for "Application package", option EE "Special density"</p> <p>Many applications use density as a key measured value for monitoring quality or controlling processes. The device measures the density of the fluid as standard and makes this value available to the control system.</p> <p>The "Special Density" application package offers high-precision density measurement over a wide density and temperature range particularly for applications subject to varying process conditions.</p> <p>The following information can be found in the calibration certificate supplied:</p>

- Density performance in air
- Density performance in liquids with different density
- Density performance in water with different temperatures

 For detailed information, see the Operating Instructions for the device.

## 16.14 Accessories

 Overview of accessories available to order →  101

## 16.15 Documentation

 For an overview of the scope of the associated Technical Documentation, refer to the following:

- *Device Viewer* ([www.endress.com/deviceviewer](http://www.endress.com/deviceviewer)): Enter the serial number from the nameplate
- *Endress+Hauser Operations app*: Enter serial number from nameplate or scan matrix code on nameplate.

---

### Standard documentation **Brief Operating Instructions**

*Brief Operating Instructions for the sensor*

Measuring instrument	Documentation code
Proline Cubemass C	KA01217D

### *Transmitter Brief Operating Instructions*

Measuring device	Documentation code
Proline Promass 100	KA01332D

### Technical Information

Measuring device	Documentation code
Cubemass C 100	TI01105D

### Description of Device Parameters

Measuring device	Documentation code
Cubemass 100	GP01066D

---

### Supplementary device-dependent documentation

### Safety Instructions



Content	Documentation code
ATEX/IECEX Ex i	XA01030D
ATEX/IECEX Ex nA	XA01143D
cCSAus IS	XA01142D
INMETRO Ex i	XA01221D
INMETRO Ex nA	XA01222D

Content	Documentation code
NEPSI Ex i	XA01261D
NEPSI Ex nA	XA01263D

### Special Documentation

Contents	Documentation code
Information on the Pressure Equipment Directive	SD01614D
Concentration measurement	SD01152D
Heartbeat Technology	SD01153D
Web server	SD01822D

### Installation Instructions

Contents	Note
Installation instructions for spare part sets and accessories	<ul style="list-style-type: none"> <li>▪ Access the overview of all the available spare part sets via <i>Device Viewer</i> →  99</li> <li>▪ Accessories available for order with Installation Instructions →  101</li> </ul>

# Index

## A

Access authorization to parameters	
Read access	39
Write access	39
Access code	39
Incorrect input	39
Adapting the diagnostic behavior	81
Ambient conditions	
Storage temperature	113
Vibration resistance and shock resistance	114
Application	103
Application packages	123
Applicator	104
Approvals	121

## C

Cable entries	
Technical data	109
Cable entry	
Degree of protection	33
CE mark	10, 121
Certificates	121
Check	
Connection	34
Received goods	13
Checklist	
Post-connection check	34
Post-installation check	26
CIP cleaning	116
Climate class	114
Commissioning	53
Advanced settings	62
Configuring the device	53
Connecting the device	29
Connection	
see Electrical connection	
Connection cable	27
Connection preparations	29
Connection tools	27
Current consumption	109
Cyclic data transmission	49

## D

Date of manufacture	14
Declaration of Conformity	10
Defining the access code	68
Degree of protection	33, 114
Design	
Measuring device	12
Design fundamentals	
Measurement error	112
Repeatability	112
Device	
Configuring	53
Preparing for electrical connection	29
Device components	12

Device description files	48
Device fuse	109
Device locking, status	70
Device name	
Sensor	15
Transmitter	14
Device repair	99
Device revision	48
Device type code	48
Device Viewer	99
DeviceCare	47
Device description file	48
Diagnostic information	
Communication interface	81
Design, description	79, 80
DeviceCare	79
FieldCare	79
LED	77
Overview	81
Remedial measures	81
Web browser	78
Diagnostic list	93
DIP switch	
see Write protection switch	
Disabling write protection	68
Display area	
For operational display	38
Display values	
For locking status	70
Disposal	100
Document	
Function	6
Symbols	6
Document function	6
Documentation	124
Down pipe	19

## E

Electrical connection	
Degree of protection	33
Measuring instrument	27
Operating tools	
Via Ethernet network	46, 120
Via service interface (CDI-RJ45)	46, 120
RSLogix 5000	46, 120
Web server	46, 120
Electromagnetic compatibility	114
Enabling write protection	68
Error messages	
see Diagnostic messages	
EtherNet/IP	
Diagnostic information	81
EtherNet/IP certification	122
Event logbook	93
Ex-approval	122

- Extended order code
  - Sensor . . . . . 15
  - Transmitter . . . . . 14
- F**
- Field of application
  - Residual risks . . . . . 10
- FieldCare . . . . . 47
  - Device description file . . . . . 48
  - Function . . . . . 47
- Filtering the event logbook . . . . . 93
- Firmware
  - Release date . . . . . 48
  - Version . . . . . 48
- Firmware history . . . . . 97
- Fix assembly . . . . . 81
- Flow direction . . . . . 20, 25
- Flow limit . . . . . 116
- Functions
  - see Parameter
- G**
- Galvanic isolation . . . . . 106
- H**
- Hardware write protection . . . . . 69
- I**
- I/O electronics module . . . . . 12, 30
- Identifying the measuring instrument . . . . . 13
- Incoming acceptance . . . . . 13
- Indication
  - Current diagnostic event . . . . . 92
  - Previous diagnostic event . . . . . 92
- Influence
  - Medium pressure . . . . . 112
  - Medium temperature . . . . . 111
- Information about this document . . . . . 6
- Inlet runs . . . . . 20
- Input variables . . . . . 104
- Inspection
  - Installation . . . . . 26
- Installation . . . . . 19
- Installation dimensions . . . . . 20
- Installation requirements
  - Down pipe . . . . . 19
  - Inlet and outlet runs . . . . . 20
  - Installation dimensions . . . . . 20
  - Mounting location . . . . . 19
  - Orientation . . . . . 20
  - Rupture disk . . . . . 22
  - Sensor heating . . . . . 22
  - Thermal insulation . . . . . 21
  - Vibrations . . . . . 22
- Intended use . . . . . 9
- Internal cleaning . . . . . 116
- L**
- Languages, operation options . . . . . 121
- Local display
  - see Operational display
- Low flow cut off . . . . . 106
- M**
- Main electronics module . . . . . 12
- Maintenance work . . . . . 98
- Manufacturer ID . . . . . 48
- Manufacturing date . . . . . 15
- Materials . . . . . 117
- Maximum measurement error . . . . . 110
- Measured variables
  - see Process variables
- Measurement accuracy . . . . . 110
- Measuring and test equipment . . . . . 98
- Measuring device
  - Conversion . . . . . 99
  - Design . . . . . 12
  - Repairs . . . . . 99
- Measuring instrument
  - Disposal . . . . . 100
  - Installing the sensor . . . . . 25
  - Preparing for mounting . . . . . 25
  - Removing . . . . . 100
- Measuring principle . . . . . 103
- Measuring range
  - For gases . . . . . 104
  - For liquids . . . . . 104
- Measuring range, recommended . . . . . 116
- Measuring system . . . . . 103
- Medium density . . . . . 115
- Medium pressure
  - Influence . . . . . 112
- Medium temperature
  - Influence . . . . . 111
- Menu
  - Diagnostics . . . . . 92
  - Operation . . . . . 70
  - Setup . . . . . 54
- Menus
  - For device configuration . . . . . 53
  - For specific settings . . . . . 62
- Mounting dimensions
  - see Installation dimensions
- Mounting location . . . . . 19
- Mounting preparations . . . . . 25
- Mounting requirements
  - Static pressure . . . . . 21
- Mounting tools . . . . . 25
- N**
- Nameplate
  - Sensor . . . . . 15
  - Transmitter . . . . . 14
- Netilion . . . . . 98
- O**
- Operable flow range . . . . . 105

- Operating menu
  - Menus, submenus . . . . . 36
  - Structure . . . . . 36
  - Submenus and user roles . . . . . 37
- Operating philosophy . . . . . 37
- Operation . . . . . 70
- Operation options . . . . . 35
- Operational display . . . . . 38
- Operational safety . . . . . 10
- Order code . . . . . 14, 15
- Orientation (vertical, horizontal) . . . . . 20
- Outlet runs . . . . . 20
- Output signal . . . . . 105
- Output variables . . . . . 105
- P**
- Packaging disposal . . . . . 18
- Parameter settings
  - Administration (Submenu) . . . . . 66
  - Advanced setup (Submenu) . . . . . 62
  - Communication (Submenu) . . . . . 58
  - Corrected volume flow calculation (Submenu) . . . . . 63
  - Device information (Submenu) . . . . . 95
  - Diagnostics (Menu) . . . . . 92
  - Low flow cut off (Wizard) . . . . . 60
  - Measured variables (Submenu) . . . . . 71
  - Medium selection (Submenu) . . . . . 57
  - Partially filled pipe detection (Wizard) . . . . . 61
  - Sensor adjustment (Submenu) . . . . . 64
  - Setup (Menu) . . . . . 54
  - Simulation (Submenu) . . . . . 67
  - System units (Submenu) . . . . . 54
  - Totalizer (Submenu) . . . . . 73
  - Totalizer 1 to n (Submenu) . . . . . 65
  - Totalizer handling (Submenu) . . . . . 74
  - Web server (Submenu) . . . . . 45
  - Zero point adjustment (Submenu) . . . . . 64
- Performance characteristics . . . . . 110
- Post-connection check . . . . . 53
- Post-connection check (checklist) . . . . . 34
- Post-installation check . . . . . 53
- Post-installation check (checklist) . . . . . 26
- Potential equalization . . . . . 32
- Power consumption . . . . . 109
- Power supply failure . . . . . 109
- Pressure loss . . . . . 116
- Pressure/temperature ratings . . . . . 115
- Process connections . . . . . 119
- Process variables
  - Calculated . . . . . 104
  - Measured . . . . . 104
- Product safety . . . . . 10
- Protecting parameter settings . . . . . 68
- R**
- RCM marking . . . . . 122
- Read access . . . . . 39
- Reading off measured values . . . . . 71
- Reading out diagnostic information, EtherNet/IP . . . . . 81
- Recalibration . . . . . 98
- Reference operating conditions . . . . . 110
- Registered trademarks . . . . . 8
- Remote operation . . . . . 120
- Repair . . . . . 99
  - Notes . . . . . 99
- Repair of a device . . . . . 99
- Repeatability . . . . . 111
- Replacement
  - Device components . . . . . 99
- Requirements for personnel . . . . . 9
- Response time . . . . . 111
- Return . . . . . 99
- Rupture disk
  - Safety instructions . . . . . 22
  - Triggering pressure . . . . . 115
- S**
- Safety . . . . . 9
- Seals
  - Medium temperature range . . . . . 115
- Sensor
  - Installing . . . . . 25
- Sensor heating . . . . . 22
- Sensor housing . . . . . 115
- Serial number . . . . . 14, 15
- Services
  - Maintenance . . . . . 98
  - Repair . . . . . 99
- Setting the operating language . . . . . 53
- Settings
  - Adapting the measuring device to the process conditions . . . . . 74
  - Administration . . . . . 66
  - Communication interface . . . . . 58
  - Low flow cut off . . . . . 60
  - Medium . . . . . 57
  - Operating language . . . . . 53
  - Partially filled pipe detection . . . . . 61
  - Resetting the device . . . . . 95
  - Resetting the totalizer . . . . . 74
  - Sensor adjustment . . . . . 64
  - Simulation . . . . . 67
  - System units . . . . . 54
  - Tag name . . . . . 54
  - Totalizer . . . . . 65
  - Totalizer reset . . . . . 74
- Signal on alarm . . . . . 105
- SIP cleaning . . . . . 116
- Software release . . . . . 48
- Spare part . . . . . 99
- Spare parts . . . . . 99
- Special connection instructions . . . . . 32
- Special mounting instructions
  - Hygienic compatibility . . . . . 22
- Standards and guidelines . . . . . 122
- Static pressure . . . . . 21
- Status area
  - For operational display . . . . . 38

- Status signals . . . . . 78
- Storage conditions . . . . . 17
- Storage temperature . . . . . 17
- Storage temperature range . . . . . 113
- Structure
  - Operating menu . . . . . 36
- Submenu
  - Administration . . . . . 66
  - Advanced setup . . . . . 62
  - Calculated values . . . . . 62
  - Communication . . . . . 58
  - Corrected volume flow calculation . . . . . 63
  - Device information . . . . . 95
  - Event logbook . . . . . 93
  - Measured values . . . . . 71
  - Measured variables . . . . . 71
  - Medium selection . . . . . 57
  - Overview . . . . . 37
  - Process variables . . . . . 62
  - Sensor adjustment . . . . . 64
  - Simulation . . . . . 67
  - System units . . . . . 54
  - Totalizer . . . . . 73
  - Totalizer 1 to n . . . . . 65
  - Totalizer handling . . . . . 74
  - Web server . . . . . 45
  - Zero point adjustment . . . . . 64
- Supply voltage . . . . . 109
- Surface roughness . . . . . 119
- Symbols
  - For communication . . . . . 38
  - For diagnostic behavior . . . . . 38
  - For locking . . . . . 38
  - For measured variable . . . . . 38
  - For measurement channel number . . . . . 38
  - For status signal . . . . . 38
  - In the status area of the local display . . . . . 38
- System design
  - Measuring system . . . . . 103
  - see Measuring device design
- System file
  - Release date . . . . . 48
  - Source . . . . . 48
  - Version . . . . . 48
- System integration . . . . . 48
- T**
- Technical data, overview . . . . . 103
- Temperature range
  - Medium temperature . . . . . 114
  - Storage temperature . . . . . 17
- Terminal assignment . . . . . 28, 30
- Terminals . . . . . 109
- Thermal insulation . . . . . 21
- Tool
  - Transportation . . . . . 17
- Tools
  - Electrical connection . . . . . 27
  - For mounting . . . . . 25
- Totalizer
  - Configuring . . . . . 65
- Transmitter
  - Connecting the signal cables . . . . . 30
  - Turning the display module . . . . . 25
- Transporting the measuring instrument . . . . . 17
- Troubleshooting
  - General . . . . . 76
- Turning the display module . . . . . 25
- U**
- UKCA marking . . . . . 121
- Use of measuring instrument
  - Borderline cases . . . . . 9
  - Incorrect use . . . . . 9
  - see Intended use
- User roles . . . . . 37
- V**
- Version data for the device . . . . . 48
- Vibration resistance and shock resistance . . . . . 114
- Vibrations . . . . . 22
- W**
- W@M Device Viewer . . . . . 13
- Weight
  - SI units . . . . . 117
  - Transport (notes) . . . . . 17
  - US units . . . . . 117
- Wizard
  - Define access code . . . . . 68
  - Low flow cut off . . . . . 60
  - Partially filled pipe detection . . . . . 61
- Workplace safety . . . . . 10
- Write access . . . . . 39
- Write protection
  - Via access code . . . . . 68
  - Via write protection switch . . . . . 69
- Write protection switch . . . . . 69



71726416

[www.addresses.endress.com](http://www.addresses.endress.com)

---