

Brief Operating Instructions

Proline Promass K

Coriolis sensor

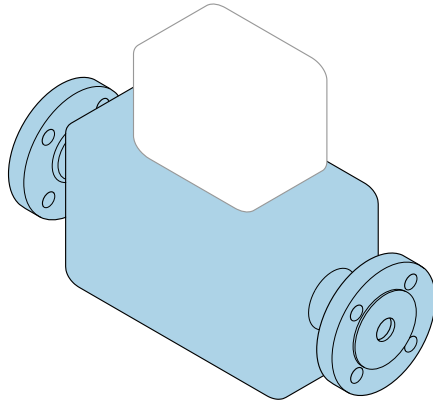

These Brief Operating Instructions are **not** a substitute for the Operating Instructions pertaining to the device.

Brief Operating Instructions Part 1 of 2: Sensor

Contain information about the sensor.

Brief Operating Instructions Part 2 of 2: Transmitter

→  3.



A0023555

Brief operating instructions Flowmeter

The device consists of a transmitter and a sensor.

The process of commissioning these two components is described in two separate manuals which together form the Brief Operating Instructions for the flowmeter:

- Brief Operating Instructions Part 1: Sensor
- Brief Operating Instructions Part 2: Transmitter

Please refer to both parts of the Brief Operating Instructions when commissioning the device, as the contents of the manuals complement one another:

Brief Operating Instructions Part 1: Sensor

The Sensor Brief Operating Instructions are aimed at specialists with responsibility for installing the measuring device.

- Incoming acceptance and product identification
- Storage and transport
- Mounting procedure

Brief Operating Instructions Part 2: Transmitter

The Transmitter Brief Operating Instructions are aimed at specialists with responsibility for commissioning, configuring and parameterizing the measuring device (until the first measured value).

- Product description
- Mounting procedure
- Electrical connection
- Operation options
- System integration
- Commissioning
- Diagnostic information

Additional device documentation



These Brief Operating Instructions are the **Brief Operating Instructions part 1: Sensor**.

The "Brief Operating Instructions part 2: Transmitter" are available via:

- Internet: www.endress.com/deviceviewer
- Smart phone/tablet: *Endress+Hauser Operations App*

Detailed information about the device can be found in the Operating Instructions and the other documentation:

- Internet: www.endress.com/deviceviewer
- Smart phone/tablet: *Endress+Hauser Operations App*

Table of contents

1	About this document	5
1.1	Symbols used	5
2	Basic safety instructions	7
2.1	Requirements for the personnel	7
2.2	Intended use	7
2.3	Workplace safety	8
2.4	Operational safety	8
2.5	Product safety	8
2.6	IT security	9
3	Incoming acceptance and product identification	10
3.1	Incoming acceptance	10
3.2	Product identification	10
4	Storage and transport	11
4.1	Storage conditions	11
4.2	Transporting the product	11
5	Installation	13
5.1	Installation requirements	13
5.2	Installing the device	20
5.3	Post-installation check	21
6	Disposal	22
6.1	Removing the measuring device	22
6.2	Disposing of the measuring device	22

1 About this document

1.1 Symbols used

1.1.1 Safety symbols

DANGER

This symbol alerts you to a dangerous situation. Failure to avoid this situation will result in serious or fatal injury.

WARNING

This symbol alerts you to a dangerous situation. Failure to avoid this situation can result in serious or fatal injury.











CAUTION

This symbol alerts you to a dangerous situation. Failure to avoid this situation can result in minor or medium injury.





NOTICE

This symbol contains information on procedures and other facts which do not result in personal injury.

1.1.2 Symbols for certain types of information





Symbol	Meaning	Symbol	Meaning
	Permitted Procedures, processes or actions that are permitted.		Preferred Procedures, processes or actions that are preferred.
	Forbidden Procedures, processes or actions that are forbidden.		Tip Indicates additional information.
	Reference to documentation		Reference to page
	Reference to graphic		Series of steps
	Result of a step		Visual inspection

1.1.3 Electrical symbols







Symbol	Meaning	Symbol	Meaning
	Direct current		Alternating current
	Direct current and alternating current		Ground connection A grounded terminal which, as far as the operator is concerned, is grounded via a grounding system.

Symbol	Meaning
	<p>Potential equalization connection (PE: protective earth) Ground terminals that must be connected to ground prior to establishing any other connections.</p> <p>The ground terminals are located on the interior and exterior of the device:</p> <ul style="list-style-type: none"> ■ Interior ground terminal: potential equalization is connected to the supply network. ■ Exterior ground terminal: device is connected to the plant grounding system.

1.1.4 Tool symbols

Symbol	Meaning	Symbol	Meaning
	Torx screwdriver		Flat-blade screwdriver
	Phillips head screwdriver		Allen key
	Open-ended wrench		

1.1.5 Symbols in graphics

Symbol	Meaning	Symbol	Meaning
1, 2, 3,...	Item numbers	 1.,  2.,  3. ...	Series of steps
A, B, C, ...	Views	A-A, B-B, C-C, ...	Sections
	Hazardous area		Safe area (non-hazardous area)
	Flow direction		

2 Basic safety instructions

2.1 Requirements for the personnel

The personnel must fulfill the following requirements for its tasks:

- ▶ Trained, qualified specialists must have a relevant qualification for this specific function and task.
- ▶ Are authorized by the plant owner/operator.
- ▶ Are familiar with federal/national regulations.
- ▶ Before starting work, read and understand the instructions in the manual and supplementary documentation as well as the certificates (depending on the application).
- ▶ Follow instructions and comply with basic conditions.

2.2 Intended use

Application and media

The measuring instrument described in these Operating Instructions is intended only for the flow measurement of liquids and gases.

Depending on the version ordered, the measuring instrument can also be used to measure potentially explosive ¹⁾, flammable, toxic and oxidizing media.

Measuring instruments for use in hazardous areas, in hygienic applications, or where there is an increased risk due to pressure, are specially labeled on the nameplate.

To ensure that the measuring instrument is in perfect condition during operation:

- ▶ Only use the measuring instrument in full compliance with the data on the nameplate and the general conditions listed in the Operating Instructions and supplementary documentation.
- ▶ Using the nameplate, check whether the ordered device is permitted for the intended use in the hazardous area (e.g. explosion protection, pressure vessel safety).
- ▶ Use the measuring instrument only for media to which the process-wetted materials are sufficiently resistant.
- ▶ Keep within the specified pressure and temperature range.
- ▶ Keep within the specified ambient temperature range.
- ▶ Protect the measuring instrument permanently against corrosion from environmental influences.

Incorrect use

Non-designated use can compromise safety. The manufacturer is not liable for damage caused by improper or non-designated use.

WARNING

Danger of breakage due to corrosive or abrasive fluids and ambient conditions!

- ▶ Verify the compatibility of the process fluid with the sensor material.
- ▶ Ensure the resistance of all fluid-wetted materials in the process.
- ▶ Keep within the specified pressure and temperature range.

1) Not applicable for IO-Link measuring instruments

NOTICE**Verification for borderline cases:**

- ▶ For special fluids and fluids for cleaning, Endress+Hauser is glad to provide assistance in verifying the corrosion resistance of fluid-wetted materials, but does not accept any warranty or liability as minute changes in the temperature, concentration or level of contamination in the process can alter the corrosion resistance properties.

Residual risks**⚠ CAUTION****Risk of hot or cold burns! The use of media and electronics with high or low temperatures can produce hot or cold surfaces on the device.**

- ▶ Mount suitable touch protection.

⚠ WARNING**Danger of housing breaking due to measuring tube breakage!**

If a measuring tube ruptures, the pressure inside the sensor housing will rise according to the operating process pressure.

- ▶ Use a rupture disk.

⚠ WARNING**Danger from medium escaping!**

For device versions with a rupture disk: medium escaping under pressure can cause injury or material damage.

- ▶ Take precautions to prevent injury and material damage if the rupture disk is actuated.

2.3 Workplace safety

When working on and with the device:

- ▶ Wear the required personal protective equipment as per national regulations.

2.4 Operational safety

Risk of injury!

- ▶ Operate the device in proper technical condition and fail-safe condition only.
- ▶ The operator is responsible for interference-free operation of the device.

Ambient requirements for transmitter housing made of plastic

If a plastic transmitter housing is permanently exposed to certain steam and air mixtures, this can damage the housing.

- ▶ If you are unsure, please contact your Endress+Hauser Sales Center for clarification.
- ▶ If used in an approval-related area, observe the information on the nameplate.

2.5 Product safety

This measuring device is designed in accordance with good engineering practice to meet state-of-the-art safety requirements, has been tested, and left the factory in a condition in which it is safe to operate.

It meets general safety standards and legal requirements. It also complies with the EU directives listed in the device-specific EU Declaration of Conformity. The manufacturer confirms this by affixing the CE mark to the device..

2.6 IT security

The manufacturer warranty is valid only if the product is installed and used as described in the Operating Instructions. The product is equipped with security mechanisms to protect it against any inadvertent changes to the settings.

IT security measures, which provide additional protection for the product and associated data transfer, must be implemented by the operators themselves in line with their security standards.

3 Incoming acceptance and product identification

3.1 Incoming acceptance

On receipt of the delivery:

1. Check the packaging for damage.
 - ↳ Report all damage immediately to the manufacturer.
Do not install damaged components.
2. Check the scope of delivery using the delivery note.
3. Compare the data on the nameplate with the order specifications on the delivery note.
4. Check the technical documentation and all other necessary documents, e.g. certificates, to ensure they are complete.



If one of the conditions is not satisfied, contact the manufacturer.

3.2 Product identification

The device can be identified in the following ways:

- Nameplate
- Order code with details of the device features on the delivery note
- Enter the serial numbers from the nameplates in the *Device Viewer* (www.endress.com/deviceviewer): all the information about the device is displayed.
- Enter the serial numbers from the nameplates into the *Endress+Hauser Operations app* or scan the DataMatrix code on the nameplate with the *Endress+Hauser Operations app*: all the information about the device is displayed.

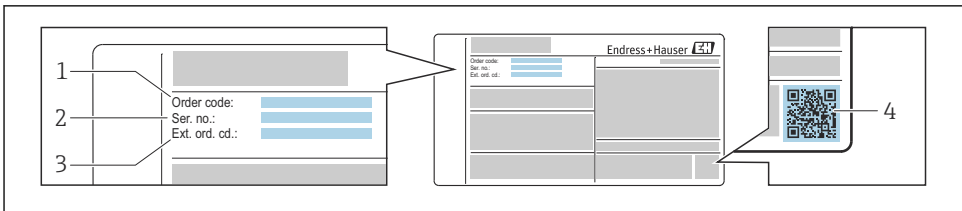

A0030196

 1 Example of a nameplate

- 1 Order code
- 2 Serial number
- 3 Extended order code
- 4 2-D matrix code (QR code)



For detailed information on the data on the nameplate, see the Operating Instructions for the device.

4 Storage and transport

4.1 Storage conditions

Observe the following notes for storage:

- ▶ Store in the original packaging to ensure protection from shock.
- ▶ Do not remove protective covers or protective caps installed on process connections. They prevent mechanical damage to the sealing surfaces and contamination in the measuring tube.
- ▶ Protect from direct sunlight. Avoid unacceptably high surface temperatures.
- ▶ Store in a dry and dust-free place.
- ▶ Do not store outdoors.

4.2 Transporting the product

Transport the measuring device to the measuring point in the original packaging.



Do not remove protective covers or caps installed on process connections. They prevent mechanical damage to the sealing surfaces and contamination in the measuring tube.

4.2.1 Measuring devices without lifting lugs



Center of gravity of the measuring device is higher than the suspension points of the webbing slings.

Risk of injury if the measuring device slips.

- ▶ Secure the measuring device against slipping or turning.
- ▶ Observe the weight specified on the packaging (stick-on label).

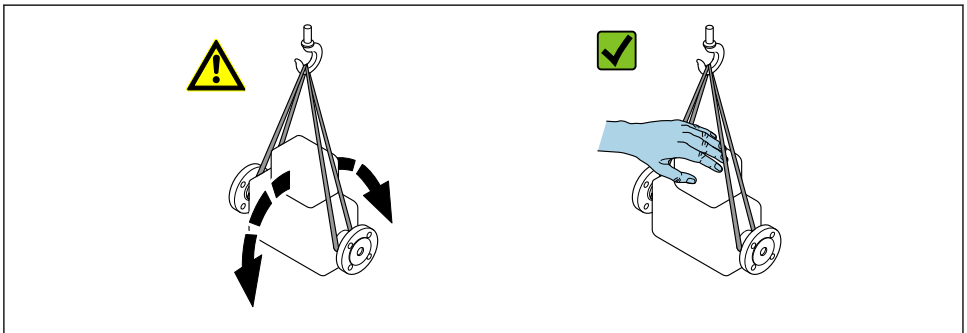

A00292.14

4.2.2 Measuring devices with lifting lugs



Special transportation instructions for devices with lifting lugs

- ▶ Only use the lifting lugs fitted on the device or flanges to transport the device.
- ▶ The device must always be secured at two lifting lugs at least.

4.2.3 Transporting with a fork lift

If transporting in wood crates, the floor structure enables the crates to be lifted lengthwise or at both sides using a forklift.

5 Installation

5.1 Installation requirements

No special measures such as supports are necessary. External forces are absorbed by the construction of the device.

5.1.1 Installation position

Mounting location

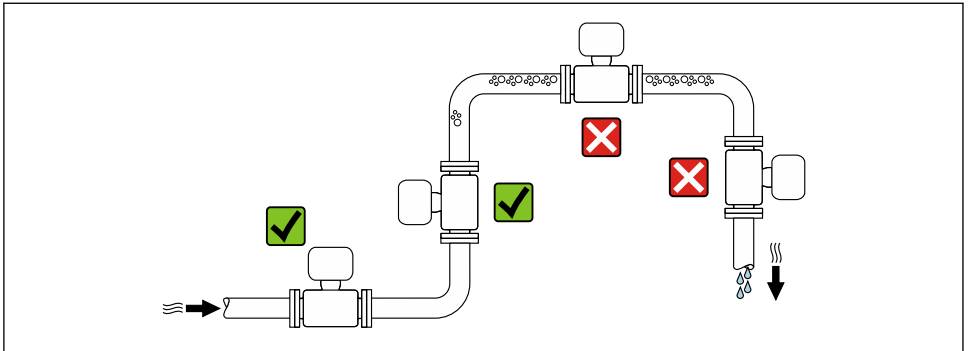

A0028772

Installation in down pipes

However, the following installation suggestion allows for installation in an open vertical pipeline. Pipe restrictions or the use of an orifice with a smaller cross-section than the nominal diameter prevent the sensor running empty while measurement is in progress.

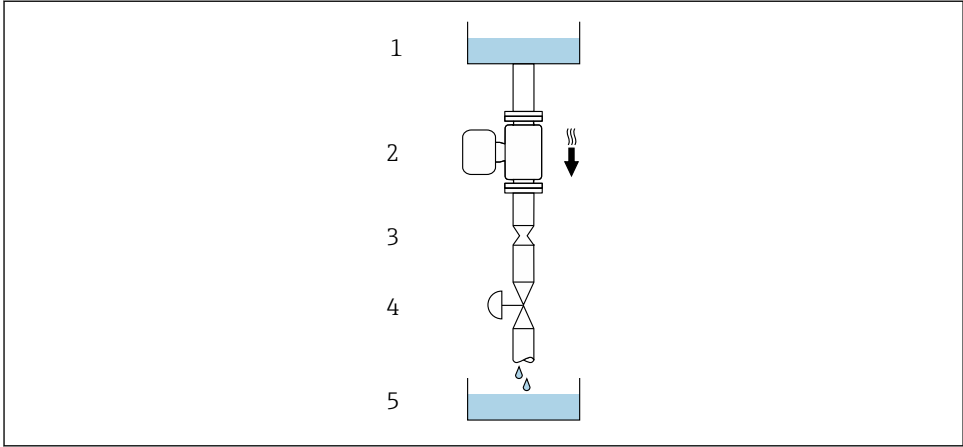

A0028773



2 Installation in a down pipe (e.g. for batching applications)

- 1 Supply tank
- 2 Sensor
- 3 Orifice plate, pipe restriction
- 4 Valve
- 5 Filling container

DN/NPS		Ø orifice plate, pipe restriction	
[mm]	[in]	[mm]	[in]
8	3/8	6	0.24
15	1/2	10	0.40
25	1	14	0.55
40	1 1/2	22	0.87
50	2	28	1.10
80	3	50	1.97

Orientation

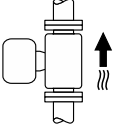
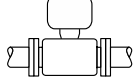
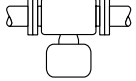
The direction of the arrow on the sensor nameplate helps you to install the sensor according to the flow direction.

Orientation			Recommendation
A	Vertical orientation	 A0015591	☑☑ ¹⁾
B	Horizontal orientation, transmitter at top	 A0015589	☑☑ ²⁾ Exception: → ☑ 3, ☑ 15
C	Horizontal orientation, transmitter at bottom	 A0015590	☑☑ ³⁾ Exception: → ☑ 3, ☑ 15
D	Horizontal orientation, transmitter at side	 A0015592	☒

- 1) This orientation is recommended to ensure self-draining.
- 2) Applications with low process temperatures may reduce the ambient temperature. To maintain the minimum ambient temperature for the transmitter, this orientation is recommended.
- 3) Applications with high process temperatures may increase the ambient temperature. To maintain the maximum ambient temperature for the transmitter, this orientation is recommended.

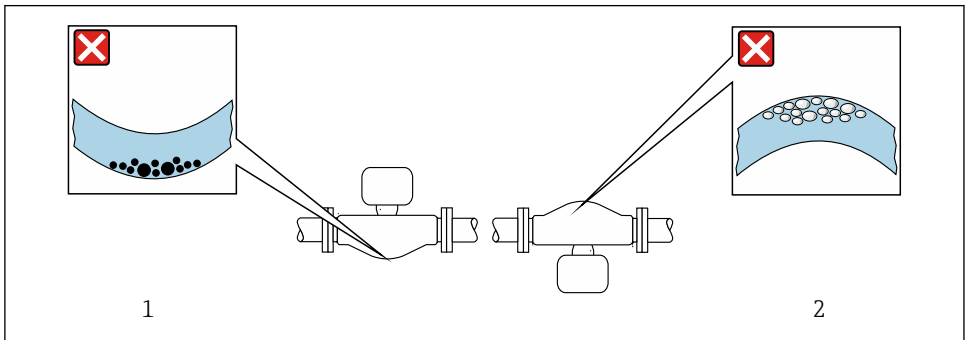

A0028774



☑ 3 Orientation of sensor with curved measuring tube

- 1 Avoid this orientation for media with entrained solids: Risk of solids accumulating
- 2 Avoid this orientation for outgassing media: Risk of gas accumulating

Inlet and outlet runs

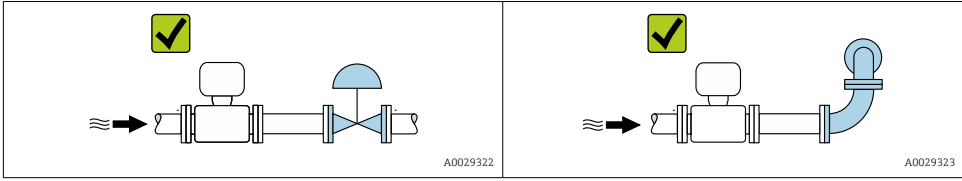
No special precautions need to be taken for fittings that create turbulence, such as valves, elbows or T-pieces, as long as no cavitation occurs →  16.



 For the dimensions and installed lengths of the device, see the "Technical Information" document, "Mechanical construction" section →  3

5.1.2 Environmental and process requirements

Ambient temperature range

 For detailed information on the ambient temperature range, see the Operating Instructions for the device.

If operating outdoors:

- Mount the measuring instrument in a shady location.
- Avoid direct sunlight, particularly in warm climatic regions.
- Avoid direct exposure to weather conditions.

*Temperature tables*²⁾

 For detailed information on the temperature tables, see the separate document entitled "Safety Instructions" (XA) for the device.

Static pressure

It is important that cavitation does not occur, or that gases entrained in the liquids do not outgas. This is prevented by means of a sufficiently high static pressure.

For this reason, the following mounting locations are recommended:

- At the lowest point in a vertical pipe
- Downstream from pumps (no danger of vacuum)

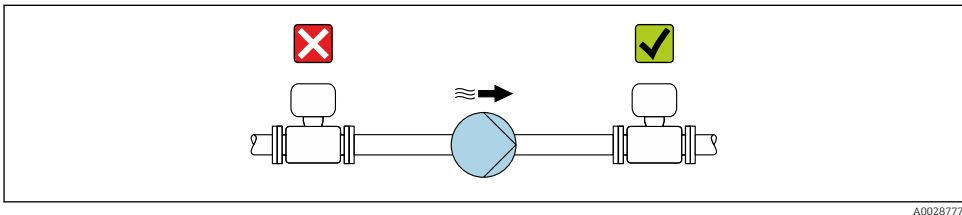

A0028777

2) Not applicable for IO-Link measuring instruments

Thermal insulation

In the case of some fluids, it is important to keep the heat radiated from the sensor to the transmitter to a low level. A wide range of materials can be used for the required insulation.

NOTICE

Electronics overheating on account of thermal insulation!

- ▶ Recommended orientation: horizontal orientation, transmitter housing (Promass 10, 100, 200, 300) or sensor connection housing (Promass 500) pointing downwards.
- ▶ Do not insulate the transmitter housing or connection housing of the sensor.
- ▶ Maximum permissible temperature at the lower end of the transmitter housing or connection housing of the sensor: 80 °C (176 °F)
- ▶ Thermal insulation with exposed extension neck: We recommend that you do not insulate the extension neck in order to ensure optimum dissipation of heat.

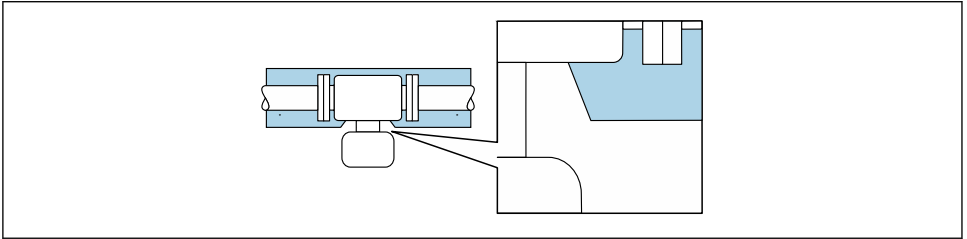

A0034391

4 Thermal insulation with exposed extension neck

Heating

NOTICE

Electronics can overheat due to elevated ambient temperature!

- ▶ Observe maximum permitted ambient temperature for the transmitter.
- ▶ Depending on the medium temperature, take the device orientation requirements into account.

NOTICE

Danger of overheating when heating

- ▶ Ensure that the temperature at the lower end of the transmitter housing does not exceed 80 °C (176 °F).
- ▶ Ensure that sufficient convection takes place at the transmitter neck.
- ▶ Ensure that a sufficiently large area of the transmitter neck remains exposed. The uncovered part serves as a radiator and protects the electronics from overheating and excessive cooling.

Heating options

If a medium requires that no heat loss should occur at the sensor, users can avail of the following heating options:

- Electrical heating, e.g. with electric band heaters ³⁾
- Via pipes carrying hot water or steam
- Via heating jackets



For detailed information on heating with electric band heaters, see the Operating Instructions for the device.

Vibrations

The high oscillation frequency of the measuring tubes ensures that the correct operation of the measuring system is not influenced by plant vibrations.

5.1.3 Special installation instructions

Drainability

When installed vertically, the measuring tubes can be drained completely and protected against buildup.

Rupture disk



Danger from medium escaping!

Medium escaping under pressure can cause injury or material damage.

- ▶ Take precautions to prevent danger to persons and damage if the rupture disk is actuated.
- ▶ Observe the information on the rupture disk sticker.
- ▶ Make sure that the function and operation of the rupture disk is not impeded through the installation of the device.
- ▶ Do not use a heating jacket.
- ▶ Do not remove or damage the rupture disk.

The position of the rupture disk is indicated on a sticker applied over it. If the rupture disk is triggered, the sticker is destroyed. The disk can therefore be visually monitored.

3) The use of parallel electric band heaters is generally recommended (bidirectional electricity flow). Particular considerations must be made if a single-wire heating cable is to be used. Additional information is provided in the document EA01339D "Installation instructions for electrical trace heating systems".

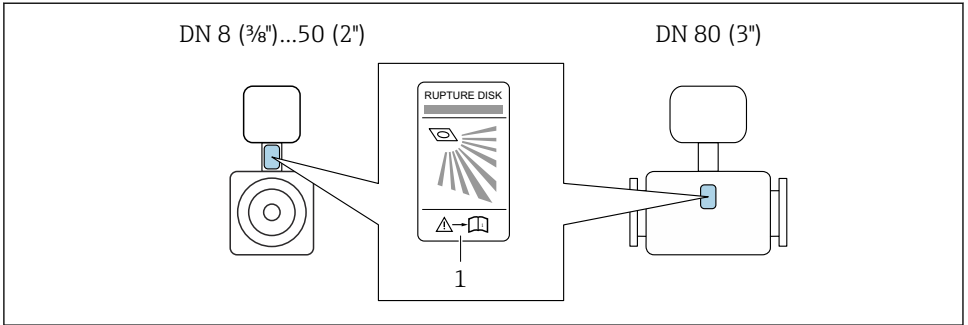

A0029956

1 Rupture disk label



For detailed information on the use of a rupture disk: see the Operating Instructions for the device.

Zero point adjustment

All devices are calibrated in accordance with state-of-the-art technology and under reference conditions. Zero point adjustment is not generally required. Zero point adjustment is advisable only in special cases:

- To achieve maximum measurement accuracy even with low flow rates
- In the event of extreme process conditions or operating conditions, e.g. very high process temperatures or very high-viscosity media.
- For gas applications with low pressure.



To optimize measurement accuracy at low flow rates, the installation must shield the sensor from mechanical stresses during operation.



Information on checking the zero point and performing a zero point adjustment: Operating instructions for the device.

Prerequisite

- Zero adjustment can only be performed with media that have no gas or solid contents.
- Zero adjustment is performed at operating pressure and operating temperature with the measuring pipes completely filled and at zero flow ($v = 0$ m/s). For this purpose, shut-off valves (for example) can be provided upstream or downstream from the sensor, or existing valves and gate valves may be used.

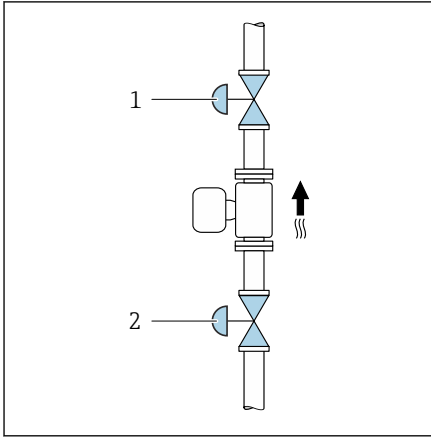

- Normal operation: shutoff valve 1 and 2 open.
- Zero adjustment with pump pressure: shutoff valve 1 closed, shutoff valve 2 open.
- Zero adjustment without pump pressure: shutoff valve 1 open, shutoff valve 2 closed.

5.2 Installing the device

5.2.1 Required tools

For flanges and other process connections, use an appropriate mounting tool

5.2.2 Preparing the measuring instrument

1. Remove all remaining transport packaging.
2. Remove any protective covers or protective caps present from the sensor.
3. If present, remove transport protection of the rupture disk.
4. Remove stick-on label on the electronics compartment cover.

5.2.3 Installing the sensor

⚠ WARNING

Danger due to improper process sealing!

- ▶ Ensure that the inside diameters of the gaskets are greater than or equal to that of the process connections and piping.
- ▶ Ensure that the seals and sealing surfaces are clean and undamaged.
- ▶ Secure the seals correctly.

1. Ensure that the direction of the arrow on the nameplate of the sensor matches the flow direction of the medium.

2. Install the measuring instrument or turn the transmitter housing so that the cable entries do not point upwards.

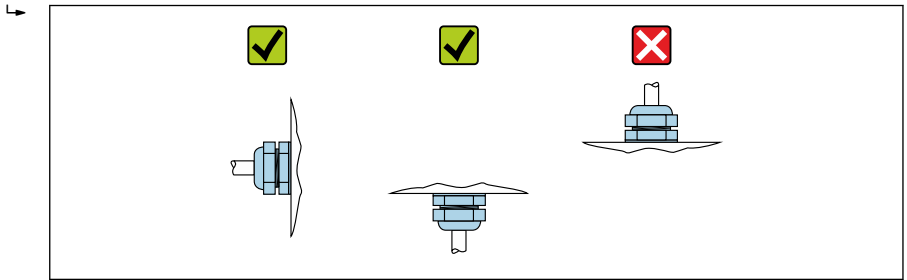

A0029263

5.3 Post-installation check

Is the device undamaged (visual inspection)?	<input type="checkbox"/>
Does the measuring instrument correspond to the measuring point specifications? For example: <ul style="list-style-type: none"> ▪ Process temperature ▪ Pressure (refer to the "Pressure-temperature ratings" section of the "Technical Information" document). ▪ Ambient temperature ▪ Measuring range 	<input type="checkbox"/>
Has the correct orientation for the sensor been selected → 14? <ul style="list-style-type: none"> ▪ According to sensor type ▪ According to medium temperature ▪ According to medium properties (outgassing, with entrained solids) 	<input type="checkbox"/>
Does the arrow on the sensor match the direction of flow of the medium? → 14?	<input type="checkbox"/>
Is the tag name and labeling correct (visual inspection)?	<input type="checkbox"/>
Is the device sufficiently protected from precipitation and direct sunlight?	<input type="checkbox"/>
Are the securing screw and securing clamp tightened securely?	<input type="checkbox"/>

6 Disposal

 If required by the Directive 2012/19/EU on waste electrical and electronic equipment (WEEE), the product is marked with the depicted symbol in order to minimize the disposal of WEEE as unsorted municipal waste. Do not dispose of products bearing this marking as unsorted municipal waste. Instead, return them to the manufacturer for disposal under the applicable conditions.

6.1 Removing the measuring device

1. Switch off the device.

WARNING

Risk of personal injury due to process conditions!

- ▶ Beware of hazardous process conditions such as pressure in the measuring device, high temperatures or aggressive media.
2. Carry out the mounting and connection steps from the "Mounting the measuring device" and "Connecting the measuring device" sections in reverse order.
 3. Observe the safety instructions.

6.2 Disposing of the measuring device

WARNING

Danger to personnel and environment from fluids that are hazardous to health.

- ▶ Ensure that the measuring device and all cavities are free of fluid residues that are hazardous to health or the environment, e.g. substances that have permeated into crevices or diffused through plastic.

Follow these instructions when disposing of the device:

- ▶ Comply with national regulations.
- ▶ Ensure proper separation and reuse of the device components.



71756818

www.addresses.endress.com
