

# Technical Information

## Liquiphant FTL63 Density with Density Calculator QML51

Vibronic



Density calculator for liquids  
specifically for the food and life sciences industries

### Application

The density measuring line can be used in liquid media and in hazardous areas. It is used for the following purposes:

- Density measurement
- Intelligent medium detection
- Calculation of reference density and concentration
- To convert values to different units such as °Brix, °Baumé, °API etc.

### Advantages

- Measurement used directly in tanks or pipes without the need for additional pipework
- Density Computer QML51 used for up to two measuring points
- Integration of existing temperature measurements for temperature compensation
- Integration of a pressure measuring instrument for pressure-compensated density measurement
- Hygienic sensor design (3-A, EHEDG) and conformity with materials standards, e.g., EG1935/2004, FDA, GB4806, cGMP

## Table of contents

<b>About this document</b> .....	<b>3</b>	<b>Certificates and approvals</b> .....	<b>36</b>
Symbols .....	3	CE mark .....	37
<b>Function and system design</b> .....	<b>4</b>	Ex approval .....	37
Density measurement and concentration calculation .....	4	Other standards and guidelines .....	37
Measuring principle .....	4	Additional information on Liquiphant Density .....	37
Measuring system .....	5	<b>Ordering information</b> .....	<b>38</b>
Specific density applications .....	6	Service .....	38
Electronic insert for density measurement .....	7	Test reports, declarations and inspection certificates .....	38
Density Computer QML51 .....	7	Test, certificate, declaration .....	38
Application examples .....	7	TAG .....	38
Network connection .....	8	<b>Accessories</b> .....	<b>39</b>
Communication and data processing .....	8	Accessories .....	39
<b>Inputs</b> .....	<b>9</b>	Accessories for Density Computer QML51 .....	41
Input of Liquiphant Density .....	9	<b>Documentation</b> .....	<b>41</b>
Input of Density Computer QML51 .....	10	Standard documentation .....	41
<b>Outputs</b> .....	<b>10</b>	Supplementary device-dependent documentation .....	41
Output of Liquiphant Density .....	10	<b>Registered trademarks</b> .....	<b>42</b>
Output of Density Calculator QML51 .....	11		
<b>Power supply</b> .....	<b>11</b>		
Power supply of Liquiphant Density .....	11		
Power supply of Density Calculator QML51 .....	13		
<b>Performance characteristics</b> .....	<b>14</b>		
Reference operating conditions .....	14		
Measurement accuracy .....	14		
<b>Installation</b> .....	<b>15</b>		
Liquiphant Density .....	15		
Density Calculator QML51 .....	19		
<b>Environment</b> .....	<b>19</b>		
Liquiphant Density .....	19		
Density Computer QML51 .....	21		
<b>Liquiphant Density process</b> .....	<b>22</b>		
Process temperature range .....	22		
Thermal shock .....	22		
Process pressure range .....	22		
Pressure tightness .....	22		
Solids contents .....	22		
<b>Mechanical construction</b> .....	<b>22</b>		
Mechanical construction of Liquiphant Density .....	22		
Mechanical construction of Density Calculator QML51 .....	32		
<b>Operability</b> .....	<b>34</b>		
Local display .....	34		
Controls .....	34		
Interfaces for data transmission .....	35		

## About this document

### Symbols

#### Safety symbols

 **DANGER**

This symbol alerts you to a dangerous situation. Failure to avoid this situation will result in serious or fatal injury.

 **WARNING**

This symbol alerts you to a potentially dangerous situation. Failure to avoid this situation can result in serious or fatal injury.

 **CAUTION**

This symbol alerts you to a potentially dangerous situation. Failure to avoid this situation can result in minor or medium injury.

 **NOTICE**

This symbol alerts you to a potentially harmful situation. Failure to avoid this situation can result in damage to the product or something in its vicinity.

#### Symbols for certain types of information

 **Permitted**

Procedures, processes or actions that are permitted

 **Preferred**

Procedures, processes or actions that are preferred

 **Forbidden**

Procedures, processes or actions that are forbidden

 **Tip**

Indicates additional information



Reference to documentation



Reference to page



Reference to graphic

#### Symbols in graphics

1, 2, 3, ...

Item numbers

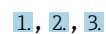

Series of steps



Result of a step



Notice or individual step to be observed

A, B, C, ...

Views

 **Viewing angle**

Indicates the object is shown from another view



 **Hazardous area**



Indicates the hazardous area

 **Safe area (non-hazardous area)**

Indicates the non-hazardous area

#### Electrical symbols

Symbol	Meaning
	Direct current
	Alternating current

Symbol	Meaning
	Direct current and alternating current
	<b>Ground connection</b> A grounded terminal which, as far as the operator is concerned, is grounded via a grounding system.
	<b>Protective earth (PE)</b> Ground terminals that must be connected to ground prior to establishing any other connections.  The ground terminals are located on the interior and exterior of the device: <ul style="list-style-type: none"> <li>▪ Interior ground terminal: protective earth is connected to the mains supply.</li> <li>▪ Exterior ground terminal: device is connected to the plant grounding system.</li> </ul>

**Tool symbols**

 Flat-blade screwdriver

 Allen key

 Open-ended wrench

## Function and system design

**Density measurement and concentration calculation**

Determining the density and concentration, as well as media detection of liquids in tanks or pipes in all industries. Used, for example, for density and concentration measurements of acids, bases, solvents, pharmaceutical chemicals, sugar solutions, etc.

**Measuring principle**

**The measuring system consists of the following main components:**

- Liquiphant Density
- Density calculator

In conjunction with the density calculator, the Liquiphant Density measures the density of a Newtonian, purely viscous, liquid in pipes and tanks.

A piezoelectric drive causes the vibrating fork of the Liquiphant Density to vibrate at its resonance frequency. Changes in liquid density cause a change in the resonance frequency of the vibrating fork. As a result, the density of the medium has a direct impact on the resonance frequency of the vibrating fork. This effect is used for density measurement.

In the density calculator, the density of the liquid is calculated from the resonance frequency of the vibrating fork transmitted by the sensor and from stored sensor-specific parameters. To compensate for temperature and pressure influences, additional corresponding sensors can be connected to the density calculator.

## Measuring system

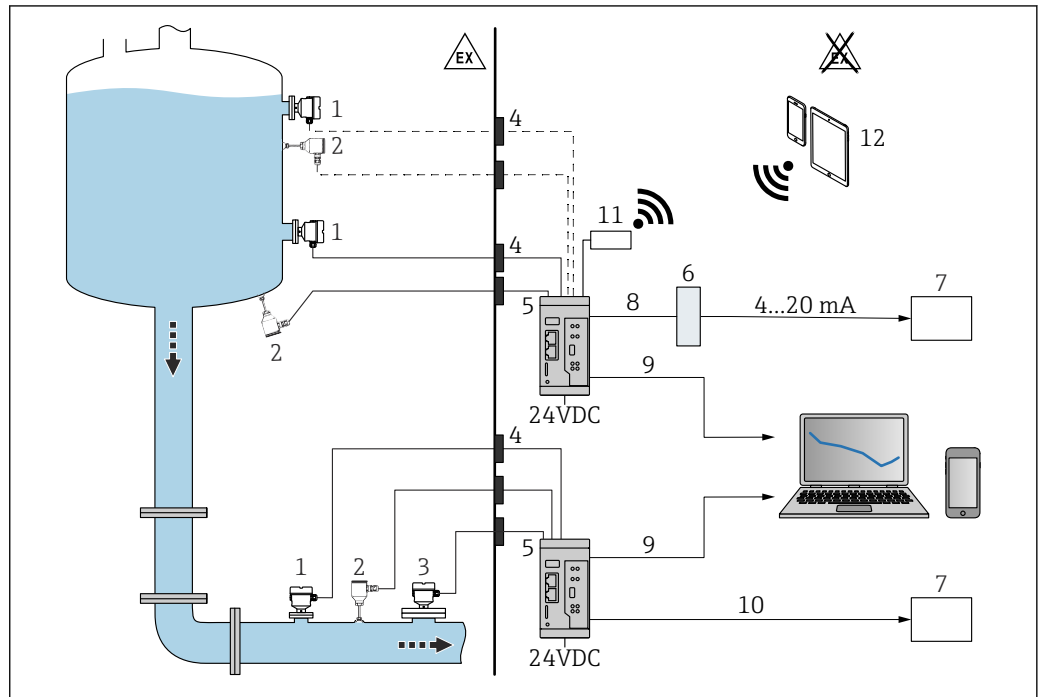

**1** Density measurement with Density Calculator QML51

- 1 Liquiphant Density with electronic insert FEL60D → pulse output
- 2 Temperature sensor, e.g. 4 to 20 mA output
- 3 Pressure transmitter 4 to 20 mA output; required for pressures above 6 bar (87 psi) or for pressure fluctuations.
- 4 Ex barrier (Liquiphant Density, temperature and/or pressure measuring cell installed in the hazardous area)
- 5 Density Calculator QML51
- 6 Modbus TCP to 4 to 20 mA converter
- 7 Programmable logic controller (PLC)
- 8 Modbus TCP
- 9 Ethernet
- 10 Modbus TCP or OPC UA
- 11 TELTONIKA Router RUT241 (accessory). For a wireless connection.
- 12 Mobile devices

**i** For use in hazardous areas: Ex barrier via RN22 active barrier. The two-channel RN22 active barrier powers analog device circuits and safety equipment up to SIL 2 (SC 3). The intrinsically safe, HART® transparent interface provides a reliable connection between the field devices and Density Calculator QML51. It is connected to 2-wire/4-wire devices in hazardous areas and provides a second galvanically isolated signal output in accordance with NAMUR NE 175.

In addition to calculating the density of a liquid medium, Density Calculator QML51 can also determine the reference density of the medium and the concentration of a solution, as well as detect up to four different media or an empty pipeline.

In doing so, the density calculator evaluates up to two measuring points and directly supplies connected two-wire transmitters with auxiliary power. This allows the connection of up to two Liquiphant Density sensors and two temperature sensors for compensation of temperature effects in order to calculate reference densities.

For concentration determination, stored standards such as ICUMSA for sugar concentrations, OIML ITS-90 for ethanol, and various preconfigured calculations for electrolyte solutions (according to the Laliberté-Cooper model) can be used.

Specific reference density or concentration tables can be entered manually in the form of linearization tables or imported into the density calculator in standard data formats (e.g., .csv, .xlsx) and used for calculations.

Density and concentration values can be output in various units, for example, SI units, °Baume, °Brix or °API.

Configuration of the QML51 is performed via an integrated web server, which can be accessed via a secure TLS connection using a standard web browser.

For output to a PLC or a SCADA system, the QML51 supports the Ethernet protocols Modbus TCP and OPC UA. If a current signal is required for connection to a PLC, this can be generated via a converter. A converter that generates up to 4 channels with an analog 4 to 20 mA signal from the Modbus TCP protocol is available as an accessory.

### Specific density applications

The density computer's software calculates the density from the frequency, temperature and pressure input variables.

### Operating principle

The oscillation frequency of the vibrating fork is reduced when the fork is completely covered with liquid. Since the density of the medium has a direct influence on the oscillation frequency, the density of the medium can be determined from the oscillation frequency based on this relationship. Using additional information, such as temperature and pressure, the current density of the medium can be compensated to a reference density or standard density. If the correlation between density and concentration is known, the concentration of the medium can be determined using a stored function. This value can be determined empirically or using existing tables or curves, for example. Standardized conversion tables from density to concentration are already stored in the density computer. Additional conversion tables can be provided by the customer and imported into the density computer.

Furthermore, up to four different media can be detected based on their density ranges. It is also possible to detect an empty pipe based on whether a certain density or frequency value is exceeded or not reached.

### Reference density

In this application, the system uses a reference temperature such as 15.56 °C (59 °F) or 20 °C (68 °F). The variation of the medium's density at other temperatures must be known.

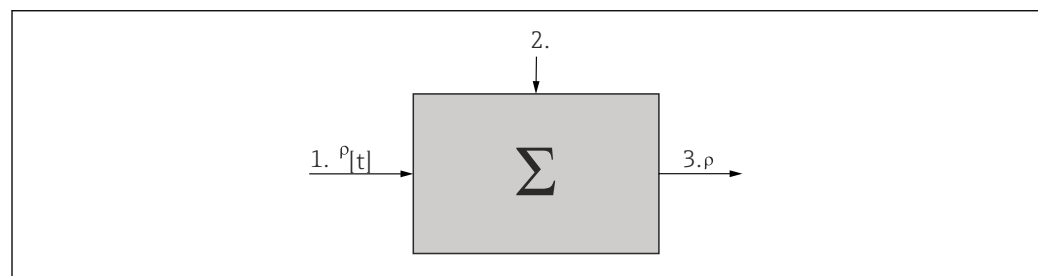

A0039650

- 1 Input data: Table  $\rho [t]$
- 2 Measured liquid medium: Temperature and density
- 3 Output: Calculated density  $\rho$  [standard]

### Concentration

Using density and concentration tables or curves already available or determined empirically, it is possible to determine the concentration when substances are continuously dissolved in a medium.

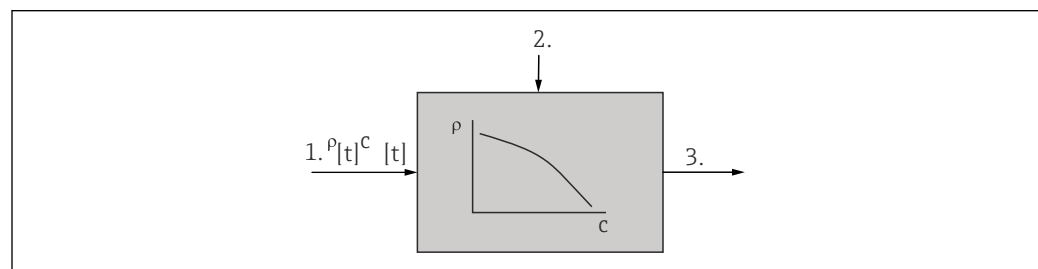

A0039651

- 1 Input data: Table  $\rho, c [t]$
- 2 Measured liquid medium: Temperature and density
- 3 Output: Calculated concentration

**Medium detection**

To be able to distinguish between two to four media, the density function can be stored for several media, depending on the temperature. This allows the system to differentiate between two to four media.

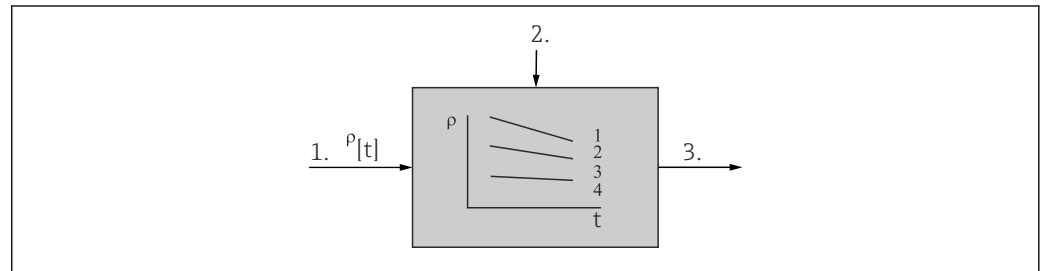

- 1 Input data: Tables  $\rho [t]$  for two liquid media
- 2 Measured liquid medium: Temperature and density
- 3 Output: Modbus TCP

A0039652

**Electronic insert for density measurement**

Electronic insert FEL60D

The output signal of the Liquiphant with density electronics FEL60D is based on pulse technology. This signal continuously transmits the measured resonance frequency of the Liquiphant to Density Computer QML51

**Density Computer QML51**

Transmitter for calculating density and concentration values, and for medium detection.

**Application examples**

-  The measurement can be affected by:
  - Air bubbles at the sensor
  - Sensor not fully covered by medium
  - Solid media buildup on the sensor
  - High fluid velocity in pipes
  - Severe turbulence in the pipe due to inlet and outlet runs that are too short
  - Corrosion of the fork
  - Non-Newtonian (not purely viscous) behavior of fluids

**Applications: Density and concentration measurement**

*1 density measuring line, temperature-compensated*

- 1x Liquiphant with electronic insert FEL60D
- 1x Density Computer QML51
- 1x 4 to 20 mA temperature transmitter

**Available outputs:** Modbus TCP, OPC UA, web browser

*2 density measuring lines, temperature-compensated*

- 2x Liquiphant with electronic insert FEL60D
- 1x Density Computer QML51
- 2x 4 to 20 mA temperature transmitter

**Available outputs:** Modbus TCP, OPC UA, web browser

*1 density measuring line, pressure and temperature-compensated*

- 1x Liquiphant with electronic insert FEL60D
- 1x Density Computer QML51
- 1x 4 to 20 mA temperature transmitter
- 1x pressure transmitter 4 to 20 mA

**Available outputs:** Modbus TCP, OPC UA, web browser

**Applications: Medium detection**

Detect 2-4 media

- 1x Liquiphant with electronic insert FEL60D
- 1x Density Computer QML51
- 1x 4 to 20 mA temperature transmitter
- **Available outputs:** Modbus TCP, OPC UA



Medium detection is performed on the basis of a configurable density and temperature range.

**Network connection**

The device can be connected into the computer network using 2 LAN ports that support the following connection speeds:

- 1 Gbit/s
- 100 Mbit/s
- 10 Mbit/s



The LAN ports support the "Auto MDI-X" feature. The ports automatically detect the type of connected cable (crossover or straight).

No special cables are required to connect the components.

**Communication and data processing**

- Measuring density of a liquid medium
- Liquiphant with electronic insert FEL60D and Density Calculator QML51
- Also for hazardous areas via intrinsically safe barrier accessories
- Up to 2 density measuring lines can be operated with Density Calculator QML51.



It is not possible to connect a device with a pulse output (PFM) and a device with a 4 to 20 mA HART or HART-only transmission to the same QML51 terminal block if the measured values are to be transmitted via HART communication.



It is not possible to connect two devices with a pulse output (PFM) to the same terminal block.

QML51 specifications	Version
Input terminals	2 x pulse <b>AND</b> 2 x 4 to 20 mA analog
	4 x 4 to 20 mA HART
Communication	Modbus TCP, OPC UA, web browser
Power supply mode	4 devices, max. current consumption per device: 24 mA

**Interface connection data****OPC UA**

The QML51 provides a preconfigured OPC UA server.



For additional information, see SD03498S.

**Modbus TCP**

Each of the two measuring points has a fixed register assignment, which is available via Device ID 1 for measuring point 1 and via Device 2 for measuring point 2 on the Modbus TCP server of the QML51. To connect the "Modbus TCP to 4-20 mA converter" accessory, Device 3 can be configured via the web browser according to the application.



For further information, see SD03501S.

**LAN interface**

The two LAN interfaces are compatible with IEEE 802.3. There are 2 shielded RJ45 sockets available for connection. The LAN interface can be used to connect the device to other devices with a hub or switch. The office equipment standard EN 60950 must be taken into consideration for safe distances between equipment. The arrangement corresponds to a standard MDI interface (AT&T258), which means that a shielded 1:1 cable with a maximum length of 100 m (328 ft) can be used. The device can operate with a bandwidth of 1 Gbit/s, 100 Mbit/s and 10 Mbit/s via the LAN interfaces. Direct connection to a PC is possible with a crossover cable. Half-duplex and full-duplex data transmission are supported.

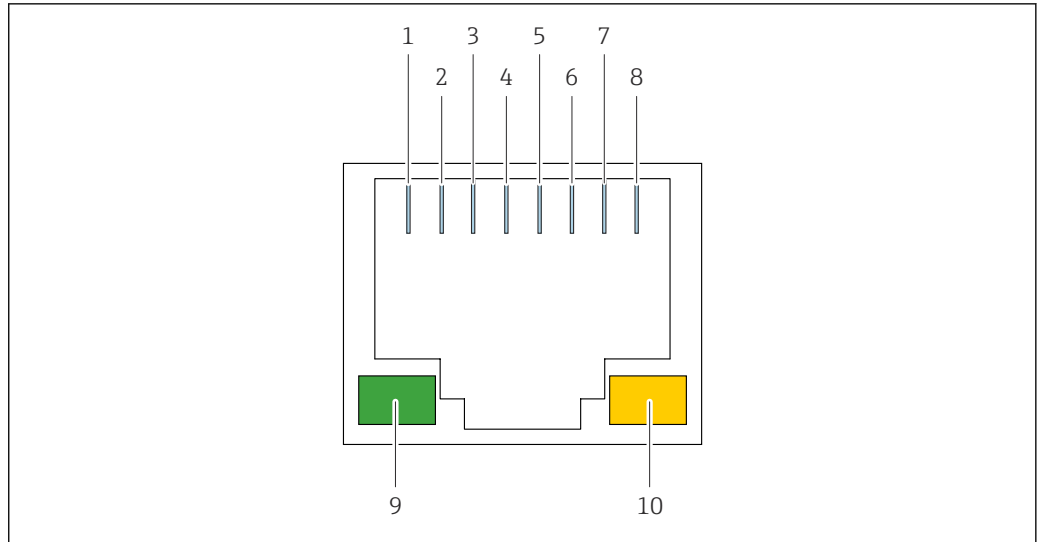

A0046134

2 Connection diagram for RJ45 socket

- 1 Tx+
- 2 Tx-
- 3 Rx+
- 4 Not connected
- 5 Not connected
- 6 Rx-
- 7 Not connected
- 8 Not connected
- 9 Green LED: link indicator
- 10 Yellow LED: active transfer indicator

### Dependability

#### Ease of maintenance

Firmware updates can be installed from the web server.

**i** The configuration of the device or saved log files are not changed if the firmware is updated.

#### Ease of maintenance

Firmware updates can be installed in a variety of ways:

- Ethernet connection
- SD card
- USB stick

**i** The configuration of the device or saved log files are not changed if the firmware is updated.

#### IT security

The manufacturer warranty is valid only if the product is installed and used as described in the Operating Instructions. The product is equipped with security mechanisms to protect it against any inadvertent changes to the settings.

IT security measures, which provide additional protection for the product and associated data transfer, must be implemented by the operators themselves in line with their security standards.

## Inputs

Input of Liquiphant Density	Measured variable
	Density of liquids

**Measuring range**

Density range: 0.3 to 2 g/cm<sup>3</sup> (18.7 to 125 lb/ft<sup>3</sup>) (0.3 to 2 SGU)

**Input of Density Computer QML51****Measured variable**

- Current (Analog input, 4 to 20 mA)
- PFM
- HART

 Only Liquiphant units with Endress+Hauser density electronics can be connected to the PFM input.

Not suitable for level and pressure measuring instruments.

**Input signals**

The following measured variables are implemented as an analog signal:

- Density
- Temperature
- Pressure

**Measuring range****Current input**

- 4 to 20 mA
- Max. input current: 24 mA per channel
- Measurement accuracy  $\pm 0.04$  mA
- Temperature drift:  $\pm 2 \mu\text{A} / \text{K}$
- Resolution: 12 bit

**PFM/pulse input**

- Frequency range: 10 to 160 Hz
- Measurement method: Period length or frequency measurement
- Temperature drift: 10 ppm at ambient temperatures of 15 to 45 °C

**HART**

- 4 to 20 mA + HART
- Fixed current: 4 mA (HART only)
- HART command 3: Up to four HART variables (PV, SV, TV, QV) are polled.

 PFM/pulse input and HART cannot be operated on one terminal block simultaneously.

**Galvanic isolation**

The terminals are galvanically isolated.

 With digital inputs, all terminal blocks are galvanically isolated from one another.

## Outputs

**Output of Liquiphant Density****Output and input variants****2-wire density (FEL60D) for density measurement**

Connection to Density Calculator QML51

**Ex connection data****See Safety instructions (XA):**

All data relating to explosion protection are provided in separate Ex documentation and are available from the Downloads area:

Endress+Hauser website [www.endress.com](http://www.endress.com) → Downloads

The Ex documentation is supplied as standard with all devices approved for use in explosion hazardous areas.

#### **Intrinsically safe barrier**

The following devices must be connected to the density calculator via an intrinsically safe barrier or an active barrier if they are used in a hazardous area:

- Liquiphant devices with hazardous area approval
- Temperature devices with hazardous area approval
- Pressure equipment with hazardous area approval

---

#### **Output of Density Calculator QML51**

##### **Output signal**

Ethernet-based protocols Modbus TCP, OPC UA and web browser.



For detailed information, see the Technical Information for Density Calculator QML51 (TIO1866F)

Analog outputs can be implemented via a Modbus TCP to 4 to 20 mA signal converter. A suitable signal converter can be ordered as an accessory for the density calculator.

## **Power supply**

---

#### **Power supply of Liquiphant Density**



Liquiphant with FEL60D electronics is powered via the connection to the PFM terminals of the QML51. A separate power supply is not required.

##### **NOTICE**

**Operation with other switching units is not permitted.**

Destruction of electronic components.

- ▶ Do not install the FEL60D electronic insert in devices that were originally used as point level switches.

## Terminal assignment

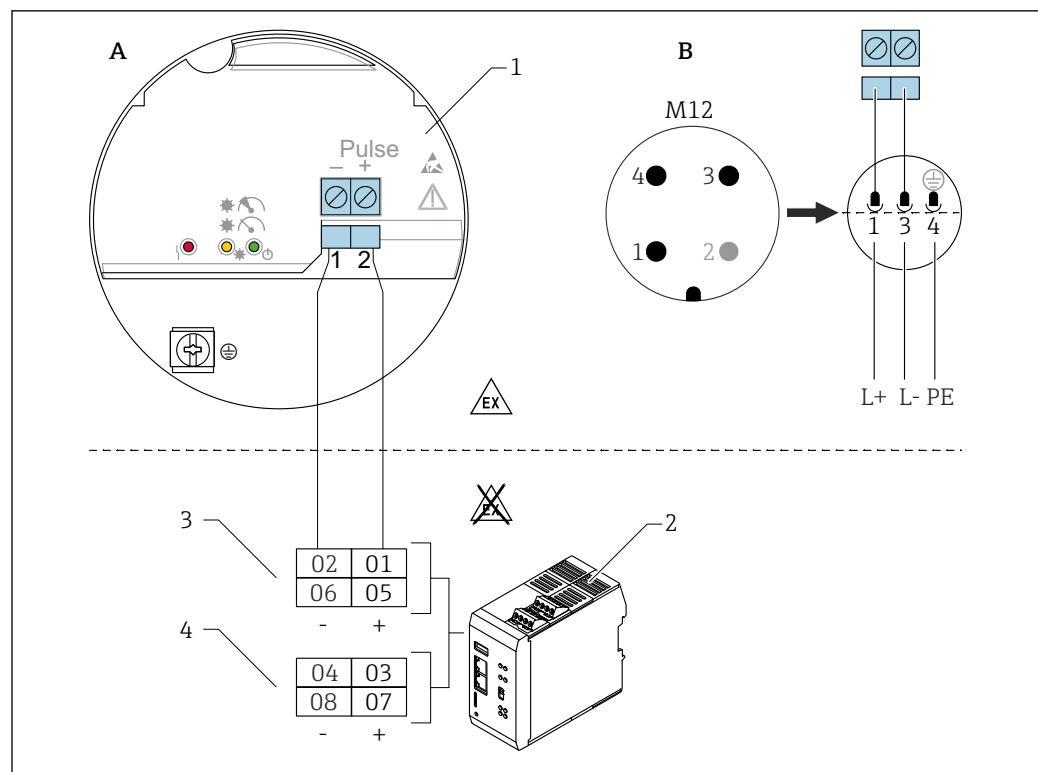

**3** Connection diagram: connection of electronic insert FEL60D to the Density Calculator QML51

A Connection wiring with terminals

B Connection wiring with M12 plug in housing as per EN61131-2 standard

1 Electronic insert FEL60D

2 Density Calculator QML51

3 PFM channels (default setting)

4 4 to 20 mA(HART) channels (default setting), e.g. for temperature measuring devices

**i** The channels are preset. The configuration can be changed.

**i** It is not possible to connect a device with a pulse output (PFM) and a device with a 4 to 20 mA HART or HART-only transmission to the same terminal block if the measured values are to be transmitted via HART communication.

**i** It is not possible to connect two devices with a pulse output (PFM) to the same terminal block.

The following devices can be connected to one terminal block:

- One device with a pulse output and one additional device with an analog output (4 to 20 mA).
- One device with a pulse output and one additional device with a 4 to 20 mA HART output, provided that HART communication is not used.
- Only one device with a pulse output. An additional device with a pulse output cannot be connected to the same terminal block.
- One or two devices with 4 to 20 mA or 4 to 20 mA HART. In this case, HART communication can be used by both devices.

**i** The previous Liquiphant Density version with FEL50D is compatible with Density Calculator QML51.

### Supply voltage

U = DC 24 V  $\pm$ 20 %, only suitable for connecting to the Density Computer QML51

**i** The device must be powered by a voltage supply categorized as "CLASS 2" or "SELV".

### Power consumption

P < 9 W

**Current consumption**

Density:  $I < 10 \text{ mA}$

**Overvoltage protection**

Overvoltage category I

**Pulse signal in case of alarm**

Output signal in case of power failure and damaged sensor: 0 Hz.

**Adjusting Liquiphant with density electronics FEL60D**

**There are 3 different types of adjustment:**

- **Standard adjustment (as delivered state):**  
To determine the sensor characteristics, the fork parameters are measured under two conditions (vacuum and a defined water bath). The device-specific parameters determined are supplied with the device in an adjustment report. These parameters must be transferred to the Density Computer QML51.
- **Special adjustment (select in the Product Configurator):**  
To determine the sensor characteristics, the fork parameters are measured under three conditions (vacuum and two defined water baths at specified temperatures). The device-specific parameters determined are supplied with the device in an adjustment report. These parameters must be transferred to the Density Computer QML51.  
This type of adjustment achieves an even higher level of accuracy.
- **Field adjustment:**  
During field adjustment, the density determined by the user is transferred to the Density Computer QML51.

 All the necessary parameters of the Liquiphant Density are documented in the **adjustment report** and in the **sensor pass**.

The documents are included in the scope of delivery.

 Further information and the documentation currently available can be found on the Endress+Hauser website: [www.endress.com](http://www.endress.com) → Downloads.

---

**Power supply of Density Calculator QML51**

**Terminal assignment of density computer**

 Use flexible stranded conductors only with ferrules.

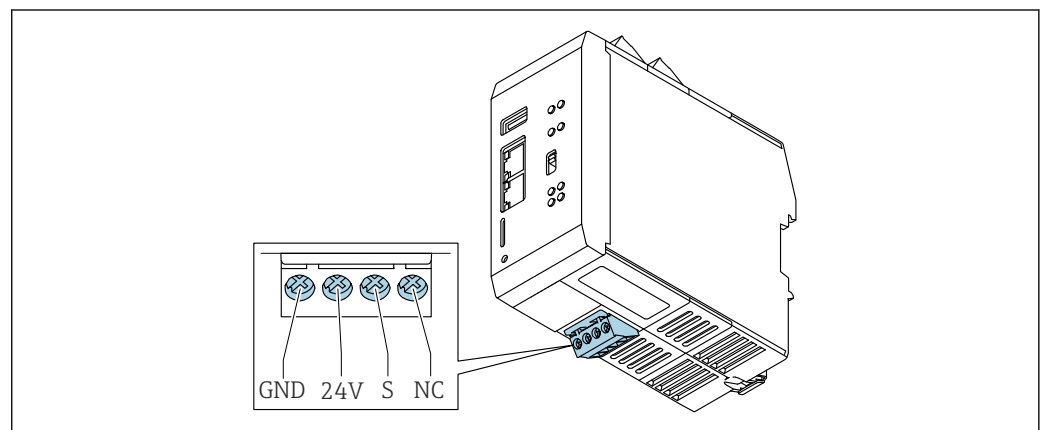

*GND* : functional grounding and negative potential of the power supply

*24V* : positive potential of the power supply

*S* : shield

*NC* : Not connected

**Supply voltage**

24 V<sub>DC</sub>

**Power consumption**

< 9 W

**Connecting the power supply****NOTICE**

Destruction of electronic components.

- ▶ Check whether the supply voltage matches the voltage indicated on the nameplate of the device.

**⚠ DANGER****Impermissible supply voltage**

There is a high risk of physical injury and damage to the electronic components.

▶

## Performance characteristics

**Reference operating conditions****Normal operating conditions for special calibration and Liquiphant Density**

- Medium: water H<sub>2</sub>O
- Medium temperature: 0 to 80 °C (32 to 176 °F), motionless fluid
- Ambient temperature: 24 °C (75 °F) ±5 °C (±9 °F)
- Moisture: max. 90 %
- Warm-up time: >30 min

**Measurement accuracy**

The accuracy described here refers to the entire density measuring line.

**General measuring conditions for accuracy data**

- Measuring range: 0.3 to 2 g/cm<sup>3</sup> (18.7 to 125 lb/ft<sup>3</sup>) (0.3 to 2 SGU)
- Observe the distance between the vibrating fork and the surface of the medium (> 50 mm (1.97 in)) see the "Orientation" section
- Measurement error, temperature sensor: < 1 K
- Maximum viscosity: 350 mPa·s (3.5 P)
- Maximum flow velocity: 2 m/s (6.56 ft/s)
  - Laminar flow rate, bubble-free
    - For higher flow velocities, structural measures such as a bypass or an increase in pipe diameter must be taken to reduce the flow velocity
- Process temperature: 0 to 80 °C (32 to 176 °F) - validity of accuracy data
- Power supply in accordance with specification QML51
- Data as per DIN EN 61298-2
- Process pressure: -1 to 25 bar (-14.5 to 362.5 psi)

**Measured error**

1 g/cm<sup>3</sup> (62.4 lb/ft<sup>3</sup>) = 1 SGU (Specific Gravity Unit)

- Standard adjustment: ±0.02 g/cm<sup>3</sup> (±1.2 lb/ft<sup>3</sup>) (±1.2 % of the span 1.7 g/cm<sup>3</sup> (106.1 lb/ft<sup>3</sup>), under general measuring conditions)
- Special adjustment: ±0.005 g/cm<sup>3</sup> (±0.3 lb/ft<sup>3</sup>) (±0.3 % of span 1.7 g/cm<sup>3</sup> (106.1 lb/ft<sup>3</sup>), under normal operating conditions)
- Field adjustment: ±0.002 g/cm<sup>3</sup> (±0.1 lb/ft<sup>3</sup>), at operating point

**Non-repeatability - reproducibility**

1 g/cm<sup>3</sup> (62.4 lb/ft<sup>3</sup>) = 1 SGU (Specific Gravity Unit)

- Standard adjustment: ±0.002 g/cm<sup>3</sup> (±0.1 lb/ft<sup>3</sup>) (under general measuring conditions)
- Special adjustment: ±0.0007 g/cm<sup>3</sup> (±0.04 lb/ft<sup>3</sup>) (under normal operating conditions)
- Field adjustment: ±0.002 g/cm<sup>3</sup> (±0.1 lb/ft<sup>3</sup>), at operating point

### Factors influencing accuracy data

- i** All information relating to measurement accuracy when determining the viscosity of liquids is based on Newtonian fluids
  - It is not possible to perform density measurement in the following liquids: gel, viscoelastic gel, non-Newtonian elastic, pseudoelastic and plastic-viscous liquids.
- Long-term drift typically:  $\pm 0.00002 \text{ g/cm}^3$  ( $\pm 0.0012 \text{ lb/ft}^3$ ) per day
- Temperature coefficient typically:  $\pm 0.0002 \text{ g/cm}^3$  ( $\pm 0.002 \text{ lb/ft}^3$ ) per 10 K
- Flow velocity in pipes:  $> 2 \text{ m/s}$  ( $6.56 \text{ ft/s}$ )
- Buildup on fork
- Air bubbles in the case of vacuum applications or improper installation
- Incomplete coverage of the fork
- In the event of changes in pressure  $> 5 \text{ bar}$  ( $72 \text{ psi}$ ), a pressure measurement is necessary for compensation
- In the event of changes in temperature  $> 1 \text{ K}$ , a temperature measurement is necessary for compensation
- Mechanical stress, such as deformation of the vibrating fork, can impair measurement accuracy and must be avoided
- Devices exposed to mechanical stress must be replaced

Cyclic field calibration can take place depending on the measurement accuracy required.

## Installation

### Liquiphant Density

**i** The following information is supplemented by additional documentation for the Liquiphant (Endress+Hauser website [www.endress.com](http://www.endress.com) → Downloads)

#### Orientation

The mounting location must be selected such that the vibrating fork and the membrane are always immersed in the medium.

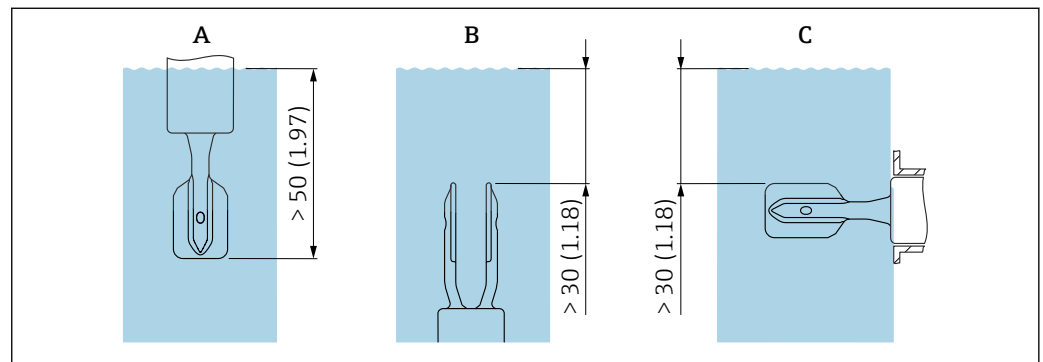

**4** Unit mm (in)

- A Installation from above
- B Installation from below
- C Installation from the side

- i** Avoid air bubbles in pipe or nozzle
- Ensure suitable ventilation
- i** Maximum viscosity:  $350 \text{ mPa}\cdot\text{s}$  ( $3.5 \text{ P}$ )

#### Input of correction factor "r"

The measurement result is affected if the distance between the tuning fork and the wall of the tank or pipe is very short:

- The medium has to flow around the tuning fork.
- The tuning fork of Liquiphant requires space to vibrate.

The measured error can be compensated for by entering a correction factor "r".

Pipe nominal diameters with internal measurements <44 mm (1.73 in) are not permitted!

 For detailed information, please refer to the relevant Operating Instructions.

**Inlet and outlet runs**

*Inlet run*

If possible, install the sensor as far upstream as possible, e.g. valves, T-pieces, elbows, flange elbows, etc.

To comply with the accuracy specification, the inlet run must meet the following requirements:

Inlet run:  $\geq 5x$  DN (nominal diameter) - min. 750 mm (29.5 in)

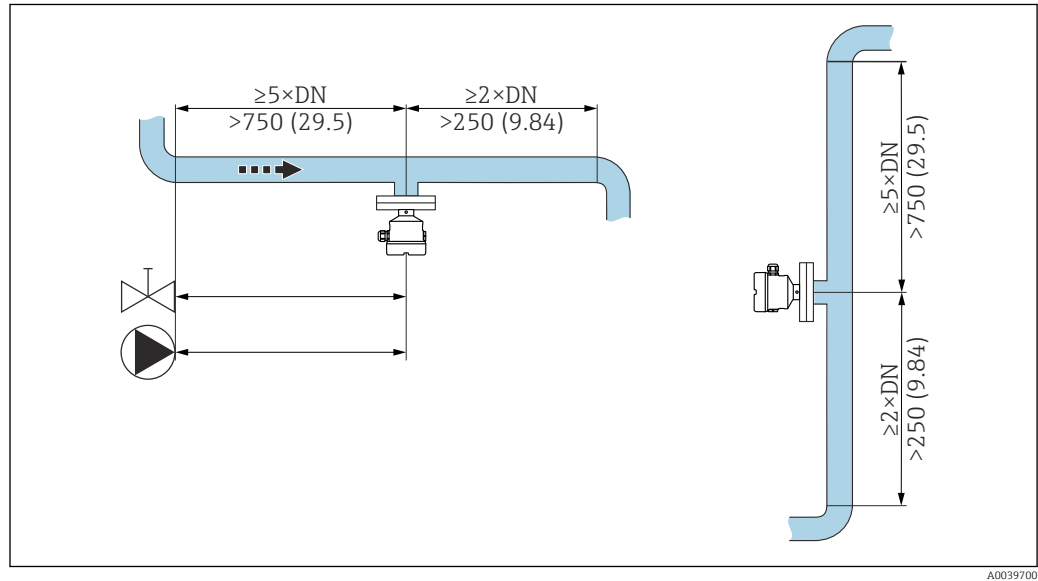

 5 Installing the inlet run. Unit of measurement mm (in)

*Outlet run*

To comply with the accuracy specification, the outlet run must meet the following requirements:

Outlet run:  $\geq 2x$  DN (nominal diameter) - min. 250 mm (9.84 in)

The pressure and temperature sensor must be installed on the outlet side of the flow direction after the Liquiphant density sensor. When installing pressure and temperature measuring points downstream of the device, make sure the distance between the measuring point and the device is sufficient.

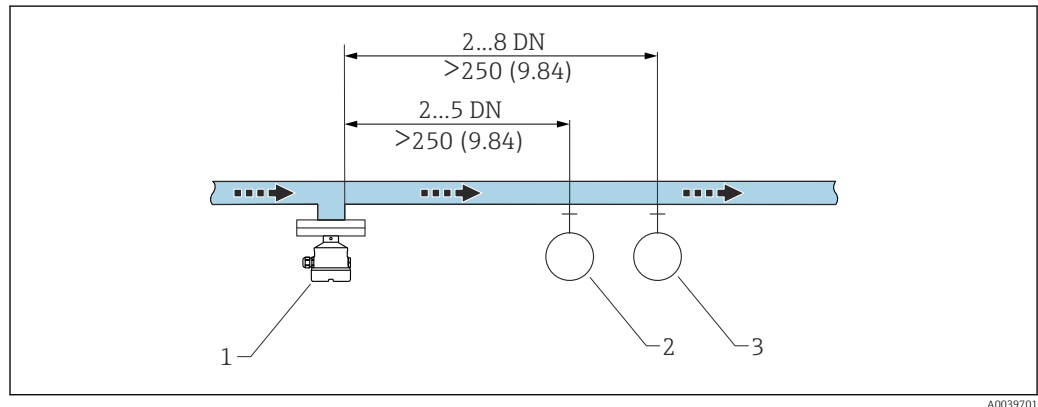

 6 Installing the outlet run. Unit of measurement mm (in)

- 1 Liquiphant density sensor
- 2 Pressure measuring point
- 3 Temperature measuring point

### Installing the device in piping

#### NOTICE

#### Incorrect alignment of the tuning fork

Vortices and eddies can falsify the measuring result.

- ▶ Align the tuning fork in the flow direction for internal fixtures in pipes or tanks with an agitator.
- The flow velocity of the medium must not exceed 2 m/s (6.56 ft/s) during operation
- Flow velocity > 2 m/s: Separate the tuning fork from the direct flow of media by using structural features such as a bypass or pipe expansion to reduce the flow velocity to max. 2 m/s (6.56 ft/s)
- The flow will not be significantly impeded if the tuning fork is correctly aligned and the marking is pointing in the direction of flow.
- A marking on the process connection indicates the position of the tuning fork.  
Threaded connection = dot on the hexagon head; flange = two lines on the flange.  
The marking is visible when installed.

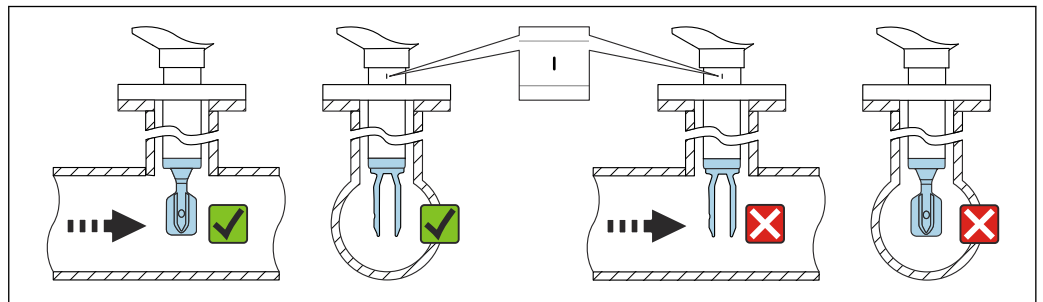

7 Installation in pipes (take fork position and marking into consideration)

### Aligning the cable entry

All housings can be aligned.

#### Housing without locking screw

The device housing can be rotated up to 350°.

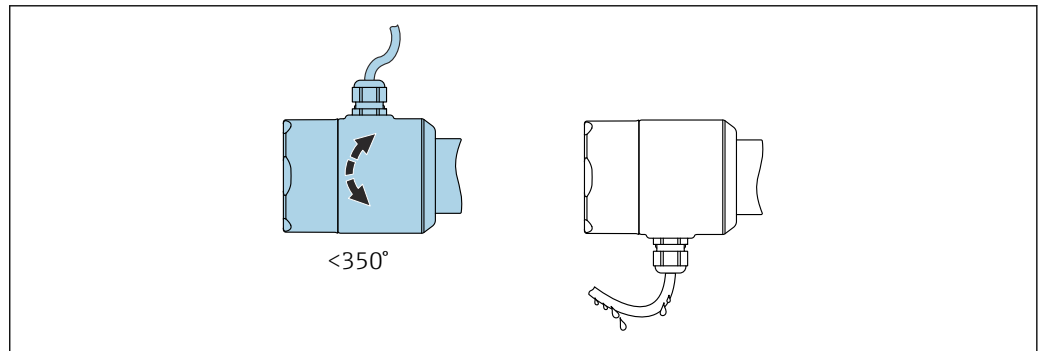

8 Housing without locking screw with drip loop

#### Housing with locking screw

- i** In the case of housings with locking screw:
  - The housing can be turned and the cable aligned by loosening the locking screw.  
A cable loop for draining prevents moisture in the housing.
  - When the device is delivered from the factory, the locking screw is tightened.

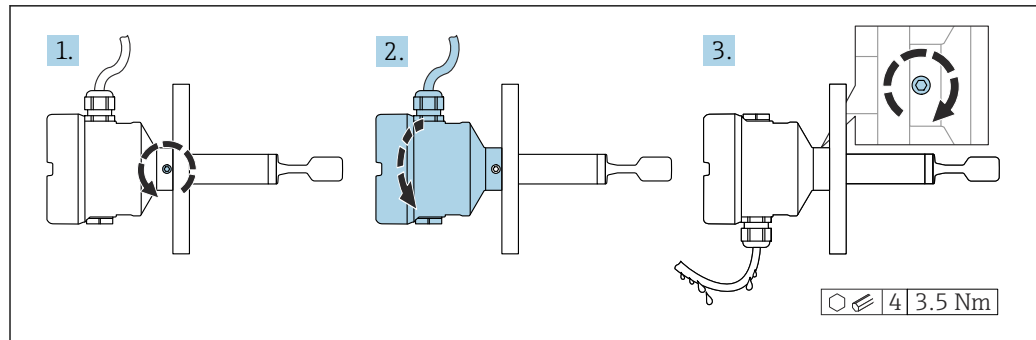

9 Housing with external locking screw and drip loop

### Special installation instructions

#### Vessel with heat insulation

If process temperatures are high, the device should be included in the vessel insulation system to prevent the electronics from heating as a result of thermal radiation or convection. The insulation in this case should not be higher than the neck of the device.

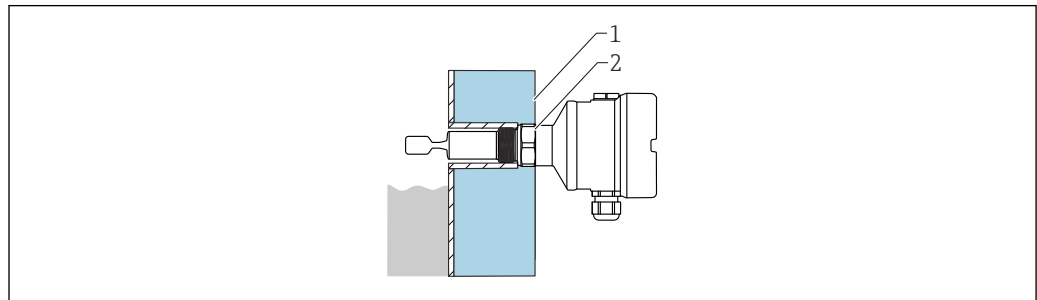

10 Example of a vessel with heat insulation

- 1 Vessel insulation
- 2 Insulation (up to the housing neck max.)

#### Support the device

Support the device in the event of severe dynamic load. Maximum lateral loading capacity of the pipe extensions and sensors: 75 Nm (55 lbf ft).

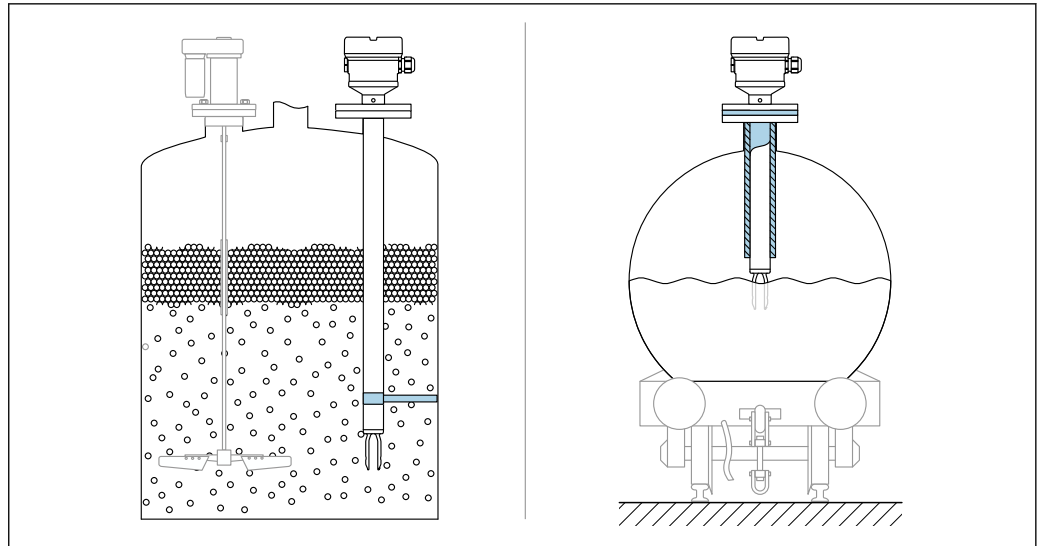

A0031874

11 Examples of support in the event of dynamic load

**i** Marine approval: In the case of pipe extensions or sensors longer than 1 600 mm (63 in), a support is needed at least every 1 600 mm (63 in).

*Weld-in adapter with leakage hole*

Position the weld-in adapter so that the leakage hole points downwards. This allows any leakage to be detected at an early stage, as the escaping medium becomes visible.

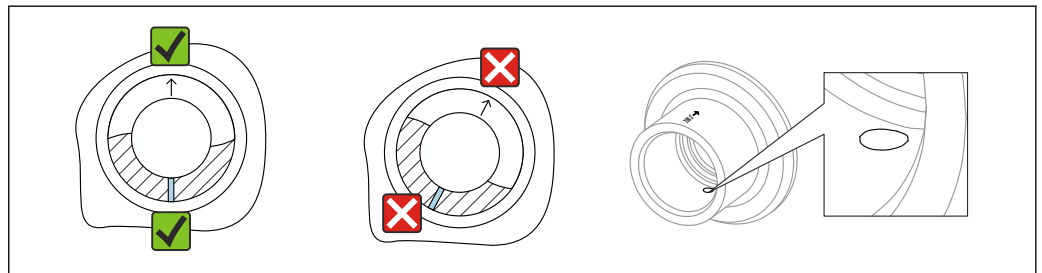

A0039230

12 Weld-in adapter with leakage hole

*Sliding sleeves*

**f** For more details, see the "Accessories" section.

**b** Special Documentation SD02398F (Installation Instructions)

**Density Calculator QML51**

**Mounting location**

Mount the device in a cabinet on a DIN rail as per IEC 60715.

**Orientation**

No restrictions.

**Environment**

**Liquiphant Density**

**Ambient temperature range**

-40 to 70 °C (-40 to 158 °F)

The minimum permitted ambient temperature of the plastic housing is limited to  $-20\text{ °C}$  ( $-4\text{ °F}$ ); 'indoor use' applies to North America.

Outdoor operation in strong sunlight:

- Mount the device in a shaded location
- Avoid direct sunlight, particularly in warmer climatic regions
- Use a weather protection cover, which can be ordered as an accessory



Further information on using the device in hazardous areas and on documentation that is currently available can be found on the Endress+Hauser website: [www.endress.com](http://www.endress.com) → Downloads.



#### **⚠ Hazardous area**

In the hazardous area, the permitted ambient temperature can be limited depending on the zones and gas groups. Pay attention to the information in the Ex documentation (XA).

### **Humidity**

Operation up to 100 %. Do not open in a condensing atmosphere.

### **Storage temperature**

$-40$  to  $80\text{ °C}$  ( $-40$  to  $176\text{ °F}$ )

### **Operating altitude**

As per IEC 61010-1 Ed.3:

- Up to 2 000 m (6 600 ft) above sea level
- Can be extended to 3 000 m (9 800 ft) above sea level if overvoltage protection is used

### **Climate class**

As per IEC 60068-2-38 test Z/AD

### **Degree of protection**

Testing according to IEC 60529 and NEMA 250

IP68 test condition: 1.83 m H<sub>2</sub>O for 24 h

### **Housing**

See cable entries

### **Cable entries**

- M20 coupling, plastic, IP66/68 NEMA Type 4X/6P
- M20 coupling, nickel-plated brass, IP66/68 NEMA Type 4X/6P
- M20 coupling, 316L, IP66/68 NEMA Type 4X/6P
- M20 coupling, 316L, hygienic, IP66/68/69 NEMA Type 4X/6P
- M20 thread, IP66/68 NEMA Type 4X/6P
- G ½ thread, NPT ½, NPT ¾ IP66/68 NEMA Type 4X/6P

Degree of protection for M12 plug

- When housing is closed and connection cable is plugged in: IP66/67 NEMA Type 4X
- When housing is open or connection cable is not plugged in: IP20, NEMA Type 1

### **NOTICE**

#### **M12 plug: Loss of IP protection class due to incorrect installation!**

- ▶ The degree of protection only applies if the connecting cable used is plugged in and screwed tight.
- ▶ The degree of protection only applies if the connecting cable used is specified according to IP67 NEMA Type 4X.



If the "M12 plug" option is selected as the electrical connection, **IP66/67 NEMA Type 4X** applies for all housing types.

### **Vibration resistance**

As per IEC 60068-2-64-2008

$a(\text{RMS}) = 50\text{ m/s}^2$ ,  $f = 5$  to  $2\,000\text{ Hz}$ ,  $t = 3$  axes x 2 h

For increased oscillations or vibrations, the following additional option is recommended: feature "Application", version "B" 100 bar (1 450 psi) process pressure.

**Shock resistance**

As per IEC 60068-2-27-2008:  $300 \text{ m/s}^2 [= 30 g_n] + 18 \text{ ms}$   
 $g_n$ : standard acceleration of gravity

**Mechanical load**

Support the device in the event of severe dynamic load. Maximum lateral loading capacity of the pipe extensions and sensors: 75 Nm (55 lbf ft).

 For more details, see the "Supporting the device" section.

**Pollution degree**

Pollution degree 2

**Electromagnetic compatibility (EMC)**

Electromagnetic compatibility as per the EN 61326 series and NAMUR Recommendation EMC (NE 21)  
Interference immunity according to Table 2 (Industrial), interference radiation according to Group 1 Class B

 For more details, refer to the EU Declaration of Conformity.

---

**Density Computer QML51**

**Ambient temperature range**

-20 to 60 °C (-4 to 140 °F)

**Transport and storage temperature**

-25 to 85 °C (-13 to 185 °F)

**Humidity**

EN 60068-2-30; Db; 0.5 K/min: 5 to 85 %; non-condensing

**Condensation**

Not permitted

**Operating height**

Up to 2 000 m (6 562 ft) above sea level

**Climate class**

IEC 60654-1, Class B2

**Ambient class**

Pollution degree: 2

**Degree of protection**

IP20 (as per IEC/EN 60529, NEMA 1)

IK06 (as per IEC/EN 61010-1)

**Vibration resistance**

EN 60068-2-64 / IEC60068-2-64: 20 to 2 000 Hz, 0.01  $g^2$ /Hz

**Shock resistance**

IEC60068-2-27:2008,  $\pm 15 g$ ; 11 ms

**Impact resistance**

1 J

**Electromagnetic compatibility (EMC)**

- Interference immunity: as per IEC 61326, industrial environment
- Interference emissions: as per IEC 61326, Class B



Information on connecting shielded cables is provided in Technical Information TI00241F, "EMC test procedures".

## Liquiphant Density process

**Process temperature range** 0 to 80 °C (32 to 176 °F)

**Thermal shock** ≤ 120 K/s

**Process pressure range** -1 to 25 bar (-14.5 to 362.5 psi)

### **⚠ WARNING**

#### **Incorrect design or use of the device may lead to bursting parts!**

This may result in severe, possibly irreversible injury to persons and environmental hazards.

- ▶ Only operate the device within the specified limits for the components!
- ▶ MWP (maximum working pressure): The maximum working pressure is specified on the nameplate. This value refers to a reference temperature of +20 °C (+68 °F) and may be applied to the device for an unlimited time. Observe the temperature dependency of the maximum working pressure. For higher temperatures, refer to the following standards for the permitted pressure values for flanges: EN 1092-1 (materials 1.4435 and 1.4404 are identical with regard to their stability/temperature property and are grouped together in under 13E0 in EN 1092-1 Tab. 18; the chemical composition of the two materials can be identical), ASME B 16.5a, JIS B 2220 (the latest version of the standard applies in each case).
- ▶ The Pressure Equipment Directive (2014/68/EU) uses the abbreviation "PS". The abbreviation "PS" corresponds to the maximum working pressure of the device.
- ▶ MWP data that deviate from this are provided in the relevant sections of the Technical Information.

**Pressure tightness** Up to vacuum

**Solids contents**  $\varnothing \leq 5$  mm (0.2 in)

## Mechanical construction

### **Mechanical construction of Liquiphant Density**

#### **Design, dimensions**

##### *Device height*

The device height consists of the following components:

- Housing including cover
- Temperature spacer and/or pressure-tight feedthrough (second line of defense), optional
- Compact version, pipe extension or short pipe version
- Process connection
- Probe design: compact version, pipe extension or short pipe version

The individual heights of the components can be found in the following sections:

- Determine the height of the device and add the individual heights
- Take the installation clearance into consideration (space that is needed to install the device)

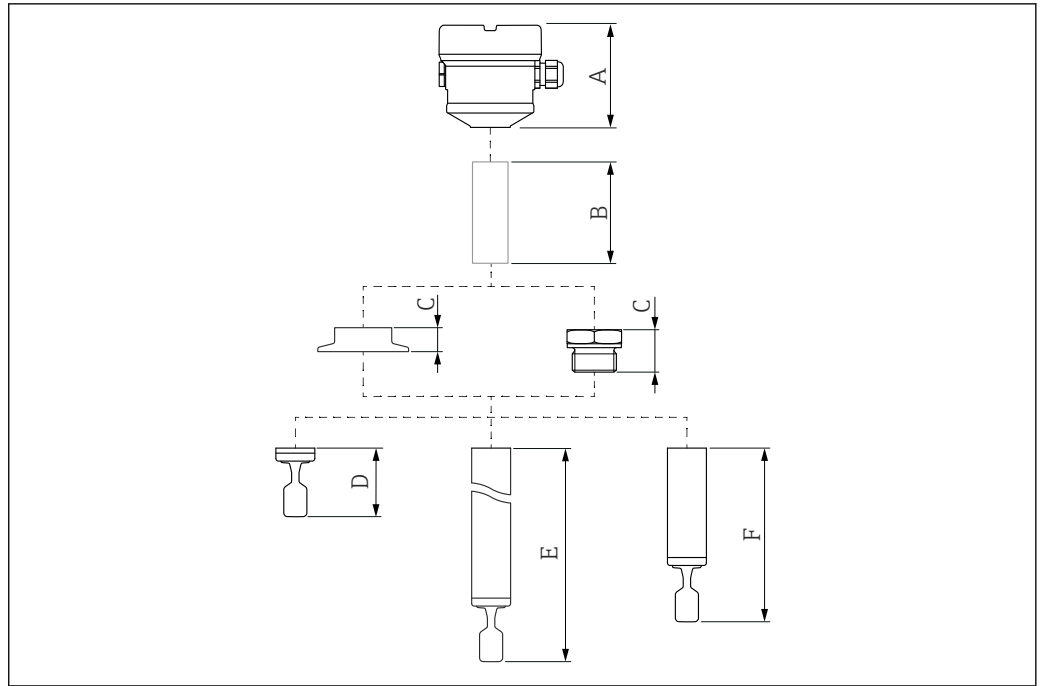

A0052410

13 Components for determining the height of the device

- A Housing with electronic insert FEL60D and cover
- B Temperature spacer, pressure-tight feedthrough (optional)
- C Process connection
- D Probe design: compact version with vibrating fork
- E Probe design: pipe extension with vibrating fork
- F Probe design: short pipe version with vibrating fork

**Dimensions**

*Housing and cover*

All housings can be aligned. The housing alignment can be fixed on housings with a locking screw.

*Single compartment housing, plastic*

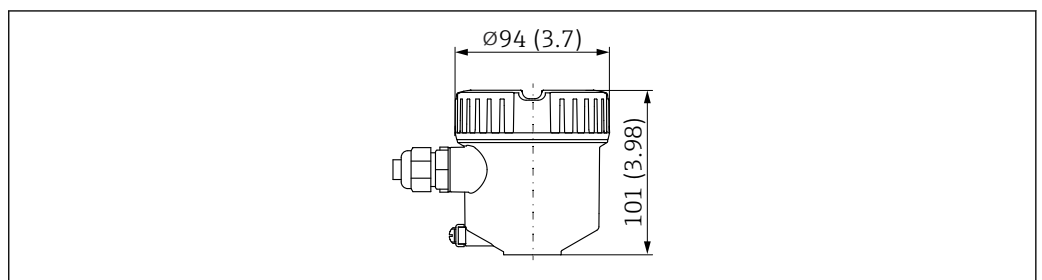

A0051909

14 Dimensions of single compartment housing, plastic; cover without sight glass. Unit of measurement mm (in)

Single compartment housing, aluminium, coated

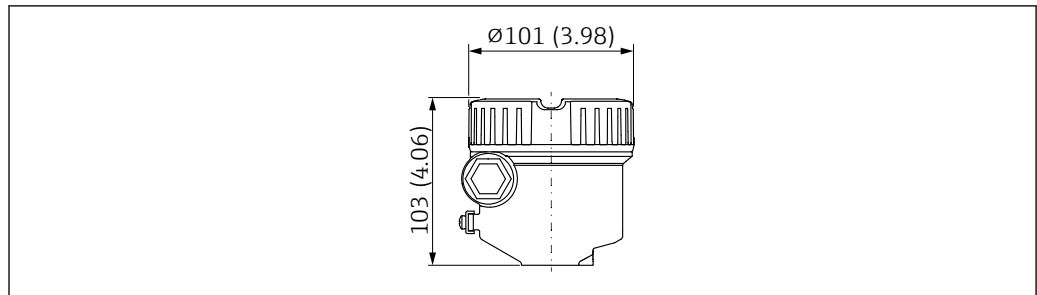

A0052195

15 Dimensions of single compartment housing, aluminium; cover without sight glass. Unit of measurement mm (in)

Single compartment housing, aluminum, coated (Ex d/XP, dust ignition-proof)

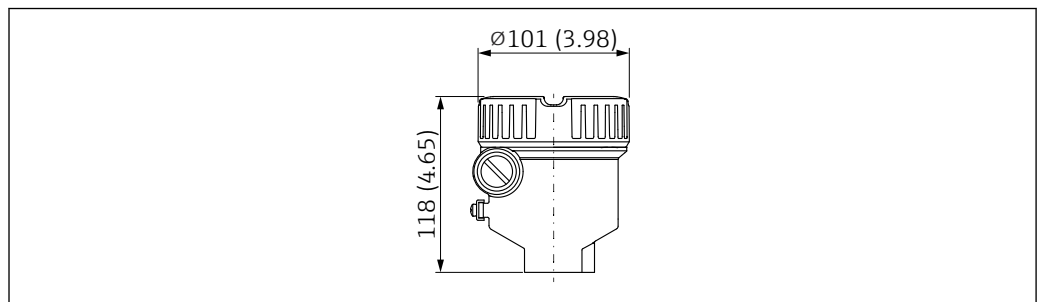

A0052194

16 Dimensions of single compartment housing, aluminum, coated; suitable for Ex d/XP, dust ignition-proof; cover without sight glass. Unit of measurement mm (in)

Single compartment housing, 316L, hygienic

**i** For use in hazardous areas with a certain type of protection, the ground terminal on the outside of the housing is required.

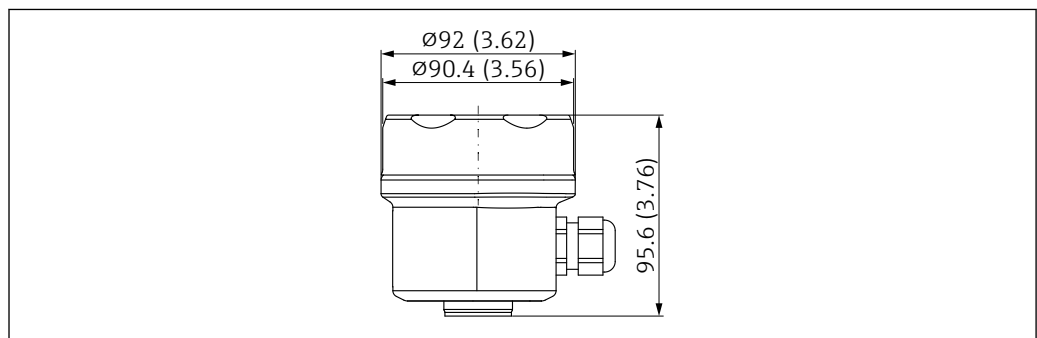

A0051667

17 Dimensions of single compartment housing, 316L, hygienic; cover without sight glass. Unit of measurement mm (in)

Dual compartment housing, L-shaped, aluminum, coated

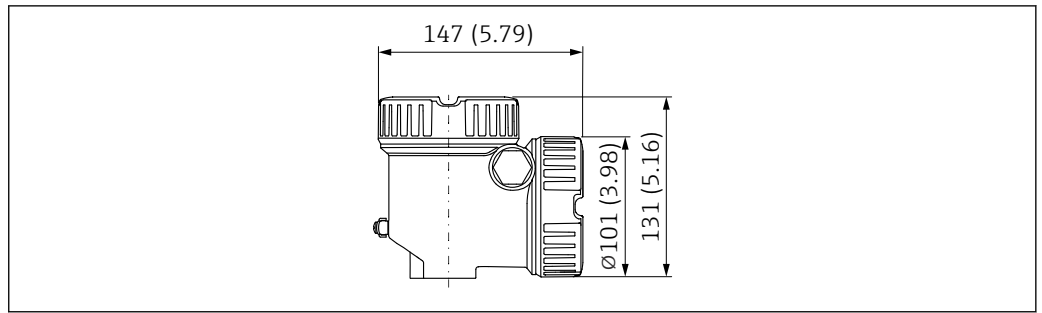

18 Dimensions of dual compartment housing, L-shaped, aluminum, coated; also with Ex d/XP, dust ignition-proof; cover without sight glass. Unit of measurement mm (in)

Ground terminal

- Ground terminal inside the housing, max. conductor cross-section 2.5 mm<sup>2</sup> (14 AWG)
- Ground terminal outside on the housing, max. conductor cross-section 4 mm<sup>2</sup> (12 AWG)

Cable glands

Cable diameter:

- Plastic: Ø5 to 10 mm (0.2 to 0.38 in)
- Nickel-plated brass: Ø7 to 10.5 mm (0.28 to 0.41 in)
- Stainless steel: Ø7 to 12 mm (0.28 to 0.47 in)
- Stainless steel, hygienic: Ø7 to 10 mm (0.28 to 0.39 in)



The scope of delivery comprises:

- 1 cable gland installed
- 1 cable gland sealed with dummy plug

Exceptions: For Ex d/XP, only threaded insertions are permitted.

Temperature spacer, pressure-tight feedthrough (optional)

The temperature spacer provides sealed insulation for the vessel.

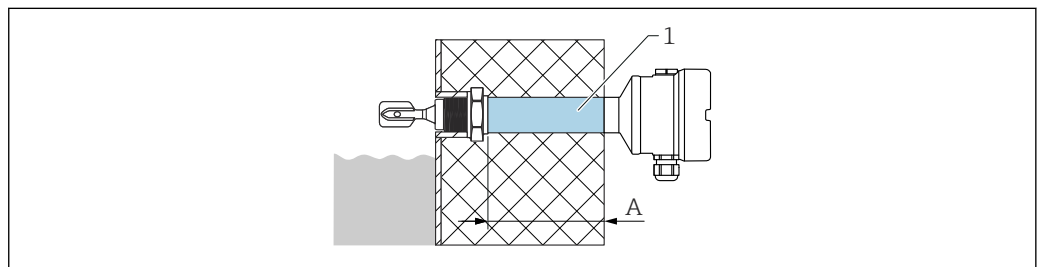

1 Temperature spacer and/or pressure-tight feedthrough with maximum insulation length  
A 140 mm (5.51 in)

Product Configurator, feature "Sensor design":

- Temperature spacer
- Pressure-tight feedthrough (second line of defense)  
If the sensor is damaged, this protects the housing from vessel pressures up to 100 bar (1 450 psi).



The "Pressure-tight feedthrough" version can only be selected in conjunction with the "Temperature spacer" option.

Probe design

**Compact version**

Sensor length L: depends on process connection

For more details, see the "Process connections" section.

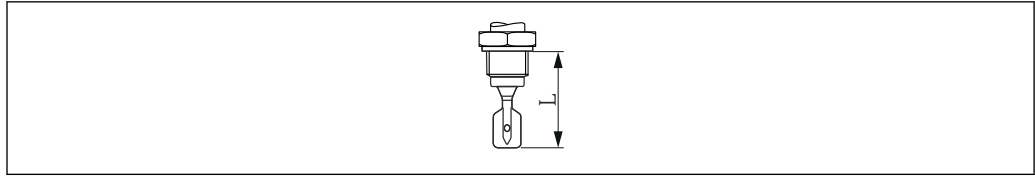

A0042435

19 Probe design: Compact version, sensor length  $L$

### Short pipe version

Sensor length  $L$ : Depends on process connection

- Thread G 1 approx. 118 mm (4.65 in)
- Ingold, flush-mounted tank connection, DIN 11851/DIN 11864-1/SMS 1145 pipe connection, DRD, Varivent, clamp/Tri-Clamp approx. 115 mm (4.53 in)
- Flush-mounted 1" (G 1 welding boss from Endress+Hauser) approx. 104 mm (4.09 in)

### Pipe extension

- Sensor lengths  $L$ : 148 to 3 000 mm (5.83 to 118.11 in)
- Length tolerances  $L$ : < 1 m (3.3 ft) = -5 mm (-0.2 in), 1 to 3 m (3.3 to 9.8 ft) = -10 mm (-0.39 in)

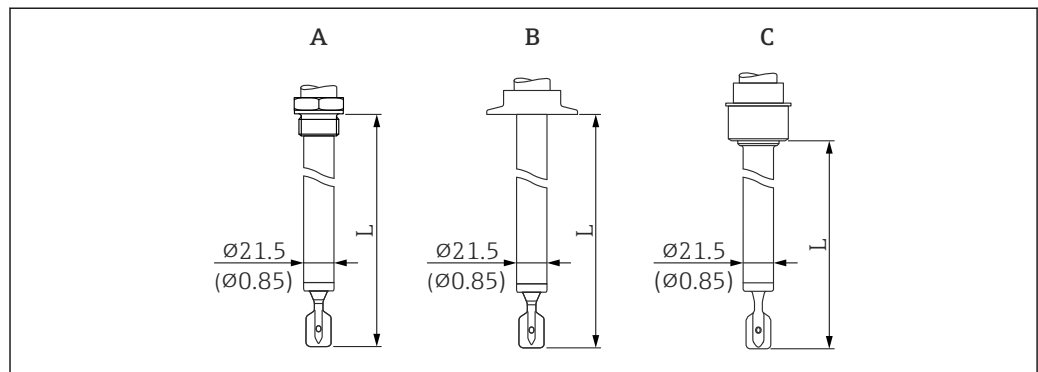

A0051989

20 Probe designs: Pipe extension, short pipe version (sensor length  $L$ ). Unit of measurement mm (in)

A Thread G 1

B For example, clamp/Tri-Clamp, Varivent

C Flush-mounted tank connection for installation in weld-in adapter

### Tuning fork

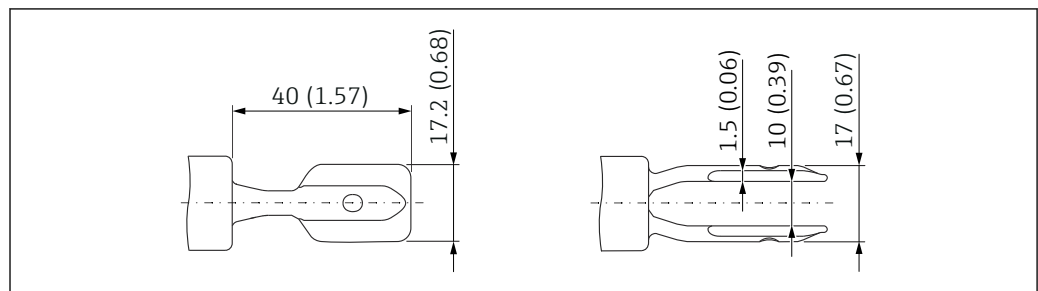

A0038269

21 Tuning fork. Unit of measurement mm (in)

### Process connections

- i** Observe the permitted process temperature of 0 to 80 °C (32 to 176 °F). Higher temperatures affect the measurement accuracy.

### Process connection, sealing surface

- Thread ISO228, G
- Ingold
- Flush-mounted tank connection

- DIN11851 pipe union
- DIN11864-1 pipe union
- DRD
- SMS1145 pipe union
- Varivent (Varinline)
- Clamp/Tri-Clamp

*Height of process connection*

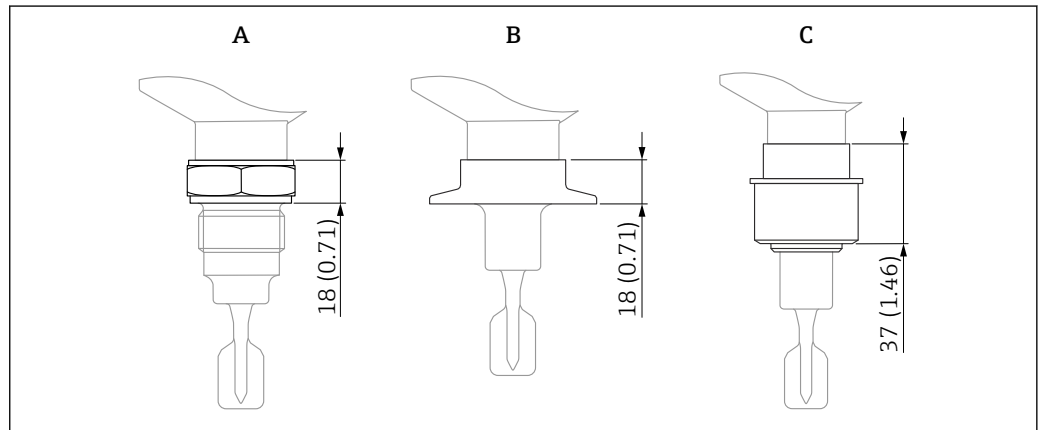

22 Maximum height specification for the process connections. Unit of measurement mm (in)

- A Process connection with threaded connection
- B For example: Clamp/Tri-Clamp, Varivent
- C Flush-mounted tank connection for installation in welding neck

*Thread ISO228 G 3/4 for installation in weld-in adapter*

G 3/4 with defined thread start for flush mounting in weld-in adapter

- Only for sensor design: compact version
- Pressure rating, temperature: ≤ 40 bar (580 psi), ≤ +100 °C (+212 °F)
- Pressure rating, temperature: ≤ 25 bar (363 psi), ≤ +150 °C (+302 °F)
- Weight: 0.2 kg (0.44 lb)
- Accessories: weld-in adapter, optionally available as "Accessory enclosed"

**i** A seal is not included in the delivery. The maximum temperature and maximum pressure depend on the clamping ring and sealing element used (according to the process connection design). The lowest value applies in each case.

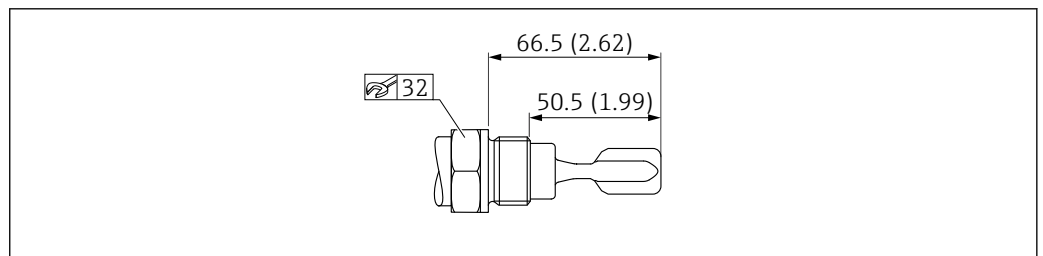

23 Thread ISO228 G 3/4. Unit of measurement mm (in)

*Thread ISO228 G 1 for installation in weld-in adapter*

G 1 with defined thread start, comprising sealing surface for flush mounting in weld-in adapter

- Pressure rating, temperature: ≤ 40 bar (580 psi), ≤ +100 °C (+212 °F)
- Pressure rating, temperature: ≤ 25 bar (363 psi), ≤ +150 °C (+302 °F)
- Weight: 0.33 kg (0.73 lb)
- Accessories: weld-in adapter, optionally available as "Accessory enclosed"

**i** A seal is not included in the delivery. The maximum temperature and maximum pressure depend on the clamping ring and sealing element used (according to the process connection design). The lowest value applies in each case.

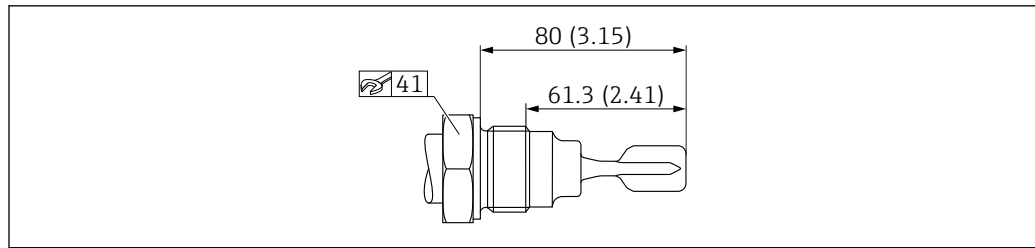

A0035551

24 Thread ISO228 G 1. Unit of measurement mm (in)

#### Ingold fitting

Ingold fitting 25 x 46 mm (2.52 in)

- Pressure rating:  $\leq 16$  bar (232 psi)
- Temperature:  $\leq 150$  °C (302 °F)
- Weight: 0.2 kg (0.44 lb)
- Scope of delivery: cap-nut G 1¼, seal

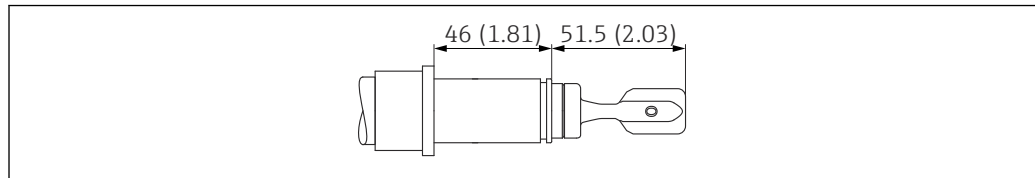

A0051991

25 Ingold fitting 25 x 46 mm (2.52 in). Unit of measurement mm (in)

#### Flush-mounted tank connection for installation in weld-in adapter

- Pressure rating, temperature:  $\leq 40$  bar (580 psi),  $\leq +100$  °C (+212 °F)
- Pressure rating, temperature:  $\leq 25$  bar (363 psi),  $\leq 140$  °C (284 °F)
- Weight: 0.44 kg (0.97 lb)
- Accessories: weld-in adapter, optionally available as "Accessory enclosed"
- Scope of delivery: cap-nut, seal

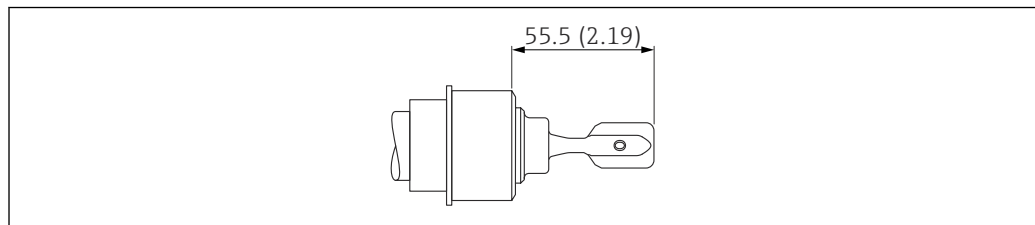

A0051993

26 Flush-mounted tank connection. Unit of measurement mm (in)

#### DIN 11851 pipe connection

DN32 PN25

- Slotted nut
- Pressure rating:  $\leq 40$  bar (580 psi)/ $\leq 25$  bar (363 psi)
- Temperature:  $\leq 100$  °C (212 °F)/  $\leq 140$  °C (284 °F)
- Weight: 0.3 kg (0.66 lb)

DN40 PN25

- Slotted nut
- Pressure rating:  $\leq 40$  bar (580 psi)/ $\leq 25$  bar (363 psi)
- Temperature:  $\leq 100$  °C (212 °F)/ $\leq 140$  °C (284 °F)
- Weight: 0.35 kg (0.77 lb)

DN50 PN25

- Slotted nut
- Pressure rating: ≤ 25 bar (363 psi)
- Temperature: ≤ 140 °C (284 °F)
- Weight: 0.47 kg (1.04 lb)

**i** A seal is not included in the delivery. The maximum temperature and maximum pressure depend on the clamping ring and sealing element used (according to the process connection design). The lowest value applies in each case.

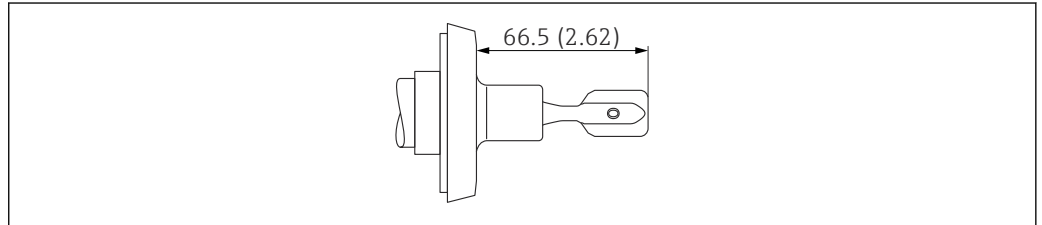

A0051995

27 DIN 11851 pipe connection. Unit of measurement mm (in)

DIN 11864-1 pipe connection

DIN 11864-1 A DN50 pipe DIN 11850

- Slotted nut
- Pressure rating: ≤ 25 bar (363 psi)
- Temperature: ≤ 140 °C (284 °F)
- Weight: 0.47 kg (1.04 lb)

**i** A seal is not included in the delivery. The maximum temperature and maximum pressure depend on the clamping ring and sealing element used (according to the process connection design). The lowest value applies in each case.

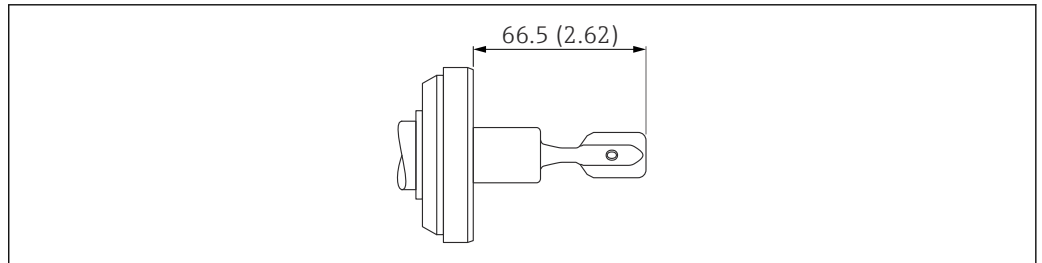

A0052381

28 DIN 11864-1 pipe connection. Unit of measurement mm (in)

DRD

DRD 65 mm (2.56 in)

- Pressure rating, temperature: ≤ 40 bar (580 psi), ≤ +100 °C (+212 °F)
- Pressure rating, temperature: ≤ 25 bar (363 psi), ≤ 140 °C (284 °F)
- Weight: 0.43 kg (0.95 lb)
- Accessories: Weld-in flange with PTFE flat seal, optionally available to order as "Accessories"

**i** A seal is not included in the delivery. The maximum temperature and maximum pressure depend on the clamping ring and sealing element used (according to the process connection design). The lowest value applies in each case.

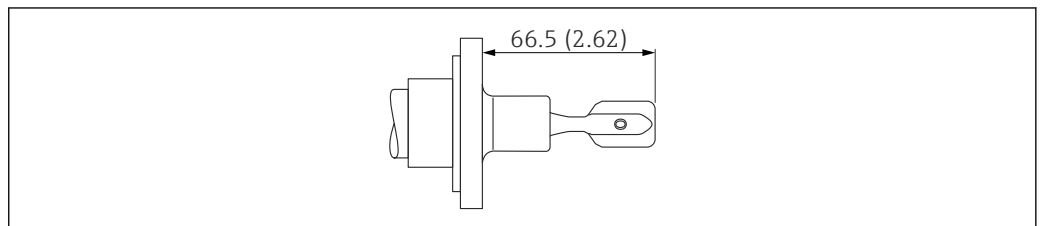

A0051992

29 DRD. Unit of measurement mm (in)

*SMS 1145 pipe connection***SMS 2" PN25**

- Pressure rating: ≤ 25 bar (363 psi)
- Temperature: ≤ 140 °C (284 °F)
- With cap nut
- Weight: 0.33 kg (0.72 lb)

**i** A seal is not included in the delivery. The maximum temperature and maximum pressure depend on the clamping ring and sealing element used (according to the process connection design). The lowest value applies in each case.

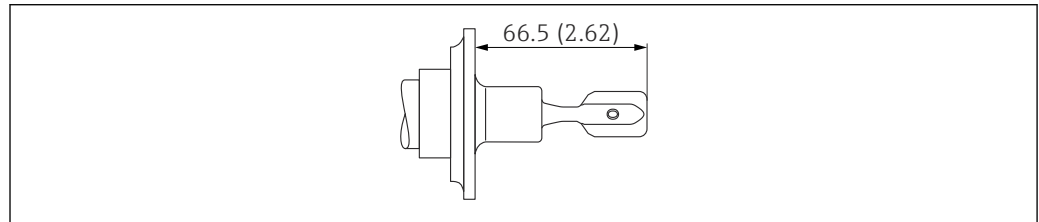

A0051994

**30** SMS 1145 pipe connection. Unit of measurement mm (in)

*Varivent (Varinline)***Varivent N pipe DN65-162 PN25**

- Pressure rating: ≤ 25 bar (363 psi)
- Temperature: ≤ 150 °C (302 °F)
- Suitable for GEA Tuchenhagen
- Weight: 0.72 kg (1.59 lb)

**i** A seal is not included in the delivery. The maximum temperature and maximum pressure depend on the clamping ring and sealing element used (according to the process connection design). The lowest value applies in each case.

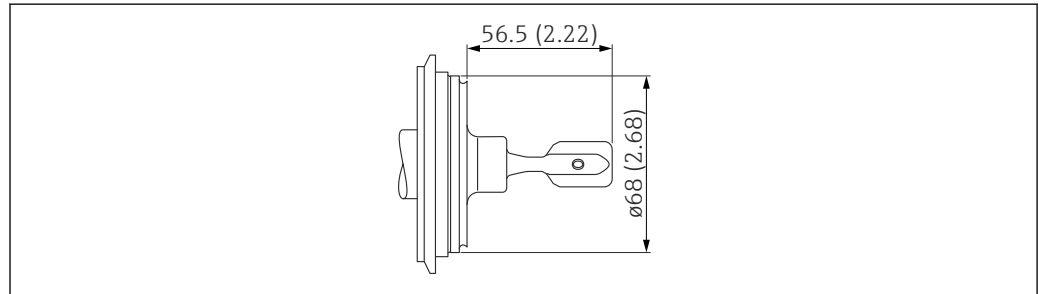

A0051996

**31** Varivent N pipe DN65-162 PN25. Unit of measurement mm (in)

*Tri-Clamp***ISO2852 DN25-38 (1 to 1 ½"), DIN32676 DN25-40**

- Pressure rating: ≤ 25 bar (363 psi)
- Temperature: ≤ 150 °C (302 °F)
- Weight: 0.3 kg (0.66 lb)

**ISO2852 DN40-51 (2"), DIN32676 DN50**

- Pressure rating: ≤ 25 bar (363 psi)
- Temperature: ≤ 150 °C (302 °F)
- Weight: 0.3 kg (0.66 lb)

**i** The Tri-Clamp connection is NA Connect-compatible.

**i** A seal is not included in the delivery. The maximum temperature and maximum pressure depend on the clamping ring and sealing element used (according to the process connection design). The lowest value applies in each case.

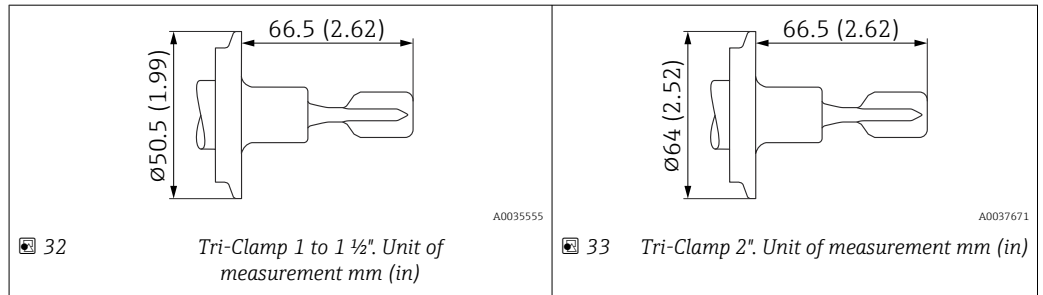

## Weight

### Basic weight: 0.65 kg (1.43 lb)

The basic weight comprises:

- Probe design: compact version
- Electronic insert
- Housing: single compartment, plastic with cover
- Thread, G 3/4



Differences in weight are caused by the housing and cover selected.

### Housing

- Single compartment, aluminum, coated: 0.8 kg (1.76 lb)
- Single compartment; 316L, hygienic: 0.45 kg (0.99 lb)
- Dual compartment, L-shaped; aluminum, coated: 1.22 kg (2.69 lb)

### Temperature spacer

0.6 kg (1.32 lb)

### Pressure-tight feedthrough

0.7 kg (1.54 lb)

### Pipe extension

- 1000 mm: 0.9 kg (1.98 lb)
- 50 in: 1.15 kg (2.54 lb)

### Process connection

See "Process connections" section

### Protective cover, plastic

0.2 kg (0.44 lb)

### Protective cover, 316L

0.93 kg (2.05 lb)

## Materials

*Materials in contact with process*

*Process connection and pipe extension*

316L (1.4404 or 1.4435)

*Tuning fork*

316L (1.4435)

*Seals*



Scope of delivery including seal

- Ingold fitting, seal material: EPDM (in compliance with FDA, USP Class VI)
- Flush-mounted tank connection for installation in welding neck, seal material: silicone

*Materials not in contact with process*

*Single compartment housing, plastic*

- Housing: PBT/PC
- Dummy cover: PBT/PC
- Transparent cover: PA12
- Cover with sight glass: PBT/PC and PC
- Cover seal: EPDM
- Potential equalization: 316L
- Seal under potential equalization: EPDM
- Plug: PBT-GF30-FR
- M20 cable gland: PA
- Seal on plug and cable gland: EPDM
- Threaded adapter as replacement for cable glands: PA66-GF30
- Nameplate: plastic foil
- TAG plate: plastic foil, metal or provided by the customer

*Aluminum housing, coated*

- Housing: aluminum EN AC 43400
- Dummy cover: aluminum EN AC 43400
- Cover seal materials: HNBR
- Cover seal materials: FVMQ
- Plug: aluminum  
Plastic (PBT-GF30-FR) in Ex-free, Ex i or IS combination with cable gland, plastic, M20 thread or G ½ thread
- Nameplate: plastic foil
- TAG plate: plastic foil, stainless steel or provided by the customer
- M20 cable glands: select material (stainless steel, nickel-plated brass, polyamide)

*Stainless steel housing, 316L, hygienic*

- Housing: stainless steel AISI 316L (1.4404)
- Dummy cover: stainless steel AISI 316L (1.4404)
- Cover with polycarbonate sight glass optionally available. For dust ignition-proof applications, the sight glass is made of borosilicate.
- Cover seal materials: VMQ
- Plug: stainless steel or plastic
  - Plastic (PBT-GF30-FR) in Ex-free, Ex i or IS combination with cable gland, plastic, M20 thread or G ½ thread
  - Stainless steel for cable glands made of stainless steel or nickel or for Ex t, Ex ia IIIC
- Nameplate: stainless steel housing labeled directly
- TAG plate: plastic foil, stainless steel or provided by the customer
- M20 cable glands: select material (stainless steel, nickel-plated brass, polyamide)

**Surface roughness**

Surface roughness of the surface in contact with the process:

Ra < 1.5 µm (59 µin)

Optional:

Ra < 0.3 µm (12 µin) mechanically polished (3-A, EHEDG)

**Mechanical construction of Density Calculator QML51****Terminal**

- Plug-in screw terminals
- Coded supply terminal (mechanical coding prevents incorrect insertion of the terminal)
- Clamping range: 0.5 to 2.5 mm<sup>2</sup> (20 to 13 AWG)



Use flexible stranded conductors only with ferrules.

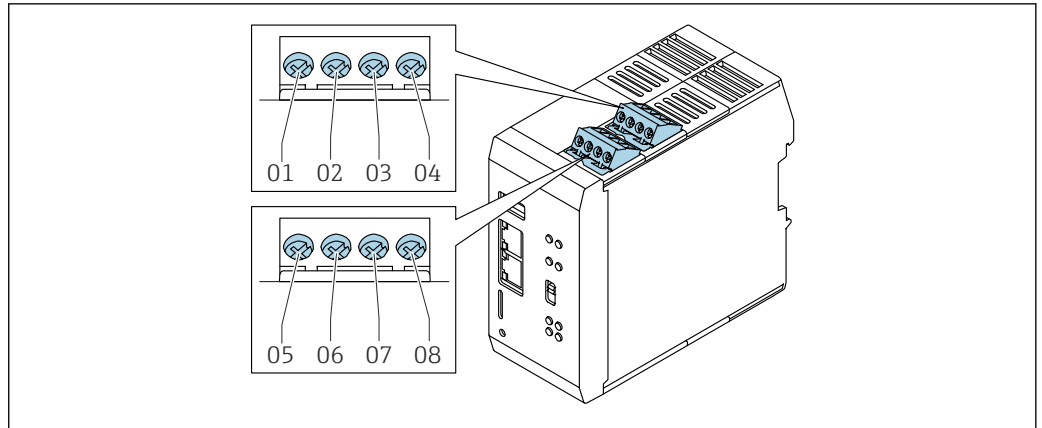

A0059905

34 Pulse and analog input

- 01 Channel 1, default setting: + PFM
- 02 Channel 1, default setting: - PFM
- 03 Channel 2, default setting: 4 to 20 mA
- 04 Channel 2, default setting: -4 to 20 mA
- 05 Channel 3, default setting: + PFM
- 06 Channel 3, default setting: - PFM
- 07 Channel 4, default setting: 4 to 20 mA
- 08 Channel 4, default setting: -4 to 20 mA

**i** The channels are preset (factory setting). The configuration can be changed subsequently.

**Design, dimensions**

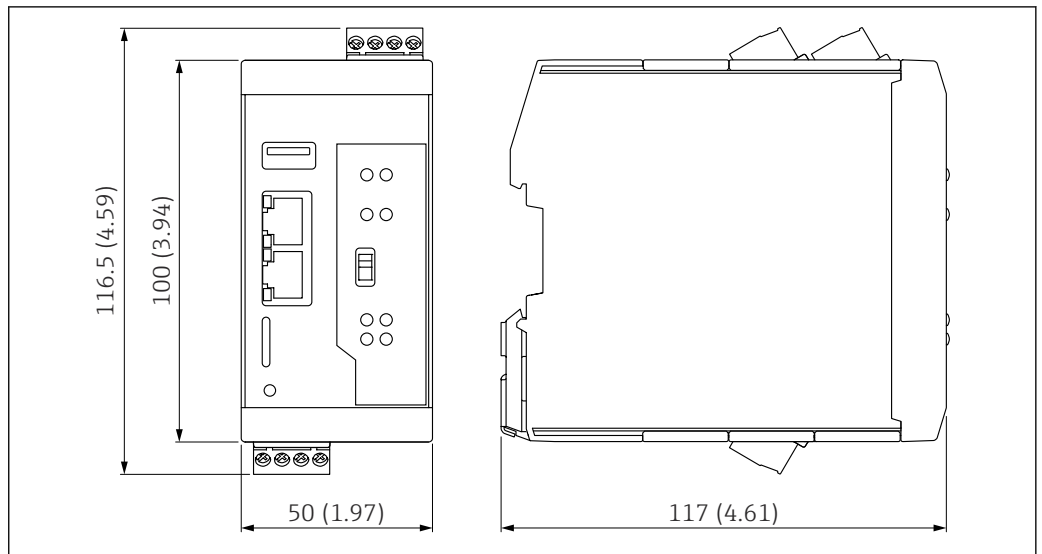

A0059927

35 Dimensions. Unit of measurement mm (in)

**Weight**

252 g (8.89 oz)

**Materials**

Housing: Polyamide

## Operability

### Local display

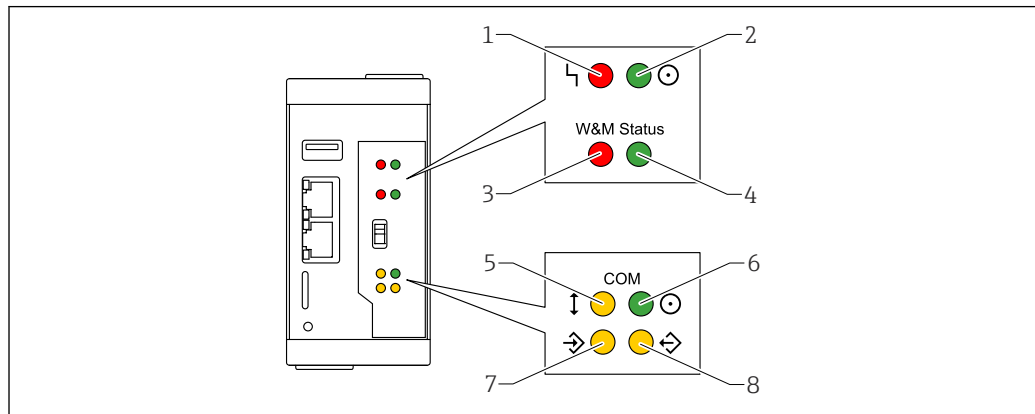

A0046044

36 Description of LED statuses

- 1 Red LED: Fault
- 2 Green LED: Power supply status
- 3 Red LED: verification switch in the locked position (no function assigned for Density Calculator QML51)
- 4 Green LED: verification switch in the unlocked position (no function assigned for Density Calculator QML51)
- 5 Yellow LED: Field communication status
- 6 Green LED: Power supply status of the communication interface
- 7 Yellow LED: Incoming data packets
- 8 Yellow LED: Outgoing data packets

### Controls

#### Reset button

The device is reset to the factory settings.

Use a pen tip to press the reset button.

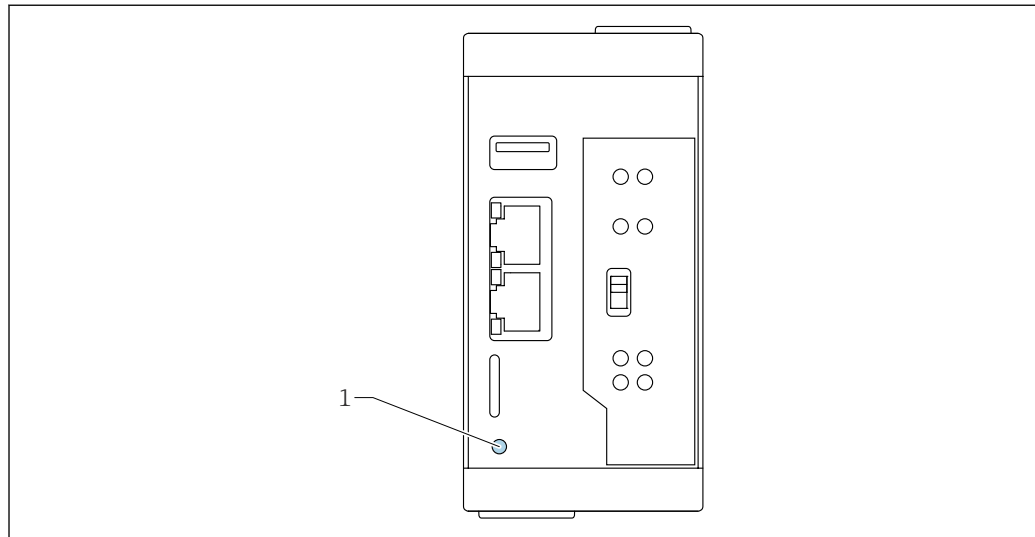

A0046191

37 Reset button position

- 1 Reset button

#### Hardware switch (no function)

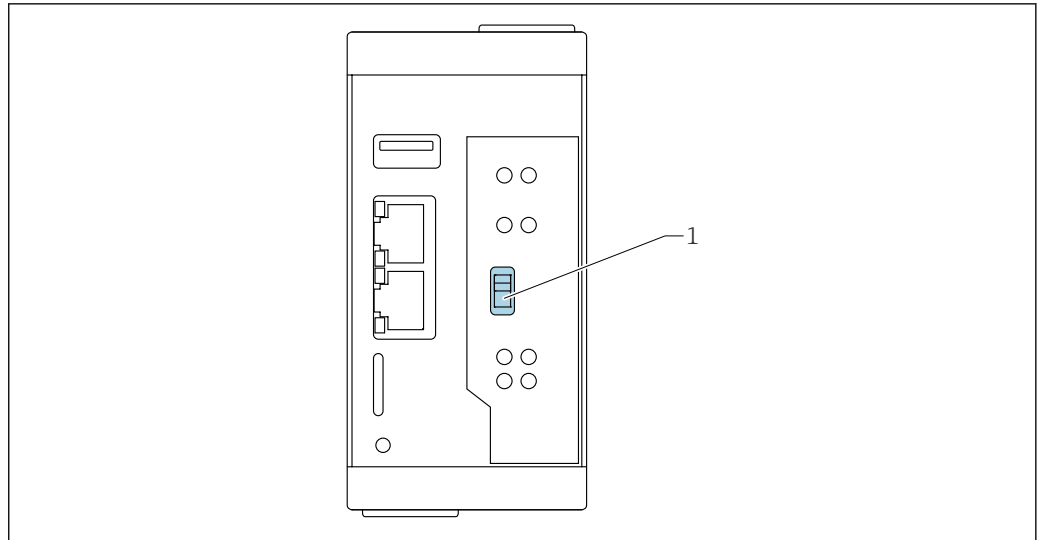

A0046237

1 Hardware switch (no function)

 This switch has no function on the Density Calculator QML51.

---

### Interfaces for data transmission

The device configuration (user data, log files, certificates, or diagnostic codes) can be saved.

Prerequisites:

- To save a backup to a USB stick or an SD card, an appropriate permitted storage medium must be available and have been detected by the device.
- If the backup is to be saved on an FTP server, an FTP server must first be set up and connection must be possible.

A backup can be protected with a password by the system. The password can be freely selected without restriction. A password-protected backup can only be imported to another system with the associated password.

### Card slot

 The microSD card is not included in the delivery.

Endress+Hauser recommends using microSD cards with the following parameters:

- Storage capacity: 8 to 64 GB
- Temperature range: -40 to 85 °C (-40 to 185 °F)

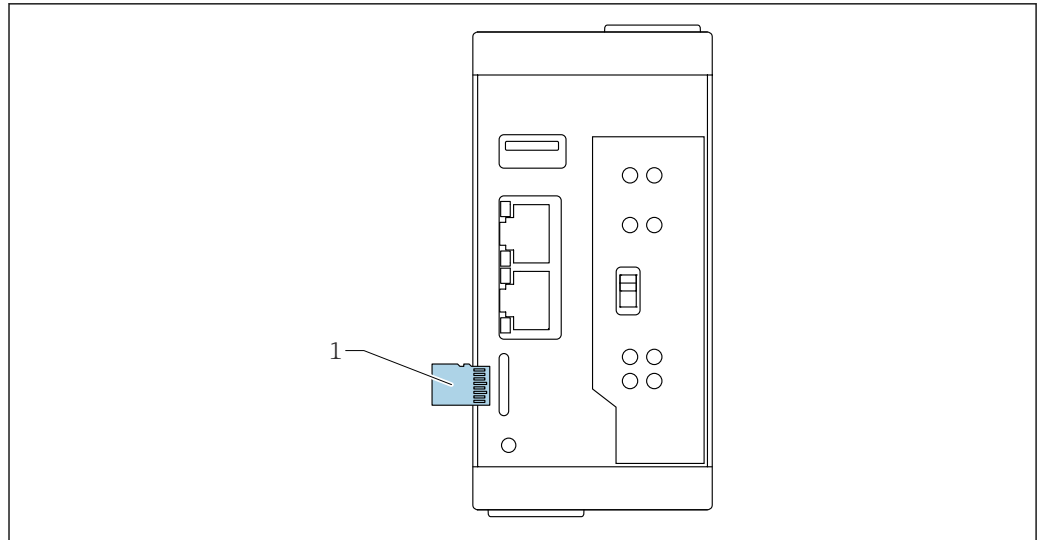

A0046045

38 Position of the card slot

1 microSD card

### USB port

USB (type A) port data:

- USB 2.0 Host
- Up to 480 Mbit/s
- 5 V<sub>DC</sub> up to 1.5 A

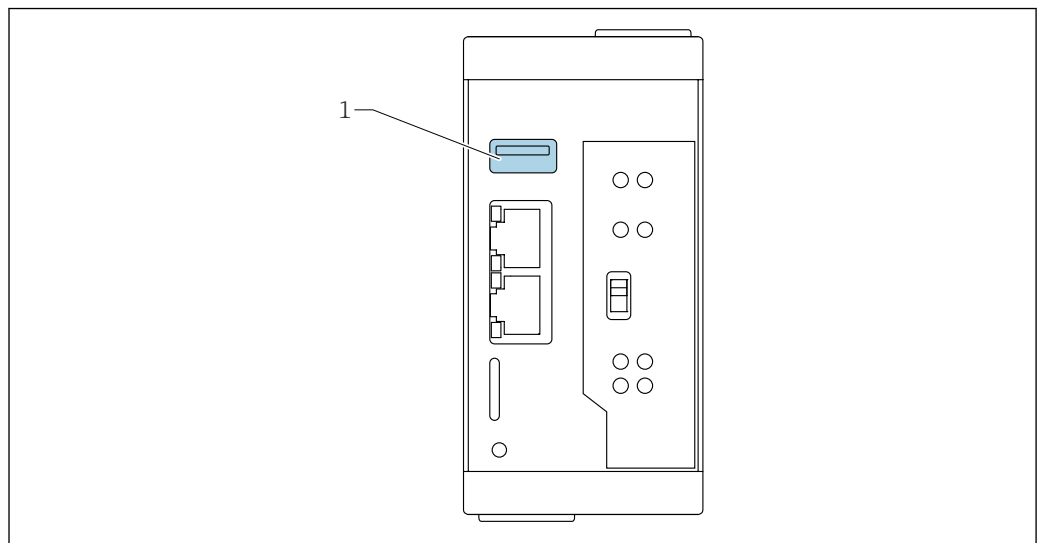

A0046046



39 USB port position

1 USB port

## Certificates and approvals

Current certificates and approvals for the product are available at [www.endress.com](http://www.endress.com) on the relevant product page:

1. Select the product using the filters and search field.
2. Open the product page.
3. Select **Downloads**.

<b>CE mark</b>	<p>The measuring system meets the legal requirements of the applicable EU Directives. These are listed in the corresponding EU Declaration of Conformity along with the standards applied.</p> <p>Endress+Hauser confirms that the device has been successfully tested by applying the CE mark.</p>
<b>Ex approval</b>	<p>For available Ex approvals, see Product Configurator.</p> <p>All explosion protection data are listed in a separate document, which is available on request.</p>
<b>Other standards and guidelines</b>	<p><b>IEC 60529</b> Degrees of protection provided by enclosures (IP code)</p> <p><b>IEC 61010</b> Safety requirements for electrical equipment for measurement, control and laboratory use</p> <p><b>EN 61326 series</b> EMC product family standard for electrical equipment for measurement, control and laboratory use</p> <p><b>NAMUR</b> User association of automation technology in process industries</p>
<b>Additional information on Liquiphant Density</b>	<p><b>Material compliance for contact with food</b></p> <p>The device has been developed for food contact applications. Versions can be selected that meet the following requirements:</p> <ul style="list-style-type: none"> <li>■ EU Food Contact Material (EC) 1935/2004</li> <li>■ US Food Contact Material FDA CFR 21</li> <li>■ CN Food Contact Material GB 4806</li> </ul> <p><b>Hygienic design compliance</b></p> <p>3-A and EHEDG-certified versions of the sensor are suitable for Cleaning-in-Place (CIP) and Sterilization-in-Place (SIP) without removing them from the plant. This means that the sensor does not need to be removed during cleaning. The maximum permitted pressure and temperature values for sensor and adapter must not be exceeded (see notes in this TI).</p> <ul style="list-style-type: none"> <li>■ Notes on installation and certification in accordance with 3-A and EHEDG: <ul style="list-style-type: none"> <li>■  SD02503F document "Hygienic approvals"</li> </ul> </li> <li>■ Information on 3-A and EHEDG-certified adapters: <ul style="list-style-type: none"> <li>■  TI00426F document "Weld-in adapters, process adapters and flanges"</li> </ul> </li> </ul> <p><b>cGMP</b></p> <p>The device was developed for life sciences applications. You can select versions with a cGMP declaration (Current Good Manufacturing Practice) for process-wetted parts with the following content in English:</p> <ul style="list-style-type: none"> <li>■ Materials of construction</li> <li>■ Polishing and surface treatment</li> <li>■ Materials and compounds compliance table: USP, FDA</li> <li>■ TSE/BSE-compliant based on EMA/410/01 Rev.3</li> </ul> <p><b>General material compliance</b></p> <p>Endress+Hauser guarantees compliance with all relevant laws and regulations, including the current guidelines for materials and substances.</p> <p>Examples:</p> <ul style="list-style-type: none"> <li>■ RoHS</li> <li>■ China RoHS</li> <li>■ REACH</li> <li>■ POP VO (Stockholm Convention)</li> </ul> <p>For further information and general declarations of compliance, see the Endress+Hauser website <a href="http://www.endress.com">www.endress.com</a></p> <p><b>TSE (BSE) compliance (ADI free - Animal Derived Ingredients)</b></p> <p>Versions can be selected that meet the following requirements:</p> <ul style="list-style-type: none"> <li>■ The parts of this product in contact with the process are not made from materials derived from animals <b>or</b></li> <li>■ The parts of this product in contact with the process correspond to at least the requirements of the EMA/410/01 Rev. 3 guideline (TSE (BSE) compliant)</li> </ul>

## Ordering information

Detailed ordering information is available from your nearest sales organization [www.addresses.endress.com](http://www.addresses.endress.com) or in the Product Configurator at [www.endress.com](http://www.endress.com):

1. Select the product using the filters and search field.
2. Open the product page.
3. Select **Configuration**.



### Product Configurator - the tool for individual product configuration

- Up-to-the-minute configuration data
- Depending on the device: direct input of information specific to the measuring point, such as the measuring range or operating language
- Automatic verification of exclusion criteria
- Automatic creation of the order code and its breakdown in PDF or Excel output format
- Ability to order directly in the Endress+Hauser Online Shop

### Service

- Cleaned of oil+grease (wetted)
- PWIS-free (paint-wetting impairment substances)
  - The plastic protective cover and weld-in adapters are excluded from the PWIS cleaning.

### Test reports, declarations and inspection certificates

All test reports, declarations and inspection certificates are provided electronically in the *Device Viewer*:

Enter the serial number from the nameplate

(<https://www.endress.com/de/pages/supporting-tools/device-viewer>)



### Product documentation on paper

Test reports, declarations and inspection certificates in hard copy can optionally be ordered with feature 570 "Service", Version I7 "Product documentation on paper". The documents are then provided with the device upon delivery.

### Test, certificate, declaration

Versions can be selected for which the following certificates are available:

- Inspection certificate 3.1, EN10204 (material certificate, wetted parts)
- AD 2000 (wetted parts), declaration, excluding cast parts
- CoC ASME BPE, declaration
- ASME B31.3 process piping, declaration
- Compliance with requirements derived from cGMP, Declaration
- EU Food Contact Material (EC) 1935/2004
- US Food Contact Material FDA CFR 21
- CN Food Contact Material GB 4806
- Surface roughness test ISO 4287/Ra, (wetted parts), test report
- Delta-ferrite test, internal procedure (wetted parts), test report



Documentation currently available on the Endress+Hauser website: [www.endress.com](http://www.endress.com) → Downloads or with the serial number of the device under Online Tools in the Device Viewer.

### TAG

#### Measuring point (TAG)

The device can be ordered with a tag name.

#### Location of tag name

Select in the additional specification:

- Stainless steel tag plate
- Paper adhesive label
- Tag provided by the customer
- RFID tag
- RFID tag + stainless steel tag plate
- RFID tag + paper adhesive label
- RFID tag + tag provided by the customer
- IEC 61406 stainless steel tag
- IEC 61406 stainless steel tag + NFC tag
- IEC 61406 stainless steel tag, stainless steel tag
- IEC 61406 stainless steel tag + NFC, stainless steel tag
- IEC 61406 stainless steel tag, plate supplied
- IEC 61406 stainless steel tag + NFC, plate supplied

**Definition of tag name**

Specify in the additional specification:  
 3 lines of maximum 18 characters each  
 The specified tag name appears on the selected plate and/or on the RFID tag.

**Accessories**

**Accessories**



The contents of this section apply to the Liquiphant.  
 See also the Operating Instructions for the density calculator: BA02545S.

Accessories currently available for the product can be selected via the Product Configurator at [www.endress.com](http://www.endress.com):

1. Select the product using the filters and search field.
2. Open the product page.
3. Select **Accessory Enclosed**. Any other accessories that are not displayed can be ordered via the Device Viewer; see "Device Viewer" section.

**Device Viewer**

Im *Device Viewer* ([www.endress.com/deviceviewer](http://www.endress.com/deviceviewer)) werden alle Zubehörteile zum Gerät inklusive Bestellcode aufgelistet.

**Weather protection cover for dual compartment housing, aluminum**

The weather protection cover can be ordered together with the device via the "Accessory enclosed" product structure.

It is used to protect against direct sunlight, precipitation and ice.

The 316L weather protection cover is suitable for dual compartment housings made of aluminum. The delivery includes the holder for direct mounting on the housing.

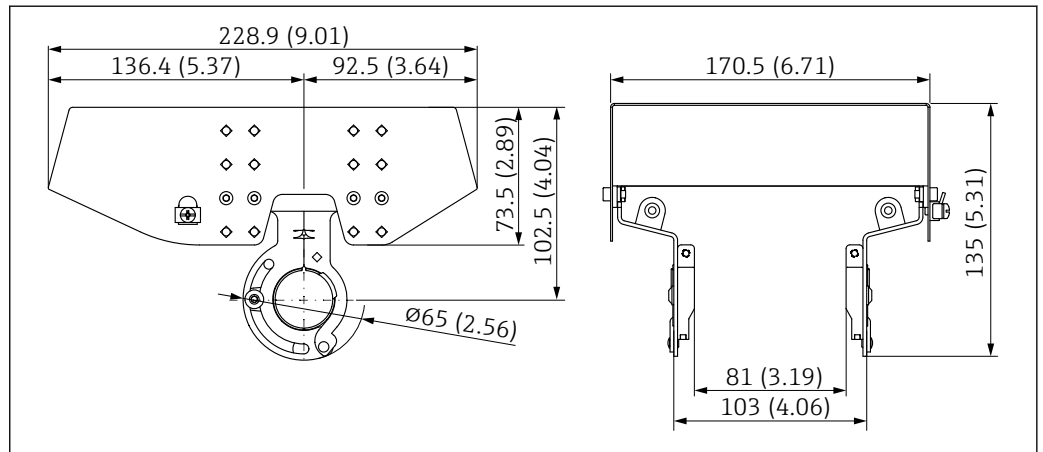

40 Dimensions of weather protection cover, 316L, XW112. Unit of measurement mm (in)

**Material**

- Weather protection cover: 316L
- Clamping screw: A4
- Bracket: 316L

**Accessory order code:**

71438303



Special Documentation SD02424F

**Weather protection cover for aluminum single compartment housing**

The weather protection cover can be ordered together with the device via the "Accessory enclosed" product structure.

It is used to protect against direct sunlight, precipitation and ice.

The plastic weather protection cover is suitable for the single compartment housing made of aluminum. The delivery includes the holder for direct mounting on the housing.

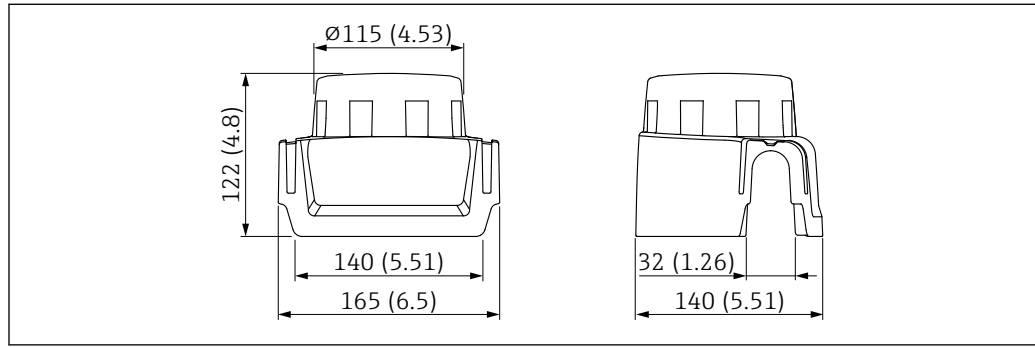

41 Weather protection cover for aluminum single compartment housing. Unit of measurement mm (in)

**Material**

Plastic

**Accessory order code:**

71438291



Special Documentation SD02423F

**M12 socket**

The M12 sockets listed are suitable for use in the temperature range  $-25$  to  $70$  °C ( $-13$  to  $158$  °F).

**M12 socket IP69**

- Terminated at one end
- Angled
- 5 m (16 ft) PVC cable (orange)
- Slotted nut 316L (1.4435)
- Body: PVC
- Order number: 52024216

**M12 socket IP67**

- Angled
- 5 m (16 ft) PVC cable (gray)
- Slotted nut Cu Sn/Ni
- Body: PUR
- Order number: 52010285

**Weld-in adapter**

Various weld-in adapters are available for installation in vessels or pipes. The adapters are optionally available with inspection certificate 3.1 EN10204.

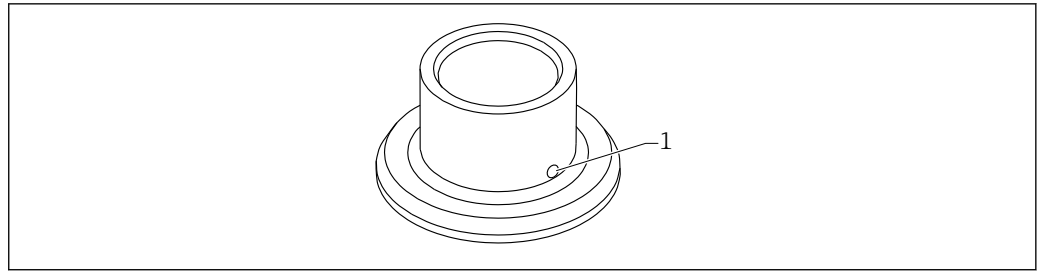

42 Weld-in adapter with leakage hole (sample view)

1 Leakage hole

Weld in the weld-in adapter in such a way that the leakage hole is pointing downwards. This enables any leaks to be detected quickly.

- G 1, Ø53 mounting on the pipe
- G 1, Ø60 flush mount on the vessel
- G ¾, Ø55 flush mount
- G 1 sensor adjustable
- RD52 sensor adjustable

 For detailed information, see "Technical Information" TI00426F (Weld-in adapters, process adapters and flanges)

Available in the Download Area of the Endress+Hauser website ([www.endress.com/downloads](http://www.endress.com/downloads)).

**Accessories for Density Computer QML51**

 See Technical Information for Density Computer QML51 (TI01866F)

## Documentation

-  For an overview of the scope of the associated Technical Documentation, refer to the following:
- *Device Viewer* ([www.endress.com/deviceviewer](http://www.endress.com/deviceviewer)): Enter the serial number from the nameplate
  - *Endress+Hauser Operations app*: Enter serial number from nameplate or scan matrix code on nameplate.

**Standard documentation**

**Document type: Operating Instructions (BA)**

Installation and initial commissioning – contains all the functions in the operating menu that are needed for a normal measuring task. Functions beyond this scope are not included.

**Document type: Brief Operating Instructions (KA)**

Quick guide to the first measured value – includes all essential information from incoming acceptance to electrical connection.

**Document type: Safety Instructions, certificates**

Depending on the approval, Safety Instructions are also supplied with the device, e.g. XA. This documentation is an integral part of the Operating Instructions.

The nameplate indicates the Safety Instructions (XA) that are relevant to the device.

**Supplementary device-dependent documentation**

**Operating instructions**

BA02545S: Density Computer QML51

**Special Documentation**

- BA02545S: Density Calculator QML51
- BA02600F: FTL63 Density with Density Calculator QML51
- SD03498S: OPC UA server
- SD03501S: Modbus TCP server
- SD01622P: Weld-in adapter (installation instructions)
- TI00426F: Weld-in adapters, process adapters and flanges (overview)

## Registered trademarks

**Modbus®**

Registered trademark of SCHNEIDER AUTOMATION, INC.

**OPC UA**

Registered trademark of the OPC Foundation, Scottsdale, Arizona, USA

**HART®**

Registered trademark of the FieldComm Group, Austin, Texas, USA

---



[www.addresses.endress.com](http://www.addresses.endress.com)

---