

Brief Operating Instructions

Flowmeter

Proline Prowirl R

Vortex flow sensor

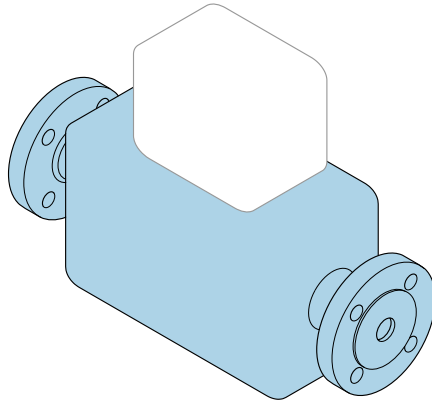

These Brief Operating Instructions are **not** a substitute for the Operating Instructions pertaining to the device.

Brief Operating Instructions Part 1 of 2: Sensor

Contain information about the sensor.

Brief Operating Instructions Part 2 of 2: Transmitter

→  3.

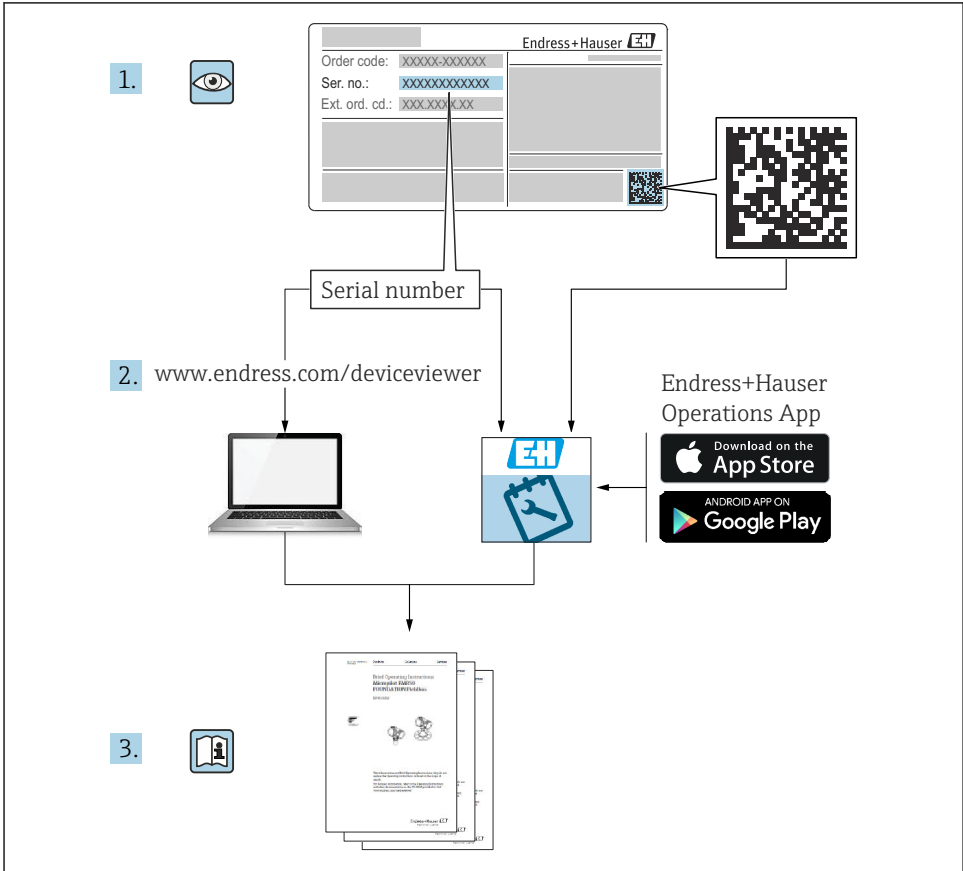

A0023555

Brief operating instructions Flowmeter

The device consists of a transmitter and a sensor.

The process of commissioning these two components is described in two separate manuals which together form the Brief Operating Instructions for the flowmeter:

- Brief Operating Instructions Part 1: Sensor
- Brief Operating Instructions Part 2: Transmitter

Please refer to both parts of the Brief Operating Instructions when commissioning the device, as the contents of the manuals complement one another:

Brief Operating Instructions Part 1: Sensor

The Sensor Brief Operating Instructions are aimed at specialists with responsibility for installing the measuring device.

- Incoming acceptance and product identification
- Storage and transport
- Mounting procedure

Brief Operating Instructions Part 2: Transmitter

The Transmitter Brief Operating Instructions are aimed at specialists with responsibility for commissioning, configuring and parameterizing the measuring device (until the first measured value).

- Product description
- Mounting procedure
- Electrical connection
- Operation options
- System integration
- Commissioning
- Diagnostic information

Additional device documentation



These Brief Operating Instructions are the **Brief Operating Instructions part 1: Sensor**.

The "Brief Operating Instructions part 2: Transmitter" are available via:

- Internet: www.endress.com/deviceviewer
- Smart phone/tablet: *Endress+Hauser Operations App*

Detailed information about the device can be found in the Operating Instructions and the other documentation:

- Internet: www.endress.com/deviceviewer
- Smart phone/tablet: *Endress+Hauser Operations App*

Table of contents

1	About this document	5
1.1	Symbols	5
2	Basic safety instructions	7
2.1	Requirements for the personnel	7
2.2	Intended use	7
2.3	Workplace safety	8
2.4	Operational safety	8
2.5	Product safety	8
2.6	IT security	8
3	Incoming acceptance and product identification	9
3.1	Incoming acceptance	9
3.2	Product identification	9
4	Storage and transport	10
4.1	Storage conditions	10
4.2	Transporting the product	10
5	Installation	11
5.1	Installation requirements	11
5.2	Installing the measuring instrument	21
5.3	Post-mounting check	24
6	Disposal	25
6.1	Removing the measuring device	25
6.2	Disposing of the measuring device	25

1 About this document

1.1 Symbols

1.1.1 Safety symbols

DANGER

This symbol alerts you to a dangerous situation. Failure to avoid this situation will result in serious or fatal injury.

WARNING

This symbol alerts you to a potentially dangerous situation. Failure to avoid this situation can result in serious or fatal injury.









CAUTION

This symbol alerts you to a potentially dangerous situation. Failure to avoid this situation can result in minor or medium injury.





NOTICE

This symbol alerts you to a potentially harmful situation. Failure to avoid this situation can result in damage to the product or something in its vicinity.

1.1.2 Symbols for certain types of information



Symbol	Meaning	Symbol	Meaning
	Permitted Procedures, processes or actions that are permitted.		Preferred Procedures, processes or actions that are preferred.
	Forbidden Procedures, processes or actions that are forbidden.		Tip Indicates additional information.
	Reference to documentation		Reference to page
	Reference to graphic	1, 2, 3...	Series of steps
	Result of a step		Visual inspection

1.1.3 Electrical symbols





Symbol	Meaning	Symbol	Meaning
	Direct current		Alternating current
	Direct current and alternating current		Ground connection A grounded terminal which, as far as the operator is concerned, is grounded via a grounding system.

Symbol	Meaning
	<p>Potential equalization connection (PE: Protective earth) Ground terminals that must be connected to ground prior to establishing any other connections.</p> <p>The ground terminals are located on the interior and exterior of the device:</p> <ul style="list-style-type: none"> ■ Interior ground terminal: potential equalization connection is connected to the supply network. ■ Exterior ground terminal: device is connected to the plant grounding system.





1.1.4 Communication-specific symbols

Symbol	Meaning	Symbol	Meaning
	<p>LED LED is on.</p>		<p>LED LED is off.</p>
	<p>LED LED flashing.</p>		

1.1.5 Tool symbols

Symbol	Meaning	Symbol	Meaning
	Torx screwdriver		Flat-blade screwdriver
	Phillips screwdriver		Allen key
	Open-end wrench		

1.1.6 Symbols in graphics

Symbol	Meaning	Symbol	Meaning
1, 2, 3,...	Item numbers		Series of steps
A, B, C, ...	Views	A-A, B-B, C-C, ...	Sections
	Hazardous area		Safe area (non-hazardous area)
	Flow direction		

2 Basic safety instructions

2.1 Requirements for the personnel

The personnel must fulfill the following requirements for its tasks:

- ▶ Trained, qualified specialists must have a relevant qualification for this specific function and task.
- ▶ Are authorized by the plant owner/operator.
- ▶ Are familiar with federal/national regulations.
- ▶ Before starting work, read and understand the instructions in the manual and supplementary documentation as well as the certificates (depending on the application).
- ▶ Follow instructions and comply with basic conditions.

2.2 Intended use

Application and media

Depending on the version ordered, the measuring instrument can also be used to measure potentially explosive¹⁾, flammable, toxic and oxidizing media.

Measuring instruments for use in hazardous areas, in hygienic applications, or where there is an increased risk due to pressure, are specially labeled on the nameplate.

To ensure that the measuring instrument is in perfect condition during operation:

- ▶ Only use the measuring instrument in full compliance with the data on the nameplate and the general conditions listed in the Operating Instructions and supplementary documentation.
- ▶ Using the nameplate, check whether the ordered device is permitted for the intended use in the hazardous area (e.g. explosion protection, pressure vessel safety).
- ▶ Use the measuring instrument only for media to which the process-wetted materials are sufficiently resistant.
- ▶ Keep within the specified pressure and temperature range.
- ▶ Keep within the specified ambient temperature range.
- ▶ Protect the measuring instrument permanently against corrosion from environmental influences.

Incorrect use

Non-designated use can compromise safety. The manufacturer is not liable for damage caused by improper or non-designated use.

WARNING

Danger of breakage due to corrosive or abrasive fluids and ambient conditions!

- ▶ Verify the compatibility of the process fluid with the sensor material.
- ▶ Ensure the resistance of all fluid-wetted materials in the process.
- ▶ Keep within the specified pressure and temperature range.

1) Not applicable for IO-Link measuring instruments

NOTICE**Verification for borderline cases:**

- ▶ For special fluids and fluids for cleaning, Endress+Hauser is glad to provide assistance in verifying the corrosion resistance of fluid-wetted materials, but does not accept any warranty or liability as minute changes in the temperature, concentration or level of contamination in the process can alter the corrosion resistance properties.

Residual risks**⚠ CAUTION****Risk of hot or cold burns! The use of media and electronics with high or low temperatures can produce hot or cold surfaces on the device.**

- ▶ Mount suitable touch protection.

2.3 Workplace safety

When working on and with the device:

- ▶ Wear the required personal protective equipment as per national regulations.

2.4 Operational safety

Risk of injury!

- ▶ Operate the device in proper technical condition and fail-safe condition only.
- ▶ The operator is responsible for interference-free operation of the device.

2.5 Product safety

This measuring device is designed in accordance with good engineering practice to meet state-of-the-art safety requirements, has been tested, and left the factory in a condition in which it is safe to operate.

It meets general safety standards and legal requirements. It also complies with the EU directives listed in the device-specific EU Declaration of Conformity. The manufacturer confirms this by affixing the CE mark to the device..

2.6 IT security

The manufacturer warranty is valid only if the product is installed and used as described in the Operating Instructions. The product is equipped with security mechanisms to protect it against any inadvertent changes to the settings.

IT security measures, which provide additional protection for the product and associated data transfer, must be implemented by the operators themselves in line with their security standards.

3 Incoming acceptance and product identification

3.1 Incoming acceptance

On receipt of the delivery:

1. Check the packaging for damage.
 - ↳ Report all damage immediately to the manufacturer.
Do not install damaged components.
2. Check the scope of delivery using the delivery note.
3. Compare the data on the nameplate with the order specifications on the delivery note.
4. Check the technical documentation and all other necessary documents, e.g. certificates, to ensure they are complete.



If one of the conditions is not satisfied, contact the manufacturer.

3.2 Product identification

The device can be identified in the following ways:

- Nameplate
- Order code with details of the device features on the delivery note
- Enter the serial numbers from the nameplates in the *Device Viewer* (www.endress.com/deviceviewer): all the information about the device is displayed.
- Enter the serial numbers from the nameplates into the *Endress+Hauser Operations app* or scan the DataMatrix code on the nameplate with the *Endress+Hauser Operations app*: all the information about the device is displayed.

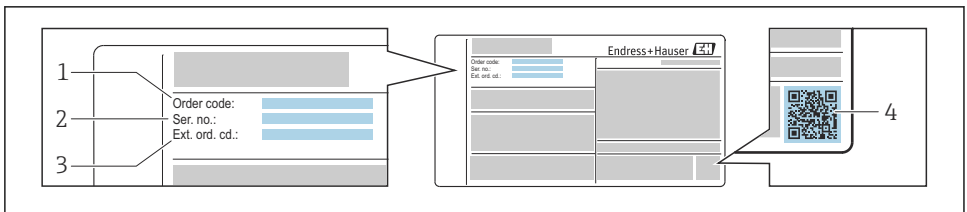

A0030196

1 Example of a nameplate

- 1 Order code
- 2 Serial number
- 3 Extended order code
- 4 2-D matrix code (QR code)



For detailed information on the data on the nameplate, see the Operating Instructions for the device.

4 Storage and transport

4.1 Storage conditions

Observe the following notes for storage:

- ▶ Store in the original packaging to ensure protection from shock.
- ▶ Protect from direct sunlight. Avoid unacceptably high surface temperatures.
- ▶ Store in a dry and dust-free place.
- ▶ Do not store outdoors.

4.2 Transporting the product

Transport the measuring device to the measuring point in the original packaging.

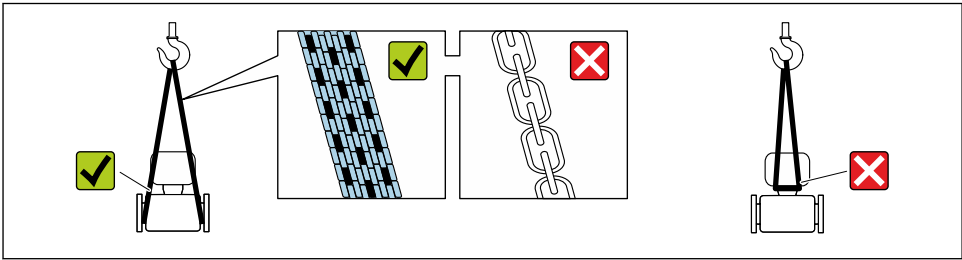

A0029252

i Do not remove protective covers or caps installed on process connections. They prevent mechanical damage to the sealing surfaces and contamination in the measuring tube.

4.2.1 Measuring devices without lifting lugs

⚠ WARNING

Center of gravity of the measuring device is higher than the suspension points of the webbing slings.

Risk of injury if the measuring device slips.

- ▶ Secure the measuring device against slipping or turning.
- ▶ Observe the weight specified on the packaging (stick-on label).

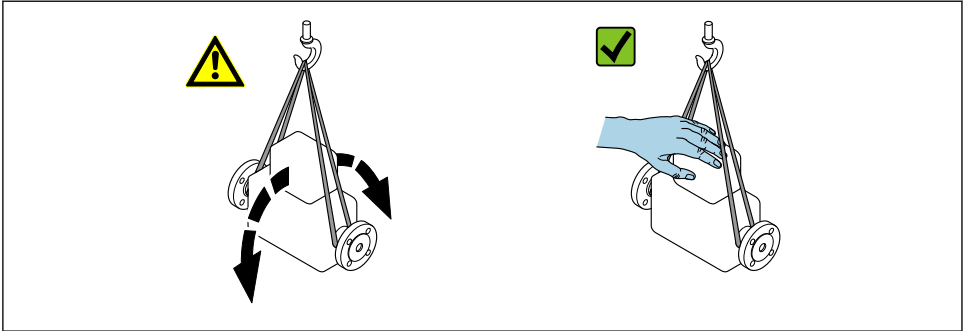

A0029214

4.2.2 Measuring devices with lifting lugs

⚠ CAUTION

Special transportation instructions for devices with lifting lugs

- ▶ Only use the lifting lugs fitted on the device or flanges to transport the device.
- ▶ The device must always be secured at two lifting lugs at least.

5 Installation

5.1 Installation requirements

5.1.1 Installation position

Mounting location

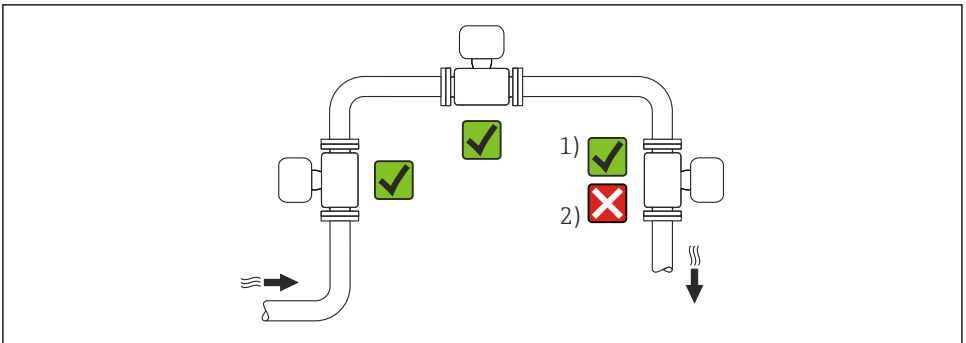

A0042128

- 1) Installation suitable for gases and steam
- 2) Installation not suitable for liquids

Orientation

The direction of the arrow on the sensor nameplate helps you to install the sensor according to the flow direction.

Vortex meters require a fully developed flow profile as a prerequisite for correct volume flow measurement. Therefore, please note the following:

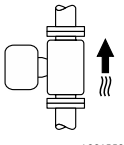
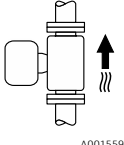
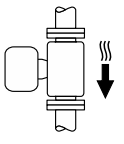
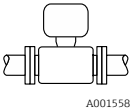
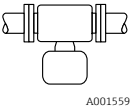
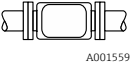
Orientation			Recommendation	
			Compact version	Remote version
A	Vertical orientation (liquids)	 A0015591	✓✓ ¹⁾	✓✓
A	Vertical orientation (dry gases)	 A0015591  A0041785	✓✓	✓✓
B	Horizontal orientation, transmitter head up	 A0015589	✓✓ ²⁾	✓✓
C	Horizontal orientation, transmitter head down	 A0015590	✓✓ ³⁾	✓✓
D	Horizontal orientation, transmitter head at side	 A0015592	✓✓	✓✓

- 1) In the case of liquids, there should be upward flow in vertical pipes to avoid partial pipe filling (Fig. A). Disruption in flow measurement!
- 2) In the case of hot media (e.g. steam or medium temperature (TM) ≥ 200 °C (392 °F)): orientation C or D
- 3) In the case of very cold media (e.g. liquid nitrogen): orientation B or D

 Order code for "Sensor version; DSC sensor; measuring tube", option DA "Mass steam" and DB "Mass gas/liquid" is available for nominal diameters from DN 25/1. Oil-free or grease-free cleaning is not possible.

Pressure measuring cell

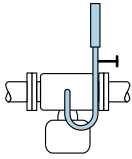
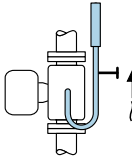
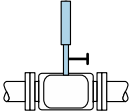
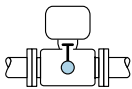
Steam pressure measurement			Option DA
E	<ul style="list-style-type: none"> With the transmitter installed at the bottom or at the side Protection against rising heat 	 <p>A0034057</p>	✓✓
F	<ul style="list-style-type: none"> Reduction in temperature to almost ambient temperature due to siphon ¹⁾ 	 <p>A0034058</p>	✓✓
Gas pressure measurement			Option DB
G	<ul style="list-style-type: none"> Pressure measuring cell with shutoff device above tapping point Discharge of any condensate into the process 	 <p>A0034092</p>	✓✓
Liquid pressure measurement			Option DB
H	<ul style="list-style-type: none"> Device with shutoff device at the same level as tapping point 	 <p>A0034091</p>	✓✓

1) Note max. permitted ambient temperature of transmitter.

Minimum spacing and cable length

Order code for "Sensor version", option "Mass" DA, DB

i Order code for "Sensor version; DSC sensor; measuring tube", option DA "Mass steam" and DB "Mass gas/liquid" is available for nominal diameters from DN 25/1. Oil-free or grease-free cleaning is not possible.

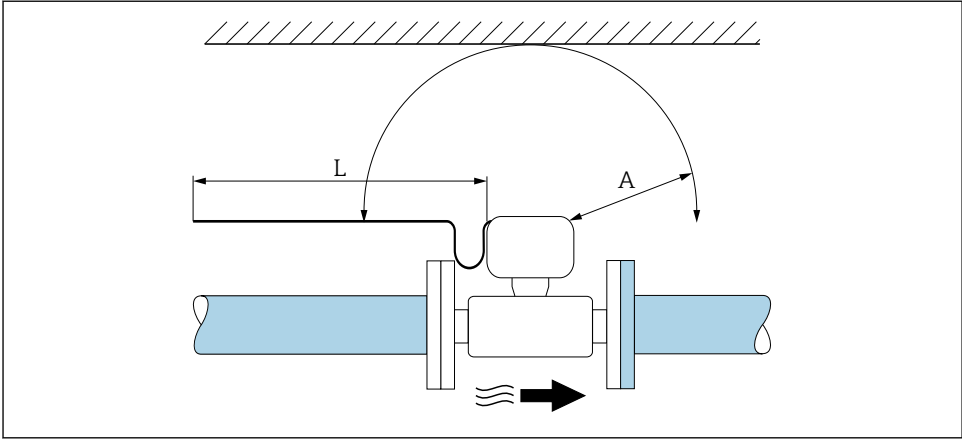

A0019211

- A* Minimum spacing in all directions
L Required cable length

The following dimensions must be observed to guarantee problem-free access to the device for service purposes:

- $A = 100 \text{ mm}$ (3.94 in)
- $L = L + 150 \text{ mm}$ (5.91 in)

Inlet and outlet runs

To achieve the specified measurement accuracy of the measuring instrument, observe at least the inlet and outlet runs listed below.

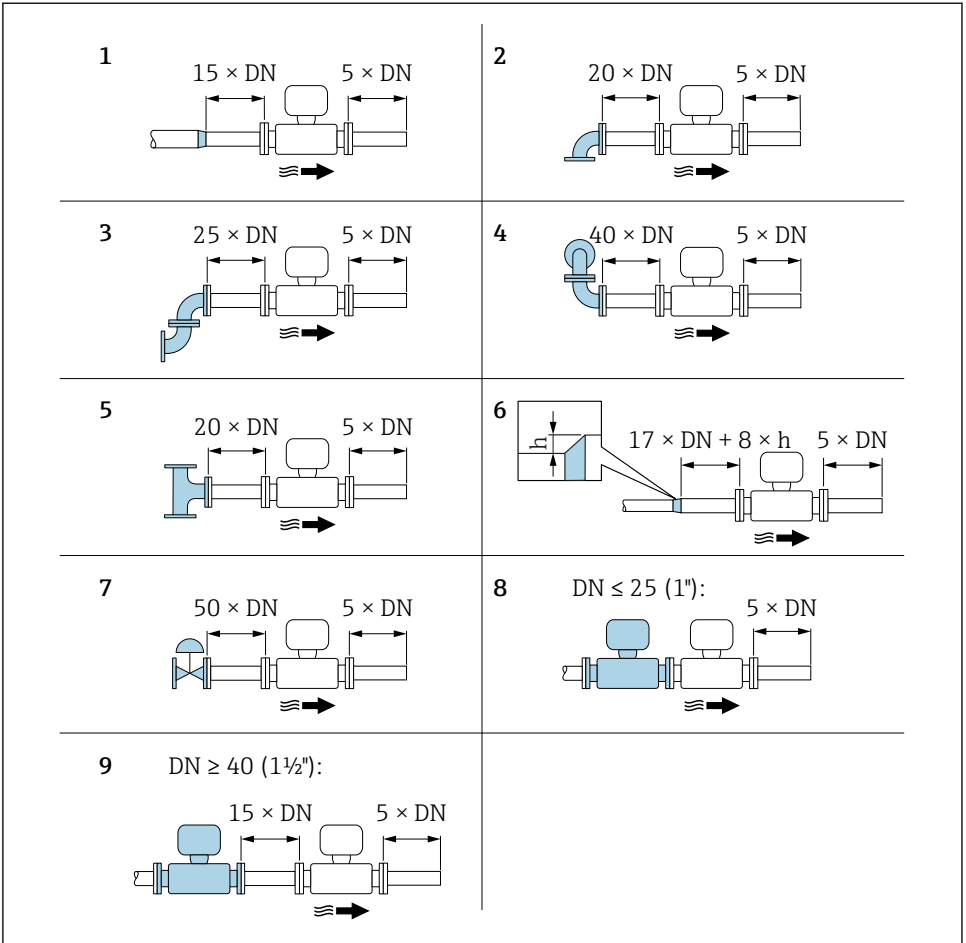



A0019189

2 Minimum inlet and outlet runs with various flow obstructions

- h* Difference in expansion
- 1 Reduction by one nominal diameter size
- 2 Single elbow (90° elbow)
- 3 Double elbow (2 × 90° elbows, opposite)
- 4 Double elbow 3D (2 × 90° elbows, opposite, not on one plane)
- 5 T-piece
- 6 Expansion

- 7 Control valve
 8 Two measuring instruments in a row where $DN \leq 25$ (1"): directly flange on flange
 9 Two measuring instruments in a row where $DN \geq 40$ (1½"): for spacing; see graphic

- i** ■ If there are several flow disturbances present, the longest specified inlet run must be maintained.
 ■ If the required inlet runs cannot be observed, it is possible to install a specially designed flow conditioner →  16.

 For detailed information about inlet run correction and wet steam detection, see the Special Documentation for the device

 For the dimensions and installed lengths of the device, see the "Technical Information" document, "Mechanical construction" section

Flow conditioner

If the inlet runs cannot be observed, the use of a flow conditioner is recommended.

The flow conditioner is fitted between two pipe flanges and centered by the mounting bolts. Generally this reduces the inlet run needed to $10 \times DN$ with full measurement accuracy.

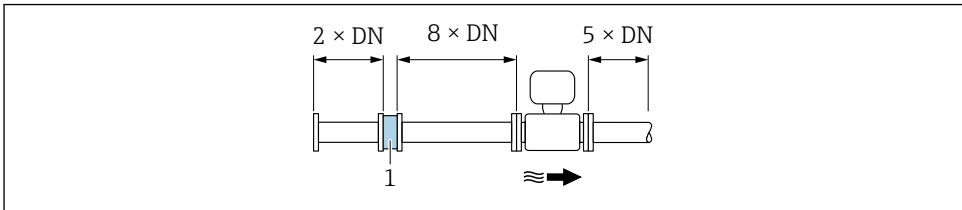

A0019208

1 Flow conditioner

The pressure loss for flow conditioners is calculated as follows:

$$\Delta p \text{ [mbar]} = 0.0085 \cdot \rho \text{ [kg/m}^3\text{]} \cdot v^2 \text{ [m/s]}$$

Example for steam

$$p = 10 \text{ bar abs.}$$

$$t = 240 \text{ }^\circ\text{C} \rightarrow \rho = 4.39 \text{ kg/m}^3$$

$$v = 40 \text{ m/s}$$

$$\Delta p = 0.0085 \cdot 4.39 \cdot 40^2 = 59.7 \text{ mbar}$$

Example for H₂O condensate (80 °C)

$$\rho = 965 \text{ kg/m}^3$$

$$v = 2.5 \text{ m/s}$$

$$\Delta p = 0.0085 \cdot 965 \cdot 2.5^2 = 51.3 \text{ mbar}$$

ρ : density of the process medium
 v : average flow velocity
 abs. = absolute

 For the dimensions of the flow conditioner, see the "Technical Information" document, "Mechanical construction" section

Outlet runs when installing external devices

If installing an external device, observe the specified distance.

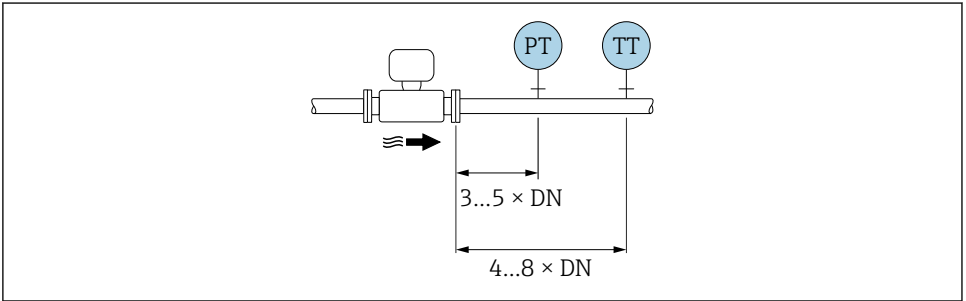

A0019205

PT Pressure
 TT Temperature device

5.1.2 Environmental and process requirements

Ambient temperature range

Compact version

Measuring instrument	Non-hazardous area:	-40 to +80 °C (-40 to +176 °F) ¹⁾ -40 to +80 °C (-40 to +176 °F)
	Ex i, Ex nA, Ex ec:	-40 to +70 °C (-40 to +158 °F) ¹⁾
	Ex d, XP:	-40 to +60 °C (-40 to +140 °F) ¹⁾
	Ex d, Ex ia:	-40 to +60 °C (-40 to +140 °F) ¹⁾
Local display		-40 to +70 °C (-40 to +158 °F) ^{2) 1)}

- 1) Additionally available as order code for "Test, certificate", option JN "Transmitter ambient temperature -50 °C (-58 °F)". This option is only available in combination with a "High-temperature sensor -200 to +400 °C (-328 to +750 °F)", see order code 060 for "Sensor version; DSC sensor; measuring tube" with options BA, BB, CA, CB.
- 2) At temperatures below -20 °C (-4 °F), depending on the physical characteristics involved, it may no longer be possible to read the liquid crystal display.

Remote version

Transmitter	Non-hazardous area:	-40 to +80 °C (-40 to +176 °F) ¹⁾ -40 to +80 °C (-40 to +176 °F)
	Ex i, Ex nA, Ex ec:	-40 to +80 °C (-40 to +176 °F) ¹⁾
	Ex d:	-40 to +60 °C (-40 to +140 °F) ¹⁾
	Ex d, Ex ia:	-40 to +60 °C (-40 to +140 °F) ¹⁾
Sensor	Non-hazardous area:	-40 to +85 °C (-40 to +185 °F) ¹⁾
	Ex i, Ex nA, Ex ec:	-40 to +85 °C (-40 to +185 °F) ¹⁾
	Ex d:	-40 to +85 °C (-40 to +185 °F) ¹⁾
	Ex d, Ex ia:	-40 to +85 °C (-40 to +185 °F) ¹⁾
Local display		-40 to +70 °C (-40 to +158 °F) ^{2) 1)}

- 1) Additionally available as order code for "Test, certificate", option JN "Transmitter ambient temperature -50 °C (-58 °F)". This option is only available in combination with a "High-temperature sensor -200 to +400 °C (-328 to +750 °F)", see order code 060 for "Sensor version; DSC sensor; measuring tube" with options BA, BB, CA, CB.
- 2) At temperatures < -20 °C (-4 °F), depending on the physical characteristics involved, it may no longer be possible to read the liquid crystal display.

► If operating outdoors:

Avoid direct sunlight, particularly in warm climatic regions.

Temperature tables

Observe the interdependencies between the permitted ambient and fluid temperatures when operating the device in hazardous areas.



For detailed information on the temperature tables, see the separate document entitled "Safety Instructions" (XA) for the device.

Thermal insulation

For optimum temperature measurement and mass calculation, it is important for some media to ensure that no heat input or loss occurs in the area of the sensor. This can be ensured by installing thermal insulation. A wide range of materials can be used for the required insulation.

This applies to:

- Compact version
- Remote sensor version

The maximum insulation height permitted is illustrated in the diagram:

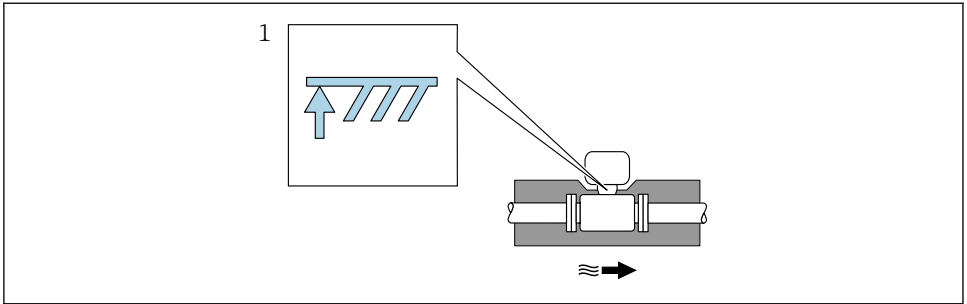

A0019212

1 Maximum insulation height

- ▶ When insulating, ensure that a sufficiently large area of the housing support remains exposed.

The uncovered part serves as a radiator and protects the electronics from overheating and excessive cooling.



The function of the siphon is to protect the pressure measuring cell from excessively high steam process temperatures through the formation of condensate in the U-tube/circular pipe. To ensure the steam condenses, the siphon may only be insulated as far as the connection flange on the measuring tube side.

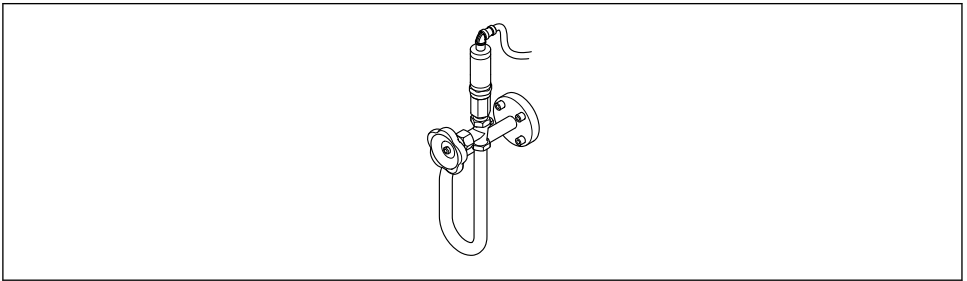

A0047532

3 Siphon

NOTICE

Electronics overheating on account of thermal insulation!

- ▶ Observe the maximum permitted insulation height of the transmitter neck so that the transmitter head and/or the connection housing of the remote version is completely free.
- ▶ Observe information on the permissible temperature ranges .
- ▶ Note that a certain orientation might be required, depending on the fluid temperature .



For detailed information about the fluid temperature, orientations and permitted temperature ranges, refer to the Operating Instructions for the device

5.1.3 Special mounting instructions

Installation for delta heat measurements

- Order code for "Sensor version", option CA "mass; 316L; 316L (integrated temperature measurement), -200 to +400 °C (-328 to +750 °F)"
- Order code for "Sensor version", option CB "mass; Alloy C22; 316L (integrated temperature measurement), -200 to +400 °C (-328 to +750 °F)"
- Order code for "Sensor version", option DA "mass steam; 316L; 316L (integrated pressure/temperature measurement), -200 to +400 °C (-328 to +750 °F)"
- Order code for "Sensor version", option DB "mass gas/liquid; 316L; 316L (integrated pressure/temperature measurement), -40 to +100 °C (-40 to +212 °F)"

The second temperature measurement is taken using a separate temperature sensor. The measuring device reads in this value via a communication interface.

- In the case of saturated steam delta heat measurements, the measuring device must be installed on the steam side.
- In the case of water delta heat measurements, the device can be installed on the cold or warm side.

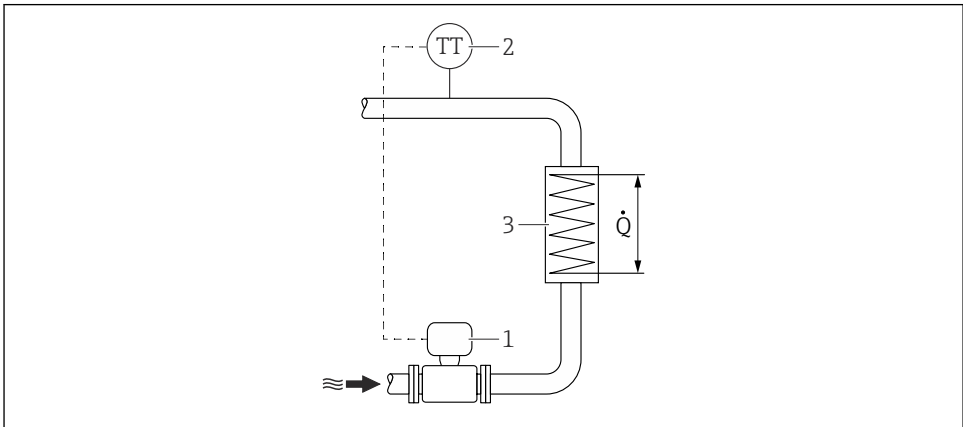

A0019209

4 Layout for delta heat measurement of saturated steam and water

- 1 Measuring device
- 2 Temperature sensor
- 3 Heat exchanger
- Q Heat flow

Protective cover

Observe the following minimum head clearance: 222 mm (8.74 in)

5.2 Installing the measuring instrument



For detailed information about turning the transmitter housing and display module, see the Brief Operating Instructions for the transmitter → 3

5.2.1 Required tools

For transmitter

- For turning the transmitter housing: Open-ended wrench 8 mm
- For opening the securing clamps: Allen key 3 mm

For sensor

For flanges and other process connections: Use a suitable mounting tool.

5.2.2 Preparing the measuring device

1. Remove all remaining transport packaging.
2. Remove any protective covers or protective caps present from the sensor.
3. Remove stick-on label on the electronics compartment cover.

5.2.3 Installing the sensor



Danger due to improper process sealing!

- ▶ Ensure that the inside diameters of the gaskets are greater than or equal to that of the process connections and piping.
- ▶ Ensure that the seals and sealing surfaces are clean and undamaged.
- ▶ Secure the seals correctly.

1. Ensure that the direction of the arrow on the sensor matches the flow direction of the medium.
2. Install the measuring instrument between the pipe flanges such that it is centered in the measurement section.
3. Install the measuring instrument or turn the transmitter housing so that the cable entries do not point upwards.

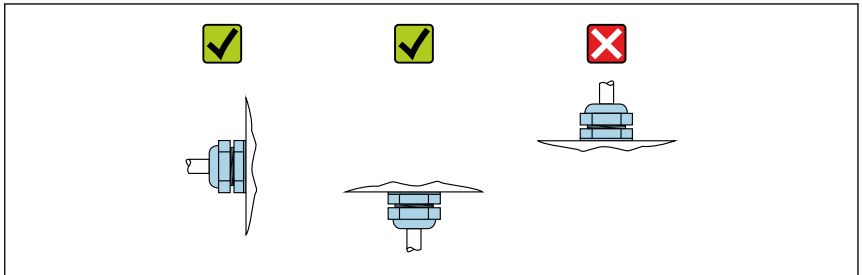

A0029263

5.2.4 Mounting the pressure measuring unit

Preparation

1. Prior to mounting the pressure measuring unit, install the measuring device in the pipe.
2. When mounting the pressure measuring unit, use only the seal provided. The use of a different sealing material is not permitted.

Removing the blind flange

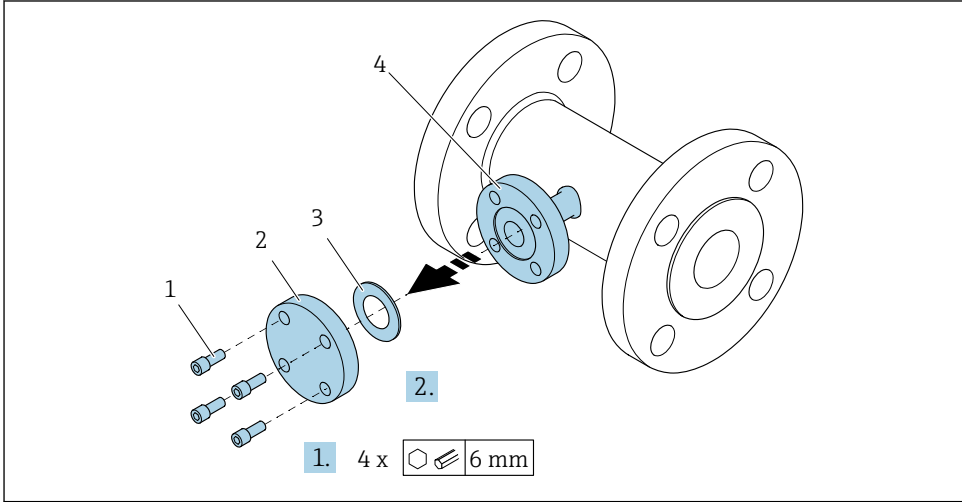

A0034355

- 1 *Mounting screws*
- 2 *Blind flange*
- 3 *Seal*
- 4 *Flange connection on sensor side*

NOTICE

When replacing the seal following commissioning, fluid may escape when the flange connection is opened!

- ▶ Ensure that the measuring device is not under pressure.
- ▶ Ensure that there is no fluid in the measuring device.

1. Release the mounting screws on the blind flange.
 - ↳ The screws are needed again to mount the pressure measuring unit.
2. Remove the internal seal.

Mounting the pressure measuring unit

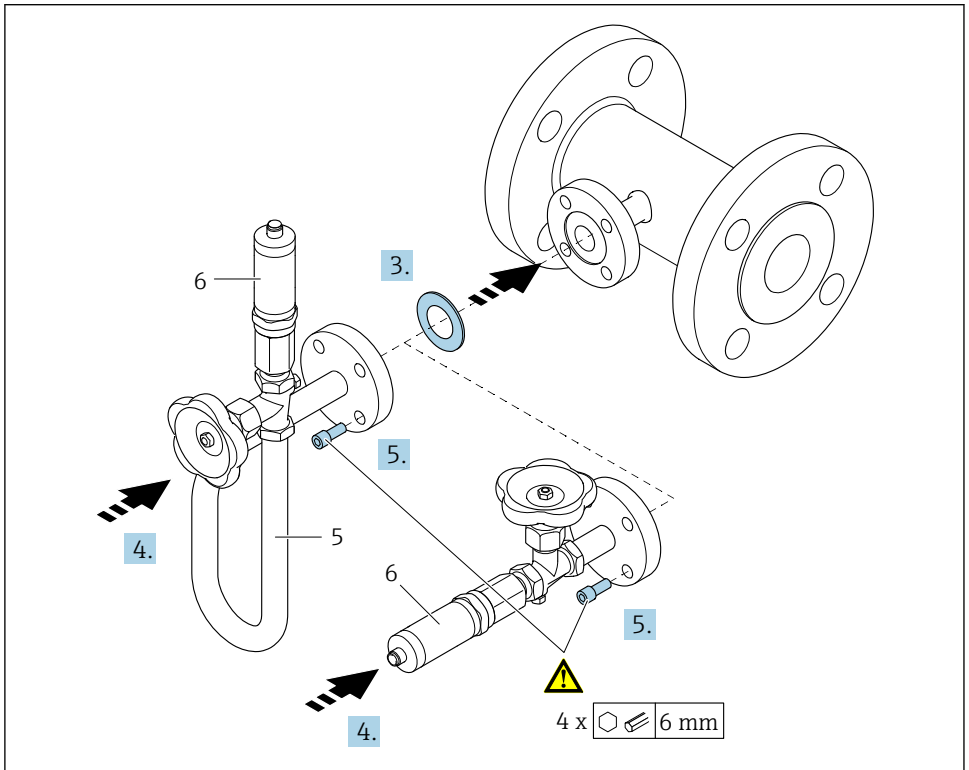

A0035442

- 5 Siphon
6 Pressure measuring cell

3. NOTICE

Damage to seal!

The seal is made of expanded graphite. It can therefore be used only once. If a coupling is released, a new seal must be installed.

- ▶ Use the additional seals provided. If necessary, these can be ordered as separate spare parts at a later stage.

Insert the enclosed seal into the groove of the flange connection on the sensor side.

4. Align the flange connection on the pressure measuring unit and tighten the screws by hand.
5. Tighten the screws with a torque wrench in three steps.
- ↳ 1. 10 Nm in criss-cross sequence
 - 2. 15 Nm in criss-cross sequence
 - 3. 15 Nm in circular sequence

Connecting the pressure measuring unit

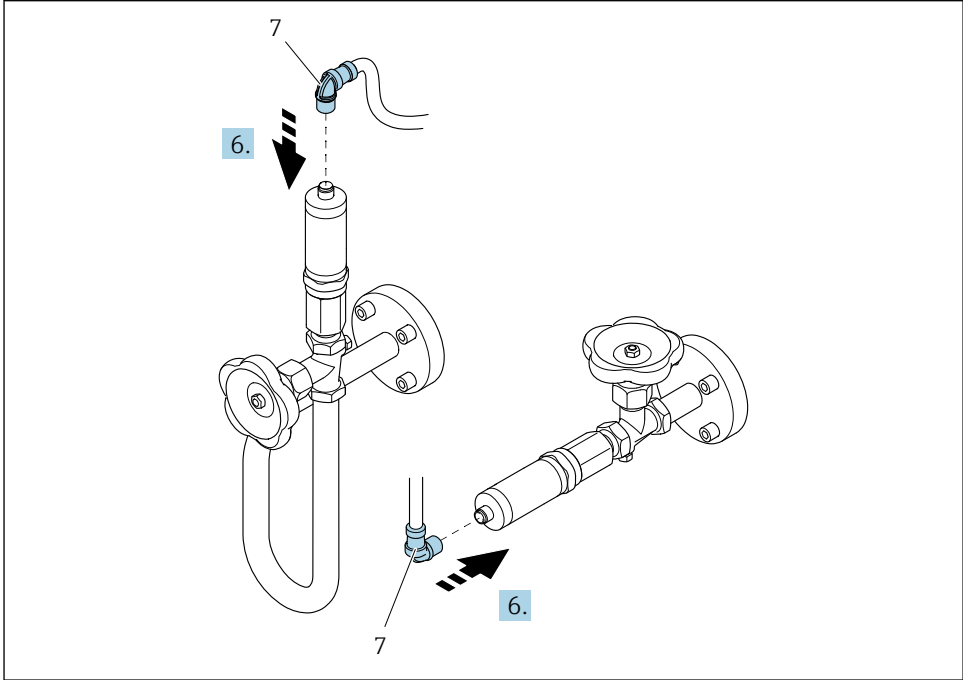



A0035443

7 Device plug

- 6. Insert the plug for electrical connection of the pressure measuring cell and screw into place.

5.3 Post-mounting check

Is the device undamaged (visual inspection)?	<input type="checkbox"/>
Does the measuring instrument correspond to the measuring point specifications? For example:	<input type="checkbox"/>
▪ Process temperature	
▪ Process pressure (refer to the section on "Pressure/temperature ratings" in the "Technical Information" document)	
▪ Ambient temperature	
▪ Measuring range	
Has the correct orientation been selected for the sensor → 12?	<input type="checkbox"/>
▪ According to sensor type	<input type="checkbox"/>
▪ As per medium temperature	
▪ As per medium properties (outgassing, with entrained solids)	
Does the arrow on the sensor match the direction of flow of the medium → 12?	<input type="checkbox"/>
Is the tag name and labeling correct (visual inspection)?	<input type="checkbox"/>
Is the device sufficiently protected from precipitation and direct sunlight?	<input type="checkbox"/>

Are the securing screw and securing clamp tightened securely?	<input type="checkbox"/>
Has the maximum permitted insulation height been observed?	<input type="checkbox"/>
Has the pressure range been observed?	<input type="checkbox"/>
Has the correct orientation been selected for the sensor →  13?	<input type="checkbox"/>
Is the pressure unit mounted correctly →  22?	<input type="checkbox"/>
Are the manometer valve and the siphon with pressure measuring cell mounted using the prescribed seal and the specified tightening torque →  22?	<input type="checkbox"/>

6 Disposal



If required by the Directive 2012/19/EU on waste electrical and electronic equipment (WEEE), the product is marked with the depicted symbol in order to minimize the disposal of WEEE as unsorted municipal waste. Do not dispose of products bearing this marking as unsorted municipal waste. Instead, return them to the manufacturer for disposal under the applicable conditions.

6.1 Removing the measuring device

1. Switch off the device.

WARNING

Risk of personal injury due to process conditions!

- ▶ Beware of hazardous process conditions such as pressure in the measuring device, high temperatures or aggressive media.

2. Carry out the mounting and connection steps from the "Mounting the measuring device" and "Connecting the measuring device" sections in reverse order.
3. Observe the safety instructions.

6.2 Disposing of the measuring device

WARNING

Danger to personnel and environment from fluids that are hazardous to health.

- ▶ Ensure that the measuring device and all cavities are free of fluid residues that are hazardous to health or the environment, e.g. substances that have permeated into crevices or diffused through plastic.

Follow these instructions when disposing of the device:

- ▶ Comply with national regulations.
- ▶ Ensure proper separation and reuse of the device components.



71756816

www.addresses.endress.com
