

# Brief Operating Instructions

## Dosimag

Electromagnetic flowmeter



These Brief Operating Instructions are **not** a substitute for the Operating Instructions pertaining to the device.

Detailed information about the device can be found in the Operating Instructions and the other documentation:

- Internet: [www.endress.com/deviceviewer](http://www.endress.com/deviceviewer)
- Smartphone/tablet: *Endress+Hauser Operations app*

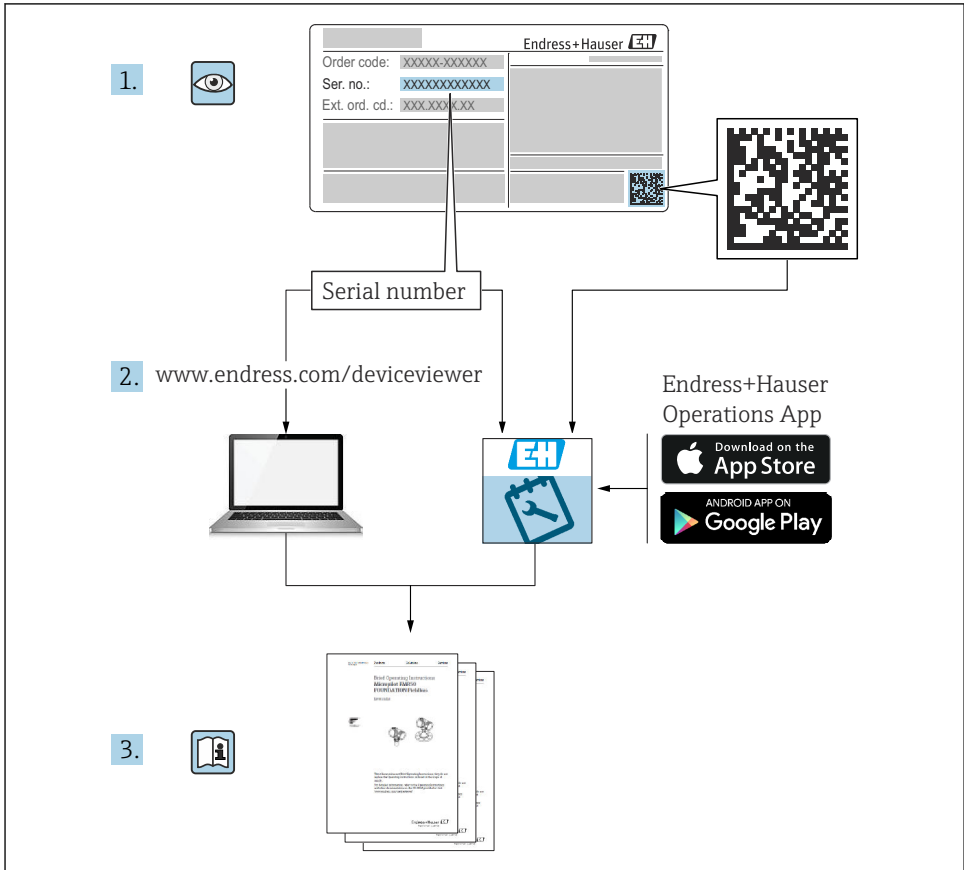

A0023555

# Table of contents

<b>1</b>	<b>About this document</b> .....	<b>4</b>
1.1	Symbols .....	4
<b>2</b>	<b>Safety instructions</b> .....	<b>5</b>
2.1	Requirements for the personnel .....	5
2.2	Intended use .....	6
2.3	Workplace safety .....	6
2.4	Operational safety .....	7
2.5	Product safety .....	7
2.6	IT security .....	7
<b>3</b>	<b>Incoming acceptance and product identification</b> .....	<b>7</b>
3.1	Incoming acceptance .....	7
3.2	Product identification .....	8
<b>4</b>	<b>Storage and transport</b> .....	<b>8</b>
4.1	Storage conditions .....	8
4.2	Transporting the product .....	9
4.3	Packaging disposal .....	9
<b>5</b>	<b>Mounting</b> .....	<b>10</b>
5.1	Mounting requirements .....	10
5.2	Mounting the measuring instrument .....	18
5.3	Post-mounting check .....	21
<b>6</b>	<b>Electrical connection</b> .....	<b>22</b>
6.1	Electrical safety .....	22
6.2	Connecting requirements .....	22
6.3	Connecting the device .....	29
6.4	Ensuring potential equalization .....	31
6.5	Ensuring the degree of protection .....	33
6.6	Post-connection check .....	33
<b>7</b>	<b>Operation options</b> .....	<b>35</b>
7.1	Overview of operation options .....	35
7.2	Access to the operating menu via the operating tool .....	35
<b>8</b>	<b>System integration</b> .....	<b>38</b>
<b>9</b>	<b>Commissioning</b> .....	<b>38</b>
9.1	Post-mounting and post-connection check .....	38
9.2	Switching on the measuring device .....	38
9.3	Connecting via FieldCare .....	38
9.4	Configuring the measuring instrument .....	38
<b>10</b>	<b>Diagnostic information</b> .....	<b>39</b>

# 1 About this document

## 1.1 Symbols

### 1.1.1 Safety symbols

#### DANGER

This symbol alerts you to a dangerous situation. Failure to avoid this situation will result in serious or fatal injury.

#### WARNING

This symbol alerts you to a potentially dangerous situation. Failure to avoid this situation can result in serious or fatal injury.











#### CAUTION

This symbol alerts you to a potentially dangerous situation. Failure to avoid this situation can result in minor or medium injury.





#### NOTICE

This symbol alerts you to a potentially harmful situation. Failure to avoid this situation can result in damage to the product or something in its vicinity.

### 1.1.2 Symbols for certain types of information





Symbol	Meaning	Symbol	Meaning
	<b>Permitted</b> Procedures, processes or actions that are permitted.		<b>Preferred</b> Procedures, processes or actions that are preferred.
	<b>Forbidden</b> Procedures, processes or actions that are forbidden.		<b>Tip</b> Indicates additional information.
	Reference to documentation		Reference to page
	Reference to graphic		Series of steps
	Result of a step		Visual inspection

### 1.1.3 Electrical symbols





Symbol	Meaning	Symbol	Meaning
	Direct current		Alternating current
	Direct current and alternating current		<b>Ground connection</b> A grounded terminal which, as far as the operator is concerned, is grounded via a grounding system.

Symbol	Meaning
	<p><b>Potential equalization connection (PE: Protective earth)</b>                      Ground terminals that must be connected to ground prior to establishing any other connections.</p> <p>The ground terminals are located on the interior and exterior of the device:</p> <ul style="list-style-type: none"> <li>▪ Interior ground terminal: potential equalization connection is connected to the supply network.</li> <li>▪ Exterior ground terminal: device is connected to the plant grounding system.</li> </ul>

### 1.1.4 Tool symbols

Symbol	Meaning	Symbol	Meaning
	Torx screwdriver		Flat-blade screwdriver
	Phillips screwdriver		Allen key
	Open-end wrench		

### 1.1.5 Symbols in graphics

Symbol	Meaning	Symbol	Meaning
1, 2, 3,...	Item numbers		Series of steps
A, B, C, ...	Views	A-A, B-B, C-C, ...	Sections
	Hazardous area		Safe area (non-hazardous area)
	Flow direction		

## 2 Safety instructions

### 2.1 Requirements for the personnel

The personnel must fulfill the following requirements for its tasks:

- ▶ Trained, qualified specialists must have a relevant qualification for this specific function and task.
- ▶ Are authorized by the plant owner/operator.
- ▶ Are familiar with federal/national regulations.
- ▶ Before starting work, read and understand the instructions in the manual and supplementary documentation as well as the certificates (depending on the application).
- ▶ Follow instructions and comply with basic conditions.

## 2.2 Intended use

Depending on the version ordered, the measuring instrument can also measure potentially explosive, flammable, poisonous and oxidizing media.

Measuring instruments for use in hazardous areas, in hygienic applications, or where there is an increased risk due to pressure, are specially labeled on the nameplate.

To ensure that the measuring instrument remains in proper condition during the operating time:

- ▶ Only use the measuring instrument in full compliance with the data on the nameplate and the general conditions listed in the manual and supplementary documentation.
- ▶ Using the nameplate, check whether the ordered device is permitted for the intended use in the hazardous area (e.g. explosion protection, pressure vessel safety).
- ▶ Use the measuring instrument only for media against which the materials in contact with the process are sufficiently resistant.
- ▶ Keep within the specified pressure and temperature range.
- ▶ Keep within the specified ambient temperature range.
- ▶ Protect the measuring instrument permanently against corrosion from environmental influences.

### Incorrect use

Non-designated use can compromise safety. The manufacturer is not liable for damage caused by improper or non-designated use.

#### WARNING

### Danger of breakage due to corrosive or abrasive fluids and ambient conditions!

- ▶ Verify the compatibility of the process fluid with the sensor material.
- ▶ Ensure the resistance of all wetted materials during the process.
- ▶ Keep within the specified pressure and temperature range.

#### NOTICE

### Verification for borderline cases:

- ▶ For special fluids and fluids for cleaning, Endress+Hauser is glad to provide assistance in verifying the corrosion resistance of fluid-wetted materials, but does not accept any warranty or liability as minute changes in the temperature, concentration or level of contamination in the process can alter the corrosion resistance properties.

### Residual risks

#### WARNING

**Risk of hot or cold burns! The use of media and electronics with high or low temperatures can produce hot or cold surfaces on the device.**

- ▶ Mount suitable touch protection.

## 2.3 Workplace safety

For work on and with the device:

- ▶ Wear the required personal protective equipment according to federal/national regulations.

## 2.4 Operational safety

Damage to the device!

- ▶ Operate the device in proper technical condition and fail-safe condition only.
- ▶ The operator is responsible for the interference-free operation of the device.

## 2.5 Product safety

This state-of-the-art device is designed and tested in accordance with good engineering practice to meet operational safety standards. It left the factory in a condition in which it is safe to operate.

It meets general safety standards and legal requirements. It also complies with the EU directives listed in the device-specific EU declaration of conformity. The manufacturer confirms this by affixing the CE mark.

## 2.6 IT security

The manufacturer warranty is valid only if the product is installed and used as described in the Operating Instructions. The product is equipped with security mechanisms to protect it against any inadvertent changes to the settings.

IT security measures, which provide additional protection for the product and associated data transfer, must be implemented by the operators themselves in line with their security standards.

# 3 Incoming acceptance and product identification

## 3.1 Incoming acceptance

On receipt of the delivery:

1. Check the packaging for damage.
  - ↳ Report all damage immediately to the manufacturer.  
Do not install damaged components.
2. Check the scope of delivery using the delivery note.
3. Compare the data on the nameplate with the order specifications on the delivery note.
4. Check the technical documentation and all other necessary documents, e.g. certificates, to ensure they are complete.



If one of the conditions is not satisfied, contact the manufacturer.

## 3.2 Product identification

The device can be identified in the following ways:

- Nameplate
- Order code with details of the device features on the delivery note
- Enter the serial numbers from the nameplates in the *Device Viewer* ([www.endress.com/deviceviewer](http://www.endress.com/deviceviewer)): all the information about the device is displayed.
- Enter the serial numbers from the nameplates into the *Endress+Hauser Operations app* or scan the DataMatrix code on the nameplate with the *Endress+Hauser Operations app*: all the information about the device is displayed.

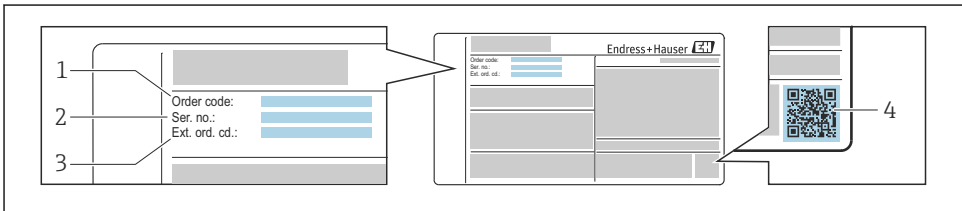

A0030196

### 1 Example of a nameplate

- 1 Order code
- 2 Serial number
- 3 Extended order code
- 4 2-D matrix code (QR code)

 For detailed information on the data on the nameplate, see the Operating Instructions for the device.

## 4 Storage and transport

### 4.1 Storage conditions

Observe the following notes for storage:

- ▶ Store in the original packaging to ensure protection from shock.
- ▶ Do not remove protective covers or protective caps installed on process connections. They prevent mechanical damage to the sealing surfaces and contamination in the measuring tube.
- ▶ Protect from direct sunlight. Avoid unacceptably high surface temperatures.
- ▶ Select a storage location that excludes the possibility of condensation forming on the measuring device. Fungi and bacteria can damage the liner.
- ▶ Store in a dry and dust-free place.
- ▶ Do not store outdoors.

Storage temperature →  16

## 4.2 Transporting the product

Transport the measuring instrument to the measuring point in the original packaging.



Do not remove protective covers or caps installed on process connections. They prevent mechanical damage to the sealing surfaces and contamination in the measuring tube.

## 4.3 Packaging disposal

All packaging materials are environmentally friendly and 100% recyclable:

- Outer packaging of device
  - Stretch wrap made of polymer in accordance with EU Directive 2002/95/EC (RoHS)
- Packaging
  - Wood crate treated in accordance with ISPM 15 standard, confirmed by IPPC logo
  - Cardboard box in accordance with European packaging guideline 94/62/EC, recyclability confirmed by Resy symbol
- Transport material and fastening fixtures
  - Disposable plastic pallet
  - Plastic straps
  - Plastic adhesive strips
- Filler material
  - Paper pads

# 5 Mounting

## 5.1 Mounting requirements

### 5.1.1 Mounting position

#### Mounting location

- Do not install the device at the highest point of the pipe.
- Do not install the device upstream from a free pipe outlet in a down pipe.

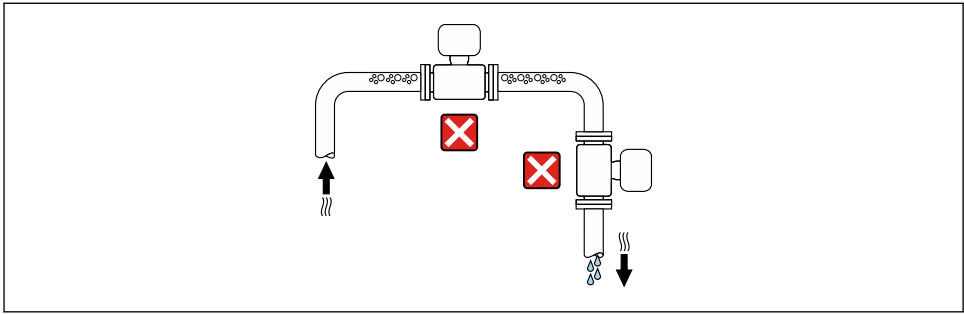

A0042131

The device should ideally be installed in an ascending pipe.

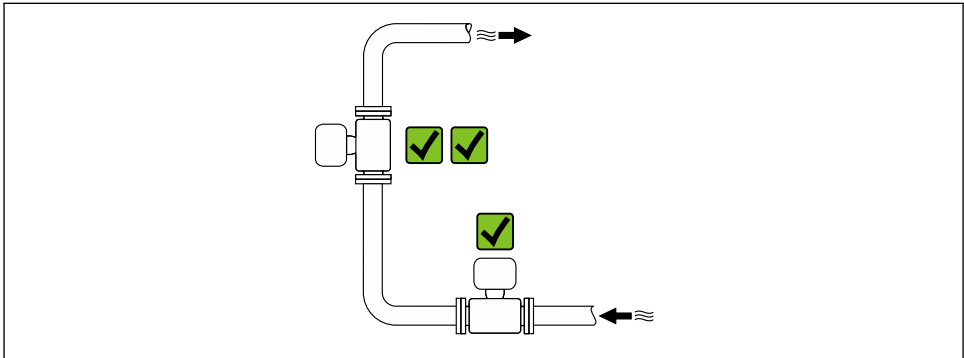

A0042317

*Installation upstream from a down pipe*

**NOTICE**

**Negative pressure in the measuring pipe can damage the liner!**

- ▶ If installing upstream of down pipes whose length  $h \geq 5 \text{ m}$  (16.4 ft): install a siphon with a vent valve downstream of the device.



This arrangement prevents the flow of liquid stopping in the pipe and air entrainment.

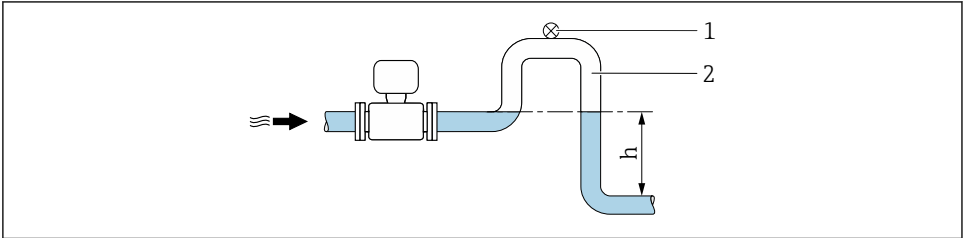

A0028981

- 1 Vent valve
- 2 Pipe siphon
- h Length of down pipe

*Installation with partially filled pipes*

- Partially filled pipes with a gradient require a drain-type configuration.
- The installation of a cleaning valve is recommended.

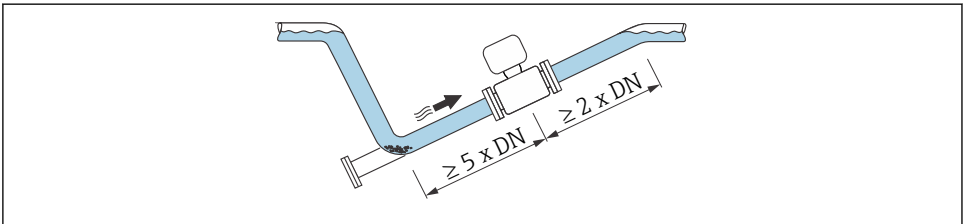

A0041088

*Installation near pumps*

**NOTICE**

**Negative pressure in the measuring tube can damage the liner!**

- ▶ In order to maintain the system pressure, install the device in the flow direction downstream from the pump.
- ▶ Install pulsation dampers if reciprocating, diaphragm or peristaltic pumps are used.

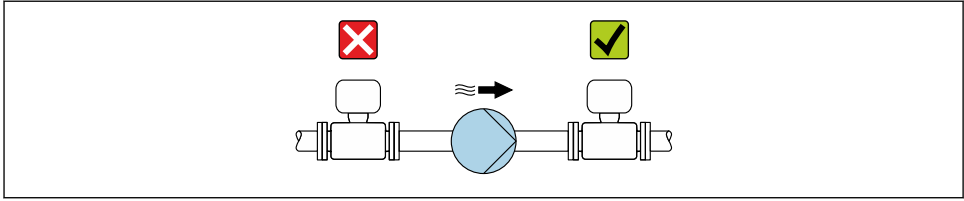

A0041083

*Installation in event of pipe vibrations*

**NOTICE**

**Pipe vibrations can damage the device!**

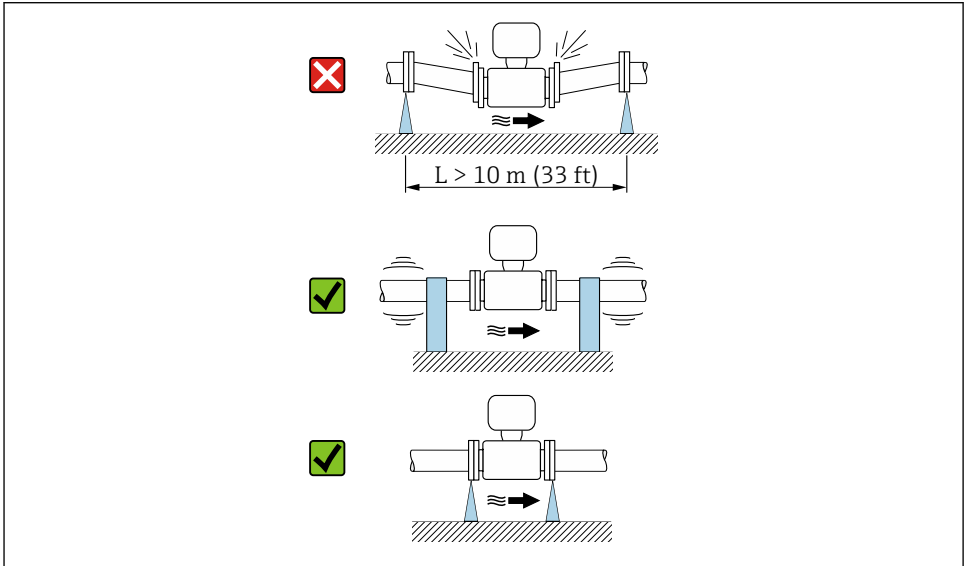

- ▶ Do not expose the device to strong vibrations.
- ▶ Support the pipe and fix it in place.
- ▶ Support the device and fix it in place.



A0041092

### Orientation

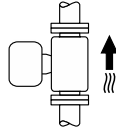
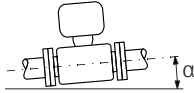
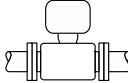
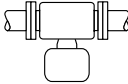
The direction of the arrow on the nameplate helps you to install the measuring device according to the flow direction.

Orientation		Recommendation
Vertical orientation	 <p style="text-align: right; font-size: small;">A0015591</p>	<input checked="" type="checkbox"/> <input checked="" type="checkbox"/>
Horizontal orientation	 <p style="text-align: right; font-size: small;">A0041328</p>	<input checked="" type="checkbox"/> <sup>1)</sup>
Horizontal orientation, transmitter at top	 <p style="text-align: right; font-size: small;">A0015589</p>	<input checked="" type="checkbox"/> <input checked="" type="checkbox"/> <sup>2)</sup>
Horizontal orientation, transmitter at bottom	 <p style="text-align: right; font-size: small;">A0015590</p>	<input checked="" type="checkbox"/> <input checked="" type="checkbox"/> <sup>3) 4)</sup>
Horizontal orientation, transmitter at side	 <p style="text-align: right; font-size: small;">A0015592</p>	<input type="checkbox"/> <input checked="" type="checkbox"/>

- 1) The measuring device should be self-draining for hygiene applications. A vertical orientation is recommended for this. If only a horizontal orientation is possible, an angle of inclination  $\alpha \geq 10^\circ$  is recommended.
- 2) Applications with low process temperatures may reduce the ambient temperature. To maintain the minimum ambient temperature for the transmitter, this orientation is recommended.
- 3) Applications with high process temperatures may increase the ambient temperature. To maintain the maximum ambient temperature for the transmitter, this orientation is recommended.
- 4) To prevent the electronics from overheating in the event of strong heat formation (e.g. CIP or SIP cleaning process), install the device with the transmitter part pointing downwards.

### Horizontal

Ideally, the measuring electrode plane should be horizontal. This prevents brief insulation of the measuring electrodes by entrained air bubbles.

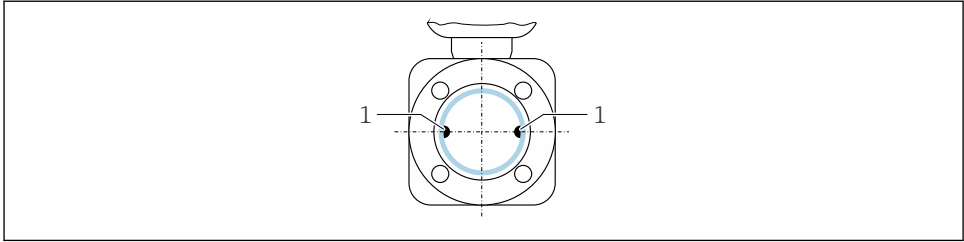

A0025817

1 Measuring electrodes for signal detection

### Valves

Never install the measuring device downstream from a filling valve. Completely emptying the measuring device results in a high distortion of the measured value.

**i** Correct measurement is possible only if the piping is completely filled. Perform sample fillings before commencing filling in production.

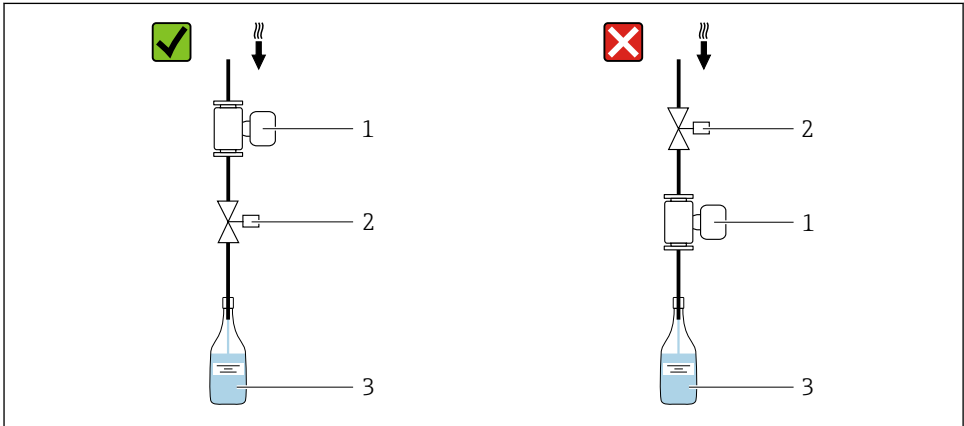

A0003768

- 1 Measuring device
- 2 Filling valve
- 3 Vessel

### Filling systems

The pipe system must be completely full to ensure optimum measurement.

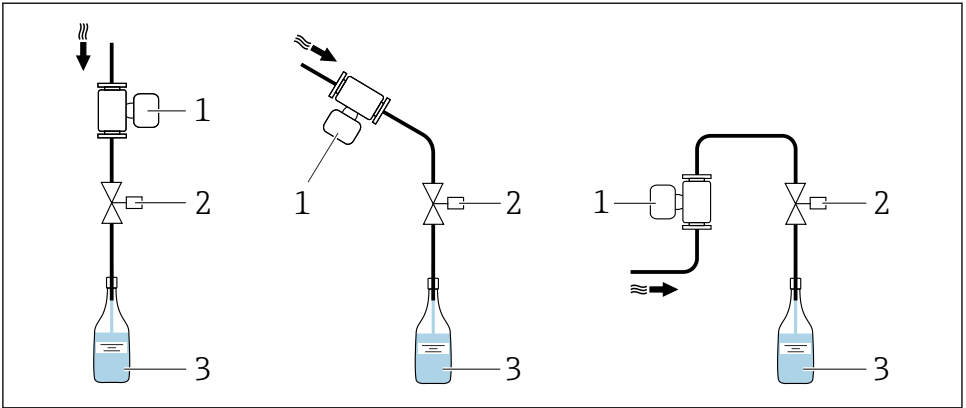

A0003795

2 Filling system

- 1 Measuring device
- 2 Filling valve
- 3 Vessel

**Inlet and outlet runs**

*Installation with inlet and outlet runs*

To avoid a vacuum and to maintain the specified level of measurement accuracy, install the device upstream from assemblies that produce turbulence (e.g. valves, T-sections) and downstream from pumps.

Maintain straight, unimpeded inlet and outlet runs.

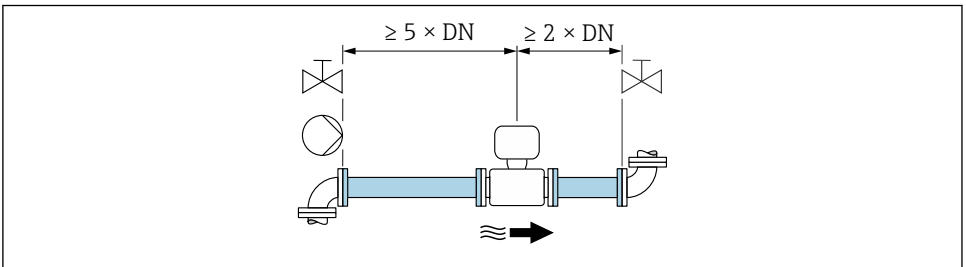

A0028997

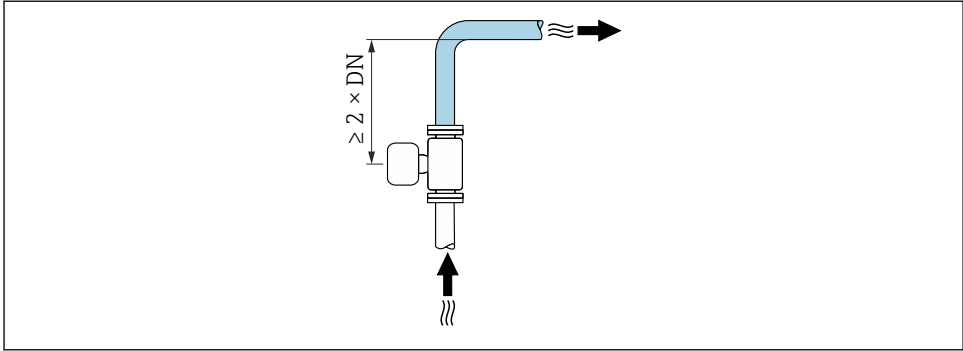

A0042132

## Installation dimensions

 For the dimensions and installation lengths of the device, see the "Technical Information" document, "Mechanical construction" section

### 5.1.2 Environmental and process requirements

#### Ambient temperature range

 For detailed information on the ambient temperature range, see the Operating Instructions for the device.

#### System pressure

Installation near pumps →  11

#### Vibrations

Installation in event of pipe vibrations →  12

### 5.1.3 Special mounting instructions

#### Information for filling systems

Correct measurement is only possible if the pipe is completely full. We therefore recommend that some test batches be carried out prior to production batching.

*Circular filling system*

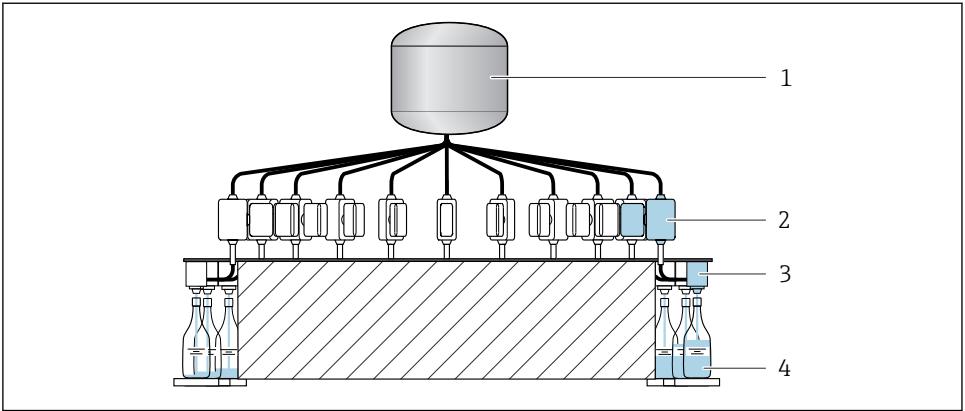

A0003761

- 1 Tank
- 2 Measuring instrument
- 3 Filling valve
- 4 Vessel

*Linear filling system*

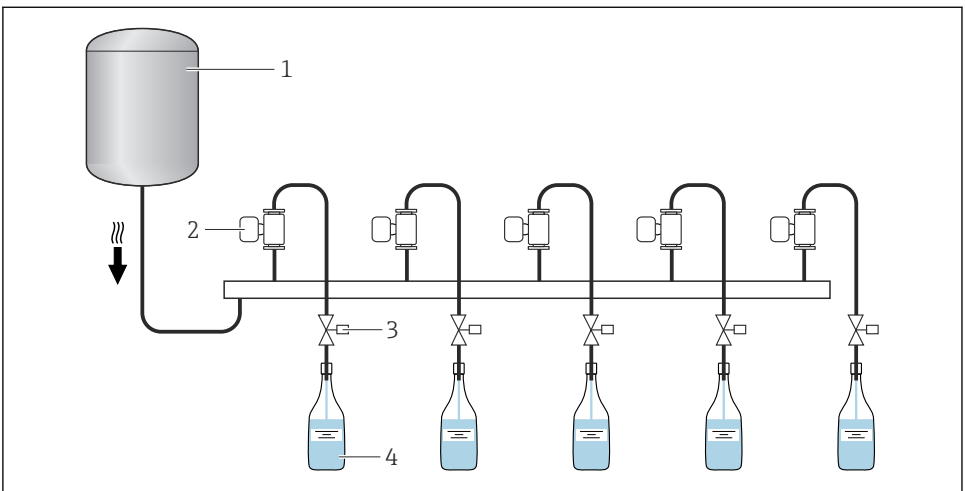

A0003762

- 1 Tank
- 2 Measuring instrument
- 3 Filling valve
- 4 Vessel

## Wall mounting kit

 Depending on the application and pipe length, the measuring instrument may need to be supported or additionally secured. In particular, it is absolutely essential to secure the measuring instrument additionally if plastic process connections are used. An appropriate wall mounting kit can be ordered separately as an accessory from Endress +Hauser.

## Zero adjustment

The **Sensor adjustment** submenu contains parameters required for zero adjustment.

 Detailed information on the "**Sensor adjustment** submenu": Device parameters

### NOTICE

**All Dosimag measuring instruments are calibrated in accordance with state-of-the-art technology. Calibration takes place under reference conditions .**

Zero adjustment is therefore not required for the Dosimag as a general rule.

- ▶ Experience shows that a zero adjustment is advisable only in special cases.
- ▶ When maximum measurement accuracy is required and flow rates are very low.

 For detailed information on the reference operating conditions: see the Operating Instructions for the device

## 5.2 Mounting the measuring instrument

### 5.2.1 Required tools

For process connections, use the appropriate installation tool

### 5.2.2 Preparing the measuring instrument

1. Remove all remaining transport packaging.
2. Remove any protective covers or protective caps present from the measuring instrument.

### 5.2.3 Mounting the measuring instrument

#### WARNING

**Danger due to improper process sealing!**

- ▶ Ensure that the inside diameters of the gaskets are greater than or equal to that of the process connections and piping.
- ▶ Ensure that the seals are clean and undamaged.
- ▶ Secure the seals correctly.

The measuring instrument is supplied to order, with or without pre-installed process connections. Pre-installed process connections are secured to the measuring instrument using 4 hexagonal-headed bolts.

- ▶ Ensure that the direction of the arrow on the nameplate of the measuring instrument matches the flow direction of the medium.

 Depending on the application and pipe length, the measuring instrument may need to be supported or additionally secured.

### Welding the measuring instrument into the pipe (welding nipples)

#### WARNING

#### Risk of destroying the electronics!

- ▶ Make sure that the welding system is not earthed via the measuring instrument.

1. Tack-weld the measuring instrument to secure it in the pipe. A suitable welding jig can be ordered separately as an accessory.
2. Loosen the screws on the process connection flange and remove the measuring instrument, along with the seal, from the pipe.
3. Weld the process connection into the pipe.
4. Reinstall the measuring instrument in the pipe, and in doing so make sure that the seal is clean and in the right position.

- 
  - If thin-walled pipes carrying food are welded correctly, the seal is not damaged by the heat even when mounted. However, it is recommended to disassemble the measuring instrument and seal.
  - It must be possible to open the pipe by at least 8 mm (0.31 in) for disassembly.

### Mounting the seals



Comply with the following instructions when installing seals:

1. The seals should be dry, clean, undamaged and correctly centered.
2. In the case of metal process connections, the screws must be tightened securely. The process connection forms a metal connection with the measuring instrument, which ensures a defined compression of the seal.
3. With regard to process connections made of plastic material, comply with the max. torques for lubricated threads: 7 Nm (5.2 lbf ft).
4. Depending on the application, the seals should be replaced periodically, particularly if molded seals are used (aseptic version). The interval between changes depends on the frequency of the cleaning cycles, the cleaning temperature and the medium temperature. Replacement seals can be ordered as an accessory.

### Mounting grounding rings

In the case of plastic process connections (e.g. external thread), the potential equalization between the measuring instrument/medium and the additional ground rings must be ensured. If grounding rings are not installed, this can affect the measurement accuracy or

cause the destruction of the measuring instrument as a result of the electrochemical decomposition of the electrodes.

 Pay attention to the information on potential equalization →  31.

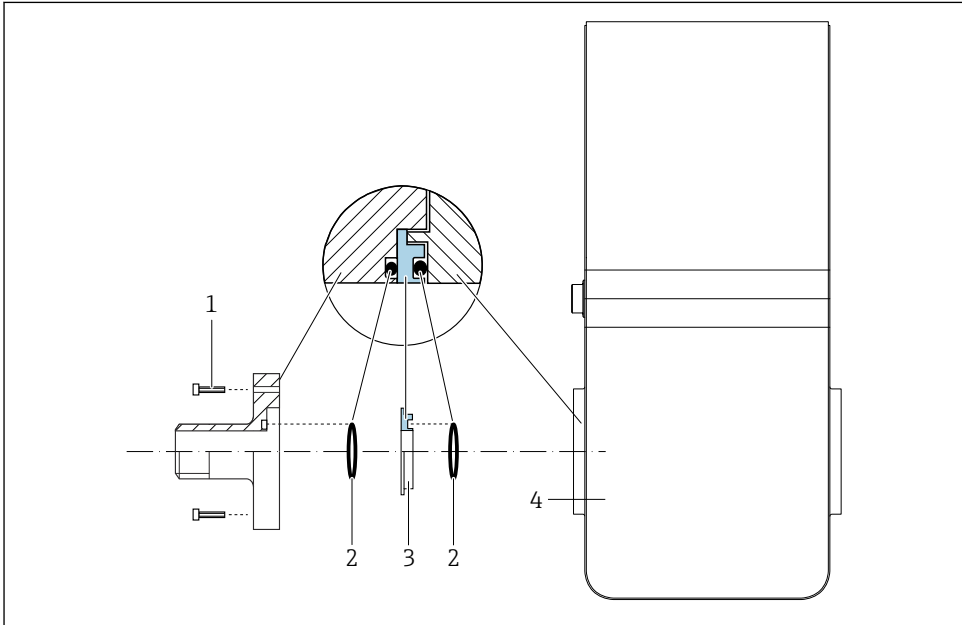





A0053324

### 3 Installing grounding rings

- 1 Hexagonal-headed bolts of process connection
- 2 O-ring seals
- 3 Grounding ring or plastic disk (spacer)
- 4 Measuring instrument

1. Release 4 hexagonal-headed bolts (1) and remove the process connection from the measuring instrument (4).
2. Remove the plastic disk (3), along with the two O-ring seals (2), from the process connection.
3. Place the first O-ring seal (2) back into the groove of the process connection.
4. Fit the metal grounding ring (3) in the process connection as illustrated.
5. Place the second O-ring seal (2) into the groove of the grounding ring.
6. Mount the process connection back on the measuring instrument. When doing so, make sure to observe the maximum screw tightening torques for lubricated threads: 7 Nm (5.2 lbf ft)

### 5.3 Post-mounting check

Is the measuring instrument undamaged (visual inspection)?	<input type="checkbox"/>
Does the measuring instrument conform to the measuring point specifications? For example: <ul style="list-style-type: none"> <li>▪ Process temperature</li> <li>▪ Process pressure</li> <li>▪ Ambient temperature</li> <li>▪ Measuring range</li> </ul>	<input type="checkbox"/>
Horizontal position of the measuring electrode plane →  13?	<input type="checkbox"/>
Has the correct orientation been selected for the measuring instrument →  13? <ul style="list-style-type: none"> <li>▪ As per measuring instrument type</li> <li>▪ According to medium temperature</li> <li>▪ According to medium properties (outgassing, with entrained solids)</li> </ul>	<input type="checkbox"/>
Does the arrow on the measuring instrument nameplate match the direction of flow of the medium through the piping ?	<input type="checkbox"/>
Are the measuring point identification and labeling correct (visual inspection)?	<input type="checkbox"/>
Is the measuring instrument adequately protected against vibration (attachment, support) →  12?	<input type="checkbox"/>
Are the inlet and outlet runs to respected →  15?	<input type="checkbox"/>

## 6 Electrical connection

### WARNING

**Live parts! Incorrect work performed on the electrical connections can result in an electric shock.**

- ▶ Set up a disconnecting device (switch or power-circuit breaker) to easily disconnect the device from the supply voltage.
- ▶ In addition to the device fuse, include an overcurrent protection unit with max. 16 A in the plant installation.

### 6.1 Electrical safety

In accordance with applicable national regulations.

### 6.2 Connecting requirements

#### 6.2.1 Requirements for connection cable

The connecting cables provided by the customer must fulfill the following requirements.

#### Permitted temperature range

- The installation guidelines that apply in the country of installation must be observed.
- The cables must be suitable for the minimum and maximum temperatures to be expected.

#### Signal cable



Cables are not included in the scope of delivery.



Please note the following with regard to cable loading:

- Voltage drop due to the cable length and cable type.
- Valve performance.

#### *Pulse/frequency/switch output*

Standard installation cable is sufficient.

#### *IO-Link*

Unshielded cable with 3 (or 4) conductors.



See <https://io-link.com>"IO-Link System Description"

#### *Switch output (batch), status output and status input*

Standard installation cable is sufficient.

#### Modbus RS485



The electrical connection of the shield to the device housing must be properly implemented (e.g. using a knurled nut).

*Total length of cable in the Modbus network ≤ 50 m*

Use a shielded cable.

*Example:*

Terminated device plug with cable: Lumberg RKWTH 8-299/10

*Total length of cable in the Modbus network > 50 m*

Use shielded twisted pair cable for RS485 applications.



*Example:*

- Cable: Belden item no. 9842 (for 4-wire version, the same cable can be used for the power supply)
- Terminated device plug: Lumberg RKCS 8/9 (shieldable version)

### 6.2.2 Terminal assignment

Connection is solely by means of device plug.

*There are different device versions available:*

Order code for "Output, input"	Device plug
Option AA: 2 pulse/frequency/switch outputs	→  23
Option FA: IO-Link, 1 pulse/frequency/switch output	→  25
Option MD: Modbus RS485, 2 switch outputs (batch), 1 status output, 1 status input	→  26

### 6.2.3 Available device plugs

#### Device version: 2 pulse/frequency/switch outputs

Order code for "Output, input": option AA:  
2 pulse/frequency/switch outputs

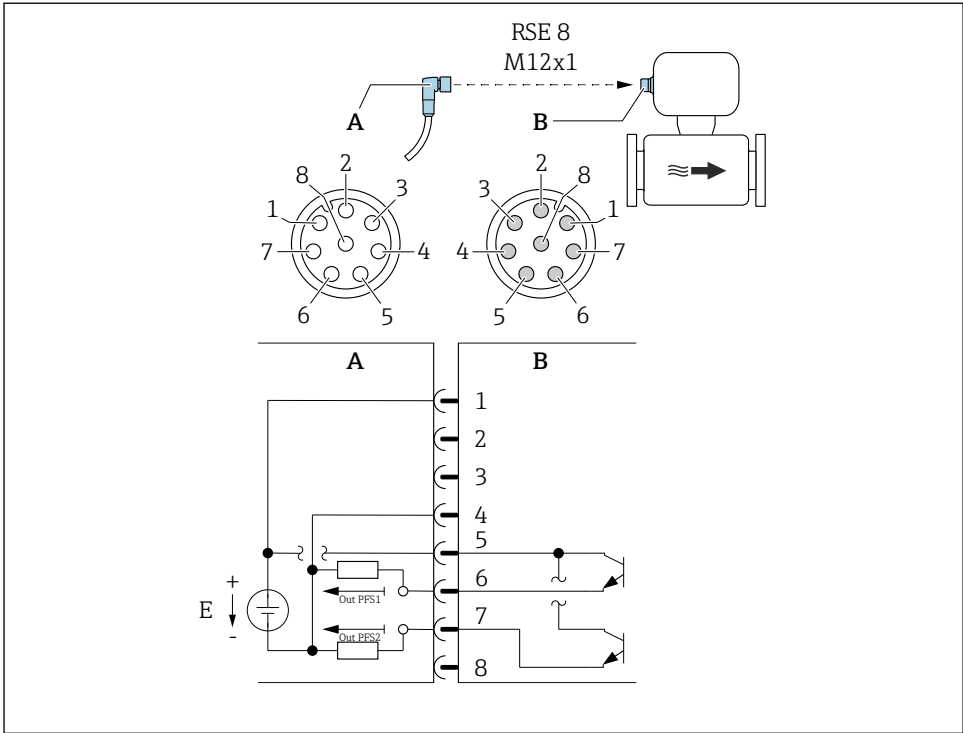

A0054673

**4** Connection to device

- A Coupling: Supply voltage, pulse/freq./switch output
- B Connector: Supply voltage, pulse/freq./switch output
- E PELV or SELV power supply
- 1 to Pin assignment
- 8

Pin assignment

Connection: Coupling (A) – Connector (B)		
Pin	Assignment	
1	L+	Supply voltage
2	+	Service interface RX
3	+	Service interface TX
4	L-	Supply voltage
5	+	Pulse/frequency/switch output 1 and 2
6	-	Pulse/frequency/switch output 1

Connection: Coupling (A) – Connector (B)		
Pin	Assignment	
7	-	Pulse/frequency/switch output 2
8	-	Service interface GND

**Device version: IO-Link, 1 pulse/frequency/switch output**

Order code for "Output, input", option FA:

IO-Link, 1 pulse/frequency/switch output

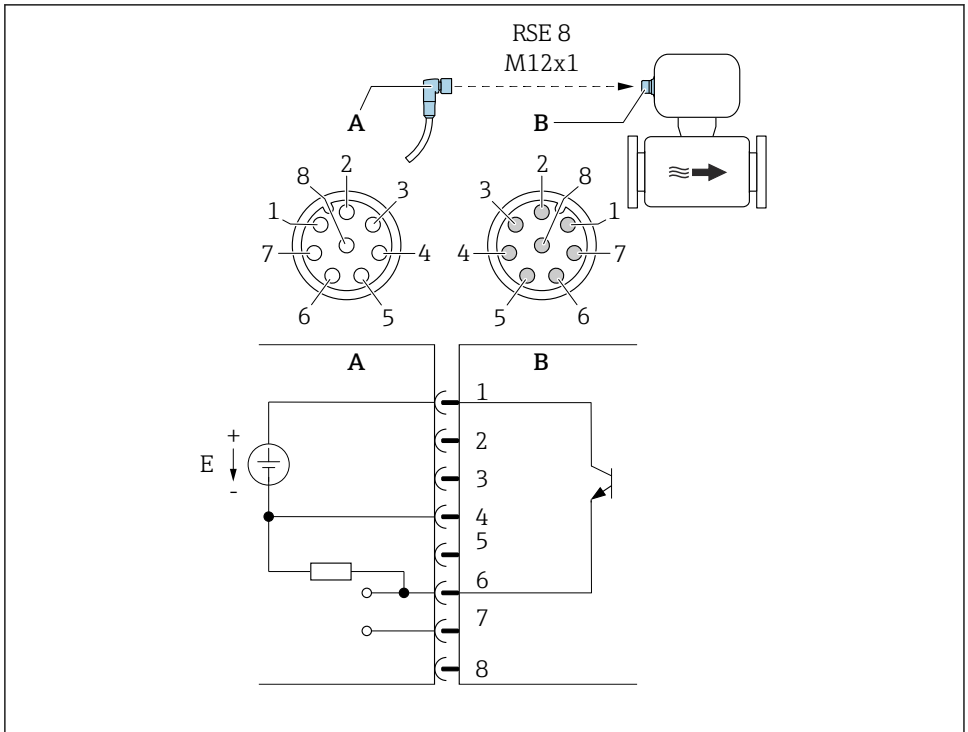

A0053318

5 Connection to device

A Coupling: Supply voltage, pulse/freq./switch output

B Connector: Supply voltage, pulse/freq./switch output

E PELV or SELV power supply

1 to Pin assignment

8

*Pin assignment*

Connection: Coupling (A) – Connector (B)		
Pin	Assignment	
1	L+	Supply voltage
2	+	Service interface RX
3	+	Service interface TX
4	L-	Supply voltage
5	Not used	
6	-	Pulse/frequency/switch output DQ
7	-	IO-Link communication signal C/Q
8	-	Service interface GND

 The pin assignment deviates from the IO-Link standard to enable compatibility with previous device versions and installations.

**Device version: Modbus RS485, 2 switch outputs (batch), 1 status output, 1 status input**

Order code for "Output, input", option MD:

Modbus RS485, 2 switch outputs (batch), 1 status output, 1 status input

Version 1: Status input via connection A/B

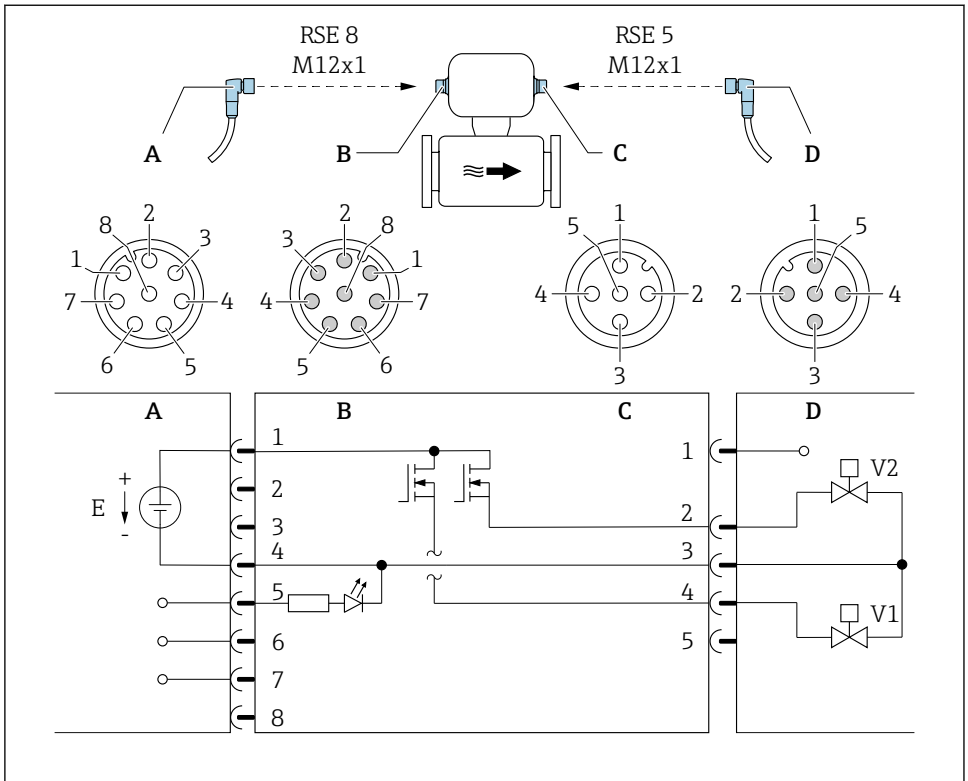

A0053319

6 Connection to device

- A Coupling: Supply voltage, Modbus RS485, status input
- B Connector: Supply voltage, Modbus RS485, status input
- C Coupling: Switch output (batch)
- D Connector: Switch output (batch)
- E PELV or SELV power supply
- V1 Valve (batch), level 1
- V2 Valve (batch), level 2
- 1 to 8 Pin assignment

Version 2: Status output via connection A/B

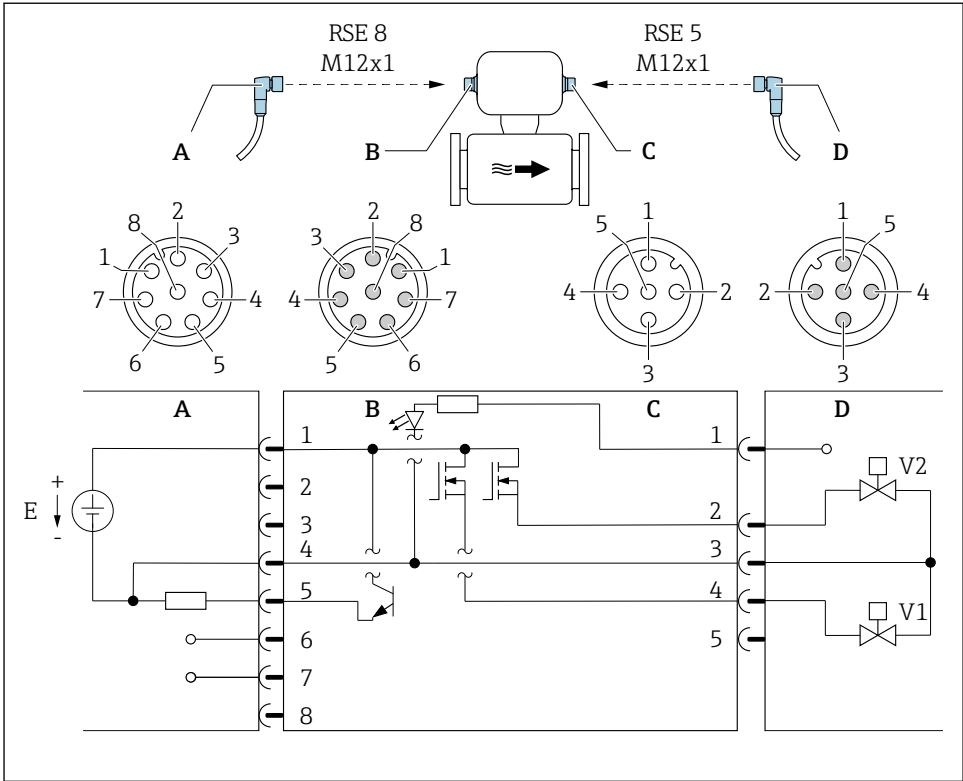

7 Connection to device

- A Coupling: Supply voltage, Modbus RS485, status output
- B Connector: Supply voltage, Modbus RS485, status output
- C Coupling: Switch output (batch), status input
- D Connector: Switch output (batch), status input
- E PELV or SELV power supply
- V1 Valve (batch), level 1
- V2 Valve (batch), level 2
- 1 to Pin assignment
- 8

*Pin assignment*

Connection: Coupling (A) – Connector (B)			Connection: Coupling (C) – Connector (D)		
Pin	Assignment		Pin	Assignment	
1	L+	Supply voltage	1	+	Status input
2	+	Service interface RX	2	+	Switch output (batch) 2
3	+	Service interface TX	3	-	Switch output (batch) 1 and 2, status input
4	L-	Supply voltage	4	+	Switch output (batch) 1
5	+	Status output/Status input <sup>1)</sup>	5	Not used	
6	+	Modbus RS485			
7	-	Modbus RS485			
8	-	Service interface GND			

1) The functionality of status input and status output is not possible at the same time.

**6.2.4 Requirements for the supply unit**

**Supply voltage**

DC 24 V (nominal voltage: DC 18 to 30 V)



- The power unit must be safety-approved (e.g. PELV, SELV).
- The maximum short-circuit current must not exceed 50 A.

**6.3 Connecting the device**

**NOTICE**

**An incorrect connection compromises electrical safety!**

- ▶ Only properly trained specialist staff may perform electrical connection work.
- ▶ Observe applicable federal/national installation codes and regulations.
- ▶ Comply with local workplace safety regulations.
- ▶ When using in potentially explosive atmospheres, observe the information in the device-specific Ex documentation.

**6.3.1 Connection via device plug**

Connection is solely by means of device plug.

**Device version: 2 pulse/frequency/status outputs and IO-Link, 1 pulse/frequency/status output**

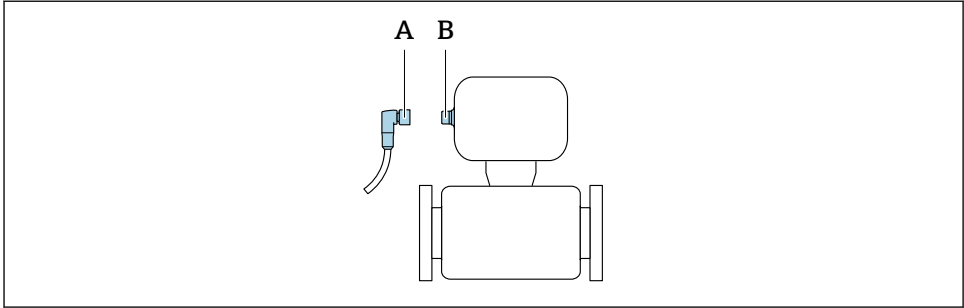

A0032652

A Coupling  
B Plug

**Device version: Modbus RS485, 2 batching outputs, 1 status output, 1 status input**

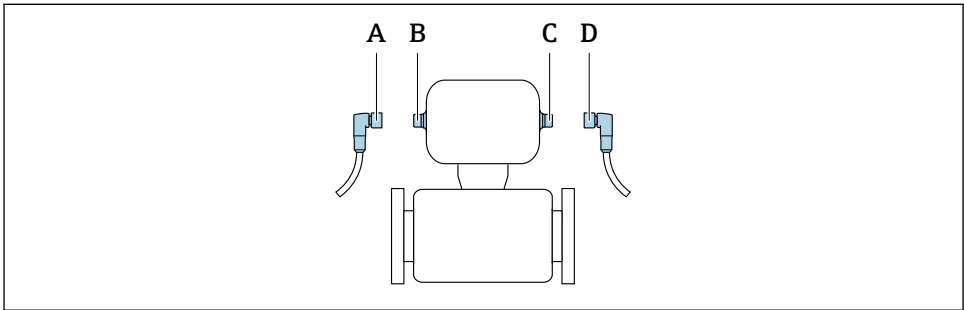

A0032534

A, C Coupling  
B, D Plug

### 6.3.2 Grounding

Grounding is by means of a cable socket.

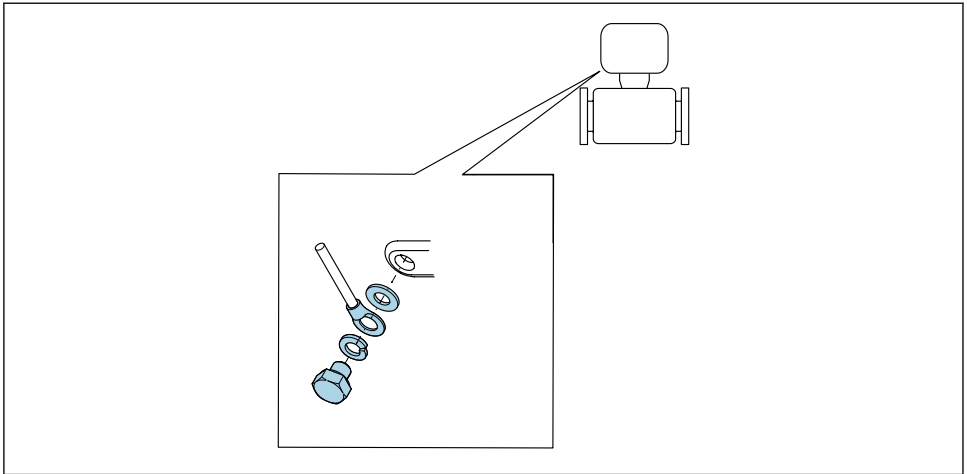

A0053306

## 6.4 Ensuring potential equalization

### 6.4.1 Requirements

For potential equalization:

- Pay attention to in-house grounding concepts
- Take account of operating conditions like the pipe material and grounding
- Connect the medium and measuring instrument to the same electric potential
- Use a ground cable with a minimum cross-section of 6 mm<sup>2</sup> (0.0093 in<sup>2</sup>) and a cable lug for potential equalization connections



For devices intended for use in hazardous locations, please observe the guidelines in the Ex documentation (XA).

### 6.4.2 Metal process connections

Potential equalization is via the metal process connections that are in contact with the medium and mounted directly on the measuring instrument.

### 6.4.3 Plastic process connections

**i** Note the following when using grounding rings:

- Depending on the option ordered, plastic disks are used instead of grounding rings on some process connections. The plastic disks act as "spacers" and do not have any potential equalization function. They perform a significant sealing function at the measuring instrument and process connection interfaces. In the case of process connections without metal grounding rings, the plastic disks and seals must never be removed. Plastic disks and seals must always be installed.
- Grounding rings can be ordered separately as an accessory from Endress+Hauser. The grounding rings must be compatible with the electrode material, as otherwise there is the danger that the electrodes could be destroyed by electrochemical corrosion. Material specifications.
- Grounding rings, including seals, are installed inside the process connections. This does not affect the installed length.

#### Potential equalization via additional grounding ring

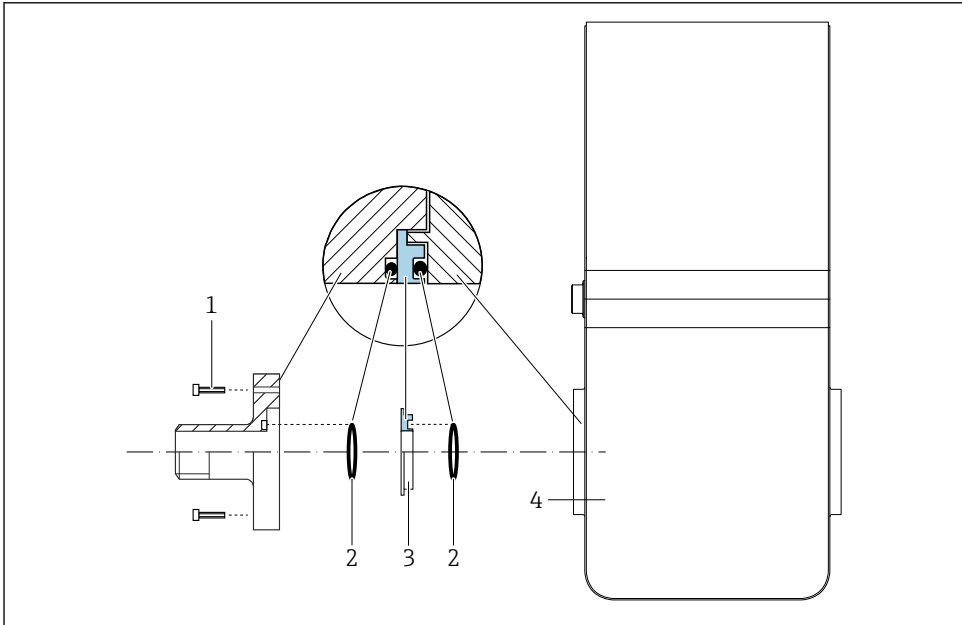

A0053324

- 1 Hexagonal-headed bolts of process connection
- 2 O-ring seals
- 3 Plastic disk (spacer) or grounding ring
- 4 Measuring instrument

### Potential equalization via grounding electrodes on process connection

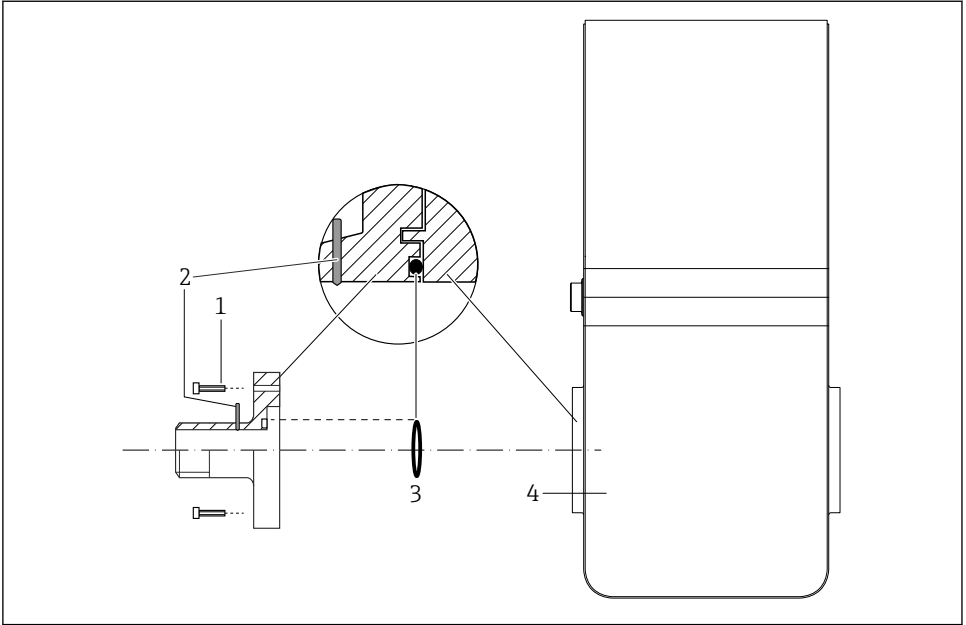

A0053325

- 1 Hexagonal-headed bolts of process connection
- 2 Integrated grounding electrodes
- 3 O-ring seal
- 4 Measuring instrument

### 6.5 Ensuring the degree of protection

The measuring device fulfills all the requirements for IP67 degree of protection, Type 4X enclosure.

To guarantee IP67 degree of protection, Type 4X enclosure, carry out the following steps after the electrical connection:

- ▶ Tighten all device plugs.

### 6.6 Post-connection check

Is the device undamaged (visual inspection)?	<input type="checkbox"/>
Does the supply voltage match the specifications on the transmitter nameplate ?	<input type="checkbox"/>
Do the cables used meet the requirements → ☰ 22?	<input type="checkbox"/>
Are the mounted cables strain relieved?	<input type="checkbox"/>
Is the terminal assignment correct → ☰ 23?	<input type="checkbox"/>
Is the protective earthing established correctly → ☰ 30?	<input type="checkbox"/>

Is the potential equalization established correctly →  31?	<input type="checkbox"/>
Are the maximum values for voltage and current observed at the pulse/frequency/switch outputs ?	<input type="checkbox"/>
Are the maximum values for voltage and current observed at the IO-Link interface and pulse/frequency/switch outputs ?	<input type="checkbox"/>
Are the maximum values for voltage and current observed at the Modbus interface, switch outputs, status output and status input ?	<input type="checkbox"/>

## 7 Operation options

### 7.1 Overview of operation options

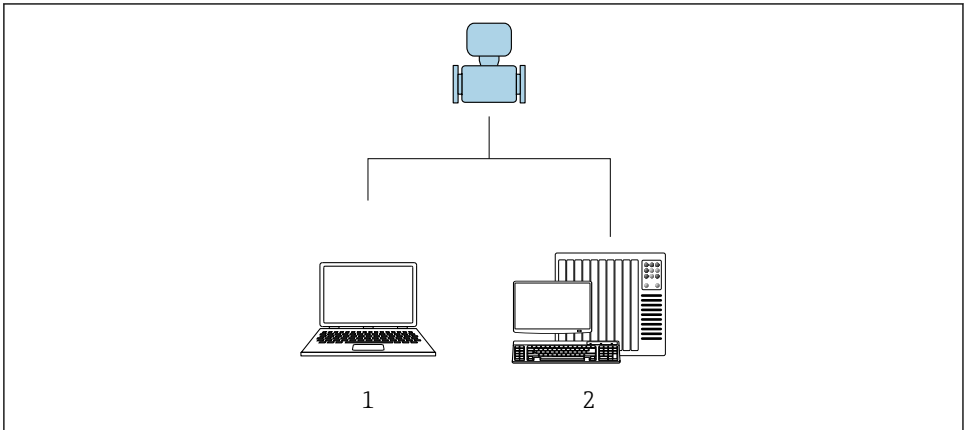

A0017760

- 1 Computer with "FieldCare" or "DeviceCare" operating tool
- 2 Control system (e.g. PLC)

## 7.2 Access to the operating menu via the operating tool

### 7.2.1 Connecting the operating tool

#### Using service adapter and Commubox FXA291

Operation and configuration can be performed using the Endress+Hauser FieldCare or DeviceCare service and configuration software.

The device is connected to the USB port of the computer via the service adapter and Commubox FXA291.

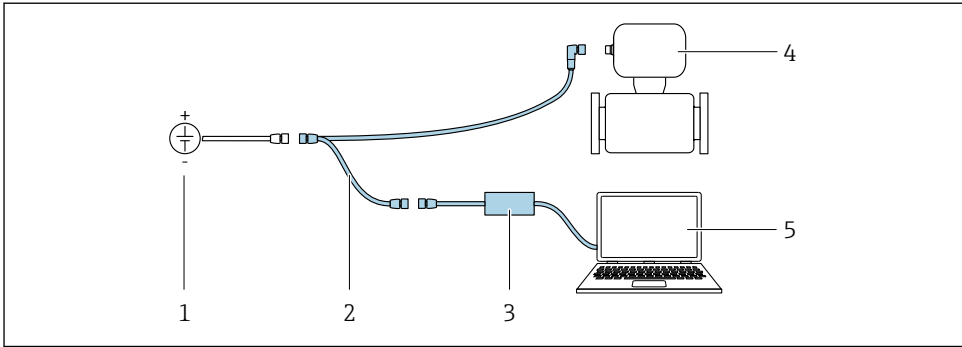

A0032567

- 1 Supply voltage 24 V DC
- 2 Service adapter
- 3 Commubox FXA291
- 4 Dosimag
- 5 Computer with "FieldCare" or "DeviceCare" operating tool

## 7.2.2 FieldCare

### Function range

FDT-based (Field Device Technology) plant asset management tool from Endress+Hauser. It can configure all smart field units in a system and helps you manage them. By using the status information, it is also a simple but effective way of checking their status and condition.

Typical functions:

- Transmitter parameter configuration
- Loading and saving of device data (upload/download)
- Documentation of the measuring point
- Visualization of the measured value memory (line recorder) and event logbook



- Operating Instructions BA00027S
- Operating Instructions BA00059S
- [www.endress.com](http://www.endress.com) → Downloads
- CD-ROM (contact Endress+Hauser)
- DVD (contact Endress+Hauser)

### Establishing a connection

Service adapter, Commubox FXA291 and "FieldCare" operating tool

1. Start FieldCare and launch the project.
2. In the network: Add a device.
  - ↳ The **Add device** window opens.
3. Select the **CDI Communication FXA291** option from the list and press **OK** to confirm.
4. Right-click **CDI Communication FXA291** and select the **Add device** option in the context menu that opens.

5. Select the desired device from the list and press **OK** to confirm.
6. Establish the online connection to the device.



- Operating Instructions BA00027S
- Operating Instructions BA00059S

### User interface

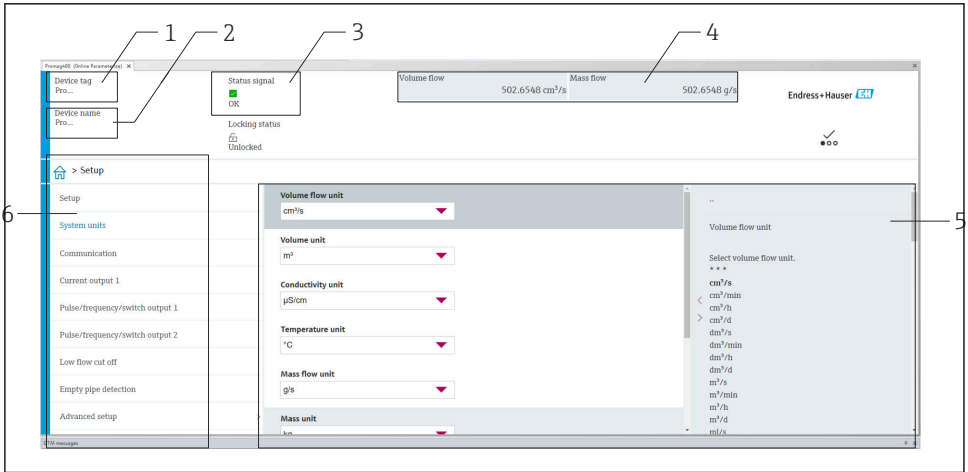

A0008200

- 1 Device name
- 2 Device tag
- 3 Status area with status signal
- 4 Display area for current measured values
- 5 Editing toolbar with other functions
- 6 Navigation area with operating menu structure

### 7.2.3 DeviceCare

#### Function range

Tool for connecting and configuring Endress+Hauser field devices.

The fastest way to configure Endress+Hauser field devices is with the dedicated "DeviceCare" tool. Together with the device type managers (DTMs) it presents a convenient, comprehensive solution.



Innovation brochure IN01047S

- [www.endress.com](http://www.endress.com) → Downloads
- CD-ROM (contact Endress+Hauser)
- DVD (contact Endress+Hauser)

## 8 System integration



For detailed information on system integration, see the Operating Instructions for the device

- Overview of device description files:
  - Current version data for the device
  - Operating tools
- Compatibility with earlier model
- Modbus RS485 information
  - Function codes
  - Response time
  - Modbus data map

## 9 Commissioning

### 9.1 Post-mounting and post-connection check

Before commissioning the device:

- ▶ Make sure that the post-installation and post-connection checks have been performed successfully.
  - Checklist for "Post-mounting" check → 21
  - Checklist for "Post-connection check" → 33

### 9.2 Switching on the measuring device

- ▶ The function check has been completed successfully.  
Switch on the supply voltage.
  - ↳ The measuring device runs through internal test functions.

The device is operational and operation commences.



If the device does not start up successfully, depending on the cause, a diagnostic message is displayed in the system asset management tool "FieldCare".

### 9.3 Connecting via FieldCare



For detailed information on establishing a connection via FieldCare, see the Operating Instructions for the device.

### 9.4 Configuring the measuring instrument



The device-specific parameters are configured via the "**Commissioning** wizard".



For detailed information on the "**Commissioning** wizard": Separate "Description of Device Parameters"(GP) document

## 10 Diagnostic information

Faults are displayed on the home page of the DeviceCare and FieldCare operating tools once the connection to the measuring instrument has been established.

Remedial measures are provided for each diagnostic event to ensure that problems can be rectified quickly.

DeviceCare and FieldCare: Remedial measures are displayed on the home page in a separate field below the diagnostic event.



71757758

[www.addresses.endress.com](http://www.addresses.endress.com)

---