

Special Documentation

Heating jacket

For Promass E Coriolis flowmeters

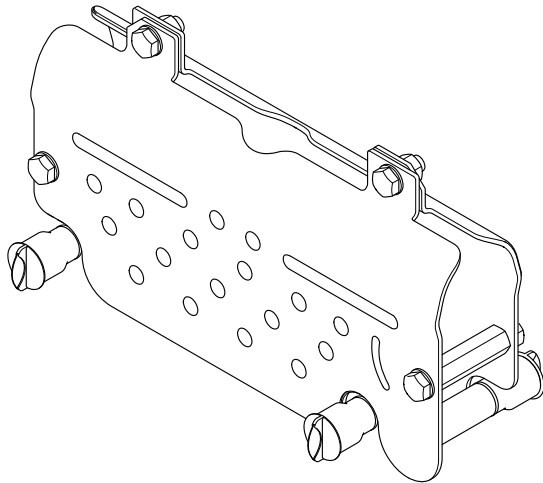

- Make sure the document is stored in a safe place such that it is always available when working on or with the device.
- To avoid danger to individuals or the facility, read the "Basic safety instructions" section carefully, as well as all other safety instructions in the document that are specific to working procedures.
- The manufacturer reserves the right to modify technical data without prior notice. Your Endress+Hauser Sales Center will supply you with current information and updates to these instructions.

Table of contents

1	Document information	4
1.1	Document function	4
1.2	Symbols used	4
1.3	Documentation	5
2	Basic safety instructions	7
3	Product description	8
3.1	Product design	8
3.2	Can be used for the following sensors ...	8
3.3	Availability	8
4	Incoming acceptance and product identification	9
4.1	Incoming acceptance	9
4.2	Product identification	10
5	Storage and transport	11
5.1	Storage conditions	11
5.2	Transporting the product	11
5.3	Packaging disposal	11
6	Installation	11
6.1	Installation conditions	11
6.2	Installing the heating jacket	12
6.3	Post-installation check	14
7	Connecting to the heating system	15
7.1	Connecting the heating jacket	15
7.2	Installing the valve	15
8	Repair	16
8.1	General notes	16
8.2	Spare parts	17
8.3	Endress+Hauser services	17
8.4	Return	17
8.5	Disposal	17
9	Technical data	18





1 Document information

1.1 Document function

This manual is Special Documentation and describes how to install the heating jacket (device).

1.2 Symbols used





1.2.1 Safety symbols

Symbol	Meaning
	DANGER! This symbol alerts you to a dangerous situation. Failure to avoid this situation will result in serious or fatal injury.
	WARNING! This symbol alerts you to a dangerous situation. Failure to avoid this situation can result in serious or fatal injury.
	CAUTION! This symbol alerts you to a dangerous situation. Failure to avoid this situation can result in minor or medium injury.
	NOTE! This symbol contains information on procedures and other facts which do not result in personal injury.

1.2.2 Tool symbols

Symbol	Meaning
	Open-ended wrench

1.2.3 Symbols for certain types of Information

Symbol	Meaning
	Tip Indicates additional information.
	Reference to documentation
	Reference to page
	Reference to graphic
	Notice or individual step to be observed

Symbol	Meaning
1, 2, 3...	Series of steps
↳	Result of a step

1.2.4 Symbols in graphics

Symbol	Meaning
1, 2, 3, ...	Item numbers
1, 2, 3, ...	Series of steps within an image

1.3 Documentation

Detailed information about the measuring device can be found in the Operating Instructions and other documentation:

- On the CD-ROM supplied (not included in the delivery for all device versions).
- Available for all device versions via:
 - Internet: www.endress.com/deviceviewer
 - Smart phone/tablet: *Endress+Hauser Operations App*

1.3.1 Standard documentation

Technical Information

Measuring device	Product root	Documentation code
Promass E 40E	40E**-	TI00055D
Promass E 80E, 83E	80E**-; 83E**-	TI00061D
Promass E 100	8E1B**-	TI01021D
Promass E 200	8E2B**-	TI01009D

Measuring device	Product root	Documentation code
Promass E 100	8E1C**-	TI01351D
Promass E 200	8E2C**-	TI01300D
Promass E 300	8E3**-	TI01272D
Promass E 500	8E5**-	TI01282D

Operating Instructions

Measuring device	Product root	Documentation code
Promass 40E	40E**-	BA061D

Measuring device	Product root	Documentation code	
		HART	PROFIBUS PA
Promass 80E	80E**-	BA00057D	BA00072D

Measuring device	Product root	Documentation code			
		HART	FOUNDATION Fieldbus	PROFIBUS DP/PA	Modbus RS485
Promass 83E	83E**-	BA00059D	BA00065D	BA00063D	BA00107D

Measuring device	Product root	Documentation code				
		HART	PROFIBUS DP	Modbus RS485	EtherNet/IP	PROFINET
Promass E 100	8E1B**-	BA01167D	BA01248D	BA01056D	BA01064D	BA01426D

Measuring device	Product root	Documentation code		
		HART	FOUNDATION Fieldbus	PROFIBUS PA
Promass E 200	8E2B**-	BA01027D	BA01314D	BA01133D

Measuring device	Product root	Documentation code				
		HART	PROFIBUS DP	Modbus RS485	EtherNet/IP	PROFINET
Promass E 100	8E1C**-	BA01713D	BA01714D	BA01711D	BA01712D	BA01715D

Measuring device	Product root	Documentation code		
		HART	FOUNDATION Fieldbus	PROFIBUS PA
Promass E 200	8E2C**-	BA01638D	BA01637D	BA01639D

Measuring device	Product root	Documentation code					
		HART	FOUNDATION Fieldbus	PROFIBUS PA	Modbus RS485	EtherNet/IP	PROFINET
Promass E 300	8E3***-	BA01484D	BA01517D	BA01506D	BA01495D	BA01727D	BA01738D
Promass E 500	8E5***-	BA01528D	BA01561D	BA01550D	BA01539D	BA01749D	BA01760D

2 Basic safety instructions

The heating jacket described in this manual is an accessory.

The heating jacket is designed to maintain a stable temperature in the sensor.

Application

To ensure that the heating jacket remains in proper condition for the operating time:

- ▶ Keep within the specified pressure and temperature range.
- ▶ Check the range of application on the nameplate of the heating jacket and measuring device.
- ▶ Keep within the range of application specified on the nameplates.
- ▶ Observe the technical data in accordance with this manual and the measuring device documentation.

Combination with measuring devices

- ▶ Do not combine the heating jacket with sensors that are fitted with a rupture disk or rinse connections.
- ▶ Use preferably a remote version of the transmitter and sensor.
- ▶ In hazardous areas, take precautions to ensure that the maximum permitted ambient temperature is not exceeded.

Heating medium

- ▶ If the temperature of the fluid and of the heating medium are very high, use the high-temperature version of the remote version.
- ▶ Use water, water vapor and other non-corrosive liquids as the heating medium.
- ▶ If using oil as the heating medium, please contact your Sales Center.
- ▶ Avoid using polluted heating media or calciferous water.

CAUTION

Hot surfaces!

Touching hot surfaces on the heating jacket and on the supply and discharge lines will cause burns.

- ▶ Wear protective equipment.
- ▶ Insulate the heating jacket and the supply and discharge lines.
- ▶ When removing insulation, observe cooling time.

Incorrect use

Non-designated use can compromise safety. The manufacturer is not liable for damage caused by improper or non-designated use.

Product safety

This device is designed in accordance with good engineering practice to meet state-of-the-art safety requirements, has been tested, and left the factory in a condition in which it is safe to operate.

The device fulfills general safety requirements and legal requirements. It also complies with the EU directives listed in the device-specific EU Declaration of Conformity.

3 Product description

3.1 Product design

The heating jacket comprises two half-shells.

3.2 Can be used for the following sensors

Option EA, "Promass E (40E**-; 80E**-; 83E**-; 8E1B**-; 8E2B**-)"

- Promass 40E
- Promass 80E
- Promass 83E
- Promass E 100, generation B
- Promass E 200, generation B

Option EB, "Promass E (8E1C**-; 8E2C**-; 8E3**-; 8E5**-)"

- Promass E 100, generation C
- Promass E 200, generation C
- Promass E 300
- Promass E 500

3.3 Availability

The accessory is optionally available to order with the measuring device.

3.3.1 Ordering with measuring device

Order code for measuring device

Different options can be ordered using order code 620 for "Accessory enclosed":

- Option RB "Heating jacket, R 1/2" internal thread"
- Option RC "Heating jacket, R 3/4" internal thread"
- Option RD "Heating jacket, NPT 1/2" internal thread"
- Option RE "Heating jacket, NPT 3/4" internal thread"

3.3.2 Upgrade without measuring device

The accessory can also be ordered separately and at a later stage without the measuring device.

Order code DK8003

Different options can be ordered using order code 020 for "Sensor":

- Option EA "Promass E (40E**-; 80E**-; 83E**-; 8E1B**-; 8E2B**-)"
- Option EB "Promass E (8E1C**-; 8E2C**-; 8E3**-; 8E5**-)"

4 Incoming acceptance and product identification

4.1 Incoming acceptance

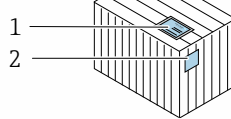
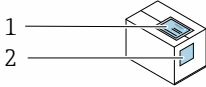

Are the order codes on the delivery note (1) and the product sticker (2) identical?

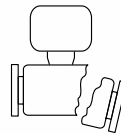
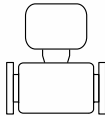
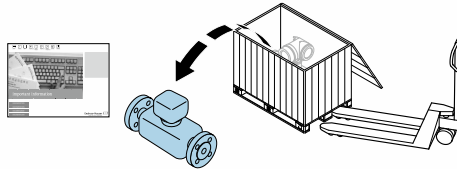

Are the goods undamaged?

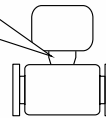
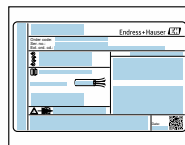

Do the nameplate data match the ordering information on the delivery note?



Is the document folder present with accompanying documents?
Is the optional CD-ROM with the Technical Documentation present?



- If one of the conditions is not satisfied, contact your Endress+Hauser Sales Center.
- Depending on the device version, the CD-ROM might not be part of the delivery! The Technical Documentation is available via the Internet or via the *Endress+Hauser Operations App*.

4.2 Product identification

The following options are available for identification of the device:

- Nameplate specifications
- Order code with breakdown of the device features on the delivery note
- Enter serial numbers from nameplates in the *W@M Device Viewer* (www.endress.com/deviceviewer): All information about the device is displayed.
- Enter the serial number from nameplates in the *Endress+Hauser Operations App* or scan the 2-D matrix code (QR code) on the nameplate using the *Endress+Hauser Operations App*: All information about the device is displayed.

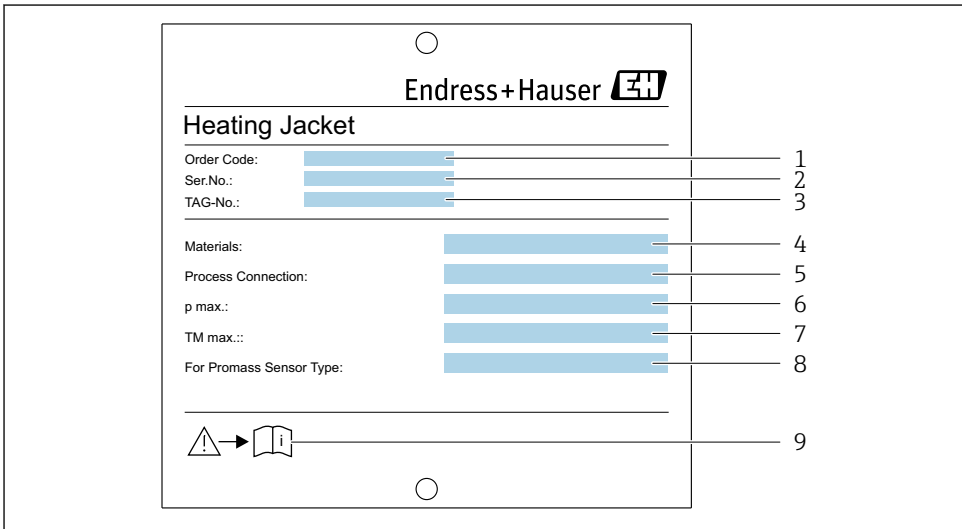

A0035574

1 Nameplate

- 1 Order code
- 2 Serial number (ser. no.)
- 3 Device tag
- 4 Material
- 5 Process connection
- 6 Maximum permitted pressure (heating fluid)
- 7 Maximum permitted temperature (heating fluid): Observe maximum permitted temperature of sensor.
- 8 Associated sensor
- 9 Approval information regarding explosion protection and document number of safety-related supplementary documentation

5 Storage and transport

5.1 Storage conditions

Observe the following notes for storage:

- ▶ Store in the original packaging to ensure protection from shock.
- ▶ Do not remove protection caps mounted on couplings. They prevent dirt from entering the pipe of the heating jacket.
- ▶ Store in a dry and dust-free place.
- ▶ Do not store outdoors.

Storage temperature: -50 to +80 °C (-58 to +176 °F)

5.2 Transporting the product

Transport the device to the measuring point in the original packaging.

- ▶ Do not remove protection caps mounted on couplings.
 - ↳ They prevent dirt from entering the pipe of the heating jacket.

5.3 Packaging disposal

All packaging materials are environmentally friendly and 100 % recyclable:

- Outer packaging of device
 - Polymer stretch film that conforms to EC Directive 2002/95/EC (RoHS)
- Packaging
 - Wooden crate treated in accordance with ISPM 15 standard, confirmed by IPPC logo
 - Cardboard box in accordance with European packaging guideline 94/62EC, recyclability confirmed by Resy symbol
- Carrying and securing materials
 - Disposable plastic pallet
 - Plastic straps
 - Plastic adhesive strips
- Filler material
 - Paper pads

6 Installation

6.1 Installation conditions

6.1.1 Mounting position

The mounting location of the heating jacket depends on the mounting location of the measuring device.



For detailed information on the mounting location, see the Operating Instructions for the measuring device.

6.1.2 Requirements from environment and process

Ambient temperature range

NOTICE

The measuring electronics will overheat if the maximum permitted ambient temperatures are not observed!

- ▶ Choose an orientation for the sensor and heating jacket that ensures that the maximum permitted ambient temperature for the measuring electronics is not exceeded.
- ▶ Depending on the version of the measuring device, observe the following ambient temperatures:

Measuring device version	Maximum ambient temperatures
Compact version	Transmitter+60 °C (+140 °F)
Remote version (standard version)	Sensor connection housing +60 °C (+140 °F) Connecting cable+105 °C (+221 °F)
Remote version for heating (neck extension for insulation)	If the maximum ambient temperature of +60 °C (+140 °F) cannot be observed when using the standard version of the measuring device.

Medium pressure range (nominal pressure)

Heating jackets for all sensors

- ▶ Medium pressure range: Observe maximum nominal pressure of 25 bar (363 psi)
→  20.

Thermal insulation

- ▶ If the heating jacket has additional insulation, observe the minimum safety distance of 20 mm (0.79 in) to the measuring device →  21.

6.2 Installing the heating jacket

NOTICE

For large nominal diameters: Risk of breakage of supply and discharge lines in case of overload!

- ▶ Due to the heavy weight involved in the case of large nominal diameters, the pipe must be supported.
- ▶ Do not use the heating system's supply and discharge lines to support the heating jacket.
- ▶ Note the weight of the measuring device: see associated Operating Instructions.

Preparing for installation

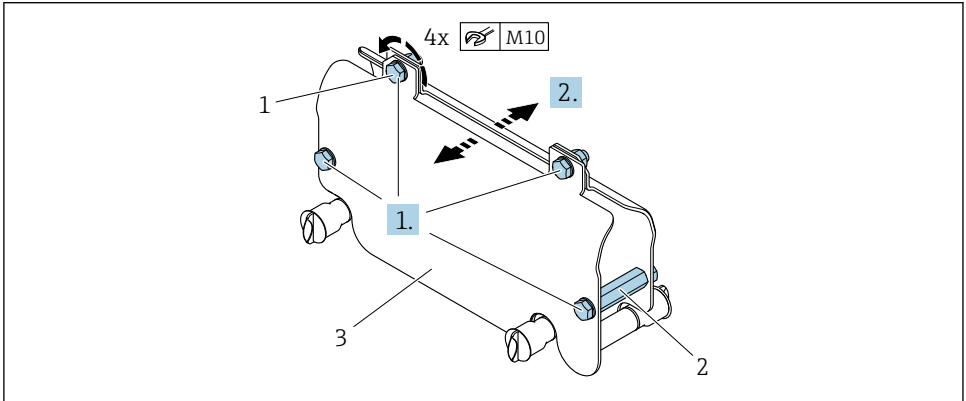

A0035575

2 Sample graphic

- 1 Fixing screws
- 2 Spacer
- 3 Half-shells

1. Release the securing screws on one side.

2. Pull the half-shells apart.

Installing the heating jacket

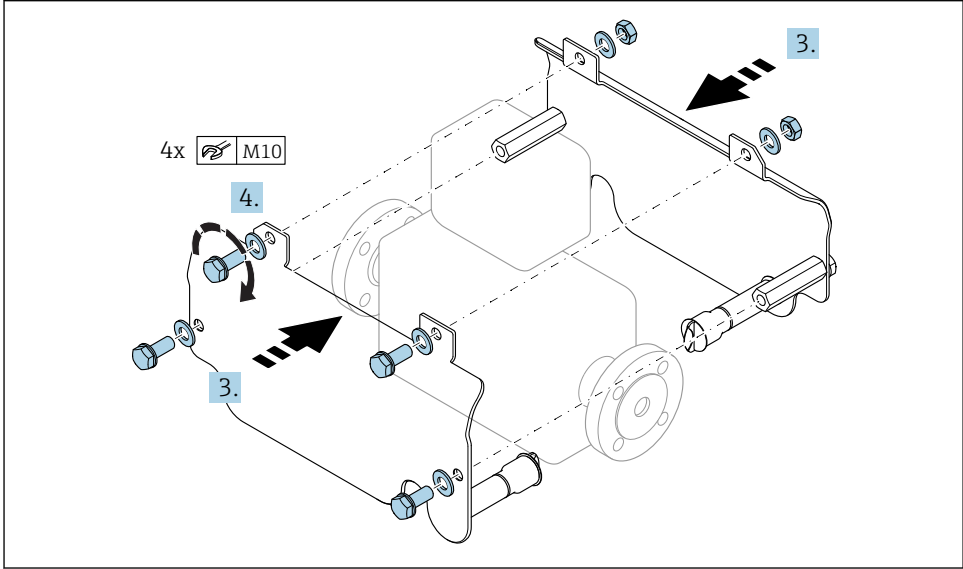

A0035576

3 Sample graphic

- 3. Place the half-shells on the sensor.
- 4. Tighten the securing screws.

6.3 Post-installation check

Is the device undamaged (visual inspection)?	<input type="checkbox"/>
Does the device comply with the measuring point specifications? For example:	<input type="checkbox"/>
▪ Ambient temperature range → 12	
▪ Measuring range pressure (nominal pressure) → 12	
▪ Flow limit → 19	
Has the correct mounting location been selected for the heating jacket → 11?	<input type="checkbox"/>
Are the measuring point identification and labeling correct (visual inspection)?	<input type="checkbox"/>
Has the maximum permitted insulation height been observed → 12? Safety distance of 20 mm (0.79 in) between customer's insulation and sensor	<input type="checkbox"/>
Is the pipe to the connections on the heating jacket positioned correctly? (connections sealed)	<input type="checkbox"/>
Is the heating jacket adequately protected against vibrations?	<input type="checkbox"/>
Is there a guaranteed flow of heating medium?	<input type="checkbox"/>

7 Connecting to the heating system

The design and calculation of a temperature-controlled heating system is based on the maximum heat requirement. The design of the pipe network is based on the permitted flow velocities of the heating media (steam, water, oil) and on losses due to pipe friction. The pump capacity and the design point are derived from the sum of all resistances in the heating system and the quantity of heating media required. Part load operation always means an increase in differential pressure in the overall system. With normal (non-regulated pumps), this effect is amplified by the increasing pump characteristic curve. In the case of regulated pumps ($D_p = \text{constant}$), the pump pressure is maintained even if the flow rate is reduced. However, due to significantly reduced pipe losses, the pump pressure transfers primarily to pipe bottlenecks or existing valves that are still open.

7.1 Connecting the heating jacket

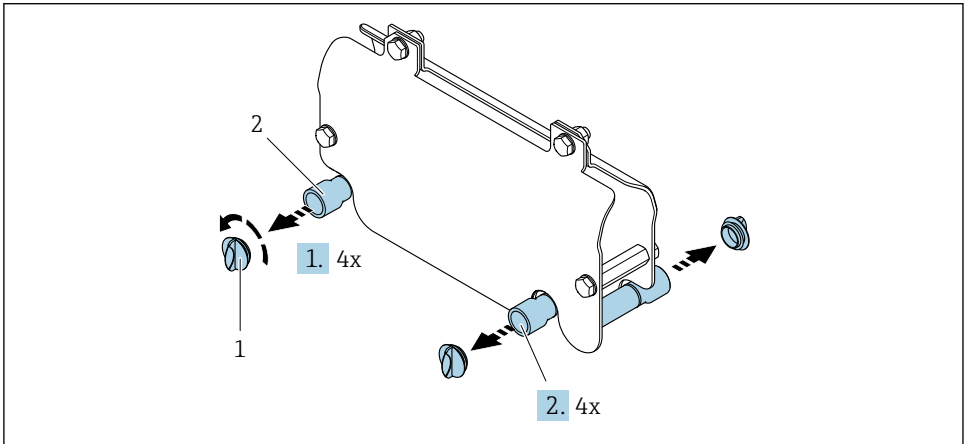

A0035577

4 Sample graphic

- 1 Protection cap
- 2 Connection for heating medium

1. Unscrew the protection caps from the connection thread.
2. Connect the system's heating system to the threaded connection of the heating jacket.

7.2 Installing the valve

When using thermal oils, high differential pressure can occur when the system starts up. This is due to the high viscosity of thermal oils at low temperatures → 20.

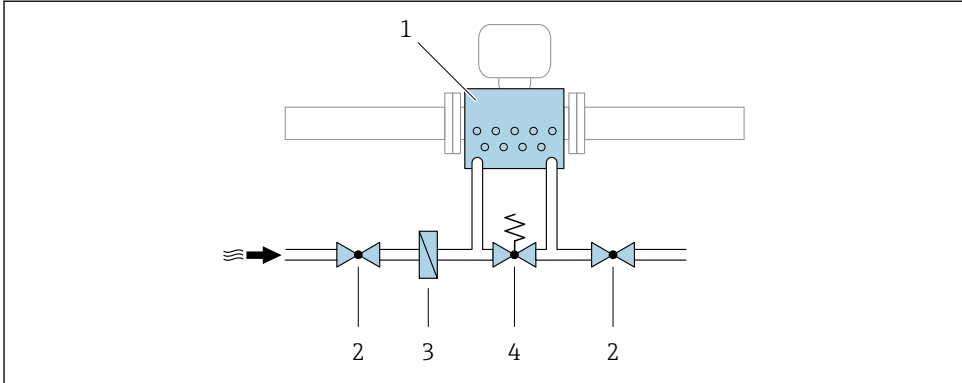

A0035579

5 Sample graphic

- 1 Heating jacket
- 2 Shut-off valve
- 3 Dirt trap
- 4 Overflow valve

1. To reduce the increase in high pressure differentials, use a differential pressure regulator or overflow valve.
2. Install an overflow valve between the infeed and return lines of the heating jacket.
 - ↳ The valve limits the delivery pressure of the circulation pump and ensures a minimum volume flow in the boiler circuit. The valve opens as soon as the delivery pressure exceeds the value configured at the valve.
3. The set pressure value must not exceed the maximum permitted nominal pressure of the heating jacket.

After the heating jacket and the oil contained therein have heated up, a pressure differential establishes itself.

8 Repair

8.1 General notes

8.1.1 Repair and conversion concept

The Endress+Hauser repair and conversion concept provides for the following:

- The measuring devices have a modular design.
- Spare parts are grouped into logical kits with the associated Installation Instructions.
- Repairs are carried out by Endress+Hauser Service or by appropriately trained customers.
- Certified devices can only be converted to other certified devices by Endress+Hauser Service or at the factory.

8.1.2 Notes for repair and conversion

For repair and modification of a measuring device, observe the following notes:

- ▶ Use only original Endress+Hauser spare parts.
- ▶ Carry out the repair according to the Installation Instructions.
- ▶ Observe the applicable standards, federal/national regulations, Ex documentation (XA) and certificates.
- ▶ Document every repair and each conversion and enter them into the *W@M* life cycle management database.

8.2 Spare parts

W@M Device Viewer (www.endress.com/deviceviewer):

All of the spare parts for the device, along with the order code, are listed here and can be ordered. If available, users can also download the associated Installation Instructions.



The serial number of the device can be found on the nameplate.

8.3 Endress+Hauser services

Endress+Hauser offers a wide range of services.



Your Endress+Hauser Sales Center can provide detailed information on the services.

8.4 Return

The measuring device must be returned if it is need of repair or a factory calibration, or if the wrong measuring device has been delivered or ordered. Legal specifications require Endress +Hauser, as an ISO-certified company, to follow certain procedures when handling products that are in contact with the medium.

To ensure safe, swift and professional device returns, please refer to the procedure and conditions for returning devices provided on the Endress+Hauser website at

<http://www.endress.com/support/return-material>

8.5 Disposal

8.5.1 Removing the measuring device

1. Switch off the device.



Danger to persons from process conditions.

- ▶ Beware of hazardous process conditions such as pressure in the measuring device, high temperatures or aggressive fluids.

2. Carry out the mounting and connection steps from the "Mounting the measuring device" and "Connecting the measuring device" sections in reverse order. Observe the safety instructions.

8.5.2 Disposing of the measuring device

WARNING

Danger to personnel and environment from fluids that are hazardous to health.

- ▶ Ensure that the measuring device and all cavities are free of fluid residues that are hazardous to health or the environment, e.g. substances that have permeated into crevices or diffused through plastic.

Observe the following notes during disposal:

- ▶ Observe valid federal/national regulations.
- ▶ Ensure proper separation and reuse of the device components.

9 Technical data

9.1 Application

The heating jacket is designed to maintain a stable temperature in the sensor.

Fluids such as:

- chocolate, condensed milk, liquid sugar
- oils, grease
- varnishes
- pharmaceuticals, catalytic converters, inhibitors
- suspensions

9.2 Environment

9.2.1 Ambient temperature range

→  12

9.3 Process

9.3.1 Pressure- temperature rating

The following diagram contains a pressure-temperature rating (reference curve) for a temperature range of -50 to $+350$ °C (-58 to $+662$ °F). However, the maximum permitted fluid temperatures are always dependent on the sensor.

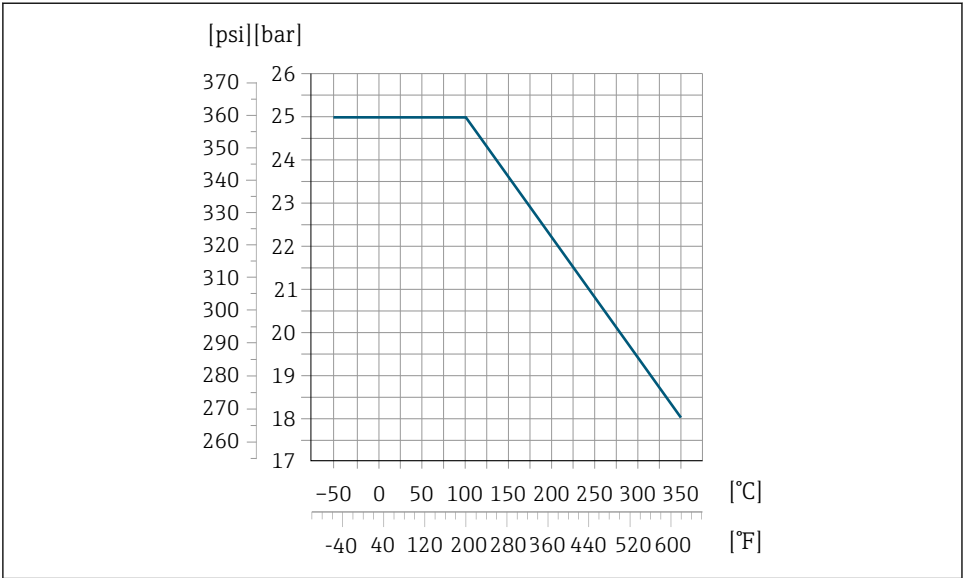

A0035588

6 Stainless steel, 1.4571/316 Ti

9.3.2 Flow limit

i Flow rate when differential pressure = 1 bar

Promass 40E, 80E, 83E, Promass E 100 (8E1B), E 200 (8E2B)

DN 8 (3/8")	400 kg/h
DN 15 (1/2")	440 kg/h
DN 25 (1")	500 kg/h
DN 40 (1 1/2")	610 kg/h
DN 50 (2")	850 kg/h

Promass E 100 (8E1C), E 200 (8E2C), Promass E 300, E 500

DN 8 (3/8")	500 kg/h
DN 15 (1/2")	500 kg/h
DN 25 (1")	800 kg/h
DN 40 (1 1/2")	650 kg/h
DN 50 (2")	950 kg/h
DN 80 (3")	1200 kg/h

9.3.3 Medium pressure range (nominal pressure)

→  12

9.3.4 Temperature range of heating medium

► Note fluid temperature range of sensor.



For detailed information on the fluid temperature range of the sensor, see the Technical Information and Operating Instructions for the measuring device.

9.3.5 Viscosity of heating medium

At 20 °C (68 °F)	0.001 to 30 mPa·s
------------------	-------------------

9.3.6 Heat transfer coefficient



Data for heat transfer coefficient without heat insulation.

Promass 40E, 80E, 83E, Promass E 100 (8E1B), E 200 (8E2B)

DN 8 (3/8")	250 °C/h
DN 15 (1/2")	235 °C/h
DN 25 (1")	220 °C/h
DN 40 (1 1/2")	180 °C/h
DN 50 (2")	100 °C/h

Promass E 100 (8E1C), E 200 (8E2C), Promass E 300, E 500

DN 8 (3/8")	440 °C/h
DN 15 (1/2")	420 °C/h
DN 25 (1")	470 °C/h
DN 40 (1 1/2")	630 °C/h
DN 50 (2")	500 °C/h
DN 80 (3")	250 °C/h

9.3.7 Vibrations

Acceleration up to 2 g based on IEC 68-2-6

9.4 Mechanical construction

9.4.1 Dimensions in SI units

Heating jacket

Promass 40E, 80E, 83, E 100 (8E1B), E 200 (8E2B)

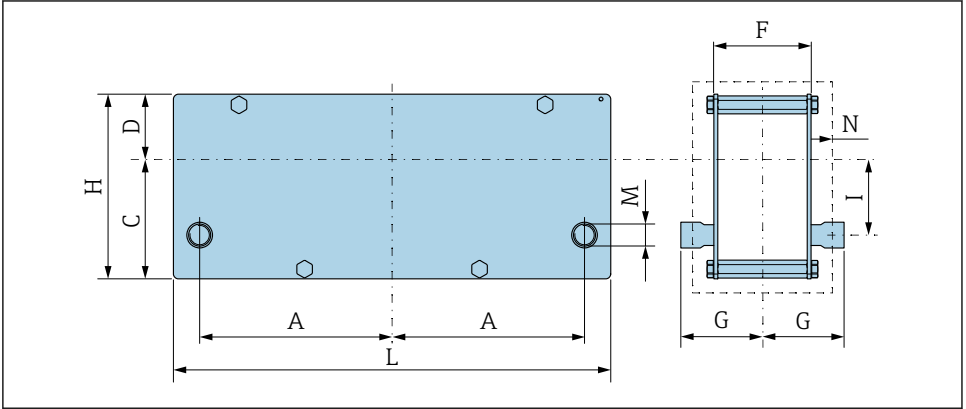

A0035796

7 Sample graphic

M Dependent on adapter → 23

N Dependent on customer's insulation thickness

DN [mm]	Adapter	A [mm]	C [mm]	D [mm]	F [mm]	G [mm]	H [mm]	I [mm]	L [mm]
8	R½	50	103	48	62	65	150	64	146
15	R½	70	111	50	62	65	160	79	189
25	R½	95	116	55	62	65	170	73	240
40	R½	141	130	61	76	72	190	85	336
50	R¾	184.25	179	77	96	84	255	127	430
80	 For the dimensions → 22								

Promass E 100 (8E1C), E 200 (8E2C), E 300, E 500

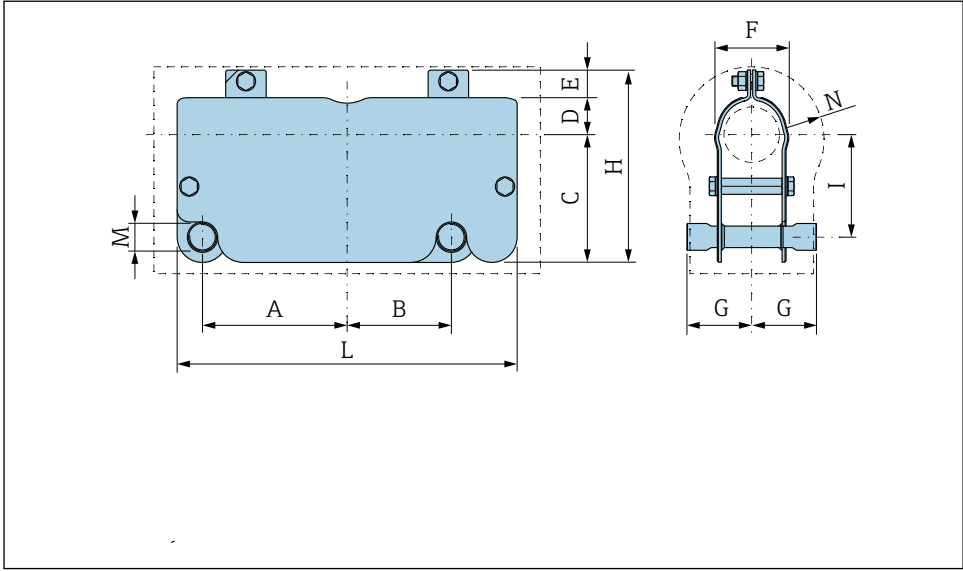

A0035581

8 Sample graphic

M Dependent on adapter → 23

N Dependent on customer's insulation thickness

DN [mm]	Adapter	A [mm]	B [mm]	C [mm]	D [mm]	E [mm]	F [mm]	G [mm]	H [mm]	I [mm]	L [mm]
8 to 15	R½	60	20	136	23.9	28.1	53.2	54	188	111	170
25	R½	96	56	125	26.9	25.1	60	52	177	100	242
40	R½	143	103	130	32.9	27.1	73.5	64	190	105	336
50	R¾	177.5	125	180	50	25	101	75.5	255	147.5	420
80	R¾	201.5	149	200	69	26	137.4	96.5	295	167.5	468

Connecting the heating medium

Flange adapter

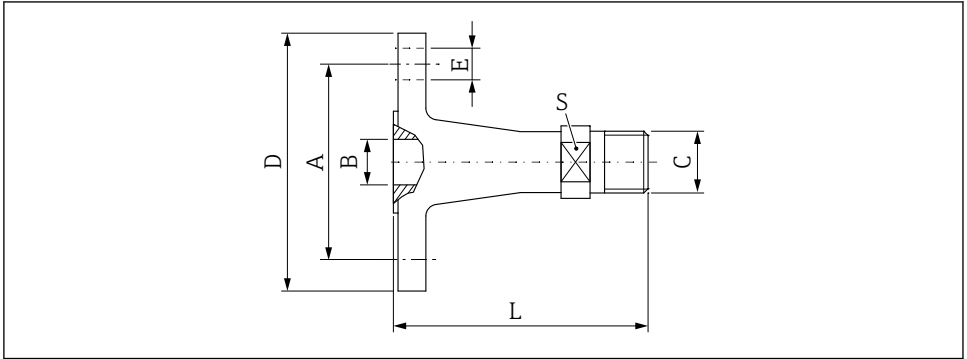

A0035586

Flange according to ASME B16.5
Stainless steel, 1.4404/316L/316
Order code for "Heating medium connection", option RF/RG

Pressure rating	A [mm]	B [mm]	C ¹⁾	D [mm]	E [mm]	L [mm]	S
Class 150	60.5	15.7	R½	88.9	4 × Ø 15.7	87.8	21 AF (7/8 AF)
	60.5	15.7	R¾	88.9	4 × Ø 15.7	87.8	
Class 300	66.5	15.7	R½	95.2	4 × Ø 15.7	92.3	
	66.5	15.7	R¾	95.2	4 × Ø 15.7	92.3	

1) DIN EN ISO 7/1

Flange according to EN1092-1-B1
Stainless steel, 1.4404/316L/316
Order code for "Heating medium connection", option RH

Pressure rating	A [mm]	B [mm]	C ¹⁾	D [mm]	E [mm]	L [mm]	S
PN 40	65	17.3	R½	95	4 × Ø 14	78	21 AF (7/8 AF)
	65	17.3	R¾	95	4 × Ø 14	78	

1) DIN EN ISO 7/1

NPT adapter

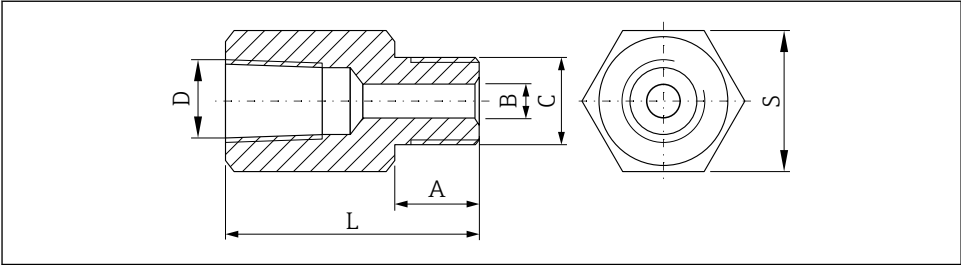

A0035585

Stainless steel ,1.4404/316
 Order code for "Heating medium connection", option RB/RC/RD/RE

A [mm]	B [mm]	C ¹⁾	D	L [mm]	S
19.1	11.9	R½	½	49.3	1 1/16 AF (27 AF)
19.1	15.7	R¾	¾	51.3	1 15/16 AF (33 AF)

1) DIN EN ISO 7/1

9.4.2 Dimensions in US units

Heating jacket

Promass 40E, 80E, 83, E 100 (8E1B), E 200 (8E2B)

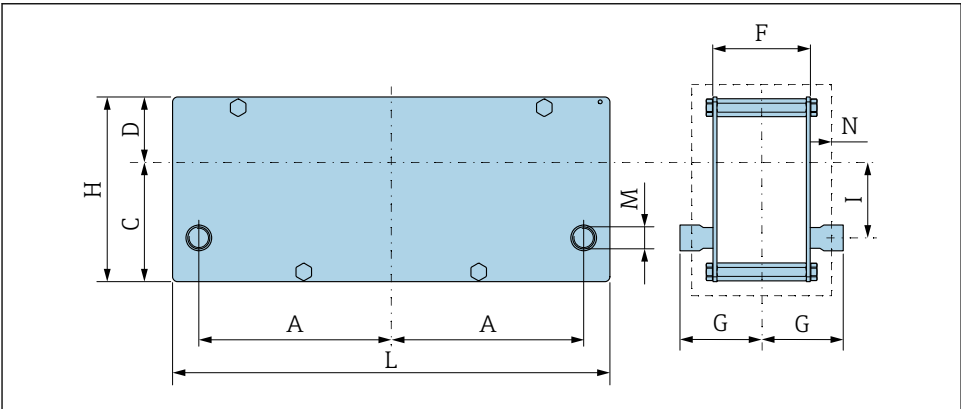



A0035796

9 Sample graphic

M Dependent on adapter → 26

N Dependent on customer's insulation thickness

DN [in]	Adapter	A [in]	C [in]	D [in]	F [in]	G [in]	H [in]	I [in]	L [in]
3/8	R1/2	50	103	48	62	65	150	64	146
1/2	R1/2	70	111	50	62	65	160	79	189
1	R1/2	95	116	55	62	65	170	73	240
1 1/2	R1/2	141	130	61	76	72	190	85	336
2	R3/4	184.25	179	77	96	84	255	127	430
3	 For the dimensions →  25								

Promass E 100 (8E1C), E 200 (8E2C), E 300, E 500

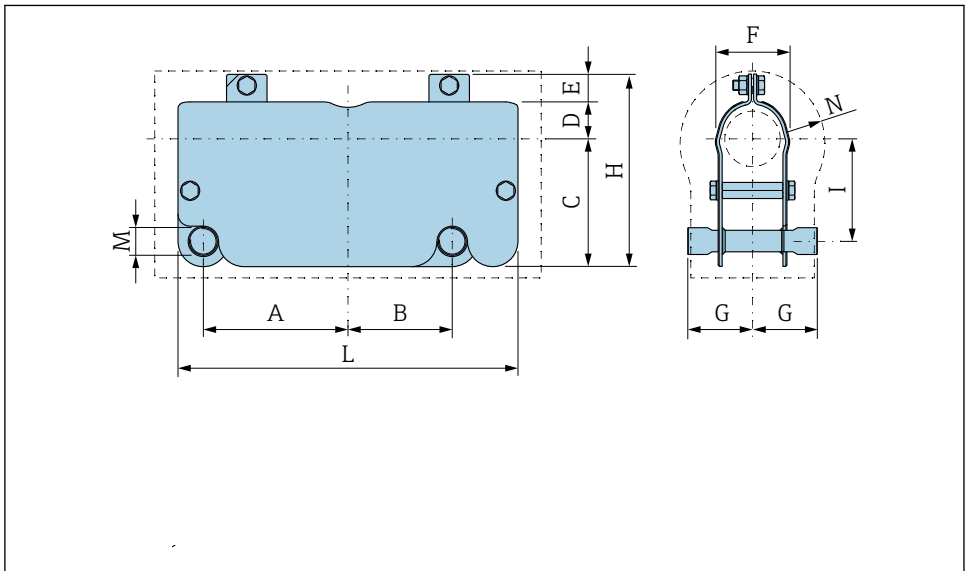

A0035581

 10 Sample graphic

M Dependent on adapter →  26

N Dependent on customer's insulation thickness

DN [in]	Adapter	A [in]	B [in]	C [in]	D [in]	E [in]	F [in]	G [in]	H [in]	I [in]	L [in]
3/8 ... 1/2	R1/2	2.36	0.79	5.35	0.94	1.11	2.09	2.13	7.4	4.37	6.69
1	R1/2	3.78	2.2	4.92	1.06	0.99	2.36	2.05	6.97	3.94	9.53
1 1/2	R1/2	5.63	4.06	5.12	1.3	1.07	2.89	2.52	7.48	4.13	13.23

DN [in]	Adap- ter	A [in]	B [in]	C [in]	D [in]	E [in]	F [in]	G [in]	H [in]	I [in]	L [in]
2	R $\frac{3}{4}$	6.99	4.92	7.09	1.97	0.98	3.98	2.97	10.04	5.81	16.54
3	R $\frac{3}{4}$	7.93	5.87	7.87	2.72	1.02	5.41	3.8	11.61	6.59	18.43

Connecting the heating medium

Flange adapter

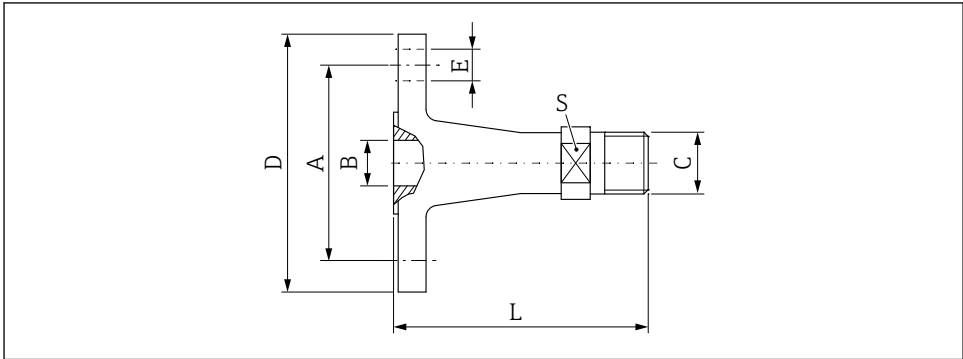

A0035586

Flange according to ASME B16.5
Stainless steel, 1.4404/316L/316
Order code for "Heating medium connection", option RF/RG

Pressure rating	A [in]	B [in]	C ¹⁾	D [in]	E [in]	L [in]	S
Class 150	2.38	0.62	R $\frac{1}{2}$	3.5	4 × Ø 0.62	3.46	7/8 AF
	2.38	0.62	R $\frac{3}{4}$	3.5	4 × Ø 0.62	3.46	
Class 300	2.62	0.62	R $\frac{1}{2}$	3.75	4 × Ø 0.62	3.63	7/8 AF
	2.62	0.62	R $\frac{3}{4}$	3.75	4 × Ø 0.62	3.63	

1) DIN EN ISO 7/1

Flange according to EN1092-1-B1 Stainless steel, 1.4404/316L/316 Order code for "Heating medium connection", option RH							
Pressure rating	A [in]	B [in]	C ¹⁾	D [in]	E [in]	L [in]	S
PN 40	2.56	0.68	R½	3.74	4 × Ø 0.55	3.07	7/8 AF
	2.56	0.68	R¾	3.74	4 × Ø 0.55	3.07	

1) DIN EN ISO 7/1

NPT adapter

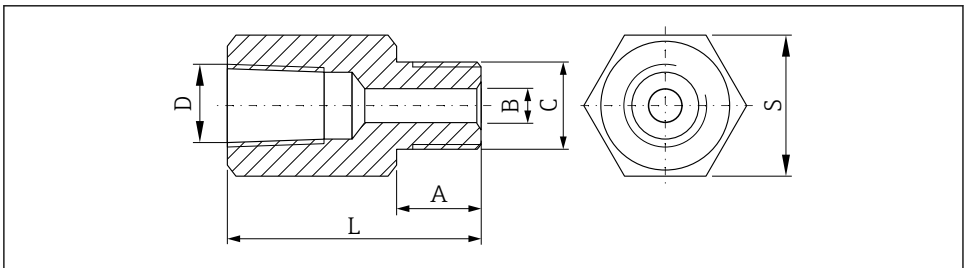

A0035585

Stainless steel, 1.4404/316 Order code for "Heating medium connection", option RB/RC/RD/RE					
A [in]	B [in]	C ¹⁾	D	L [in]	S
0.75	0.47	R½	½	1.94	1 1/16 AF
0.75	0.62	R¾	¾	2.02	1 15/16 AF

1) DIN EN ISO 7/1

9.4.3 Weight

Weight in SI units



Weight and volume specifications per half-shell.

Promass 40E, 80E, 83, E 100 (8E1B), E 200 (8E2B)

DN [mm]	Weight [kg]	Volume [l]
8	0.6	0.05
15	1	0.05

DN [mm]	Weight [kg]	Volume [l]
25	1.3	0.1
40	2	0.15
50	3.5	0.2
80	5	0.3

Promass E 100 (8E1C), E 200 (8E2C), E 300, E 500

DN [mm]	Weight [kg]	Volume [l]
8 to 15	1.1	0.05
25	1.5	0.1
40	2.1	0.15
50	3.7	0.2
80	5	0.3

Weight in US units



Weight and volume specifications per half-shell.

Promass 40E, 80E, 83, E 100 (8E1B), E 200 (8E2B)

DN [in]	Weight [lb]	Volume [gal]
$\frac{3}{8}$	1.32	0.01
$\frac{1}{2}$	2.21	0.01
1	2.87	0.03
$1\frac{1}{2}$	4.41	0.03
2	7.72	0.05
3	11.02	0.08

Promass E 100 (8E1C), E 200 (8E2C), E 300, E 500

DN [in]	Weight [lb]	Volume [gal]
$\frac{3}{8}$... $\frac{1}{2}$	2.43	0.01
1	3.31	0.03
$1\frac{1}{2}$	4.63	0.04

DN [in]	Weight [lb]	Volume [gal]
2	8.16	0.05
3	11.02	0.08

9.4.4 Materials

Heating jacket housing	Stainless steel, 1.4571 (316Ti)
Flange adapter	Stainless steel, 1.4404/316L/316
NPT adapter	Stainless steel ,1.4404/316

9.5 Certificates and approvals

9.5.1 Pressure Equipment Directive

Devices not bearing this marking (PED) are designed and manufactured according to good engineering practice. They comply with the requirements of Art. 4 Para. 3 of the Pressure Equipment Directive 2014/68/EU.

www.addresses.endress.com
