

# Technical Information

## Fieldgate PAM SFG600

### HART via PROFINET



#### Application

The Fieldgate PAM SFG600 enables device configuration for HART devices in PROFINET systems with Siemens ET200SP HART remote I/O assemblies. A central access point for mobile Plant Asset Management clients enables speedy maintenance of field devices. The user can connect to the devices quickly and easily, without having to scan or configure the network. The device allows up to 10 operators, each with a Field Xpert SMT70 tablet PC, to simultaneously access up to 1024 HART devices in a single PROFINET segment of the system. The device information and configurations are freely accessible via the respective DTMs independently of the controller.

#### Your benefits









- Industrial, robust and fully configured Fieldgate.
- Easy to connect via Plug & Play.
- Network complexity is not apparent due to fully automatic network scan for all HART devices connected to the Siemens ET200SP in PROFINET systems.
- When used in conjunction with the Field Xpert SMT70 tablet PC, it's as straightforward as if the device were right in front of you and directly connected to the tablet, even in larger industrial plants.
- In combination with the Field Xpert SMT70 tablet PC, the device offers a unique, open, FDT-based PAM system for HART via PROFINET with Siemens ET200SP remote I/O assemblies (no vendor lock-in).
- Provides access for entire maintenance teams with up to ten mobile operators and up to 1024 HART devices in a single PROFINET segment of a system.

## Table of contents

<b>Document information</b> . . . . .	<b>3</b>	<b>Registered trademarks</b> . . . . .	<b>10</b>
Symbols for certain types of information . . . . .	3		
<b>Function and system design</b> . . . . .	<b>3</b>		
Function . . . . .	3		
System design . . . . .	4		
Communication and data processing . . . . .	5		
<b>Power supply</b> . . . . .	<b>5</b>		
Terminal assignment . . . . .	5		
Device plugs available . . . . .	5		
Supply voltage . . . . .	5		
Battery . . . . .	5		
Power supply failure . . . . .	5		
Overvoltage protection . . . . .	5		
<b>Performance characteristics</b> . . . . .	<b>5</b>		
Hardware . . . . .	5		
<b>Installation</b> . . . . .	<b>6</b>		
<b>Environment</b> . . . . .	<b>7</b>		
Ambient temperature range . . . . .	7		
Storage temperature . . . . .	7		
Transportation temperature . . . . .	7		
Humidity . . . . .	7		
Degree of protection . . . . .	7		
Vibration resistance . . . . .	7		
Shock resistance . . . . .	7		
Electromagnetic compatibility (EMC) . . . . .	7		
<b>Mechanical construction</b> . . . . .	<b>8</b>		
Design, dimensions . . . . .	8		
Weight . . . . .	8		
Material . . . . .	8		
<b>Operability</b> . . . . .	<b>9</b>		
System integration . . . . .	9		
Service interface . . . . .	9		
<b>Certificates and approvals</b> . . . . .	<b>9</b>		
CE mark . . . . .	9		
UL . . . . .	9		
CCC . . . . .	9		
<b>Ordering information</b> . . . . .	<b>9</b>		
Scope of delivery . . . . .	9		
<b>Accessories</b> . . . . .	<b>9</b>		
<b>Documentation</b> . . . . .	<b>10</b>		
Fieldgate PAM SFG600 . . . . .	10		
Field Xpert SMT70 . . . . .	10		

## Document information

### Symbols for certain types of information

Symbol	Meaning
	<b>Permitted</b> Procedures, processes or actions that are permitted.
	<b>Preferred</b> Procedures, processes or actions that are preferred.
	<b>Forbidden</b> Procedures, processes or actions that are forbidden.
	<b>Tip</b> Indicates additional information.
	Reference to documentation.
	Reference to page.
	Reference to graphic.
	Visual inspection.

## Function and system design

 The Fieldgate PAM SFG600 can only be used as a client with the Field Xpert SMT70 tablet PC. For detailed information, contact the Sales Center at [www.addresses.endress.com](http://www.addresses.endress.com) or [www.endress.com/smt70](http://www.endress.com/smt70)

### Function

The Fieldgate PAM SFG600 is a device configuration management gateway and supports HART devices via PROFINET networks. The HART devices must have a unique device TAG. The devices must be in operation with a PROFINET controller and operated via the Siemens assembly ET200SP IM 155-6PN HF with the 4x1 2-wire HART analog modules with HART capabilities. During production, the Fieldgate PAM SFG600 is configured with the IP address supplied by the customer at the field network interface, and connected to the PROFINET. The second interface for the plant network with the PAM clients is also preconfigured with a fixed IP address or by DHCP assignment, and connected accordingly to a free switch port in the plant network. The IP addresses are determined by the customer when ordering.

The Fieldgate PAM SFG600 automatically starts scanning at the PROFINET port. All HART devices are then accessible with the Field Xpert SMT70 tablet PC. If tags are changed or new devices added, the Fieldgate must be switched on and off or reset in order to initiate a new scan to take account of the changed network topology. Other configuration tools shall not access the plant in parallel. The Fieldgate PAM SFG600 uses sequencing only when accessed by Field Xpert SMT70 tablet PCs connected at the same time. The duration of the scan is influenced by the size of the network as well as the number of devices. Since all devices communicate via the HART protocol, this procedure can take up to several hours in larger networks. For example, the scan takes just under three minutes in the case of two Siemens ET200SP with four or three HART-analog assemblies and 15 of the 28 HART devices that can be connected. A third service interface should be connected to an internet access point (proxy-free) only if requested by Endress+Hauser Service for the purpose of remote service, if required.

 For detailed information on "Configuration settings for Field Xpert SMT70", see the Operating Instructions. →  10

## System design

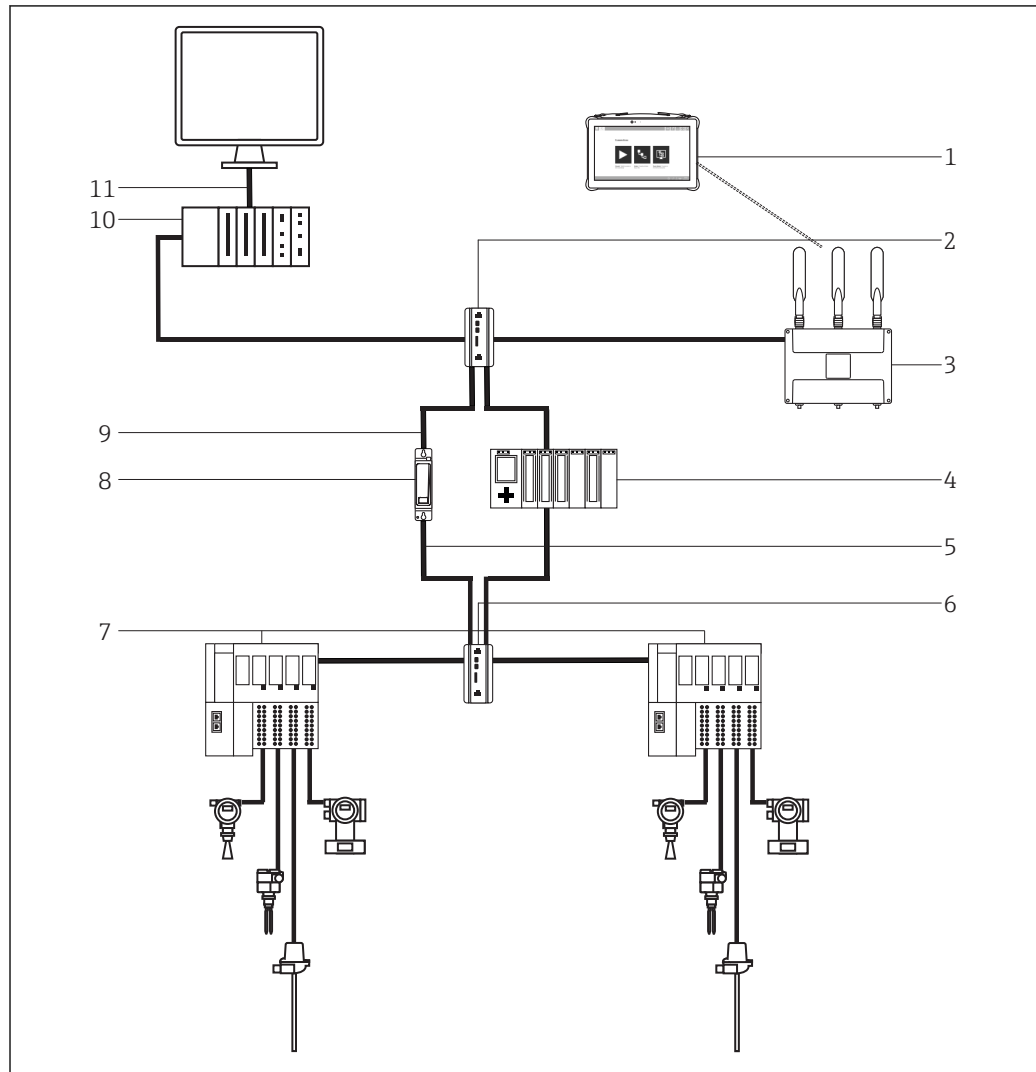

1 Network architecture

- 1 Field Xpert SMT70 tablet PC
- 2 Switch
- 3 Wireless router
- 4 PROFINET controller
- 5 PROFINET segment ETH1
- 6 PROFINET switch
- 7 Siemens ET200SP IM 155-6PN HF
- 8 Fieldgate PAM SFG600
- 9 Plant network PAM Client ETH2
- 10 Firewall
- 11 Office network

**Communication and data processing**

Ethernet	3 x 10/100/1000 MBit/s
----------	------------------------

**Power supply****Terminal assignment**

Pin 1	+
Pin 2	Functional ground
Pin 3	-

**Device plugs available**

RJ45

**Supply voltage**

Voltage	24 V <sub>DC</sub> ±25 %, SELV
Current	5.5 A
switch-on current	max. 60 A for < 300 µs
Power	45.9 W

**Battery**

Replaceable lithium battery

Type	Lithium battery
Voltage	3 V
Power	950 mAh
Operating life	4 years

**Power supply failure**

No

**Overvoltage protection**

According to EN 61131-2 II

**Performance characteristics****Hardware**

CPU	Intel Core i5 processor 7300U 2.6 GHz Dual Core
Storage	SO-DIMM DDR4, 8 192 MByte CFast 64 GByte MLC
Connections	1x Ethernet PROFINET RJ45 (ETH1) 1x Ethernet PAM Client RJ45 (ETH2) 1x Ethernet service RJ45 (IF Option 2)

## Installation

**i** When installing the Fieldgate PAM SFG600, take into account the space required for air circulation as well as additional space for operating and maintaining the device.

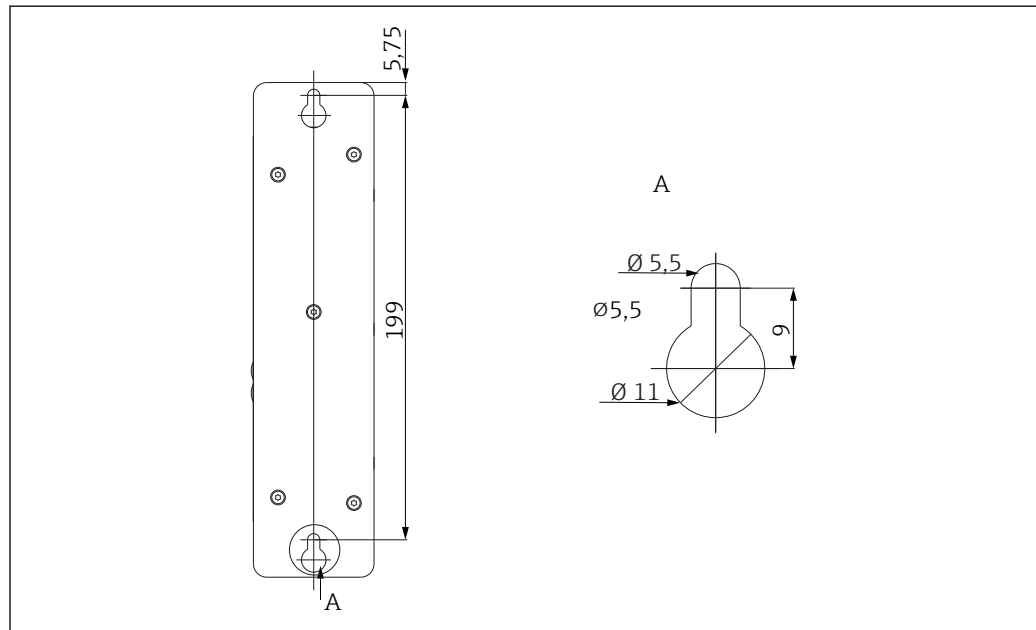

**2** Drill template

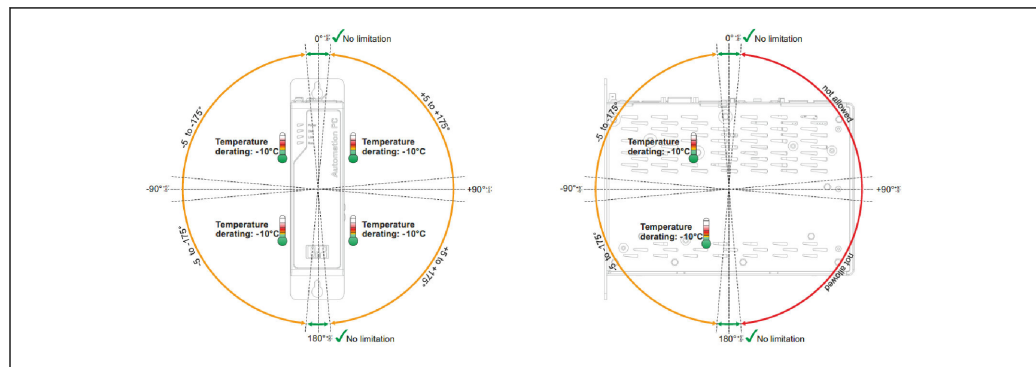

**3** Rear of mounting plate

## Environment

---

<b>Ambient temperature range</b>	0 to 50 °C (32 to 122 °F)
<b>Storage temperature</b>	-20 to 60 °C (-4 to 140 °F)
<b>Transportation temperature</b>	-20 to 60 °C (-4 to 140 °F)
<b>Humidity</b>	5 to 85 %
<b>Degree of protection</b>	IP20
<b>Vibration resistance</b>	2 to 9 Hz 1.75 mm Amplitude 9 to 200 Hz: 0.5 g
<b>Shock resistance</b>	15 g, 11 ms
<b>Electromagnetic compatibility (EMC)</b>	<ul style="list-style-type: none"><li>■ EN 61131-2:2007</li><li>■ EN 61000-6-2: 2005</li><li>■ EN 61000-6-4: 2007</li></ul>

---

# Mechanical construction

**Design, dimensions**

221.5 mm · 54 mm · 248.3 mm (8.72 in · 2.12 in · 9.77 in)

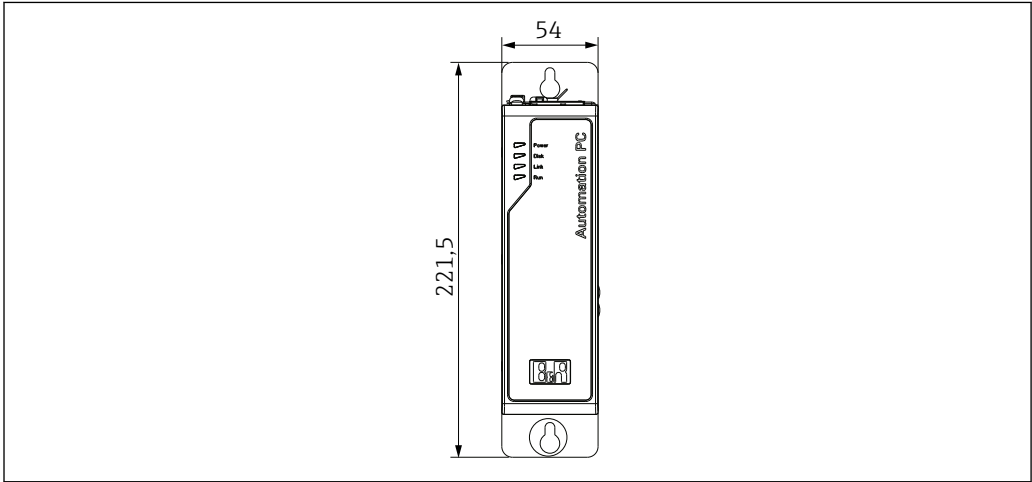

4 Front view

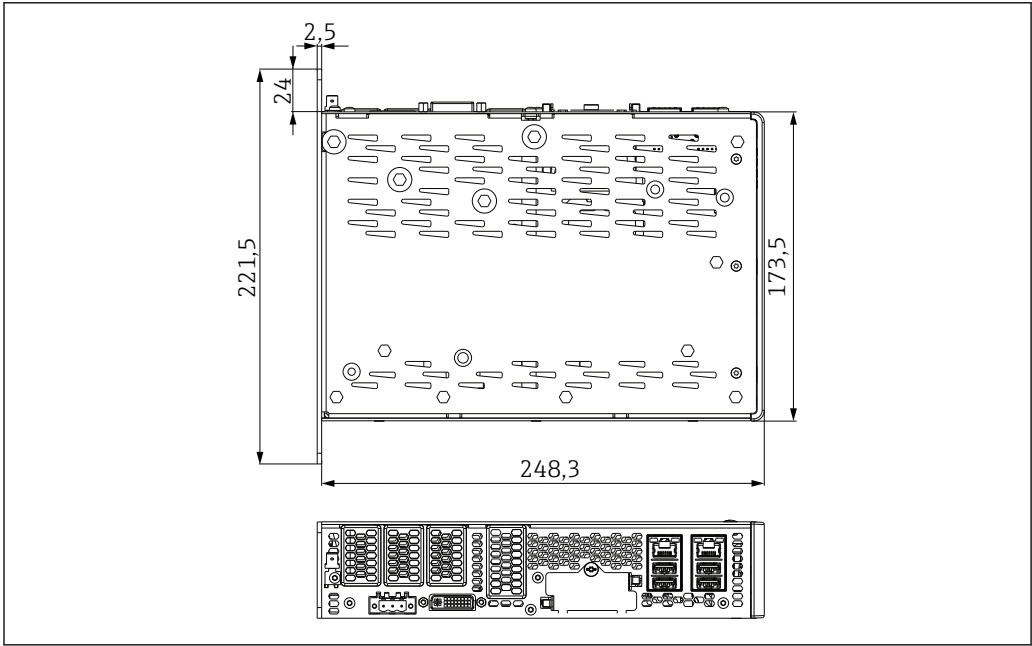

5 Side view

**Weight** 1.43 kg (3.15 lb)

**Material** Housing: steel



## Operability

### System integration

The Siemens ET200SP does not allow parallel access by a second PROFINET supervisor (parallel operation of the Siemens PDM is not possible). At least one Field Xpert SMT70 tablet PC must be configured as the gateway with the IP address of the "ETH2 PAM Client" connection. The HART devices must have unique TAGs, and the PROFINET controller must be in operation. The free PROFINET IP address configured for the "ETH1 PROFINET" connection must be connected to a free port of a PROFINET switch.

#### *PROFINET remote I/Os*

PROFINET remote I/O	Firmware Version
Siemens ET200SP IM155-6PN HF Order code: 6ES7 155-6AU00-0CNO	V3.1.0
	V3.3.0

#### *HART module with Siemens ET200SP IM 155-6PN HF*

HART module	Firmware Version
Module 4xI 2-wire HART Order code: 6ES7 134-6TD00-0CA1	V1.0.0
	V1.0.1

### Service interface

IF Option 2, RJ45 DHCP client configured. Do not connect to a network that has access to the internet (proxy-free) for remote service unless requested by Endress+Hauser Service.

## Certificates and approvals

### CE mark

The Fieldgate PAM SFG600 meets the legal requirements of the relevant EU directives. The manufacturer has affixed the CE mark as confirmation that the Fieldgate PAM SFG600 has been successfully tested.

### UL

The Fieldgate PAM SFG600 meets the legal requirements. The manufacturer has affixed the UL mark as confirmation that the Fieldgate PAM SFG600 has been successfully tested.

### CCC

The Fieldgate PAM SFG600 meets the legal requirements. The manufacturer has affixed the CCC mark as confirmation that the Fieldgate PAM SFG600 has been successfully tested.

## Ordering information

For detailed information on the product structure, contact the sales center at [www.addresses.endress.com](http://www.addresses.endress.com) or [www.endress.com/sfg600](http://www.endress.com/sfg600)

### Scope of delivery

The scope of delivery comprises:  
Fieldgate PAM SFG600

## Accessories

Plug24 V<sub>DC</sub>

## Documentation

---

**Fieldgate PAM SFG600** Brief Operating Instructions KA01400S/04/EN

---

**Field Xpert SMT70**

- Technical Information TI01342S/04/EN
- Operating Instructions BA01709S/04/EN

## Registered trademarks

Intel® Core™ is a registered trademark of Intel Corporation, Santa Clara, USA.

SIMATIC is a registered trademark of Siemens Aktiengesellschaft, Munich/Germany.

HART® is the registered trademark of the FieldComm Group, Austin, TX 78759, USA.

PROFINET® is a registered trademark of the PROFIBUS User Organization, Karlsruhe/Germany.

All other brand and product names are trademarks or registered trademarks of the companies and organizations in question.

---

[www.addresses.endress.com](http://www.addresses.endress.com)

---