



Level



Pressure



Flow



Temperature



Liquid  
Analysis



Registration



Systems  
Components



Services



Solutions

Instruções de operação

# Nivotester FTW325

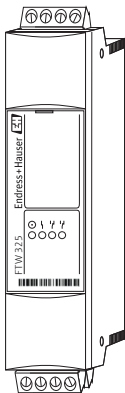

pt - Chave de nível pontual  
com circuito de sinal intrinsecamente seguro

KA00199F/38/PT/15.15  
71454199

Endress+Hauser   
People for Process Automation

pt - Conteúdo	2
Notas sobre a segurança	4
Identificação do equipamento	6
Sistema de medição	8
Instalação	9
Conexão	12
Configuração	15
Função mestre-escravo	25
Calibração	26
Teste de função	28
Exemplos para instalação e configuração	29
Solução de problemas	42
Documentação complementar	47

pt - Notas sobre a segurança

O Nivotester FTW325 só poder ser usado como um transmissor de medição condutivo.

Caso seja utilizado incorretamente, é possível surgir riscos associados à aplicação.

O equipamento pode ser instalado, conectado, comissionado, operado e mantido **somente por pessoas qualificadas e autorizadas**, sob rígida obediência a estas instruções de operação, todas as normas relevantes, especificações legais e, quando aplicável, o certificado.

Use somente ferramentas isoladas!

Use somente peças originais!

pt - Identificação

As seguintes opções estão disponíveis para a identificação do medidor:

- Especificações da etiqueta de identificação
- O código do pedido do recurso do equipamento com avaria é apresentado na nota de entrega



Dica



Permitido



Proibido



Inspeção visual

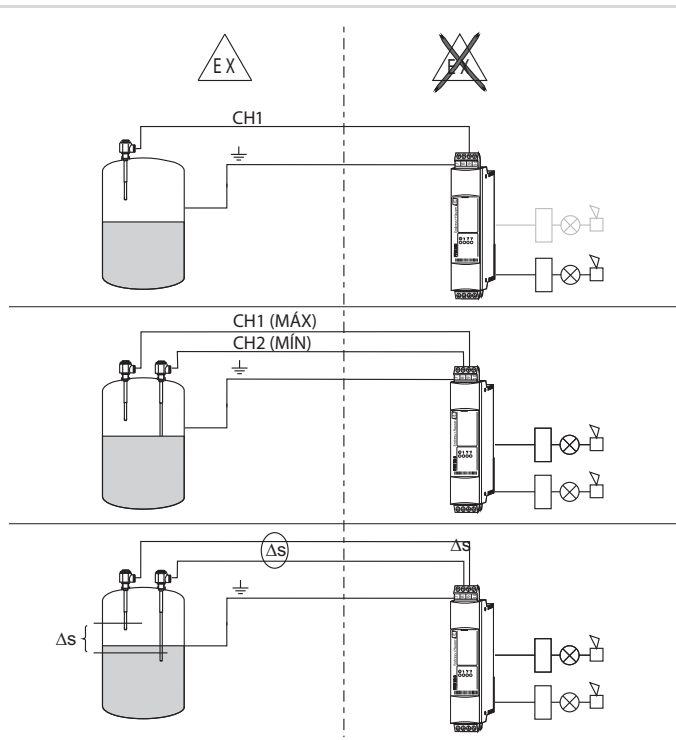

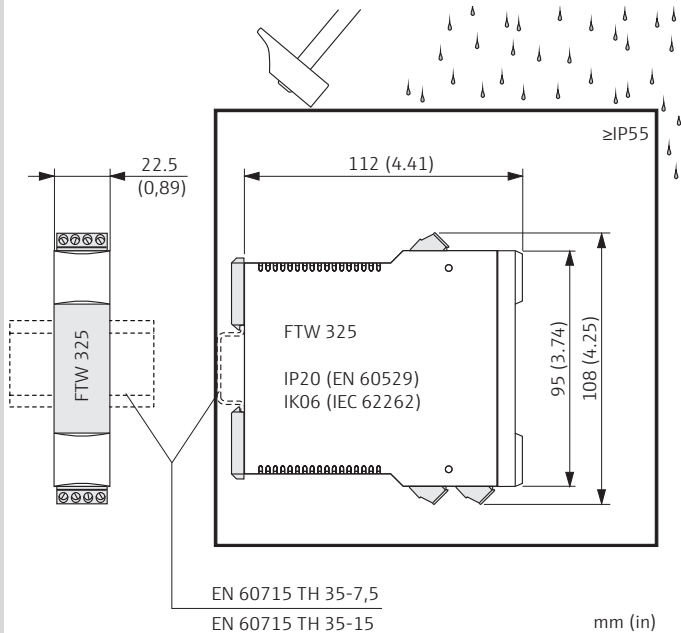

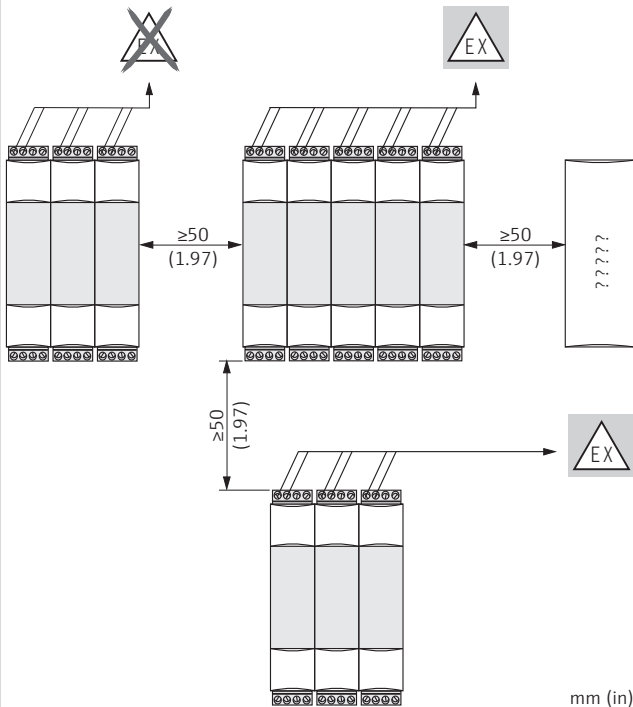

pt - A: Montagem do trilho

B: Desmontagem

1. Remova o borne

2. Remova a unidade

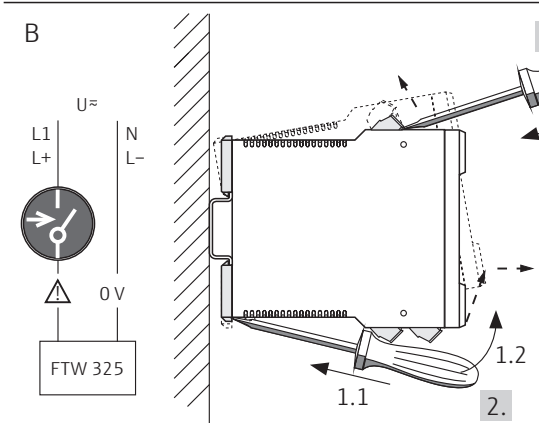
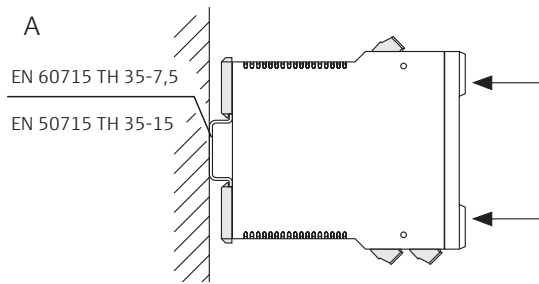

Anote a placa de identificação!

N L1  $U \sim 85 \dots 253 \text{ V (AC)}$   
50/60 Hz

L- L+  $U = 20 \dots 60 \text{ V (DC)}$

N L1  $U \sim 20 \dots 30 \text{ V (AC)}$   
50/60 Hz

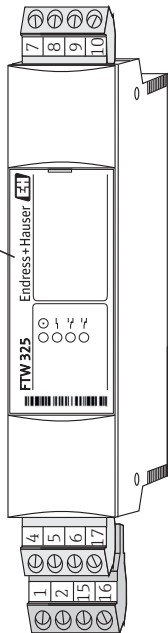

pt - Conexão  
Disposição do terminal  
fonte de alimentação

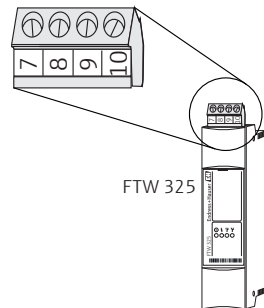
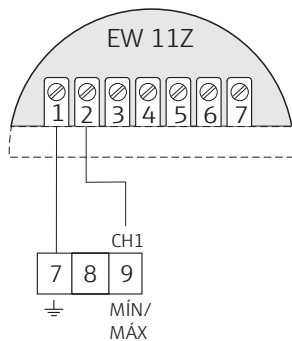
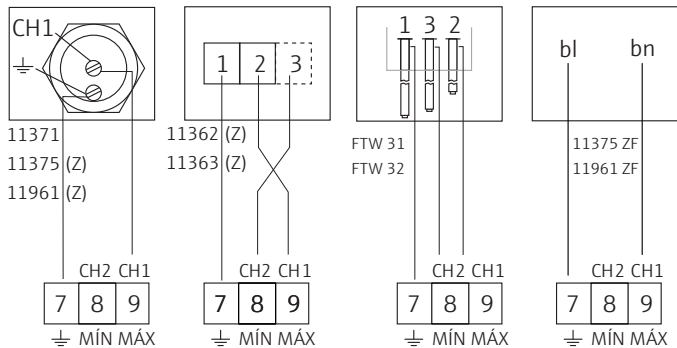



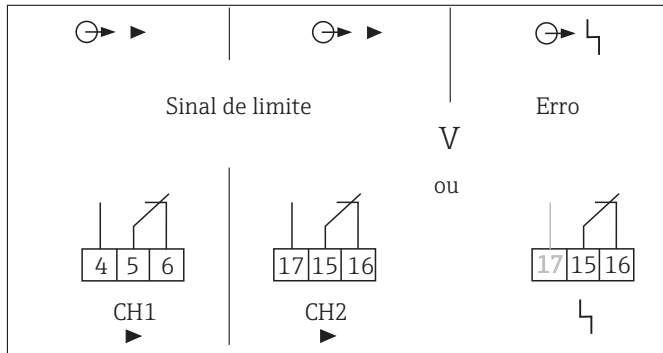

$U_{\sim}$  máx. 250 V (AC)  
 $I_{\sim}$  máx. 2 A (AC)  
 $P_{\sim}$  máx. 500 VA /  $\cos \varphi \geq 0,7$   
 $U_{\rightleftharpoons}$  máx. 40 V (DC)  
 $I_{\rightleftharpoons}$  máx. 2 A (DC)  
 $P_{\rightleftharpoons}$  máx. 80 W

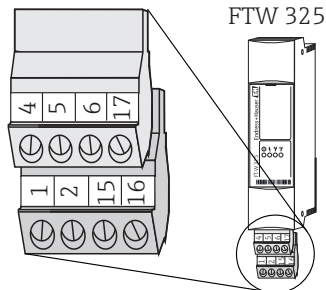

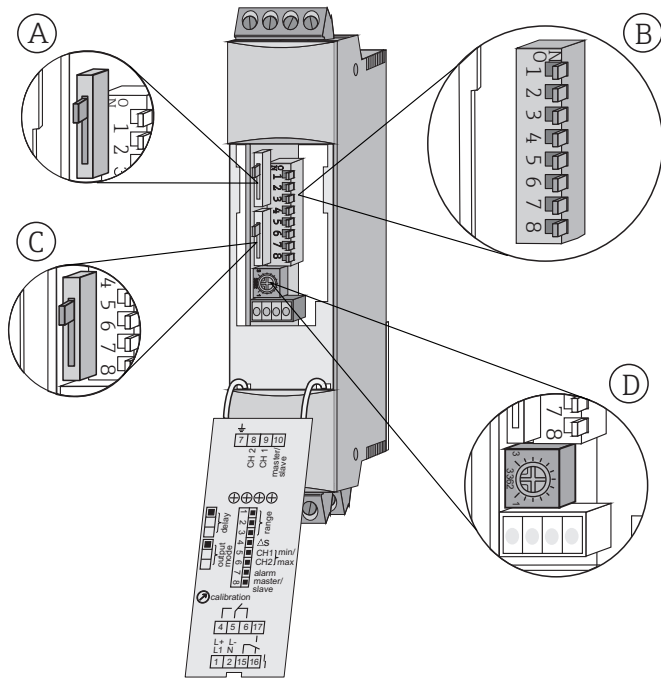

Sinais de luz:

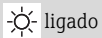

ligado



desligado

pt - Configuração do atraso de  
comutação  
5,0 s (topo)  
3,0 s (centro)  
0,5 s (base)

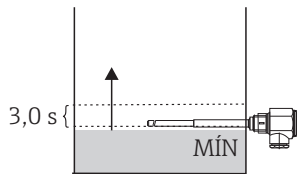
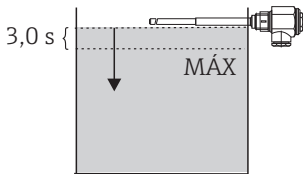
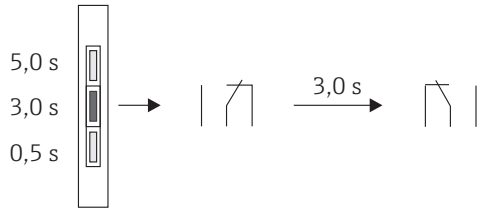
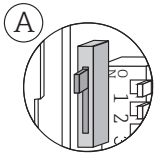

pt - Modo de operação da  
segunda saída do relé  
Nível ou alarme

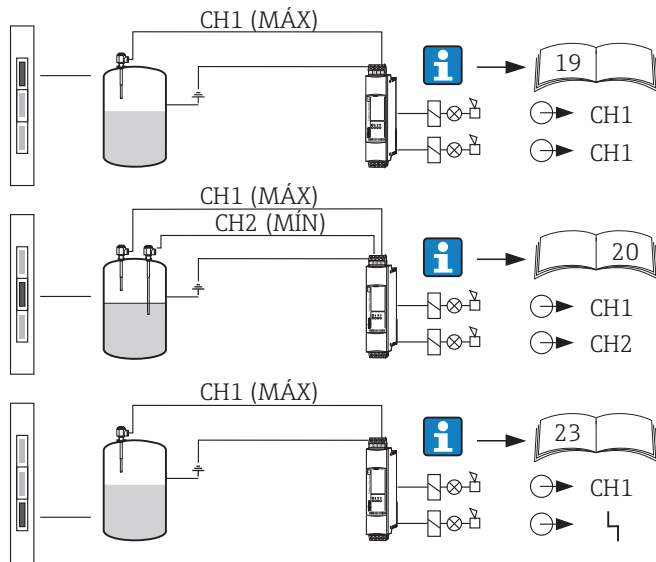
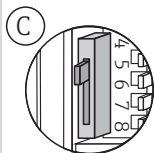

1.

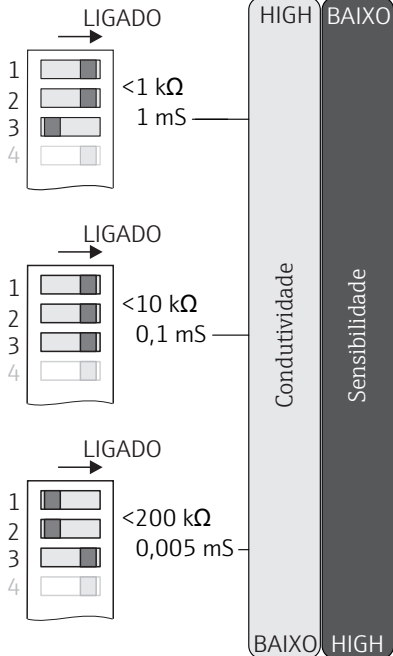

(B)

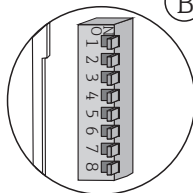

pt - Comutador DIL:

1. Configurando a faixa de resistência
2. Execute a calibração

2.

(D)

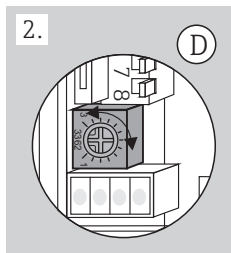

pt - Comutador DIL:  
Δ s função  
Controle de dois pontos

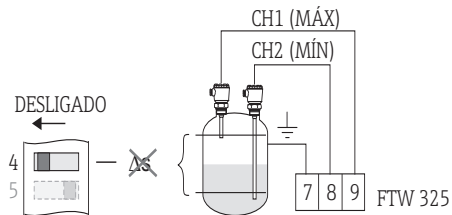
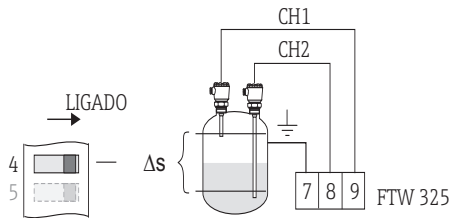
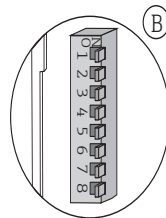

pt - Comutador DIL:  
 Segurança MÍN/MÁX  
 2 x CH1  
 Monitoramento da linha  
 (DESLIGADO)

Circuito no modo seguro	Nível			CH1	CH1	gn rd ye ye ● ● ● ●
MÁX DESLIGADO 	 	 	 	 		
MÍN LIGADO 	 	 	 	 		

pt - Comutador DIL:  
 Segurança MÍN/MÁX  
 CH1 e CH2  
 Monitoramento da linha  
 (DESLIGADO)

Circuito no  
 modo seguro

Nível

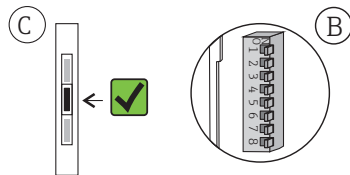

⊖ CH1

⊖ CH2

gn rd ye ye

CH1 = MÁX  
 CH2 = MÍN

DESLIGADO

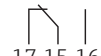
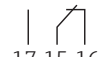

CH1 = MÍN  
 CH2 = MÁX

LIGADO

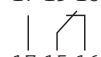
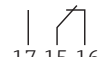



pt - Comutador DIL:  
 Segurança MÁX  
 $\Delta s$  (CH1 + CH2)  
 Monitoramento da linha  
 (DESLIGADO)

Circuito no modo seguro

Nível

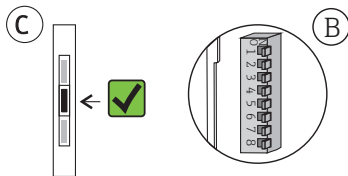

$\Delta s$

$\Delta s = \{$   CH1 |  CH2 | gn rd ye ye

MÁX +  $\Delta s$

LIGADO

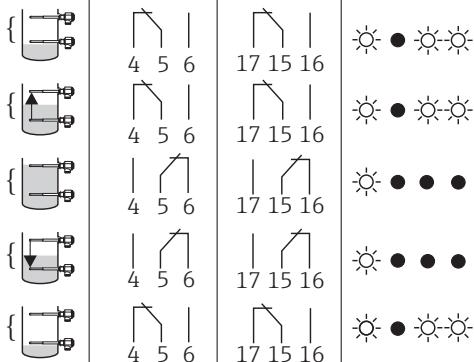

pt - Comutador DIL:  
 Segurança MÍN  
 $\Delta s$  (CH1 + CH2)  
 Monitoramento da linha  
 (DESLIGADO)

Circuito no  
 modo seguro



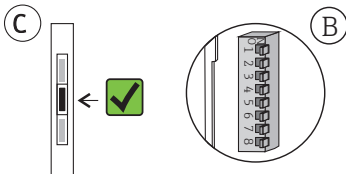



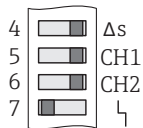



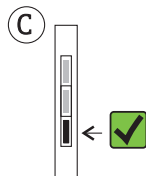
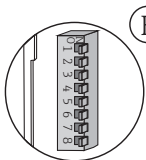













Nível



	Nível	$\Delta s$		gn rd ye ye				
		$\Delta s = \{$	$\ominus \rightarrow$ CH1	$\ominus \rightarrow$ CH2	gn	rd	ye	ye
MÍN + $\Delta s$		$\{$						
LIGADO		$\{$						
		$\{$						
		$\{$						
		$\{$						



pt - Comutador DIL:  
 Segurança MÍN/MÁX  
 CH1 + mensagem de erro  
 Monitoramento da linha  
 (LIGADO)

Circuito no modo seguro	Nível			gn rd ye ye
		⊖ CH1	⊖	● ● ● ●
MÁX DESLIGADO 5 CH1 6 CH2 7	 	 4 5 6  4 5 6	 17 15 16  17 15 16	 
MÍN LIGADO 5 CH1 6 CH2 7	 	 4 5 6  4 5 6	 17 15 16  17 15 16	 
Erro		 4 5 6	 17 15 16	
		 4 5 6	 17 15 16	

pt - Função mestre-escravo  
 Configurando a sincronização  
 das fases

MESTRE \_\_\_\_\_  
 ESCRAVO .....  
 0

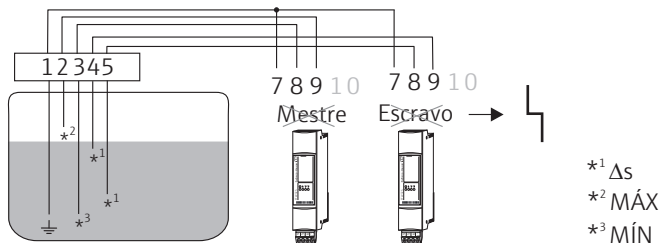
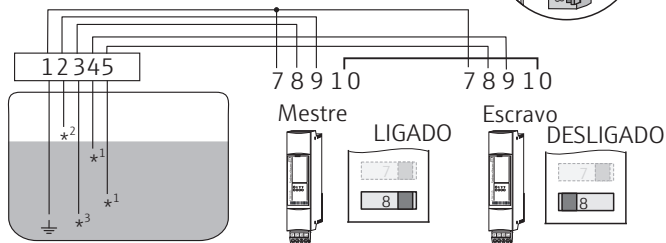
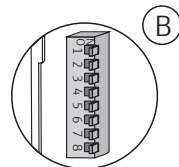

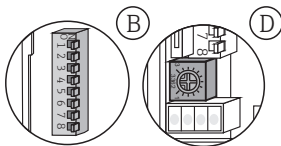
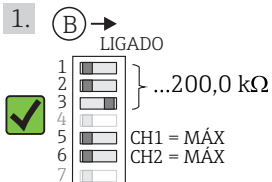

pt - Calibração  
Configuração padrão!  
Para líquidos condutivos

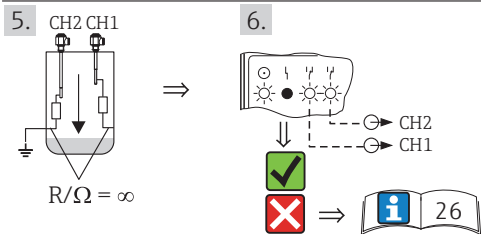
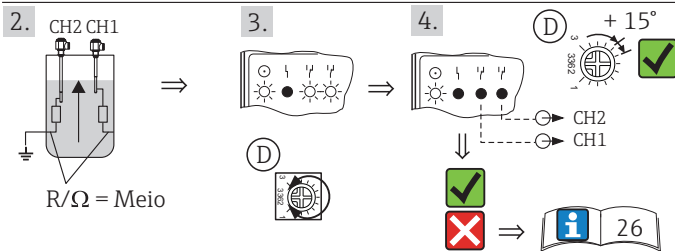

1.

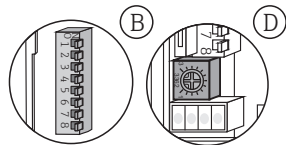
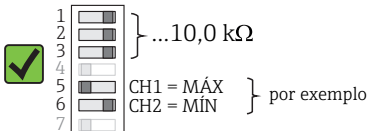

2.

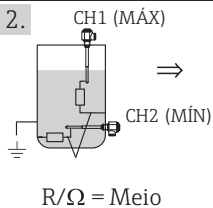

3.

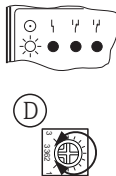

4.

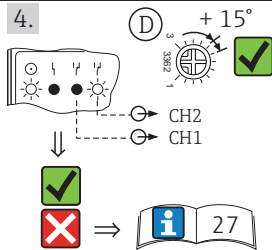



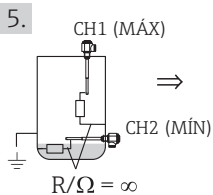



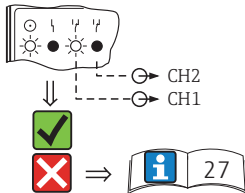

5.



6.



1. (B) → LIGADO

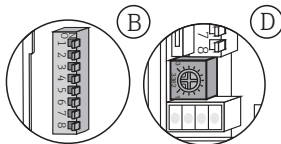

 1  } ...1,0 k $\Omega$   
 2  }  
 3  }  
 4  }  $\Delta s$  = LIGADO  
 5  } CH1 = MÁX  
 6  } CH2 = MÁX  
 7  } por exemplo

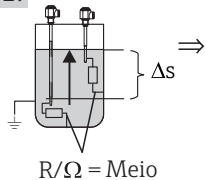

2. CH2 CH1

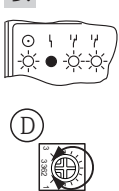

3.



4.

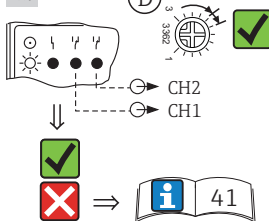

5. CH2 CH1

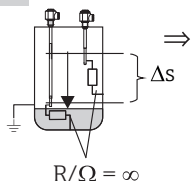

6.

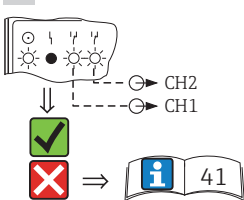

pt - Teste de função  
Nível do alarme 1. - 3. e  
mensagem de erro 4. - 9.

por exemplo MÁX

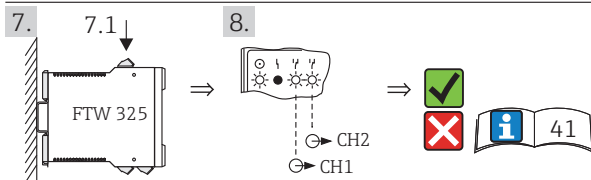
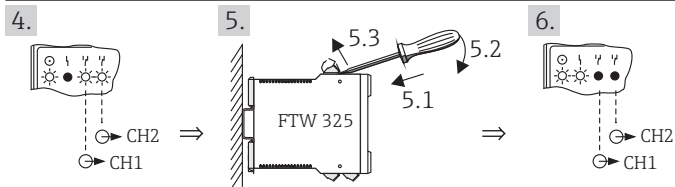
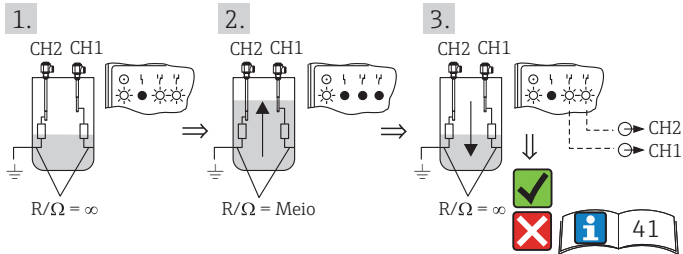



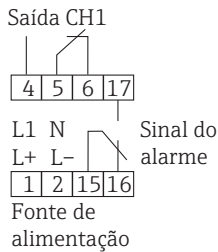
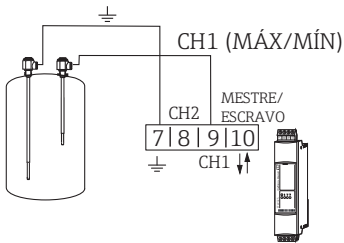

pt - Exemplos para instalação e configuração  
Um modo de canal com sinal do alarme

### Configuração da comutação

5 s	<input type="checkbox"/>	deslig. lig.	1	<input type="checkbox"/>	.. 1 k $\Omega$	} sensibilidade
3 s	<input type="checkbox"/>		2	<input type="checkbox"/>	.. 10 k $\Omega$	
0,5 s	<input checked="" type="checkbox"/>		3	<input checked="" type="checkbox"/>	.. 200 k $\Omega$	
	<input type="checkbox"/>		4	<input type="checkbox"/>	$\Delta$ S (DESLIGADO)	
	<input type="checkbox"/>		5	<input checked="" type="checkbox"/>	CH1 (MÁX/MÍN)	
	<input type="checkbox"/>		6	<input type="checkbox"/>	CH2 (MÁX)	
	<input type="checkbox"/>		7	<input checked="" type="checkbox"/>	Alarme (LIGADO)	
	<input checked="" type="checkbox"/>		8	<input type="checkbox"/>	Escravo/mestre (mestre)	

Saída CH1 em paralelo

Saída CH2 separada

1CH com alarme



Calibração

pt - Um modo de canal sem sinal do alarme (saídas em paralelo)

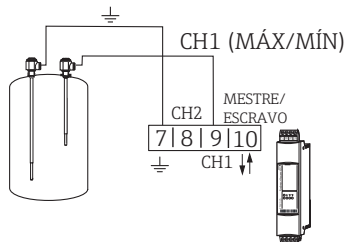

Saída CH1

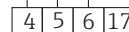

L1 N Saída CH1  
L+ L-

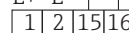

Fonte de alimentação

### Configuração da comutação

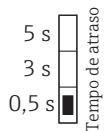

Saída CH1 em paralelo

Saída CH2 separada

1CH com alarme

Modo de saída

deslig. lig.

- |   |                                     |                         |                 |
|---|-------------------------------------|-------------------------|-----------------|
| 1 | <input checked="" type="checkbox"/> | .. 1 k $\Omega$         | } sensibilidade |
| 2 | <input checked="" type="checkbox"/> | .. 10 k $\Omega$        |                 |
| 3 | <input type="checkbox"/>            | .. 200 k $\Omega$       |                 |
| 4 | <input checked="" type="checkbox"/> | $\Delta$ S (DESLIGADO)  |                 |
| 5 | <input checked="" type="checkbox"/> | CH1 (MÁX/MÍN)           |                 |
| 6 | <input checked="" type="checkbox"/> | CH2 (MÁX)               |                 |
| 7 | <input checked="" type="checkbox"/> | Alarme (DESLIGADO)      |                 |
| 8 | <input type="checkbox"/>            | Escravo/mestre (mestre) |                 |



Calibração

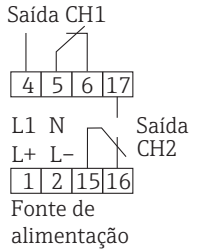
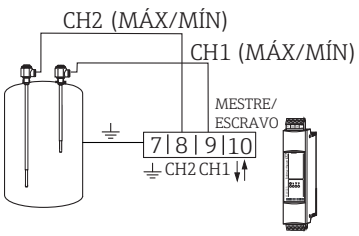

pt - Dois modos de canal (saídas separadas)

Configuração da comutação

- 5 s
  - 3 s
  - 0,5 s
- Tempo de atraso

- Saída CH1 em paralelo
- Saída CH2 separada
- 1CH com alarme

Modo de saída

deslig. lig.

- 1  .. 1 kΩ
  - 2  .. 10 kΩ
  - 3  .. 200 kΩ
  - 4  ΔS (DESLIGADO)
  - 5  CH1 (MÁX/MÍN)
  - 6  CH2 (MÁX/MÍN)
  - 7  Alarme (DESLIGADO)
  - 8  Escravo/mestre (mestre)
- } sensibilidade



Calibração

pt - controle de dois pontos ( $\Delta s$ )  
com sinal de alarme

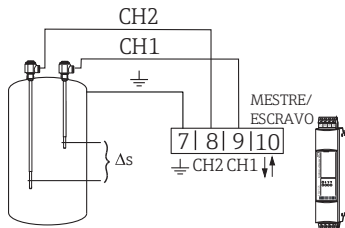

Saída  $\Delta S$  - Sinal

4 5 6 17

L1 N Sinal do  
L+ L- alarme

1 2 15 16

Fonte de  
alimentação

### Configuração da comutação

5 s  
3 s  
0,5 s

Tempo de atraso

Saída CH1 em paralelo  
Saída CH2 separada  
1CH com alarme

Modo de saída

deslig. lig.

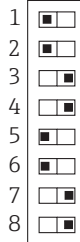

.. 1 k $\Omega$   
.. 10 k $\Omega$   
.. 200 k $\Omega$  } sensibilidade  
 $\Delta S$  (LIGADO)  
CH1 (MÁX)  
CH2 (MÁX)  
Alarme (LIGADO)  
Escravo/mestre (mestre)



Calibração

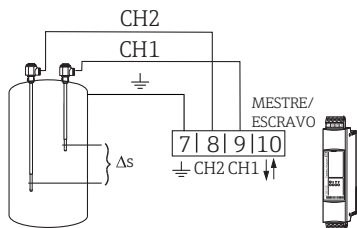

Saída  $\Delta s$  - Sinal

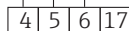

L1 N Saída  $\Delta s$  - Saída  
L+ L-

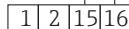

Fonte de alimentação

pt - Controle de dois pontos ( $\Delta s$ ) sem sinal de alarme (saídas em paralelo)

### Configuração da comutação

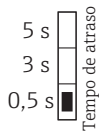

Saída CH1 em paralelo  
Saída CH2 separada  
1CH com alarme



deslig. lig.

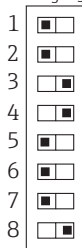

- 1 .. 1 k $\Omega$
- 2 .. 10 k $\Omega$
- 3 .. 200 k $\Omega$
- 4  $\Delta s$  (LIGADO)
- 5 CH1 (MÁX)
- 6 CH2 (MÁX)
- 7 Alarme (DESLIGADO)
- 8 Escravo/mestre (mestre)



Calibração

pt - Dois modos de canal  
(saídas separadas)

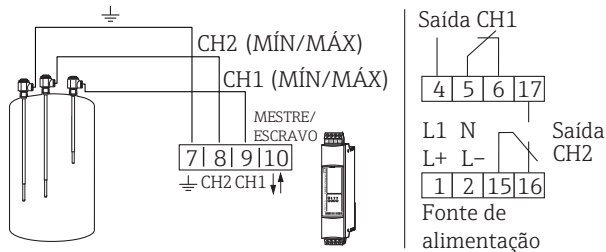

### Configuração da comutação

5 s	<input type="checkbox"/>	Tempo de atraso	1	<input checked="" type="checkbox"/>	deslig.	} sensibilidade
3 s	<input type="checkbox"/>		2	<input checked="" type="checkbox"/>	lig.	
0,5 s	<input checked="" type="checkbox"/>		3	<input type="checkbox"/>	.. 1 k $\Omega$	
	<input type="checkbox"/>	Modo de saída	4	<input checked="" type="checkbox"/>	.. 10 k $\Omega$	} .. 200 k $\Omega$
Saída CH1 em paralelo	<input type="checkbox"/>		5	<input checked="" type="checkbox"/>	$\Delta$ S (DESLIGADO)	
Saída CH2 separada	<input checked="" type="checkbox"/>		6	<input checked="" type="checkbox"/>	CH1 (MÍN/MÁX)	
1CH com alarme	<input type="checkbox"/>		7	<input checked="" type="checkbox"/>	CH2 (MÍN/MÁX)	
	<input type="checkbox"/>		8	<input type="checkbox"/>	Alarme (DESLIGADO)	
	<input type="checkbox"/>			<input checked="" type="checkbox"/>	Escravo/mestre (mestre)	



Calibração

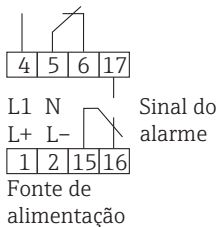
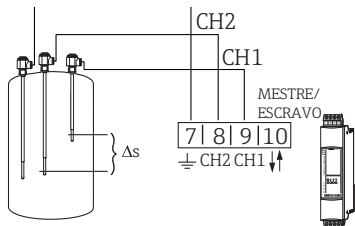

pt - controle de dois pontos ( $\Delta s$ )  
com sinal de alarme

Configuração da comutação

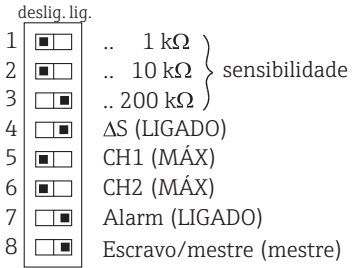
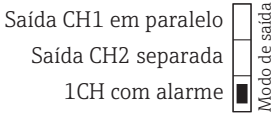
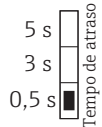

Calibração

pt - Controle de dois pontos ( $\Delta s$ )  
sem sinal de alarme (saídas  
em paralelo)

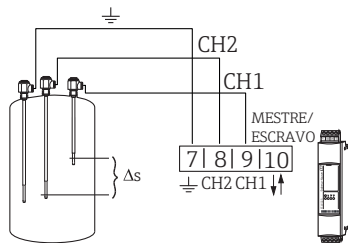

Saída  $\Delta s$  - Sinal



Fonte de  
alimentação

### Configuração da comutação

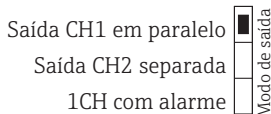
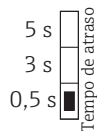

deslig. lig.

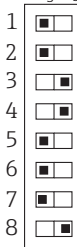

- .. 1 k $\Omega$  }
- .. 10 k $\Omega$  } sensibilidade
- .. 200 k $\Omega$  }
- 4 AS (LIGADO)
- 5 CH1 (MÁX)
- 6 CH2 (MÁX)
- 7 Alarme (DESLIGADO)
- 8 Escravo/mestre (mestre)



Calibração



pt - Quatro modos de canal  
(MÍN resp. MÁX combinado  
arbitrariamente)

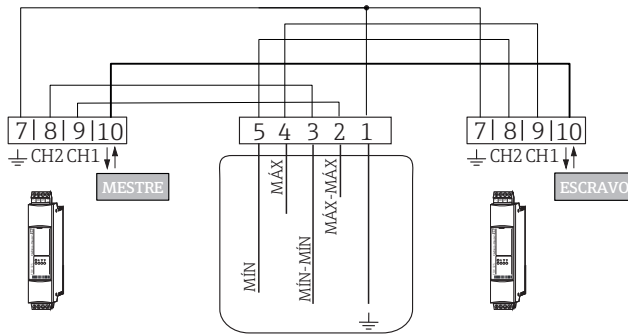

Mestre

Saída CH1

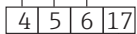

L1 N  
L+ L- Saída  
CH2

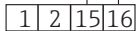

Fonte de  
alimentação

Escravo

Saída CH1

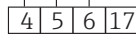

L1 N  
L+ L- Saída  
CH2

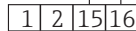

Fonte de a  
limentação

pt - Quatro modos de canal  
(MÍN resp. MÁX combinado  
arbitrariamente)

### Configuração da comutação mestre

Saída CH1 em paralelo  
Saída CH2 separada  
1CH com alarme

Modo de saída



Calibração

deslig. lig.

1	<input checked="" type="checkbox"/> <input type="checkbox"/>	.. 1 k $\Omega$	} sensibilidade
2	<input checked="" type="checkbox"/> <input type="checkbox"/>	.. 10 k $\Omega$	
3	<input type="checkbox"/> <input checked="" type="checkbox"/>	.. 200 k $\Omega$	
4	<input checked="" type="checkbox"/> <input type="checkbox"/>	$\Delta$ S (DESLIGADO)	
5	<input checked="" type="checkbox"/> <input checked="" type="checkbox"/>	CH1 (MÁX/MÍN)	
6	<input checked="" type="checkbox"/> <input type="checkbox"/>	CH2 (MÁX/MÍN)	
7	<input checked="" type="checkbox"/> <input type="checkbox"/>	Alarme (DESLIGADO)	
8	<input type="checkbox"/> <input checked="" type="checkbox"/>	Escravo/mestre (mestre)	

### Configuração da comutação escravo

Saída CH1 em paralelo  
Saída CH2 separada  
1CH com alarme

Modo de saída



Calibração

deslig. lig.

1	<input checked="" type="checkbox"/> <input type="checkbox"/>	.. 1 k $\Omega$	} sensibilidade
2	<input checked="" type="checkbox"/> <input type="checkbox"/>	.. 10 k $\Omega$	
3	<input type="checkbox"/> <input checked="" type="checkbox"/>	.. 200 k $\Omega$	
4	<input checked="" type="checkbox"/> <input type="checkbox"/>	$\Delta$ S (DESLIGADO)	
5	<input checked="" type="checkbox"/> <input checked="" type="checkbox"/>	CH1 (MÁX/MÍN)	
6	<input checked="" type="checkbox"/> <input type="checkbox"/>	CH2 (MÁX/MÍN)	
7	<input checked="" type="checkbox"/> <input type="checkbox"/>	Alarme (DESLIGADO)	
8	<input checked="" type="checkbox"/> <input type="checkbox"/>	Escravo/mestre (escravo)	

pt - Controle de dois pontos ( $\Delta s$ )  
sem sinal de alarme e dois  
modos de canal (saídas  
separadas)

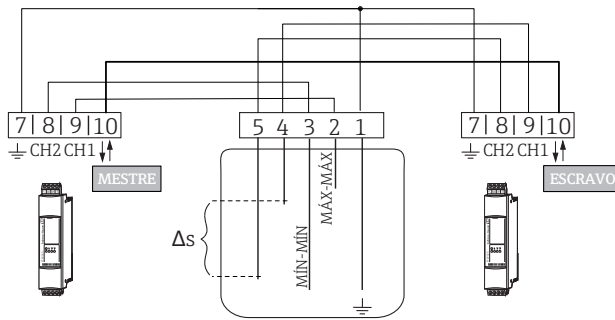

### Mestre

Saída CH1



L1 N Saída  
L+ L- CH2

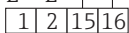

Fonte de  
alimentação

### Escravo

Saída  $\Delta s$  - Sinal

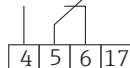

L1 N Saída  
L+ L-  $\Delta s$  -  
Sinal

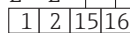

Fonte de  
alimentação

pt - Controle de dois pontos ( $\Delta s$ )  
sem sinal de alarme e dois  
modos de canal (saídas  
separadas)

### Configuração da comutação mestre

Saída CH1 em paralelo

Saída CH2 separada

1CH com alarme

Modo de saída



Calibration

deslig. lig.

1	<input checked="" type="checkbox"/> <input type="checkbox"/>	.. 1 k $\Omega$	} sensibilidade
2	<input checked="" type="checkbox"/> <input type="checkbox"/>	.. 10 k $\Omega$	
3	<input type="checkbox"/> <input checked="" type="checkbox"/>	.. 200 k $\Omega$	
4	<input checked="" type="checkbox"/> <input type="checkbox"/>	$\Delta S$ (DESLIGADO)	
5	<input checked="" type="checkbox"/> <input checked="" type="checkbox"/>	CH1 (MÁX/MÍN)	
6	<input checked="" type="checkbox"/> <input checked="" type="checkbox"/>	CH2 (MÁX/MÍN)	
7	<input checked="" type="checkbox"/> <input type="checkbox"/>	Alarme (DESLIGADO)	
8	<input type="checkbox"/> <input checked="" type="checkbox"/>	Escravo/mestre (mestre)	

### Configuração da comutação escravo

Saída CH1 em paralelo

Saída CH2 separada

1CH com alarme

Modo de saída



Calibration

deslig. lig.



1	<input checked="" type="checkbox"/> <input type="checkbox"/>	.. 1 k $\Omega$	} sensibilidade
2	<input checked="" type="checkbox"/> <input type="checkbox"/>	.. 10 k $\Omega$	
3	<input type="checkbox"/> <input checked="" type="checkbox"/>	.. 200 k $\Omega$	
4	<input type="checkbox"/> <input checked="" type="checkbox"/>	$\Delta S$ (LIGADO)	
5	<input checked="" type="checkbox"/> <input type="checkbox"/>	CH1 (MÁX)	
6	<input checked="" type="checkbox"/> <input type="checkbox"/>	CH2 (MÁX)	
7	<input checked="" type="checkbox"/> <input type="checkbox"/>	Alarme (DESLIGADO)	
8	<input checked="" type="checkbox"/> <input type="checkbox"/>	Escravo/mestre (escravo)	

Erro	Motivo	Solução
Não comuta	Sem alimentação (LED verde não acende)	Verificar energia
	Defeito eletrônico	Substitua FTW325
	Contatos soldados simultaneamente (após curto-circuito)	Substitua FTW325; conecte um fusível em um contator de circuito
	Transmissor de medição com falha	Substitua o transmissor de medição
Comuta incorretamente	Configuração incorreta do comutador para sinal de limite no FTW325	Comutador configurado corretamente atrás do painel frontal
Sinal de alarme permanente	Interrompa ou linha curto-circuito para o transmissor de medição	Verifique a linha
	Componentes eletrônicos do transmissor de medição com falha	Substitua os componentes eletrônicos do transmissor de medição
	Nivotester com falha	Substitua FTW325

Informações técnicas

TI00373F

Notas sobre a segurança

XA00196F   II (1) G [Ex ia Ga] IIC/IIB

  II (1) D [Ex ia Da] IIIC



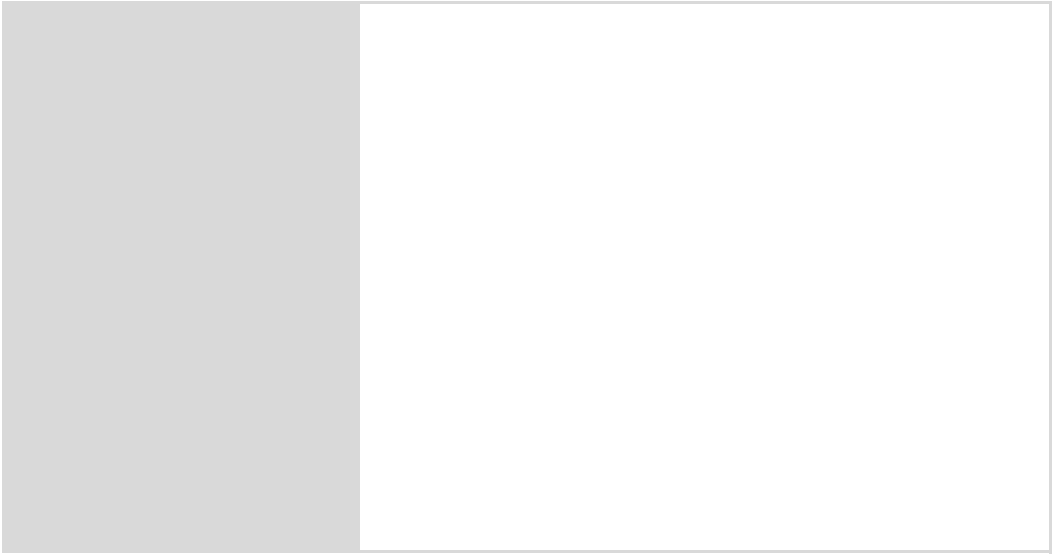

[www.endress.com/worldwide](http://www.endress.com/worldwide)

