

Safety Instructions

Micropilot

FMR50/51/52/53/54/56/57

PROFIBUS PA, FOUNDATION Fieldbus

II 1 G Ex ia IIC T6...T1 Ga

II 1/2 G Ex ia IIC T6...T1 Ga/Gb



Micropilot FMR50/51/52/53/54/56/57

PROFIBUS PA, FOUNDATION Fieldbus

Table of contents

Associated documentation	4
Supplementary documentation	4
Manufacturer's certificates	4
Manufacturer address	4
Other standards	5
Extended order code	5
Safety instructions: General	10
Safety instructions: Special conditions	10
Safety instructions: Installation	12
Safety instructions: Zone 0	15
Temperature tables	15
Connection data	17

Associated documentation

This document is an integral part of the following Operating Instructions:

PROFIBUS PA

- BA01124F/00 (FMR50)
- BA01125F/00 (FMR51, FMR52)
- BA01126F/00 (FMR53, FMR54)
- BA01127F/00 (FMR56, FMR57)

FOUNDATION Fieldbus

- BA01120F/00 (FMR50)
- BA01121F/00 (FMR51, FMR52)
- BA01122F/00 (FMR53, FMR54)
- BA01123F/00 (FMR56, FMR57)

Supplementary documentation

Explosion-protection brochure: CP00021Z/11

The Explosion-protection brochure is available:

- In the download area of the Endress+Hauser website:
www.endress.com -> Downloads -> Brochures and Catalogs ->
Text Search: CP00021Z
- On the CD for devices with CD-based documentation

Manufacturer's certificates**UK Declaration of Conformity**

Declaration Number:
EC00881

The UK Declaration of Conformity is available:

In the download area of the Endress+Hauser website:
www.endress.com -> Downloads -> Declaration ->
Type: EU Declaration -> Product Code: ...

UKCA type-examination certificate

Certificate number:
CML 21UKEX2141X

List of applied standards: See UK Declaration of Conformity.

Manufacturer address

Endress+Hauser SE+Co. KG
Hauptstraße 1
79689 Maulburg, Germany

Address of the manufacturing plant: See nameplate.

Other standards

Among other things, the following standards shall be observed in their current version for proper installation:

- IEC/EN 60079-14: "Explosive atmospheres - Part 14: Electrical installations design, selection and erection"
- EN 1127-1: "Explosive atmospheres - Explosion prevention and protection - Part 1: Basic concepts and methodology"

Extended order code

The extended order code is indicated on the nameplate, which is affixed to the device in such a way that it is clearly visible. Additional information about the nameplate is provided in the associated Operating Instructions.

Structure of the extended order code

FMR5x	-	*****	+	A*B*C*D*E*F*G*..
<i>(Device type)</i>		<i>(Basic specifications)</i>		<i>(Optional specifications)</i>

* = Placeholder

At this position, an option (number or letter) selected from the specification is displayed instead of the placeholders.

Basic specifications

The features that are absolutely essential for the device (mandatory features) are specified in the basic specifications. The number of positions depends on the number of features available.

The selected option of a feature can consist of several positions.

Optional specifications

The optional specifications describe additional features for the device (optional features). The number of positions depends on the number of features available. The features have a 2-digit structure to aid identification (e.g. JA). The first digit (ID) stands for the feature group and consists of a number or a letter (e.g. J = Test, Certificate). The second digit constitutes the value that stands for the feature within the group (e.g. A = 3.1 material (wetted parts), inspection certificate).

More detailed information about the device is provided in the following tables. These tables describe the individual positions and IDs in the extended order code which are relevant to hazardous locations.

Extended order code: Micropilot



The following specifications reproduce an extract from the product structure and are used to assign:

- This documentation to the device (using the extended order code on the nameplate).
- The device options cited in the document.

Device type

FMR50, FMR51, FMR52, FMR53, FMR54, FMR56, FMR57

Basic specifications

Position 1, 2 (Approval)		
Selected option		Description
FMR5x	UA	UK Ex II 1 G Ex ia IIC T6...T1 Ga
	UB	UK Ex II 1/2 G Ex ia IIC T6...T1 Ga/Gb

Position 3 (Power Supply, Output)		
Selected option		Description
FMR5x	E	2-wire, FOUNDATION Fieldbus, switch output (PFS)
	G	2-wire, PROFIBUS PA, switch output (PFS)

Position 4 (Display, Operation)		
Selected option		Description
FMR5x	A	Without, via communication
	C	SD02, 4-line, push buttons + data backup function
	E	SD03, 4-line, illum., touch control + data backup function
	L ^{1) 2)}	Prepared for display FHX50 + M12 connection
	M ^{1) 2)}	Prepared for display FHX50 + custom connection
	N ^{1) 3)}	Prepared for display FHX50 + NPT1/2"

- 1) UK Ex approved version of FHX50
- 2) In connection with Position 5 = A: Observe the specifications in the "Overvoltage protection" and "Temperature tables" chapters!
- 3) Only in connection with Position 5 = B, C

Position 5 (Housing)		
Selected option		Description
FMR5x	A	GT19 dual compartment, plastics PBT
	C	GT20 dual compartment, Alu coated
FMR51-54 FMR57	B	GT18 dual compartment, 316L

Position 7, 8 (Antenna)		
Selected option		Description
FMR50	BM	Horn 40 mm/1½", PVDF encapsulated, -40...130°C
	BN	Horn 80 mm/3", PP cladded, -40...80°C
	BR	Horn 100 mm/4", PP cladded, -40...80°C
FMR51	Bx	Horn (different sizes)
FMR52	BO	Horn 50 mm/2", -40...200°C ¹⁾ , -196...200°C ²⁾ , flush mount
	BP	Horn 80 mm/3", -40...200°C ¹⁾ , -196...200°C ²⁾ , flush mount
FMR53	Cx	Rod (different sizes)
FMR54	Ax	Without Horn
	Bx	Horn (different sizes)
	Dx	Planar (different sizes)
FMR56	BN	Horn 80 mm/3", PP cladded, -40...80°C
	BR	Horn 100 mm/4", PP cladded, -40...80°C
FMR57	Bx	Horn (different sizes)
	Fx	Parabolic (different sizes)



Shown in the temperature tables exemplary as follows:

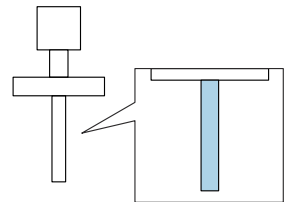

- 1) In connection with Position 5 = A
- 2) Only in connection with Position 5 = B, C

Position 9, 10 (Seal)		
Selected option		Description
FMR51	A5	Viton GLT, -40...150°C
	C1	Kalrez, -20...150°C
	D2	Graphite, -196...450°C (HT)
	D3	Graphite, -40...250°C (XT)
FMR54	A7	Viton, -20...150°C (Planar)
	A8	Viton, -40...200°C
	B4	EPDM, -40...150°C
	C2	Kalrez, -20...200°C, conductive media max. 150°C
	D1	Graphite, -196...280°C (XT)
	D2	Graphite, -196...400°C (HT)
FMR57	A6	Viton GLT, -40...200°C
	D4	Graphite, -40...400°C (HT)

 Shown in the temperature tables exemplary as follows:

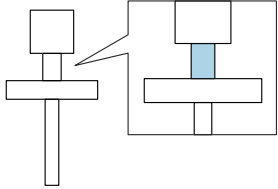

Position 11-13 (Process Connection)		
Selected option		Description
FMR51-54 FMR57	Axx Cxx Kxx	Flange (different sizes)
FMR50	GGF RGF	Thread, PVDF
	UAE	Mounting bracket
	XRO	Connection, without flange/mounting bracket
	XxG	Slip on flange (different sizes)
FMR51	Pxx	Flange (different sizes)
	Rxx	Thread
	Txx	Tri-Clamp

Position 11-13 (Process Connection)		
Selected option		Description
FMR52	Mxx	Slotted-nut
	Txx	Tri-Clamp
FMR53	RxJ	Thread, 316L
	RxF	Thread, PVDF
FMR56	UAE	Mounting bracket
	XR0	Connection, without flange/mounting bracket
	XxG	Slip on flange (different sizes)
FMR57	RxJ	Thread, 316L
	XxJ	Align. device (different sizes)

 Shown in the temperature tables exemplary as follows:

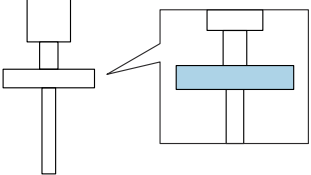

Position 14 (Air Purge Connection)		
Selected option		Description
FMR57	1	G1/4
	2	NPT1/4

Optional specifications

ID Jx (Test, Certificate)		
Selected option		Description
FMR51 ¹⁾ FMR52 FMR54 ²⁾	JN ³⁾	Ambient temperature transmitter -50°C

- 1) Only in connection with Position 9, 10 = D2
- 2) Only in connection with Position 9, 10 = D1, D2
- 3) Only in connection with Position 5 = B, C

ID Nx, Ox (Accessory Mounted)		
Selected option		Description
FMR5x	NA	Overvoltage protection
FMR51	OM OU OV	Antenna extension (different sizes)
	OW	Horn protection, PTFE, no airpurge possible
FMR54	OM	Antenna extension (different sizes)
	ON	
	OR	
	OS	
FMR57	OP OT	Antenna extension (different sizes)
	OW	Horn protection, PTFE, no airpurge possible

Safety instructions: General

- Staff must meet the following conditions for mounting, electrical installation, commissioning and maintenance of the device:
 - Be suitably qualified for their role and the tasks they perform
 - Be trained in explosion protection
 - Be familiar with national regulations
- Install the device according to the manufacturer's instructions and national regulations.
- Do not operate the device outside the specified electrical, thermal and mechanical parameters.
- Only use the device in media to which the wetted materials have sufficient durability.
- Avoid electrostatic charging:
 - Of plastic surfaces (e.g. enclosure, sensor element, special varnishing, attached additional plates, ..)
 - Of isolated capacities (e.g. isolated metallic plates)
- Modifications to the device can affect the explosion protection and must be carried out by staff authorized to perform such work by Endress+Hauser.
- Refer to the temperature tables for the relationship between the permitted ambient temperature for the sensor and/or transmitter, depending on the range of application and the temperature class.

Safety instructions: Special conditions

Permitted ambient temperature range at the electronics enclosure:
 $-40\text{ °C} \leq T_a \leq +80\text{ °C}$

Optional specification, ID Jx = JN

Permitted ambient temperature range at the electronics enclosure:
 $-50\text{ °C} \leq T_a \leq +80\text{ °C}$

- Observe the information in the temperature tables.
- In the case of process connections made of polymeric material or with polymeric coatings, avoid electrostatic charging of the plastic surfaces.
- To avoid electrostatic charging: Do not rub surfaces with a dry cloth.
- In the event of additional or alternative special varnishing on the enclosure or other metal parts or for adhesive plates:
 - Observe the danger of electrostatic charging and discharge.
 - Do not install in the vicinity of processes (≤ 0.5 m) generating strong electrostatic charges.

Basic specification, Position 5 = A

Avoid electrostatic charging of the enclosure (e.g. friction, cleaning, maintenance, strong medium flow).

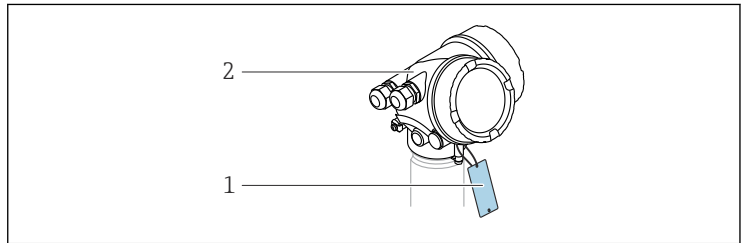

A0032146

1

1 *Isolated capacitance:*

with one metal plate: ≤ 3 pF (permitted in all areas for Equipment Groups II and III)

with two to three metal plates: ≤ 10 pF (not permitted in Zone 0 and for Equipment Group IIC)

2 *Enclosure*

Basic specification, Position 5 = C

In Zone 0, avoid sparks caused by impact and friction.

Device type FMR50, FMR52, FMR53, FMR54 (planar, enamel), FMR56

An antenna coated with non-conductive material can be used if avoiding electrostatic charging (e.g. through friction, cleaning, maintenance, strong medium flow).

Device type FMR51, FMR57 and Optional specification, ID Nx, Ox = OW

An antenna coated with non-conductive material can be used if avoiding electrostatic charging (e.g. through friction, cleaning, maintenance, strong medium flow).

Device type FMR57 and Basic specification, Position 11-13 = XxJ

- Changing the position of the alignment device must be impossible:
 - After the alignment of the antenna via the pivot bracket
 - After tightening of the clamping flange
 - After setting the damping ring (torque 15 Nm)
- Degree of protection IP67 must be fulfilled.

Device type FMR57 and Basic specification, Position 14 = 1, 2

- If equipment with Ga/Gb or Da/Db is required: In the closed state the minimum degree of protection of the installation must be IP67.
- After removing the air purge connection: Lock the opening with a suitable plug.
 - Torque: 6-7 Nm
 - For Da/Db: thread engagement > 5 turns
- Degree of protection IP67 must be fulfilled.

Device type FMR51, FMR54, FMR57 and Optional specification, ID Nx,
Ox = OM, ON, OR, OS, OU, OV, OP, OT

Avoid contact between sensor and tank wall. Take into account tank fittings and flow conditions (avoid sparks caused by impact and friction).

Safety instructions: Installation

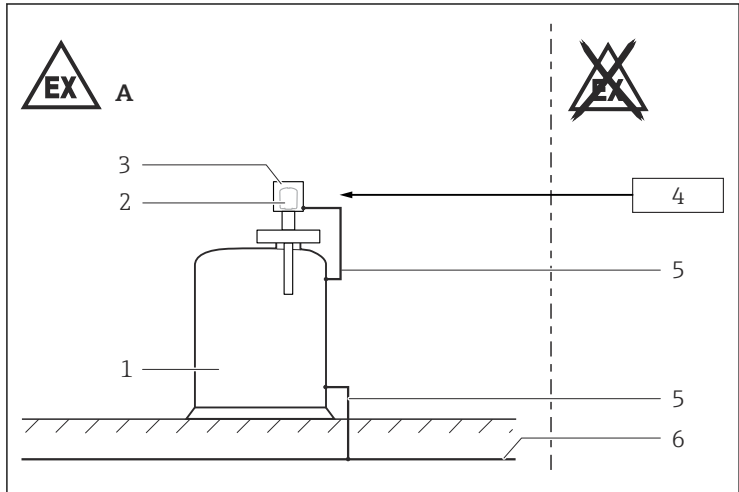

A0025536

2

- A Zone 0, Zone 1
- 1 Tank; Zone 0, Zone 1
- 2 Electronic insert
- 3 Enclosure
- 4 Certified associated apparatus
- 5 Potential equalization line
- 6 Potential equalization

- After aligning (rotating) the enclosure, retighten the fixing screw (see Operating Instructions).
- Install the device to exclude any mechanical damage or friction during the application. Pay particular attention to flow conditions and tank fittings.
- Continuous service temperature of the connecting cable:
-40 °C to $\geq +85$ °C; in accordance with the range of service temperature taking into account additional influences of the process conditions ($T_{a,\min}$), ($T_{a,\max} + 20$ K).

Optional specification, ID Jx = JN

Continuous service temperature of the connecting cable:
-50 °C to $\geq +85$ °C; in accordance with the range of service temperature taking into account additional influences of the process conditions ($T_{a,\min}$), ($T_{a,\max} + 20$ K).

Basic specification, Position 4 = N

Observe the requirements according to IEC/EN 60079-14 for conduit systems and the wiring- and installation instructions of the suitable Safety Instructions (XA). In addition, observe national regulations and standards for conduit systems.

Intrinsic safety

- The device is only suitable for connection to certified, intrinsically safe equipment with explosion protection Ex ia / Ex ib.
- The intrinsically safe input power circuit of the device is isolated from ground. If the device is only equipped with one input, the dielectric strength of the input is at least 500 V_{rms}. If the device is equipped with more than one input, the dielectric strength of each individual input to ground is at least 500 V_{rms}, and the dielectric strength of the inputs vis-à-vis one another is also at least 500 V_{rms}.
- Observe the pertinent guidelines when interconnecting intrinsically safe circuits.
- The device can be connected to the Endress+Hauser FXA291 service tool: refer to the Operating Instructions and specifications in the "Overvoltage protection" chapter.
- When the intrinsically safe Ex ia circuits of the device are connected to certified intrinsically safe circuits of Category Ex ib for Equipment Groups IIC or IIB, the type of protection changes to Ex ib [ia] IIC or Ex ib [ia] IIB. Regardless of the power supply, all the internal circuits correspond to Ex ia IIC type of protection (e.g. service interface, external display, sensor).

Potential equalization

- Integrate the device into the local potential equalization.
- Grounding the screen, see the following figure.

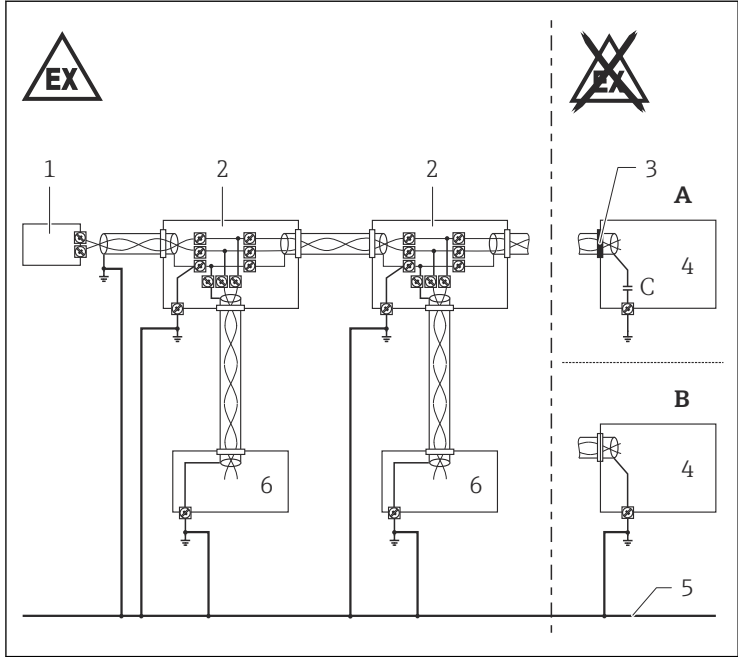

A0022352

- A Version 1: Use small capacitors (e.g. 1 nF, 1 500 V dielectric strength, ceramic). Total capacitance connected to the screen may not exceed 10 nF.
- B Version 2
- 1 Terminating resistor
 - 2 Distributor/T box
 - 3 Screen insulated
 - 4 Supply unit/Segment coupler
 - 5 Potential equalization (secured in high degree)
 - 6 Field device

Overvoltage protection

- If an overvoltage protection against atmospheric over voltages is required: no other circuits may leave the enclosure during normal operation without additional measures.
- For installations which require overvoltage protection to comply with national regulations or standards, install the device using overvoltage protection (e.g. HAW56x from Endress+Hauser).
- Observe the safety instructions of the overvoltage protection.

Optional specification, ID Nx, Ox = NA
(Overvoltage protection Type OVP20)

The intrinsically safe input power circuit of the device is isolated from ground. If the device is only equipped with one input, the dielectric strength of the input is at least 290 V_{rms}. If the device is equipped with

more than one input, the dielectric strength of each individual input to ground is at least $290 V_{\text{rms}}$, and the dielectric strength of the inputs vis-à-vis one another is also at least $290 V_{\text{rms}}$.

Safety instructions: Zone 0

- In the event of potentially explosive vapor/air mixtures, only operate the device under atmospheric conditions.
 - Temperature: -20 to $+60$ °C
 - Pressure: 80 to 110 kPa (0.8 to 1.1 bar)
 - Air with normal oxygen content, usually 21 % (V/V)
- If no potentially explosive mixtures are present, or if additional protective measures have been taken, the device may also be operated under non-atmospheric conditions in accordance with the manufacturer's specifications.
- Associated devices with galvanic isolation between the intrinsically safe and non-intrinsically safe circuits are preferred.
- Only use the device in media to which the silicone rubber potting compound of the electronic insert and the enclosure made of PBT, aluminum or 316L have sufficient durability.
- If there is a risk of dangerous potential differences within Zone 0 (e.g. through the occurrence of atmospheric electricity), implement suitable measures for intrinsically safe circuits in Zone 0.

Temperature tables

→ Safety Instructions: XA02407F/00



The Safety Instructions for temperature tables are available: In the download area of the Endress+Hauser website: www.endress.com -> Downloads -> Manuals and Datasheets -> Type: Ex Safety Instructions (XA) -> Text Search: ...



*Optional specification, ID Nx, Ox = NA
(Overvoltage protection Type OVP20)*

When using the internal overvoltage protection: Reduce the admissible ambient temperature at the enclosure by 5 K.

Basic specification, Position 5 = A

When using the remote display FHX50: Reduce the admissible ambient temperature at the enclosure by 3 K.



Observe the permitted temperature range at the antenna.

Explanation of how to use the temperature tables

 Unless otherwise indicated, the positions always refer to the basic specification.

1st column: Position 5 = A, B, ...

2nd column: Position 3 = A, B, ..

- (1): 1 channel used
- (2): 2 channels used

3rd column: Temperature classes T6 (85 °C) to T1 (450 °C)

Column P1 to P6: Position (temperature value) on the axes of the derating

- T_a : Ambient temperature in °C
- T_p : Process temperature in °C

 Column P6 is only relevant for version B of the derating.

Example table

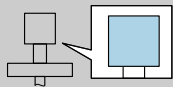
 = C	(1)	P1		P2		P3		P4		P5		P6	
		T_p	T_a	T_p	T_a	T_p	T_a	T_p	T_a	T_p	T_a	T_p	T_a
E, G	T6	-40	60	60	60	85	54	85	-40	-40	-40	-	-
	T5	-40	75	75	75	100	69	100	-40	-40	-40	-	-
	T4	-40	80	80	80	135	68	135	-40	-40	-40	-	-

Example diagrams of possible deratings

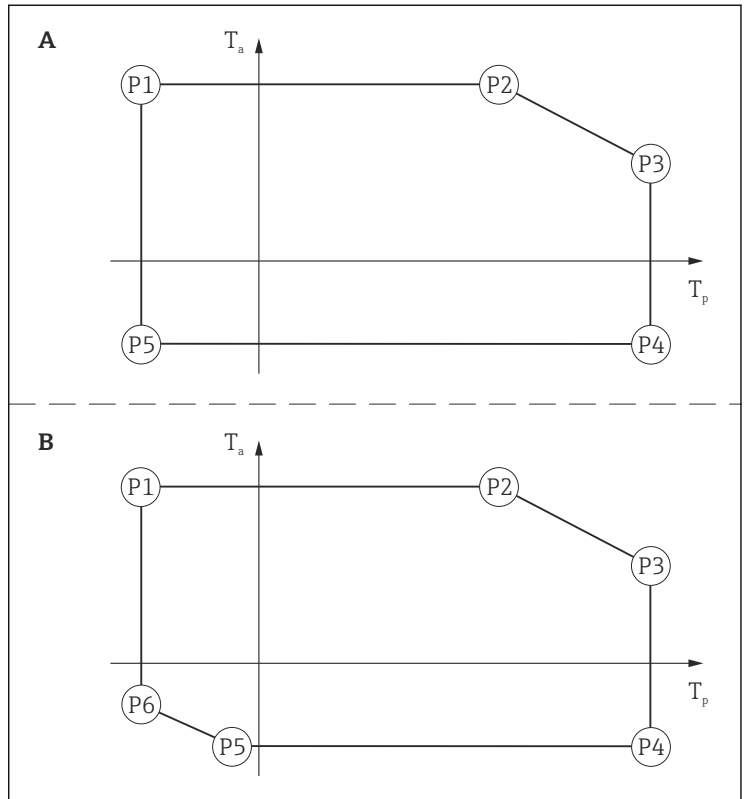

A0022717

Connection data

Optional specification, $ID Nx, Ox = NA$
 (Ovoltage protection Type OVP20)

When using the internal overvoltage protection: No changes to the connection values.

Ex ia

Power supply and signal circuit with protection type: intrinsic safety
 Ex ia IIC, Ex ia IIB.

Basic specification, Position 3 = E, G

Terminal 1 (+), 2 (-)		Terminal 3 (+), 4 (-)
FISCO	Entity	Switch output (PFS)
$U_i = 17.5 \text{ V}$	$U_i = 30 \text{ V}$	$U_i = 30 \text{ V}$
$I_i = 550 \text{ mA}$	$I_i = 300 \text{ mA}$	$I_i = 300 \text{ mA}$
$P_i = 5.5 \text{ W}$	$P_i = 1.2 \text{ W}$	$P_i = 1 \text{ W}$
effective inner inductance $L_i = 10 \text{ } \mu\text{H}$		effective inner inductance $L_i = 0$
effective inner capacitance $C_i = 5 \text{ nF}$		effective inner capacitance $C_i = 6 \text{ nF}$

Service interface (CDI)

Taking the following values into consideration, the device can be connected to the certified Endress+Hauser FXA291 service tool or a similar interface:

Service interface													
$U_i = 7.3 \text{ V}$ effective inner inductance $L_i = \text{negligible}$ effective inner capacitance $C_i = \text{negligible}$													
$U_o = 7.3 \text{ V}$ $I_o = 100 \text{ mA}$ $P_o = 160 \text{ mW}$													
$L_o \text{ (mH)} =$	5.00	2.00	1.00	0.50	0.20	0.15	0.10	0.05	0.02	0.01	0.005	0.002	0.001
$C_o \text{ (}\mu\text{F)}^{1) =}$	0.73	1.20	1.60	2.00	2.60	-	3.20	4.00	5.50	7.30	10.00	12.70	12.70
$C_o \text{ (}\mu\text{F)}^{2) =}$	-	0.49	0.90	1.40	-	2.00	-	-	-	-	-	-	-

- 1) Values according to PTB "ispark" program
- 2) Values according to IEC/EN 60079-25, Annex C



71532679

www.addresses.endress.com
