

Användarinstruktioner **Liquiphant M FTL51C**

Nivåvakt

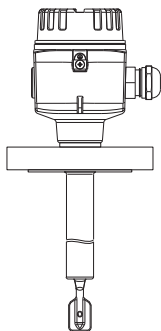

SV - Innehåll

Säkerhetsinformation	3
Handhavande	4
Enhetsbeteckning	6
Applikation	10
Mätsystem	11
Installation	15
Installation	24
Lampsymboler	28
Anslutningar	29
Underhåll	50
Teknisk information	51
Felsökning	52
Reservdelar	54
Reparation	55
Tilläggsdokumentation	56



Var försiktig!

= förbjudet:

Leder till felaktig drift eller förstörelse.

SV - Säkerhetsinformation

Liquiphant M FTL51C är utvecklad för nivådetektering i vätskor.

Om den används på fel sätt är det möjligt att risker relaterade till applikationen uppstår.

Liquiphant M FTL51C får endast installeras, anslutas, driftsättas, användas och underhållas **av kvalificerad och behörig personal**, och denna bruksanvisning, relevanta standarder, juridiska krav och, om tillämpligt, certifikatet, måste iakttas noga. Installera en lättåtkomlig strömbrytare i närheten av enheten. Markera strömbrytaren som avstängningsmekanism för enheten.

SV - Handhavande

Håll i den vid huset, flänsen eller förlängningstuben.

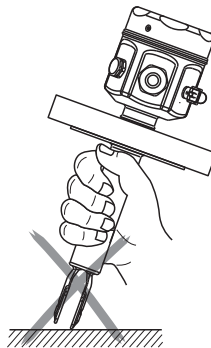
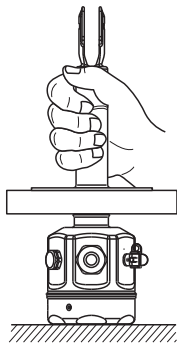
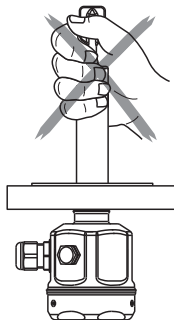
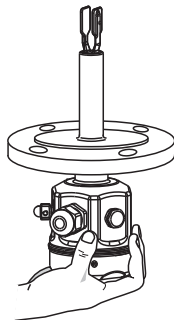

SV - Böj den **inte**
Skyddsbeläggning

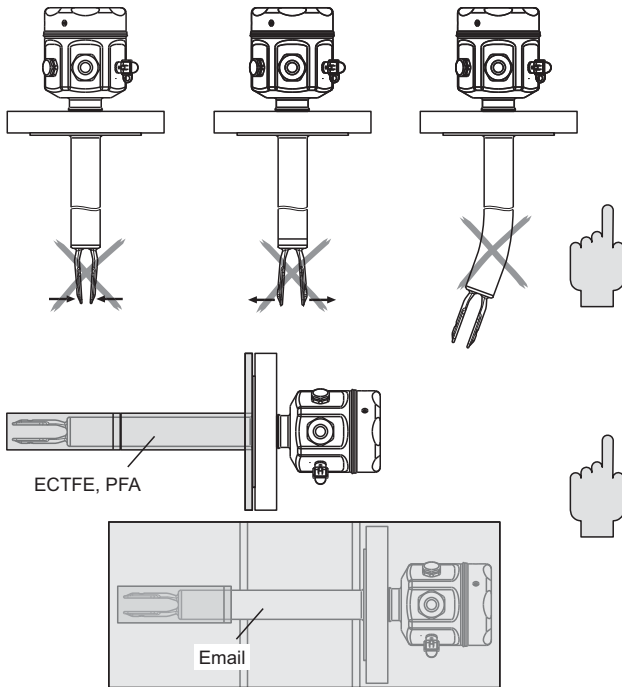

Email = emalj

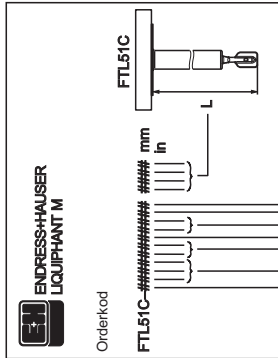

A *1

B ATEX II 3 G EEx nC II T6, WHG
ATEX II 3 D T 85°C, *3

C ATEX II 3 G EEx nA II T6, WHG
ATEX II 3 D T 85°C, *3

D *1, WHG

E ATEX II 1/2 G EEx de IIC T6, WHG

F ATEX II 1/2 G EEx ia IIC T6, WHG
ATEX II 1/2 D T 80°C, *3

L ATEX II 1/2 G EEx d IIC T6, WHG

M NEPSI, Ex ia IIC T6

N NEPSI, Ex d IIC T6

P FM, IS, Cl. I, II, III, Div. 1, Gr. A-G

Q FM, XP, Cl. I, II, III, Div. 1, Gr. B-G
E5 => Gr. A-G

R FM, Ni, Cl. I, Div. 2, Gr. A-D

S CSA, IS, Cl. I, II, III, Div. 1, Gr. A-G

T CSA, XP, Cl. I, II, III, Div. 1, Gr. A-G

U CSA Allmänt syfte

V TIIS, Ex ia IIC T3

W TIIS, Ex d IIB T3

X TIIS, Ex ia IIC T6

Y *2

1 ATEX II 1/2 G EEx ia IIB T6, WHG

2 ATEX II 1/2 G EEx d IIB T6, WHG

3 ATEX II 1/2 G EEx de IIB T6, WHG

4 ATEX II 1/2 G EEx ia IIC T6, WHG

5 ATEX II 1/2 G EEx d IIC T6, WHG

6 ATEX II 1/2 G EEx de IIC T6, WHG

7 TIIS, Ex d IIC T3

8 TIIS, Ex d IIC T6

A##
B##
C##
K##
Y#9

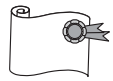

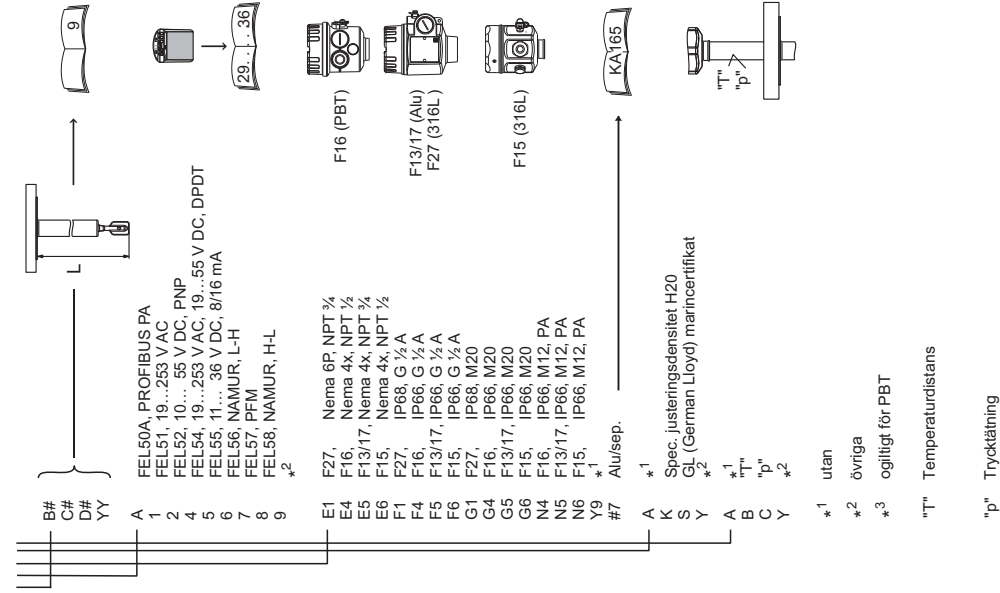

Längd L

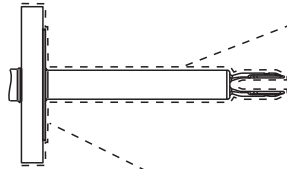
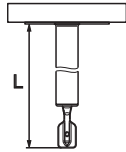
**ANSI B 16.5**

ACK 1/2", 150 lbs, ECTFE	>316/316L
ACL 1/2", 150 lbs, PFA (Edlon™)	>316/316L
ACM 1/2", 150 lbs, PFA (RubyRed)	>316/316L
ACN 1/2", 150 lbs, PFA (cond.)	>316/316L
AEK 2", 150 lbs, ECTFE	>316/316L
AEL 2", 150 lbs, PFA (Edlon™)	>316/316L
AEM 2", 150 lbs, PFA (RubyRed)	>316/316L
AEN 2", 150 lbs, PFA (cond.)	>316/316L
AES 2", 150 lbs, Email	>316/316L
AFK 2", 300 lbs, ECTFE	>316/316L
AFL 2", 300 lbs, PFA (Edlon™)	>316/316L
AFM 2", 300 lbs, PFA (RubyRed)	>316/316L
AFN 2", 300 lbs, PFA (cond.)	>316/316L
AFS 2", 300 lbs, Email	>316/316L
ALK 3", 150 lbs, ECTFE	>316/316L
ALL 3", 150 lbs, PFA (Edlon™)	>316/316L
ALM 3", 150 lbs, PFA (RubyRed)	>316/316L
ALN 3", 150 lbs, PFA (cond.)	>316/316L
APK 4", 150 lbs, ECTFE	>316/316L
APL 4", 150 lbs, PFA (Edlon™)	>316/316L
APM 4", 150 lbs, PFA (RubyRed)	>316/316L
AKN 4", 150 lbs, PFA (cond.)	>316/316L
A8K 1", 150 lbs, ECTFE	>316/316L
A8L 1", 150 lbs, PFA (Edlon™)	>316/316L
A8M 1", 150 lbs, PFA (RubyRed)	>316/316L
A8N 1", 150 lbs, PFA (cond.)	>316/316L

EN 1092-1 (DIN 2527)

BBK DN 32, PN 25/40, ECTFE	>316L
BBL DN 32, PN 25/40, PFA (Edlon™)	>316L
BBM DN 32, PN 25/40, PFA (RubyRed)	>316L
BBN DN 32, PN 25/40, PFA (cond.)	>316L
BDK DN 40, PN 25/40, ECTFE	>316L
BDL DN 40, PN 25/40, PFA (Edlon™)	>316L

BDM DN 40, PN 25/40, PFA (RubyRed) >316L
 BDN DN 40, PN 25/40, PFA (cond.) >316L
 BEK DN 50, PN 6, ECTFE >316L
 BEL DN 50, PN 6, PFA (Edlon™) >316L
 BEM DN 50, PN 6, PFA (RubyRed) >316L
 BEN DN 50, PN 6, PFA (cond.) >316L
 BGK DN 50, PN 25/40, ECTFE >316L
 BGL DN 50, PN 25/40, PFA (Edlon™) >316L
 BGM DN 50, PN 25/40, PFA (RubyRed) >316L
 BGN DN 50, PN 25/40, PFA (cond.) >316L
 BNK DN 80, PN 25/40, ECTFE >316L
 BNL DN 80, PN 25/40, PFA (Edlon™) >316L
 BNM DN 80, PN 25/40, PFA (RubyRed) >316L
 BNN DN 80, PN 25/40, PFA (cond.) >316L
 BQK DN 100, PN 10/16, ECTFE >316L
 BQL DN 100, PN 10/16, PFA (Edlon™) >316L
 BQM DN 100, PN 10/16, PFA (RubyRed) >316L
 BQN DN 100, PN 10/16, PFA (cond.) >316L
 B8K DN 25, PN 25/40, ECTFE >316L
 B8L DN 25, PN 25/40, PFA (Edlon™) >316L
 B8M DN 25, PN 25/40, PFA (RubyRed) >316L
 B8N DN 25, PN 25/40, PFA (cond.) >316L
 CGS DN 50, PN 25/40, Email >1.0487
 CNS DN 80, PN 25/40, Email >1.0487

JIS B 2220

KEK 10K 50A, ECTFE >316L
 KEL 10K 50A, PFA (Edlon™) >316L
 KEM 10K 50A, PFA (RubyRed) >316L
 KEN 10K 50A, PFA (cond.) >316L

YY9 #2

L

BK 148 mm...3000 mm
 BLmm, ECTFE ---
 BMmm, PFA (Edlon™)
 BNmm, PFA (RubyRed)
 BS 148 mm...1200 mm
mm, Email
 CK 6 in...115 in
in, ECTFE
 CLin, PFA (Edlon™)
 CMin, PFA (RubyRed)
 CNin, PFA (cond.)
 CS 6 in...46 in
in, Email
 DK "L II", ECTFE
 DL "L II", PFA (Edlon™)
 DM "L II", PFA (RubyRed)
 DN "L II", PFA (cond.)
 DS "L II", Email
 YY #2

#2 övriga

"L II" Omkopplingspunkt

Liquiphant II
FTL360/365, FDL30/35

Email Emalj

cond. Ledande

SV - Applikation

Nivådetektering i vätskor

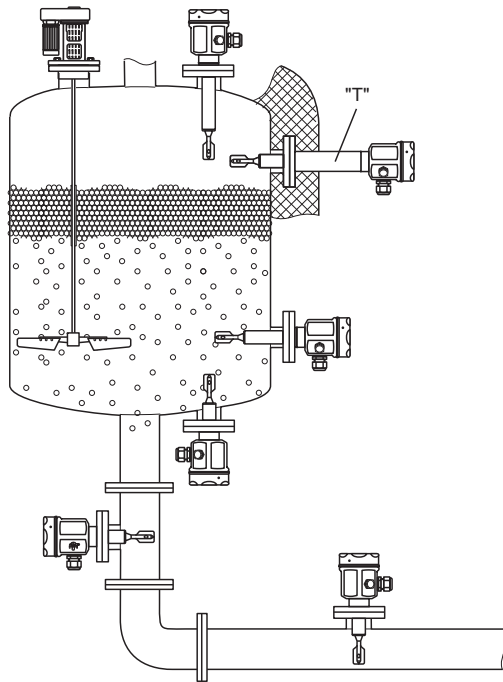

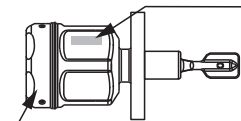

Elektronikinsatser

Orderkod:
FTL51C - # ### # # # #

FEL51
FEL52
FEL54

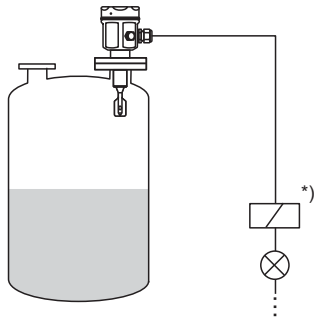

*) Extern last

SV - Mätssystem
för direktanslutning

SV - Mätssystem

för anslutning via
omkomplingsenhet

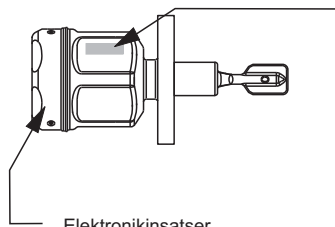

Elektronikinsatser

Orderkod:

FTL51C - # ### ## # ## #

**FEL55
FEL56
FEL57
FEL58**

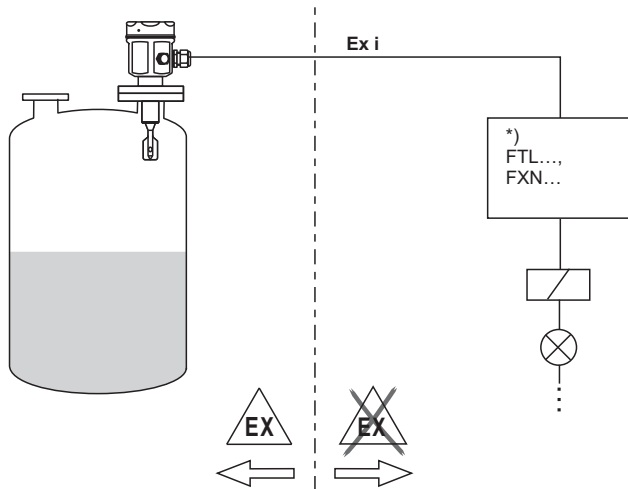

*) Omkopplingsenhet, PLC, isoleringsförstärkare

SV - Mätssystem

för anslutning till PROFIBUS PA

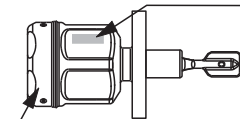

Elektronikinsats

Orderkod:

FTL51C - # ## # # # #

FEL50A

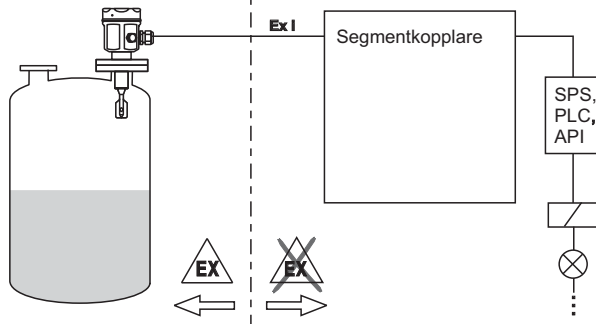

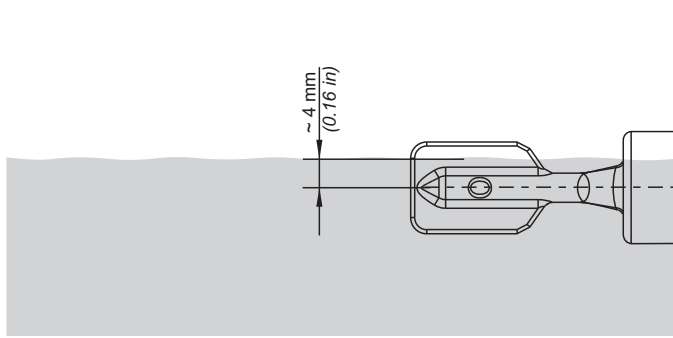
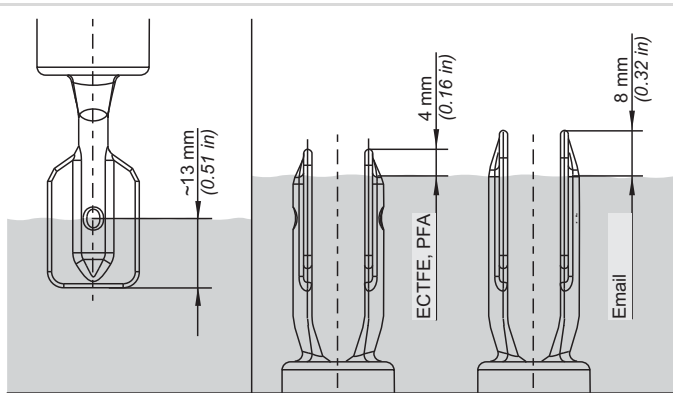

SV - Installation

Omkopplingspunkten beror på monteringspositionen

SV - Monteringsexempel
som en funktion av
vätskeviskositetv

$v = 0 \dots 2000 \text{ mm}^2/\text{s}$
($v = 0 \dots 2000 \text{ cSt}$)

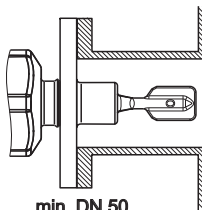

min. DN 50
(min. 2")

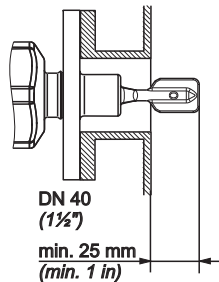

DN 40
(1½")

min. 25 mm
(min. 1 in)

$v = 0 \dots 10000 \text{ mm}^2/\text{s}$
($v = 0 \dots 10000 \text{ cSt}$)

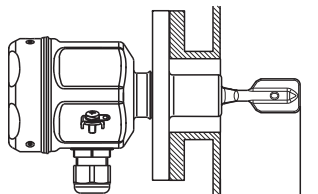

min. 40 mm
(min. 1.6 in)

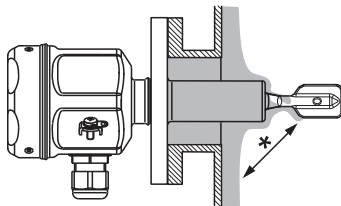
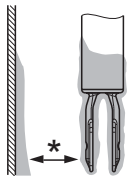

* Avstånd!

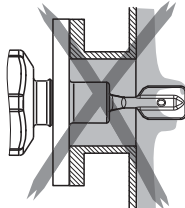
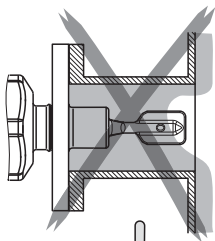
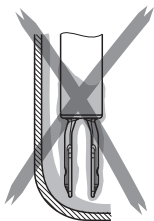

SV - Tänk på avlagringarna.
Gaffeln får inte vara i kontakt med
avlagringarna.

Beläggning:

plast



Beläggning:

emalj

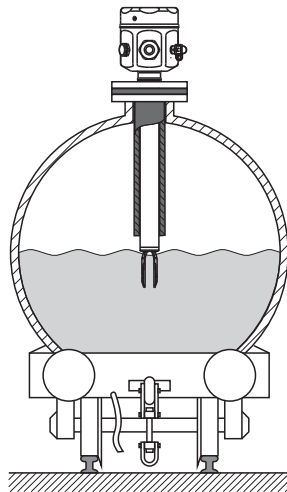
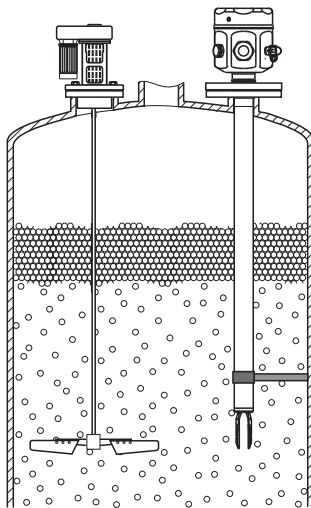

"T" = med temperaturdistanser för insulerade tankar

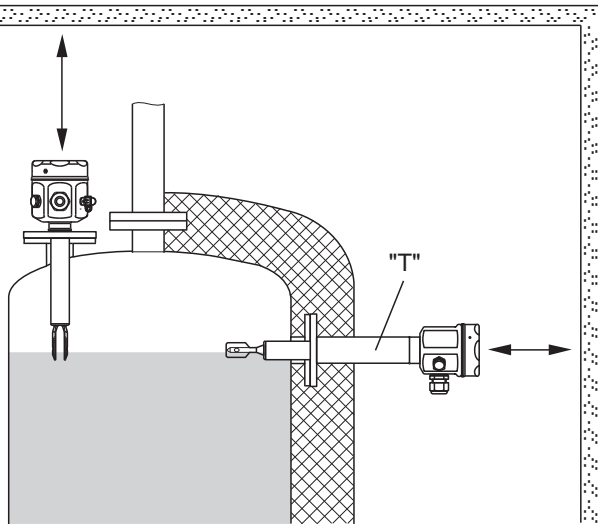

SV - Skyddsbeläggning
Observera temperaturen.

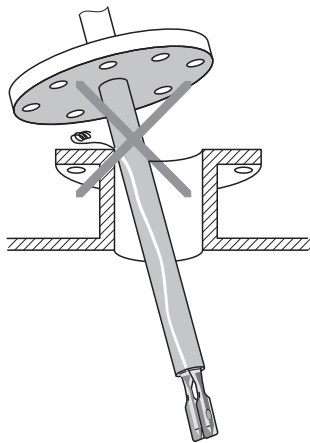

Repa inte!

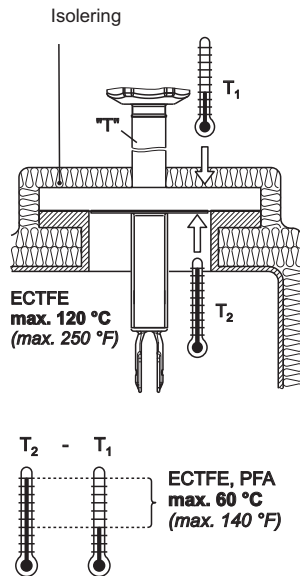

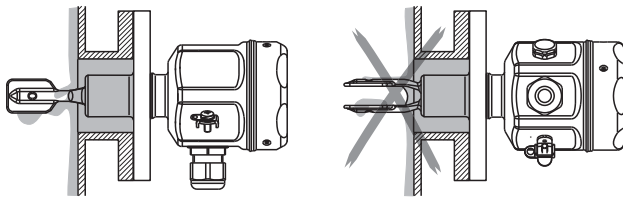

SV - Rikta in gaffelklorna:
Markering ovanpå eller under

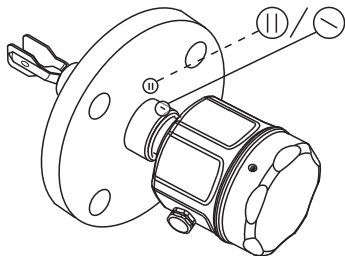

SV - Placering inuti rör:
Markering i flödesriktningen

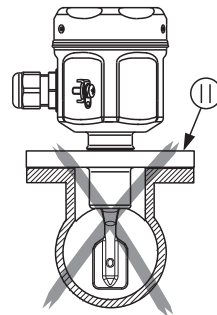
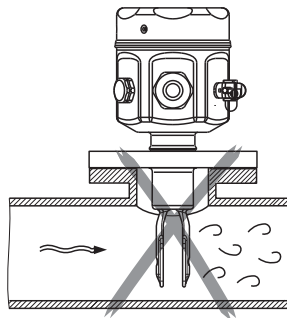
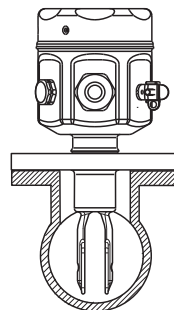
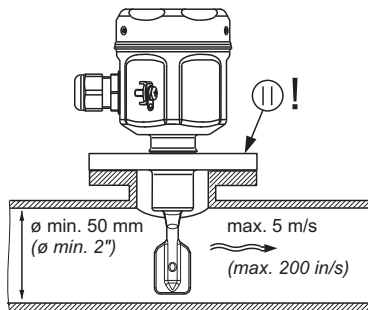

F15, F27

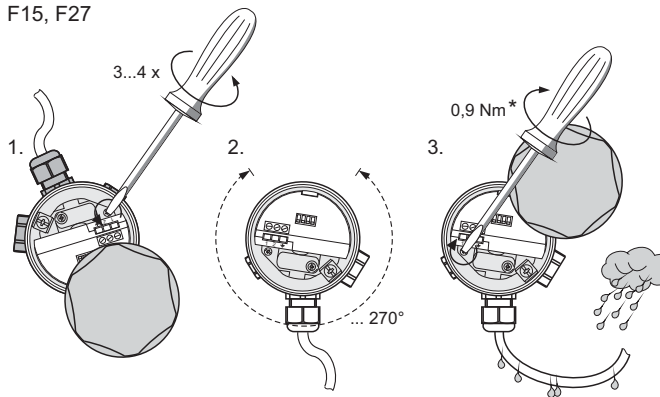

F16, F13, F17

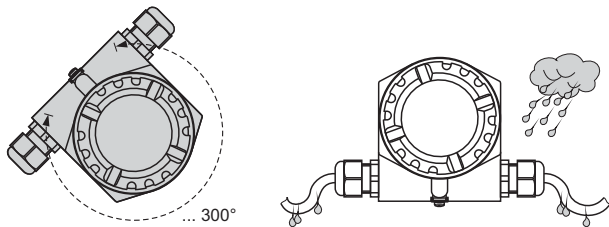

SV - Justera kabelförskruvningen

* Vridmoment

SV - Installation

Minsta/maximala felsäkra läge.

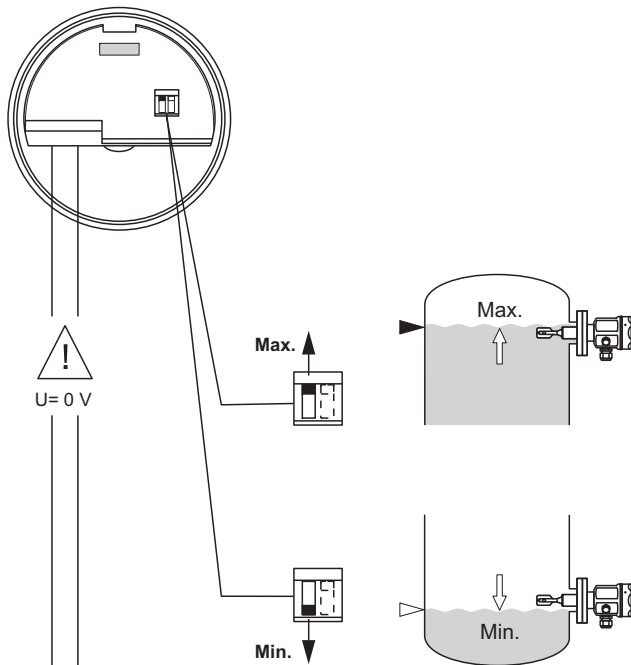

FEL51, FEL52, FEL54,
FEL55, FEL56, FEL57, FEL58

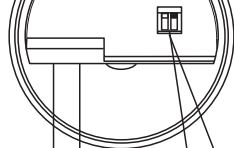

Standardlösning

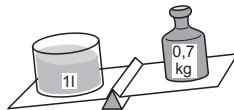

$1 \text{ l (1 dm}^3\text{)} = \text{min } 0,7 \text{ kg}$
 $(1 \text{ imp.gal} = \text{min. } 7,0 \text{ lbs})$
 $(1 \text{ US. gal} = \text{min. } 5,9 \text{ lbs})$

$U = 0 \text{ V}$

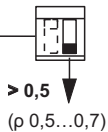

t.ex. propan

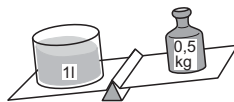

$1 \text{ l (1 dm}^3\text{)} = 0,5 \dots 0,7 \text{ kg}$
 $(1 \text{ imp.gal} = 5,0 \dots 0,7 \text{ lbs})$
 $(1 \text{ US. gal} = 4,2 \dots 5,9 \text{ lbs})$

SV - Vätskans densitet.
Densitet ρ mätt i g/cm^3
eller i kg/l .

SV - Funktionstest

Testa fasen på omkopplaren
(se sidan 42, 43 och
omkopplingsenheten)

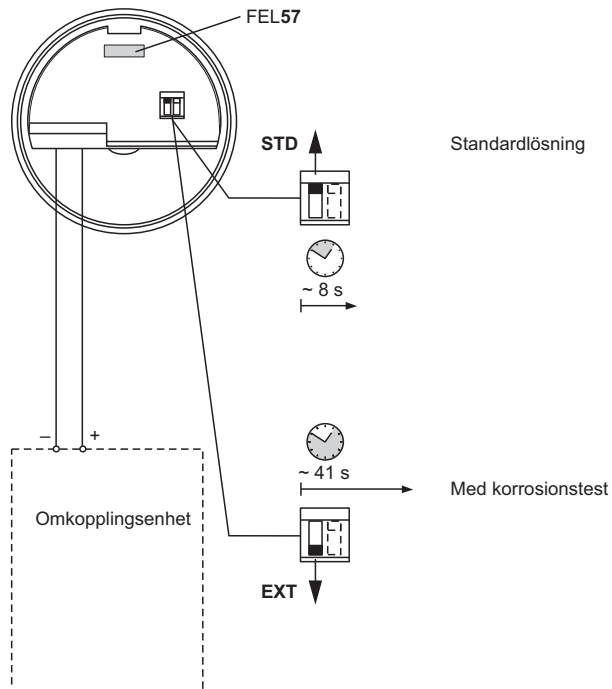

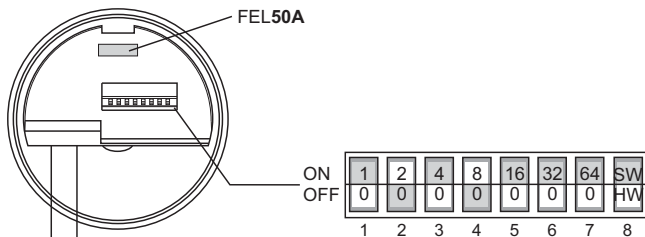

Exempel:

$2 + 8 = 10 = \text{Adress}$

Segmentkopplare

t.ex. PLC

SV - Ange enhetens adress
(Ange parametrarna,
se BA141F)

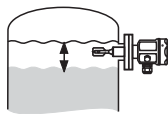

Variera nivå

Lysdioder



Stand-by



Omkopplarens status



FEL57, FEL50A: Täckning



TILL



blinkar



FRÅN



Utsignal



Fel

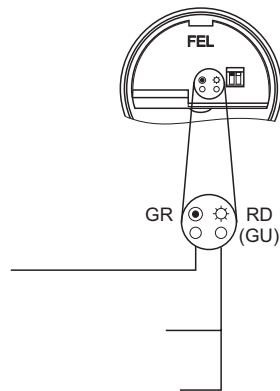



Följ nationella föreskrifter.

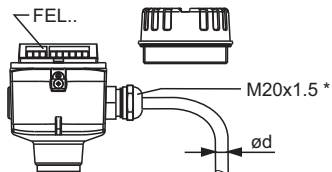

max. 2,5 mm²
(max. AWG 14)

max. 4 mm²
(max. AWG 12)

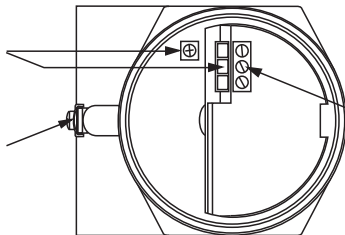

3 mm
(1/8 in)

SV - Anslutningar

*Kabelingång

Nickelpläterad mässing:

$\varnothing d = 7-10,5$ mm

(0,28-0,41 tum)

Plast:

$\varnothing d = 5-10$ mm (0,2-0,38 tum)

Rostfritt stål:

$\varnothing d = 7-12$ mm (0,28-0,47 tum)

SV- Anslutningar FEL51
Tvåkabelanslutning, AC

 Förbjudet

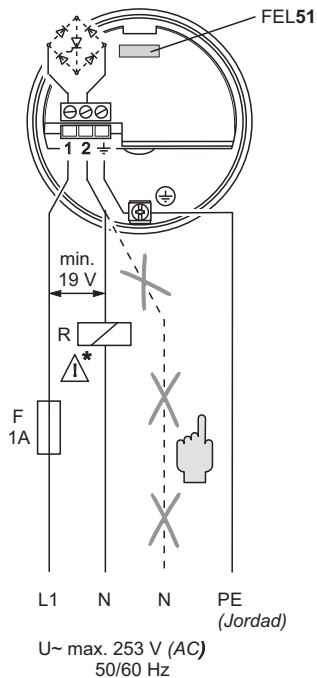

* Extern last R
måste anslutas

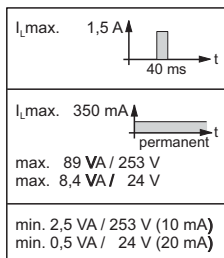

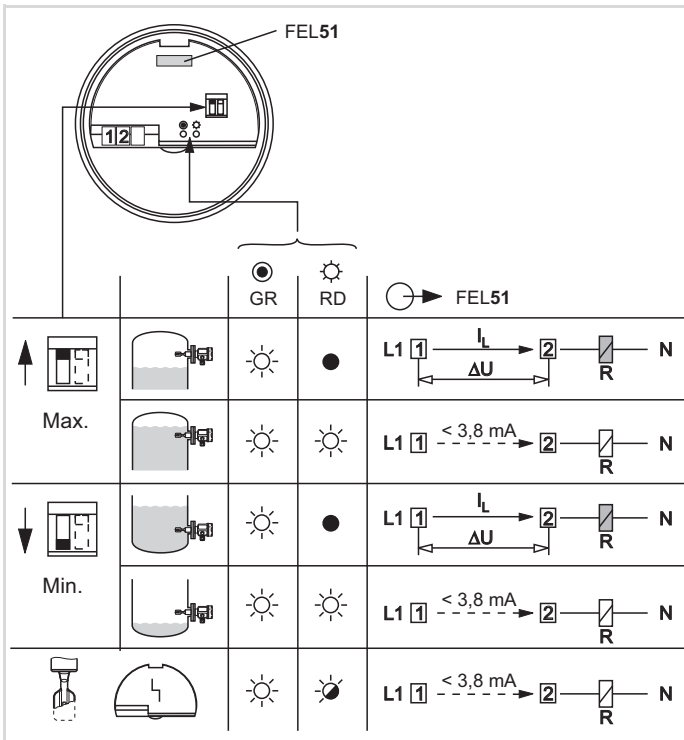
 $\Delta U_{\text{FEL51}} \text{ max. } 12 \text{ V}$

SV- Anslutningar FEL52
Likströmsanslutning (PNP)

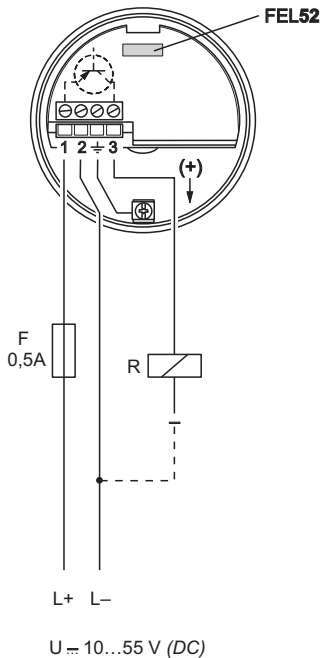

även för DI-moduler

EN 61131- 2



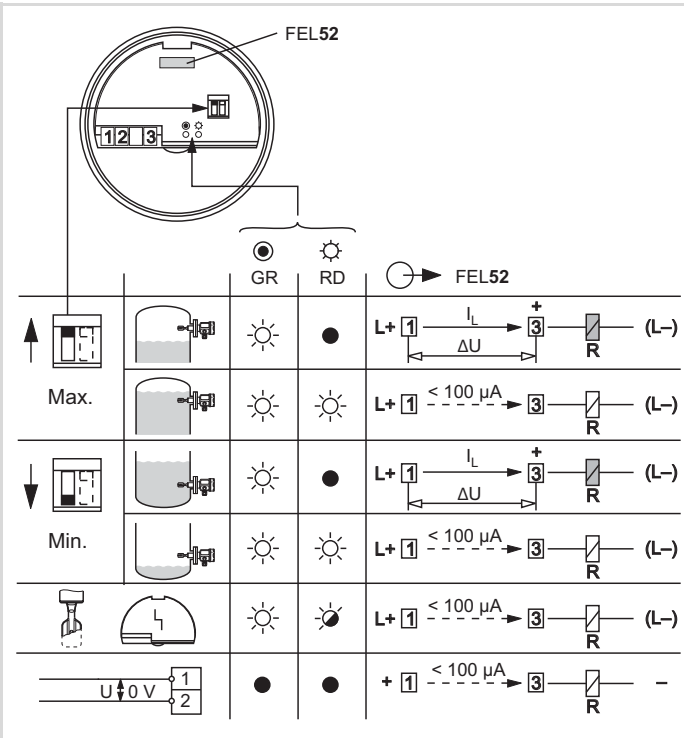

ΔU_{FEL52} max. 3 V

SV- Anslutningar FEL54
 Universalanslutning
 Reläutgång

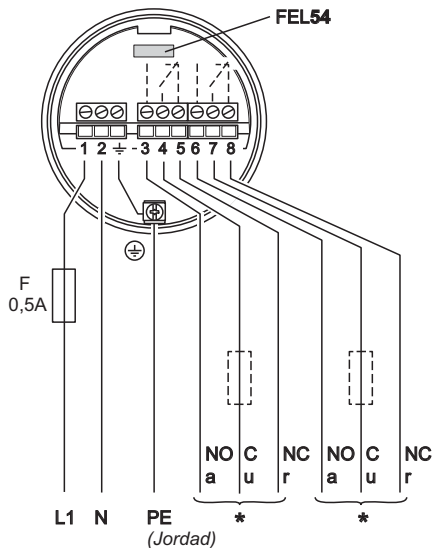

U~ 19...253 V (AC)

**L+ L-
 U= 19... 55 V (DC)**

- I~** max. 6 A (**EEx de: 4 A**)
- U~** max. 253 V AC,
- P~** max. 1500 VA, $\cos \varphi = 1$
- *** **P~** max. 750 VA, $\cos \varphi > 0,7$
- I=** max. 6 A (**EEx de: 4 A**), **U_m** < 30 V
- I=** max. 0,2 A, **U_m** < 125 V

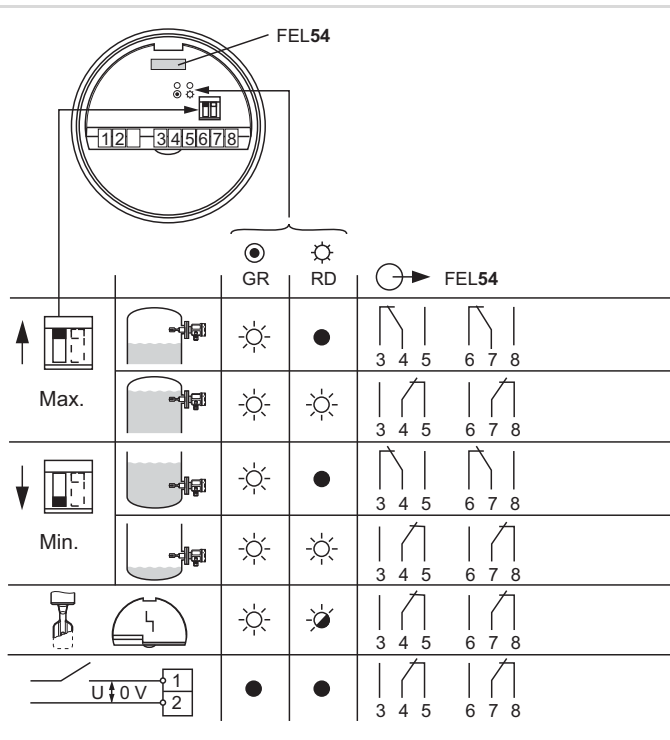

SV- Anslutningar FEL55

Utgång 8/16 mA

* Våt plats.

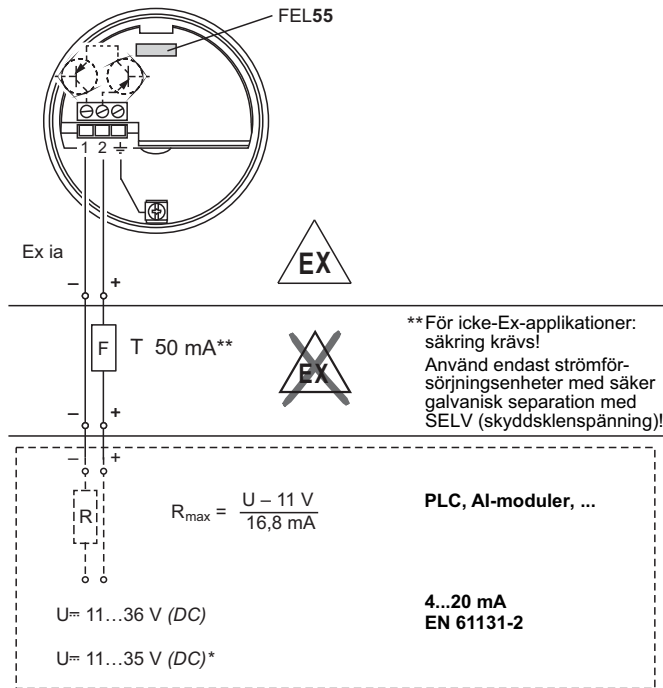

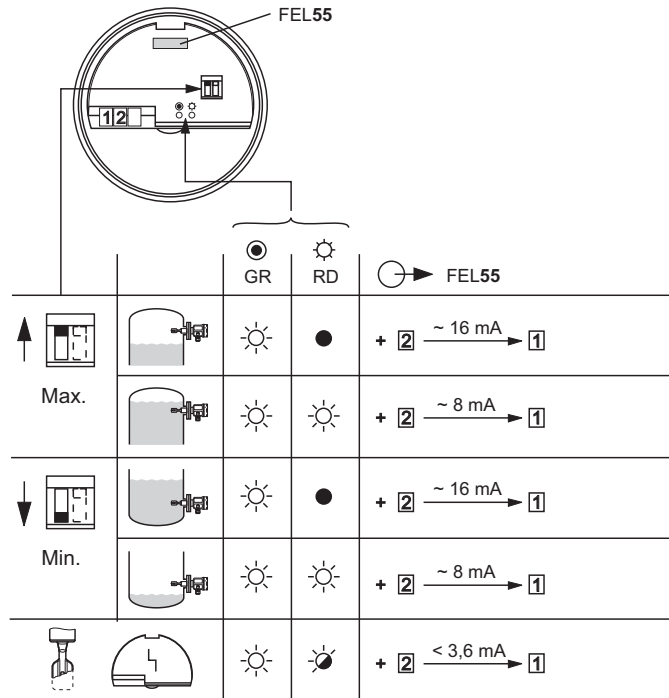

SV- Anslutningar FEL56
NAMUR utgång L-H
< 1,0 mA / > 2,2 mA

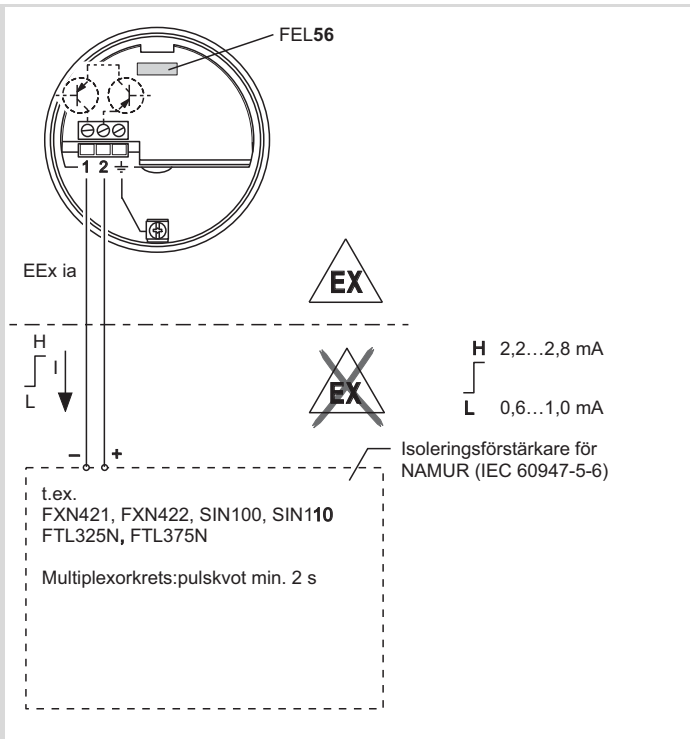

Strömförsörjning



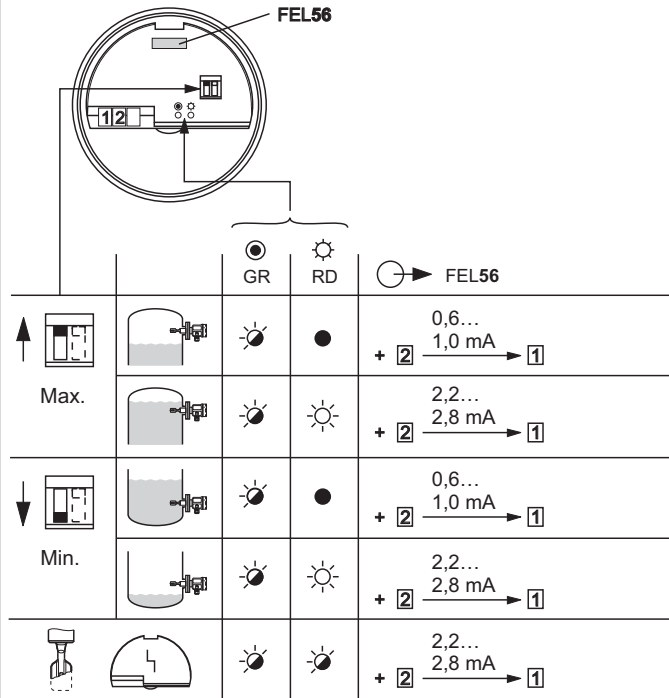



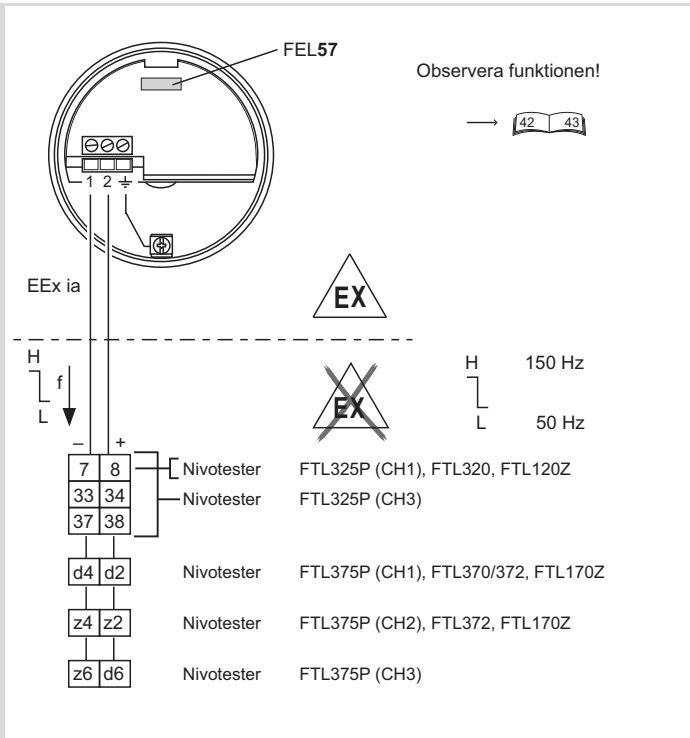

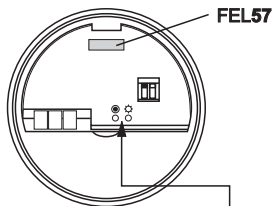





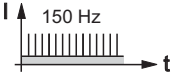

Likström: 8,2 V +/- 20 %



SV- Anslutningar FEL 57
 PFM-utgång
 150 Hz/50 Hz



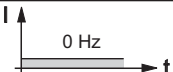
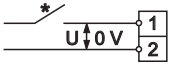

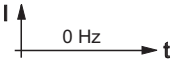
	 GR	 GU	 FEL57
			
			
			
			

* Omkopplarens funktion



SV- Funktion FEL57
Omkopplarens funktion STD

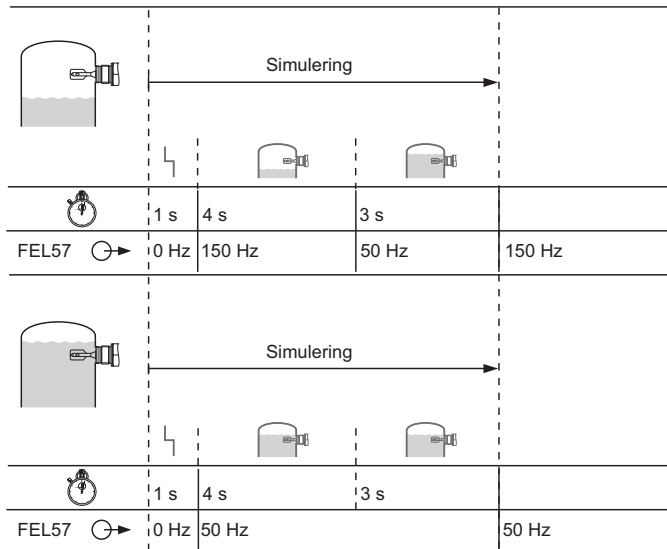
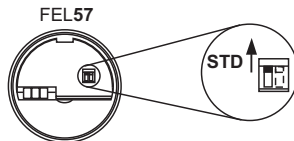

SV - Funktion FEL57
Omkopplarens funktion EXT

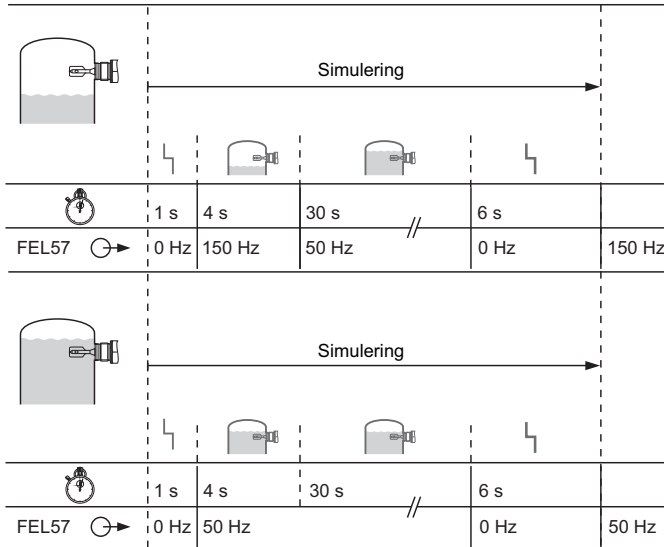
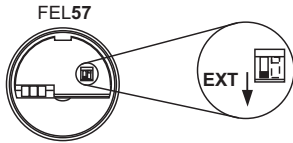

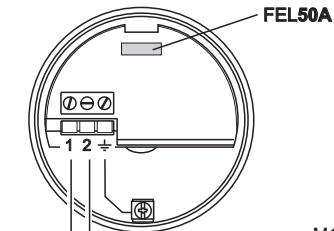



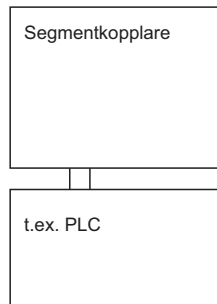



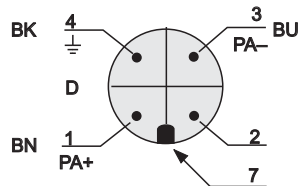



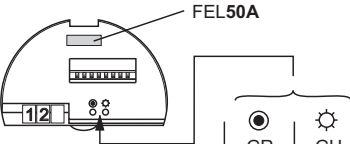
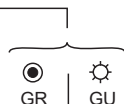









PA- PA+
U... 9...32 V (DC)



M12-kontakt

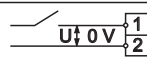

Enhetskontakt på hus (hane)

				 FEL50A
				PA Bussignal
ej inverterad				OUT_D = 0
				OUT_D = 1
inverterad				OUT_D = 0
				OUT_D = 1
			-	Kommunikation
		-		Status, se BA141F
				../..

SV- Anslutningar FEL58
NAMUR utgång H-L
> 2,2 mA / < 1,0 mA

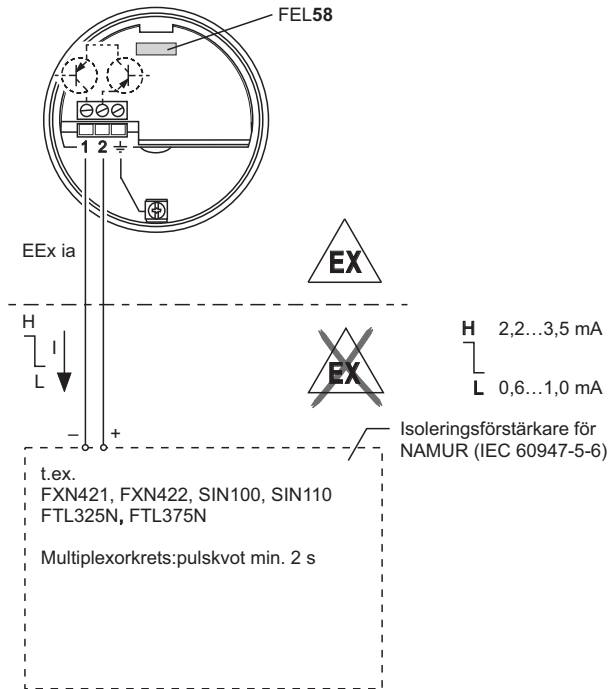

Strömförsörjning

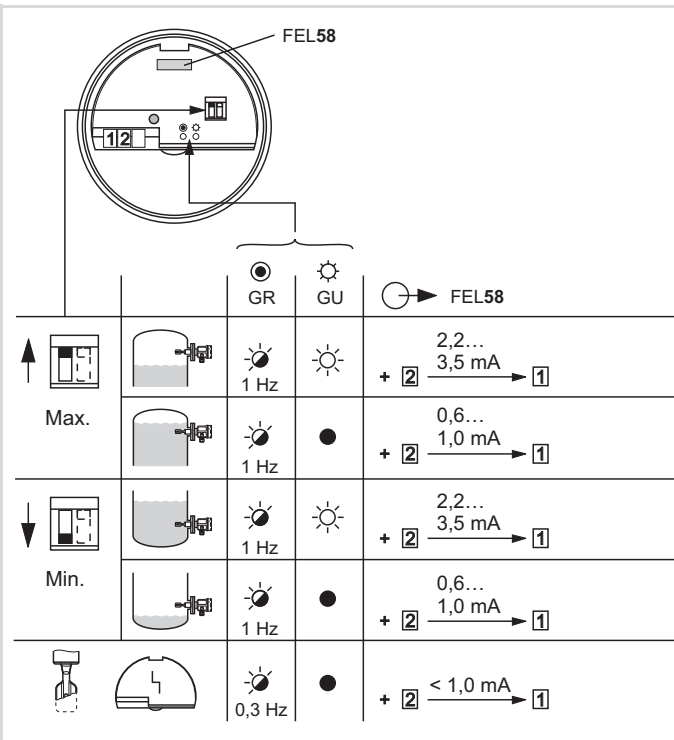

Likström: 8,2 V +/- 20 %



SV - Funktionstestknapp FEL58
Felsäkert läge MAX.



1. Normal drift

GR  GU 
1 Hz

GR  GU 
1 Hz

+ 2,2...
3,5 mA → 1

+ 0,6...
1,0 mA → 1

2. Tryck ner testknappen



GR  GU 



GR  GU 

+ 0 mA → 1

+ 0 mA → 1

3. Släpp testknappen efter
ungefär 2 sekunders
normal drift



GR  GU 
1 Hz







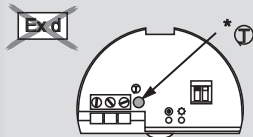











GR  GU 
1 Hz

+ 2,2...
3,5 mA → 1

+ 0,6...
1,0 mA → 1



SV - Funktionstestknapp FEL58
Felsäkert läge MIN.

<p>MIN  + </p>		
<p>1. Normal drift</p>	<p>GR  GU  1 Hz + 2,2... 3,5 mA → 1</p>	<p>GR  GU  1 Hz + 0,6... 1,0 mA → 1</p>
<p>2. Tryck ner testknappen  >3 s</p>	<p>GR  GU  + 0 mA → 1</p>	<p>GR  GU  + 0 mA → 1</p>
<p>3. Släpp testknappen efter ungefär 2 sekunders normal drift </p>	<p>GR  GU  1 Hz + 2,2... 3,5 mA → 1</p>	<p>GR  GU  1 Hz + 0,6... 1,0 mA → 1</p>

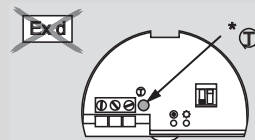

SV - Underhåll

Ta bort tjocka avlagringar
Kontrollera beläggningen

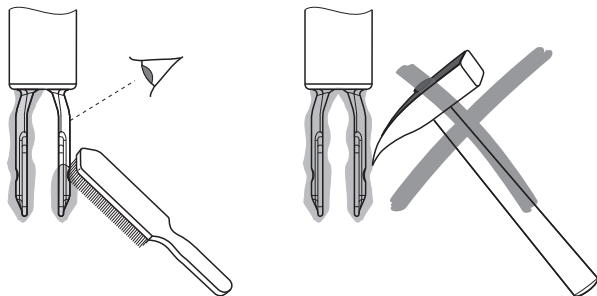

Använd **inte**
som fotsteg!

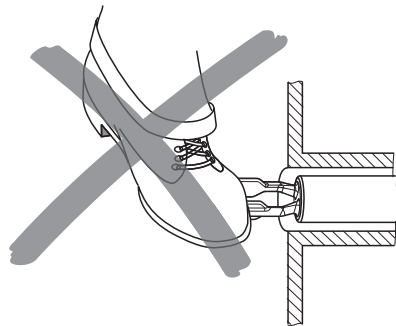

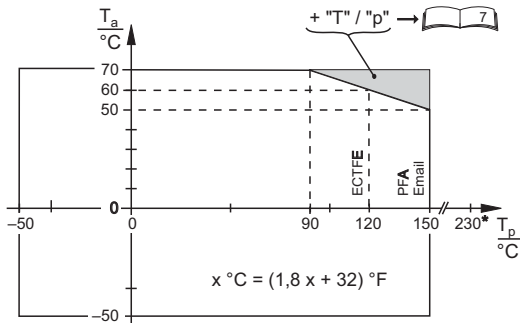
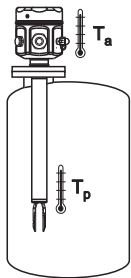

Processtryck

Se fläsar sidan 8–9

p_e = ECTFE, PFA: max. 40 bar (580 psi); Email: max. 25 bar (360 psi)

Densitet ρ

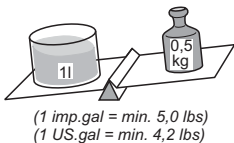

Viskositet ν

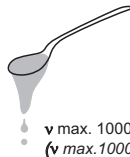

SV - Teknisk information

Omgivningstemperatur T_a

Processtemperatur T_p

* på begäran

Fel	Orsak	Åtgärd
Omkopplar inte	Ingen ström	Kontrollera strömmen
	Fel på signalledningen	Kontrollera signalledningen
	Trasig elektronikinsats – FEL51 ansluten direkt till L1 och N	Byt – anslut alltid FEL51 via extern last
	Vätskans densitet är för låg	Ange densiteten till > 0,5 på elektronikinsatsen
	Gaffeln har avlagringar	Rengör gaffeln
	Gaffeln har korroderat (Indikation på FEL: Det blinkar rött/gult, FEL58: Det blinkar grönt 0,3 Hz)	Byt gaffel och processanslutning
	FEL51: Intern motstånd hos anslutet relä för stort	Anslut lämpligt relä
	FEL51: Hållströmmen till anslutet relä för låg	Anslut motstånd parallellt med relä
	FEL54: Kontakter har svetsats samman (efter kortslutning)	Byt FEL54: Sätt säkringen i kontaktkretsen
Kopplar felaktigt	Min-/Max-felsäkert läge har ställts in fel	Ange korrekt läge på elektronikinsatsen
Sporadiskt felaktig omkoppling	Tjockt, tungt skum, mycket turbulens, skummande vätska	Montera Liquiphant i bypassrör
	Extrem elektromagnetisk störning	Använd skärmad kabel
	Extrem vibration	Koppla ifrån den, dämpa, vrid gaffeln 90°
	Vatten i huset	Skruva åt locket och kabelförskruvningen hårt
	FEL52: Överbelastad utgång	Minska belastningen, (kabel) kapacitans
Omkopplar på fel sätt efter strömavbrott	FEL57: funktion under test när omkopplaren är på (funktionstest)	Observera hur omkopplaren fungerar vid FEL57. Efter strömavbrott, blockera anläggningsstyrning i upp till 45 sekunder

SV - Felsökning – Tillägg

Om gaffeln inte omkopplar normalt kan gaffelns frekvens ställas in till PIN 4 på diagnosuttaget.

Vid elektronikinsatserna FEL51/52/54/55/56/57/58 uppstår en sinusformad vibration vars amplitud gör det möjligt att avgöra skicket på gaffeln.

Vid FEL50A går det på grund av en rektangulär pulssignal endast att mäta gaffelns frekvens.

SV - Reservdelar

Elektronikinsatser



FEL51	52002304
FEL52	52002305
FEL54	52002306
FEL55	52002307
FEL56	52002308
FEL57	52002309
FEL58	52006454
FEL50A	52010527

Installationsbeskrivning: Under installationen måste du tänka på att elektriska resurser (elektronikinsatser) som drivs av icke-egensäkra kretsar **inte** längre kan kopplas till egensäkra kretsar.

SV - Reparation
hos Endress+Hauser

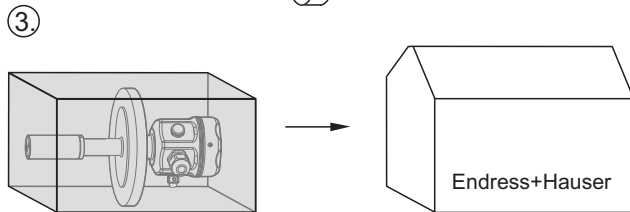
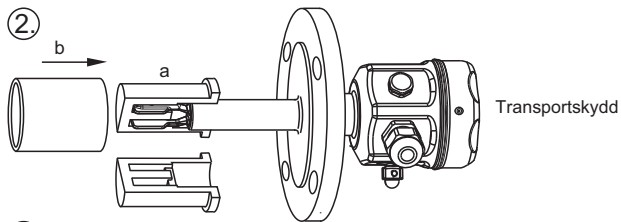
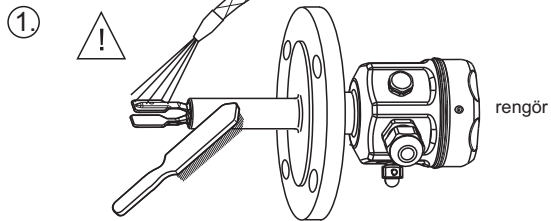











Teknisk information

TI00347F Liquiphant FTL51C
TI00426F Svetsadapter, nivå och tryck

Driftinstruktioner

BA00141F FEL50A, PROFIBUS PA

Säkerhetsinformation

XA00031F	CE 	II 1/2 G,	Ex d	IIC/IIB
XA00063F	CE 	II 1/2 G, II 1/2 D,	Ex ia/ib	IIC/IIB
XA00064F	CE 	II 1 G,	Ex ia	IIC/IIB
XA00108F	CE 	II 1/2 G,	Ex de	IIC/IIB
XA00113F	CE 	II 1/2 G,	Ex ia/ib	IIC
XA00114F	CE 	II 1/2 G,	Ex d	IIC
XA00115F	CE 	II 1/2 G,	Ex de	IIC
XA00154F	CE 	II 1/2 G, II 1/2 D,	Ex ia/ib	IIC/IIB
XA00158F	CE 	II 1/2 G,	Ex ia/ib	IIC
XA00159F	CE 	II 1 G,	Ex ia	IIC/IIB
XA00182F	CE 	II 3 G, II 3 D,	Ex nA/nC	IIC/IIIC



71541610

www.endress.com/worldwide
