

# Functional Safety Manual

## Levelflex FMP57

Guided wave radar for bulk solids with 4-20 mA output signal





A0023555

## Table of contents

<b>1</b>	<b>Declaration of Conformity</b> . . . . .	<b>4</b>	<b>5</b>	<b>Operation</b> . . . . .	<b>20</b>
1.1	Safety-related characteristic values . . . . .	5	5.1	Device behavior during power-up . . . . .	20
<b>2</b>	<b>About this document</b> . . . . .	<b>6</b>	5.2	Device behavior in safety function demand mode . . . . .	20
2.1	Document function . . . . .	6	5.3	Behavior of device in the event of an alarm and warnings . . . . .	20
2.2	Symbols used . . . . .	6	5.4	Alarm and warning messages . . . . .	20
2.2.1	Safety symbols . . . . .	6	5.4.1	Exceptions . . . . .	21
2.2.2	Symbols for certain types of information and graphics . . . . .	6	<b>6</b>	<b>Proof testing</b> . . . . .	<b>21</b>
2.3	Supplementary device documentation . . . . .	7	6.1	Test sequence A . . . . .	22
2.3.1	Further applicable documents . . . . .	7	6.2	Test sequence B . . . . .	23
2.3.2	Technical Information (TI) . . . . .	7	6.3	Test sequence C . . . . .	24
2.3.3	Operating Instructions (BA) . . . . .	7	6.4	Verification criterion . . . . .	25
2.3.4	Brief Operating Instructions (KA) . . . . .	7	<b>7</b>	<b>Repair and error handling</b> . . . . .	<b>25</b>
2.3.5	Description of Device Parameters (GP) . . . . .	7	7.1	Maintenance . . . . .	25
2.3.6	Certificate . . . . .	7	7.2	Repair . . . . .	25
<b>3</b>	<b>Design</b> . . . . .	<b>8</b>	7.3	Modification . . . . .	27
3.1	Permitted device types . . . . .	8	7.4	Decommissioning . . . . .	28
3.1.1	Order codes . . . . .	8	7.5	Disposal . . . . .	28
3.2	Identification marking . . . . .	9	7.6	Battery disposal . . . . .	28
3.3	Safety function . . . . .	9	<b>8</b>	<b>Appendix</b> . . . . .	<b>28</b>
3.3.1	Safety-related output signal . . . . .	9	8.1	Structure of the measuring system . . . . .	28
3.3.2	Redundant configuration of multiple sensors . . . . .	10	8.1.1	System components . . . . .	28
3.4	Basic conditions for use in safety-related applications . . . . .	10	8.1.2	Description of use as a safety instrumented system . . . . .	29
3.4.1	Safety-related failures according to IEC / EN 61508 . . . . .	10	8.1.3	Installation conditions . . . . .	29
3.4.2	Restrictions for safety-related use . . . . .	11	8.2	Commissioning or proof test report . . . . .	30
3.5	Dangerous undetected failures in this scenario . . . . .	11	8.2.1	Test Report . . . . .	31
3.6	Useful lifetime of electric components . . . . .	11	8.3	Version history . . . . .	33
<b>4</b>	<b>Commissioning (installation and configuration)</b> . . . . .	<b>12</b>			
4.1	Requirements for personnel . . . . .	12			
4.2	Installation . . . . .	12			
4.3	Commissioning . . . . .	12			
4.4	Operation . . . . .	12			
4.5	Device configuration for safety-related applications . . . . .	12			
4.5.1	Calibration of the measuring point . . . . .	12			
4.5.2	Configuration methods . . . . .	13			
4.5.3	Locking in "Increased safety mode" . . . . .	13			
4.5.4	Locking in Expert mode . . . . .	14			
4.5.5	Unlocking a SIL device . . . . .	15			
4.6	Parameters and default settings for SIL mode . . . . .	16			

# 1 Declaration of Conformity

SIL\_00471\_01.21

**Endress+Hauser**   
People for Process Automation

## Declaration of Conformity

Functional Safety according to IEC 61508  
Based on NE 130 Form B.1

Endress+Hauser SE+Co. KG, Hauptstraße 1, 79689 Maulburg

being the manufacturer, declares that the product

**Levelflex FMP50/51/52/53/54/55/56/57**

is suitable for the use in safety-instrumented systems according to IEC 61508. The instructions of the corresponding functional safety manual must be followed.

This declaration of compliance is exclusively valid for the customer listed in the cover letter of the respective Endress+Hauser sales center and for the listed products and accessories in delivery status.

Maulburg, July 20th, 2021  
Endress+Hauser SE+Co. KG

i. V.



Thorsten Springmann  
Dept. Man. R&D Devices Level Continuous  
Research & Development

i. V.



Manfred Hammer  
Dept. Man. R&D Quality Management/FSM  
Research & Development

A0047150

# 1.1 Safety-related characteristic values

SIL\_00471\_01.21



General			
Device designation and permissible types <sup>1)</sup>	Guided level radar, Levelflex FMP5x-**y*****+LA x=0...7, y=A,B,C,K		
Safety-related output signal	4...20 mA		
Fault signal	≤ 3,6 mA ; ≥ 21 mA		
Process variable/function	Level or Interface Measurement		
Safety function(s)	MIN , MAX , Range		
Device type acc. to IEC 61508-2	<input type="checkbox"/> Type A		<input checked="" type="checkbox"/> Type B
Operating mode	<input checked="" type="checkbox"/> Low Demand Mode	<input checked="" type="checkbox"/> High Demand Mode	<input type="checkbox"/> Continuous Mode
Valid hardware version	As of manufacturing date after January 28, 2011		
Valid software version	As of version V01.01.ZZ		
Safety manual	FY01057F, FY01058F, FY01059F, FY01060F, FY01061F, FY01062F, FY01063F, FY01064F		
Type of evaluation (check only <u>one</u> box)	<input checked="" type="checkbox"/>	Complete HW/SW evaluation parallel to development incl. FMEDA and change request acc. to IEC 61508-2, 3	
	<input type="checkbox"/>	Evaluation of "proven in use" performance for HW/SW incl. FMEDA and change request acc. to IEC 61508-2, 3	
	<input type="checkbox"/>	Evaluation of HW/SW field data to verify „prior use" acc. to IEC 61511	
	<input type="checkbox"/>	Evaluation by FMEDA acc. to IEC 61508-2 for devices w/o software	
Evaluation through – report/certificate no.	TÜV Rheinland Industry Service GmbH - 968/EL 733		
Test documents	Development documents	Test reports	Data sheets
SIL - Integrity			
Systematic safety integrity		<input type="checkbox"/> SIL 2 capable	<input checked="" type="checkbox"/> SIL 3 capable
Hardware safety integrity	Single channel use (HFT = 0)	<input checked="" type="checkbox"/> SIL 2 capable	<input type="checkbox"/> SIL 3 capable
	Multi channel use (HFT ≥ 1)	<input type="checkbox"/> SIL 2 capable	<input checked="" type="checkbox"/> SIL 3 capable
FMEDA			
Safety function	MIN	MAX	Range
λ <sub>DU</sub> <sup>2),3)</sup>	197 FIT	197 FIT	197 FIT
λ <sub>DP</sub> <sup>2),3)</sup>	2504 FIT	2504 FIT	2504 FIT
λ <sub>SU</sub> <sup>2),3)</sup>	801 FIT	801 FIT	801 FIT
λ <sub>SD</sub> <sup>2),3)</sup>	54 FIT	54 FIT	54 FIT
SFF	94 %	94 %	94 %
PFD <sub>avg</sub> (T <sub>1</sub> = 1 year) <sup>3)</sup> (single channel architecture)	8.82 × 10 <sup>-4</sup>	8.82 × 10 <sup>-4</sup>	8.82 × 10 <sup>-4</sup>
PFD <sub>avg</sub> (T <sub>1</sub> = 3 years) <sup>3)</sup> (single channel architecture)	2.61 × 10 <sup>-3</sup>	2.61 × 10 <sup>-3</sup>	2.61 × 10 <sup>-3</sup>
PFH	1.97 × 10 <sup>-7</sup> 1/h	1.97 × 10 <sup>-7</sup> 1/h	1.97 × 10 <sup>-7</sup> 1/h
PTC <sup>4)</sup>	99 %	99 %	99 %
λ <sub>total</sub> <sup>2),3)</sup>	3556 FIT	3556 FIT	3556 FIT
Diagnostic test interval <sup>5)</sup>	30 min	30 min	30 min
Fault reaction time <sup>6)</sup>	30 s	30 s	30 s
Comments			
-			
Declaration			
<input checked="" type="checkbox"/>	Our internal company quality management system ensures information on safety-related systematic faults which become evident in the future		

<sup>1)</sup> Valid order codes and order code exclusions are maintained in the E+H ordering system  
<sup>2)</sup> FIT = Failure In Time, number of failures per 10<sup>9</sup> h  
<sup>3)</sup> Valid for average ambient temperature up to +40 °C (+104 °F)  
 For continuous operation at ambient temperature close to +60 °C (+140 °F), a factor of 2.1 should be applied  
<sup>4)</sup> PTC = Proof Test Coverage  
<sup>5)</sup> All diagnostic functions are performed at least once within the diagnostic test interval  
<sup>6)</sup> Maximum time between error recognition and error response

## 2 About this document

### 2.1 Document function

This supplementary Safety Manual applies in addition to the Operating Instructions, Technical Information and ATEX Safety Instructions. The supplementary device documentation must be observed during installation, commissioning and operation. The requirements specific to the protection function are described in this safety manual.



General information on functional safety (SIL) is available at:  
[www.endress.com/SIL](http://www.endress.com/SIL)

### 2.2 Symbols used

#### 2.2.1 Safety symbols



This symbol alerts you to a dangerous situation. Failure to avoid this situation will result in serious or fatal injury.



This symbol alerts you to a dangerous situation. Failure to avoid this situation can result in serious or fatal injury.



This symbol alerts you to a dangerous situation. Failure to avoid this situation can result in minor or medium injury.



This symbol contains information on procedures and other facts which do not result in personal injury.

#### 2.2.2 Symbols for certain types of information and graphics



**Tip**  
Indicates additional information



Reference to documentation



Reference to graphic



Notice or individual step to be observed

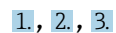

Series of steps



Result of a step

1, 2, 3, ...  
Item numbers

A, B, C, ...  
Views

## 2.3 Supplementary device documentation

 For an overview of the scope of the associated Technical Documentation, refer to the following:

- *W@M Device Viewer* ([www.endress.com/deviceviewer](http://www.endress.com/deviceviewer)): Enter the serial number from the nameplate
- *Endress+Hauser Operations App*: Enter the serial number from the nameplate or scan the matrix code on the nameplate

The following document types are available in the Downloads section of the Endress+Hauser website ([www.endress.com/downloads](http://www.endress.com/downloads)):

### 2.3.1 Further applicable documents

- TI01004F
- BA01004F
- KA01061F
- GP01000F

### 2.3.2 Technical Information (TI)

#### Planning aid

The document contains all the technical data on the device and provides an overview of the accessories and other products that can be ordered for the device.

### 2.3.3 Operating Instructions (BA)

#### Your reference guide

These Operating Instructions contain all the information that is required in various phases of the life cycle of the device: from product identification, incoming acceptance and storage, to mounting, connection, operation and commissioning through to troubleshooting, maintenance and disposal.

### 2.3.4 Brief Operating Instructions (KA)

#### Guide that takes you quickly to the 1st measured value



The Brief Operating Instructions contain all the essential information from incoming acceptance to initial commissioning.

### 2.3.5 Description of Device Parameters (GP)

#### Parameter reference document

The document is part of the Operating Instructions and provides a detailed explanation of each individual parameter in the operating menu.

### 2.3.6 Certificate

The associated certificate is available in the Endress+Hauser W@M Device Viewer ( Section 2.3) or can be found in the Declaration of Conformity ( Section 1) of the applicable Functional Safety Manual. This certificate must be valid at the time of delivery of the device.

## 3 Design

### 3.1 Permitted device types

The details pertaining to functional safety in this manual relate to the device versions listed below and are valid as of the specified firmware and hardware versions.

Unless otherwise specified, all subsequent versions can also be used for safety functions.

A modification process according to IEC 61508 is applied for any device modifications.

 Any exemptions from possible combinations of features are saved in the Endress +Hauser ordering system.

Valid device versions for safety-related use:

#### 3.1.1 Order codes

**Feature: 010 "Approval"**

Version: all

**Feature: 020 "Power supply; output"**

Version:

- A: 2-wire; 4-20 mA HART
- B <sup>1)</sup>: 2-wire; 4-20 mA HART, switch output
- C <sup>2)</sup>: 2-wire; 4-20 mA HART, 4-20 mA
- K: 4-wire 90-253 VAC, 4-20 mA HART

**Feature: 030 "Display; operation"**

Version: all

**Feature: 040 "Housing"**

Version: all

**Feature: 050 "Electrical connection"**

Version: all

**Feature: 060 "Probe"**

Version: all

**Feature: 090 "Seal"**

Version: all

**Feature: 100 "Process connection"**

Version: all

**Feature: 500 "Additional operating languages"**

Version: all

**Feature: 540 "Application package"**

Version: all

**Feature: 550 "Calibration"**

Version: all

**Feature: 570 "Service"**

Version: all

**Feature: 580 "Test; certificate"**

Version: all

- 
- 1) In this version with one current output and one switch output, only the current output (terminals 1 and 2) is approved for safety functions. The switch output can, if necessary, be wired for non-safety-oriented purposes.
  - 2) In this version with two current outputs, only the first output (terminals 1 and 2) is approved for safety functions. The second output can, if necessary, be wired for non-safety-oriented purposes.



**Feature: 590 "Additional approval"**

Version:

- LA<sup>3)</sup>: SIL
-  The "LA" version must be selected for use as a safety function as per IEC 61508.

**Feature: 600 "Probe design"**

Version: all

**Feature: 610 "Accessory mounted"**

Version: all

**Feature: 620 "Accessory enclosed"**

Version: all

**Feature: 850 "Firmware version"**

Version; If no version is selected here, the latest SW with SIL capability is supplied.

Alternatively, the following SW version may be selected:

- 75: 01.01.zz, HART 6, DevRev02
- 74: 01.02.zz, HART 6, DevRev03
- 71: 01.03.zz, HART 7, DevRev04

**Valid versions**

- Firmware: from 01.01.zz (→ device nameplate)
- Hardware (electronics): from date of manufacture 28 January 2011 (→ device nameplate)

## 3.2 Identification marking

SIL-certified devices are marked with the SIL logo  on the nameplate.

## 3.3 Safety function

The device's safety functions are:

- Maximum point level monitoring (overflow protection)
- Minimum point level monitoring (dry running protection)
- Level range monitoring

The safety functions contain the measurement of the bulk solid.

### 3.3.1 Safety-related output signal

The device's safety-related signal is the analog output signal: 4 to 20 mA. All safety measures refer exclusively to this signal.

In the case of devices with one current output and one switch output (order code "020", option "B"), only the current output (terminals 1 and 2) is approved for safety functions. The switch output (terminals 3 and 4) can, if necessary, be wired for non-safety-oriented purposes.

In the case of devices with two current outputs (order code "020", option "C"), only the first current output (terminals 1 and 2) is approved for safety functions. The second output (terminals 3 and 4) can, if necessary, be wired for non-safety-oriented purposes.

The device additionally communicates for information purposes via HART and contains all HART features with additional device information.

The safety-related output signal is fed to a downstream logic unit, e.g. a programmable logic controller or a limit signal transmitter, where it is monitored to determine whether:

- it exceeds and/or drops below a predefined point level
- a fault has occurred, e.g. failure current ( $\leq 3.6$  mA,  $\geq 21.0$  mA, signal cable open circuit or short-circuit)

3) An additional selection of any additional versions is possible.

**NOTICE****In an alarm condition**

- ▶ Ensure that the equipment under control achieves or maintains a safe state.

**3.3.2 Redundant configuration of multiple sensors**

This section provides additional information regarding the use of homogeneously redundant sensors e.g. in 1oo2 or 2oo3 architectures.

The common cause factors  $\beta$  and  $\beta_D$  indicated in the table below are minimum values for the device. These must be used when designing the sensor subsystem.

Minimum value $\beta$ with homogeneous redundant use	2 %
Minimum value $\beta_D$ with homogeneous redundant use	1 %

The device meets the requirements for SIL 3 in homogeneously redundant applications.

The following must be taken into account during installation:

- Install rod and rope probes in separate reference vessels (bypasses, stilling wells), to prevent them from interfering with each other. When installing in the same vessel, the sensor axes must be a minimum distance of 100 mm (3.94 in) apart. Coaxial probes may be installed at any distance.
- Application limits of measuring systems in contact with the process must be observed! In particular, in the case of highly viscous, build-up forming or crystallizing media.

**3.4 Basic conditions for use in safety-related applications**

The measuring system must be used correctly for the specific application, taking into account the medium properties and ambient conditions. Carefully follow instructions pertaining to critical process situations and installation conditions from the Operating Instructions. The application-specific limits must be observed. The specifications in the Operating Instructions and the Technical Information must not be exceeded.

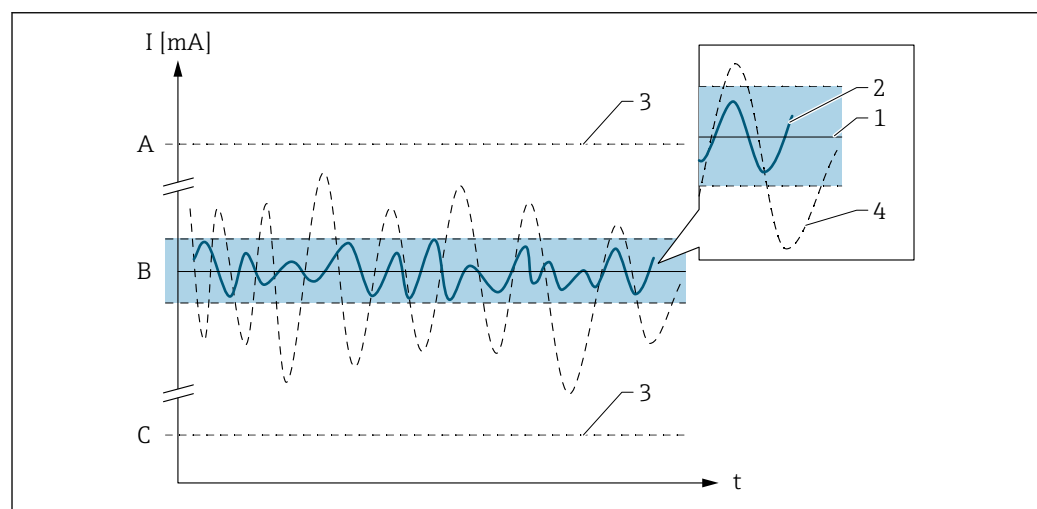
**3.4.1 Safety-related failures according to IEC / EN 61508**

- A HI alarm  $\geq 21$  mA  
 B SIL error range  $\pm 2\%$   
 C LO alarm  $\leq 3.6$  mA

**No device error**

- No failure
- Implications for the safety-related output signal:  
None (1) and measuring uncertainty is within the specification (TI, BA, etc.)

 **$\lambda_S$  (Safe)**

- Safe failure
- Implication for the safety-related output signal:  
The current measured value is output (2) or adopts the safe state (3) and measuring uncertainty is within the specified safety measured errors

 **$\lambda_{DD}$  (dangerous detected)**

- Dangerous but detectable failure
- Implication for the safety-related output signal:  
Results in a failure mode at the output signal (3) and the measuring uncertainty can exceed the specified safety measured error.

 **$\lambda_{DU}$  (dangerous undetected)**

- Dangerous and undetectable failure
- Implication for the safety-related output signal:  
The current measured value is output (4) and the measuring uncertainty can exceed the specified safety measured error.

**3.4.2 Restrictions for safety-related use**

- The application-specific limits must be observed
- Information on the safety-related signal
- The specifications in the Operating Instructions must not be exceeded
- The following restriction also applies for safety-related use:
  - Strong, pulse-like EMC interference on the power supply line can result in transient (<1 s) deviations  $\pm 2\%$  in the output signal. Therefore, filtering with a time constant  $\geq 1$  s should be performed in the downstream logic unit.
  - The error range is device-specific and is defined according to FMEDA (Failure Modes, Effects and Diagnostic Analysis) on delivery. It includes all influential factors described in the Technical Information (e.g. non-linearity, non-repeatability, hysteresis, zero drift, temperature drift, EMC influences).

**3.5 Dangerous undetected failures in this scenario**

An incorrect output signal that deviates from the real measured value by more than 2 %, but is still in the 4 to 20 mA range, is considered a dangerous, undetected failure.

**3.6 Useful lifetime of electric components**

The established failure rates of electrical components apply within the useful lifetime as per IEC 61508-2:2010 section 7.4.9.5 note 3.

According to DIN EN 61508-2:2011 section 7.4.9.5 (national footnote N3) appropriate measures taken by the operator can extend the useful lifetime.

## 4 Commissioning (installation and configuration)

### 4.1 Requirements for personnel

The personnel for installation, commissioning, diagnostics and maintenance must fulfill the following requirements:

- ▶ Trained, qualified specialists must have a relevant qualification for this specific function and task.
- ▶ Personnel must be authorized by the plant owner/operator.
- ▶ Be familiar with federal/national regulations.
- ▶ Before starting work: personnel must read and understand the instructions in the manual and supplementary documentation as well as the certificates (depending on the application).
- ▶ Personnel must follow instructions and comply with general policies.

The operating personnel must fulfill the following requirements:

- ▶ Personnel are instructed and authorized according to the requirements of the task by the facility's owner-operator.
- ▶ Personnel follow the instructions in this manual.

### 4.2 Installation

The mounting and wiring of the device and the permitted orientations are described in the Operating Instructions pertaining to the device.

 Correct installation is a prerequisite for safe operation of the device.

### 4.3 Commissioning

The commissioning of the device is described in the Operating Instructions pertaining to the device.

Prior to operating the device in a safety instrumented system, verification must be performed by carrying out a test sequence as described in **Section 6 Proof testing**.

### 4.4 Operation

The operation of the device is described in the Operating Instructions pertaining to the device.

### 4.5 Device configuration for safety-related applications

#### 4.5.1 Calibration of the measuring point

 For more information, see the Operating Instructions.

Check the initial factory setting of the E (zero point) and F (range) parameters according to the desired measuring range and correct if necessary.

## 4.5.2 Configuration methods

When using the devices in process control safety systems, the device configuration must meet two requirements:

- Confirmation concept:  
Proven, independent testing of safety-related parameters entered.
- Locking concept:  
Locking of the device following parameter configuration (according to IEC 61511-1 : 2016 Section 11.6.3).

To activate the SIL mode, the device must run through an operating sequence, during which the device can be operated by means of the device display or any asset management tool (FieldCare, Pactware, AMS, PDM, Field Communicator 375/475, ...) for which integration is available.

Two methods of configuring the device are provided, which differ mainly with regard to the confirmation concept:

- "Increased safety mode"  
While the commissioning sequence is performed, critical parameters which control functions in the safety path are either set automatically by the device to safe values or transferred to the display/operating tool via an alternative data format so that the setting can be checked.  
This mode can be used for standard applications. As there are only a few safety-related parameters which can be freely configured, the risk of operating errors is greatly reduced, and the level in the vessel does not need to be changed during commissioning in order to check the settings.
- "Expert mode"  
A larger number of safety-related parameters can be freely configured here. This means that the device can be adapted to difficult applications. However, the settings must be checked by directly approaching the level in the vessel or by applying a comparable method.

A detailed description of both modes is provided in the following sections.

 The SIL commissioning sequence is only visible on the display and in external operating tools in the case of SIL devices (order code 590, option "LA"). For this reason, SIL locking can only be activated on these devices.

## 4.5.3 Locking in "Increased safety mode"

To commission the device, carry out and document the following steps in the order shown:

1. Reset device.

This resets all parameters to defined values. To do this, select:

- With firmware version 01.01.zz:  
"Diagnostics → Device reset → To factory defaults" or  
"Diagnostics → Device reset → To delivery settings"
- With firmware version 01.02.zz and 01.03.zz:  
"Setup → Advanced setup → Administration → Device reset → To factory defaults" or  
"Setup → Advanced setup → Administration → Device reset → To delivery settings"

2. Carry out parameter configuration. The parameter configuration procedure and the meaning of the individual parameters are described in the Operating Instructions. The parameter settings must be observed.
3. Perform the "Device check". Activate the "Diagnostics → Device check → Start device check" parameter (for more information, see the Operating Instructions). The signal quality is checked here and any installation errors are detected.

4. Start the SIL/WHG confirmation sequence. Navigate to: "Setup → Advanced setup → SIL/WHG confirmation"
  - ↳ Setting: "Set write protection" = enter the corresponding locking code (WHG: 7450; SIL: 7452; SIL and WHG: 7454)

 For Step 4:

In this way, forbidden parameter changes (e.g. via external operating tools if the confirmation sequence is performed at the device display) are prevented already during the SIL/WHG confirmation sequence.

5. For "Commissioning", select the "Increased safety" entry from the list. The device checks the parameter settings according to the following table and forces the switching of parameters if necessary. Once testing is finished, "SIL/WHG preparation: Finished" is displayed, and the commissioning sequence can continue.

 For Step 5:

- If configuration was not performed in accordance with the specifications in point 2, only "Expert mode" can be selected at this point.
- The commissioning mode must not be changed during the SIL confirmation sequence. If the wrong mode has been selected, the sequence must be canceled and started again.

6. Simulate distance values using the "Value of simulated distance" parameter, and check that the current output responds as it should. For MIN monitoring and MAX monitoring, in each case simulate a distance directly above and below the switch point. For range monitoring, 5 distance values should be simulated which cover the entire measuring range.

#### CAUTION

**During distance simulation, the loop current does not correspond to the measured value.**

- ▶ Ensure that this does not pose any danger.

7. Confirm that the distance simulation is correct. To do so, select the "Yes" value for the "Simulation correct" parameter
8. Compare the character string which is now output ("0123456789+-.") with the reference string printed here, and confirm if the value output is correct.
9. The parameters previously configured and which require confirmation are transferred via an independent data format to the display/operating tool. Check the parameters one after the other and confirm if correct.
10. Enter the locking code again under "Set write protection" (WHG: 7450; SIL: 7452; SIL and WHG: 7454). The locking status must be checked after SIL locking: The parameter "Setup → Advanced setup → Locking status → SIL Locking" must be confirmed with an "X".
11. As an option, hardware locking can also be activated (via the dip switch marked "WP" on the main electronics).

#### 4.5.4 Locking in Expert mode

To commission the device, carry out and document the following steps in the order shown:

1. Reset device.

This resets all parameters to defined values. To do this, select:

- With firmware version 01.01.zz:  
"Diagnostics → Device reset → To factory defaults" or  
"Diagnostics → Device reset → To delivery settings"
  - With firmware version 01.02.zz and 01.03.zz:  
"Setup → Advanced setup → Administration → Device reset → To factory defaults" or  
"Setup → Advanced setup → Administration → Device reset → To delivery settings"
2. Carry out parameter configuration. The parameter configuration procedure and the meaning of the individual parameters are described in the Operating Instructions. Observe the following parameter settings.
  3. Perform the "Device check". Activate the "Diagnostics → Device check → Start device check" parameter (for more information, see the Operating Instructions). The signal quality is checked here and any installation errors are detected.
  4. Start the SIL/WHG confirmation sequence. To do this, enter the appropriate locking code in the "Setup → Advanced setup → SIL/WHG confirmation → Set write protection" parameter (WHG: 7450; SIL: 7452; SIL and WHG: 7454).
  5. For "Commissioning" select the "Expert mode" entry from the list. The device checks the parameter settings according to the following table and forces the switching of parameters if necessary. Once testing is finished, "SIL/WHG preparation: Finished" is displayed, and the commissioning sequence can continue.

 For Step 5:  
The commissioning mode must not be changed during the SIL confirmation sequence. If the wrong mode has been selected, the sequence must be canceled and started again.

6. Carry out function test. For MIN and MAX monitoring, at least one level below (MIN monitoring) or above (MAX monitoring) the switch point must be approached. For range monitoring, 5 levels should be approached which cover the entire measuring range. Verify in each case that the response of the current output is correct. If it is not possible to approach the required level values, a test in accordance with test sequence C (proof test) can be performed prior to locking. However, this does not detect all possible errors (e.g. insufficient adjustment). For this reason, we recommend that the measured values be checked and documented in accordance with test sequence A (proof test) at a time when the required point levels/levels have been reached.
7. Confirm that the function test has been successful. To do so, select the "Yes" entry for "Confirm function test".
8. Enter the locking code again under "Set write protection" (WHG: 7450; SIL: 7452; SIL and WHG: 7454). The locking status must be checked after SIL locking: The parameter "Setup → Advanced setup → Locking status → SIL Locking" must be confirmed with an "X".
9. As an option, hardware locking can also be activated (via the dip switch marked "WP" on the main electronics).

 For Step 6:  
In accordance with IEC 61508-1 : 2010, Section 7.14, this test is part of the "Overall safety validation" and is the responsibility of the operator.

#### 4.5.5 Unlocking a SIL device

When SIL locking is active on a device, the device is protected against unauthorized operation by means of a locking code and, as an additional option, by means of a hardware write protection switch. The device must be unlocked in order to change the configuration, for proof tests according to test sequence B or test sequence C, and to reset self-holding diagnostic messages.

**⚠ CAUTION**

**Unlocking the device deactivates diagnostic functions, and the device may not be able to carry out its safety function when unlocked.**

- ▶ Therefore, independent measures must be taken to ensure that there is no risk of danger while the device is unlocked.

To unlock, proceed as follows:

1. Check the position of the hardware write protection switch (dip switch marked "WP" on main electronics), and set this switch to "Off".
2. Select the sequence "Setup → Advanced setup → Deactivate SIL/WHG" and enter the appropriate locking code in the "Reset write protection" parameter (WHG: 7450; SIL: 7452; SIL and WHG: 7454).

The "End of sequence" message indicates that the device was successfully unlocked.

## 4.6 Parameters and default settings for SIL mode

The following parameters affect the safety function. However, they may be freely configured in accordance with the application. In increased safety mode, it is necessary to confirm the configured values during the remainder of the commissioning process. Confirmation is not required in expert mode. It is recommended to note down the configured values!

### Setup

- Bin type  
From firmware 01.02.00
- Empty calibration
- Full calibration
- Advanced setup → Level → Medium type  
Firmware 01.01.10, 01.01.16 and 01.01.18
- Advanced setup → Level → Medium property  
Only for level measurement
- Advanced setup → Interface → Process property  
From firmware 01.02.00
- Advanced setup → Level → Advanced process conditions  
From firmware 01.02.00
- Advanced setup → Probe settings → Present probe length  
Where possible use the function for the automatic redetermination of the probe length ("Setup > Advanced setup > Probe length correction" sequence) after shortening the probe. If the probe length is not determined automatically, but is entered manually in the device instead, only the expert mode is possible.

The following parameters affect the safety function and are not freely configurable in increased safety mode. Instead, they are automatically set by the device to the safety-oriented values mentioned at the start of SIL/WHG confirmation. If these parameters are to be set to other values, expert mode must be selected.

### Setup

- Advanced setup → Display → Backlight  
Default value: Disable
- Advanced setup → Level → Process property  
Default value: Standard < 1 m/min
- Advanced setup → Level → Level correction  
Default value: 0
- Advanced setup → Linearization → Linearization type  
Default value: None
- Advanced setup → Current output 1 → Current span  
Default value: Fixed current
- Advanced setup → Current output 1 → Damping output  
Default value: 0 s



**Expert**

- Sensor → Level → Distance offset  
Default value: 0 m
- Sensor → Level → L max. drain speed  
Default value: 0
- Sensor → Level → L max. fill speed  
Default value: 0
- Sensor → Level → I max. drain speed  
Default value: 0
- Sensor → Level → I max. fill speed  
Default value: 0
- Sensor → Level → Level limit mode  
Default value: Off
- Sensor → Level → Output mode  
Default value: Level linearized
- Sensor → Sensor diagnostics → Broken probe detection  
Default value: On
- Sensor → Safety settings → Delay time echo lost  
Default value: 1 s (firmware 01.01.10 and 01.01.16), 3 s (from firmware 01.01.18)
- Sensor → Envelope curve → Additional measurement range  
Default value: 0
- Sensor → Envelope curve → Additional number of envelope points  
Default value: 0
- Output → Current output 1 → Turn down  
Default value: Off
- Output → Current output 1 → Measuring mode  
Default value: Standard
- Communication → Configuration → HART address  
Default value: 0

The following parameters affect the safety function and are automatically adapted by the device when configuring higher-ranking parameters (known as application parameters). This indirect setting is permitted in increased safety mode. However, it is not permitted to change the parameters directly. If these parameters were changed directly, only expert mode is available for selection during SIL/WHG confirmation.

**Expert**

- Sensor → Distance → Dead time
- Sensor → Distance → Integration time
- Sensor → Distance → Max. integration time
- Sensor → Distance → Delta at integration time
- Sensor → Distance → Blocking distance evaluation mode
- Sensor → Sensor diagnostics → BP reflect fact.  
From firmware 01.02.00
- Sensor → Safety settings → Jump delay echo lost
- Sensor → Safety settings → Draining speed
- Sensor → Safety settings → Filling speed
- Sensor → Mapping → Map gap to LN  
From firmware 01.02.00
- Sensor → Envelope curve → Envelope statistics down
- Sensor → Envelope curve → Envelope statistics up
- Sensor → First echo factor → First echo mode
- Sensor → First echo factor → First echo factor
- Sensor → EOP evaluation → EOP level evaluation  
From firmware 01.02.00
- Sensor → EOP evaluation → EOP search mode
- Sensor → EOP evaluation → In upper area
- Sensor → EOP evaluation → EOP range upper area
- Sensor → EOP evaluation → Reflection factor near
- Sensor → EOP evaluation → Attenuation constant

- Sensor → EOP evaluation → Reflection factor far
- Sensor → EOP evaluation → Thin interface  
From firmware 01.02.00
- Sensor → Echo tracking → Evaluation mode
- Sensor → Echo tracking → Window size tracking
- Sensor → Echo tracking → Maximal track counter

The following parameters affect the safety function and cannot be freely configured in either the increased safety mode or in the expert mode. Instead they are automatically changed by the device to the safety-oriented values mentioned at the start of SIL/WHG confirmation.

- Setup → Advanced setup → Safety settings → Output echo lost  
Default value: Alarm
- Diagnostics → Simulation → Assign measurement variable  
Default value: Off
- Diagnostics → Simulation → Current output 1 simulation  
Default value: Off
- Diagnostics → Simulation → Device alarm simulation  
Default value: Off
- Expert → Sensor → Distance → Hysteresis  
Default value: 0 m
- Expert → Output → Current output 1 → Trim  
Default value: Off
- Expert → Diagnostics → Simulation → Diagnostic event simulation  
Default value: 65 533

The following parameters affect the safety function. If the settings differ from the as-delivered state of the device, only the expert mode can be selected during SIL/WHG confirmation.

### Setup

Advanced setup → Probe settings → Probe grounded  
From firmware 01.02.00

### Expert

- Sensor → Sensor properties → Sensor type
- Sensor → Sensor properties → Microfactor
- Sensor → Sensor properties → Ideal signal near
- Sensor → Sensor properties → Ideal signal attenuation
- Sensor → Sensor properties → Ideal signal far
- Sensor → Sensor properties → Antenna zero distance
- Sensor → Sensor properties → Cable zero distance
- Sensor → Sensor properties → Electronics zero distance
- Sensor → Sensor properties → Fine zero distance
- Sensor → Sensor properties → Fine zero distance window left
- Sensor → Sensor properties → Fine zero distance window right
- Sensor → Sensor properties → Threshold fine zero distance
- Sensor → Sensor properties → Present fine zero distance correction
- Sensor → Sensor properties → Inactive length
- Sensor → Sensor diagnostics → UBD broken probe  
From firmware 01.02.00
- Sensor → Sensor diagnostics → LBD broken probe
- Sensor → Sensor diagnostics → HF cable failure
- Sensor → Safety settings → Echo lost window right
- Sensor → Safety settings → Echo lost window left
- Sensor → Echo threshold → Threshold near
- Sensor → Echo threshold → Threshold far
- Sensor → Echo threshold → Threshold attenuation constant
- Sensor → Echo threshold → Weight area
- Sensor → Echo threshold → Echo threshold inactive length  
From firmware 01.02.00

- Sensor → Mapping → Map gap to LN  
Firmware 01.01.10, 01.01.16 and 01.01.18
- Sensor → First echo factor → Fix factor EWC
- Sensor → Echo fine adjustment → Fine adjustment mode  
From firmware 01.02.00
- Sensor → Echo fine adjustment → Merge echo distance  
From firmware 01.02.00
- Sensor → Echo fine adjustment → Merging echo window  
From firmware 01.02.00
- Sensor → Echo fine adjustment → Merging ratio  
From firmware 01.02.00
- Sensor → Echo fine adjustment → Parabolic fit window size
- Sensor → EOP evaluation → EOP level evaluation  
Firmware 01.01.10, 01.01.16 and 01.01.18
- Sensor → Echo tracking → Lower level area  
From firmware 01.02.00
- Communication → Output → Assign PV  
Firmware 01.01.10, 01.01.16 and 01.01.18

The following parameters affect the safety function. If the settings differ from the permitted values indicated, SIL/WHG confirmation is canceled automatically, and the device cannot be locked in either the increased safety mode or in the expert mode.

### Setup

Advanced setup → Current output 1 → Failure mode  
Default value: Min. or Max.

- Output → Current output 1 → Start-up mode  
Default value: Defined value
- Communication → Output → Assign PV  
From firmware 01.02.00

- 
  - Those parameters which are not mentioned do not affect the safety function and can be configured to any meaningful values. The visibility of the parameters mentioned in the operating menu depends in part on the user role, the SW options ordered and on the configuration of other parameters.
  - If gas phase compensation is activated ("GPC mode" parameter set to "On" or "Const. GPC factor"), this results in a different specification for accuracy. Coaxial probes with gas phase compensation are precalibrated ex works and may be commissioned either in the increased safety mode or in the expert mode.  
When using a rod probe with gas phase compensation, expert mode must be selected, and the correct setting of the "Reference distance" parameter must be verified during commissioning.
  - In the SIL mode, the device must not be operated in HART-Multidrop mode, as otherwise the current output will assume a fixed value. For this reason, only the setting "Expert → Communication → HART address = 0" is permitted in the SIL mode and in the combined SIL/WHG mode when the device is in the increased safety mode. In pure WHG mode, HART Multidrop is permitted in the expert mode as long as the HART signal is evaluated in an external switching unit (e.g. Tank Side Monitor NRF590) that complies with the approval principles as per WHG.

## 5 Operation

### 5.1 Device behavior during power-up

 After SIL locking, additional diagnostics are active and critical parameters in the safety path are set to safe values. Therefore, the behavior of the device in the "SIL-locked state" may deviate from the "non-SIL-locked state". If a test phase takes place before the system is finally put into production, it is recommended to run this test phase in the locked state in order to obtain the most conclusive results possible

Once switched on, the device runs through a diagnostic phase of approx. 15 s. The current output is set to failure current during this time. For approx. 5 s of the diagnostic phase, this current is  $\leq 3.6$  mA. After that, depending on the setting of the "Start-up mode" parameter, the current is:

- at the MIN value:  $\leq 3.6$  mA
- at the MAX value:  $\geq 21.0$  mA

During the diagnostic phase, no communication is possible via the service interface (CDI) or via HART.

### 5.2 Device behavior in safety function demand mode

The device outputs a current value corresponding to the limit value to be monitored. This value must be monitored and processed further in an attached logic unit.

### 5.3 Behavior of device in the event of an alarm and warnings

The output current on alarm can be set to a value of  $\leq 3.6$  mA or  $\geq 21.0$  mA.

In some cases (e.g. failure of power supply, a cable open circuit and faults in the current output itself, where it is not possible to set the failure current  $\geq 21.0$  mA), output currents  $\leq 3.6$  mA can occur irrespective of the configured failure current.

In other cases (e.g. short circuit of cabling), output currents  $\geq 21.0$  mA occur irrespective of the configured failure current.

For alarm monitoring, the downstream logic unit must be able to recognize failure currents of the upper level for signal on alarm ( $\geq 21.0$  mA) and the lower level for signal on alarm ( $\leq 3.6$  mA).

### 5.4 Alarm and warning messages

The behavior of the device in the event of an alarm and warnings is described in the relevant Operating Instructions.

 The error codes are listed in the Operating Instructions.

Additional information is provided by the alarm and warning messages in the form of error codes and associated plain text messages. The following table shows the correlation between the error code and the current output:

#### Error code "Fxxx"

- Current output:  $\geq 21.0$  mA or  $\leq 3.6$  mA
- Comment: xxx = three-digit number

#### Error code "Mxxx"

- Current output: corresponding to measuring mode
- Comment: xxx = three-digit number

**Error code "Cxxx"**

- Current output: corresponding to measuring mode
- Comment: xxx = three-digit number

**Error code "Sxxx"**

- Current output: corresponding to measuring mode
- Comment: xxx = three-digit number

**5.4.1 Exceptions**

 The error codes are listed in the Operating Instructions.

**Error code "M272"**

- Current output:  $\geq 21.0 \text{ mA}$  or  $\leq 3.6 \text{ mA}$
- Comment: main electronics error

**Error code "C484"**

- Current output:  $\geq 21.0 \text{ mA}$  or  $\leq 3.6 \text{ mA}$
- Comment: simulation failure mode

**Error code "S942"**

- Current output:  $\geq 21.0 \text{ mA}$  or  $\leq 3.6 \text{ mA}$
- Comment: in safety distance

 When SIL locking is active on the device, additional diagnostics are activated (e.g. the output current that is read back is compared with the target value). If one of these diagnostics results in an error message (e.g. F803 loop current) and SIL locking is then deactivated, the error message remains while the error persists, even if the diagnostic is no longer active in the unlocked state. In this case, the device must be disconnected briefly from the power supply (e.g. by unplugging the terminals). When the device is then restarted, a self-check is carried out, and the error message is reset where applicable.

**6 Proof testing**

 The safety-related functionality of the device in the SIL mode must be verified during commissioning, when changes are made to safety-related parameters, and also at appropriate time intervals. This enables this functionality to be verified within the entire safety instrumented system. The time intervals must be specified by the operator.

** CAUTION****The safety function is not guaranteed during a proof test**

Suitable measures must be taken to guarantee process safety during the test.

- ▶ The safety-related output signal 4 to 20 mA must not be used for the protective system during the test.
- ▶ The operator specifies the testing interval and this must be taken into account when determining the probability of failure  $\text{PFD}_{\text{avg}}$  of the sensor system.

If no operator-specific proof testing requirements have been defined, the following is a possible alternative for testing the transmitter depending on the measured variable used for the safety function. The individual proof test coverages (PTC) that can be used for calculation are specified for the test sequences described below.

**Flexible testing of field devices**

NAMUR Worksheet NA106 "Flexible proof testing of field devices in safety instrumented systems" explains how to optimize testing activities on existing installations.

Heartbeat Verification enables the documentation of the current device diagnostic or device status as proof of testing. This supports the documentation of proof tests according to IEC 61511-1:2016 Section 16.3.3, "Documentation of proof tests and inspections".

**i** Heartbeat Verification is not a substitute for a proof test. Test sequences with Heartbeat Verification can contribute to the detection of systematic errors within the context of proof testing. In this case, Heartbeat Verification is one step in the proof test sequence.

Heartbeat Verification is based on device-specific test sequences that are performed automatically. The verification also enables the detection of systematic errors in the process, e.g. antenna or probe fouling

Heartbeat Technology is a methodological design concept based on IEC 61508:2010 consisting of the Heartbeat Diagnostic, Verification and Monitoring modules. For more information on Heartbeat Technology, see the associated documentation.

#### NOTICE

**Before the test is started, the device is in a fault state, i.e. an alarm is output**

► First rectify the cause of the fault before starting the proof test.

#### Overview of the proof tests:

- Test sequence A: Approach the level in the original vessel
- Test sequence B: Remove the device and immerse it in a medium with comparable properties
- Test sequence C: Device self-test and level simulation. No change of level in the vessel is necessary for this sequence

#### Note the following for the test sequences:

If an error is detected in one of the redundantly operated devices, the other devices must be checked to see if there is the same error.

## 6.1 Test sequence A

Preparatory steps

1. Connect a suitable measuring device (recommended accuracy better than  $\pm 0.1$  mA) to the current output.
2. Determine the safety setting (point level or range monitoring).

Procedure for point level monitoring

1. Check safety function: Approach at least one level immediately above (MAX monitoring) or below (MIN monitoring) the point level to be monitored.
2. Check safety function: Read the output current, record it and assess for accuracy.
3. If (as an option) the function of the measuring point is to be checked immediately before the switch point, check the function before the MIN or MAX switch point: Approach the level immediately below (MAX monitoring) or above (MIN monitoring) the point level to be monitored. Read the output current, record it and assess for accuracy. This does not check the safety function of the device.

The test is to be considered successful if the current values trigger or ensure the required function.

Procedure for range monitoring

1. Approach five levels within the range to be monitored.
2. Read the output current at each level value, record it and assess for accuracy.

The test is to be considered successful if the current values in step 2 are within the required level of accuracy.

**NOTICE**

**The device has failed the proof test if the current value at a specific level deviates by  $> \pm 2\%$  from the expected value.**

99% of dangerous, undetected failures are detected using this test (proof test coverage (PTC) = 0.99).

► For troubleshooting measures, see the Operating Instructions.

## 6.2 Test sequence B

Preparatory steps

1. Prepare a test tank with test medium (dielectric constant comparable to that of the medium to be measured). For installation instructions, refer to the Operating Instructions
2. Deactivate SIL mode. To do so, in the operating menu select "Setup → Advanced setup → Deactivate SIL/WHG" and enter the appropriate locking code (WHG: 7450; SIL: 7452; SIL and WHG: 7454).  
↳ The SIL mode is deactivated.
3. Remove the device and mount it in the test tank.
4. Connect a suitable measuring device (recommended accuracy better than  $\pm 0.1$  mA) to the current output.
5. Perform interference echo mapping if the shape and size of the test tank is different.
6. Determine the safety setting (point level or range monitoring).

Procedure for point level monitoring

1. Approach a level directly below (MAX monitoring) or directly above (MIN monitoring) the point level to be monitored.
2. Read the output current, record it and assess for accuracy.
3. Approach the level directly above (MAX monitoring) or directly below (MIN monitoring) the point level to be monitored.
4. Read the output current, record it and assess for accuracy.

The test is to be considered successful if the current in step 2 does not result in activation of the safety function but the current in step 4 does.

Procedure for range monitoring

1. Approach five levels within the range to be monitored.
2. Read the output current at each level value, record it and assess for accuracy.

The test is to be considered successful if the current values in step 2 are within the required level of accuracy.

**NOTICE**

**The device has failed the proof test if the current value at a specific level deviates by  $> \pm 2\%$  from the expected value.**

99% of dangerous, undetected failures are detected using this test (proof test coverage (PTC) = 0.99).

► For troubleshooting measures, see the Operating Instructions.

**⚠ CAUTION****Re-installation in the original tank**

SIL mode is not activated.

- ▶ SIL mode must be reactivated
- ▶ If an interference echo mapping was performed in the test tank, it is necessary following installation in the original tank to carry out another interference echo mapping that is valid for that tank.

## 6.3 Test sequence C

### Preparatory steps

1. Deactivate SIL mode. To do so, in the operating menu select "Setup → Advanced setup → Deactivate SIL/WHG → Reset write protection" and enter the appropriate locking code (WHG: 7450; SIL: 7452; SIL and WHG: 7454).
  - ↳ The SIL mode is deactivated.
2. Connect a suitable measuring device (recommended accuracy better than  $\pm 0.1$  mA) to the current output.
3. Determine the safety setting (point level or range monitoring).

### Procedure for point level monitoring

1. Perform device self-check. For this, in the operating menu "Expert → Sensor → Sensor diagnostics → Start self check" select "Yes".
2. After performing the test, read the result in the "Expert → Sensor → Sensor diagnostics → Result self check" parameter.
  - ↳ This part of the test has been passed only when "OK" is displayed here.
3. Simulate a level directly below (MAX monitoring) or directly above (MIN monitoring) the point level to be monitored. To do so, select the value "Level" in the operating menu "Diagnostics → Simulation → Assign measurement variable". Alternatively, in the case of interface measurement, select the values "Interface" or "Upper interface thickness" and enter the value in the "Diagnostics → Simulation → Process variable value" parameter.
4. Read the output current, record it and assess for accuracy.
5. Simulate a level directly above (MAX monitoring) or directly below (MIN monitoring) the point level to be monitored.
6. Read the output current, record it and assess for accuracy.

The test is to be considered successful if the current in step 4 does not result in activation of the safety function but the current in step 6 does.

- i** If the "Expert" menu group is selected, a prompt for the access code appears on the display. If an access code was defined under "Setup → Advanced setup → Define access code", this code must be entered here. If no access code was defined, the prompt can be acknowledged by pressing the "E" key.

### Procedure for range monitoring

1. Perform device self-check. For this purpose, in the menu select "Yes" in the list "Expert → Sensor → Sensor diagnostics → Start self check" and, after performing the test, read the result in the "Expert → Sensor → Sensor diagnostics → Result self check" parameter. This part of the test has been passed only when "OK" is displayed here.
2. Simulate five levels within the range to be monitored. Procedure, → Point level monitoring, step 2.
3. Read the output current at each level value, record it and assess for accuracy.



The test is to be considered successful if the current values in step 2 are within the required level of accuracy.

- i
  - If the "Expert" menu group is selected, a prompt for the access code appears on the display. If an access code was defined under "Setup → Advanced setup → Define access code", this code must be entered here. If no access code was defined, the prompt can be acknowledged by pressing the "E" key.
  - The device has failed the proof test if the current value at a certain level deviates from the expected value by  $> \pm 2\%$ . For troubleshooting, refer to the Operating Instructions. 95 % of dangerous, undetected failures are detected using this test (proof test coverage (PTC) = 0.95).  
A number of sensor (probe) faults are not detected.
  - If one of the test criteria from the test sequences described above is not fulfilled, the device may no longer be used as part of a safety instrumented system. The purpose of proof testing is to detect random device failures ( $\lambda_{DU}$ ). The impact of systematic faults on the safety function is not covered by this test and must be assessed separately. Systematic faults can be caused, for example, by process material properties, operating conditions, build-up or corrosion.

#### **⚠ CAUTION**

**Once test sequence C has been performed, the SIL mode must be activated again**

- ▶ Activate the SIL mode
- ▶ The following steps do not need to be performed again in this case: Steps 1 and 2 were performed in the context of (initial) commissioning/configuration. Steps 3 and 6 were performed in the context of this proof test with the relevant diagnostic coverage.

## 6.4 Verification criterion

**If one of the test criteria from the test sequences described above is not fulfilled, the device may no longer be used as part of a safety instrumented system.**

- The purpose of proof-testing is to detect dangerous undetected device failures ( $\lambda_{DU}$ ).
- This test does not cover the impact of systematic faults on the safety function, which must be assessed separately.
- Systematic faults can be caused, for example, by process material properties, operating conditions, build-up or corrosion.
- As part of the visual inspection, for example, ensure that all of the seals and cable entries provide adequate sealing and that the device is not visibly damaged.

# 7 Repair and error handling

## 7.1 Maintenance

Maintenance instructions and instructions regarding recalibration may be found in the Operating Instructions pertaining to the device.

- i
 Alternative monitoring measures must be taken to ensure process safety during configuration, proof-testing and maintenance work on the device.

## 7.2 Repair

Repair means restoring functional integrity by replacing defective components.

**Only original Endress+Hauser spare parts may be used for this purpose.**

Document the repair with the following information:

- Serial number of the device
- Date of the repair
- Type of repair
- Person who performed the repair

Components may be repaired/replaced by the customer's technical staff if **original spare parts** from Endress+Hauser are used (they can be ordered by the end user) and the appropriate installation instructions are followed.

 A proof test must always be performed after every repair.

#### **Probe with process connection**

- Installation Instructions: EA00045F/00
- Device inspection following repair: proof test, test sequence A or B

#### **Probe without process connection**

- Installation Instructions: EA00047F/00
- Device inspection following repair:
  - If the probe length is changed: unlock the device; recalibrate the probe length; check the measurement at any level; lock the device again
  - If the probe length is not changed: check the probe length e.g. with a tape measure; perform visual inspection to check whether all parts are present and mounted correctly; after reinstalling: check the measurement at any level

#### **Weight of probe**

- Installation Instructions: EA00042F/00
- Device inspection following repair: visual inspection to check whether all parts are present and properly mounted

#### **Nord-lock washers and lock nuts for probe mounting**

- Installation Instructions: EA00048F/00
- Device inspection following repair: visual inspection to check whether all parts are present and properly mounted

#### **HF coaxial cable of separate version**

- Installation Instructions: EA00057F/00
- Device inspection following repair:
  - Visual inspection to check whether all parts are present and properly mounted
  - After remounting: check the measurement at an arbitrary level

#### **Display SD02/03**

- Installation Instructions: EA00102D/06
- Device inspection following repair: visual inspection to check whether all parts are present and properly mounted

#### **Transmitter electronics of the remote display FHX50**

- Installation Instructions: EA01064F/00
- Device inspection following repair: visual inspection to check whether all parts are present and properly mounted

#### **Cable of the remote display FHX50**

- Installation Instructions: EA01062F/00 (General Safety Datasheet)
- Device inspection following repair: visual inspection to check whether all parts are present and properly mounted

#### **Main electronics**

- Installation Instructions: EA00041F/00
- Device inspection following repair:
  - Visual inspection to check whether all parts are present and properly mounted
  - Unlock the device
  - Lock the device

**I/O modules**

- Installation Instructions: EA00039F/00
- Device inspection following repair:
  - Visual inspection to check whether all parts are present and properly mounted
  - Check the measurement at an arbitrary level

**Overvoltage protection OVP10/20**

- Installation Instructions: SD01090F/00
- Device inspection following repair:
  - Visual inspection to check whether all parts are present and properly mounted
  - Check the measurement at an arbitrary level

**Terminals for I/O modules**

- Installation Instructions: EA00040F/00
- Device inspection following repair:
  - Visual inspection to check whether all parts are present and properly mounted
  - After remounting: check the measurement at an arbitrary level

**Housing cover**

- Installation Instructions: EA00035F/00
- Device inspection following repair: visual inspection to check whether all parts are present and properly mounted

**Seal kit for housing covers**

- Installation Instructions: EA00036F/00
- Device inspection following repair: visual inspection to check whether all parts are present and properly mounted

**Housing filter (vent plugs)**

- Installation Instructions: EA00037F/00
- Device inspection following repair: visual inspection to check whether all parts are present and properly mounted

**Securing clamps, housing**

- Installation Instructions: EA00038F/00
- Device inspection following repair: visual inspection to check whether all parts are present and properly mounted



Installation Instructions are supplied with the original spare part and can also be accessed in the Download Area at [www.endress.com](http://www.endress.com)

Send in replaced components to Endress+Hauser for fault analysis.

When returning the defective component, always enclose the "Declaration of Hazardous Material and Decontamination" with the note "Used as SIL device in a safety instrumented system."

Information on returns: <http://www.endress.com/support/return-material>

## 7.3 Modification

- **Modifications to SIL devices by the user are not permitted as they can impair the functional safety of the device**
- Modifications to SIL devices on site at the user's plant are possible following approval by the Endress+Hauser manufacturing center
- Modifications to SIL devices must be performed by staff who have been authorized to perform this work by Endress+Hauser
- Only **original spare parts** from Endress+Hauser must be used for modifications
- All modifications must be documented in the Endress+Hauser W@M Device Viewer
- All modifications require a modification nameplate or the replacement of the original nameplate.

## 7.4 Decommissioning

When decommissioning, the requirements according to IEC 61508-1:2010 section 7.17 must be observed.

## 7.5 Disposal



If required by the Directive 2012/19/EU on waste electrical and electronic equipment (WEEE), the product is marked with the depicted symbol in order to minimize the disposal of WEEE as unsorted municipal waste. Do not dispose of products bearing this marking as unsorted municipal waste. Instead, return them to Endress+Hauser for disposal under the applicable conditions.

## 7.6 Battery disposal

- In some countries, the end user is legally obliged to return used batteries.
- The end user can return old batteries or electronic assemblies containing these batteries free of charge to Endress+Hauser.



In accordance with German law regulating the use of batteries (BattG §17 Para Number 3), this symbol is used to denote electronic assemblies that must not be disposed of as municipal waste.

# 8 Appendix

## 8.1 Structure of the measuring system

### 8.1.1 System components

The measuring system's devices are displayed in the following diagram (example):

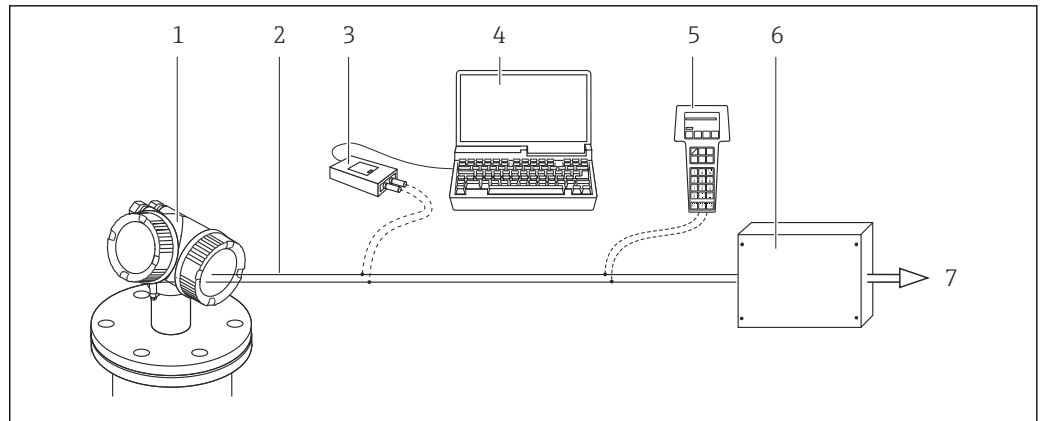

A0024237

- 1 Levelflex (optional with display module SD02/SD03)
- 2 4 to 20 mA cable
- 3 Commubox FXA191/195
- 4 Computer with operating tool, e.g. FieldCare
- 5 Field Communicator 375/475
- 6 Logic unit, e.g. PLC, limit signal transmitter
- 7 Actuator

An analog signal (4 to 20 mA) that is in proportion to the level is generated in the transmitter. This is sent to a downstream logic unit (e.g. PLC, limit signal transmitter, etc.) where it is monitored to determine whether it is below or above a specified limit value.

For fault monitoring, the logic unit must detect both HI alarms ( $\geq 21.0$  mA) and LO alarms ( $\leq 3.6$  mA).

### 8.1.2 Description of use as a safety instrumented system

The device is a "downward-looking" measuring system that functions according to the time-of-flight (ToF) method. The distance from the reference point (process connection of the measuring device) to the product surface is measured. High-frequency pulses are injected to a probe and led along the probe. The pulses are reflected by the product surface, received by the electronic evaluation unit and converted into level information. This method is also known as time domain reflectometry (TDR).

### 8.1.3 Installation conditions

The installation conditions for various measurements are described in the Technical Information for the device.



Correct installation is a prerequisite for safe operation of the device.

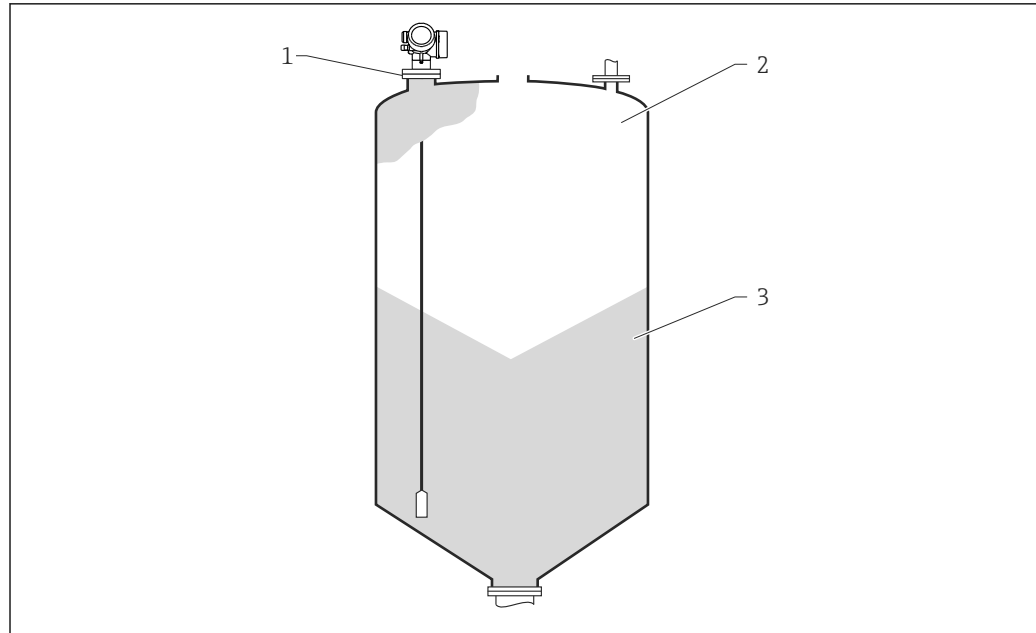

A0022799

- 1 Flange: Reference point of measurement
- 2 20 mA, 100 %
- 3 4 mA, 0 %

The device can be used in this arrangement in safety instrumented systems for MIN safety, MAX safety and range monitoring.

For interface measurement of two different phases (e.g. oil on water), two echos are analyzed according to the TDR method described above. Only one probe is needed to carry out both the TDR measurement and the capacitance measurement. This capacitance is an indicator for the level, as the dielectric constant and/or the conductivity of the products cause an increase in capacitance. This additional information enables a high degree of accuracy, even in difficult application conditions (e.g. emulsification).

## 8.2 Commissioning or proof test report

The following device-specific test report acts as a print/master template and can be replaced or supplemented any time by the customer's own SIL reporting and testing system.

### 8.2.1 Test Report

System-specific data	
Data	
Measuring points/TAG No.	
Facility	
Device type/Order code	
Serial number of device	
Name	
Date/time	
Access code (if individual to each device)	
Locking code used	WHG <input type="checkbox"/> 7450
	SIL <input type="checkbox"/> 7452
	SIL and WHG <input type="checkbox"/> 7454
Signature	

For firmware version: 01.01.zz

Device-specific commissioning parameters (only in "Increased safety mode")	
Empty calibration	
Full calibration	
Blocking distance	
Operating mode	
Current assignment (interface measurement)	
Medium type	
Present probe length	
Pipe diameter	
Tank level (interface measurement)	
DC value (interface measurement)	
Medium property (level measurement)	

For firmware version: 01.02.zz and 01.03.zz

Device-specific commissioning parameters (only in "Increased safety mode")	
Empty calibration	
Full calibration	
Operating mode (interface measurement)	
Current assignment (interface measurement)	
Tank type (liquids)	
Bin type (bulk solids)	
Process property	
Advanced process conditions	
Present probe length	
Tube diameter (interface measurement)	
Tank level (interface measurement)	

Device-specific commissioning parameters (only in "Increased safety mode")	
DC value (interface measurement)	
Medium property (level measurement)	

Proof test protocol		
Test step	Set point	Actual value
1. Current value 1		
2. Current value 2		
3. Current value 3 (if necessary)		
4. Current value 4 (if necessary)		
5. Current value 5 (if necessary)		



## 8.3 Version history

### **FY01064F; version 01.21**

- Firmware version: from 01.01.zz (zz: any double number)
- Hardware version: from date of manufacture 28 January 2011
- Changes:
  - Certificate renewed
- Predecessor: SD00326F  
Levelflex FMP50/51/52/53/54/55/56/57







71551463

[www.addresses.endress.com](http://www.addresses.endress.com)

---