

Brief Operating Instructions

Rxn-30 Raman spectroscopic probe



Table of Contents

1	About this Document	5
1.1	Disclaimer	5
1.2	Warnings	5
1.3	Symbols	6
1.4	U.S. export compliance.....	6
2	Basic safety instructions	7
2.1	Requirements for personnel.....	7
2.2	Designated use	7
2.3	Workplace safety.....	7
2.4	Operational safety.....	8
2.5	Laser safety.....	8
2.6	Service safety.....	9
2.7	Important safeguards.....	9
2.8	Product safety.....	9
3	Product description	11
3.1	Rxn-30 probe.....	11
3.2	Hardware	12
4	Incoming product acceptance and product identification	13
4.1	Incoming acceptance.....	13
4.2	Product identification	13
4.3	Scope of delivery.....	14
5	Probe and fiber optic connection	15
5.1	FC cable assembly	15
5.2	EO fiber cable.....	16
6	Installation	17
6.1	Rxn-30 probe with NPT cross fitting	17
6.2	Rxn-30 probe with compression cross fitting	18
6.3	Process and probe compatibility	19
6.4	Hazardous area installation	19
7	Commissioning.....	20
7.1	Receipt of probe.....	20
7.2	Probe calibration and verification.....	20
8	Operation.....	21
8.1	Routine operation.....	21
8.2	Start-up procedure	21

8.3 Recommendations for optimal performance21

9 Diagnostics and troubleshooting 23

1 About this Document

1.1 Disclaimer

These instructions are Brief Operating Instructions; they do not replace the Operating Instructions included in the scope of supply.

1.2 Warnings

Structure of Information	Meaning
<p>⚠ WARNING</p> <p>Causes (/consequences) If necessary, consequences of non-compliance (if applicable)</p> <p>▶ Corrective action</p>	<p>This symbol alerts you to a dangerous situation. Failure to avoid the dangerous situation can result in a fatal or serious injury.</p>
<p>⚠ CAUTION</p> <p>Causes (/consequences) If necessary, consequences of non-compliance (if applicable)</p> <p>▶ Corrective action</p>	<p>This symbol alerts you to a dangerous situation. Failure to avoid this situation can result in minor or more serious injuries.</p>
<p>NOTICE</p> <p>Cause/situation If necessary, consequences of non-compliance (if applicable)</p> <p>▶ Action/note</p>	<p>This symbol alerts you to situations which may result in damage to property.</p>

Table 1. Warnings

1.3 Symbols





Symbol	Description
	The Laser Radiation symbol is used to alert the user to the danger of exposure to hazardous visible laser radiation when using the Raman Rxn system.
	The High Voltage symbol that alerts people to the presence of electric potential large enough to cause injury or damage. In certain industries, high voltage refers to voltage above a certain threshold. Equipment and conductors that carry high voltage warrant special safety requirements and procedures.
	The CSA Certification Mark indicates that the product was tested against and met the applicable North American standards requirements.
	The WEEE symbol indicates that the product should not be discarded as unsorted waste but must be sent to separate collection facilities for recovery and recycling.
	The CE Marking indicates conformity with health, safety, and environmental protection standards for products sold within the European Economic Area (EEA).

Table 2. Symbols

1.4 U.S. export compliance

The policy of Endress+Hauser is strict compliance with U.S. export control laws as detailed in the website of the [Bureau of Industry and Security](#) at the U.S. Department of Commerce.

2 Basic safety instructions

2.1 Requirements for personnel

- Installation, commissioning, operation, and maintenance of the measuring system may be carried out only by specially trained technical personnel.
- The technical personnel must be authorized by the plant operator to carry out the specified activities.
- The technical personnel must have read and understood these Operating Instructions and must follow the instructions contained herein.
- The facility must designate a laser safety officer who ensures staff are trained on all Class 3B laser operating and safety procedures.
- Faults at the measuring point may only be rectified by properly authorized and trained personnel. Repairs not described in this document must be carried out only directly at the manufacturer's site or by the service organization.

2.2 Designated use

The Rxn-30 Raman spectroscopic probe is intended for gas phase sample analysis.

Recommended applications include:

- **Chemical:** ammonia, methanol, HyCO
- **Gas-phase streams in refining:** hydrogen production and recycle fuel blending, fuel characterization
- **Power and energy:** integrated gasification combined cycle (IGCC) power plants, gas turbines
- **Life sciences/food and beverage:** fermentations, offgas, volatiles

Use of the device for any purpose other than that described, poses a threat to the safety of people and of the entire measuring system and invalidates any warranty.

2.3 Workplace safety

As the user, you are responsible for complying with the following safety conditions:

- Installation guidelines
- Local standards and regulations for electromagnetic compatibility

The product has been tested for electromagnetic compatibility in accordance with the applicable international standards for industrial applications.

The electromagnetic compatibility indicated applies only to a product that has been properly connected to the analyzer.

2.4 Operational safety

Before commissioning the entire measuring point:

1. Verify that all connections are correct.
2. Ensure that electro-optical cables are undamaged.
3. Do not operate damaged products, and protect them against unintentional operation.
4. Label damaged products as defective.

During operation:

1. If faults cannot be rectified, products must be taken out of service and protected against unintentional operation.
2. When working with laser devices, always follow all local laser safety protocols which may include the use of personal protective equipment and limiting device access to authorized users.

2.5 Laser safety

The Raman Rxn analyzers use Class 3B lasers as defined in the following:

- [American National Standards Institute](#) (ANSI) Z136.1, American National Standard for Safe Use of Lasers
- [International Electrotechnical Commission](#) (IEC) 60825-1, Safety of Laser Products – Part 1

WARNING

Laser radiation

- ▶ Avoid exposure to beam
- ▶ Class 3B laser product

CAUTION

Laser beams can cause ignition of certain substances such as volatile organic compounds.

The two possible mechanisms for ignition are direct heating of the sample to a point causing ignition and the heating of a contaminant (such as dusts) to a critical point leading to ignition of the sample.

The laser configuration presents further safety concerns because the radiation is nearly invisible. Always be aware of the initial direction and possible scattering paths of the laser. The use of laser safety glasses with OD3 or greater is highly recommended for 532 nm and 785 nm excitation wavelengths and OD4 or greater for a 993 nm excitation wavelength.

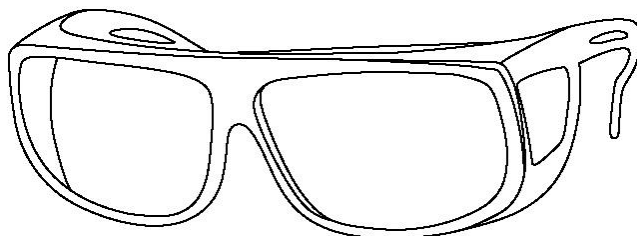

A0048421

Figure 1. Laser safety glasses

For more assistance with taking appropriate precautions and setting the proper controls when dealing with lasers and their hazards, refer to the most current version of ANSI Z136.1 or IEC 60825-14.

2.6 Service safety

Follow your company's safety instructions when removing a process probe from the process interface for service. Always wear proper protective equipment when servicing the equipment.

2.7 Important safeguards

- Do not use the Rxn-30 probe for anything other than its intended use.
- Do not look directly into the laser beam.
- Do not point the laser at a mirrored/shiny surface or a surface that may cause diffuse reflections. The reflected beam is as harmful as the direct beam.
- Do not leave attached and unused probes uncapped or unblocked.
- Always use a laser beam block to avoid inadvertent scatter of laser radiation.

2.8 Product safety

This product is designed to meet all current safety requirements, has been tested, and shipped from the factory in a safe operating condition. The relevant regulations and international standards have been observed. Devices connected to an analyzer must also comply with the applicable analyzer safety standards.

Endress+Hauser Raman spectroscopy systems incorporate the following safety features to conform to the United States Government requirements 21 [Code of Federal Regulations](#) (CFR) Chapter 1, Subchapter J as administered by the [Center for Devices and Radiological Health](#) (CDRH) and IEC 60825-1 as administered by the [International Electrotechnical Commission](#).

2.8.1 CDRH and IEC compliance

Endress+Hauser Raman analyzers are certified by Endress+Hauser to meet CDRH and IEC 60825-1 design and manufacturing requirements.

Endress+Hauser Raman analyzers have been registered with the CDRH. Any unauthorized modifications to an existing Raman Rxn analyzer or accessory may result in hazardous radiation exposure. Such modifications may result in the system being no longer in conformance with federal requirements as certified by Endress+Hauser.

2.8.2 Laser safety interlock

The Rxn-30 probe, as installed, forms part of the interlock circuit. If the fiber cable is severed, the laser will turn off as a result of the breakage, in compliance with IEC 60079-28 and IEC 60825-2.

NOTICE

Handle probes and cables with care.

Fiber cables should NOT be kinked and should be routed to maintain the minimum bend radius of 152.4 mm (6 in.).

- ▶ Permanent damage may result if cables are not routed appropriately.

The interlock circuit is a low-current electrical loop. If the Rxn-30 probe is used in a hazardous classified area, the interlock circuit must pass through an intrinsically safe (IS) barrier.

When there is potential for the laser to be energized, the LED laser indicator light is illuminated in accordance with 21 CFR Chapter 1, Subchapter J.

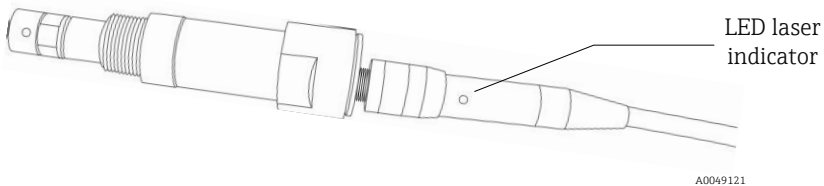

Figure 2. LED laser indicator location

3 Product description

3.1 Rxn-30 probe

The Rxn-30 Raman spectroscopic probe, powered by Kaiser Raman technology, is intended for robust gas-phase measurements in a laboratory or process plant setting. The probe is designed to be compatible with Endress+Hauser Raman Rxn analyzers operating at 532 nm.

The Rxn-30 probe is available with a variety of mounting options for maximum installation and sampling flexibility. These options allow for direct insertion, side insertion, and in sample loops. The probe is NeSSI compatible and slip-stream compatible. In addition, the Rxn-30 probe is compatible with installations in hazardous areas/classified environments.

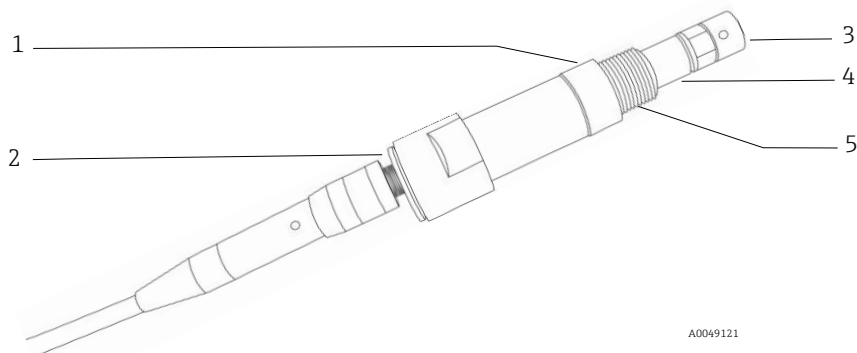

A0049121

Figure 3. Rxn-30 probe

#	Description
1	1 inch diameter compression fitting compatible (25.4 mm)
2	Connector/cable interface (leave attached)
3	Retro assembly
4	Sample gas ports located under a sintered metal filter
5	½ inch NPT interface thread (12.7 mm)

Table 3. Rxn-30 probe parts

3.2 Hardware

3.2.1 Standard hardware

Standard Rxn-30 hardware includes the following:

- Rxn-30 gas-phase probe
- Sample tube removal and replacement wrench to facilitate cleaning of internal sample and window surfaces
- Contamination gas filter for use in “dirty” sample environments and some classified/hazardous environments (20 micron pore sintered)

3.2.2 Additional accessories

The Rxn-30 probe connects to the Raman Rxn analyzer via a fiber optic cable. Cables are available in 5 m (16.4 ft.) increments with the length configured to suit and limited by the application. See Section 5 →  for additional information about fiber optic cable options.

The Rxn-30 is designed to accommodate installation to a sample stream or vessel using one of these industry standard optional accessories:

- ½ inch NPT cross fitting (12.7 mm)
- 1 inch compression cross fitting (25.4 mm)

4 Incoming product acceptance and product identification

4.1 Incoming acceptance

1. Verify that the packaging is undamaged. Notify the supplier of any damage to the packaging. Keep the damaged packaging until the issue has been resolved.
2. Verify that the contents are undamaged. Notify the supplier of any damage to the delivery contents. Keep the damaged goods until the issue has been resolved.
3. Check that the delivery is complete and nothing is missing. Compare the shipping documents with your order.
4. Pack the product for storage and transportation in such a way that it is protected against impact and moisture. The original packaging offers the best protection. Make sure to comply with the permitted ambient conditions.

If you have any questions, please contact your supplier or your local sales center.

NOTICE

Probe may be damaged during transport if packaged inadequately.

4.2 Product identification

4.2.1 Label

At a minimum, the probe/tag is labeled with the following information:

- Endress+Hauser branding
- Serial number

Where size allows, the following information is also included:

- Product identification (e.g., Rxn-30)
- Extended order code
- Manufacturer information
- Key functional aspects of the probe (e.g., material, wavelength, focal depth)
- Safety warnings and certification information, as applicable

Compare the information on the label/tag with the order.

4.2.2 Manufacturer address

Endress+Hauser
371 Parkland Plaza
Ann Arbor, MI 48103 USA

4.3 Scope of delivery

The scope of delivery comprises:

- Rxn-30 probe
- *Rxn-30 Raman spectroscopic probe Operating Instructions* manual
- Certificate of Product Performance
- Local declarations of conformity, if applicable
- Certificates for hazardous zone use, if applicable
- Material certificates, if applicable
- Rxn-30 probe optional accessories, if applicable

If you have any queries, please contact your supplier or local sales center.

5 Probe and fiber optic connection

The Rxn-30 probe connects to the Raman Rxn analyzer via one of the following:

- Fiber channel (FC) cable assembly
- Electro-optical (EO) fiber cable

An optional EO extension fiber cable is also available.

Fiber optic cables are available in 5 m (16.4 ft.) increments with the length configured to suit and limited by the application. Refer to the applicable Raman Rxn analyzer operating instructions for analyzer connection details. When connecting, ensure the following, as applicable:

- The laser interlock is connected to the safety indicator light and to any other safety systems (such as purges) appropriate to the installation.
- Remote interlock connectors are in place on each channel.

NOTICE

Connection of the probe to the FC cable assembly or the EO fiber cable must be conducted by a qualified Endress+Hauser engineer or specially trained technical personnel.

- ▶ Unless trained by qualified personnel, customer attempts to connect the probe to the fiber optic cable can result in damage and may void the warranty.
- ▶ Contact your local Endress+Hauser service representative for additional support regarding the probe and fiber cable connection.

5.1 FC cable assembly

The FC cable assembly connects the Rxn-30 probe to the analyzer via the following:

- Electrical interlock connector
- Yellow (YE) excitation fiber for laser output
- Red (RD) collection fiber for spectrograph input

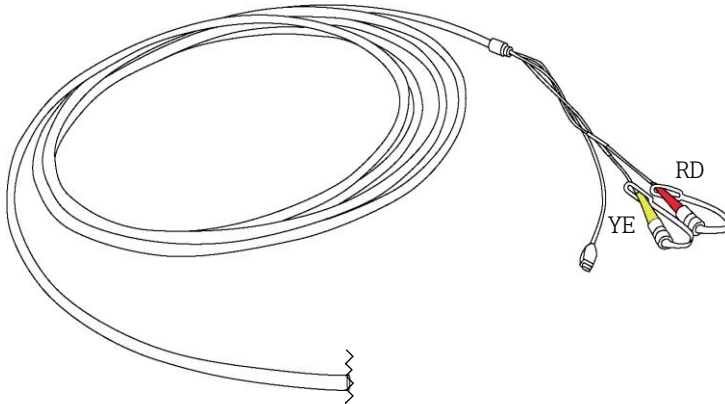

A0048939

Figure 4. FC cable assembly showing connector for analyzer

5.2 EO fiber cable

The EO fiber cable connects the Rxn-30 probe to the analyzer with a single, robust connector that contains the excitation and collection fiber-optics as well as an electrical laser interlock.

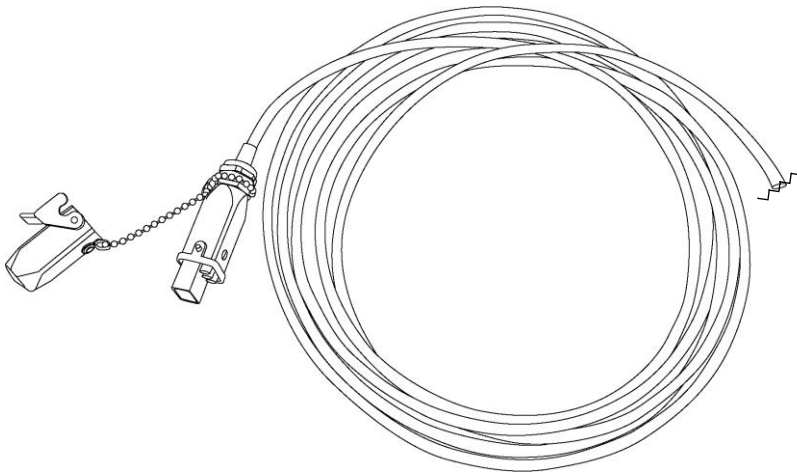

A0048938

Figure 5. EO fiber cable showing connector for analyzer

6 Installation

Prior to installation in the process, verify that the amount of laser power out of each probe is no more than the amount specified in the Hazardous Area Equipment Assessment (4002266) or equivalent.

Standard eye and skin safety precautions for Class 3B laser products (as per EN-60825/IEC 60825-14) should be observed.

The Rxn-30 probe is designed to accommodate installation to a sample stream or vessel using one of these industry standards:

- ½ inch NPT cross fitting (12.7 mm)
- 1 inch compression cross fitting (25.4 mm)

With either installation, ensure that the sample gas ports will be in the stream flow or region of interest.

6.1 Rxn-30 probe with NPT cross fitting

Endress+Hauser offers an optional, custom ½ inch NPT cross fitting (12.7 mm) with standard NPT adapters for ¼ inch stainless tubing (6.35 mm) (P/N 2013463, not included). It provides four ½ inch NPT ports (12.7 mm). The fourth port may be used for temperature or pressure sensors, condensate drainage, or it may be plugged.

Apply Teflon tape to the NPT threads of the Rxn-30 probe when connecting the probe to the cross fitting.

NOTICE

Excessive twisting of the cable within the connector may break a fiber connection, rendering the Rxn-30 inoperable.

- ▶ Using a compression fitting installation instead of NPT may alleviate this issue.

Take care not to twist the cable within the connector while tightening the Rxn-30 into this or any other NPT fitting. Thread the fitting onto the stationary Rxn-30 if circumstances allow. Otherwise, rotate the entire cable with the probe as the Rxn-30 is threaded into the fitting.

NOTICE

NPT interconnects are not the preferred probe interface if the probe will be removed and reinstalled.

- ▶ For these types of installations, a compression fitting is recommended. See Section 6.2 → .

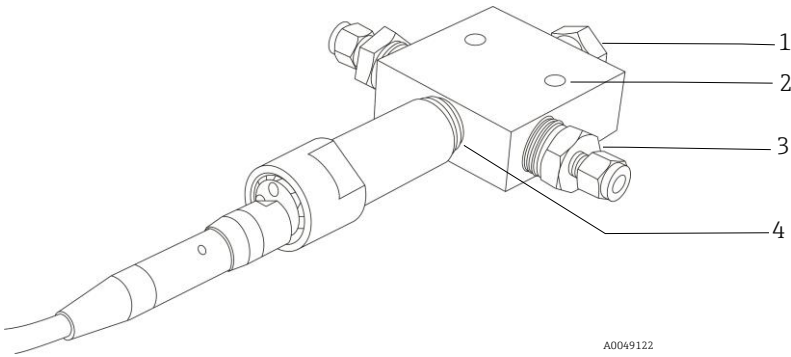

Figure 6. Rxn-30 probe integrated to ½ inch NPT cross fitting

#	Description
1	½ inch NPT plug for port not in use (12.7 mm)
2	(2) ¼ inch mounting holes (6.35 mm)
3	(2) ½ inch NPT to ¼ inch stainless tubing compression adapters (12.7 mm to 6.35 mm)
4	½ inch NPT Rxn-30 port (12.7 mm)

Table 4. Rxn-30 probe integrated to ½ inch NPT cross fitting

6.2 Rxn-30 probe with compression cross fitting

The Rxn-30 probe may also be installed using a standard 1 inch compression cross fitting (25.4 mm), commercially available or from Endress+Hauser (P/N 2013461).

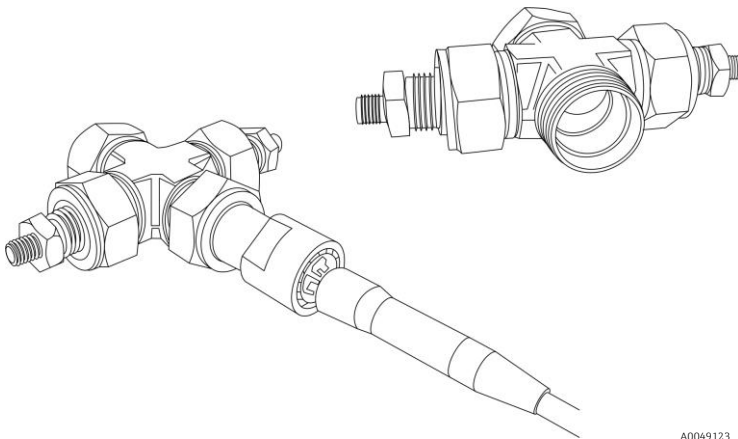

Figure 7. Rxn-30 probe integrated to 1 inch standard compression cross fitting

6.3 Process and probe compatibility

Prior to installation, the user must check that the probe pressure and temperature ratings, as well as the materials from which the probe is made, are compatible with the process into which it is being inserted.

6.4 Hazardous area installation

The Rxn-30 probe is certified for use in hazardous area environments and has been designed to be installed directly into process streams or reactor vessels. The probe must be installed according to the Hazardous Area Installation Drawing (4002396).

NOTICE

When installing the probe *in situ*, the user must provide the strain relief to the fiber optic cable at the probe installation location.

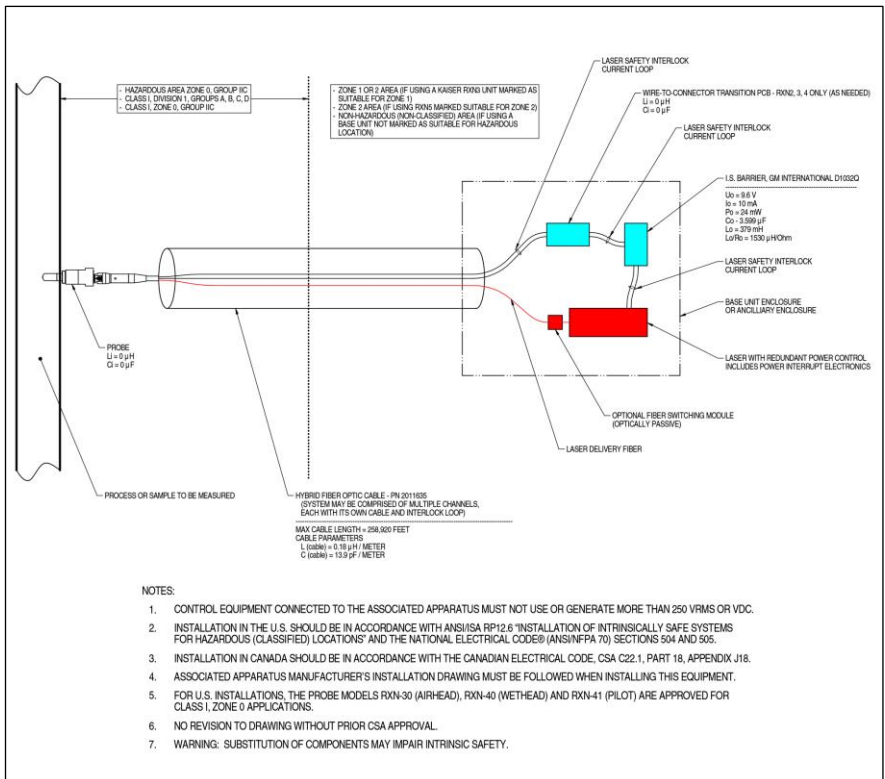

A0049010

Figure 8. Hazardous Area Installation Drawing (4002396 version X5)

7 Commissioning

The Rxn-30 probe is delivered ready to connect to the Raman Rxn analyzer. No additional alignment or adjustment to the probe itself is required. Follow the instructions below to commission the probe for use.

NOTICE

The probe installation and usage parameters may have specific requirements governed by the associated application.

- ▶ Please refer to the appropriate certificate for ATEX, CSA, or IECEx for those specific requirements.

7.1 Receipt of probe

Perform the steps for incoming product acceptance described in Section 4.1 → .

Additionally, upon receipt, remove the shipping container cover and inspect the sapphire window for any damage prior to installing into the process. If the window shows any visible cracks, please contact the supplier.

7.2 Probe calibration and verification

The probe and the analyzer must be calibrated before use.

Refer to the applicable Raman Rxn analyzer operating instructions for steps to:

- Perform internal analyzer calibration; may include alignment calibration, full wavelength calibration or full laser wavelength calibration depending on status of analyzer
- Perform probe calibration; requires a Raman Calibration Accessory (HCA) with an appropriate optic adapter
- Perform probe verification; verifies the calibration results using a standard reference sample
- View calibration and verification reports

The Raman RunTime software will not allow spectra to be collected without passing internal analyzer and probe calibrations. Passing the probe verification step is not required but highly recommended.

Raman Rxn analyzer operating instructions are available by searching the Downloads area of the Endress+Hauser web site: <https://endress.com/downloads>

8 Operation

Refer to the applicable Raman Rxn analyzer operating instructions for additional information not covered below.

8.1 Routine operation

The Endress+Hauser Raman Rxn-30 probe is designed for *in situ* Raman spectroscopy of gas-phase samples in a laboratory or process plant setting. The Rxn-30 line of probes is designed to be compatible with Endress+Hauser Raman Rxn analyzers operating at 532 nm.

8.2 Start-up procedure

Illuminate the Rxn-30 probe with the excitation laser for as long as is practical before acquiring operational Raman spectra. This has the effect of quenching background that originates from the internal optical surfaces of the probe. Guidelines for start-up:

- A minimum of one hour is recommended if the probe has been “dark” for several hours.
- A period of one to three days is recommended if the probe has been “dark” for an extended period (days or weeks).

The quenching reduction in background/baseline and corresponding increase in signal-to-noise ratio (SNR) will be significant in applications involving low concentration or low pressure sample gases.

8.3 Recommendations for optimal performance

The Rxn-30 probe is a sensitive optical instrument that must be handled and operated with appropriate care for optimal performance. The following recommendations and precautions should be observed:

- Keep the sample end of the Rxn-30 probe clean. If dust or other condensates collect on the internal optics of the sample tip, the Raman signature of those contaminants will be added to, or even dominate, the weaker gas sample signatures being measured.
- If the probe becomes contaminated to the point where cleaning is absolutely necessary, refer to the relevant disassembly and cleaning instructions in the *Rxn-30 Raman spectroscopic probe Operating Instructions*. Alternately, you may return the Rxn-30 to Endress+Hauser for cleaning.
- A sintered metal contamination filter is normally mounted over the probe’s gas sample ports for operation in a dirty or hazardous environment. It may be removed, if desired, for a somewhat faster response to changes in gas sample concentrations. Refer to the filter kit installation instructions in the *Rxn-30 Raman spectroscopic probe Operating Instructions*.
- Mount the Rxn-30 in a horizontal orientation. This will minimize the likelihood of any contaminants or condensates collecting on the optical surfaces, thereby minimizing their impact on performance.

- Leave the cable attached to the Rxn-30. The fibers are coupled to the head with index matching gel inside the connector. If the connector is removed, the exposed gel becomes a magnet for contamination that can reduce throughput and risk damage due to laser burn.

If the connector is removed, it is recommended that all traces of the original coupling gel be cleaned from both the cable and Rxn-30 fiber interfaces. Partial disassembly of the input end of the Rxn-30 is necessary in order to accomplish this. Fresh coupling gel must then be reapplied immediately prior to reconnection. These operations should only be performed by factory trained service personnel.

- Do not twist the cable at its connection to the Rxn-30 probe. If the probe is interfaced to an NPT fitting, follow the NPT cross fitting installation instructions in the *Rxn-30 Raman spectroscopic probe Operating Instructions* to ensure the internal fiber optical connection is not damaged.

9 Diagnostics and troubleshooting

Refer to the table below when troubleshooting issues with the Rxn-30 probe. If the probe is damaged, isolate the probe from the process stream and turn off the laser prior to evaluation. Contact your service representative as needed for assistance.

Symptom	Possible cause	Action	
1	Substantial reduction in signal or signal-to-noise ratio	<ol style="list-style-type: none"> Carefully remove probe from the process, decontaminate, and inspect optical window at tip of probe. If necessary, clean the window before returning it to service. Refer to the <i>Rxn-30 Raman spectroscopic probe Operating Instructions</i>. 	
	Cracked but intact fiber	Verify condition of fiber and contact your service representative for replacement.	
2	Complete loss of signal while laser is powered and LED laser indicator is lit	Broken fiber without interlock wire breakage	Ensure all fiber connections are secure.
3	Rising baseline when compared to result at installation	Probe window or retro fouling	<ol style="list-style-type: none"> Turn off the laser for the contaminated probe. Clean the window and mirror before returning to service. If increased baseline persists, contact your service representative.
4	High signal level	Detector saturation is too high. Possible increase in sample pressure	Check that the sample pressure is in range with the original installation conditions.
5	LED laser indicator on probe is not lit	Damaged fiber assembly	Look for signs of breakage in fiber. Contact your service representative for replacement.
		Fiber cable EO connector not secured/latched	Ensure EO connector is properly connected and latched at the probe (if applicable) and at the analyzer.
		Remote interlock connector disconnected	Ensure the twist-lock remote interlock connector at the rear of analyzer (next to fiber EO connector) is connected.
6	Unstable signal and contamination visible behind window	Window seal failure	<ol style="list-style-type: none"> Examine the area inside the window for moisture or condensation. Examine the probe for fluid penetration or signs of sample fluid in the probe body (e.g., corrosion, residue). Look for any sign of spectral deviation. If any of the above are noted, contact your service representative to return the probe to the manufacturer.

Symptom		Possible cause	Action
7	Decreased laser power or collection efficiency	Contaminated fiber connection	Carefully clean the fiber ends at the probe. Refer to the applicable Raman Rxn analyzer operating instructions for cleaning instructions and steps for starting up a new probe.
8	Laser interlock on analyzer causes laser to shut down	Laser interlock activated	Check for fiber breakage on all connected fiber optic cable channels and ensure remote interlock connectors are in place on each channel.
9	Unrecognized bands or patterns in the spectra	Cracked but intact fiber	Verify possible causes and contact your service representative to return the damaged product.
		Contaminated probe tip	
		Contaminated internal optics of probe due to leakage	
10	Other unexplained negative performance of the probe	Physical damage to probe	Contact your service representative to return the damaged product.

Table 5. Troubleshooting

www.addresses.endress.com
