

Special Documentation

Proline Promag 300

Functional Safety Manual
HART



Table of contents

1	Manufacturer's Declaration	4	8	Repair and error handling	43
1.1	Safety-related characteristic values	5	8.1	Maintenance	43
2	Certificate	8	8.2	Repair	43
3	About this document	9	8.3	Modification	44
3.1	Document function	9	8.4	Taking out of service	44
3.2	Using this document	9	8.5	Disposal	44
3.3	Symbols	9	9	Appendix	44
3.4	Supplementary device documentation ..	10	9.1	Structure of the measuring system	44
4	Design	11	9.2	Commissioning or proof test report	47
4.1	Permitted device types	11	9.3	Verification or calibration	49
4.2	Marking	13	9.4	Version history	49
4.3	Notes on the redundant use of multiple sensors	14			
4.4	Basic conditions for use in safety-related applications	16			
4.5	Safety measured error	17			
4.6	Useful lifetime of electrical components	19			
5	Commissioning (installation and configuration)	19			
5.1	Requirements for the personnel	19			
5.2	Installation	19			
5.3	Commissioning	19			
5.4	Operation	20			
5.5	Parameter configuration for safety-related applications	20			
6	Operation	29			
6.1	Device behavior during power-up	29			
6.2	Device behavior in safety function demand mode	29			
6.3	Safe states	29			
6.4	Device behavior in event of alarms and warnings	29			
6.5	Alarm and warning messages	30			
7	Proof testing	30			
7.1	Test sequence A (PTC = 99 %)	32			
7.2	Test sequence C (PTC = 98 %)	35			
7.3	Test sequence D (PTC = 36 %)	36			
7.4	Test sequence E (PTC = 19 %)	40			
7.5	Test sequence F (PTC = 0 %)	41			
7.6	Verification criterion	43			

1 Manufacturer's Declaration

Products

Solutions

Services

HE_61508_Promag_300_500_de_en.docx

Herstellererklärung - Manufacturer Declaration Funktionale Sicherheit / Functional Safety (IEC 61508)

Endress+Hauser Flowtec AG, Kägenstrasse 7, 4153 Reinach

erklärt als Hersteller, dass die Durchflussmessgeräte aus der Serie
declares as a manufacturer, that the flow meters of the product line

Proline Promag 300 (5a3B)
Proline Promag 500 (5a5B)

a = H, P, W

in sicherheitsrelevanten Anwendungen SIL 2 (HFT=0) bzw. SIL 3 (HFT=1) nach
IEC 61508:2010 eingesetzt werden können.
are suitable for use in safety relevant applications up to SIL 2 (HFT=0) resp. SIL 3 (HFT=1) acc. IEC
61508:2010.

Für einen Einsatz in sicherheitsrelevanten Anwendungen entsprechend IEC 61508 sind die Angaben
des Handbuchs zur Funktionalen Sicherheit zu beachten. Die Installation muß konform zu diesem
Handbuch ausgeführt werden und die Sicherheitshinweise sind zu beachten.
For safety relevant applications according to IEC 61508, we refer to our hand-book named functional
safety. The installation has to be conform to our descriptions in our handbook in consideration of our
safety instructions.

Die Kenngrößen für die Verwendung des Produktes in sicherheitsrelevanten Anwendungen können
dem Handbuch zur Funktionalen Sicherheit entnommen werden.
The characteristics for use of these products in safety relevant applications can be found in the
functional safety manual.

Reinach, 14. Juli 2016

Endress+Hauser Flowtec AG

Dr. B.-J. Schäfer
Managing Director

i.V. 
M. Karolzak
Project Manager Functional Safety

Endress+Hauser 
People for Process Automation

1.1 Safety-related characteristic values

General	
Device designation and permitted versions	5H3B (Promag H 300) 5P3B (Promag P 300) 5W3B (Promag W 300)
	Order code for "Output; input 1": <ul style="list-style-type: none"> ▪ Option BA "4-20mA HART" ▪ Option BB "4-20mA + Wireless HART" ▪ Option CA "4-20mA HART Ex-i passive" ▪ Option CB "4-20mA Ex-i + Wireless HART" ▪ Option CC "4-20mA HART Ex-i active" Order code for "Output; input 2": All options
	Order code for "Output; input 3": All options
	Order code for "Additional approval": Option LA "SIL"
Safety-related output signal	4 to 20 mA (output; input 1)
Failure current	≤ 3.6 mA or ≥ 21 mA
Assessed measured variable/function	Volume flow monitoring
Safety function(s)	Min., Max., Range
Device type according to IEC 61508-2	<input type="checkbox"/> Type A <input checked="" type="checkbox"/> Type B
Operating mode	<input checked="" type="checkbox"/> Low Demand Mode <input checked="" type="checkbox"/> High Demand Mode <input type="checkbox"/> Continuous Mode ¹⁾
Valid hardware version (main electronics)	From delivery date October 1, 2017
Valid firmware version	01.01.zz and higher (HART; from delivery date October 1, 2017)
Safety manual	SD01740D
Type of assessment (only 1 version can be selected)	<input checked="" type="checkbox"/> Complete HW/SW assessment in the context of development including FMEDA and change process according to IEC 61508-2, 3 <input type="checkbox"/> Assessment of evidence for proven-in-use HW/SW including FMEDA and change process according to IEC 61508-2, 3 <input type="checkbox"/> Analysis of HW/SW field data for evidence of "prior use" according to IEC 61511 <input type="checkbox"/> Assessment by FMEDA according to IEC 61508-2 for devices without software
Assessment by (including report no. + FMEDA data source)	TÜV Rheinland Industrie Service GmbH – Certificate No. 968/FSP 1408.00/17
Test documents	Development documents, test reports, data sheets

1) No continuous operation in accordance with IEC 61508: 2011 (Section 3.5.16).

SIL integrity			
Systematic safety integrity		<input type="checkbox"/> SIL 2 capable	<input checked="" type="checkbox"/> SIL 3 capable
Hardware safety integrity	Single-channel service (HFT = 0)	<input checked="" type="checkbox"/> SIL 2 capable	<input type="checkbox"/> SIL 3 capable
	Multi-channel service (HFT ≥ 1)	<input type="checkbox"/> SIL 2 capable	<input checked="" type="checkbox"/> SIL 3 capable

FMEDA				
Safety function(s)	Min., Max., Range			
Device model	A1		A2	
	Option BA, BB	Option CA, CB	Option BA, BB	Option CA, CB, CC
$\lambda_{DU}^{1)}$	132 FIT	128 FIT	152 FIT	148 FIT
λ_{DD}	1647 FIT	1627 FIT	2338 FIT	2317 FIT
λ_{SU}	1528 FIT	1724 FIT	1744 FIT	1940 FIT
λ_{SD}	1240 FIT	1226 FIT	2022 FIT	2009 FIT
SFF - Safe Failure Fraction	97 %		97 %	
PF _{D_{avg}} for T ₁ = 1 year ²⁾ (single-channel architecture)	$5.8 \cdot 10^{-4}$	$5.6 \cdot 10^{-4}$	$6.6 \cdot 10^{-4}$	$6.5 \cdot 10^{-4}$
PF _{D_{avg}} for T ₁ = 4 years (single-channel architecture)	$2.3 \cdot 10^{-3}$		$2.6 \cdot 10^{-3}$	
PFH	$6.6 \cdot 10^{-8}$	$6.4 \cdot 10^{-8}$	$7.6 \cdot 10^{-4}$	$7.4 \cdot 10^{-4}$
PTC ³⁾	Up to 99 %		Up to 99 %	
MTBF _{tot} ⁴⁾	69 years	58 years	69 years	57 years
Diagnostic test interval ⁵⁾	30 min		30 min	
Fault response time ⁶⁾	30 s		30 s	
Process safety time ⁷⁾	50 h		50 h	
Recommended test interval T ₁	4 years		3 years	
MTTF _d ⁸⁾	64 years	65 years	45 years	46 years

- 1) FIT = Failure In Time, number of failures per 10⁹ h.
- 2) Valid for averaged ambient temperatures up to 40 °C (104 °F) in accordance with general standard for devices with SIL capability.
- 3) PTC = Proof Test Coverage (diagnostic coverage achieved by device failure detection during manual proof testing).
- 4) This value takes into account all failure types of the electronic components as per Siemens SN29500.
- 5) All diagnostic functions are carried out at least once during this time.
- 6) Maximum time between fault detection and fault response.
- 7) The process safety time amounts to the diagnostic test interval * 100 (calculation as per IEC 61508).
- 8) MTTF_d as per ISO 13849/IEC 62061 also includes soft errors (sporadic bit errors in data memories).

Note

The measuring device has been developed for use in "Low Demand" and "High Demand" mode.

Explanation

Our in-house quality management system saves information on safety-related systematic errors that will become known in the future.

2 Certificate

Certificate can be accessed at www.endress.com:

1. Downloads
2. Approvals
3. Type: Functional safety (SIL)
4. Product root: e.g. 5H3B
5. Press the "Search" button

3 About this document

3.1 Document function

This document is part of the Operating Instructions and serves as a reference for application-specific parameters and notes.



General information about functional safety **SIL** is available in the Download Area of the Endress+Hauser website: www.endress.com/SIL.

3.2 Using this document

3.2.1 Information on the document structure



For additional information regarding the arrangement of the parameters, along with a short description, according to the **Operation** menu, **Setup** menu, **Diagnostics** menu and the operating concept, see the Operating Instructions, "Supplementary device documentation" section

3.3 Symbols

3.3.1 Safety symbols



This symbol alerts you to a dangerous situation. Failure to avoid this situation will result in serious or fatal injury.



This symbol alerts you to a dangerous situation. Failure to avoid this situation can result in serious or fatal injury.











This symbol alerts you to a dangerous situation. Failure to avoid this situation can result in minor or medium injury.



This symbol contains information on procedures and other facts which do not result in personal injury.

3.3.2 Symbols for certain types of Information

Symbol	Meaning
	Permitted Procedures, processes or actions that are permitted.
	Preferred Procedures, processes or actions that are preferred.
	Forbidden Procedures, processes or actions that are forbidden.
	Tip Indicates additional information.

Symbol	Meaning
	Reference to documentation
	Reference to page
	Reference to graphic
	Notice or individual step to be observed
1, 2, 3...	Series of steps
	Result of a step
 A0028662	Operation via local display
 A0028663	Operation via operating tool
 A0028665	Write-protected parameter

3.3.3 Symbols in graphics

Symbol	Meaning
1, 2, 3 ...	Item numbers
A, B, C, ...	Views
A-A, B-B, C-C, ...	Sections

3.4 Supplementary device documentation

 For an overview of the scope of the associated Technical Documentation, refer to the following:

- *Device Viewer* (www.endress.com/deviceviewer): Enter the serial number from the nameplate
- *Endress+Hauser Operations app*: Enter serial number from nameplate or scan matrix code on nameplate.

 This Special Documentation and other documentation is available:
In the Download Area of the Endress+Hauser website: www.endress.com → Downloads

This documentation is an integral part of the following Operating Instructions:

Measuring device	Documentation code
Promag H 300	BA01392D
Promag P 300	BA01393D
Promag W 300	BA01918D

4 Design

4.1 Permitted device types

The information on functional safety contained in this manual relates to the device versions listed below and are valid as of the specified software and hardware version.

Unless otherwise specified, all subsequent versions can also be used for safety functions.

A modification process according to IEC 61508 is applied for any device modifications.

Valid device versions for safety-related use:

4.1.1 Order codes

Feature	Designation	Option selected
–	Order code	5H3B (Promag H 300) 5P3B (Promag P 300) 5W3B (Promag W 300)
000	Nominal diameter	All
010	Approval; transmitter + sensor	All
015	Power supply	All
020	Output; input 1 ¹⁾	<ul style="list-style-type: none"> ▪ Option BA "4-20mA HART" ▪ Option BB "4-20mA + Wireless HART" ▪ Option CA "4-20mA HART Ex-i passive" ▪ Option CB "4-20mA Ex-i + Wireless HART" ▪ Option CC "4-20mA HART Ex-i active"
021	Output; input 2	All
022	Output; input 3	All
030	Display; operation	All
040	Housing	All
050	Electrical connection	All
060	Liner	All
070	Process connection	All
075	Electrodes	All
080	Calibration flow	All

Feature	Designation	Option selected
480	Device model	All
500	Display operating language	All
520	Sensor option	All
530	Customer-specific configuration	All
540	Application package	<ul style="list-style-type: none"> ▪ EA "Extended HistoROM" ▪ EB "Heartbeat Verification + Monitoring" ▪ EL "OPC-UA server"
550 ²⁾	Suitability for custody transfer measurement	All
570	Service	All
580	Test, certificate	All
590	Additional approval	LA (= SIL) ³⁾
610	Accessory mounted	All
620	Accessory enclosed	All
850	Firmware version	Firmware with SIL capability, e.g. 01.01.zz (HART)
895	Marking	All

- 1) In devices with several outputs, only current output 1 (terminals 26 and 27) is suitable for safety functions. The other outputs can, if necessary, be connected for non-safety-oriented purposes.
- 2) Only for devices with approval for custody transfer
- 3) Additional selection of further approvals is possible.

4.1.2 Suitability of the measuring device

1. Carefully select the nominal diameter of the measuring device in accordance with the application's expected flow rates.
 - ↳ The maximum flow rate during operation must not exceed the specified maximum value for the sensor.
For further information on selecting the nominal diameter, see the Technical Information
2. In SIL mode: ensure that the measuring tube is filled.
 - ↳ Empty pipe detection is switched to the **Off** option in the SIL mode.

NOTICE**Use the measuring device according to the specifications.**

- ▶ Pay attention to the medium properties and the environmental conditions.
- ▶ Carefully follow instructions pertaining to critical process situations and installation conditions.



Detailed information on:

- Mounting
- Electrical connection
- Medium properties
- Environment
- Process

Operating Instructions →  10

CAUTION**For liquids that readily boil or in the case of suction lines:**

- ▶ It is the responsibility of the user to assess the influence of the process conditions and the medium on the measurement result in safety equipment, particularly the occurrence of changes in the magnetic system due to external magnetic fields or deposit buildup.
- ▶ Ensure that the vapor pressure is not undershot and that the liquid does not start to boil.
- ▶ Please ensure that there is never any outgassing of the gases naturally contained in many liquids. Sufficiently high system pressure prevents the occurrence of these effects.
- ▶ In order to guarantee correct measurement, ensure that no cavitation occurs.



Further information on the suitability of the measuring device for safety-related operation is available from your Endress+Hauser sales center.

4.2 Marking

SIL certified devices are marked with the SIL logo on the nameplate.

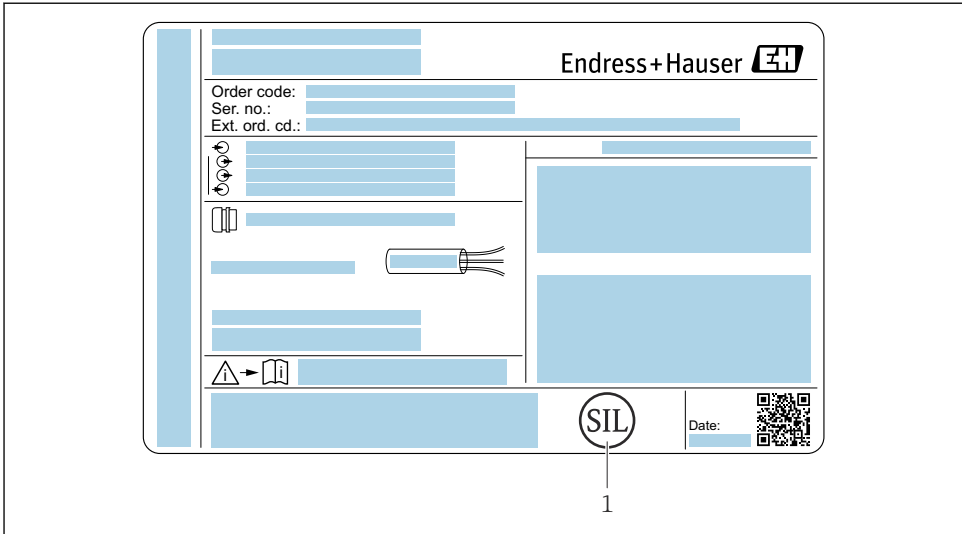

A0031473

1 SIL logo

4.3 Notes on the redundant use of multiple sensors

This section provides additional information regarding the use of homogeneously redundant sensors e.g. in 1oo2 or 2oo3 architectures.

The common cause factors β and β_D indicated below are minimum values for the device. These must be used when designing the sensor subsystem:

- Minimum value β for homogeneously redundant use: 2 %
- Minimum value β_D for homogeneously redundant use: 1 %

The device meets the requirements for SIL 3 in homogeneously redundant applications.

If two sensors with an identical design (same type and same nominal diameter) are directly connected to one another flange-to-flange, mutual acoustic interference cannot be entirely ruled out. To fully rule out potential interference, it is recommended to install the sensors at different points of the pipe or to insert a spacer between the two sensors. The spacer must be at least half as long as the sensor.

NOTICE

Note the following if a fault is detected in one of the redundantly operated devices during the proof test:

- ▶ Check the other devices to see if the same fault occurs there.

4.3.1 Safety-related output signal

The device's safety-related signal is the 4 to 20 mA analog output signal as per NAMUR NE43. All safety measures refer to this signal exclusively.

The device additionally communicates for information only via HART and contains all HART features with additional device information. HART communication is not part of the safety function.

The safety-related output signal is fed to a downstream logic unit, e.g. a programmable logic controller or a limit signal transmitter, where it is monitored for the following:

- Overshooting and/or undershooting of a specified limit value
- The occurrence of a fault: e.g. failure current ($\leq 3.6 \text{ mA}$, $\geq 21 \text{ mA}$, signal cable open circuit or short-circuit)



In the event of a fault, it must be ensured that the equipment under control achieves or maintains a safe state.

The safety-related errors are broken down in accordance with IEC/EN 61508 into different categories and implications for the safety-related output signal.

Safety-related error	Explanation	Item no →  1 Impact on measuring uncertainty	Implication for safety-related output signal
No device error	Safe: No error	1 Within specification	None
λ_{SD}	Safe detected: Safe, detectable failure present	3 No implications	Causes a failure current at the output signal
λ_{SU}	Safe undetected: Safe, undetectable failure present	2 May be outside specifications	Is within the defined error range
λ_{DD}	Dangerous detected: Dangerous but detectable failure present (diagnosis in device)	3 No implications	Causes a failure current at the output signal

Safety-related error	Explanation	Item no → 1 Impact on measuring uncertainty	Implication for safety-related output signal
λ_{DU}	Dangerous undetected: Dangerous, undetectable failure present	4 May be outside the defined error range	May be outside the defined error range

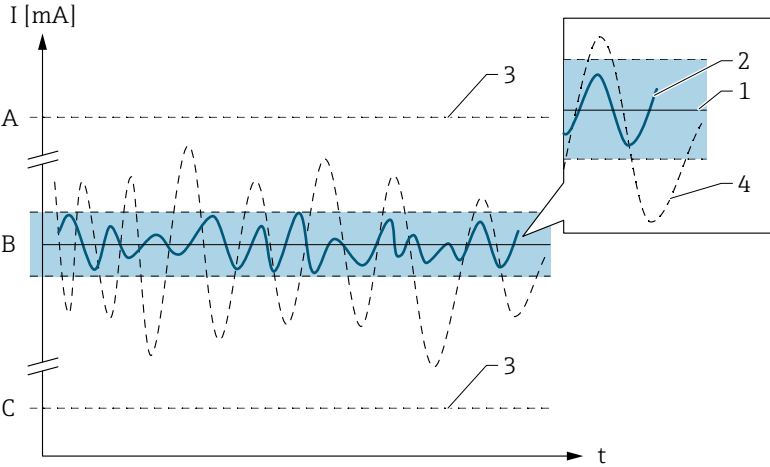

A0034924

1 Safety-related output signal

- A Failure current $\geq 21 \text{ mA}$
- B Measuring uncertainty according to device's technical data
- C Failure current $\leq 3.6 \text{ mA}$

4.4 Basic conditions for use in safety-related applications

1. The measuring device must be used correctly for the specific application, taking into account the medium properties and ambient conditions.
2. Carefully follow safety instructions pertaining to critical process situations and installation conditions, which can be found in the device documentation.
3. Observe application-specific limits.
4. Do not exceed technical specifications of measuring device.

Information on the safety-related signal

For detailed information on the technical specifications, see the device documentation → 10.

4.4.1 Additional restrictions for safety-related use

An incorrect output signal that deviates from the value specified in the Operating Instructions but is still in the range of 4 to 20 mA, is considered a dangerous, undetected failure.



Information on measured error → 17



For detailed information on the maximum measured error, see the Operating Instructions → 10

4.5 Safety measured error

When the measured value is transmitted via the 4–20 mA current output, the measuring device's relative measured error is made up of the contribution of the digitally determined measured value and the accuracy of the analog current output. These contributions, which are listed in the device documentation, apply under reference operating conditions and can depend on the sensor version ordered.



For further information on calculating the measured error, see the Technical Information.

4.5.1 Power supply to the 4–20 mA current output

Overvoltages at the 4–20 mA current output (passive, output; input 1) - caused by a fault in the supply unit, for example - can result in a leak current in the device's input protection unit. This may lead to falsification of the output signal by more than the specified error or the minimum failure current (3.6 mA) can no longer be set due to the leak current.

- ▶ Use a 4–20 mA power supply unit with either voltage limitation or voltage monitoring.

NOTICE

The safety-related connection values depend on the Ex approval.

- ▶ Pay attention to the safety-related connection values.



For detailed information on the connection values, see the Safety Instructions.

4.5.2 HART communication

The measuring device also communicates via HART or WirelessHART in the SIL mode. This comprises all the HART features with additional device information.

NOTICE

The measuring device's safety-related signal is the 4–20 mA analog output signal (output; input 1).

All safety measures refer to this signal exclusively.

- ▶ Please note the following: → 14.

NOTICE

When the SIL locking code is entered, the device parameters that affect the safety-related output signal are locked and write-protected. It is still possible to read the parameters.

When SIL locking is enabled, restrictions apply on all communication options, such as the service interface (CDI-RJ45), HART protocol and WirelessHART protocol, local display and WLAN.

- ▶ Deactivation of the SIL mode →  28.

4.6 Useful lifetime of electrical components

The established failure rates of electric components apply for a useful lifetime of 12 years as per IEC 61508-2: 2010, Section 7.4.9.5, Note 3. Once a device has exceeded its useful lifetime, it should be replaced.

The device's year of manufacture is coded in the first character of the serial number (→ table below).

Example: serial number L5ABBF02000 → year of manufacture 2016

ASCII character	Meaning	ASCII character	Meaning	ASCII character	Meaning
D	2010	K	2015	R	2020
E	2011	L	2016	S	2021
F	2012	M	2017	T	2022
H	2013	N	2018	V	2023
J	2014	P	2019	W	2024

5 Commissioning (installation and configuration)

5.1 Requirements for the personnel

The personnel for installation, commissioning, diagnostics and maintenance must fulfill the following requirements:

- ▶ Trained, qualified specialists must have a relevant qualification for this specific function and task.
- ▶ Are authorized by the plant owner/operator.
- ▶ Are familiar with federal/national regulations.
- ▶ Before starting work, read and understand the instructions in the manual and supplementary documentation as well as the certificates (depending on the application).
- ▶ Follow instructions and comply with basic conditions.

The operating personnel must fulfill the following requirements:

- ▶ Are instructed and authorized according to the requirements of the task by the facility's owner-operator.
- ▶ Follow the instructions in this manual.

5.2 Installation

The mounting and wiring of the device and the permitted orientations are described in the Operating Instructions pertaining to the device.

5.3 Commissioning



For detailed information on commissioning, see the Operating Instructions.

5.4 Operation

 For detailed information on the operating options, see the Operating Instructions.

5.5 Parameter configuration for safety-related applications

5.5.1 Adjustment of the measuring point

The measuring point is calibrated via the operating interfaces. A wizard guides you systematically through all the submenus and parameters that have to be set for configuring the measuring device.

 For detailed information on the operating options, see the Operating Instructions.

 For detailed information on configuring the measuring device, see the Operating Instructions and Description of Device Parameters

Device protection

The devices can be protected against external influences as follows:

- Hardware write protection
- Software write protection

The application of these methods is described below.

5.5.2 Activation of SIL mode

To activate the SIL mode, the device must run through a confirmation sequence. While running through this sequence, critical parameters are either set automatically by the device to standard values or transferred to the local display/operating tool to enable verification of the setting. On completion of parameter configuration, the SIL mode of the device must be enabled with a SIL locking code.

Availability of the SIL mode function

NOTICE

The SIL confirmation sequence is only visible on the local display and in the operating tools for devices with the order code for "Additional approval", option LA "SIL".

- ▶ For this reason, the SIL mode can also only be activated on these measuring devices.
- ▶ If the LA "SIL" option was ordered for the flowmeter ex works, this option is available when the measuring device is delivered to the customer. Access is via the operating interfaces of the measuring device.
- ▶ If the order option cannot be accessed in the measuring device, the function cannot be retrofitted during the life cycle of the device. If you have any questions please contact your Endress+Hauser service or sales organization.



Ways to check function availability in the measuring device:

Using the serial number:

Device viewer ¹⁾ → Order code for "Additional approval", option LA "SIL"

1) www.endress.com/deviceviewer

Detailed information concerning the SIL label:

- Permitted device types →  11
- SIL marking on the transmitter nameplate →  13

Overview of the SIL mode

The SIL mode enables the following steps:

1. Makes sure that the preconditions are met.
 - ↳ The measuring device checks whether the user has correctly configured a predefined set of parameters for the safety function.
If the result is positive, the device continues with the activation of the SIL mode.
If the result is negative, the sequence is not permitted or is aborted, and the device does not continue with the activation of the SIL mode.
2. Automatically switches a predefined set of parameters to the default values specified by the manufacturer.
 - ↳ This parameter set ensures that the flowmeter works in the safety mode.
3. Guides the user through the preconfigured parameters for checking.
 - ↳ This ensures that the user actively checks all the important pre-settings.
4. Activates write protection for all the relevant parameters in the SIL mode.

All this ensures that the parameter settings that are required for the safety function are configured correctly. (These settings cannot be circumvented either deliberately or by accident.)

5.5.3 Locking a SIL device

When locking a SIL device, all safety-related parameter settings are shown to the operator individually and must be confirmed explicitly. Parameter settings not permitted in the locked SIL mode are reset to their default values where necessary. A SIL locking code is then entered to lock the device software to ensure that parameters cannot be changed. Non-safety-related parameters remain unchanged.

NOTICE

Once the SIL device has been locked, the process-related parameters are write protected, and thereby locked, for security reasons.

It is still possible to read the parameters. When SIL locking is enabled, restrictions apply on all communication options, such as the service interface, HART protocol and WirelessHART protocol, local display and WLAN.

► Follow the specified locking sequence.

1. Check preconditions are met.

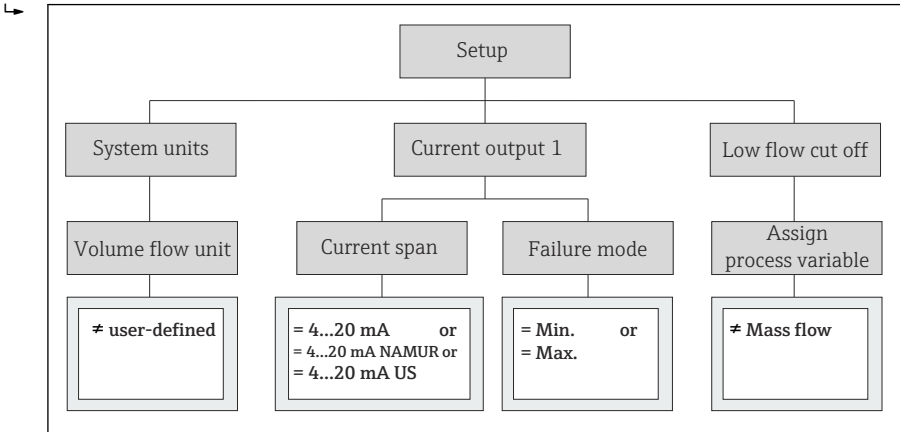

A0025718-EN

2. In the **Setup** menu → **Advanced setup** submenu, select the **SIL confirmation** wizard.
3. Select the **Set write protection** parameter.
4. Enter the SIL locking code **7452**.

↳ The device first checks the preconditions listed under item 1.

NOTICE

If these preconditions are not met, the message "SIL preparation = failed" appears on the display along with the parameter that failed to meet the preconditions under 1.

The SIL confirmation sequence is not continued.

► Check preconditions.

If the preconditions are met, the message **SIL preparation = finished** appears on the display.

Once the preconditions have been met, the device automatically switches the following parameters to safety-oriented settings:

NOTICE

If the measuring device has been set to the Mass flow option measured variable, the Assign current output in the SIL confirmation sequence is automatically changed to Volume flow option.

The 4 mA value and 20 mA value are reset to the factory setting.

- ▶ Cancel the SIL confirmation sequence.
- ▶ Check the settings of the current output and change them if necessary.

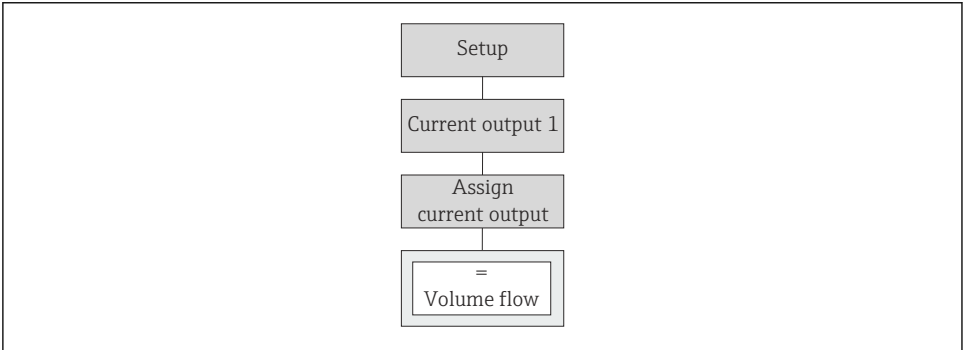

A0025650-EN

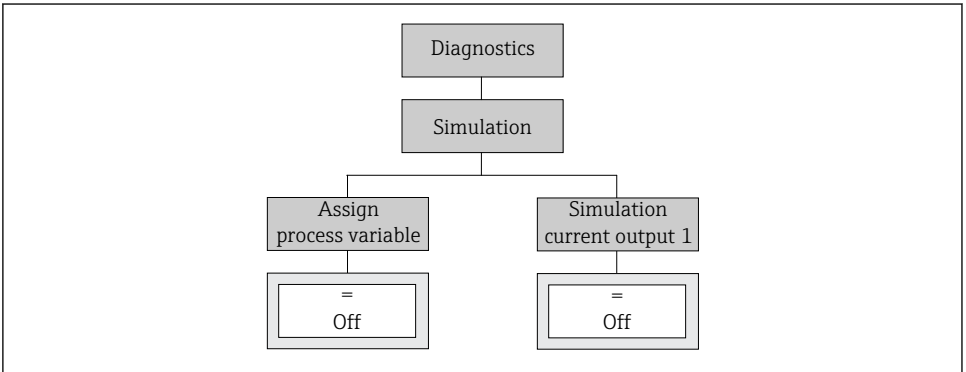

A0021506-EN

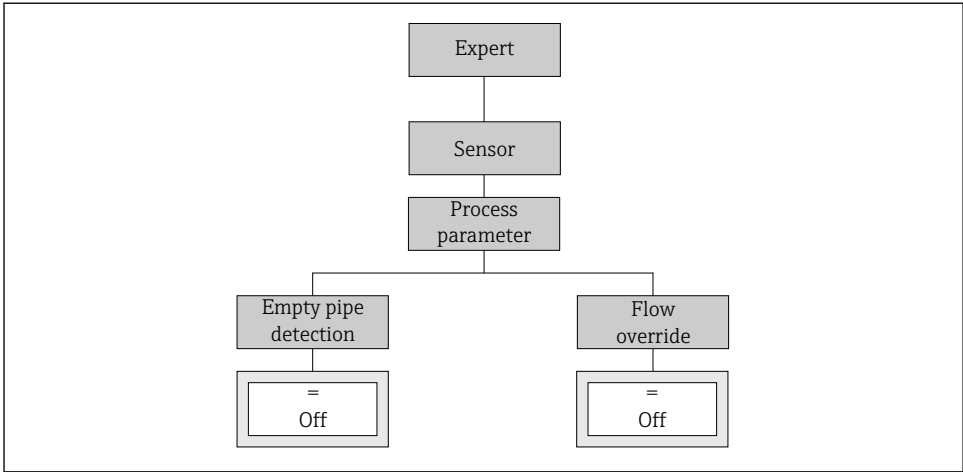

A0031507-EN

The diagnostic behavior is set in such a way that the measuring device is set to the safe state when an error occurs. This means that the diagnostic messages listed in the graphic are set to alarm and the current output adopts the configured failsafe mode .

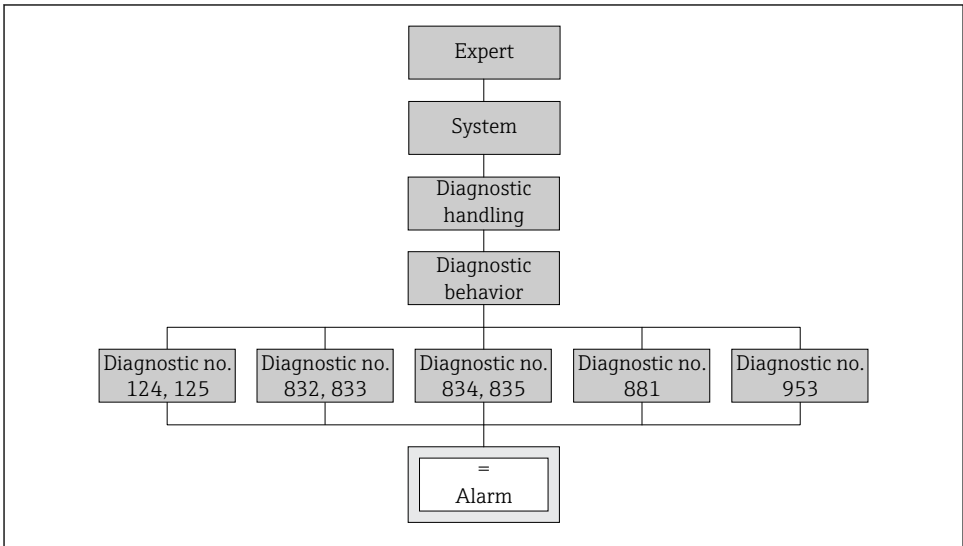

A0043167-EN

- 124 Relative signal strength
- 125 Relative sound velocity
- 832 Electronics temperature too high

- 833 Electronics temperature too low
- 834 Process temperature too high
- 835 Process temperature too low
- 881 Sensor signal path
- 953 Asymmetry noise signal too high path

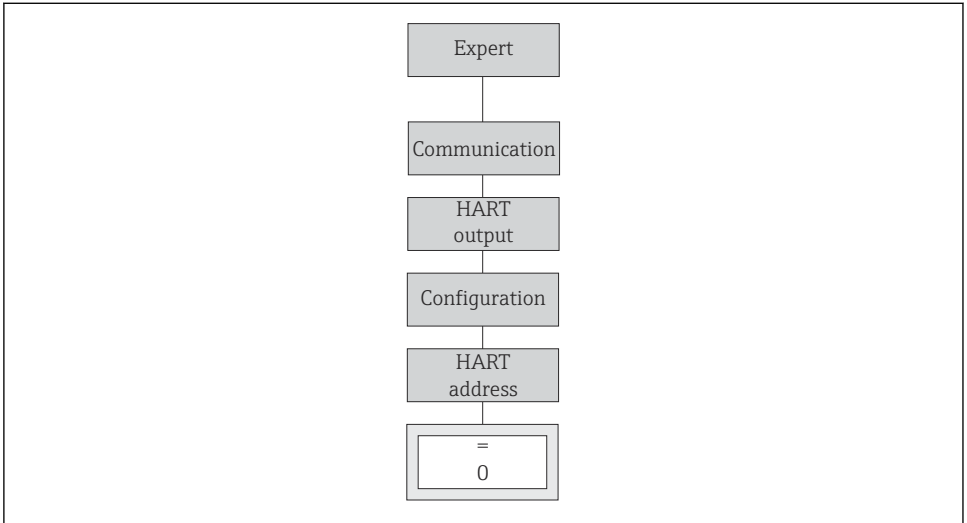

A0031495-EN

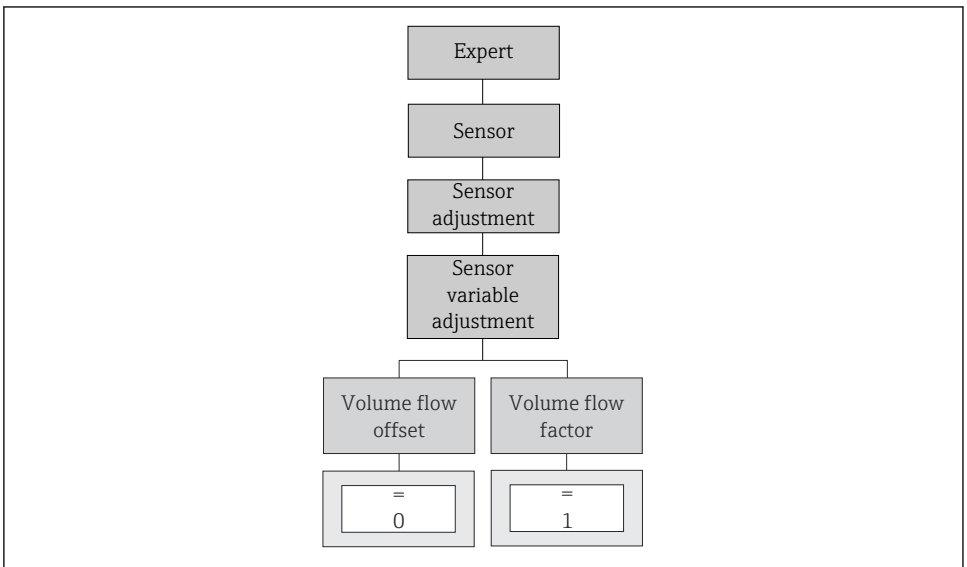

A0031496-EN

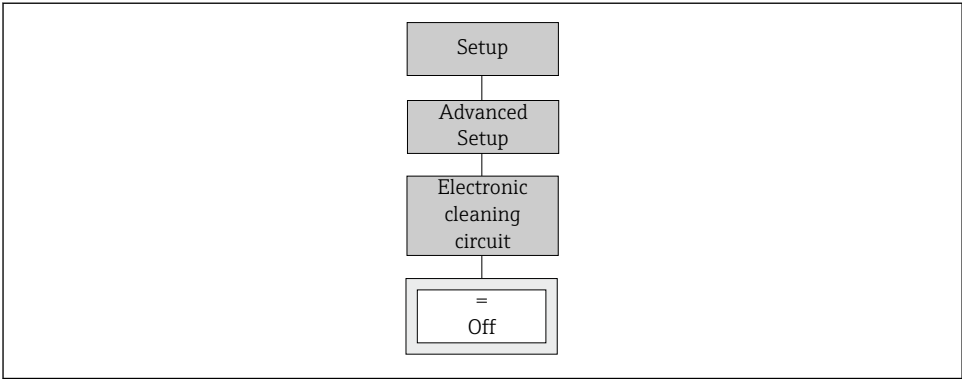

A0031501-EN

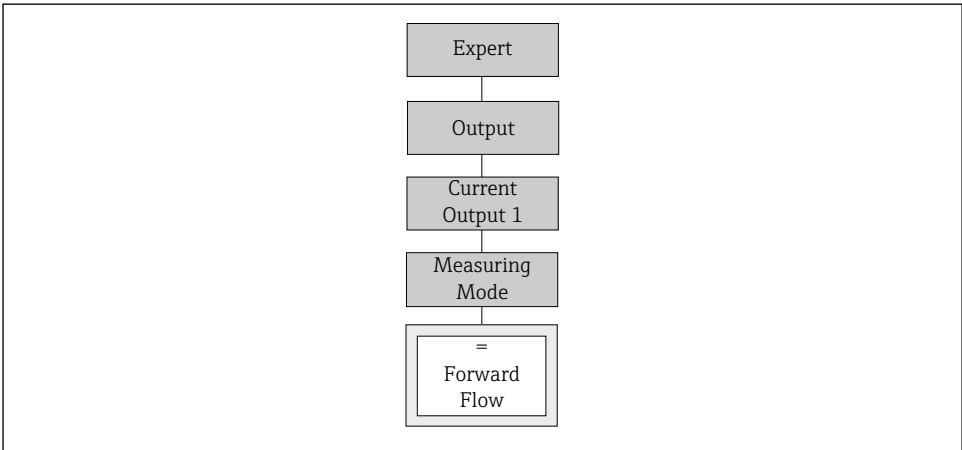

A0031506-EN

To check that values are displayed correctly, the following string appears on the device display or operating tool: **0123456789+-**.

5. The user must confirm that the values are displayed correctly.

- ↳ The device displays the current settings for the following parameters one after another for the user to confirm each of them:

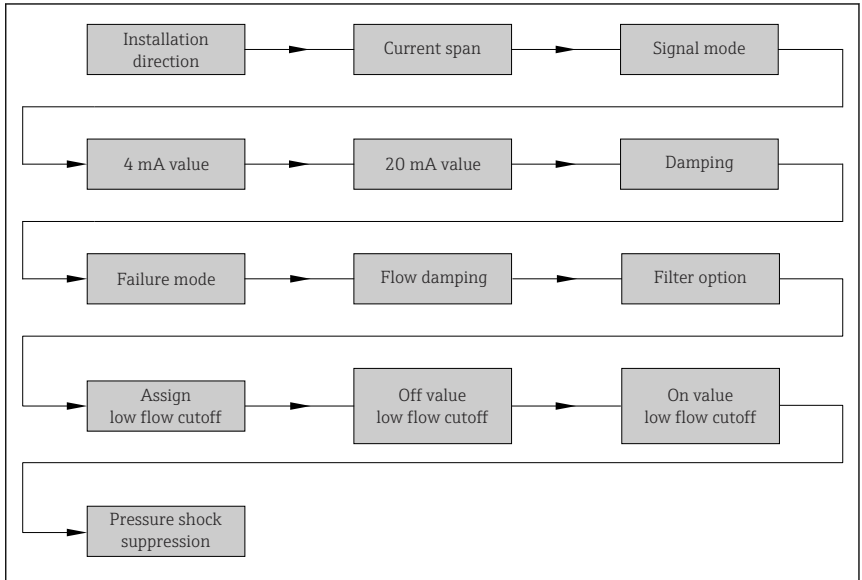

A0031492-EN



For detailed information on the parameters in the graphic, see the Operating Instructions.

6. At the end of the verification, the SIL locking code **7452** must be entered in the **Set write protection** parameter again to confirm that all the parameter values have been defined correctly.

- ↳ If the SIL locking code has been entered correctly, the message "**End of sequence**" appears on the display.

7. Press the  key to confirm.

The SIL mode is now activated.

Recommendation:

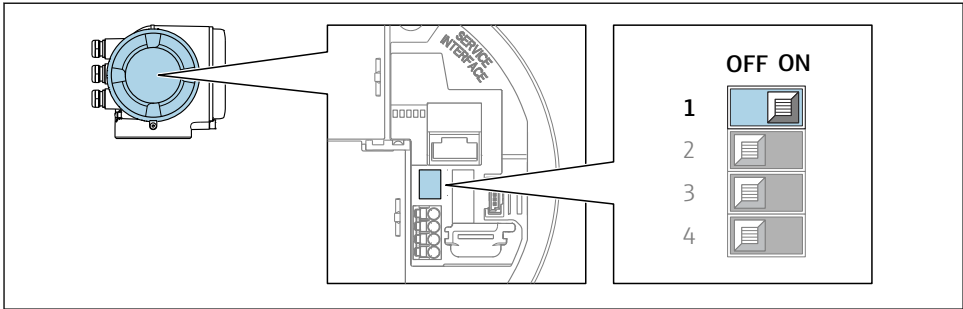

A0029630

1. Check the write protection switch (WP) in the connection compartment.
2. Set this switch to the **ON** position where necessary.
 - ↳ Hardware write protection enabled.
3. Restart the device on completion of the SIL confirmation sequence.

NOTICE

If the SIL confirmation sequence is aborted before the "End of sequence" message is displayed, the SIL device is not locked. The safety-oriented parameter settings have been made but the SIL device has not been locked.

- ▶ Perform SIL device locking again.

5.5.4 Unlocking a SIL device

A device in the locked SIL mode is protected against unauthorized operation by means of a SIL locking code and, where applicable, by means of a user-specific release code and a hardware write protection switch. The device must be unlocked in order to change parameters, for proof-tests as well as to reset self-holding diagnostic messages.

NOTICE

Unlocking the device deactivates diagnostic functions, and the device may not be able to carry out its safety function in the unlocked SIL mode.

- ▶ Therefore, independent measures must be taken to ensure that there is no risk of danger while the SIL device is unlocked.

Unlocking procedure:

1. Check the write protection switch (WP) in the connection compartment.
2. Set this switch to the **OFF** position where necessary.
 - ↳ Hardware write protection disabled.
3. Enter the user-specific release code if necessary.
4. In the **Setup** menu → **Advanced setup** submenu, select the **Deactivate SIL** wizard.
5. Select **Reset write protection** parameter.

6. Enter the SIL locking code **7452**.

- ↳ If the SIL locking code has been entered correctly, the message **"End of sequence"** appears on the display.

7. Press the  key to confirm.

The SIL mode is now deactivated.

6 Operation

6.1 Device behavior during power-up

Once switched on, the device runs through a start-up phase. The current output is set to failure current during this time. This current is ≤ 3.6 mA in the initial seconds of this start-up phase.

After that, depending on the setting of the "Start-up mode" parameter, the current is:

- At the value MIN: ≤ 3.6 mA
- At the value MAX: ≥ 21 mA

No communication with the device is possible via the interfaces during the start-up phase. After the start-up phase the device switches to the normal mode (measuring operation).

6.2 Device behavior in safety function demand mode

The device outputs a current value corresponding to the limit value to be monitored. This value must be monitored and processed further in a connected logic unit.

6.3 Safe states

The system adopts one of the three states depending on the error detected:

- Application error
Application errors are detected by the device and a fixed failure current is output. The device can continue communicating via HART (device state: "temporarily safe"). This state persists until the application error is resolved and the device can again supply a valid measured value at the current output. All parameters can be read.
Example: A cable open circuit is detected in the sensor.
- Safe state / output current:
 - $I \leq 3.6$ mA (low alarm)
 - $I \geq 21$ mA (high alarm)

6.4 Device behavior in event of alarms and warnings

The output current on alarm can be set to a value ≤ 3.6 mA or ≥ 21 mA.

In some cases (e.g. a cable open circuit or faults in the current output itself, where it is not possible to set the failure current ≥ 21 mA) output currents of ≤ 3.6 mA occur irrespective of the configured failure current.

In some other cases (e.g. short circuit of cabling), output currents of ≥ 21 mA occur irrespective of the configured failure current.

For alarm monitoring, the downstream automation system must be able to recognize both maximum alarms (≥ 21 mA) and minimum alarms (≤ 3.6 mA).

6.5 Alarm and warning messages

Additional information is provided by the alarm and warning messages output in the form of diagnostic events and associated event texts.

NOTICE

A diagnostic message is displayed even though the diagnostic event is no longer active in the unlocked SIL mode.

When SIL mode is activated, additional diagnostics are activated. If a diagnostic event is pending and the locked SIL mode is deactivated, the diagnostic message remains as long as the error is still present.

- ▶ In this case, the device must be disconnected briefly from the power supply .
- ▶ When the device is then restarted, a self-check is carried out, and the diagnostics event is reset where applicable.

This behavior occurs in the event of the following diagnostic message:

803 Current loop diagnostic message

 After a period of 20 to 30 s, the diagnostic message changes from **803 Current loop** diagnostic message to **F375 I/O- 1 to n communication failed** diagnostic message. If a check run in the device's event logbook confirms the previous **803 Current loop** diagnostic message diagnostic message, the installation must be checked for a cable break.

7 Proof testing

 The functional integrity of the device in the SIL mode must be verified during commissioning, when changes are made to safety-related parameters, and also at appropriate time intervals. The time intervals must be specified by the operator.

CAUTION

The safety function is not guaranteed during a proof test.

Suitable measures must be taken to guarantee process safety during the test.

- ▶ The safety-related output signal 4 to 20 mA must not be used for the protective system during the test.
- ▶ Any test that is performed must be documented; the template in the appendix can be used for this purpose →  47.
- ▶ The operator specifies the testing interval and this must be taken into account when determining the probability of failure PFD_{avg} of the sensor system.

If no operator-specific proof testing requirements have been defined, the following is a possible alternative for testing the transmitter depending on the measured variable used for

the safety function. The individual proof test coverages (PTC) that can be used for calculation are specified for the test sequences described below.



Flexible testing of field devices

NAMUR Worksheet NA106 "Flexible proof testing of field devices in safety instrumented systems" explains how to optimize testing activities on existing installations. Heartbeat Verification enables the documentation of the current device diagnostic or device status as proof of testing. This supports the documentation of proof tests according to IEC 61511-1, Section 16.3.3, "Documentation of proof tests and inspections". The Heartbeat Technology developed by Endress+Hauser can be used to implement the "Flexible testing" test strategy of field devices under NA106.



Heartbeat Verification is not a substitute for a proof test. Test sequences with Heartbeat Verification can contribute to the detection of systematic errors within the context of proof testing. In this case, Heartbeat Verification is one step in the proof test sequence.

Device verification (Heartbeat Verification) is based on device-specific test sequences that are performed automatically. Heartbeat Verification also enables the detection of systematic errors in the sensor system (e.g. formation of buildup in the sensor).

Heartbeat Verification is based on device-specific test sequences that are performed automatically. Formation of buildup in the sensor. Heartbeat Technology is a methodological design concept based on IEC 61508 consisting of the Heartbeat Diagnostic, Verification and Monitoring modules

For more information on Heartbeat Technology, see the associated documentation in the Operating Instructions.

Proof-testing of the device can be performed as follows:

- Test sequence A: Testing with a secondary standard 1 (volume flow) and current output 1 → PTC = 99 %
- Test sequence C: Testing with a secondary standard 1 (volume flow) → PTC = 98 %
- Test sequence D: Device restart, testing of output 1, Heartbeat Verification → PTC = 36 % + systematic errors
- Test sequence E: Device restart, Heartbeat Verification → PTC = 19 % + systematic errors
- Test sequence F: Heartbeat Verification → PTC = 0 % + systematic errors

Note the following for the test sequences:

- The individual proof test coverages (PTC) that can be used for calculation are specified in the Declaration of Conformity.
- Test sequence C is not permitted for a commissioning test.
- The transmitter can be tested without a sensor using an appropriate sensor simulator (resistance decade, reference voltage source, etc.).
- The accuracy of the measuring device used must meet the transmitter specifications.
- A three-point calibration must be performed when customized linearization (e.g. with CvD coefficients) is used. The **upper sensor limit** and the **lower sensor limit** must also be checked.

Proof testing and optimization of subsystems

NAMUR Worksheet NA106 "Flexible proof testing of field devices in safety instrumented systems" explains how to optimize testing activities in safety instrumented systems with

regard to interrupting operation while maintaining the necessary safety integrity of the installed safety instrumented systems.

The Heartbeat Technology developed by Endress+Hauser can be used to implement the "Flexible testing" test strategy of field devices under NA106 .

Device verification (Heartbeat Verification) enables the documentation of the current device diagnostic or the device status as proof of testing. This supports the documentation of proof tests according to IEC 61511-1, Section 16.3.3, "Documentation of proof tests and inspections". Device verification (Heartbeat Verification) is based on device-specific test sequences that are performed automatically. The verification also enables the detection of systematic errors in the sensor system (e.g. formation of buildup in the sensor).

7.1 Test sequence A (PTC = 99 %)

- Testing with a secondary standard (volume flow)
- Testing of current output 1
- Inspection and on-site visual check

Preparation

Byassing of safety function of process control system, to prevent accidental activation of the safety function.

- ▶ Deactivate the locked SIL mode →  28.

7.1.1 Test sequence: Testing with a secondary standard (volume flow)

The measured values (3 to 5 measuring points) are checked with a secondary standard on an installed device (mobile calibration rig or calibrated reference device) or on a factory calibration rig following device removal.

The measured values of the secondary standard and the device under test (DUT) are compared using one of the following methods:

Comparison by reading off the digital measured value

- ▶ Compare the digital measured value of the secondary standard against the measured value display of the DUT at the logic subsystem (process control system or safety-related PLC).

Comparison of the measured value by measuring the current

Requirements for the measuring equipment:

- DC current measuring uncertainty $\pm 0.2\%$
- DC current resolution $10\ \mu\text{A}$

1. Measure the current at the DUT using an external, traceably-calibrated ammeter.
2. Measure the current of the DUT at the logic subsystem (process control system or safety-related PLC).

Evaluation of results: Testing with a secondary standard (volume flow)

The amount of deviation between the measured flow rate and the set point must not exceed the measured error specified for the safety function.



For information on the required measured error for the device, see the "Performance characteristics" section of the Operating Instructions

- ▶ Follow the information in the section on "Restrictions for use in safety-related applications, information on measured errors" →  17.

7.1.2 Test sequence: Testing of current output 1

The **Simulation** submenu (Diagnostics → Simulation) enables you to simulate, without a real flow situation, various process variables in the process and the device alarm mode and to verify downstream signal chains (switching valves or closed-control loops).

Performing the test

 For proof testing, use only the **Current output simulation** parameter (→  34) and the **Value current output** parameter (→  34), as these are the only parameters approved for testing the safety-related characteristics.

1. In the **Value current output** parameter, select the defined default values one after the other.
2. Compare current at output 1 with this default value.

Comparing the current values

The current values can be compared using one of the following methods:

- Measure the current of the DUT at the logic subsystem (process control system or safety-related PLC).
 - Measure the current at the DUT using an external, traceably-calibrated ammeter.
- ▶ Compare the current values.

Connecting the measuring equipment and external testing

- Connecting the measuring equipment in the measuring circuit
- External check of the passive current output

 Requirements for the measuring equipment:

- DC current measuring uncertainty $\pm 0.2\%$
- DC current resolution $10\ \mu\text{A}$

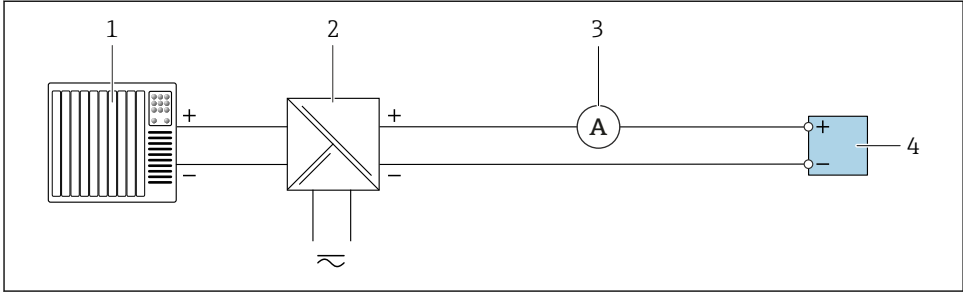

A0034446

2 External verification taking the example of a passive current output

- 1 Automation system with current input (e.. g. PLC)
- 2 Power supply unit
- 3 Ammeter
- 4 Transmitter

1. Connect the ammeter to the transmitter by looping it in series into the circuit.
2. Connect the power supply unit.

Evaluation of results: Testing of current output 1

The amount of deviation between the measured current and the set point must not exceed the measured error specified for the safety function. The deviation should not exceed $\pm 1\%$ / $\pm 300 \mu\text{A}$.

- ▶ Follow the information in the section on "Restrictions for use in safety-related applications, information on measured errors" → 17.

Parameter overview with brief description

Parameter	Prerequisite	Description	Selection / User entry	Factory setting
Current output 1 to n simulation	-	Switch the simulation of the current output on and off.	On	Off
Current output value	In the Current output 1 to n simulation parameter, the On option is selected.	Enter the current value for simulation.	<ul style="list-style-type: none"> ▪ 1. Default value: Select 4.0 mA. ▪ 2. Default value: Select 20.0 mA. 3.59 to 22.5 mA	3.59 mA

7.1.3 Test sequence: Inspection and on-site visual check

At the transmitter, check the correct sealing function of all the electronics compartment cover seals and cable entries.

7.1.4 Connecting the test

1. Re-activate the locked SIL mode →  21.
2. Deactivate bypassing of safety function of process control system.
3. Document results of proof test in accordance with the safety management guidelines applicable to the system.

NOTICE

At least 99 % of dangerous, undetected failures can be detected using the test sequences described (PTC = 0.99). The influence of systematic errors on the safety function is not fully covered by the test. Systematic errors can be caused, for example, by medium properties, operating conditions or buildup.

- ▶ If one of the test criteria from the test sequences described above is not fulfilled, the device may no longer be used as part of a protective system.
- ▶ Take measures to reduce systematic errors. For detailed information on the orientation, medium properties and operating conditions, see the "Operating Instructions" →  10

7.2 Test sequence C (PTC = 98 %)

- Testing with a secondary standard (volume flow)
- Inspection and on-site visual check

Preparation

Byassing of safety function of process control system, to prevent accidental activation of the safety function.

- ▶ Deactivate the locked SIL mode →  28.

7.2.1 Test sequence: Testing with a secondary standard (volume flow)

Testing with a secondary standard (volume flow) Verification of the measured value for liquid and gaseous volume flow by comparing with a secondary standard.

The measured values (3 to 5 measuring points) are checked with a secondary standard on an installed device (mobile calibration rig or calibrated reference device) or on a factory calibration rig following device removal.

The measured values of the secondary standard and the device under test (DUT) are compared using one of the following methods:

Comparison by reading off the digital measured value

- ▶ Compare the digital measured value of the secondary standard against the measured value display of the DUT at the logic subsystem (process control system or safety-related PLC).

Comparison of the measured value by measuring the current

Requirements for the measuring equipment:

- DC current measuring uncertainty $\pm 0.2\%$
- DC current resolution $10\ \mu\text{A}$

1. Measure the current at the DUT using an external, traceably-calibrated ammeter.

2. Measure the current of the DUT at the logic subsystem (process control system or safety-related PLC).

Evaluation of results: Testing with a secondary standard (volume flow)

The amount of deviation between the measured flow rate and the set point must not exceed the measured error specified for the safety function.

For information on the required measured error for the device, see the "Performance characteristics" section of the Operating Instructions

- ▶ Follow the information in the section on "Restrictions for use in safety-related applications, information on measured errors" →  17.

7.2.2 Test sequence: Inspection and on-site visual check

At the transmitter, check the correct sealing function of all the electronics compartment cover seals and cable entries.

7.2.3 Connecting the test

NOTICE

At least 98 % of dangerous, undetected failures can be detected using the test sequences described (PTC = 0.98). The influence of systematic errors on the safety function is not fully covered by the test. Systematic errors can be caused, for example, by medium properties, operating conditions or buildup.

- ▶ If one of the test criteria from the test sequences described above is not fulfilled, the device may no longer be used as part of a protective system.
- ▶ Take measures to reduce systematic errors. For detailed information on the orientation, medium properties and operating conditions, see the "Operating Instructions" →  10

7.3 Test sequence D (PTC = 36 %)

- Device restart
- Testing of current output 1
- Heartbeat verification
- Inspection and on-site visual check

Detection of additional systematic errors with Heartbeat Verification: influence of the process on the device (e.g. formation of buildup in the sensor).

Preparation

Byassing of safety function of process control system, to prevent accidental activation of the safety function.

- ▶ Deactivate the locked SIL mode →  28.

7.3.1 Test sequence: Device restart

The device restart resets every parameter whose data are in the volatile memory (RAM) to the factory setting (e.g. measured value data). The device configuration remains unchanged.

The device can be restarted using one of the following methods:

- Disconnecting and reconnecting the terminal voltage.
- In the **Device reset** parameter, select the **Restart device** option.
Setup → Advanced setup → Administration
- ▶ Restart the device.

NOTICE

Wrong option selected in the "Reset device" parameter.

If the "To factory defaults" or "To delivery settings" option is selected, the device configuration is reset and the device must be reconfigured!

- ▶ In the **Device reset** parameter, select only the **Restart device** option.



Evaluation of results: Device restart

- ▶ Test restart of device.
 - ↳ After a successful startup, the local display switches automatically from the startup display to the operational display. If the device restarts and no diagnostic message is displayed, this step has been completed successfully.
If nothing appears on the local display or a diagnostic message is displayed, refer to the "Diagnostics and troubleshooting" section of the "Operating Instructions" →  10

7.3.2 Test sequence: Testing of current output 1

The **Simulation** submenu (Diagnostics → Simulation) enables you to simulate, without a real flow situation, various process variables in the process and the device alarm mode and to verify downstream signal chains (switching valves or closed-control loops).

Performing the test

 For proof testing, use only the **Current output simulation** parameter (→  34) and the **Value current output** parameter (→  34), as these are the only parameters approved for testing the safety-related characteristics.

1. In the **Value current output** parameter, select the defined default values one after the other.
2. Compare current at output 1 with this default value.

Comparing the current values

The current values can be compared using one of the following methods:

- Measure the current of the DUT at the logic subsystem (process control system or safety-related PLC).
- Measure the current at the DUT using an external, traceably-calibrated ammeter.
- ▶ Compare the current values.

Connecting the measuring equipment and external testing

- Connecting the measuring equipment in the measuring circuit
- External check of the passive current output

i Requirements for the measuring equipment:

- DC current measuring uncertainty $\pm 0.2\%$
- DC current resolution $10\ \mu\text{A}$

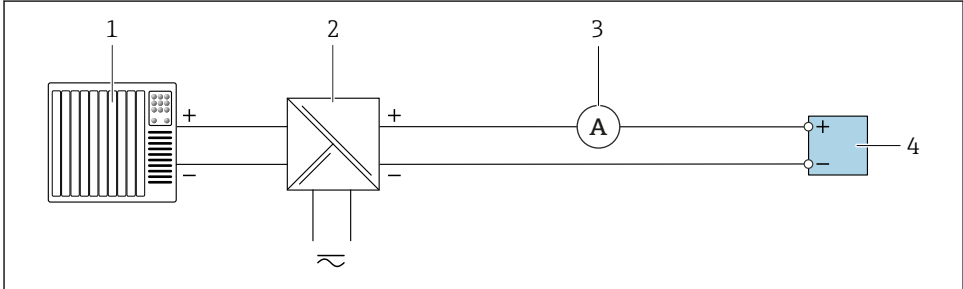

A0034446

3 External verification taking the example of a passive current output

- 1 Automation system with current input (e. g. PLC)
- 2 Power supply unit
- 3 Ammeter
- 4 Transmitter

1. Connect the ammeter to the transmitter by looping it in series into the circuit.
2. Connect the power supply unit.

Evaluation of results: Testing of current output 1

The amount of deviation between the measured current and the set point must not exceed the measured error specified for the safety function. The deviation should not exceed $\pm 1\%$ / $\pm 300\ \mu\text{A}$.

- ▶ Follow the information in the section on "Restrictions for use in safety-related applications, information on measured errors" → 17.

Parameter overview with brief description

Parameter	Prerequisite	Description	Selection / User entry	Factory setting
Current output 1 to n simulation	–	Switch the simulation of the current output on and off.	On	Off
Current output value	In the Current output 1 to n simulation parameter, the On option is selected.	Enter the current value for simulation.	<ul style="list-style-type: none"> ▪ 1. Default value: Select 4.0 mA. ▪ 2. Default value: Select 20.0 mA. 3.59 to 22.5 mA	3.59 mA

7.3.3 Test sequence: Heartbeat Verification

1. Select Heartbeat Verification (standard).
2. Initiate Heartbeat Verification.
3. Verification is performed automatically in the device: see the "Standard verification" section of the "Special Documentation for Heartbeat Technology".

Acceptance criteria: External Heartbeat Verification

1. Check whether the result of the verification is **Passed** or **Failed**.
 - ↳ The check is completed successfully if the result of the Heartbeat Verification is **Passed**.
2. To document the test, print the verification report. Device diagnostics or device status as proof of testing.



The following systematic errors can be detected:
Buildup in the sensor pipes

7.3.4 Test sequence: Inspection and on-site visual check

At the transmitter, check the correct sealing function of all the electronics compartment cover seals and cable entries.

7.3.5 Connecting the test

1. Re-activate the locked SIL mode → 21.
2. Deactivate bypassing of safety function of process control system.
3. Document results of proof test in accordance with the safety management guidelines applicable to the system.

NOTICE

At least 52 % of dangerous, undetected failures can be detected using the test sequences described (PTC = 0.52). The influence of systematic errors on the safety function is not fully covered by the test. Systematic errors can be caused, for example, by medium properties, operating conditions or buildup.

- ▶ If one of the test criteria from the test sequences described above is not fulfilled, the device may no longer be used as part of a protective system.
- ▶ Take measures to reduce systematic errors. For detailed information on the orientation, medium properties and operating conditions, see the "Operating Instructions" →  10

7.4 Test sequence E (PTC = 19 %)

- Device restart
- Heartbeat Verification
- Inspection and on-site visual check

Detection of additional systematic errors with Heartbeat Verification: influence of the process on the device (e.g. formation of buildup in the sensor).

Preparation

Bypassing of safety function of process control system, to prevent accidental activation of the safety function.

- ▶ Deactivate the locked SIL mode →  28.

7.4.1 Test sequence: Device restart

The device restart resets every parameter whose data are in the volatile memory (RAM) to the factory setting (e.g. measured value data). The device configuration remains unchanged.

The device can be restarted using one of the following methods:

- Disconnecting and reconnecting the terminal voltage.
- In the **Device reset** parameter, select the **Restart device** option.
Setup → Advanced setup → Administration
- ▶ Restart the device.

NOTICE

Wrong option selected in the "Reset device" parameter.

If the "To factory defaults" or "To delivery settings" option is selected, the device configuration is reset and the device must be reconfigured!

- ▶ In the **Device reset** parameter, select only the **Restart device** option.

Evaluation of results: Device restart

- ▶ Test restart of device.
 - ↳ After a successful startup, the local display switches automatically from the startup display to the operational display. If the device restarts and no diagnostic message is displayed, this step has been completed successfully.
 - If nothing appears on the local display or a diagnostic message is displayed, refer to the "Diagnostics and troubleshooting" section of the "Operating Instructions" →  10

7.4.2 Test sequence: Heartbeat Verification

1. Select Heartbeat Verification (standard).
2. Initiate Heartbeat Verification.
3. Verification is performed automatically in the device: see the "Standard verification" section of the "Special Documentation for Heartbeat Technology".

Acceptance criteria: External Heartbeat Verification

1. Check whether the result of the verification is **Passed** or **Failed**.
 - ↳ The check is completed successfully if the result of the Heartbeat Verification is **Passed**.
2. To document the test, print the verification report. Device diagnostics or device status as proof of testing.



The following systematic errors can be detected:
Buildup in the sensor pipes

7.4.3 Test sequence: Inspection and on-site visual check

At the transmitter, check the correct sealing function of all the electronics compartment cover seals and cable entries.

7.4.4 Connecting the test

1. Re-activate the locked SIL mode → 21.
2. Deactivate bypassing of safety function of process control system.
3. Document results of proof test in accordance with the safety management guidelines applicable to the system.

NOTICE

With the test sequences described, at least 19 % of the dangerous undetected failures can be detected (PTC = 0.19). The influence of systematic errors on the safety function is not fully covered by the test. Systematic errors can be caused, for example, by medium properties, operating conditions or buildup.

- ▶ If one of the test criteria from the test sequences described above is not fulfilled, the device may no longer be used as part of a protective system.
- ▶ Take measures to reduce systematic errors. For detailed information on the orientation, medium properties and operating conditions, see the "Operating Instructions" → 10

7.5 Test sequence F (PTC = 0 %)

- Heartbeat Verification
- Inspection and on-site visual check

Detection of additional systematic errors with Heartbeat Verification: influence of the process on the device (e.g. formation of buildup in the sensor).

Preparation

Bypassing of safety function of process control system, to prevent accidental activation of the safety function.

- ▶ Deactivate the locked SIL mode →  28.

7.5.1 Test sequence: Heartbeat Verification

1. Select Heartbeat Verification (standard).
2. Initiate Heartbeat Verification.
3. Verification is performed automatically in the device: see the "Standard verification" section of the "Special Documentation for Heartbeat Technology".

Acceptance criteria: External Heartbeat Verification

1. Check whether the result of the verification is **Passed** or **Failed**.
 - ↳ The check is completed successfully if the result of the Heartbeat Verification is **Passed**.
2. To document the test, print the verification report. Device diagnostics or device status as proof of testing.



The following systematic errors can be detected:
Buildup in the sensor pipes

7.5.2 Test sequence: Inspection and on-site visual check

At the transmitter, check the correct sealing function of all the electronics compartment cover seals and cable entries.

7.5.3 Connecting the test

1. Re-activate the locked SIL mode →  21.
2. Deactivate bypassing of safety function of process control system.
3. Document results of proof test in accordance with the safety management guidelines applicable to the system.

NOTICE

No dangerous, undetected failures can be detected using the test sequences described (PTC = 0). The influence of systematic errors on the safety function is not fully covered by the test. Systematic errors can be caused, for example, by medium properties, operating conditions or buildup.

- ▶ If one of the test criteria from the test sequences described above is not fulfilled, the device may no longer be used as part of a protective system.
- ▶ Take measures to reduce systematic errors. For detailed information on the orientation, medium properties and operating conditions, see the "Operating Instructions" →  10

7.6 Verification criterion

If one of the test criteria from the test sequences described above is not satisfied, the device may no longer be used as part of a safety instrumented system.

- The purpose of proof-testing is to detect dangerous undetected device failures (λ_{du}).
- The impact of systematic errors on the safety function is partially covered by this test and must be assessed separately.
- Systematic errors can be caused, for example, by substance properties, operating conditions or buildup.
- As part of the visual inspection, for example, ensure that all of the seals and cable entries provide adequate sealing.

8 Repair and error handling

8.1 Maintenance



For detailed information on maintenance, see the Operating Instructions.



Alternative monitoring measures must be taken to ensure process safety during configuration, proof-testing and maintenance work on the device.

8.2 Repair



Repair means restoring functional integrity by replacing defective components.

Only original Endress+Hauser spare parts may be used for this purpose.

We recommend that you document the repair. This includes documenting the:

- Serial number of the device
- Date of the repair
- Type of repair
- Person who performed the repair

Components may be repaired/replaced by the customer's technical staff if original Endress+Hauser spare parts are used (they can be ordered by the end user), and if the relevant installation instructions are followed.



For detailed information on returns, see the Operating Instructions.

8.2.1 Replacing device components

The following components may be replaced by the customer's technical staff if genuine spare parts are used and the appropriate installation instructions are followed:

- Sensor
- Transmitter without a sensor
- Display module
- Power unit
- Main electronics module

- Sensor electronics module (ISEM)
- I/O modules
- Terminals
- Connection compartment cover
- Electronics compartment cover
- Seal sets for electronics compartment cover
- Securing clamps for electronics compartment cover
- Cable glands

Installation Instructions: see the Download Area under www.endress.com.

The replaced component must be sent to Endress+Hauser for the purpose of fault analysis if the device has been operated in a protective system and a device error cannot be ruled out. In this case, always enclose the "Declaration of Hazardous Material and Decontamination" with the note "Used as SIL device in protection system" when returning the defective device. Please refer to the "Return" section in the Operating Instructions .

8.3 Modification

Modifications are changes to devices with SIL capability already delivered or installed.

- ▶ Modifications to devices with SIL capability are usually performed in the Endress+Hauser manufacturing center.
- ▶ Modifications to devices with SIL capability onsite at the user's plant are possible following approval by the Endress+Hauser manufacturing center. In this case, the modifications must be performed and documented by an Endress+Hauser service technician.
- ▶ Modifications to devices with SIL capability by the user are not permitted.

8.4 Taking out of service

The requirements of IEC 61508-1:2010 Section 7.17 must be observed when taking the device out of service.

8.5 Disposal

 For detailed information on the device disposal, see the Operating Instructions

9 Appendix

9.1 Structure of the measuring system

9.1.1 System components

An example of the devices in the measuring system is shown in the following graphic.

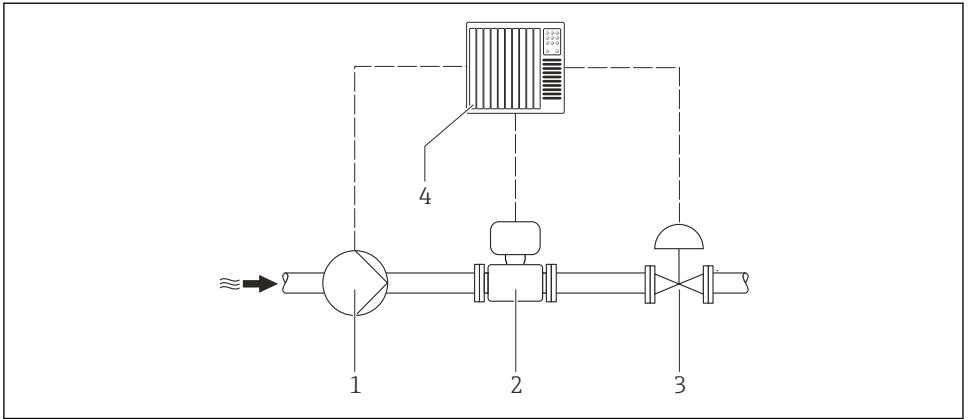

A0015443

4 System components

- 1 Pump
- 2 Measuring device
- 3 Valve
- 4 Automation system

An analog signal (4–20 mA) proportional to the volume flow is generated in the transmitter. This is sent to a downstream automation system where it is monitored to determine whether it falls below or exceeds a specified limit value. The safety function (volume flow monitoring) is implemented in this way.

For fault monitoring, the logic unit must recognize both HI alarms (≥ 21 mA) and LO alarms (≤ 3.6 mA).

9.1.2 Description of use of protective system

The measuring device can be used in protective systems to monitor the following (Min., Max. and range):

Volume flow

NOTICE

The device must be correctly mounted to guarantee safe operation.

► Observe the mounting instructions.



For detailed information on mounting, see the Operating Instructions

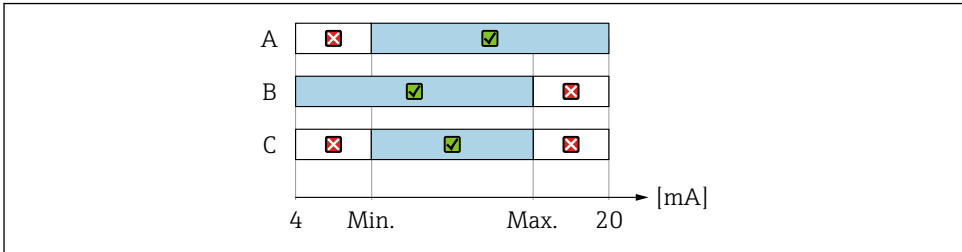

A0015277

5 Monitoring options in protective systems

A Min. alarm

B Max. alarm

C Range monitoring

✗ = Safety function is triggered

✓ = Permitted operating status

9.2 Commissioning or proof test report

9.2.1 Test report – Page 1

Prüfprotokoll – Seite 1		
Geräteinformation		
Anlage		
Messstellen / TAG-Nr.		
Seriennummer		
Informationen zur Prüfung		
Datum / Uhrzeit		
Durchgeführt von:		
Prüfablauf	PTC	
Prüfungsergebnis		
Bestanden:	Nicht bestanden	
Bemerkungen		
Firma / Ansprechpartner:		
Ausführender:		
Datum	Unterschrift	Unterschrift Ausführender

A0049162

9.2.2 Test report – Page 2

Prüfprotokoll – Seite 2

Geräteinformation
Anlage
Messstellen / TAG-Nr.
Seriennummer
Informationen zur Prüfung
Datum / Uhrzeit

Sicherheitsfunktion - Grenzwertüberwachung	
<input type="checkbox"/> Min	<input type="checkbox"/> Max

Teil Prüfabläufe	Soll	Ist	Teil-Ergebnis	
			<input checked="" type="checkbox"/>	<input checked="" type="checkbox"/>

A0049163

9.2.3 Parameter settings for the SIL mode

Parameter-Einstellungen für den SIL-Mode

Parametername	Werkseinstellung	Eingestellter Wert	Geprüft
Freigabecode eingeben	0		
Anfang Messbereich (4mA)	0		
Sensortyp			
Druckkompensation	= Aus		
Zuordnung Stromausgang 1	= Massefluss		
Strombereich	= 4...20 mA		
Fehlerverhalten	= Min.		
Schleichenmengenunterdrückung	= Aus		
Überwachung teilgefülltes Rohr	= Aus		
Messmodus (4 mA-Wert)*	= Förderricht.		
Ansprechzeit teilgefülltes Rohr*	= 0		
Zuordnung Simul. Prozessgr.*	= Aus		
Simulation Stromausgang 1*	= Aus		
Diagnosenr. 046; 140; 274; 374; 830; 831; 834; 835; 913*	= Alarm		

* Das Gerät schaltet nach Erfüllung der Vorbedingungen selbsttätig diese Parameter auf sicherheitsgerichtete Einstellungen.

A0049164

9.3 Verification or calibration

The SIL mode must be disabled in order to verify the measuring point with Heartbeat Technology or calibrate the measuring point.

NOTICE

To use the device in a safety function again following a verification or calibration, the configuration of the measuring point must be checked and the SIL mode must be enabled again.

► Activation of the SIL mode →  21.

9.4 Version history

Version	Changes	Valid as of firmware version
SD01740D/06/xx/07.22	Changes: Operating Instructions for the device	01.06.zz (HART; from delivery date August 2, 2022)
SD01740D/06/xx/06.20	Addition, Device Model A1/A2 & option CC (4 to 20mA HART Ex-i active)	01.05.zz (HART; from delivery date September 16, 2019)

Version	Changes	Valid as of firmware version
SD01740D/06/xx/02.17	Changes: Operating Instructions for the device	01.01.zz (HART; from delivery date October 1, 2017)
SD01740D/06/xx/01.16	First version	01.00.zz (HART; from delivery date August 2, 201)



71576941

www.addresses.endress.com
