

# Brief Operating Instructions

## **Rxn-20 Raman spectroscopic probe**





# Table of Contents

<b>1</b>	<b>About this document.....</b>	<b>4</b>
1.1	Disclaimer .....	4
1.2	Warnings .....	4
1.3	Symbols .....	5
1.4	U.S. export compliance.....	5
<b>2</b>	<b>Basic safety instruction.....</b>	<b>6</b>
2.1	Requirements for personnel.....	6
2.2	Designated use .....	6
2.3	Workplace safety.....	6
2.4	Operational safety.....	7
2.5	Laser safety.....	7
2.6	Service safety.....	8
2.7	Important safeguards.....	8
2.8	Product safety.....	8
<b>3</b>	<b>Product description .....</b>	<b>10</b>
3.1	The Rxn-20 probe.....	10
3.2	Raman Rxn-20 probe accessories .....	11
<b>4</b>	<b>Incoming product acceptance and product identification .....</b>	<b>12</b>
4.1	Incoming acceptance.....	12
4.2	Product identification .....	12
4.3	Scope of delivery.....	13
<b>5</b>	<b>Probe and fiber optic connection .....</b>	<b>14</b>
<b>6</b>	<b>Installation .....</b>	<b>15</b>
6.1	Hazardous area installation .....	16
6.2	Process and probe compatibility .....	17
<b>7</b>	<b>Commissioning.....</b>	<b>18</b>
7.1	Receipt of probe.....	18
7.2	Probe calibration and verification.....	18
<b>8</b>	<b>Operation.....</b>	<b>19</b>
8.1	Silica Raman removal.....	19
8.2	Focusing excitation radiation .....	19
<b>9</b>	<b>Diagnostics and troubleshooting.....</b>	<b>20</b>

# 1 About this document

## 1.1 Disclaimer

These instructions are Brief Operating Instructions; they do not replace the Operating Instructions included in the scope of supply.

## 1.2 Warnings



Structure of Information	Meaning
<p> <b>WARNING</b></p> <p><b>Causes (/consequences)</b> If necessary, consequences of non-compliance (if applicable)</p> <p>▶ Corrective action</p>	<p>This symbol alerts you to a dangerous situation. Failure to avoid the dangerous situation can result in a fatal or serious injury.</p>
<p> <b>CAUTION</b></p> <p><b>Causes (/consequences)</b> If necessary, consequences of non-compliance (if applicable)</p> <p>▶ Corrective action</p>	<p>This symbol alerts you to a dangerous situation. Failure to avoid this situation can result in minor or more serious injuries.</p>
<p><b>NOTICE</b></p> <p><b>Cause/situation</b> If necessary, consequences of non-compliance (if applicable)</p> <p>▶ Action/note</p>	<p>This symbol alerts you to situations which may result in damage to property.</p>

Table 1. Warnings

## 1.3 Symbols





Symbol	Description
	The Laser Radiation symbol is used to alert the user to the danger of exposure to hazardous visible laser radiation when using the Raman Rxn system.
	The High Voltage symbol that alerts people to the presence of electric potential large enough to cause injury or damage. In certain industries, high voltage refers to voltage above a certain threshold. Equipment and conductors that carry high voltage warrant special safety requirements and procedures.
	The CSA Certification Mark indicates that the product was tested against and met the applicable North American standards requirements.
	The WEEE symbol indicates that the product should not be discarded as unsorted waste but must be sent to separate collection facilities for recovery and recycling.
	The CE Marking indicates conformity with health, safety, and environmental protection standards for products sold within the European Economic Area (EEA).

Table 2. Symbols

## 1.4 U.S. export compliance

The policy of Endress+Hauser is strict compliance with U.S. export control laws as detailed in the website of the [Bureau of Industry and Security](#) at the U.S. Department of Commerce.

## 2 Basic safety instruction

### 2.1 Requirements for personnel

- Installation, commissioning, operation, and maintenance of the measuring system may be carried out only by specially trained technical personnel.
- The technical personnel must be authorized by the plant operator to carry out the specified activities.
- The technical personnel must have read and understood these Operating Instructions and must follow the instructions contained herein.
- The facility must designate a laser safety officer who ensures staff are trained on all Class 3B laser operating and safety procedures.
- Faults at the measuring point may only be rectified by properly authorized and trained personnel. Repairs not described in this document must be carried out only directly at the manufacturer's site or by the service organization.

### 2.2 Designated use

The Rxn-20 Raman spectroscopic probe is intended for the measurement of solids and semi-solids in a laboratory or process development or manufacturing setting.

Recommended applications include:

- **Polymers:** extruded pellet quality, crystallinity, density, raw materials
- **Pharmaceutical:** crystallinity, polymorphism, granulation, blend uniformity, content uniformity, coating, tableting
- **Chemicals:** final product quality, blend impurities, crystallinity, raw materials
- **Food and beverage:** quality of dairy solids, and meat and fish composition

Use of the device for any purpose other than that described, poses a threat to the safety of people and of the entire measuring system and invalidates any warranty.

### 2.3 Workplace safety

As the user, you are responsible for complying with the following safety conditions:

- Installation guidelines
- Local standards and regulations for electromagnetic compatibility

The product has been tested for electromagnetic compatibility in accordance with the applicable international standards for industrial applications.

The electromagnetic compatibility indicated applies only to a product that has been properly connected to the analyzer.

## 2.4 Operational safety

Before commissioning the entire measuring point:

1. Verify that all connections are correct.
2. Ensure that electro-optical cables are undamaged.
3. Do not operate damaged products, and protect them against unintentional operation.
4. Label damaged products as defective.

During operation:

1. If faults cannot be rectified, products must be taken out of service and protected against unintentional operation.
2. When working with laser devices, always follow all local laser safety protocols which may include the use of personal protective equipment and limiting device access to authorized users.

## 2.5 Laser safety

The Raman Rxn analyzers use Class 3B lasers as defined in the following:

- [American National Standards Institute](#) (ANSI) Z136.1, American National Standard for Safe Use of Lasers
- [International Electrotechnical Commission](#) (IEC) 60825-1, Safety of Laser Products – Part 1

### WARNING

#### Laser radiation

- ▶ Avoid exposure to beam
- ▶ Class 3B laser product

### CAUTION

#### Laser beams can cause ignition of certain substances such as volatile organic compounds.

The two possible mechanisms for ignition are direct heating of the sample to a point causing ignition and the heating of a contaminant (such as dusts) to a critical point leading to ignition of the sample.

The laser configuration presents further safety concerns because radiation at 785 nm and 993 nm is nearly invisible. Always be aware of the initial direction and possible scattering paths of the laser. The use of laser safety glasses with OD3 or greater is highly recommended for 532 nm and 785 nm excitation wavelengths and OD4 or greater for a 993 nm excitation wavelength.

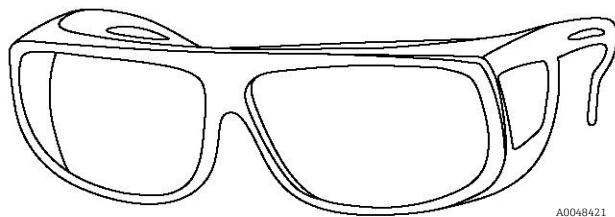

Figure 1. Laser safety glasses

For more assistance with taking appropriate precautions and setting the proper controls when dealing with lasers and their hazards, refer to the most current version of ANSI Z136.1 or IEC 60825-14.

## 2.6 Service safety

Follow your company's safety instructions when removing a process probe from the process interface for service. Always wear proper protective equipment when servicing the equipment.

## 2.7 Important safeguards

- Do not use the Rxn-20 probe for anything other than its intended use.
- Do not look directly into the laser beam.
- Do not point the laser at a mirrored/shiny surface or a surface that may cause diffuse reflections. The reflected beam is as harmful as the direct beam.
- Do not leave attached and unused probes uncapped or unblocked.
- Always use a laser beam block to avoid inadvertent scatter of laser radiation.
- Always secure the probe so that it is pointing away from personnel. Never handle the probe freely when it is operating.

## 2.8 Product safety

This product is designed to meet all current safety requirements, has been tested, and shipped from the factory in a safe operating condition. The relevant regulations and international standards have been observed. Devices connected to an analyzer must also comply with the applicable analyzer safety standards.

Endress+Hauser Raman spectroscopy systems incorporate the following safety features to conform to the United States Government requirements 21 [Code of Federal Regulations](#) (CFR) Chapter 1, Subchapter J as administered by the [Center for Devices and Radiological Health](#) (CDRH) and IEC 60825-1 as administered by the [International Electrotechnical Commission](#).



### 2.8.1 CDRH and IEC compliance

Endress+Hauser Raman analyzers are certified by Endress+Hauser to meet CDRH and IEC 60825-1 design and manufacturing requirements.

Endress+Hauser Raman analyzers have been registered with the CDRH. Any unauthorized modifications to an existing Raman Rxn2 or Raman Rxn4 analyzer or accessory may result in hazardous radiation exposure. Such modifications may result in the system being no longer in conformance with federal requirements as certified by Endress+Hauser.

### 2.8.2 Laser safety interlock

The Rxn-20 probe, as installed, forms part of the interlock circuit. If the fiber cable is severed, the laser will turn off within milliseconds of the breakage.

#### NOTICE

#### Handle probes and cables with care.

Fiber cables should NOT be kinked and should be routed to maintain the minimum bend radius of 75 mm (2.96 in.).

- ▶ Permanent damage may result if cables are not routed appropriately.

The probe contains an intrinsically safe level of electrical potential. If the probe is installed in an enclosure, an optional interlock switch may be fitted to the enclosure lid such that opening the enclosure will operate the laser interlock and shut the laser down within milliseconds of the enclosure being opened.

### 2.8.3 Laser radiation emission indicator

In addition to the CDRH-compliant indicators on the base unit of a Raman Rxn2/Rxn4 (hybrid configuration) analyzer, the Rxn-20 probe has an electrically powered CRDH-compliant laser emission indicator.

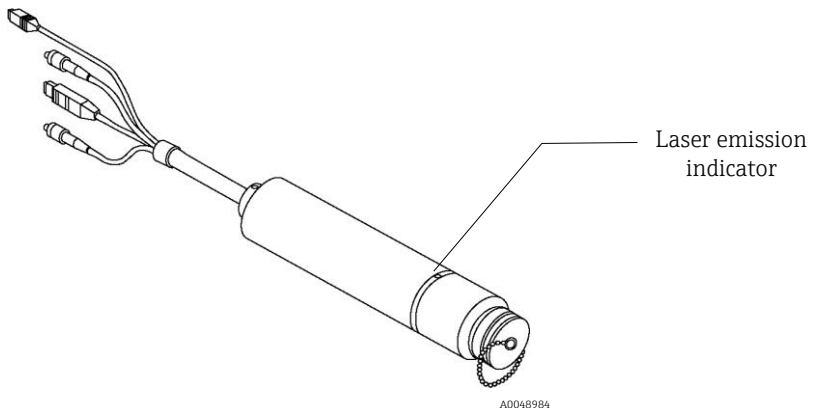

Figure 2. Location of the laser emission indicator on the Rxn-20 probe

## 3 Product description

### 3.1 The Rxn-20 probe

The Rxn-20 Raman spectroscopic probe, powered by Kaiser Raman technology, is optimized for large volumetric measurements, enabling representative, focus-free, quantitative Raman measurements of solids and semi-solids in a laboratory or process plant setting. The Rxn-20 probe is designed to be compatible with Endress+Hauser Raman Rxn2/Rxn4 (hybrid configuration) analyzers operating at 785 nm.



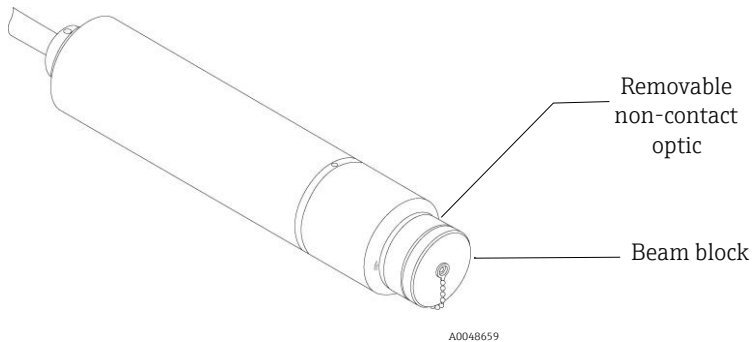



To enhance sampling flexibility, both immersion and non-contact sampling optics are available for the Rxn-20 probe. The Rxn-20 probe has a threaded beam block cap attached for safety.

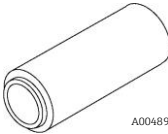
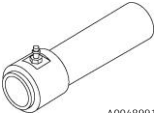
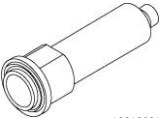

*Figure 3. Stainless steel Rxn-20 probe*

### 3.2 Raman Rxn-20 probe accessories

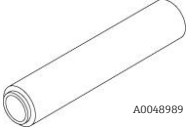
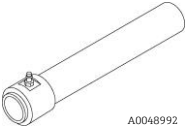
The probe is compatible with the accessories below to meet the requirements of different applications.

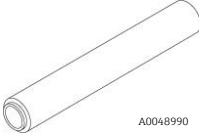
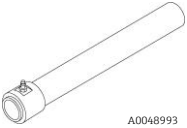
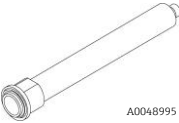
Spot size	Lens adapters 38.1 mm (1.50 in.) diameter	Lens tubes: <b>non-purged</b> 31.8 mm (1.25 in.) diameter, for Enclosed Sample Compartment	Lens tubes: <b>purgeable</b> 25.4 mm (1.00 in.) diameter	Immersion optics 25.4 mm (1.00 in.) diameter
	<b>316 stainless steel, PTFE</b>	<b>Aluminum alloy 6061-T651, anodized black</b>	<b>316 stainless steel with 303 stainless barbed nipple</b>	<b>316 stainless steel, Kalrez, PTFE, sapphire</b>
<b>1 mm (0.04 in.)</b>	 *	<b>X</b>	<b>X</b>	<b>X</b>
<b>1.5 mm (0.06 in.)</b>	 *	<b>X</b>	<b>X</b>	<b>X</b>
<b>3 mm (0.12 in.)</b>	 A0048985	 A0048988	 A0048991	 A0048994
<b>4.7 mm (0.19 in.)</b>	 A0048986	 A0048989	 A0048992	<b>X</b>
<b>6 mm (0.24 in.)</b>	 A0048987	 A0048990	 A0048993	 A0048995

\*Compatible with small sample chamber using 76.2 mm (3.00 in.) lens tube mounted between the probe body and lens adapter

Table 3. Accessories for the Rxn-20 probe

## 4 Incoming product acceptance and product identification

### 4.1 Incoming acceptance

1. Verify that the packaging is undamaged. Notify the supplier of any damage to the packaging. Keep the damaged packaging until the issue has been resolved.
2. Verify that the contents are undamaged. Notify the supplier of any damage to the delivery contents. Keep the damaged goods until the issue has been resolved.
3. Check that the delivery is complete and nothing is missing. Compare the shipping documents with your order.
4. Pack the product for storage and transportation in such a way that it is protected against impact and moisture. The original packaging offers the best protection. Make sure to comply with the permitted ambient conditions.

If you have any questions, please contact your supplier or your local sales center.

#### NOTICE

**Probe may be damaged during transport if packaged inadequately.**

### 4.2 Product identification

#### 4.2.1 Label

At a minimum, the probe/tag is labeled with the following information:

- Endress+Hauser branding
- Serial number

Where size allows, the following information is also included:

- Product identification (e.g., Rxn-20)
- Extended order code
- Manufacturer information
- Key functional aspects of the probe (e.g., material, wavelength, focal depth)
- Safety warnings and certification information, as applicable

Compare the information on the label/tag with the order.

#### 4.2.2 Manufacturer address

Endress+Hauser  
371 Parkland Plaza  
Ann Arbor, MI 48103 USA

### **4.3 Scope of delivery**

The scope of delivery comprises:

- Rxn-20 probe in the configuration ordered
- Rxn-20 Raman spectroscopic probe Operating Instructions manual
- Rxn-20 probe Certificate of Product Performance
- Local declarations of conformity, if applicable
- Certificates for hazardous zone use, if applicable
- Rxn-20 probe optional accessories, if applicable
- Material certificates, if applicable

If you have any queries, please contact your supplier or local sales center.

## 5 Probe and fiber optic connection

The Rxn-20 probe connects to the Raman Rxn (hybrid configuration) analyzer via a fiber optic bundle. Standard fiber cable lengths are 3, 10, or 15 m (9.84, 32.81, or 49.21 ft.). Custom cable lengths are also available.

### NOTICE

**Connection of the probe to the fiber optic cable must be conducted by a qualified Endress+Hauser engineer or specially trained technical personnel.**

- ▶ Unless trained by qualified personnel, customer attempts to connect the probe to the fiber optic cable can result in damage and may void the warranty.
- ▶ Contact your local Endress+Hauser service representative for additional support regarding the probe and fiber cable connection.

The fiber optic bundle connects the Rxn-20 probe to the analyzer via the following:

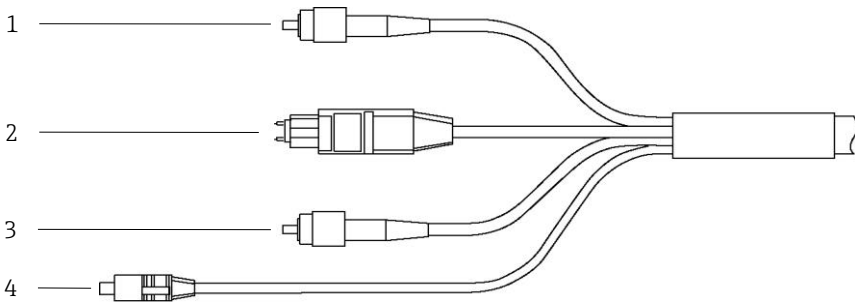

A0048999

Figure 4. Rxn-20 probe fiber optic bundle

#	Name	Description
1	Excitation fiber	Fiber channel (FC) type fiber that provides fiber optic laser radiation output
2	Collection fiber	Mechanical transfer (MT) type fiber for Raman scatter collection
3	Calibration fiber	FC type fiber that provides fiber optic auto-calibration source output
4	Laser interlock connector	Electrical interlock loop connector; in case of fiber breakage, laser will turn OFF



Table 4. Rxn-20 probe fiber optic bundle

Refer to the applicable Raman Rxn2 or Raman Rxn4 analyzer operating instructions for analyzer connection details.

## 6 Installation

Prior to installation in the process, verify that the amount of laser power out of each probe is no more than the amount specified in the Hazardous Area Equipment Assessment (4002266) or equivalent.

Standard eye and skin safety precautions for Class 3B laser products (as per EN-60825/IEC 60825-14) should be observed as described below.

 <b>WARNING</b>	<p><b>Standard precautions for laser products should be observed.</b></p> <ul style="list-style-type: none"> <li>▶ Probes should always be capped or pointed away from people toward a diffuse target if not installed in a sample chamber.</li> </ul>
 <b>CAUTION</b>	<p><b>If stray light is allowed to enter an unused probe, it will interfere with data collected from a used probe and may cause calibration failure or measurement errors.</b></p> <ul style="list-style-type: none"> <li>▶ Unused probes should ALWAYS be capped to prevent stray light from entering the probe.</li> </ul>
<b>NOTICE</b>	<p><b>Take care to install the probe such that it measures the sample or region of interest.</b></p>





## 6.2 Process and probe compatibility

Prior to installation, the user must verify that the probe pressure and temperature ratings, as well as the materials from which the probe is made, are compatible with the process into which it is being inserted.

The probe should be installed using sealing techniques (e.g., compression fittings) appropriate and typical for the vessel or piping and in accordance with any local construction codes.

### **WARNING**

**If the probe will be installed in a high temperature or pressure process, additional safety precautions must be taken to avoid equipment damage or safety hazards.**

A blow-out protection device is highly recommended in accordance with local safety standards.

- ▶ It is the responsibility of the user to determine if any blow-out protection devices are required and ensure they are attached to the probe during installation.

## 7 Commissioning

The Rxn-20 probe is delivered ready to connect to the Raman Rxn2 (hybrid configuration) or Raman Rxn4 (hybrid configuration) analyzer. No additional alignment or adjustment to the probe itself is required. Connection of the probe to the Raman Rxn2/Rxn4 (hybrid configuration) analyzer must be conducted by a qualified Endress+Hauser engineer.

Follow the instructions below to commission the probe for use.

### NOTICE

**The probe installation and usage parameters may have specific requirements governed by the associated application.**

- ▶ Please refer to the appropriate certificate for ATEX, CSA, or IECEx for those specific requirements.

### 7.1 Receipt of probe

Perform the steps for incoming product acceptance described in Section 4.1 → .

Additionally, upon receipt, remove the shipping container cover and inspect the sapphire window for any damage prior to installing into the process. If the window shows any visible cracks, please contact the supplier.

### 7.2 Probe calibration and verification

The probe and the analyzer must be calibrated before use.

Refer to the applicable Raman Rxn2 or Raman Rxn4 analyzer operating instructions for steps to:

- Perform internal analyzer calibration; may include alignment calibration, full wavelength calibration or full laser wavelength calibration depending on status of analyzer
- Perform probe calibration; requires a Calibration Accessory (HCA) with an appropriate optic adapter
- Perform probe verification; verifies the calibration results using a standard reference sample
- View calibration and verification reports

The Raman RunTime software will not allow spectra to be collected without passing internal analyzer and probe calibrations. Passing the probe verification step is not required but highly recommended.

Raman Rxn2 or Raman Rxn4 analyzer operating instructions are available by searching the Downloads area of the Endress+Hauser web site: <https://endress.com/downloads>

## 8 Operation

The Rxn-20 probe is designed for large volumetric measurements of solids and semi-solids in a laboratory or process plant setting. The Rxn-20 probe is compatible with Endress+Hauser Raman Rxn2/Rxn4 (hybrid configuration) analyzers operating at 785 nm.

The probe images the laser excitation light from the fiber bundle onto the sample and images the sample emission onto another fiber bundle. The fiber bundle connects the probe to the analyzer.

The Rxn-20 probe illuminates a large surface area and eliminates the need to align the probe for surface roughness. The principles of operation are below.

### 8.1 Silica Raman removal

Laser light traveling through a silica optical fiber generates silica Raman emission. If this emission were to reach the spectrograph, it could obscure the Raman spectrum of the sample. This problem is especially severe when long lengths of optical fiber are used. The Rxn-20 probe removes the silica Raman light from the laser light after the light exits the excitation fiber bundle and before it reaches the sample. The probe also removes laser light from the sample emission before it reaches the collection fiber bundle. As a result, silica Raman bands are not observed in spectra collected with the Rxn-20 probe, even when very long optical fibers are used.

### 8.2 Focusing excitation radiation

The standard Rxn-20 probe is designed to focus the excitation light on a spot 6 mm (0.24 in.) in diameter for large spot sampling. The large excitation spot and multiple collection fibers in the Rxn-20 probe achieve heterogenous solids sampling in both the axial and lateral dimensions. In doing so, it provides information on deeper layers in addition to the surface, which is useful for measuring heterogenous solids such as tablets, capsules, food solids, and polymer beads.

Alternate excitation spot sizes are available. Refer to the sampling accessories in Section 3.2 → .

Refer to the applicable Raman Rxn2 or Raman Rxn4 analyzer operating instructions for additional instructions for use.

## 9 Diagnostics and troubleshooting

Refer to the table below when troubleshooting issues with the Rxn-20 probe. If the probe is damaged, isolate the probe from the process and turn off the laser prior to evaluation. Contact your service representative as needed for assistance.

Symptom		Possible cause	Action
1	Substantial reduction in signal or signal-to-noise ratio	Lens/window fouling	<ol style="list-style-type: none"> <li>Carefully remove probe from the process, decontaminate, and inspect lens/window at tip of probe.</li> <li>If necessary, clean the lens/window before returning it to service. Refer to the <i>Rxn-20 Raman spectroscopic probe Operating Instructions</i>.</li> </ol>
		Cracked but intact fiber	Verify condition of fiber and contact your service representative for replacement.
2	Complete loss of signal while laser is powered and laser emission indicator is lit	Broken fiber without interlock wire breakage	Ensure all fiber connections are secure. Verify condition of fiber and contact your service representative for replacement.
3	Laser emission indicator on probe is not lit	Damaged fiber assembly	Look for signs of breakage in fiber. Contact your service representative for replacement.
		Laser interlock wire disconnected	Ensure laser interlock wire and remote interlock connector for the probe/channel are properly connected at the analyzer.
4	Decreased laser power or collection efficiency	Contaminated fiber connection	Carefully clean the probe fiber cable ends at the analyzer. Refer to the applicable Raman Rxn analyzer operating instructions for cleaning instructions and steps for starting up a new probe.
		Incorrect combination of lens adapter and lens tube or immersion optic	Select the appropriate lens adapter and lens tube or immersion optic for the desired spot size. Refer to Table 3 for acceptable combinations.
5	Laser emission indicator goes out	Fiber breakage	Contact your service representative to repair or replace the fiber cable.
6	Laser interlock on analyzer causes laser to shut down	Laser interlock activated	Check for fiber breakage on all connected fiber optic cable channels and ensure remote interlock connectors are in place for the same.

Symptom		Possible cause	Action
7	Unrecognized bands or patterns in the spectra	Cracked but intact fiber	Verify possible causes and contact your service representative to return the damaged product.
		Contaminated probe/lens tip	
		Contaminated internal optics of probe due to leakage	
8	Other unexplained negative performance of the probe	Physical damage to probe head or accessories	Contact your service representative to return the damaged product.

*Table 5. Troubleshooting*

[www.addresses.endress.com](http://www.addresses.endress.com)

---