

Brief Operating Instructions

Waterpilot FMX21

Hydrostatic level measurement
4 to 20 mA analog



These Instructions are Brief Operating Instructions; they are not a substitute for the Operating Instructions pertaining to the device.

Detailed information about the device can be found in the Operating Instructions and the other documentation:

Available for all device versions via:

- Internet: www.endress.com/deviceviewer
- Smart phone/tablet: *Endress+Hauser Operations App*

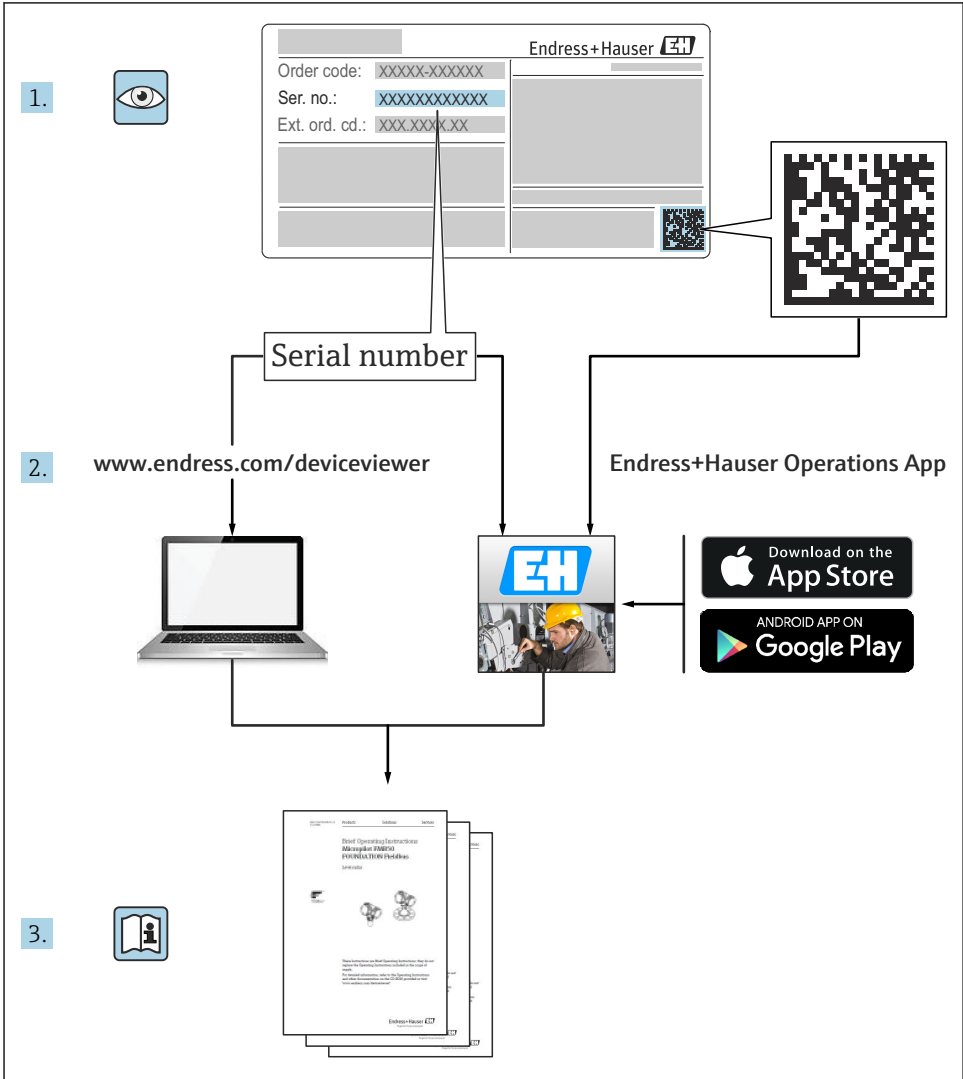

A0023555

Table of contents

1	About this document	3
1.1	Document function	3
1.2	Symbols	4
1.3	Documentation	6
1.4	Registered trademarks	6
1.5	Terms and abbreviations	7
1.6	Turn down calculation	8
2	Basic safety instructions	9
2.1	Requirements for personnel	9
2.2	Intended use	9
2.3	Workplace safety	9
2.4	Operational safety	9
2.5	Product safety	10
3	Incoming acceptance and product identification	10
3.1	Incoming acceptance	10
3.2	Product identification	11
3.3	Nameplates	11
3.4	Storage and transport	12
4	Mounting	14
4.1	Mounting requirements	14
4.2	Additional mounting instructions	15
4.3	Mounting the Waterpilot with a suspension clamp	16
4.4	Mounting the device with a cable mounting screw	17
4.5	Mounting the terminal box	18
4.6	Mounting the TMT71 temperature head transmitter with terminal box	18
4.7	Cable marking	20
4.8	Post-mounting check	20
5	Electrical connection	21
5.1	Connecting the device	21
5.2	Supply voltage	24
5.3	Cable specifications	24
5.4	Power consumption	24
5.5	Current consumption	25
5.6	Connecting the measuring unit	25
5.7	Post-connection check	27
6	Operation options	27
6.1	Overview of operation options	27

1 About this document

1.1 Document function

The Brief Operating Instructions contain all the essential information from incoming acceptance to initial commissioning.

1.2 Symbols

1.2.1 Safety symbols

DANGER

This symbol alerts you to a dangerous situation. Failure to avoid this situation will result in serious or fatal injury.

WARNING

This symbol alerts you to a dangerous situation. Failure to avoid this situation can result in serious or fatal injury.

CAUTION

This symbol alerts you to a dangerous situation. Failure to avoid this situation can result in minor or medium injury.

NOTICE

This symbol contains information on procedures and other facts which do not result in personal injury.

1.2.2 Electrical symbols



Direct current



Alternating current



Direct and alternating current

 Ground connection

Grounded clamp, which is grounded via a grounding system.

 Protective earth (PE)

Ground terminals, which must be grounded prior to establishing any other connections. The ground terminals are located on the inside and outside of the device.

 Equipotential connection

A connection that has to be connected to the plant grounding system: This may be a potential equalization line or a star grounding system depending on national or company codes of practice.

1.2.3 Tool symbols

 Flat blade screwdriver

 Phillips screwdriver



 Allen key

 Open-ended wrench

1.2.4 Symbols for certain types of information

 **Permitted**

Procedures, processes or actions that are permitted

  **Preferred**

Procedures, processes or actions that are preferred

 **Forbidden**

Procedures, processes or actions that are forbidden

 **Tip**

Indicates additional information



Reference to documentation



Reference to page



Reference to graphic

1., 2., 3.

Series of steps



Result of a step



Help in the event of a problem



Visual inspection

1.2.5 Symbols in graphics

1, 2, 3, ...

Item numbers

1., 2., 3.

Series of steps

A, B, C, ...

Views

A-A, B-B, C-C etc.

Sections

1.3 Documentation

The following types of documentation are available in the Download Area of the Endress+Hauser website (www.endress.com/downloads):



For an overview of the scope of the associated Technical Documentation, refer to the following:

- *W@M Device Viewer* (www.endress.com/deviceviewer): Enter the serial number from the nameplate
- *Endress+Hauser Operations App*: Enter the serial number from the nameplate or scan the matrix code on the nameplate

1.3.1 Operating Instructions (BA)

Your reference guide

These Operating Instructions contain all the information that is required in various phases of the life cycle of the device: from product identification, incoming acceptance and storage, to mounting, connection, operation and commissioning through to troubleshooting, maintenance and disposal.

1.3.2 Safety Instructions (XA)

Depending on the approval, the following Safety Instructions (XA) are supplied with the device. They are an integral part of the Operating Instructions.



The nameplate indicates the Safety Instructions (XA) that are relevant to the device.

1.4 Registered trademarks

1.4.1 GORE-TEX®

Trademark of W.L. Gore & Associates, Inc., USA.

1.4.2 TEFLON®

Trademark of E.I. Du Pont de Nemours & Co., Wilmington, USA.

1.4.3 iTEMP®

Trademark of Endress+Hauser Wetzler GmbH + Co. KG, Nesselwang, D..

1.5 Terms and abbreviations

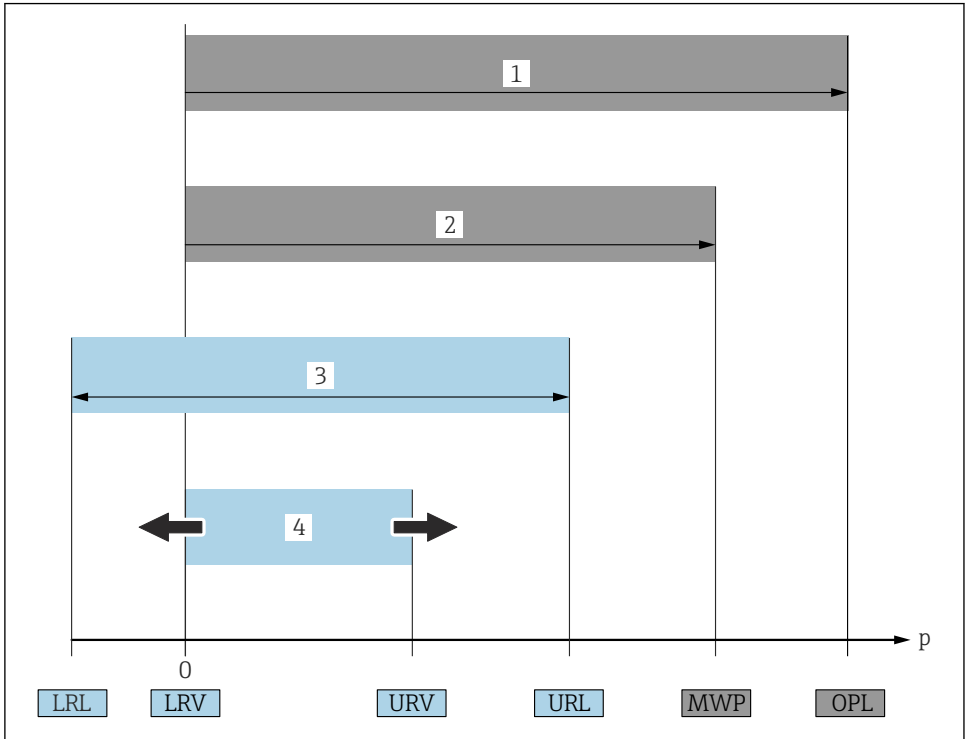

A0029505

- **OPL (1)**
 The OPL (Over Pressure Limit) for the measuring device depends on the lowest-rated element, with regard to pressure, of the selected components i.e. the process connection has to be taken into consideration in addition to the measuring cell. Also observe pressure-temperature dependency.
 The OPL may only be applied for a limited period of time.
- **MWP (2)**
 The MWP (Maximum Working Pressure) for the sensors depends on the lowest-rated element, with regard to pressure, of the selected components, i.e. the process connection has to be taken into consideration in addition to the measuring cell. Also observe pressure-temperature dependency.
 The MWP may be applied at the device for an unlimited period.
 The MWP can also be found on the nameplate.
- **Maximum sensor measuring range (3)**
 Span between LRL and URL. This sensor measuring range is equivalent to the maximum calibratable/adjustable span.

▪ **Calibrated/adjusted span (4)**

Span between LRV and URV. Factory setting: 0 to URL
 Other calibrated spans can be ordered as customized spans.

- **p:** Pressure
- **LRL:** Lower range limit
- **URL:** Upper range limit
- **LRV:** Lower range value
- **URV:** Upper range value
- **TD (Turn down):** Example - see the following section
- **PE:** Polyethylene
- **FEP:** Fluorinated ethylene propylene
- **PUR:** Polyurethane

1.6 Turn down calculation

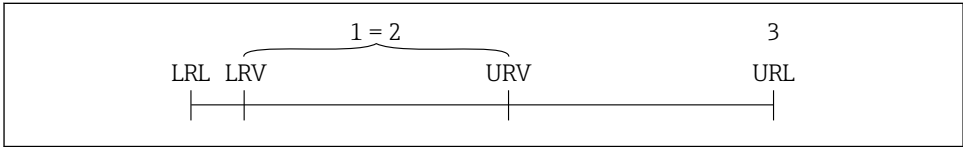

A0029545

- 1 *Calibrated/adjusted span*
- 2 *Zero point-based span (4 to 20 mA Analog: customer-specific span can only be set at the factory when ordered)*
- 3 *URL sensor*

Example

- Sensor: 10 bar (150 psi)
- Upper range value (URL) = 10 bar (150 psi)
- Calibrated/adjusted span: 0 to 5 bar (0 to 75 psi)
- Lower range value (LRV) = 0 bar (0 psi)
- Upper range value (URV) = 5 bar (75 psi)

Turn down (TD):

$$TD = \frac{URL}{|URV - LRV|}$$

$$TD = \frac{10 \text{ bar (150 psi)}}{|5 \text{ bar (75 psi)} - 0 \text{ bar (0 psi)}|} = 2$$

In this example, the TD is 2:1.
 This span is based on the zero point.

2 Basic safety instructions

2.1 Requirements for personnel

The personnel must fulfill the following requirements for its tasks:

- ▶ Trained, qualified specialists must have a relevant qualification for this specific function and task.
- ▶ Personnel must be authorized by the plant owner/operator.
- ▶ Personnel must be familiar with federal/national regulations.
- ▶ Before starting work: personnel must read and understand the instructions in the manual and supplementary documentation as well as the certificates (depending on the application).
- ▶ Personnel must follow instructions and comply with general policies.

2.2 Intended use

2.2.1 Application and media

The Waterpilot FMX21 is a hydrostatic pressure sensor for measuring the level of fresh water, wastewater and salt water. The temperature is measured simultaneously in the case of sensor versions with a Pt100 resistance thermometer.

An optional temperature head transmitter converts the Pt100 signal into a 4 to 20 mA signal.

2.2.2 Incorrect use

The manufacturer is not liable for damage caused by improper or non-intended use.

Verification for borderline cases:

- ▶ For special fluids and fluids for cleaning, Endress+Hauser is glad to provide assistance in verifying the corrosion resistance of fluid-wetted materials, but does not accept any warranty or liability.

2.3 Workplace safety

For work on and with the device:

- ▶ Wear the required personal protective equipment according to federal/national regulations.
- ▶ Switch off the supply voltage before connecting the device.

2.4 Operational safety

Risk of injury!

- ▶ Operate the device in proper technical condition and fail-safe condition only.
- ▶ The operator is responsible for interference-free operation of the device.

Modifications to the device

Unauthorized modifications to the device are not permitted and can lead to unforeseeable dangers.

- ▶ If, despite this, modifications are required, consult with Endress+Hauser.

Repairs

To ensure continued operational safety and reliability,

- ▶ Carry out repairs on the device only if they are expressly permitted.
- ▶ Observe federal/national regulations pertaining to repair of an electrical device.
- ▶ Use original spare parts and accessories from Endress+Hauser only.

Hazardous area

To eliminate danger to persons or the facility when the device is used in the approval-related area (e.g. explosion protection, pressure vessel safety):

- ▶ Check the nameplate to verify if the device ordered can be put to its intended use in the approval-related area.
- ▶ Observe the specifications in the separate supplementary documentation that is an integral part of these Instructions.

2.5 Product safety

This measuring device is designed in accordance with good engineering practice to meet state-of-the-art safety requirements, has been tested, and left the factory in a condition in which it is safe to operate.

It meets general safety standards and legal requirements. It also complies with the EC directives listed in the device-specific EC Declaration of Conformity. Endress+Hauser confirms this by affixing the CE mark to the device.

3 Incoming acceptance and product identification

3.1 Incoming acceptance

Check the following during incoming acceptance:

- Are the order codes on the delivery note and the product sticker identical?
- Are the goods undamaged?
- Do the data on the nameplate match the ordering information on the delivery note?
- If required (see nameplate): are the Safety Instructions e.g. XA provided?



If one of these conditions is not met, please contact the manufacturer's sales office.

3.2 Product identification

The following options are available for identification of the device:

- Nameplate specifications
- Extended order code with breakdown of the device features on the delivery note
- Enter serial number of nameplates in *W@M Device Viewer* www.endress.com/deviceviewer. All of the information on the measuring device is displayed along with an overview of the scope of technical documentation provided.
- Enter the serial number on the nameplate into the *Endress+Hauser Operations app* or scan the 2-D matrix code on the nameplate with the *Endress+Hauser Operations app*

3.2.1 Manufacturer address

Endress+Hauser SE+Co. KG

Hauptstraße 1

79689 Maulburg, Germany

Address of the manufacturing plant: See nameplate.

3.3 Nameplates

3.3.1 Nameplates on extension cable

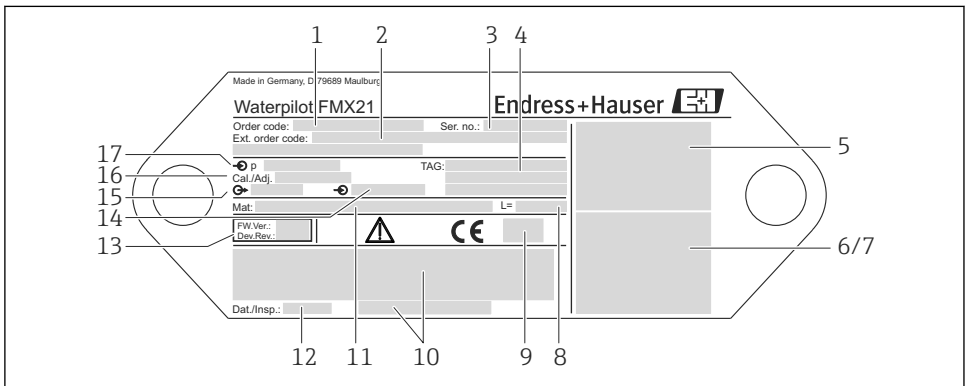

A0018802

- 1 Order code (shortened for reordering); The meaning of the individual letters and digits is explained in the order confirmation details.
- 2 Extended order number (complete)
- 3 Serial number (for clear identification)
- 4-17 See the Operating Instructions

Additional nameplate for devices with approvals

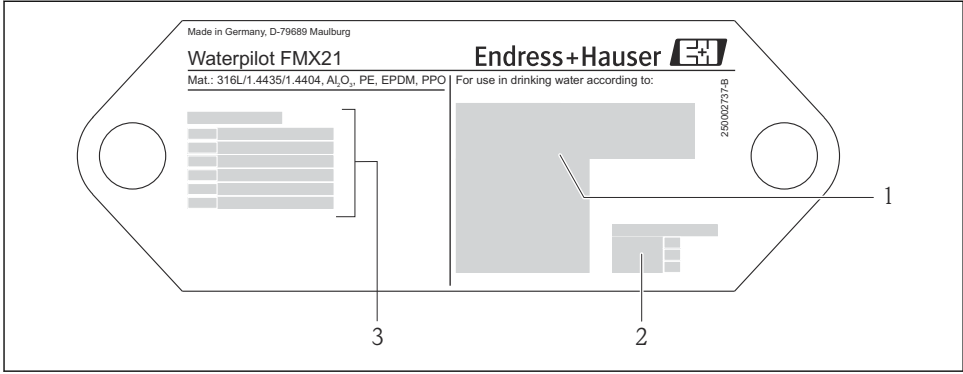

A0018805

- 1 Approval symbol (drinking water approval)
- 2 Reference to associated documentation
- 3 Approval number (marine approval)

3.3.2 Additional nameplate for devices with external diameter 22 mm (0.87 in) and 42 mm (1.65 in)

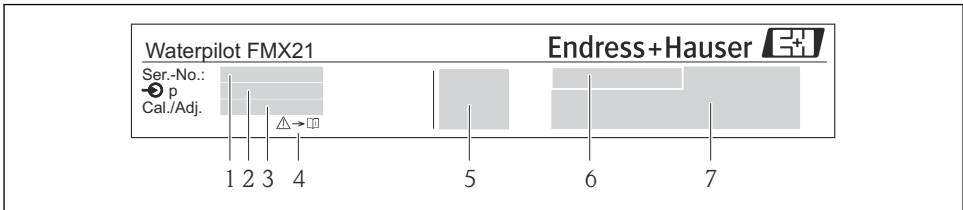

A0018804

- 1 Serial number
- 2 Nominal measuring range
- 3 Set measuring range
- 4 CE mark or approval symbol
- 5 Certificate number (optional)
- 6 Text for approval (optional)
- 7 Reference to documentation

3.4 Storage and transport

3.4.1 Storage conditions

Use original packaging.

Store the measuring device in clean and dry conditions and protect from damage caused by shocks (EN 837-2).

Storage temperature range

Device + Pt100 (optional)

-40 to +80 °C (-40 to +176 °F)

Cable

(when mounted in a fixed position)

- With PE: -30 to +70 °C (-22 to +158 °F)
- With FEP: -30 to +80 °C (-22 to +176 °F)
- With PUR: -40 to +80 °C (-40 to +176 °F)

Terminal box

-40 to +80 °C (-40 to +176 °F)

TMT71 temperature head transmitter (optional)

-40 to +100 °C (-40 to +212 °F)

3.4.2 Transporting the product to the measuring point



Incorrect transport!

Device or cable may become damaged, and there is a risk of injury!

- ▶ Transport measuring device in the original packaging.
- ▶ Follow the safety instructions and transport conditions for devices weighing more than 18 kg (39.6 lbs).

4 Mounting

4.1 Mounting requirements

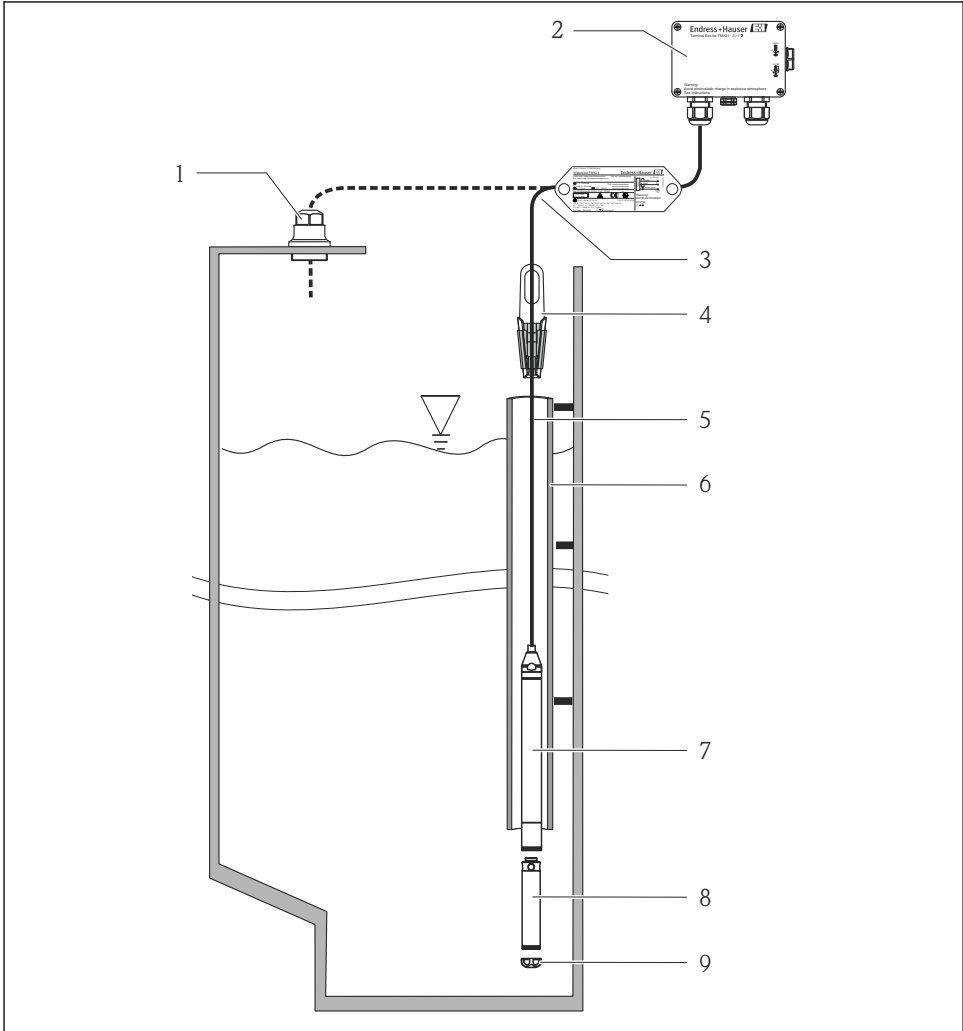

A0018770

- 1 Cable mounting screw (can be ordered as an accessory)
- 2 Terminal box (can be ordered as an accessory)
- 3 Bending radius of extension cable 120 mm (4.72 in)
- 4 Suspension clamp (can be ordered as an accessory)
- 5 Extension cable
- 6 Guide tube

- 7 Device
- 8 Additional weight can be ordered as an accessory for the device with external diameter of 22 mm (0.87 in) and 29 mm (1.14 in)
- 9 Protective cap

4.2 Additional mounting instructions

- Cable length
 - Customer-specific in meters or feet.
 - Limited cable length when performing installation with freely suspended device with cable mounting screw or mounting clamp, as well as for FM/CSA approval: max. 300 m (984 ft).
- Sideways movement of the level probe can result in measuring errors. For this reason, install the probe at a point free from flow and turbulence, or use a guide tube. The internal diameter of the guide tube should be at least 1 mm (0.04 in) greater than the external diameter of the selected FMX21.
- To avoid mechanical damage to the measuring cell, the device is equipped with a protection cap.
- The cable must end in a dry room or a suitable terminal box. The terminal box from Endress+Hauser provides humidity and climatic protection and is suitable for installation outdoors (see the Operating Instructions for additional information).
- Cable length tolerance: < 5 m (16 ft): ± 17.5 mm (0.69 in); > 5 m (16 ft): ± 0.2 %
- If the cable is shortened, the filter at the pressure compensation tube must be reattached. Endress+Hauser offers a cable shortening kit for this purpose (see the Operating Instructions for additional information) (documentation SD00552P/00/A6).
- Endress+Hauser recommends using twisted, shielded cable.
- In shipbuilding applications, measures are required to restrict the spread of fire along cable looms.
- The length of the extension cable depends on the intended level zero point. The height of the protection cap must be taken into consideration when designing the layout of the measuring point. The level zero point (E) corresponds to the position of the process isolating diaphragm. Level zero point = E; tip of probe = L (see the following diagram).

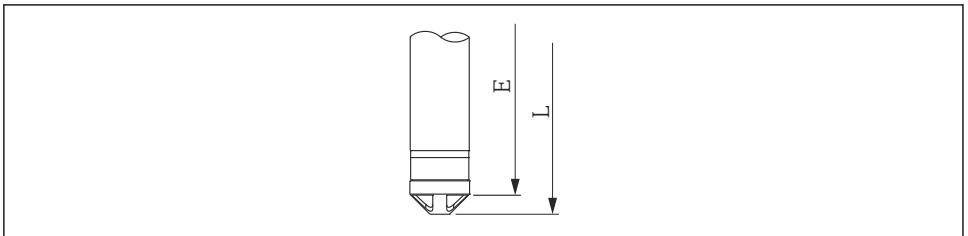

A0026013

4.3 Mounting the Waterpilot with a suspension clamp

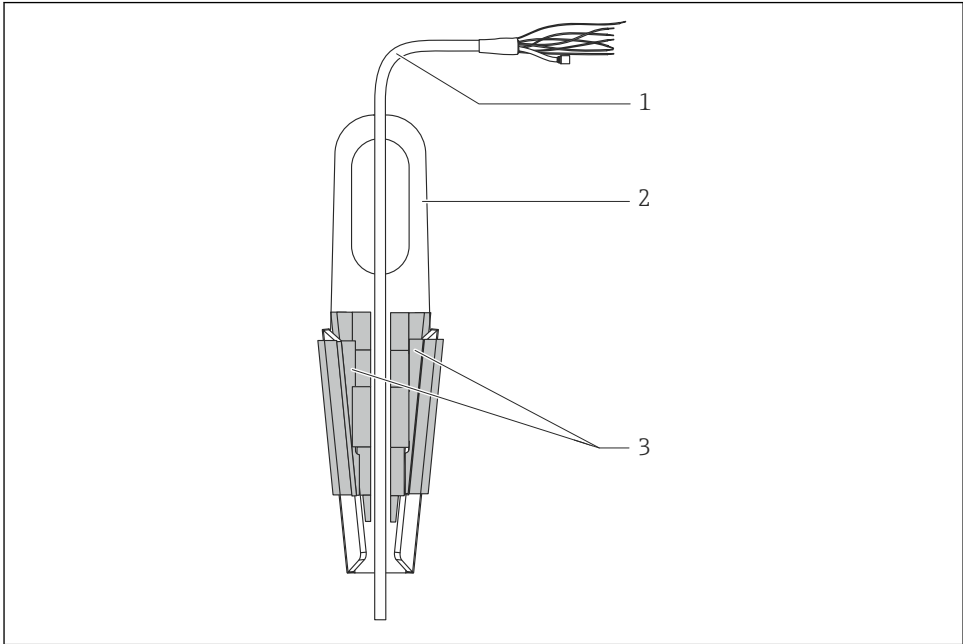

A0018793

- 1 *Extension cable*
- 2 *Suspension clamp*
- 3 *Clamping jaws*

4.3.1 Mounting the suspension clamp:

1. Mount the suspension clamp (item 2). Take the weight of the extension cable (item 1) and the device into account when selecting the fastening point.
2. Push up the clamping jaws (item 3). Place the extension cable (item 1) between the clamping jaws as shown in the graphic.
3. Hold the extension cable (item 1) in position and push the clamping jaws (item 3) back down. Tap the clamping jaws gently from above to fix them in place.

4.4 Mounting the device with a cable mounting screw

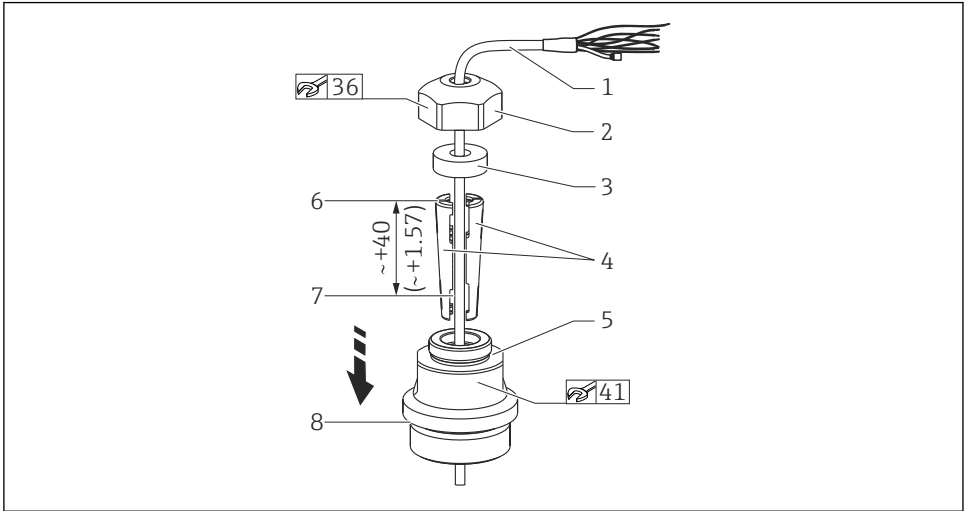

A0018794

 1 Illustrated with G 1½" thread. Unit of measurement mm (in)

- 1 Extension cable
- 2 Cover for cable mounting screw
- 3 Sealing ring
- 4 Clamping sleeves
- 5 Adapter for cable mounting screw
- 6 Top edge of clamping sleeve
- 7 Desired length of extension cable and Waterpilot probe prior to assembly
- 8 After assembly, item 7 is located next to the mounting screw with G 1½" thread: height of sealing surface of the adapter or NPT 1½" thread height of thread run-out of adapter



If you want to lower the level probe to a certain depth, position the top edge of the clamping sleeve 40 mm (4.57 in) higher than the required depth. Then push the extension cable and the clamping sleeve into the adapter as described in Step 6 in the following section.

4.4.1 Mounting the cable mounting screw with a G 1½" or NPT 1½" thread:

1. Mark the desired length of extension cable on the extension cable.
2. Insert the probe through the measuring aperture and carefully lower on the extension cable. Fix the extension cable to prevent it from slipping.
3. Slide the adapter (item 5) over the extension cable and screw it tightly into the measuring aperture.
4. Slide the sealing ring (item 3) and cover (item 2) onto the cable from above. Press the sealing ring into the cover.

5. Place the clamping sleeves (item 4) around the extension cable (item 1) at the marked point as illustrated in the graphic.
6. Slide the extension cable with the clamping sleeves (item 4) into the adapter (item 5)
7. Fit the cover (item 2) with the sealing ring (item 3) onto the adapter (item 5) and securely screw together with the adapter.

 To remove the cable mounting screw, perform this sequence of steps in reverse.

CAUTION

Risk of injury!

- Use only in unpressurized vessels.

4.5 Mounting the terminal box

The optional terminal box is mounted using four screws (M4). For the dimensions of the terminal box, see the Technical Information

4.6 Mounting the TMT71 temperature head transmitter with terminal box

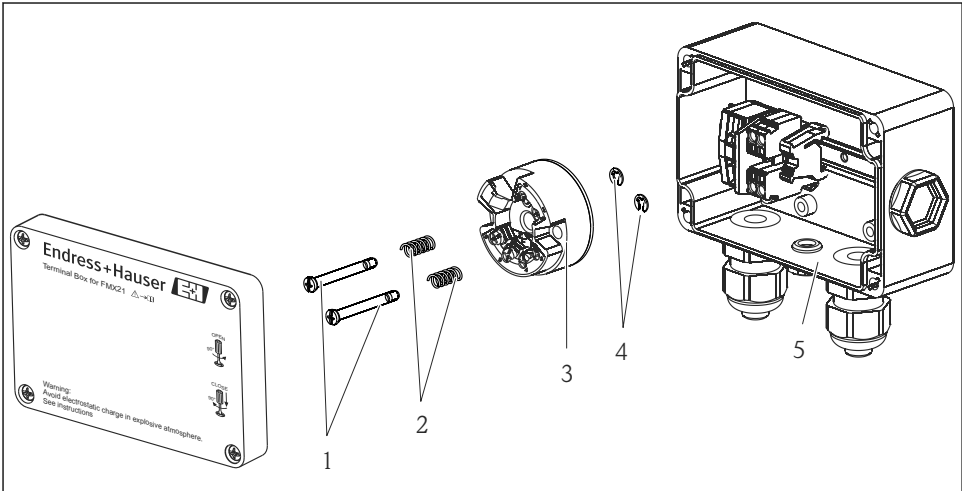

A0018813

- 1 Mounting screws
- 2 Mounting springs
- 3 TMT71 temperature head transmitter
- 4 Circlips
- 5 Terminal box

 Only open the terminal box with a screwdriver.

WARNING**Explosion Hazard!**

- ▶ The TMT71 is not designed for use in hazardous areas.

4.6.1 Mounting the temperature head transmitter:

1. Guide the mounting screws (item 1) with the mounting springs (item 2) through the bore of the temperature head transmitter (item 3)
2. Secure the mounting screws with the circlips (item 4). Circlips, mounting screws and springs are included in the scope of delivery for the temperature head transmitter.
3. Screw the temperature head transmitter into the field housing tightly. (Width of screwdriver blade max. 6 mm (0.24 in))

NOTICE**Avoid damage to the temperature head transmitter.**

- ▶ Do not overtighten the mounting screw.

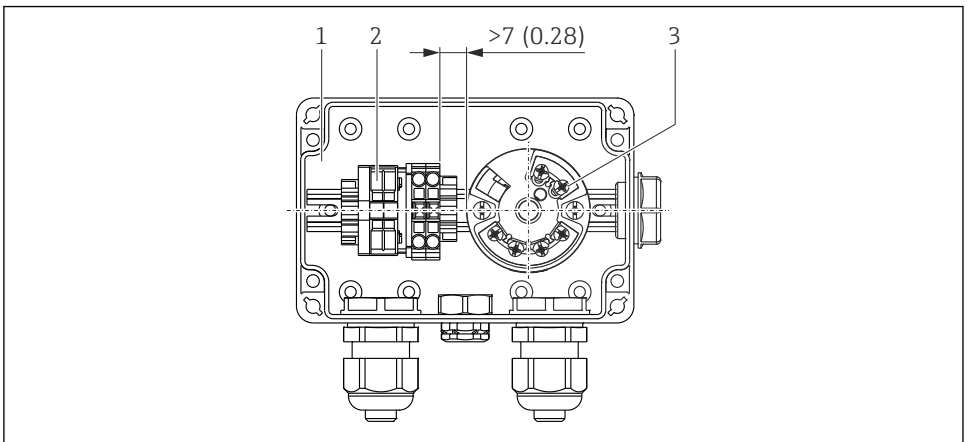

A0018696

Unit of measurement mm (in)

- 1 Terminal box
- 2 Terminal strip
- 3 TMT71 temperature head transmitter

NOTICE**Incorrect mounting!**

- ▶ A distance of > 7 mm (28 in) must be maintained between the terminal strip and the TMT71 temperature head transmitter.

4.7 Cable marking

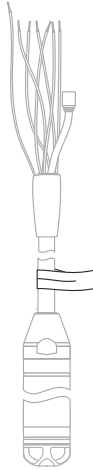

A0030955

- To make installation easier, Endress+Hauser marks the extension cable if a customer-specific length has been ordered.
- Cable marking tolerance (distance to lower end of level probe):
 - Cable length < 5 m (16 ft): ± 17.5 mm (0.69 in)
 - Cable length > 5 m (16 ft): ± 0.2 %
- Material: PET, stick-on label: acrylic
- Immunity to temperature change: -30 to $+100$ °C (-22 to $+212$ °F)

NOTICE

The marking is used exclusively for installation purposes.

- ▶ The mark must be thoroughly removed without trace in the case of devices with drinking water approval. The extension cable must not be damaged in the process.



Not for the use of the device in hazardous areas.

4.8 Post-mounting check

- Is the device undamaged (visual inspection)?
- Does the device conform to the measuring point specifications?
 - Process temperature
 - Process pressure
 - Ambient temperature
 - Measuring range
- Are the measuring point identification and labeling correct (visual inspection)?
- Check that all screws are firmly seated

5 Electrical connection

WARNING

Electrical safety is compromised by an incorrect connection!

- ▶ When using the measuring device in a hazardous area, the relevant national standards and guidelines as well as the Safety Instructions (XAs) or installation or control drawings (ZDs) must be adhered to. All data relating to explosion protection can be found in separate documentation which is available on request. This documentation is supplied with the devices as standard

5.1 Connecting the device

WARNING

Electrical safety is compromised by an incorrect connection!

- ▶ The supply voltage must match the supply voltage specified on the nameplate
- ▶ Switch off the supply voltage before connecting the device.
- ▶ The cable must end in a dry room or a suitable terminal box. The IP66/IP67 terminal box with GORE-TEX® filter from Endress+Hauser is suitable for outdoor installation. →  18
- ▶ Connect the device in accordance with the following diagrams. Reverse polarity protection is integrated in the device and the temperature head transmitter. Changing the polarities will not result in the destruction of the devices.
- ▶ A suitable circuit breaker should be provided for the device in accordance with IEC/EN 61010.

5.1.1 Device with Pt100

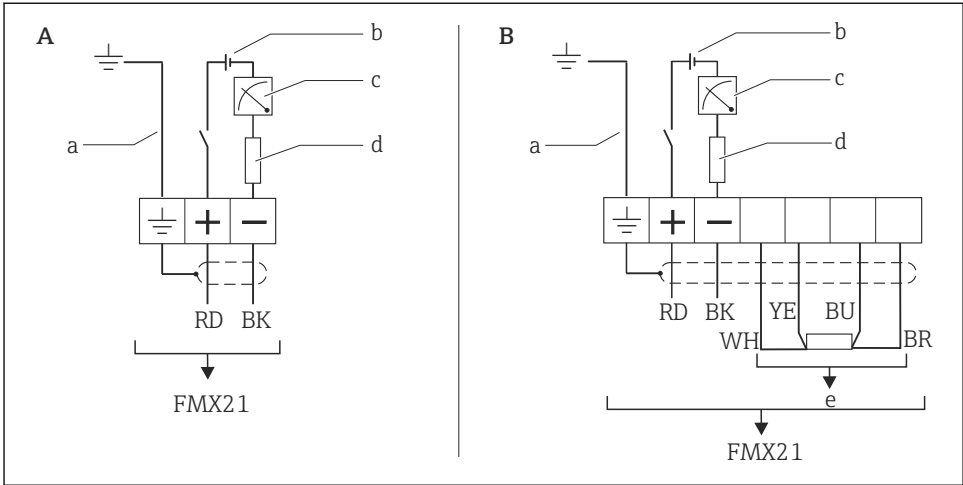

A001941

- A Device
- B Device with Pt100 (not for use in hazardous areas)
- a Not for devices with external diameter of 29 mm (1.14 in)
- b 10.5 to 30 V_{DC} (hazardous area), 10.5 to 35 V_{DC}
- c 4 to 20 mA
- d Resistance (R_L)
- e Pt100

5.1.2 Device with Pt100 and TMT71 temperature head transmitter

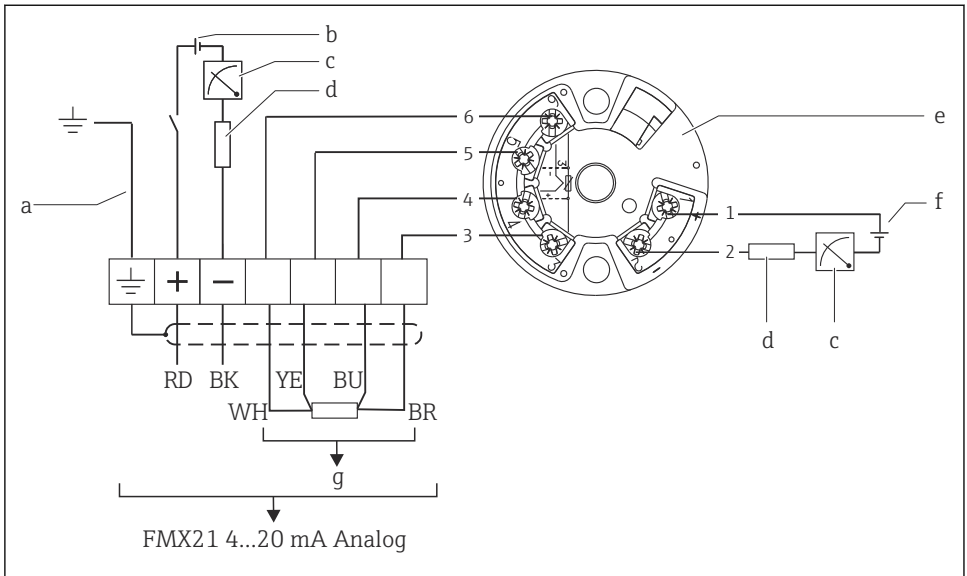

A0030945

- a Not for devices with external diameter of 29 mm (1.14 in)
- b 10.5 to 35 V_{DC}
- c 4 to 20 mA
- d Resistance (R_t)
- e TMT71 temperature head transmitter (4 to 20 mA) (not for use in hazardous areas)
- f 8 to 35 V_{DC}
- g Pt100
- 1 to Pin assignment
- 6

5.1.3 Wire colors

RD = red, BK = black, WH = white, YE = yellow, BU = blue, BR = brown

5.1.4 Connection data

Connection classification as per IEC 61010-1:

- Overvoltage category 1
- Pollution level 1

Connection data in the hazardous area

See relevant XA.

5.2 Supply voltage

WARNING

Supply voltage might be connected!

Risk of electric shock and/or explosion!

- ▶ When using the measuring device in hazardous areas, installation must comply with the corresponding national standards and regulations as well as the Safety Instructions.
- ▶ All explosion protection data are given in separate Ex documentation, which is available upon request. The Ex documentation is supplied as standard with all devices approved for use in explosion hazardous areas.

5.2.1 Device + Pt100 (optional)

- 10.5 to 35 V (non-hazardous area)
- 10.5 to 30 V (hazardous area)

5.2.2 TMT71 temperature head transmitter (optional)

8 to 35 V_{DC}

5.3 Cable specifications

Endress+Hauser recommends using shielded, twisted-pair two-wire cables.

 The probe cables are shielded for device versions with outer diameters of 22 mm (0.87 in) and 42 mm (1.65 in).

5.3.1 Device + Pt100 (optional)

- Commercially available instrument cable
- Terminals, terminal box: 0.08 to 2.5 mm² (28 to 14 AWG)

5.3.2 TMT71 temperature head transmitter (optional)

- Commercially available instrument cable
- Terminals, terminal box: 0.08 to 2.5 mm² (28 to 14 AWG)
- Transmitter connection: max. 1.75 mm² (15 AWG)

5.4 Power consumption

5.4.1 Device + Pt100 (optional)

- ≤ 0.805 W at 35 V_{DC} (non-hazardous area)
- ≤ 0.690 W at 30 V_{DC} (hazardous area)

5.4.2 TMT71 temperature head transmitter (optional)

≤ 0.875 W at 35 V_{DC}

5.5 Current consumption

5.5.1 Device + Pt100 (optional)

Max. current consumption: ≤ 23 mA

Min. current consumption: ≥ 3.6 mA

5.5.2 TMT71 temperature head transmitter (optional)

- Max. current consumption: ≤ 25 mA
- Min. current consumption: ≥ 3.5 mA

5.6 Connecting the measuring unit

5.6.1 Overvoltage protection

To protect the Waterpilot and the TMT71 temperature head transmitter from large interference voltage peaks, Endress+Hauser recommends installing overvoltage protection upstream and downstream of the display and/or evaluation unit as shown in the graphic.

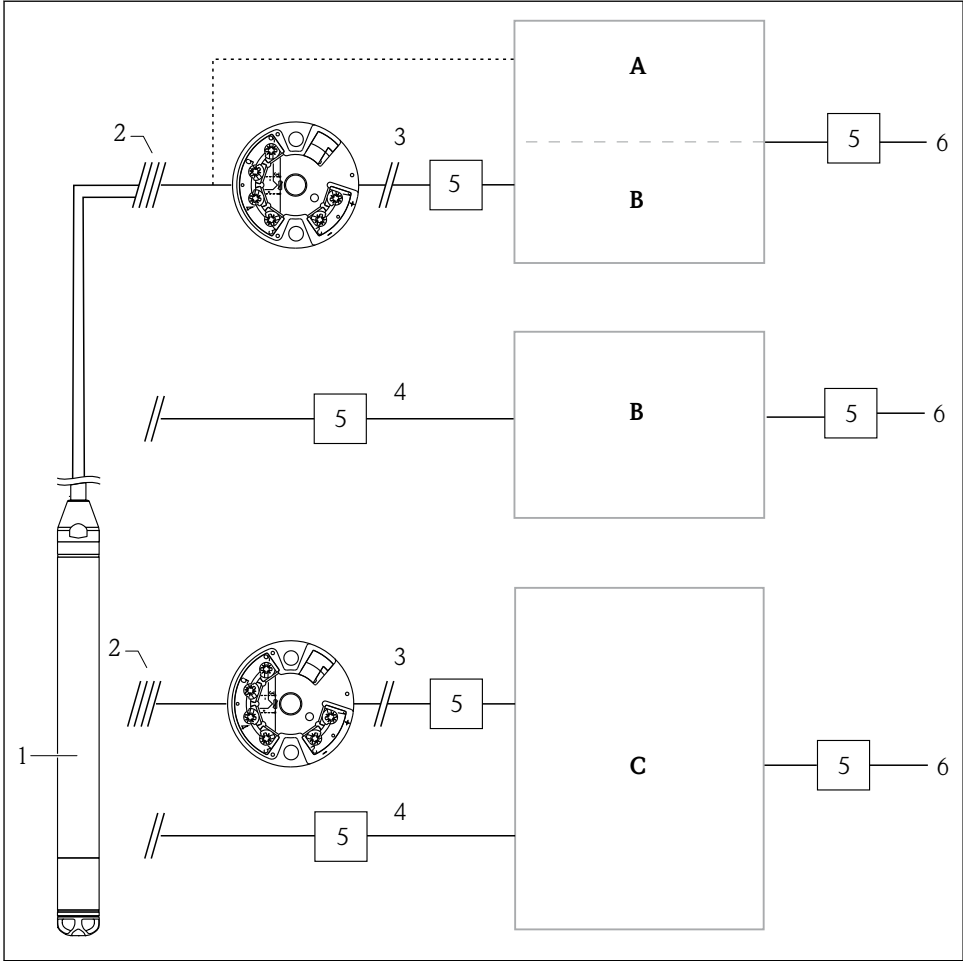

A0030206-EN

- A Power supply, display and evaluation unit with one input for Pt100
- B Power supply, display and evaluation unit with one input for 4 to 20 mA
- C Power supply, display and evaluation unit with two inputs for 4 to 20 mA

1 Device

2 Connection for integrated Pt100 in the FMX21

3 4 to 20 mA (temperature)

4 4 to 20 mA (level)

5 Overvoltage protection, e.g. HAW from Endress+Hauser (not for use in hazardous areas.)

6 Power supply

5.7 Post-connection check

- Are the device or cables undamaged (visual check)?
- Do the cables used comply with the requirements?
- Do the mounted cables have adequate strain relief?
- Are all cable glands installed, securely tightened and leak-tight?
- Does the supply voltage match the information on the nameplate?
- Is the terminal assignment correct?

6 Operation options

Endress+Hauser offers comprehensive measuring point solutions with display and/or evaluation units for the device and the TMT71 temperature head transmitter.



Your Endress+Hauser service organization would be glad to be of service if you have any other questions. Contact addresses are available at: www.endress.com/worldwide

6.1 Overview of operation options

No display or other operation facility is required to operate the device.



71593283

www.addresses.endress.com
