

Operating Instructions

OUSBT66

NIR absorption sensor for the measurement of cell growth and biomass







Table of contents









1	About this document	3	10.2	Calibration	16
1.1	Warnings	3	11	Technical data	16
1.2	Symbols	3	11.1	Input	16
1.3	Symbols on the product	3	11.2	Environment	17
2	Basic safety instructions	4	11.3	Process	17
2.1	Requirements for the personnel	4	11.4	Mechanical construction	17
2.2	Intended use	4	Index	19	
2.3	Workplace safety	4			
2.4	Operational safety	4			
2.5	Product safety	5			
3	Mode of operation	5			
4	Incoming acceptance and product identification	6			
4.1	Incoming acceptance	6			
4.2	Product identification	7			
4.3	Manufacturer address	7			
4.4	Scope of delivery	7			
5	Mounting	8			
5.1	Mounting requirements	8			
5.2	Mounting the sensor	10			
5.3	Post-mounting check	11			
6	Electrical connection	11			
6.1	Connecting the sensor	11			
6.2	Lamp voltage	12			
6.3	Ensuring the degree of protection	12			
6.4	Post-connection check	12			
7	Commissioning	13			
7.1	Function check	13			
7.2	Calibrating/adjusting the sensor	13			
8	Maintenance	14			
9	Repair	15			
9.1	General information	15			
9.2	Spare parts	15			
9.3	Return	15			
9.4	Disposal	15			
10	Accessories	16			
10.1	Assembly	16			

1 About this document



1.1 Warnings

Structure of information	Meaning
<p> DANGER</p> <p>Causes (/consequences) If necessary, Consequences of non-compliance (if applicable)</p> <ul style="list-style-type: none"> ▶ Corrective action 	<p>This symbol alerts you to a dangerous situation. Failure to avoid the dangerous situation will result in a fatal or serious injury.</p>
<p> WARNING</p> <p>Causes (/consequences) If necessary, Consequences of non-compliance (if applicable)</p> <ul style="list-style-type: none"> ▶ Corrective action 	<p>This symbol alerts you to a dangerous situation. Failure to avoid the dangerous situation can result in a fatal or serious injury.</p>
<p> CAUTION</p> <p>Causes (/consequences) If necessary, Consequences of non-compliance (if applicable)</p> <ul style="list-style-type: none"> ▶ Corrective action 	<p>This symbol alerts you to a dangerous situation. Failure to avoid this situation can result in minor or more serious injuries.</p>
<p> NOTICE</p> <p>Cause/situation If necessary, Consequences of non-compliance (if applicable)</p> <ul style="list-style-type: none"> ▶ Action/note 	<p>This symbol alerts you to situations which may result in damage to property.</p>

1.2 Symbols

-  Additional information, tips
-  Permitted
-  Recommended
-  Forbidden or not recommended
-  Reference to device documentation
-  Reference to page
-  Reference to graphic
-  Result of a step

1.3 Symbols on the product

-  Reference to device documentation
-  Do not dispose of products bearing this marking as unsorted municipal waste. Instead, return them to the manufacturer for disposal under the applicable conditions.

2 Basic safety instructions

2.1 Requirements for the personnel

- Installation, commissioning, operation and maintenance of the measuring system may be carried out only by specially trained technical personnel.
- The technical personnel must be authorized by the plant operator to carry out the specified activities.
- The electrical connection may be performed only by an electrical technician.
- The technical personnel must have read and understood these Operating Instructions and must follow the instructions contained therein.
- Faults at the measuring point may only be rectified by authorized and specially trained personnel.



Repairs not described in the Operating Instructions provided must be carried out only directly at the manufacturer's site or by the service organization.

2.2 Intended use

The sensor is suitable for use in a wide range of applications in a variety of industrial sectors, such as:

- Cell growth in bacterial fermentation and applications in mammalian cell cultures
- Biomass in fermentation processes
- Monitoring of algae concentration
- Monitoring of crystallization processes
- Measurement of solids

Use of the device for any purpose other than that described, poses a threat to the safety of people and of the entire measuring system and is therefore not permitted.

The manufacturer is not liable for damage caused by improper or non-designated use.

2.3 Workplace safety

As the user, you are responsible for complying with the following safety conditions:

- Installation guidelines
- Local standards and regulations

Electromagnetic compatibility

- The product has been tested for electromagnetic compatibility in accordance with the applicable international standards for industrial applications.
- The electromagnetic compatibility indicated applies only to a product that has been connected in accordance with these Operating Instructions.

2.4 Operational safety

Before commissioning the entire measuring point:

1. Verify that all connections are correct.
2. Ensure that electrical cables and hose connections are undamaged.

3. Do not operate damaged products, and protect them against unintentional operation.
4. Label damaged products as defective.

During operation:

- ▶ If faults cannot be rectified:
products must be taken out of service and protected against unintentional operation.

2.5 Product safety

The product is designed to meet state-of-the-art safety requirements, has been tested, and left the factory in a condition in which it is safe to operate. The relevant regulations and international standards have been observed.

3 Mode of operation

Light absorption

The measuring principle is based on the Lambert-Beer law.

There is a linear dependency between the absorption of light and the concentration of the absorbing substance:

$$A = -\log(T) = \varepsilon \cdot c \cdot OPL$$

$$T = I/I_0$$

T ... Transmission

I ... Intensity of received light at detector

I₀ ... Intensity of transmitted light of light source

A ... Absorption

ε ... Extinction coefficient

c ... Concentration

OPL ... Optical path length

A light source emits radiation through the medium and the incident radiation is measured on the detector side.

The intensity of the light is determined by a photodiode and converted to a photocurrent. The subsequent conversion to absorbance units (AU, OD) is performed in the associated transmitter.

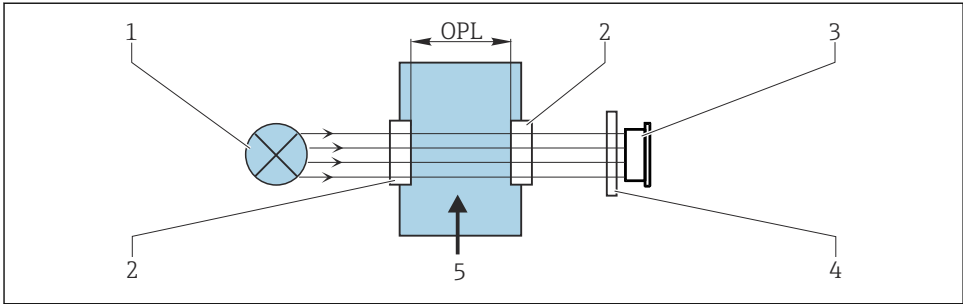

A0029401

1 Absorption measurement

- 1 Light source
- 2 Optical windows of the sensor
- 3 Detector
- 4 Measurement filter (depends on sensor, not provided on all sensors)
- 5 Medium flow

4 Incoming acceptance and product identification

4.1 Incoming acceptance

1. Verify that the packaging is undamaged.
 - ↳ Notify the supplier of any damage to the packaging.
Keep the damaged packaging until the issue has been resolved.
2. Verify that the contents are undamaged.
 - ↳ Notify the supplier of any damage to the delivery contents.
Keep the damaged goods until the issue has been resolved.
3. Check that the delivery is complete and nothing is missing.
 - ↳ Compare the shipping documents with your order.
4. Pack the product for storage and transportation in such a way that it is protected against impact and moisture.
 - ↳ The original packaging offers the best protection.
Make sure to comply with the permitted ambient conditions.

If you have any questions, please contact your supplier or your local Sales Center.

4.2 Product identification

4.2.1 Nameplate

The nameplate provides you with the following information on your device:

- Manufacturer identification
- Order code
- Serial number
- Safety information and warnings

► Compare the information on the nameplate with the order.

4.2.2 Product identification

Product page

www.endress.com/ousbt66

Interpreting the order code

The order code and serial number of your product can be found in the following locations:

- On the nameplate
- In the delivery papers

Obtaining information on the product

1. Go to www.endress.com.
2. Page search (magnifying glass symbol): Enter valid serial number.
3. Search (magnifying glass).
 - ↳ The product structure is displayed in a popup window.
4. Click the product overview.
 - ↳ A new window opens. Here you fill information pertaining to your device, including the product documentation.

4.3 Manufacturer address

Endress+Hauser Conducta Inc.
4123 East La Palma Avenue, Suite 200
Anaheim, CA 92807 USA

4.4 Scope of delivery

The scope of delivery comprises the following, :

- Sensor OUSBT66
- Life sciences package certificates
 - Inspection certificate 3.1
 - Pharma CoC
 - Certificate of conformity to pharmaceutical requirements, conformity to bioreactivity test
 - USP Class VI, FDA material conformity, TSE-/BSE-free, surface roughness
- Operating Instructions

- ▶ If you have any queries:
Please contact your supplier or local sales center.

5 Mounting

5.1 Mounting requirements

5.1.1 Measuring system

An optical measuring system comprises:

- OUSBT66 sensor (photometer)
- Transmitter, for example Liquiline CM44P
- Sensor cable, for example CUK80

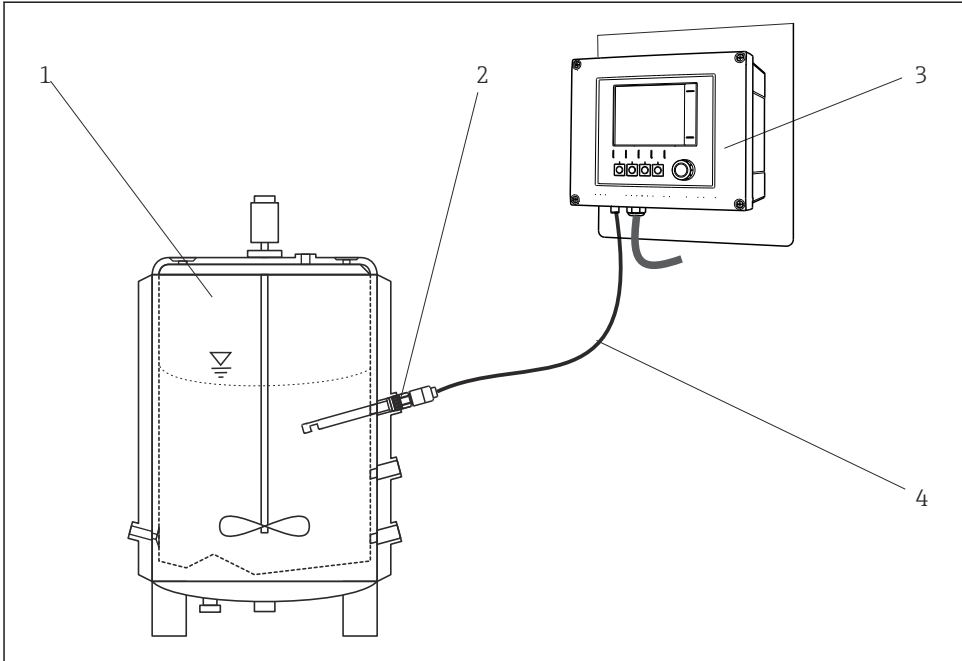

A0029711

▣ 2 Example of a measuring system with a photometer sensor

- 1 Bioreactor (example)
- 2 OUSBT66 sensor
- 3 CM44P transmitter
- 4 CUK80 sensor cable

5.1.2 Dimensions

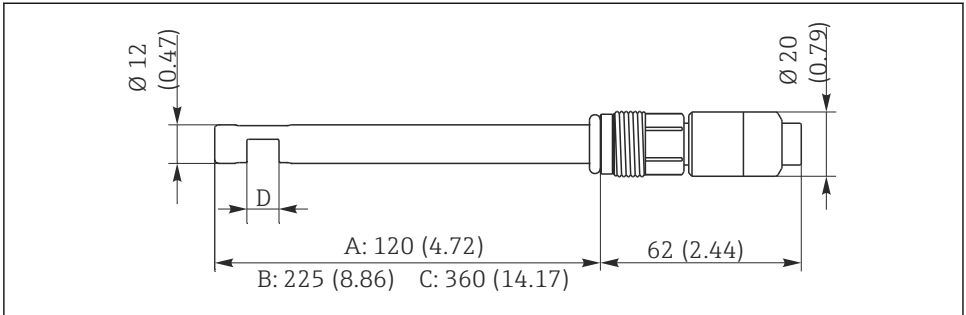

A0029244

3 Dimensions in mm (inch)

- A Version with shaft length 120 mm (4.72")
- B Version with shaft length 225 mm (8.86")
- C Version with shaft length 360 mm (14.17")
- D Optical path length: 5, 10 or 20 mm

5.1.3 Mounting bracket

The sensor can be installed up to the horizontal in an assembly, support or suitable process connection. Other angles of inclination are not recommended.

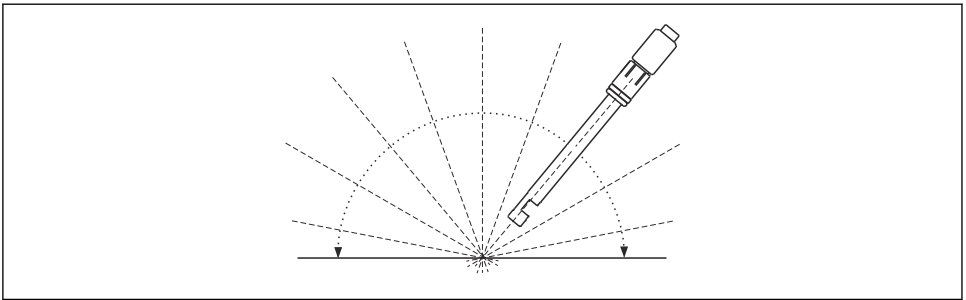

A0029251

4 Permitted mounting angle

5.1.4 Mounting in pipes

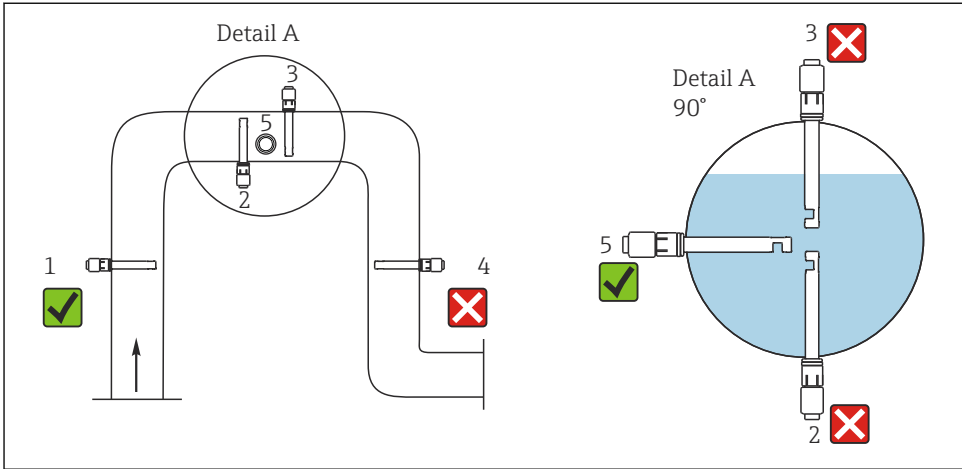

A0029258

☒ 5 Permitted and unacceptable installation positions in pipes

Comply with the following conditions. Otherwise you run the risk of damaging the measuring point or obtaining incorrect measured values.

- ▶ The diameter of the pipe must be at least 50 mm (2").
- ▶ Install the sensor in places with consistent flow conditions.
- ▶ The best installation location is in the ascending pipe (item 1).
- ▶ Installation in the horizontal pipe (item 5) is also possible.
- ▶ Do not install the sensor in places where air pockets or bubbles occur (→ ☒ 5, item 3) or where sedimentation may occur (item 2).
- ▶ Avoid installation in the down pipe (item 4).
- ▶ Align the sensor in such a way that the medium flows through the measuring gap (self-cleaning effect).

5.2 Mounting the sensor

NOTICE

Mounting errors

Possibility of sensor damage, twisted cables or similar

- ▶ Make sure that the sensor bodies are protected against damage from external forces - such as trolleys on adjacent paths.
- ▶ Make sure to avoid exerting excessive tensile force on the cable (e.g. from jerky pulling movements).
- ▶ Make sure to observe the national grounding regulations when using metal assemblies.

Thanks to the connections in the head plate, the sensor can be installed either directly in fermenters and bioreactors with a suitable process connection, or in a suitable assembly.

5.3 Post-mounting check

Put the sensor into operation only if you can answer "yes" to the following questions:

- Are the sensor and cable undamaged?
- Have you chosen a correct mounting angle?

6 Electrical connection



Device is live!

Incorrect connection may result in injury or death!

- ▶ The electrical connection may be performed only by an electrical technician.
- ▶ The electrical technician must have read and understood these Operating Instructions and must follow the instructions contained therein.
- ▶ **Prior** to commencing connection work, ensure that no voltage is present on any cable.

6.1 Connecting the sensor

The sensor is connected to the transmitter using the pre-terminated or labeled sensor fixed cable.

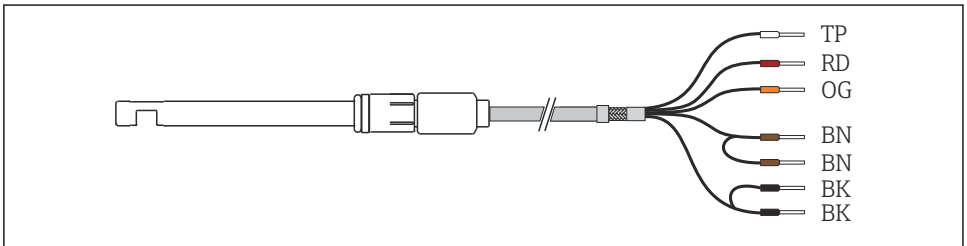

A0029260

6 Sensor cable

CM44P terminal	Cable color	Assignment
P+	BN	Lamp voltage +
S+	BN	Detection of lamp voltage +
S-	BK	Detection of lamp voltage -
P-	BK	Lamp voltage -
A (1)	RD	Sensor +
C(1)	OG	Sensor -
SH (1)	TP	Shield

6.2 Lamp voltage

Sensor version	Lamp type	Lamp voltage [V]
OUSBT66-xxxxx	LED	7.5 ± 0.1

6.3 Ensuring the degree of protection

Only the mechanical and electrical connections which are described in these instructions and which are necessary for the required, designated use, may be carried out on the device delivered.

- ▶ Exercise care when carrying out the work.

Individual types of protection permitted for this product (impermeability (IP), electrical safety, EMC interference immunity) can no longer be guaranteed if, for example :

- Covers are left off
- Different power units to the ones supplied are used
- Cable glands are not sufficiently tightened (must be tightened with 2 Nm (1.5 lbf ft) for the permitted level of IP protection)
- Unsuitable cable diameters are used for the cable glands
- Modules are not fully secured
- The display is not fully secured (risk of moisture entering due to inadequate sealing)
- Loose or insufficiently tightened cables/cable ends
- Conductive cable strands are left in the device

6.4 Post-connection check

Device condition and specifications	Notes
Are the sensor, assembly and cable free from damage on the outside?	Visual inspection

Electrical connection	Notes
Does the supply voltage of the connected transmitter match the data on the nameplate?	Visual inspection
Are the installed cables strain-relieved and not twisted?	
Has the cable been routed without loops and cross-overs?	Check that it is firmly seated (by pulling gently)
Are the signal cables connected correctly according to the connection diagram?	
Are all cable entries mounted, tightened and leak-tight?	For lateral cable entries, make sure the cables loop downwards to allow water to drip off.
Are the PE distributor rails grounded (if present)?	Grounding at the point of installation

7 Commissioning

7.1 Function check

Prior to initial commissioning, ensure that:

- The sensor is correctly installed
- The electrical connection is correct

7.2 Calibrating/adjusting the sensor

Measuring points consisting of a photometer sensor and a transmitter are adjusted at the factory. Normally adjustment is not required when commissioning for the first time.

Calibrate/adjust the sensor (if necessary)

Use the calibration kit (71128340).

You must switch on the sensor lamp for at least 15 minutes before performing the calibration/adjustment in order to heat the lamp. To switch the lamp on/off, use the menu function of the transmitter, e.g. for CM44P: **Setup/Inputs/Photometer/Switch lamp on**.

1. **Setup/Inputs/Photometer/Extended setup/Measurement channel/Calib. settings/Filter calibration** → Yes
2. **CAL/Photometer/Measurement channel/Calibration/2-pnt. calibration**.
3. **Do you want to start the calibration?**
(Hold turns to active)
→ OK.
4. Keep the clean, dry sensor in the air in a dark place. → OK
↳ The current measured value is displayed.

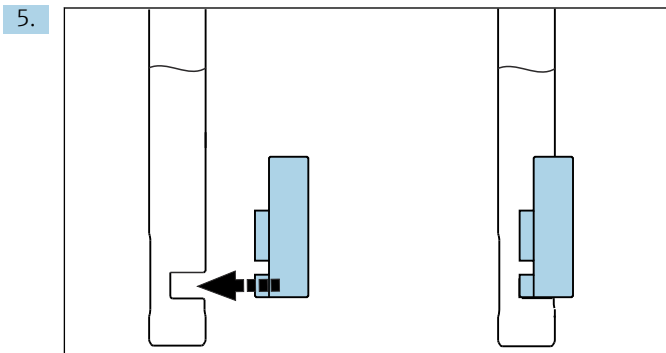

Then fit the calibration filter (2.0 AU) onto the sensor shaft and push it down as far as it will go.

6. → OK.
↳ The measured value for the calibration filter is displayed.

7. Then fit the verification filter (0.35 AU) onto the sensor shaft and push it down as far as it will go.
8. → **OK**.
↳ The measured value for the verification filter is displayed.
9. Remove the filter from the sensor head. → **OK**.
10. If the calibration is valid: → **OK**. An invalid calibration aborts the process and you must repeat all of the steps.
11. **CAL/Photometer/Measurement channel/Optical zero point ▷ Use current raw value as zero point.** → **OK**.

8 Maintenance

Take all the necessary precautions in time to ensure the operational safety and reliability of the entire measuring system.

NOTICE

Effects on process and process control!

- ▶ When carrying out any work on the system, bear in mind any potential impact this could have on the process control system and the process itself.
- ▶ For your own safety, only use genuine accessories. With genuine parts, the function, accuracy and reliability are also ensured after maintenance work.

Cleaning the sensor

If the sensor is dirty, this can influence the measurement results and even cause a malfunction. Therefore the sensor must be cleaned regularly in order to guarantee reliable measurement results. The frequency and intensity of the cleaning process depend on the medium. Clean the sensor:

- before every calibration/adjustment/zero point adjustment
- before you send the sensor in for repair

Fouling	Cleaning
Lime deposits	▶ Immerse the sensor in 1-5 % hydrochloric acid (for a few minutes).
Dirt particles on the optical windows	▶ Fold the cloth and wipe the cell.

NOTICE

Cleaning agent residue

Cleaning agent residue can affect the measurement.

- ▶ Rinse the sensor carefully with water after every cleaning.

9 Repair

9.1 General information

The repair and conversion concept provides for the following:

- The product has a modular design
- Spare parts are grouped into kits which include the associated kit instructions
- Only use original spare parts from the manufacturer
- Repairs are carried out by the manufacturer's Service Department or by trained users
- Certified devices can only be converted to other certified device versions by the manufacturer's Service Department or at the factory
- Observe applicable standards, national regulations, Ex documentation (XA) and certificates

1. Carry out the repair according to the kit instructions.
2. Document the repair and conversion and enter, or have entered, in the Life Cycle Management tool (W@M).

9.2 Spare parts

Device spare parts that are currently available for delivery can be found on the website:

<https://portal.endress.com/webapp/SparePartFinder>

- ▶ Quote the serial number of the device when ordering spare parts.

9.3 Return

The product must be returned if repairs or a factory calibration are required, or if the wrong product was ordered or delivered. As an ISO-certified company and also due to legal regulations, Endress+Hauser is obliged to follow certain procedures when handling any returned products that have been in contact with medium.

To ensure the swift, safe and professional return of the device:

- ▶ Refer to the website www.endress.com/support/return-material for information on the procedure and conditions for returning devices.

9.4 Disposal



If required by the Directive 2012/19/EU on waste electrical and electronic equipment (WEEE), the product is marked with the depicted symbol in order to minimize the disposal of WEEE as unsorted municipal waste. Do not dispose of products bearing this marking as unsorted municipal waste. Instead, return them to the manufacturer for disposal under the applicable conditions.

10 Accessories

The following are the most important accessories available at the time this documentation was issued.

Listed accessories are technically compatible with the product in the instructions.

1. Application-specific restrictions of the product combination are possible.
Ensure conformity of the measuring point to the application. This is the responsibility of the operator of the measuring point.
2. Pay attention to the information in the instructions for all products, particularly the technical data.
3. For accessories not listed here, please contact your Service or Sales Center.

10.1 Assembly

Unifit CPA842

- Installation assembly for food, biotechnology and pharmaceuticals
- With EHEDG and 3A certificate
- Product Configurator on the product page: www.endress.com/cpa842



Technical Information TI00306C

Cleanfit CPA875

- Retractable process assembly for sterile and hygienic applications
- For in-line measurement with standard sensors with 12 mm diameter, e.g. for pH, ORP, oxygen
- Product Configurator on the product page: www.endress.com/cpa875



Technical Information TI01168C

10.2 Calibration

OUSBT66 calibration kit

- 2/0.35 AU
- Order no.: 71128340

11 Technical data

11.1 Input

11.1.1 Measured variable

NIR-absorption

11.1.2 Measuring range

- 0 to 4 AU
- 0 to 8 OD (depending on the optical path length)

11.1.3 Wavelength

880 nm

11.1.4 Optical path length

5, 10 or 20 mm

11.2 Environment

11.2.1 Ambient temperature

0 to 55 °C (32 to 131 °F)

11.2.2 Storage temperature

0 to 70 °C (32 to 160 °F)

11.2.3 Humidity

5 to 95 %

11.2.4 Degree of protection

IP 68, Fischer connector (up to 2 m (6.6 ft) water column for 24 h)

11.3 Process

11.3.1 Process temperature

0 to 90 °C (32 to 194 °F) continuous

Max. 135 °C (275 °F) for 2 hours maximum

11.3.2 Process pressure

Max. 10 bar (150 psi) absolute, at 90 °C (194 °F)

11.4 Mechanical construction

11.4.1 Dimensions

→  9

11.4.2 Weight

Approx. 0.2 kg (0.44 lbs)

11.4.3 Materials

Sensor	Stainless steel 1.4435 (316L)
Window	Sapphire, borosilicate
O-ring	EPDM

11.4.4 Process connections

Pg 13.5

11.4.5 Surface roughness

$R_a < 0.38 \mu\text{m}$

11.4.6 Light source

LED

Index

A

Accessories 16

C

Check

 Connection 12

 Mounting 11

Connection

 Check 12

 Measuring device 11

D

Device description 5

Dimensions 9

Disposal 15

E

Ensuring the degree of protection 12

F

Function check 13

I

Incoming acceptance 6

Intended use 4

L

Lamp voltage 12

M

Measured variable 16

Measuring range 17

Measuring system 8

Mounting

 Check 11

Mounting bracket 9

Mounting requirements 8

Mounting the sensor 10

N

Nameplate 7

O

Operational safety 4

P

Pipe mounting 10

Power supply

 Connecting the measuring device 11

Product identification 7

Product safety 5

R

Requirements for the personnel 4

Return 15

S

Safety

 Operational 4

 Product 5

 Workplace safety 4

Safety instructions 4

Scope of delivery 7

Symbols 3

T

Technical personnel 4

U

Use

 Intended 4

W

Warnings 3

Wavelength 17

Workplace safety 4



71596233

www.addresses.endress.com
