

Safety Instructions

SS2100i-2 TDLAS Gas Analyzer

ATEX/IECEX/UKEX Zone 1

Safety instructions for the SS2100i-2 TDLAS gas analyzer in explosion-hazardous areas



Endress+Hauser 

People for Process Automation

Table of Contents

- 1 Introduction.....4**
- 1.1 How to use this manual 4
- 1.2 Conventions used in this manual 4
- 1.3 Associated documentation 5
- 1.4 Manufacturer’s certificates 5
- 1.5 Manufacturer address..... 5

- 2 General safety 6**
- 2.1 Intended equipment use 6
- 2.2 Warnings and cautions 6
- 2.3 Instructional symbols..... 8
- 2.4 Analyzer technical specifications..... 8
- 2.5 Potential risks affecting personnel 11

- 3 Installation 13**
- 3.1 Lifting/carrying the analyzer 13
- 3.2 Mounting the analyzer 13
- 3.3 Protective chassis ground connections..... 14
- 3.4 Electrical wiring requirements 15
- 3.5 External circuit breaker requirements..... 15
- 3.6 Cable installation 15
- 3.7 Ventilation requirements 16
- 3.8 Inspecting the analyzer..... 16

- 4 Equipment operation 19**
- 4.1 Firmware version 19
- 4.2 Intermittent operation 19
- 4.3 Cleaning and decontaminating the analyzer 19
- 4.4 Exd accessory conditions of use 20

- 5 Maintenance and service 21**
- 5.1 Potentially hazardous substances..... 21
- 5.2 Fuse ratings and characteristics..... 22
- 5.3 Service 26

1 Introduction

Endress+Hauser's SS2100i-2 products are high-speed, diode laser-based extractive analyzers designed for extremely reliable monitoring of very low (trace) to standard concentrations of specific components in various background gases.

This document describes safety instructions for SS2100i-2 TDLAS Gas Analyzer for explosion-hazardous areas classified according to International Electrotechnical Commission (IEC), UK Statutory Instrument SI 2016 No. 1107 (as amended by SI 2019 No. 696-Schedule 3A Part 1) and Directive 2014/34/EU of the European Parliament and of the Council of 26 February 2014 on the harmonization of the laws Member States.

It is important to closely review all information contained in the manuals related to system installation, operation and maintenance, as referenced in section 1.3 → [Associated Documentation](#) to operate the analyzer safely. This manual is divided into the following sections:

- General safety instructions (Chapter 2)
- Equipment installation (Chapter 3)
- Equipment operation (Chapter 4)
- Equipment maintenance and service (Chapter 5)

1.1 How to use this manual

This manual has been written to address the most common safety issues related to the installation and maintenance of the SS2100i-2 analyzer. Additional information has been provided with the analyzer model purchased to instruct qualified users in the installation, operation and maintenance of the equipment.

Images, tables and charts have been included with instruction to provide a visual understanding of the analyzers and its functions. Special symbols are also used to provide the user with key information regarding the system configuration and operation. Users should pay close attention to this information.

1.2 Conventions used in this manual

In addition to the symbols and instructional information, this manual is created with “hot links” to enable the user to quickly navigate between different sections within the manual. These links include table, figure and section references and are identified by a pointing finger cursor  when rolling over the text. Simply click on the link to navigate to the associated reference.

1.3 Associated documentation

Enclosed in your analyzer system order is the product Safety Manual for your reference. Please review all necessary safety instructions before installing or operating your analyzer.

This document is an integral part of the complete document package, which includes:

Part number	Document type	Description
BA02197C	Operating Instructions	A complete overview of the operations required to install, commission, and maintain the device.
TIO1670C	Technical Information	Provides technical data on the device with an overview of associated models available.
GP01177C	Description of Device Parameters	Provides the user with an overview of the FS 5.16 firmware functionality.

Table 1. Associated documentation

For additional instruction manuals, please refer to the following:

- For custom orders, refer to the Endress+Hauser website (<https://endress.com/contact>) for the list of local sales channels to request order-specific documentation. Order-specific documentation is located by analyzer serial number (SN).
- For standard orders, refer to the Endress+Hauser website product page to download the published manuals for the analyzer: www.endress.com

1.4 Manufacturer's certificates

ATEX/UKEX/IECEX Certificate of Conformity:

CML 21 ATEX 11305X / CML 21UKEX11196X / IECEX CML 21.0154X

ATEX	UKEX	IECEX
EN IEC 60079-0:2018	EN IEC 60079-0:2018	IEC 60079-0:2017
EN 60079-1:2014	EN 60079-1:2014	IEC 60079-1:2014-06

Table 2. Manufacturer's certificates

1.5 Manufacturer address

Endress+Hauser
 11027 Arrow Route
 Rancho Cucamonga, CA 91730
 United States
www.endress.com

2 General safety

Each analyzer shipped from the factory includes documentation for the purpose of relaying installing, operating and safety instructions to the responsible party or operator of the equipment. This chapter reviews the general safety instruction for every SS2100i-2 analyzer.

2.1 Intended equipment use

The SS2100i-2 analyzer is intended for use as instructed in the documentation package provided with the equipment. The information provided should be read and referenced by anyone installing, operating or having direct contact with the SS2100i-2 analyzer. Any use of the equipment in a manner not specified by Endress+Hauser could impair the protection provided by the equipment.

2.2 Warnings and cautions

Instructional icons are provided in all equipment manuals and on the SS2100i-2 analyzer to alert the user of potential hazards, important information and valuable tips. Following are the symbols and associated warning and caution types to observe when installing or servicing the analyzer. Some of these symbols are provided for instructional purposes only and are not labeled on the system.

2.2.1 Safety warning label

The warning label shown below will be affixed to the front side of all analyzer enclosures that contain sample gas.



Hazards may vary by stream composition. One or more of the following conditions may apply.



Flammable. Gases used in the processing of this analyzer may be extremely flammable. Any work in a hazardous area must be carefully controlled to avoid creating any possible ignition sources (e.g., heat, arcing, sparking, etc.).



Toxins. Endress+Hauser analyzers measure a variety of gases, including high-level H₂S. Follow all safety protocols governing toxic gases and potential leaks.



Inhalation. Inhaling toxic gases or fumes may cause physical damage or death.

⚠ CAUTION

- ▶ Technicians are expected to follow all safety protocols established by the customer that are necessary for servicing or operating the analyzer. This may include, but is not limited to, lockout/tag-out procedures, toxic gas monitoring protocols, personal protective equipment (PPE) requirements, hot work permits and other precautions that address safety concerns related to performing service or operation on process equipment located in hazardous areas.

2.2.2 Equipment labels







Equipment label	Meaning
	Warning statement for hazardous voltage. Contact may cause electric shock or burn. Turn off and lock out system before servicing.
	Failure to follow all directions may result in damage or malfunction of the analyzer.
	CLASS 1 LASER PRODUCT - Invisible laser radiation when open. Avoid direct exposure to the beam.
	INVISIBLE LASER RADIATION - Avoid exposure to beam. Class 3b Radiation Product. Refer servicing to the manufacturer-qualified personnel.
	Maximum voltage and current specifications for fuses.
	PROTECTIVE EARTH GROUND. Symbol indicates the connection point of the ground wire from the main power source.
	Cleaning warning to avoid potential electrostatic charge hazard.

Table 3. Equipment labels

2.3 Instructional symbols

Structure of Information	Meaning
<p>⚠ WARNING</p> <p>Causes (/consequences) Consequences of non-compliance (if applicable) ▶ Corrective action</p>	<p>This symbol alerts you to a dangerous situation. Failure to avoid the dangerous situation can result in a fatal or serious injury.</p>
<p>⚠ CAUTION</p> <p>Causes (/consequences) Consequences of non-compliance (if applicable) ▶ Corrective action</p>	<p>This symbol alerts you to a dangerous situation. Failure to avoid this situation can result in minor or more serious injuries.</p>
<p>NOTICE</p> <p>Cause/situation Consequences of non-compliance (if applicable) ▶ Action/note</p>	<p>This symbol alerts you to situations which may result in damage to property.</p>

Table 4. Warnings

2.4 Analyzer technical specifications

Technical specifications are provided in the following tables that outline recommended equipment settings, ratings, and physical specifications.

Peripheral devices

For systems equipped with peripheral devices, e.g., probe assemblies, the documentation indicates that only devices that meet with the manufacturer's specifications may be used.

Equipment rating

The following equipment rating information is provided for the SS2100i-2 in the table below. This information includes, but is not limited to, the following:

- Supply voltage, power and current rating
- Description of all input connections
- Environmental conditions for which the equipment is designed (i.e., environmental temperature range, environmental relative humidity)
- Degree of ingress protection (IP)

Performance	
Concentration	See analyzer calibration report
Repeatability	See analyzer calibration report
Measurement time	Typically less than 20 seconds
Application data	
Environmental temperature range	Standard: -20 °C to 50 °C (-4 °F to 122 °F) Optional: -10 °C to 60 °C (14 °F to 140 °F)
Heated enclosure temperature	Standard: 50 ±5 °C Optional: 60 ±5 °C
Environmental relative humidity	5 % to 95 %, non-condensing
Altitude	Up to 2000 m
Sample cell operating pressure	Standard: Typically 800 to 1200 mbar Optional: 950 to 1700 mbar
Pressure to cell	70 kPaG (10 PSIG) max to spectrometer cell
Sample flow rate	0.5 to 4 SLPM (0.02 to 0.1 SCFM) ¹
Contaminant sensitivity	None for gas phase glycol, methanol, amines, or mercaptans

¹ Application dependent.

Electrical and communications		
Input voltages, maximum ¹	120 or 240 VAC tolerance $\pm 10\%$ 50/60 Hz, 300W ² UM = 264 VAC	
Output type	Modbus RS485 or Modbus Ethernet/IP	UN = 30 VDC UM = 250 VAC N = nominal, M = maximum
Output type	Relay output	UN = AC: 15-250V, 3A N.O. Contact; 1.5A N.C. Contact DC: 13-24V, 1A N.O. Contact; 1A N.C. Contact UM = 250 VAC
	Current 4-20mA Input/Output	UN = 30 VDC UM = 250 VAC
	Ethernet	UN = 3.3 VDC
Communications	Analog: Isolated Analog channels, 1200 ohms at 24 VDC max Outputs: Qty (2) 4-20 mA (measurement value) Input: Qty (1) 4-20 mA (pipeline pressure) ² Serial: Ethernet and RS-485 half-duplex, standard RS-232C, optional	
Digital signals	Outputs: (5); Hi/Lo Alarm, General Fault, Validation Fail ² , Validation 1 Active ² , Validation 2 Active ² Inputs: (2); Flow Alarm ² , Validation Request ²	
Protocol	Modbus Gould RTU, Daniel RTU or ASCII	
Diagnostic value examples	Detector power (optics health), spectrum reference comparison and peak tracking (spectrum quality), cell pressure and temperature (overall system health)	
LCD display	Concentration, cell pressure, cell temperature and diagnostics	

¹ Supply voltage not to exceed $\pm 10\%$ of nominal. Transient over-voltages according to Overvoltage category II.

² Application dependent

Physical specifications	
Electronics enclosure	IP66 copper-free aluminum with marine environment RAL7001 gray aliphatic polyurethane finish; approximately 200 µm final thickness
Size ¹	670H ´ 1122W ´ 248D mm
Weight ²	Approximately 145 kg (320 lbs.)
Sample cell construction	316L series polished stainless steel standard
Number of sample cells	1 per analyzer
Area classification	
Analyzer (electronics and laser)	ATEX / UKEX / IECEx  II 2 G Ex db IIB+H2 T4 Gb -20 °C ≤ Tamb ≤ +60 °C CML 21 ATEX 11305X ³ ; CML 21UKEX 11196X ³ ; IECEx CML 21.0154X ³ CE, UKCA

Table 5. Analyzer technical specifications

2.5 Potential risks affecting personnel

This section addresses the appropriate actions to undertake when faced with hazardous situations during or before service of the analyzer. It is not possible to list all potential hazards within this document. The user is responsible for identifying and mitigating any potential hazards present when servicing the analyzer.

CAUTION

Technicians are expected to follow all safety protocols established by the customer that are necessary for servicing the analyzer.

- ▶ This may include, but is not limited to, lockout/tagout procedures, toxic gas monitoring protocols, personal protective equipment (PPE) requirements, hot work permits and other precautions that address safety concerns related to performing service on process equipment located in hazardous areas.

¹ Dimensions are for analyzer only. Consult system drawings for analyzers with sample conditioning systems.

² Application dependent

³ Including an "X" after the certificate number indicates that the product is subject to the Special Conditions of Use specified in the schedule to this certificate. Refer to the Special Conditions of Use under the relevant certification prior to installation or use.

Personnel responsibility

NOTICE

- ▶ The safety of the analyzer is the responsibility of the installer and the organization he/she represents.

Operatives/technicians shall possess, to the extent necessary to perform their tasks, the following:

- Understanding of the general principles of explosion protection
- Understanding of those aspects of equipment design that affect the protection concept
- Understanding of the certificate contents and relevant parts of the standard associated with the product
- General understanding of inspection and maintenance requirements of IEC 60079-17
- Familiarity with the particular techniques to be employed in the selection and installation of equipment in the standard
- Understanding of the additional importance of permit to work systems and safe isolation in relation to explosion protection

Mitigating Risks

Refer to the instructions for each situation listed below to mitigate associated risks.

2.5.1 Electrocutation hazard

1. Shut off power at the main disconnect external to the analyzer.

⚠ CAUTION

- ▶ Complete this action before performing any service that requires working near the main input power or disconnecting any wiring or other electrical components.

2. Open enclosure door.

If service must be performed with power engaged:

1. Note any live electrical components and avoid any contact with them.
2. Only use tools with a safety rating for protection against accidental contact with voltage up to 1000V (IEC 900, ASTF-F1505-04, VDE 0682/201).

2.5.2 Explosion hazard

Any work in a hazardous area must be carefully controlled to avoid creating any possible ignition sources (e.g., heat, arcing, sparking, etc.). All tools must be appropriate for the area and hazards present. Electrical connections must not be made or broken with power on (to avoid arcing).

2.5.3 Electrostatic discharge

The coating and the adhesive label is non-conducting and may generate an ignition capable level of electrostatic discharge under certain extreme conditions. The user should ensure that the equipment is not installed in a location where it may be subjected to external conditions, such as high pressure steam, which may cause a build-up of electrostatic charges on non-conducting surfaces. To clean the equipment, use only a damp cloth.

3 Installation

The information in this chapter is related to safety during the equipment installation.

CAUTION

- ▶ When an “X” is included after the certificate number, it indicates that the product is subject to the Special Conditions of Use specified in the schedule to this certificate. For certification listings, see [Manufacturer's Certificates →](#) . The entries into the analyzer enclosure can be equipped with certified accessories (e.g., blanking element, breather/drain, reducer, etc.) according to the intended use of the product.

3.1 Lifting/carrying the analyzer

The SS2100i-2 is bolted on a Unistrut (or equivalent) metal frame in the factory. Due to the analyzer's size and weight (approximately 145 Kg [320 lbs], without sample conditioning system) the use of a forklift, pallet jack, etc. to lift or move the analyzer is recommended.

Before removing from the crate, move the analyzer as close as possible to the final installation location. Always carry the load using the lifting eyes (refer to [Figure 1 →](#)  and the drawings included with the purchased SS2100i-2 analyzer).

CAUTION

- ▶ Ensure all equipment used for lifting/moving the analyzer is rated for the maximum weight load.

3.2 Mounting the analyzer

Mounting dimensions are provided in the layout diagrams for the purchased SS2100i-2 analyzer, which can be found in the [Operating Instructions →](#)  or in the system as-built drawings.

CAUTION

- ▶ Endress+Hauser analyzers are designed for operation within the specified ambient temperature range. Intense sun exposure in some areas may cause the analyzer temperature to exceed the maximum.
- ▶ When mounting the analyzer, be sure to position the instrument so that it is not difficult to operate adjacent devices. Allow 3 feet (1 meter) of room in front of the analyzer and any switches.
- ▶ Bolts or screws used for wall mounting the SS2100i-2 must be able to support four times the weight of the instrument (approximately 145 kg [320 lbs] without sample conditioning system).
- ▶ It is critical to mount the analyzer so that the supply and return lines reach the supply and return connections on the chassis, while still maintaining flexibility, so that the sample lines are not under excessive stress.

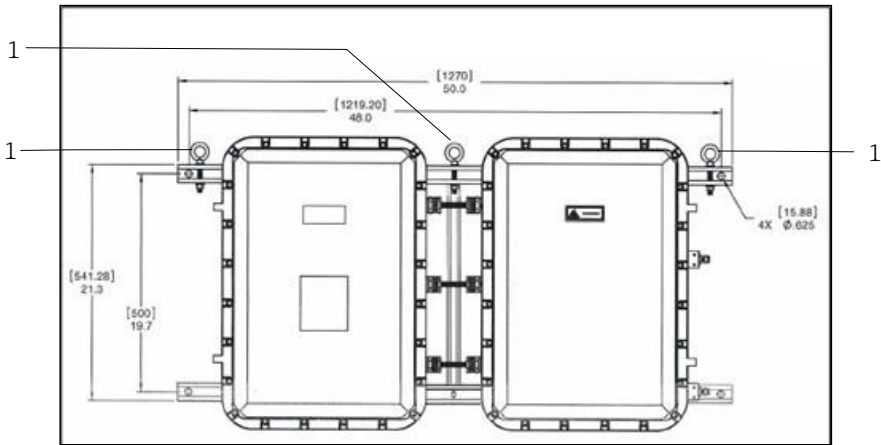

A0051927

Figure 1. SS2100i-2 mounting and dimensions with lifting eyes (1)

The SS2100i-2 is intended to be mounted to a wall or secured upright frame. Secure the analyzer frame in position using bolts or screws of the size indicated in the figure above.

3.3 Protective chassis ground connections



Before connecting any electrical signal or power, the chassis grounds must be connected. Safety requirements for the protective and chassis grounds are as follows:

- The protective and chassis grounds must be of equal or greater size than any other current-carrying conductors, including the heater located in the sample conditioning system.
- The protective and chassis grounds must remain connected until all other wiring is removed.
- If the protective and chassis ground is insulated, it must use the green/yellow color.

CAUTION

- ▶ Failure to properly ground the analyzer may create a high-voltage shock hazard.

Refer to system drawings for exact locations of the chassis ground connections.

1. Connect the chassis ground to the marked bottom right corner of the right-side enclosure.
2. Connect the chassis ground to the marked top left corner of the left-side enclosure.
3. Connect the system ground to the ground bus bar as shown in [Figure 3](#) →  during the electrical power connection. The SS2100i-2 Operating Instructions listed in [Associated Documentation](#) →  gives more information.

3.4 Electrical wiring requirements

Interconnection of the analyzer enclosure and cell enclosure shall be accomplished using wiring methods described in the Standard IEC/EN 60079-0 and IEC/EN 60079-14. The installer is responsible for complying with all local installation codes.

3.5 External circuit breaker requirements

An approved switch or circuit breaker rated for 15 amps should be used and clearly marked as the disconnecting device for the analyzer. The OFF switch should consider isolation of all circuit power supply conductors, including the neutral. The switch or circuit breaker shall not interrupt a protective earth conductor.

Because the breaker in the customer-provided power distribution panel or switch will be the primary means of disconnecting the power from the analyzer, the isolating device should be located in close proximity to the equipment and within easy reach of the operator.

The switch or circuit breaker employed as a disconnecting device shall meet the relevant requirements of IEC 60947-1 and IEC 60947-3 and be suitable for the application.

3.6 Cable installation

To avoid potential damage, cable systems and accessories should be installed, so far as is practicable, in positions that will prevent them from being exposed to mechanical damage, to corrosion or chemical influences, to the effects of heat and to UV radiation. If cables are subject to other conditions, e.g., vibrations or continuous flexing, they shall be designed to withstand that condition without damage.

When cables are secured to equipment or cable trays, the bend radius on the cable should be in compliance with the cable manufacturer's data, or be at least eight (8) times the cable diameter to prevent damage to the cable. The bend radius of the cable should start at least 25 mm from the end of the cable gland.

The hazardous area end of each core in multi-core cables shall either be connected to earth or be adequately insulated by means of terminations suitable for the type of protection.

CAUTION

- ▶ Insulation of multi-core cables by tape alone is not permitted.

3.6.1 Terminations

Connections shall be made in a manner consistent with the type of terminal, type of protection and not introduce undue stress on the connections.

If multi-stranded and, in particular, fine-stranded conductors are employed, the ends shall be protected against separation of the strands, e.g., by means of cable lugs, core-end sleeves or by the type of terminal, but not by soldering alone.

NOTICE

- ▶ The creepage distances and clearances shall not be reduced by the method in which the conductors are connected to the terminals.

3.6.2 Cable glands

⚠ CAUTION

- ▶ Certified compound barrier seal type glands and cables shall be used where appropriate in compliance with local regulations.

The cable gland shall be selected to match the cable diameter. The use of sealing tape, heat-shrink tube or other materials are not permitted to make the cable fit to the cable gland.

If an Ex “d” gland clamping by the sealing ring (compression) is used with braided or armored cable, it shall be the type where the braid or armor is terminated in the gland and compression takes place on the inner cable sheath.

⚠ CAUTION

- ▶ For flameproof enclosures, adapters shall not be used together with blanking elements.

Flameproof cable glands, adapters or blanking elements, having parallel threads may be fitted with a sealing washer between the entry device and the flameproof enclosure provided that the applicable thread engagement is still achieved after the washer has been fitted. Thread engagement shall be at least five (5) full threads. Suitable grease may be used as long as it is non-setting, non-metallic and non-combustible and any earthing between the device and the flameproof enclosure is maintained. Using STL8 screw thread lubricant or equivalent on all screw thread and its taped opening is recommended. The lubricant application procedure can be found in the [Operating Instructions](#) → .

NOTICE

- ▶ Do not use this lubricant on exposed current-carrying parts.

Unused cable entries shall be sealed with a flameproof blanking element, which shall be fitted directly to the hole (no threaded adapter shall be used), and shall comply with thread engagement requirements detailed above and shall be secured against loosening.

3.7 Ventilation requirements

Instruction for connecting ventilation to the SS2100i-2 analyzer is provided in the system drawings that accompany the equipment.

3.8 Inspecting the analyzer

There are three grades of inspection; visual, close and detailed. Visual and close inspections can be performed with the analyzer energized. Detailed inspections generally require the equipment to be isolated. It is recommended that, at a minimum, a visual inspection to be performed after installation to reinforce understanding that the product is installed to manufacturer specifications and to the appropriate standards.

The visual inspection should not be expected to reveal faults of a random nature, such as loose connections, but should be performed to monitor the effect of environmental conditions. Some key considerations include:

- Extremely low or high temperatures
- Pressure conditions

- Corrosive atmosphere
- Vibration, mechanical impacts, friction or abrasion
- Wind
- Painting processes
- Solar radiation
- Chemicals
- Water and moisture
- Dust and dirt
- Plants, animals, insects

The corrosion of metal, or influences of chemicals on plastic or elastomeric components, may affect the type and degree of ingress protection of the equipment. If the enclosure materials begin to exhibit signs of a corrosion, notify the responsible parties so that the enclosure can be treated with the appropriate protective coating as a corrosive protection.

If the equipment is subject to vibration, notify the responsible party so that special care can be taken to ensure that all bolts and cable entries remain tight.

3.8.1 Flameproof enclosure: protection type “d”

When reassembling or working on the flameproof enclosure, perform a thorough visual inspection to confirm all joints are cleaned. They may be lightly smeared with a suitable grease (e.g., Silicon Grease GS9) to prevent corrosion and to assist weather-proofing.

NOTICE

- ▶ Only non-metallic scrapers and non-corrosive cleaning fluids may be used to clean flanges.

Bolts, screws, and similar parts, depending on the type of protection required, shall only be replaced by similar parts in accordance with the manufacturer’s design, shown in the inspection schedule below.

Items to Check	Description	Ex “d”	Ex “e”	Ex “n”
	General (All Equipment)	Grade of Inspection		
1	Equipment is appropriate to the EPL/zone requirements of the location	X	X	X
2	Equipment group is correct	X	X	X
3	Equipment temperature class is correct (only for gas)	X	X	X
4	Degree of protection (IP grade) of equipment is appropriate for the level of protection/group/conductivity	X	X	X
5	Enclosure, glass parts and glass-to-metal sealing gaskets or compounds are satisfactory	X	X	X
6	There is no damage or unauthorized modification	X	X	X

Items to Check	Description	Ex “d”	Ex “e”	Ex “n”
7	Bolts, cable entry devices (direct and indirect) and blanking elements are of the correct type and are complete and tight; physical check	X	X	X
8	Joint surfaces are clean and undamaged. Gaskets, if any, are satisfactory and positioned correctly	X		
9	Condition of enclosure gaskets are satisfactory	X	X	X
10	There is no evidence of ingress of water or dust in the enclosure in accordance with IP rating	X	X	X
11	Electrical connections are tight		X	X
12	Unused terminals are tightened		X	X
13	Enclosed-break and hermetically sealed devices are undamaged			X
14	Encapsulated components are undamaged		X	X
15	Breathing and draining devices are satisfactory	X	X	X
16	There is no obvious damage to cables	X	X	X
17	Sealing of trunking, ducts, pipes or conduits is satisfactory	X	X	X
18	Stopping boxes and cable boxes are correctly filled	X		
19	Earthing connections, including any supplementary earthing bonding connections, are satisfactory (for example, connections are tight, and conductors are of sufficient cross-section); physical check	X	X	X
20	Cables not in use are correctly terminated	X	X	X
21	Obstructions adjacent to flameproof flanged joints are in accordance with the standard	X		
22	Equipment is adequately protected against corrosion, weather, vibration, and other adverse factors	X	X	X
23	No undue accumulation of dust and dirt	X	X	X
24	Electrical insulation is clean and dry		X	X

4 Equipment operation

4.1 Firmware version

Each Endress+Hauser analyzer operates based on its own version of firmware. The firmware version for each analyzer is listed in the system calibration report, and displays upon start-up of the analyzer. The Description of Device Parameters can be found on the Endress+Hauser website (www.endress.com).

4.2 Intermittent operation

If the analyzer is to be stored or shut down for a period of time, follow the instructions for isolating the measurement cell and sample conditioning system (SCS) in the SCS Operating Instructions.

4.3 Cleaning and decontaminating the analyzer

If the analyzer has been installed and/or operated (even for purposes of a demonstration), the system should be decontaminated (purged with an inert gas) before powering down the analyzer.

CAUTION

Process samples may contain hazardous material in potentially flammable and/or toxic concentrations.

- ▶ Personnel should have a thorough knowledge and understanding of the physical properties of the sample and prescribed safety precautions before installing, operating or maintaining the analyzer.

Cleaning and decontaminating the analyzer for shipment or storage

1. Shut off the process gas flow.
2. Allow all residual gas to dissipate from the lines.
3. Connect a purge supply (N_2), regulated to the specified sample supply pressure, to the sample supply port.
4. Confirm that any valves controlling the sample flow effluent to the low pressure flare or atmospheric vent are open.
5. Turn on the purge supply and purge the system to clear any residual process gases. For differential systems, make sure to purge the scrubber/dryer for several dry cycles. If necessary, dry cycles can be initiated by pressing the # key followed by the 2 key to enter **Mode 2** and then pressing the # key followed by the 1 key to return to **Mode 1**.
6. Turn off the purge supply.
7. Allow all residual gas to dissipate from the lines.
8. Close any valves controlling the sample flow effluent to the low pressure flare or atmospheric vent.
9. Disconnect power to the system.
10. Disconnect all tubing and signal connections.

11. Cap all inlets, outlets, vents, conduit or gland openings (to prevent foreign material such as dust or water from entering the system) using the original fittings supplied as part of the packaging from the factory.

4.4 Exd accessory conditions of use

All accessories listed in the table below shall comply with the latest IEC/EN 60079-0 and IEC/EN 60079-1.

Accessory Type	Rating	Notes
Stopper plug	Exd, Zone 1	<ol style="list-style-type: none"> 1. Stopping plugs shall be assembled in such a way that their protrusion from an associated enclosure is not increased. 2. Installer must ensure the stopping plug ingress protection matches the ingress protection rating of the associated enclosure, IP66.
Reducer/adapter	Exd, Zone 1	<ol style="list-style-type: none"> 1. Adapter/reducers shall be assembled in such a way that their protrusion from an associated enclosure is not increased. 2. Installer must ensure the stopping plug ingress matches the ingress protection of the rating of the associated enclosure, IP66. 3. For direct entry Exd applications, only one adapter/reducer shall be used per cable entry. 4. The female connection thread of a Thread Conversion Adapter shall “step” not more than two “sizes” up in the case of a thread gender change.
Breather/drainer	Exd, Zone 1	<ol style="list-style-type: none"> 1. The breather/drainer shall be suitable for bottom entry application only. 2. It is the user’s responsibility to ensure that the ingress protection level of an associated enclosure is maintained at the interface, IP66. 3. Breather/drainer specified shall meet the following requirements: <ul style="list-style-type: none"> • Exd enclosures with an internal volume $75 \text{ L} \leq V \leq 175 \text{ L}$ • Exd enclosure reference pressure 40 bar maximum.
Cable gland(s)	Exd, Zone 1	<ol style="list-style-type: none"> 1. Compound barrier cable glands shall be specified for use with our analyzer Exd enclosure. 2. Compound barrier cable glands shall carry a minimum IP66 ingress protection level.

5 Maintenance and service

This chapter provides safety information related to maintenance and service of the SS2100i-2 analyzer. Below is an outline of the SS2100i-2 analyzer configuration. The components for the electronics enclosure are detailed in [Figure 3](#) → .

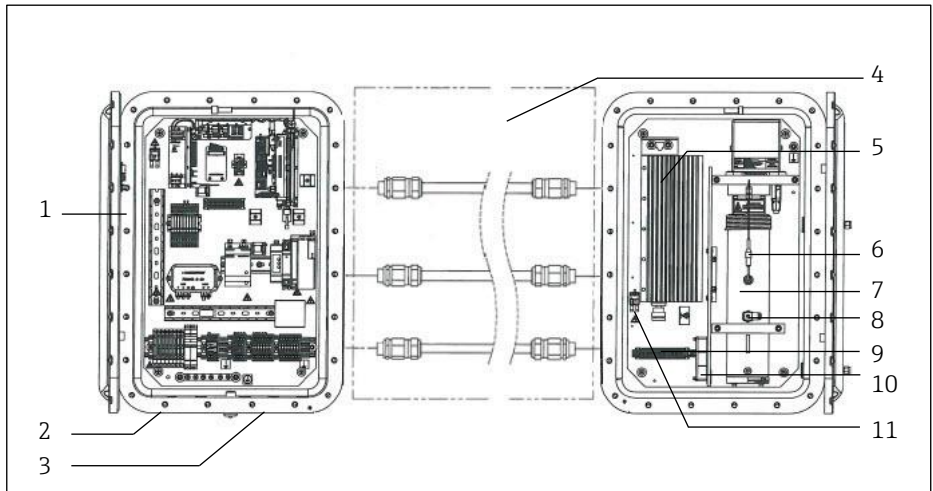

A0051928

Figure 2. Analyzer component overview

- | | |
|------------------------------|--------------------|
| 1. Electronics enclosure | 7. Sample cell |
| 2. Power Input M20x1.5 Qty.1 | 8. Pressure sensor |
| 3. Signal I/O M25x1.5, Qty.4 | 9. Terminal blocks |
| 4. Cable assembly | 10. Fan |
| 5. Heater | 11. Thermostat |
| 6. Temperature thermistor | |

5.1 Potentially hazardous substances

The SS2100i-2 analyzers may be provided with a scrubber and scrubber indicator. See below for proper disposal of these items.

5.1.1 Disposal of hazardous substances

For an analyzer equipped with H₂S scrubbers, discard used scrubber and scrubber indicator in an appropriate leak-proof receptacle for safe disposal of old components.

CAUTION

- ▶ Depleted H₂S scrubbers and scrubber indicators contain predominantly Copper (II) Sulfide [CAS# 1317-40-4] with some remaining Copper (II) Oxide [CAS# 1317-38-0] and basic cupric carbonate [CAS# 12069-69-1], each of which are odorless dark powders that require few special precautions other than avoiding contact with the



internal substances, keeping the scrubber tightly sealed, and protecting the contents against humidity.

5.2 Fuse ratings and characteristics

WARNING

- ▶ Hazardous voltage and risk of electric shock. Turn off and lock out system power before opening the electronics enclosure and making any connections.
- ▶ If you need to replace a fuse, use only the same type and rating of fuse as the original. Refer also to specifications listed in the tables below.

For an illustration of the fuse location in the electronics assembly, see [Figure 3](#) → .

Fuse specifications for 240 VAC systems			
	DWG Ref.	Description	Rating
	F3	Miniature Fuse, 5 x 20 mm, Time Delay	250 VAC/1.6 A
	F4 ¹	Miniature Fuse, 5 x 20 mm, Time Delay	250 VAC/0.5 A
	F5 ¹ , F6 ¹ , F7 ¹ , F8 ¹	Miniature Fuse, 5 x 20 mm, Time Delay	250 VAC/0.1 A
	F9 ¹	Miniature Fuse, 5 x 20 mm, Time Delay	250 VAC/1.0A
	F10 ¹	Miniature Fuse, 5 x 20 mm, Time Delay	250 VAC/1.2 A
Fuse specifications for 120 VAC systems			
	DWG Ref.	Description	Rating
	F3	Miniature Fuse, 5 x 20 mm, Time Delay	250 VAC/1.6 A
	F4 ¹	Miniature Fuse, 5 x 20 mm, Time Delay	250 VAC/0.5 A
	F5 ¹ , F6 ¹ , F7 ¹ , F8 ¹	Miniature Fuse, 5 x 20 mm, Time Delay	250 VAC/0.1 A
	F9 ¹	Miniature Fuse, 5 x 20 mm, Time Delay	250 VAC/1.0 A
	F10 ¹	Miniature Fuse, 5 x 20 mm, Time Delay	250 VAC/2.0 A

¹ Housed in fuse terminal blocks. Illuminated LED indicates blown fuse.

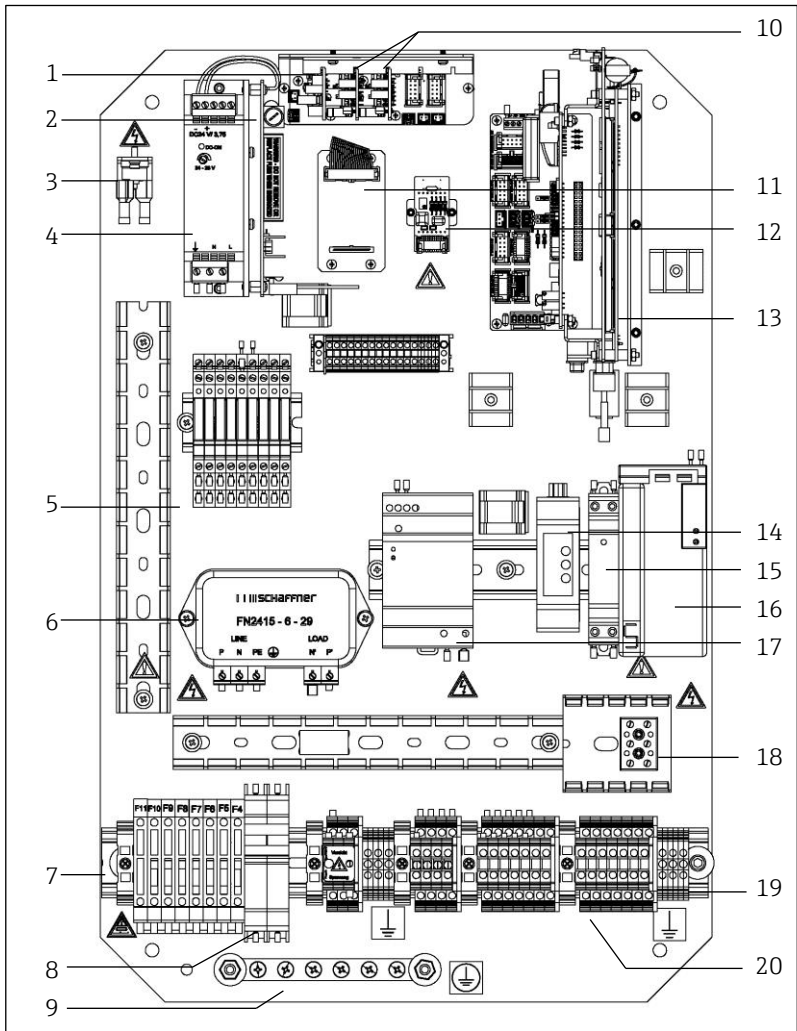

A0051929

Figure 3. Components in electronics enclosure

- | | |
|--|--|
| <ol style="list-style-type: none"> 1. 4-20mA AI board 2. Fuse (F3) 3. High temperature limit thermostat 4. Analyzer power supply 5. Relays 6. AC line filter 7. Fuses (F4-F10) 8. Main circuit breaker 9. Ground bus bar 10. 4-20mA AO board | <ol style="list-style-type: none"> 11. Relay control board 12. Temperature control board 13. ARM9 control electronics 14. RS-232 to RS-422/485 converter 15. Solid-state relay 16. Temperature controller 17. Auxiliary power supply 18. AC terminal block for sample cell heater 19. Ground terminal blocks 20. Terminal blocks |
|--|--|

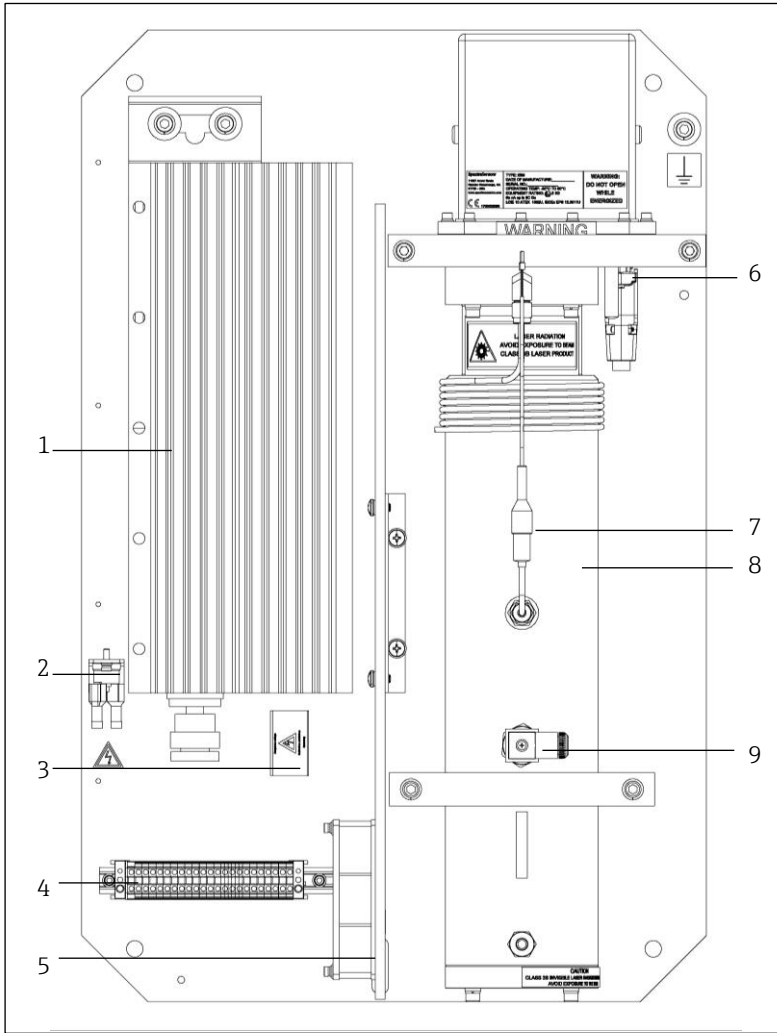
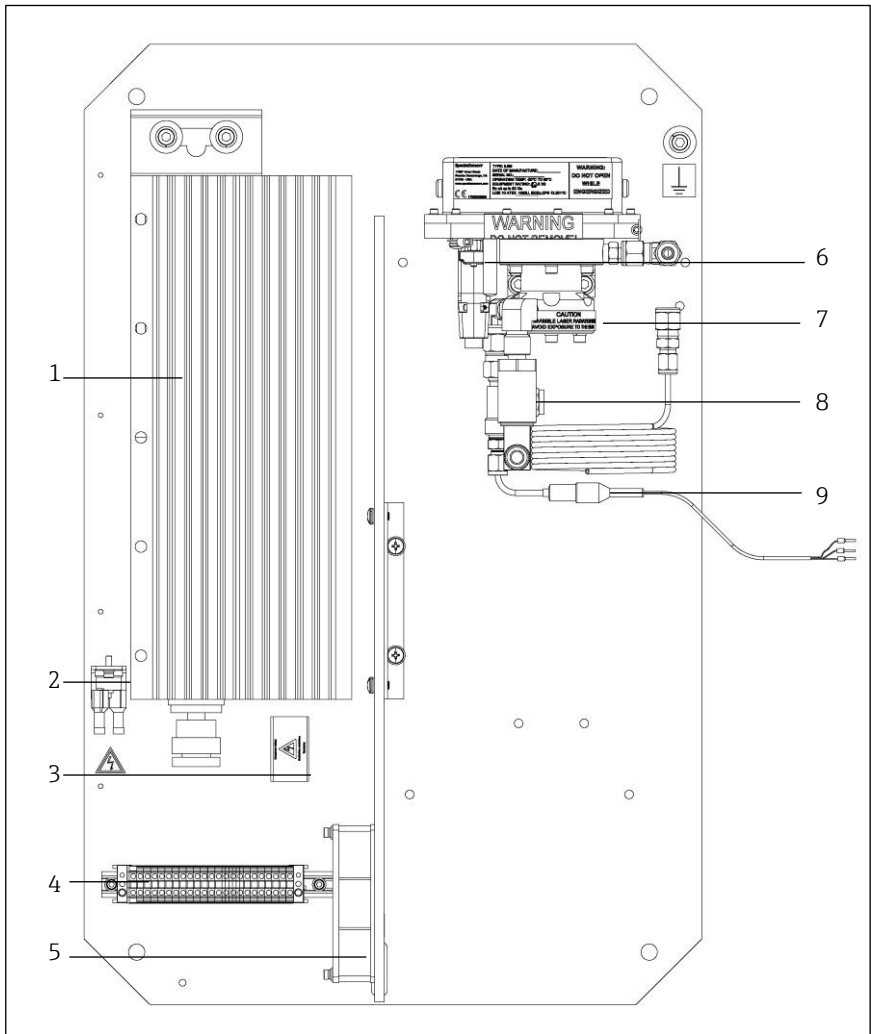

Figure 4. Components on sample cell panel assembly (8/28 m sample cell)

- | | |
|---|---|
| <ul style="list-style-type: none"> 1. Heater 2. High temp. limit thermostat set at 70 °C 3. AC terminal block for heater 4. Terminal blocks 5. Fan | <ul style="list-style-type: none"> 6. Transition plate thermistor 7. Sample temperature thermistor 8. Measurement cell 9. Pressure sensor |
|---|---|



A0051938

Figure 5. Components on sample cell panel assembly (0.1 m sample cell)

- | | |
|---|----------------------------------|
| 1. Heater | 6. Transition plate thermistor |
| 2. High temp. limit thermostat set at 70 °C | 7. Measurement cell |
| 3. AC terminal block for heater | 8. Pressure sensor |
| 4. Terminal blocks | 9. Sample temperature thermistor |
| 5. Fan | |

5.3 Service

For Service, refer to our website (<https://www.endress.com/contact>) for the list of local sales channels in your area.

www.addresses.endress.com
