

Brief Operating Instructions JT33 TDLAS gas analyzer



Endress + Hauser



People for Process Automation

Table of Contents

1	About this document	5
1.1	Symbols.....	5
1.2	Associated documentation	6
1.3	U.S. export compliance	6
1.4	Registered trademarks	6
1.5	Manufacturer address	7
2	Basic safety.....	8
2.1	Personnel qualifications.....	8
2.2	Potential risks affecting personnel	9
2.3	Product safety.....	9
2.4	Device-specific IT security.....	12
3	Product description.....	14
3.1	JT33 TDLAS gas analyzer system	14
3.2	Sample conditioning system.....	16
3.3	Symbols on the equipment	16
4	Installation	18
4.1	Installing the heat trace boot	18
4.2	Lifting and moving the analyzer	19
4.3	Mounting the analyzer	20
4.4	Turning the display module.....	25
5	Electrical connection.....	26
5.1	Connection conditions	26
5.2	Connecting the measuring device	33
5.3	Gas connections	42
5.4	Metric conversion kit	44
5.5	Hardware settings	45
5.6	Ensuring IP66 degree of protection	45
6	Operation options.....	46
6.1	Overview of operation options	46
6.2	Structure and function of the operating menu	47
6.3	Accessing the operating menu through the local display	48
6.4	Operating elements.....	54
6.5	Access the operating menu from the web browser	56
6.6	Remote operation using Modbus	56
7	Commissioning.....	57
7.1	Language.....	57



7.2	Configuring the measuring device	57
7.3	Protecting settings from unauthorized access	58
8	Diagnostic information	59
8.1	Diagnostic information from light-emitting diodes.....	59
8.2	Diagnostic information on local display	60
8.3	Diagnostic information in the web browser	64
8.4	Diagnostic information through the communication interface	64
8.5	Overview of diagnostic information	64
8.6	General troubleshooting	65

1 About this document



These instructions are Brief Operating Instructions; they do not replace the Operating Instructions included in the scope of supply.

1.1 Symbols



1.1.1 Alerts

Structure of Information	Meaning
 WARNING Causes (/consequences) Consequences of noncompliance (if applicable) ▶ Corrective action	This symbol alerts you to a dangerous situation. Failure to avoid the dangerous situation can result in a fatal or serious injury.
 CAUTION Causes (/consequences) Consequences of noncompliance (if applicable) ▶ Corrective action	This symbol alerts you to a dangerous situation. Failure to avoid this situation can result in minor or more serious injuries.
NOTICE Cause/situation Consequences of noncompliance (if applicable) ▶ Action/note	This symbol alerts you to situations which may result in damage to property.

1.1.2 Safety symbols

Symbol	Description
	The High Voltage symbol that alerts people to the presence of electric potential large enough to cause injury or damage. In certain industries, high voltage refers to voltage above a certain threshold. Equipment and conductors that carry high voltage warrant special safety requirements and procedures.
	The Laser Radiation symbol is used to alert the user to the danger of exposure to hazardous visible laser radiation when using the system. The laser is a class 3R radiation product.
	The Ex mark signals to Authorities Having Jurisdiction and end-users in Europe that the product complies with the essential ATEX Directive for explosion protection.

1.1.1 Informational symbols

Symbol	Meaning
	Tip: Indicates additional information
	Reference to page

1.2 Associated documentation

Each analyzer shipped from the factory is packaged with documents for the model that was purchased. All documentation is available on the USB flash drive provided with the shipment. This document is an integral part of the document package, which includes:

Part number	Document type	Description
BA02297C	Operating Instructions	A complete overview of the operations required to install, commission, and maintain the device
TI01722C	Technical Information	Technical data for the device with an overview of associated models available
XA03137C	Safety Instructions	Requirements for installing or operating the analyzer as it relates to personnel or equipment safety
GP01198C	Description of device parameters	Reference for parameters, providing a detailed explanation of each individual parameter of the operating menu
SD02192C	Special Documentation Heartbeat Technology	Reference for using the Heartbeat Technology function integrated in the measuring device
SD03032C	Special Documentation Web server	Reference for using the web server integrated in the measuring device
EX3100000056	Control drawing	Drawings and requirements for JT33 field interface connections

For additional instruction manuals, refer to the Endress+Hauser website to download the published documentation: www.endress.com.

1.3 U.S. export compliance

The policy of Endress+Hauser is in strict compliance with U.S. export control laws as detailed on the website of the [Bureau of Industry and Security](https://www.bis.gov/) at the U.S. Department of Commerce.

1.4 Registered trademarks

Modbus®

Registered trademark of SCHNEIDER AUTOMATION, INC.

1.5 Manufacturer address

Endress+Hauser
11027 Arrow Route
Rancho Cucamonga, CA 91730
United States
www.endress.com

2 Basic safety

Each analyzer shipped from the factory includes safety instructions and documentation to the responsible party or operator of the equipment for the purpose of installation and maintenance.

WARNING

Technicians are expected to be trained and to follow all safety protocols, established by the customer in accordance with the area hazard classification, to service or operate the analyzer.

- ▶ This may include but is not limited to toxic and flammable gas monitoring protocols, lockout/tagout procedures, personal protective equipment (PPE) requirements, hot work permits, and other precautions that address safety concerns related to the use and operation of process equipment located in hazardous areas.

2.1 Personnel qualifications

Personnel must shall the following conditions for mounting, electrical installation, commissioning, and maintenance of the device. This includes but is not limited to:

- Suitably qualified for their role and the tasks they perform
- Understand the general principles and types of protection and markings
- Understand the aspects of equipment design which affect the protection concept
- Understand the content of certificates and relevant parts of IEC 60079-14
- General understanding of inspection and maintenance requirements of IEC 60079-17
- Familiar with the techniques used in the selection and installation of equipment referenced in IEC 60079-14
- Understand the additional importance of permit to work systems and safe isolation in relation to explosion protection
- Familiar with national and local regulations and guidelines, such as ATEX/IECEx/UKEX and cCSAus
- Familiar with lockout/tagout procedures, toxic gas monitoring protocols, and personal protective equipment (PPE) requirements

Personnel shall also be able to demonstrate competency in the:

- Use of documentation
- Production of documentation in inspection reports
- Practical skills necessary for the preparation and implementation of relevant concepts of protection
- Use and production of installation records

WARNING

Substitution of components is not permitted.

- ▶ Substitution of components may impair intrinsic safety.

2.2 Potential risks affecting personnel

This section addresses the appropriate actions to undertake when faced with hazardous situations during or before service of the analyzer. It is not possible to list all potential hazards within this document. The user is responsible for identifying and mitigating any potential hazards present when servicing the analyzer.

NOTICE

- ▶ Technicians are expected to be trained and follow all safety protocols that have been established by the customer in accordance with the area hazard classification to service or operate the analyzer and MAC controller.
- ▶ This may include, but is not limited to, toxic and flammable gas monitoring protocols, lockout/tagout procedures, the use of PPE requirements, hot work permits and other precautions that address safety concerns related to the use and operation of process equipment located in hazardous areas.

2.2.1 Electrocuting hazard

WARNING

- ▶ Complete this action before performing any service that requires working near the main input power or disconnecting any wiring or other electrical components.
1. Shut off power at the main disconnect external to the analyzer.
 2. Only use tools with a safety rating for protection against accidental contact with voltage up to 1000V (IEC 900, ASTF-F1505-04, VDE 0682/201).

2.2.2 Laser safety

The JT33 spectrometer is a Class 1 laser product, which poses no threat to equipment operators. The laser internal to the analyzer controller is classified Class 3R and could cause eye damage if the beam is viewed directly.

WARNING

- ▶ Before servicing, shut off all power to the analyzer.

2.3 Product safety

The JT33 TDLAS gas analyzer is designed in accordance with good engineering practice to meet state-of-the-art safety requirements, has been tested, and left the factory in a condition that is safe to operate.

It meets general safety standards and legal requirements. It also complies with the EU directives listed in the specific EU Declaration of Conformity. Endress+Hauser confirms this by affixing the CE mark to the analyzer system.

2.3.1 General

- Adhere to all warning labels to prevent damage to the unit.
- Do not operate the device outside the specified electrical, thermal, and mechanical parameters.
- Only use the device in media to which the wetted materials have sufficient durability.
- Modifications to the device can affect the explosion protection and must be carried out by staff authorized to perform such work by Endress+Hauser.
- Ensure foreign matter (solid, liquid, or gas) does not enter the MAC or controller enclosure during maintenance to preserve its pollution degree 2 rating.
- Only open the controller or MAC cover if the following conditions are met:
 - An explosive atmosphere is not present.
 - All device technical data is observed. See the nameplate.
- In potentially explosive atmospheres:
 - Do not disconnect any electrical connections while the equipment is energized.
 - Do not open the connection compartment cover or MAC cover when energized or the area is known to be hazardous.
- Install the controller circuit wiring according to the Canadian Electrical Code (CEC) respective National Electrical Code (NEC) using threaded conduit or other wiring methods in accordance with articles 501 to 505, and/or IEC 60079-14.
- Install the device according to the manufacturer's instructions and regulations.
- The flameproof joints of this equipment are other than the minimums specified in IEC/EN 60079-1 and shall not be repaired by the user.

2.3.2 General pressure

The system is designed and tested with appropriate margins to ensure that it is safe under normal operating conditions, which include temperature, pressure, and gas content. The operator is responsible for ensuring that the system is shut off when these conditions are no longer valid.

2.3.3 JT33 analyzer seals

The optical head of the analyzer interfaces with the process medium through a window and pressure transducer in the cell tube assembly. The window and pressure transducer are the primary seals of the equipment. The ISEM interface module assembly is the analyzer's secondary seal, which separates the transmitter head from the optical head. Although the JT33 analyzer contains other seals to prevent the migration of process medium into the electrical wiring system, if either of the primary seals fail, only the ISEM interface module assembly is considered a secondary seal.

The JT33 analyzer transmitter housing is certified for Class I, Division 1 with a factory-sealed terminal compartment which eliminates the need for external seals. The factory seal is only required when used in $-40\text{ }^{\circ}\text{C}$ ($-40\text{ }^{\circ}\text{F}$) or lower ambient temperatures.

All optical heads for JT33 analyzers were assessed as "Dual Seal without Annunciation" devices. Refer to the markings on the label for the maximum working pressures.

MAC enclosure entries require either a barrier gland or conduit seal, depending on the application, and shall be located within 127 mm (5 in) of the MAC enclosure.

For Class I Zone 1, installation seals are required within 51 mm (2 in) of the analyzer transmitter housing. If the JT33 analyzer includes a heated enclosure, a suitable equipment certified seal shall be installed within 127 mm (5 in) of the outer MAC enclosure wall.

2.3.4 Electrostatic discharge

The powder coating and the adhesive label are nonconducting and may generate an ignition-capable level of electrostatic discharge under certain extreme conditions. The user should ensure that the equipment is not installed in a location where it may be subjected to external conditions, such as high-pressure steam, which might cause a buildup of electrostatic charges on nonconducting surfaces. To clean the equipment, use only a damp cloth.

2.3.5 Chemical compatibility

Never use vinyl acetate, acetone, or other organic solvents to clean the analyzer housing or labels.

2.3.6 Canadian Registration Number

In addition to the requirements above for general pressure safety, Canadian Registration Number (CRN) systems must be maintained using CRN approved components without any modification to the sample conditioning system (SCS) or analyzer.

2.3.7 IT security

Our warranty is valid only if the device is installed and used as described in the Operating Instructions. The device is equipped with security mechanisms to protect it against any inadvertent changes to the settings.

IT security measures, which provide additional protection for the device and associated data transfer, must be implemented by the operators in line with their security standards.

2.4 Device-specific IT security

The device offers a range of specific functions to support protective measures on the operator's side. These functions can be configured by the user and guarantee greater operational safety if used correctly. An overview of the most important functions is provided in the following section.

Function/interface	Factory setting	Recommendation
Write protection from hardware write protection switch	Not enabled	On an individual basis following risk assessment
Access code (also applies for web server login)	Not enabled (0000)	Assign a custom access code during commissioning.
WLAN (order option in display module)	Enabled	On an individual basis following risk assessment
WLAN security mode	Enabled (WPA2-PSK)	Do not change.
WLAN passphrase (password)	Serial number	Assign an individual WLAN passphrase during commissioning.
WLAN mode	Access Point	On an individual basis following risk assessment
Web server	Enabled	On an individual basis following risk assessment
CDI-RJ45 service interface	—	On an individual basis following risk assessment

2.4.1 Protecting access through hardware write protection

Write access to the device parameters from the local display and the web browser can be disabled with a write protection switch (DIP switch on the motherboard). When hardware write protection is enabled, only read-only access to the parameters is possible.

Hardware write protection is disabled when the device is delivered.

2.4.2 Protecting access with a password

Different passwords are available through the WLAN interface to protect write access to the device parameters or access to the device,

- **User-specific access code.** Protect write access to the device parameters from the local display or web browser. Access authorization is clearly regulated with a user-specific access code.
- **WLAN passphrase.** The network key through the WLAN interface protects a connection between an operating unit (e.g., notebook or tablet) and the device; this can be ordered as an option.
- **Infrastructure mode.** When the device is operated in infrastructure mode, the WLAN passphrase corresponds to the WLAN passphrase configured on the operator side.

2.4.3 User-specific access code

Write access to the device parameters through the local display and web browser can be protected by the modifiable, *user-specific access code* → . When the device is delivered, the device does not have an access code and is equivalent to **0000** (open).

2.4.4 Access from web server

The device can be operated and configured from a web browser with the integrated web server. Refer to *Access the operating menu from the web browser* → . The connection is through the service interface (CDI-RJ45), the connection for TCP/IP signal transmission (RJ45 connector), or the WLAN interface.

The web server is enabled when the device is delivered. The web server can be disabled if necessary (e.g., after commissioning) from the **web server functionality** parameter.

The JT33 TDLAS gas analyzer and status information can be hidden on the log in page to prevent unauthorized access to the information.

2.4.5 Access through service interface

The device can be accessed from the service interface (CDI-RJ45). Device-specific functions guarantee the secure operation of the device in a network.

NOTICE

- ▶ Connection to the service interface (CDI-RJ45) shall only be permitted by trained personnel on a temporary basis for the purpose of test, repair, or overhaul of the equipment, and only if the area where the equipment is to be installed is known to be nonhazardous.

The use of relevant industrial standards and guidelines that have been defined by national and international safety committees, such as IEC/ISA62443 or the IEEE, is recommended. This includes organizational security measures such as the assignment of access authorization as well as technical measures such as network segmentation.

3 Product description

3.1 JT33 TDLAS gas analyzer system

The JT33 TDLAS gas analyzer for trace measurements features specialized equipment for mitigating and measuring analytes. It is a turnkey assembly configured with precertified equipment, including the heater, solenoid valves, scrubber, filter, isolation valves, enclosure, and SCS. The SCS allows more precise control of the sample gas before it flows through the spectrometer.

The system is comprised of a sample cell, intrinsically safe optical head, and an electronics assembly platform within a precertified flameproof enclosure. The cell is a sealed tube through which the gas mixture flows. The cell has a gas inlet and a gas outlet. On 1 end of the tube is a window through which a beam of infrared laser light travels, which in turn reflects on internal mirrors. In this arrangement, the gas mixture does not contact the laser or any other optoelectronics. Pressure, and in some cases temperature sensors, are employed in the cell assembly to compensate for the effects of pressure and temperature changes in the gas.

Differential system for hydrogen sulfide (H₂S)

The Endress+Hauser JT33 TDLAS gas analyzer for trace hydrogen sulfide (H₂S) features a differential TDLAS system. Below is the front view of a sample analyzer for H₂S.

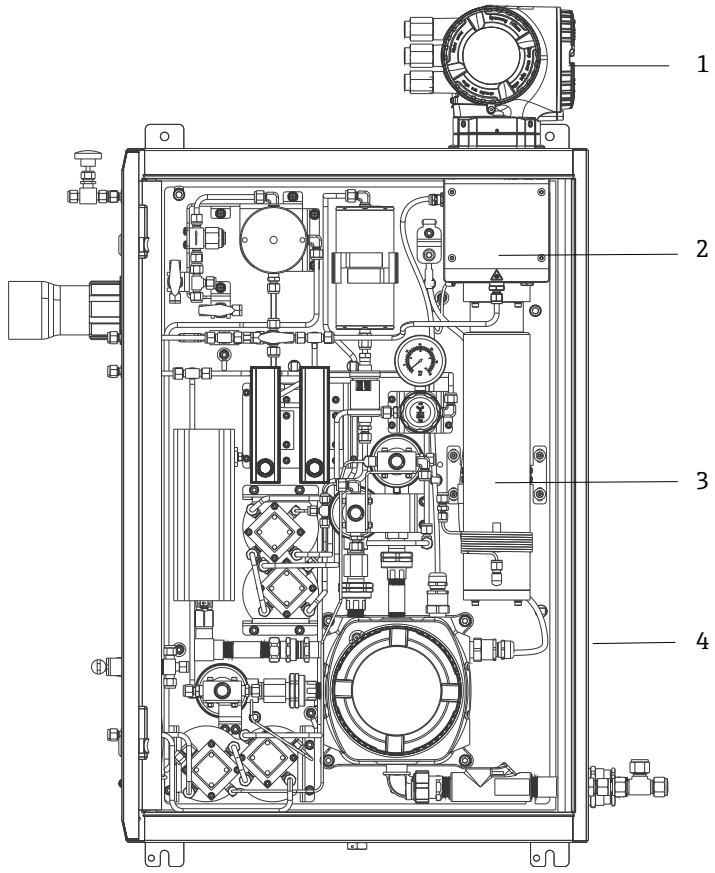

A0054774

Figure 1. JT33 TDLAS gas analyzer with enclosed SCS, with heater

#	Name
1	Controller
2	Optical head enclosure assembly
3	Measurement head assembly
4	Sample system in enclosure

3.2 Sample conditioning system

3.2.1 Overview

A sample conditioning system (SCS) with the JT33 TDLAS gas analyzer has been specifically designed to deliver a sample stream that is representative of the process systems stream at the time of sampling. analyzers are designed for use with extractive gas sampling stations.

3.2.2 Scrubber

All trace measurement applications require the use of a scrubber. Typically, these devices are switched into the flowing sample going to the measurement cell to remove the trace hydrogen sulfide component. A spectrum of the sample gas free of H₂S is acquired and saved in the analyzer controller memory. This is the “dry” spectrum. The scrubber is bypassed and the sample spectrum is acquired with H₂S in the sample. This is the “wet” spectrum.

The analyzer controller subtracts the dry spectrum from the wet spectrum and the concentration of trace hydrogen sulfide is measured. The same dry spectrum is typically used for 10 to 30 minutes, depending on logic programmed into the controller before a new dry spectrum is acquired. The automatic valves that control switching the sample stream into the scrubber or bypassing the scrubber are either electrical or pneumatically driven valves.

3.3 Symbols on the equipment

3.3.1 Electrical symbols

Symbol	Description
	Protective Earth (PE) This symbol identifies a terminal that is bonded to conductive parts of equipment for safety purposes and is intended to be connected to an external protective earthing system.

3.3.2 Informational symbols

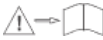
Symbol	Description
	This symbol refers the user to the technical documentation for more information.

3.3.3 Warning symbols

Symbol	Description
	The Laser Radiation symbol is used to alert the user to the danger of exposure to hazardous visible laser radiation when using the system. The laser is a class 3R radiation product.

3.3.4 Controller labels

POWER
Nicht unter Spannung offen
Do not open when energized
Ne pas ouvrir sous tension

Terminate power prior to accessing equipment to prevent damage to the analyzer.

Warning: DO NOT OPEN IN
EXPLOSIVE ATMOSPHERE
Attention: NE PAS OUVRIR EN
ATMOSPHERE EXPLOSIVE

Use caution before opening the analyzer enclosure to avoid injury.

4 Installation

For safety requirements and guidance, refer to the *JT33 TDLAS gas analyzer Safety Instructions (XA03137C)*.

For environmental and wiring requirements, refer to the **Technical data** section of the *JT33 TDLAS gas analyzer Operating Instructions (BA02297C)*.

Tools and hardware

- T20 Torx screwdriver
- 24 mm Open-ended wrench
- 3 mm Flat blade screwdriver
- #2 Phillips screwdriver
- 1.5 mm hex driver
- 3 mm hex driver
- Tape measure
- Felt-tip marker
- Level
- Seamless, stainless steel tubing (electro-polished), 6 mm (¼ in) O.D. x 0.1 mm (0.035 in) is recommended.

4.1 Installing the heat trace boot

The heat trace boot for JT33 TDLAS gas analyzer with an enclosure is an available option. For ease of shipping, the heat trace boot may have been removed at the factory. To reinstall the heat trace boot, follow the instructions below.

Tools and hardware

- Bushing
- Lubricated O-ring
- Heat trace boot

Install the heat trace boot

1. Locate the appropriate opening on the exterior of the sample conditioning system.
2. Open the sample conditioning system enclosure door and insert the bushing into the opening until the base is flush against the inside wall of the enclosure.
3. Apply the lubricated O-ring to the threaded bushing on the outside of the enclosure until flush against the outside wall.

NOTICE

- ▶ Ensure there is no contamination of the O-ring lubricant prior to installation.
4. Holding the threaded connector from the inside of the enclosure, thread the boot onto the bushing and turn clockwise by hand until tight.
 5. Torque the 2 in (approximately 50 mm) plastic heat trace boot to 7 Nm (63 in-lb).

NOTICE

- ▶ Do not overtighten. The boot assembly can break.

4.2 Lifting and moving the analyzer

The JT33 analyzer weighs up to 102.5 kg (226 lb) and is shipped in a wooden crate. Because of the size and weight, Endress+Hauser recommends the following process for lifting and moving the analyzer for installation.

Equipment/materials

- Crane or forklift with lifting hook
- Dolly or scissor jack
- Four 25 mm (1 in) wide endless ratchet straps rated for a minimum of 500 kg (1100 lb) each
- Cloths

NOTICE

- ▶ Overtightening the ratchets on the horizontal straps may damage the enclosure. The horizontal straps must be tight enough to hold the vertical straps in position, but not too tight.
 - ▶ Place cloths between the ratchet points and the enclosure to prevent scratches.
1. Move the crate as close to the final installation location as possible.
 2. With the analyzer still in the crate, route 2 of the ratchet straps vertically on each side of the analyzer. Ensure the straps under the enclosure align outside of the bottom mounting tabs as shown in the figure below.
 3. Bring both straps together at the top of the analyzer, allowing enough slack to pass the lifting hook through the straps.
 4. Install the third strap horizontally toward the bottom of the enclosure by weaving it over and under the vertical straps. Install the fourth strap horizontally toward the top of the enclosure by weaving it over and under the vertical straps in the opposite pattern from the third strap.
 5. Remove the analyzer from the crate using the crane or forklift.
 6. Place the analyzer on a dolly or scissor jack and remove the straps to finish the installation.
If necessary, the installation can be completed using the crane or forklift and the ratchet straps.

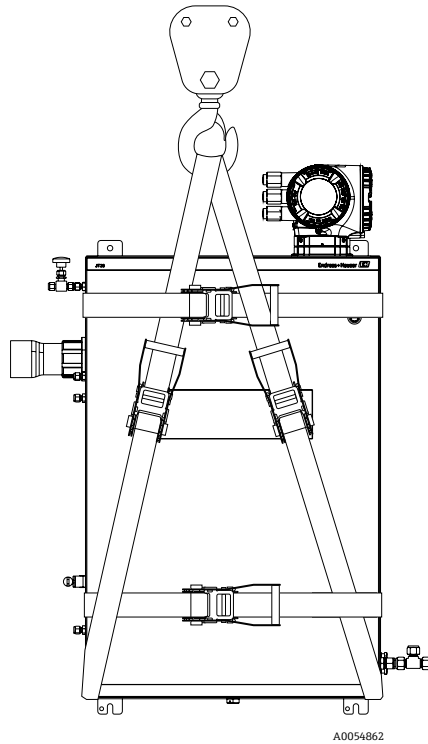
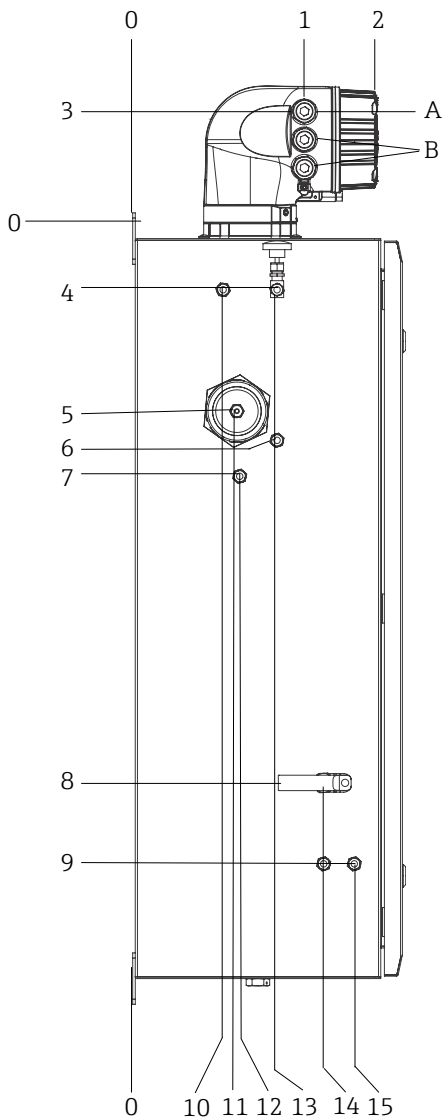

Figure 2. JT33 analyzer with ratchet straps for lifting and moving

4.3 Mounting the analyzer

The analyzer can be wall mounted. When mounting, position the instrument so that it is not difficult to operate adjacent devices.

4.3.1 Mounting dimensions



A0054796

Figure 3. Mounting dimensions: Side view

#	From corner 0, mm (in)	#	From corner 0, mm (in)	#	Description
1	213 (8)	9	789 (31)	0	Top mounting location
2	304 (12)	10	112 (4)	A	Power in
3	141 (6)	11	129 (5)	B	Communication out
4	79 (3)	12	133 (5)		
5	229 (9)	13	179 (7)		
6	265 (10)	14	237 (9)		
7	310 (12)	15	275 (11)		
8	689 (27)				

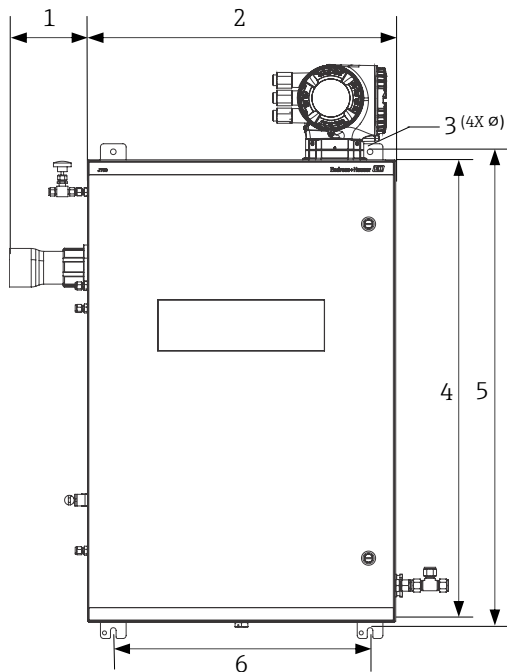

A0054797

Figure 4. Mounting dimensions: Front view

#	mm (in)	#	mm (in)
1	155 (6)	4	914 (36)
2	610 (24)	5	946 (37)
3	11 (0.4)	6	508 (20)

4.3.2 Wall mounting

NOTICE

The JT33 TDLAS gas analyzer is designed for operation within the specified ambient temperature range. Intense sun exposure in some areas may cause the temperature inside the analyzer to exceed the ambient temperature specification.

- ▶ A sunshade or canopy installed over the analyzer for outdoor installations is recommended in those instances.
- ▶ Hardware used for mounting the JT33 TDLAS gas analyzer must be able to support 4 times the weight of the instrument, approximately 89.9 kg (196 lb) to 102.5 kg (226 lb), depending on configuration.

Hardware required (not supplied)

- Mounting hardware
- Spring nuts, if mounting on Unistrut
- Machine screws and nuts to fit the size of the mounting hole

To install the enclosure

1. Install the bottom 2 mounting bolts to the mounting frame or wall. Do not fully tighten the bolts. Leave an approximately 10 mm (0.4 in) gap to slide the analyzer mounting tabs onto the bottom bolts.
2. Safely lift the analyzer using the appropriate installation equipment. Refer to *Lifting and moving the analyzer* → .
3. Install the analyzer onto the bottom bolts and slide the slotted bottom mounting tabs over the bolts. Continue to support the weight of the analyzer with the equipment.



A0053925

Figure 5. Slotted bottom mounting tabs of enclosure

4. Tilt the analyzer towards the mounting frame or wall to align and secure the 2 top bolts.



A0053926

Figure 6. Top mounting tabs of enclosure

5. Tighten all 4 bolts and then remove the installation equipment.

4.4 Turning the display module

The display module can be turned to optimize readability and operability.

1. Loosen the securing clamp of the connection compartment cover.
2. Unscrew the connection compartment cover.
3. Turn the display module to the desired position: max. $8 \times 45^\circ$ in every direction.

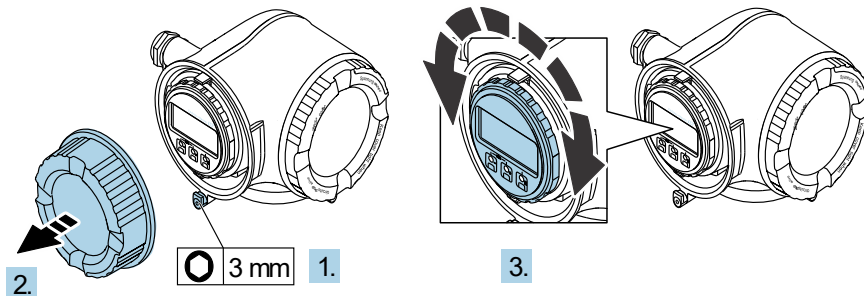

A0030035

Figure 7. Turning the display module

4. Screw on the connection compartment cover.
5. Fit the securing clamp of the connection compartment cover.

5 Electrical connection



WARNING

Hazardous voltage and risk of electric shock

- ▶ Turn off lockout system power before opening the electronics enclosure and making any connections.

The installer is responsible for complying with all local installation codes.

- ▶ Power and signal field wiring should be accomplished using wiring methods approved for hazardous locations as per the Canadian Electrical Code (CEC) Appendix J, the National Electrical Code (NEC) Article 501 or 505, and IEC 60079-14.
- ▶ Use copper conductors only.
- ▶ For models of the JT33 TDLAS gas analyzer with SCS with enclosure, the inner sheath of the supply cable for the heater circuit should be sheathed with thermoplastic, thermosetting, or elastometric material. The material should be circular and compact. Any bedding or sheath should be extruded. Fillers, if any, should be nonhygroscopic.
- ▶ At a minimum, the cable length should exceed 3 m (9.8 ft).

5.1 Connection conditions

5.1.1 Protective chassis and ground connections

Before connecting any electrical signal or power, connect the protective and chassis grounds.

- Protective and chassis grounds must be of equal or greater size than any other current-carrying conductors, including the heater located in the SCS.
- Protective and chassis grounds remain connected until all other wiring is removed.
- Protective grounding wire current carrying capacity must be at least the same as the main supply.
- Earth bonding/chassis ground shall be at least 6 mm² (10 AWG).

Protective ground cables

- Analyzer: 2.1 mm² (14 AWG)
- Enclosure: 6 mm² (10 AWG)

The grounding impedance must be less than 1 Ω.

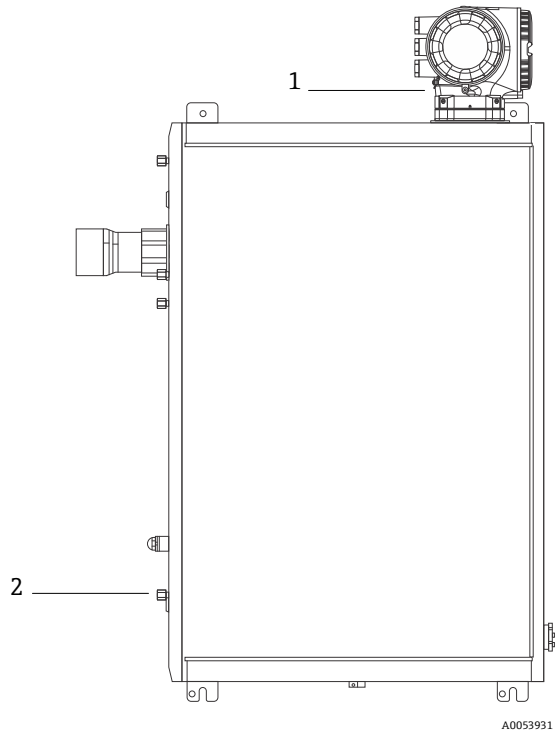

Figure 8. Ground connections

#	Name
1	Protective ground screw, M6 x 1.0 x 8 mm, ISO-4762
2	Protective ground stud, M6 x 1.0 x 20 mm

5.1.2 Analyzer electrical connections

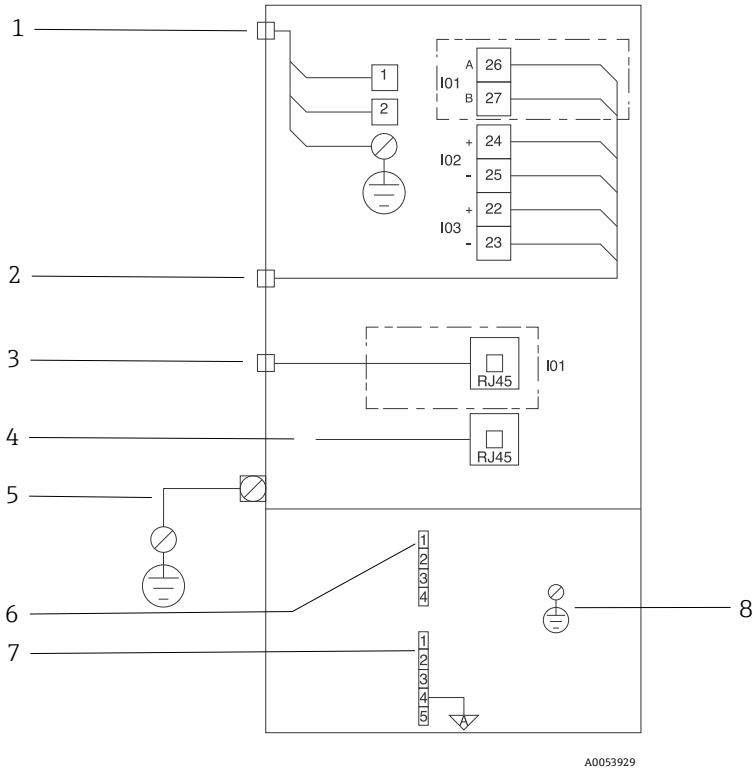

Figure 9. JT33 analyzer electrical connections

#	Description
JT33 controller	
1	AC 100 to 240 V $\pm 10\%$; DC 24 V $\pm 20\%$ 1 = line; 2 = neutral Wire is 14 gauge or larger for ground connection (for line, neutral and ground). Cross section of the cable is $\geq 2.1 \text{ mm}^2$.
2	Data ports I/O options: <ul style="list-style-type: none"> • Modbus RTU • Outputs: Current, Status, Relay • Inputs: Current, Status Terminals 26 and 27 are used for Modbus RTU (RS485) only.

#	Description
3	Alternative data port 10/100 ethernet (optional), network option Modbus TCP Terminals 26 and 27 are replaced by an RJ45 connector for Modbus TCP.
4	Service port Internal connection is accessible only temporarily by trained personnel for test, repair, or overhaul of the equipment, and only if the area where the equipment is installed is known to be nonhazardous.
5	External ground lug Must be 10 gauge or larger. Cross section of the cable is $\geq 6 \text{ mm}^2$.
Optical head	
6	Flow switch connection (1 to 4) = connector J6. See drawing EX3100000056. 1 = flow switch line 2 = analog ground 3 = no connection 4 = no connection
7	RS485 MAC communication lines (1 to 5) = connector J7. See drawing EX3100000056. Connector J7 is for Endress+Hauser factory connection only. Do not use for installation or customer connection. 1 = negative intrinsically safe line 2 = positive intrinsically safe line 3 = no connection 4 = connection to the analog ground on the optical head enclosure (OHE) and to the RS485 harness shielding 5 = no connection
8	Internal ground to optical head cover

5.1.3 MAC electrical connections

The MAC (measurement accessories controller) certified equipment, consisting of a single, printed circuit board assembly and power supply—depending on voltage source—resides in an Ex d enclosure. It is powered independently of the ISEM and offers the capability for some intrinsically and non-intrinsically safe inputs and outputs.

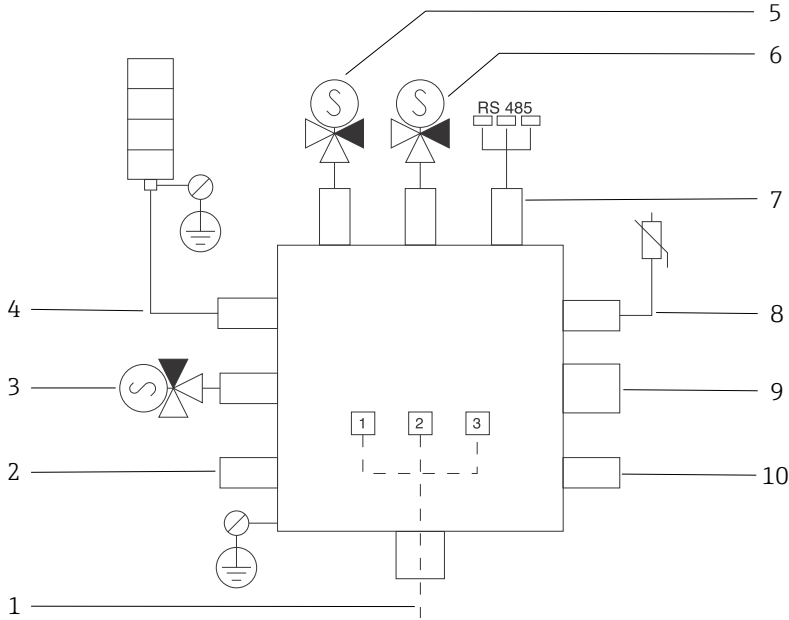
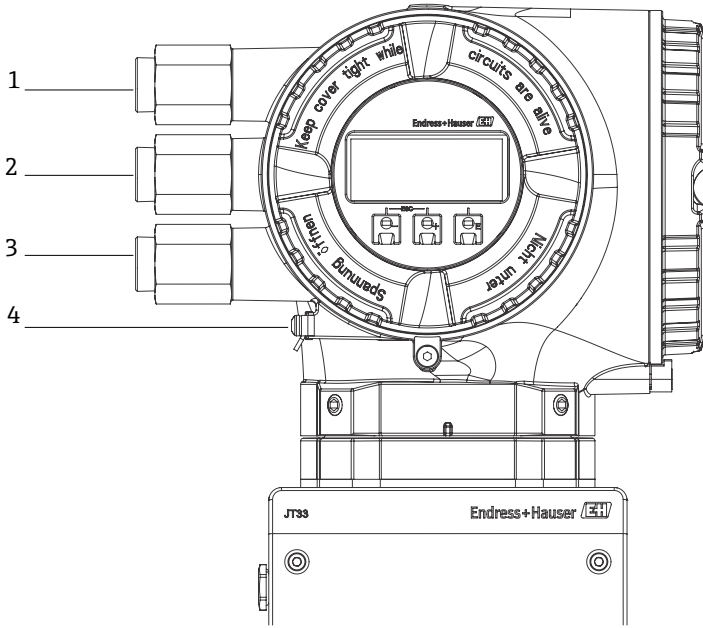

Figure 10. MAC enclosure designed instrument/sensor locations

#	Description												
1	Customer power entry AC 100 to 240 V $\pm 10\%$ 50/60 HZ, 275 W maximum DC 24 V $\pm 10\%$, 67 W maximum												
	<table border="1"> <thead> <tr> <th>#</th> <th>AC 100 to 240 V option</th> <th>DC 24 V option</th> </tr> </thead> <tbody> <tr> <td>1</td> <td>Hot</td> <td>+24 V</td> </tr> <tr> <td>2</td> <td>Neutral main</td> <td>-24 V</td> </tr> <tr> <td>3</td> <td>Main ground</td> <td>open</td> </tr> </tbody> </table>	#	AC 100 to 240 V option	DC 24 V option	1	Hot	+24 V	2	Neutral main	-24 V	3	Main ground	open
#	AC 100 to 240 V option	DC 24 V option											
1	Hot	+24 V											
2	Neutral main	-24 V											
3	Main ground	open											

#	Description
2	Not used currently Future solenoid entry
3	Validation solenoid
4	Sample conditioning system heater
5	Cell/scrubber solenoid 2
6	Cell/scrubber solenoid 1
7	RS485 communication Intrinsically safe OHE RS485 interface connected with a cable to the OHE board in the optical head enclosure, Endress+Hauser integrator
8	Sample conditioning system thermistor
9	Not used currently Future cell heater/cell thermistor entry
10	Not used currently Future pump entry

5.1.4 External cable entry points



A0054799

Figure 11. Threaded entries

#	Description
1	Cable entry for supply voltage
2	Cable entry for signal transmission; I/O1, or Modbus RS485, or Ethernet network connection (RJ45)
3	Cable entry for signal transmission; I/O2, I/O3
4	Protective earth ground

5.2 Connecting the measuring device

5.2.1 Connecting Modbus RS485

Open the terminal cover

1. Loosen the securing clamp of the connection compartment cover.
2. Unscrew the connection compartment cover.
3. Squeeze together the tabs of the display module holder.
4. Remove the display module holder.

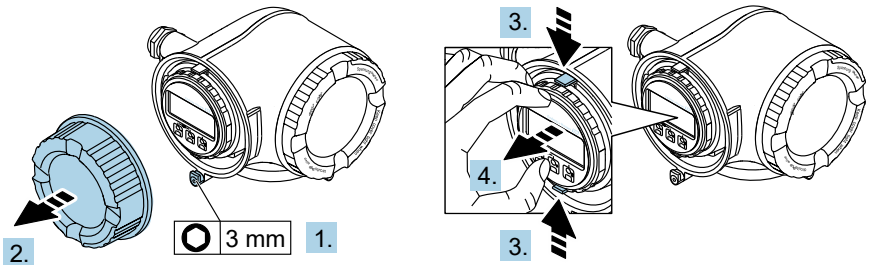

A0029813

Figure 12. Removing the display module holder

5. Attach the holder to the edge of the electronics compartment.
6. Open the terminal cover.

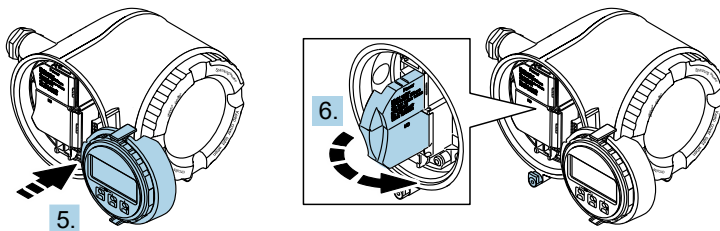

A0029814

Figure 13. Opening the terminal cover

Connect the cables

1. Push the cable through the cable entry. To ensure tight sealing, do not remove the sealing ring from the cable entry.

NOTICE

- ▶ The temperature of the gas analyzer can reach 67 °C (153 °F) in 60 °C (140 °F) ambient at the cable entry and branching point. This must be considered when selecting field wiring and cable entry devices.

2. Strip the cable and cable ends. In the case of stranded cables, also fit ferrules.
3. Connect the protective ground.

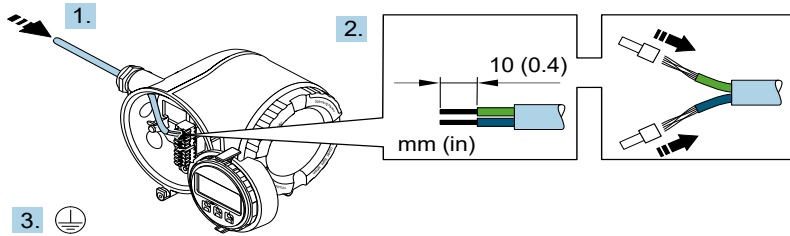

A0033983

Figure 14. Feeding wiring and connecting the protective ground

4. Connect the cable in accordance with the **signal cable terminal assignment**. The device-specific terminal assignment is documented on an adhesive label in the terminal cover.
5. Firmly tighten the cable glands.
 - ↳ This concludes the cable connection process.



Step 5 is not used for CSA-certified products. Under CEC and NEC requirements, conduit is used in place of cable glands.

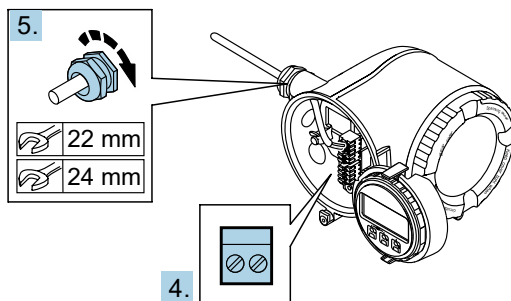

A0033984

Figure 15. Connecting the cables and tightening glands

6. Close the terminal cover.
7. Fit the display module holder in the electronics compartment.
8. Screw on the connection compartment cover.
9. Secure the securing clamp of the connection compartment cover.

5.2.2 Connecting Modbus TCP

In addition to connecting the device through Modbus TCP and the available inputs/outputs, **Error! Reference source not found.** is an available option. Refer to the section **Connecting to the analyzer through the service interface (CDI-RJ45)** in the *JT33 TDLAS gas analyzer Operating Instructions (BA02297C)*.

Open the terminal cover

1. Loosen the securing clamp of the connection compartment cover.
2. Unscrew the connection compartment cover.
3. Squeeze together the tabs of the display module holder.
4. Remove the display module holder.

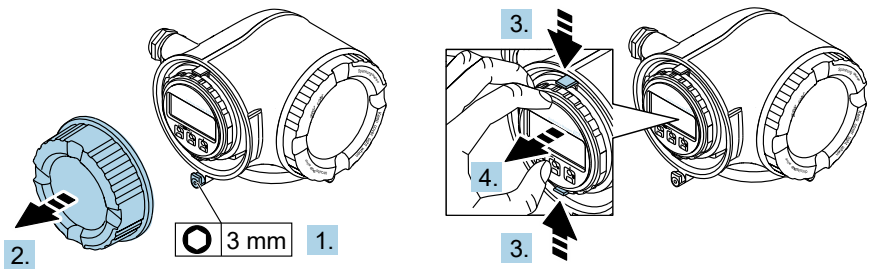

A0029813

Figure 16. Removing the display module holder

5. Attach the holder to the edge of the electronics compartment.
6. Open the terminal cover.

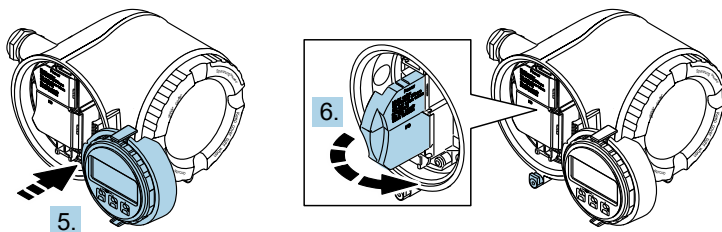

A0029814

Figure 17. Opening the terminal cover

Connect the cables

1. Push the cable through the cable entry. To ensure tight sealing, do not remove the sealing ring from the cable entry.
 2. Strip the cable and cable ends and connect to the RJ45 connector.
 3. Connect the protective ground.
 4. Plug in the RJ45 connector.
 5. Firmly tighten the cable glands.
- ↳ This concludes the Modbus TCP connection process.

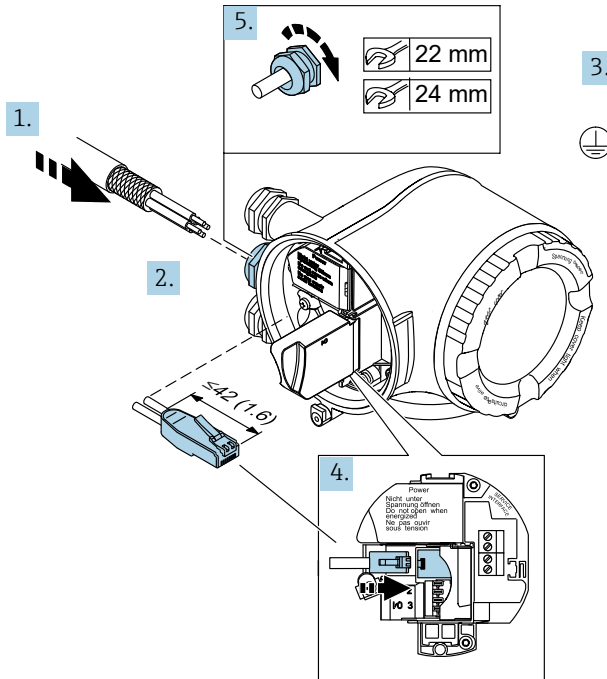

A0054800

Figure 18. Connecting the RJ45 cable

6. Close the terminal cover.
7. Fit the display module holder in the electronics compartment.
8. Screw on the connection compartment cover.
9. Secure the securing clamp of the connection compartment cover.

5.2.3 Connecting the supply voltage and additional inputs/outputs

⚠ WARNING

The temperature of the gas analyzer can reach 67 °C (153 °F) in 60 °C (140 °F) ambient at the cable entry and branching point.

- ▶ These temperatures must be considered when selecting field wiring and cable entry devices.
- ▶ The main electronic assembly shall be protected by a building installation overcurrent protection rated for 10 amp or less.

1. Push the cable through the cable entry. To ensure tight sealing, do not remove the sealing ring from the cable entry.
2. Strip the cable and cable ends. In the case of stranded cables, also fit ferrules.
3. Connect the protective ground.

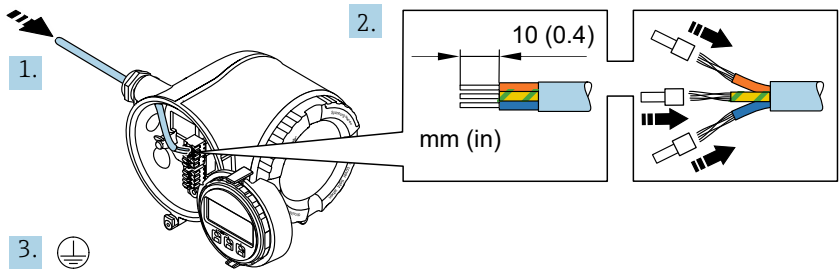

A0054801

Figure 19. Feeding wiring and connecting the protective ground

4. Connect the cable in accordance with the terminal assignment: Signal cable terminal assignment or Supply voltage terminal assignment. The device-specific terminal assignment is documented on an adhesive label in the terminal cover.

i Refer to the *JT33 TDLAS gas analyzer Operating Instructions (BA02297C)* for connection examples.

5. Firmly tighten the cable glands.
 - ↳ This concludes the cable connection process.
6. Close the terminal cover.
7. Fit the display module holder in the electronics compartment.
8. Screw on the connection compartment cover.
9. Secure the securing clamp of the connection compartment cover.

i Conduit is required for the power connection for the CSA-certified gas analyzer. The ATEX-certified model requires armored cable steel wire or braided wire.

5.2.4 Removing a cable

1. To remove a wire from the terminal, use a flat-blade screwdriver to push the slot between the 2 terminal holes.
2. Simultaneously pull the cable end out of the terminal.

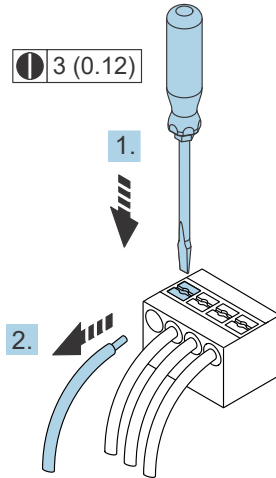

A0029598

Figure 20. Removing a cable. Engineering unit: mm (in)

After installing all interconnecting wiring or cabling, make sure any remaining conduit or cable entries are plugged with certified accessories according to the intended use of the product.

WARNING

- ▶ Conduit seals and glands specific to the application (CSA or Ex d IP66) should be used where appropriate in compliance with local regulations.

5.2.5 Connecting the controller to a network

Refer to the section **Connecting Modbus RS485** in the *JT33 TDLAS gas analyzer Operating Instructions (BA02297C)* for instructions to connect the controller.

5.2.6 Connecting through the service interface

The gas analyzer includes a connection to the service interface (CDI-RJ45).

NOTICE

- ▶ Connection to the service interface (CDI-RJ45) shall only be permitted by trained personnel on a temporary basis for the purpose of test, repair, or overhaul of the equipment and only if the area where the equipment is to be installed is known to be nonhazardous.

Note the following when connecting:

- Recommended cable: CAT 5e, CAT 6 or CAT 7, with shielded connector
- Maximum cable thickness: 6 mm (¼ in)
- Length of connector including bend protection: 42 mm (1.7 in)
- Bending radius: 5 x cable thickness

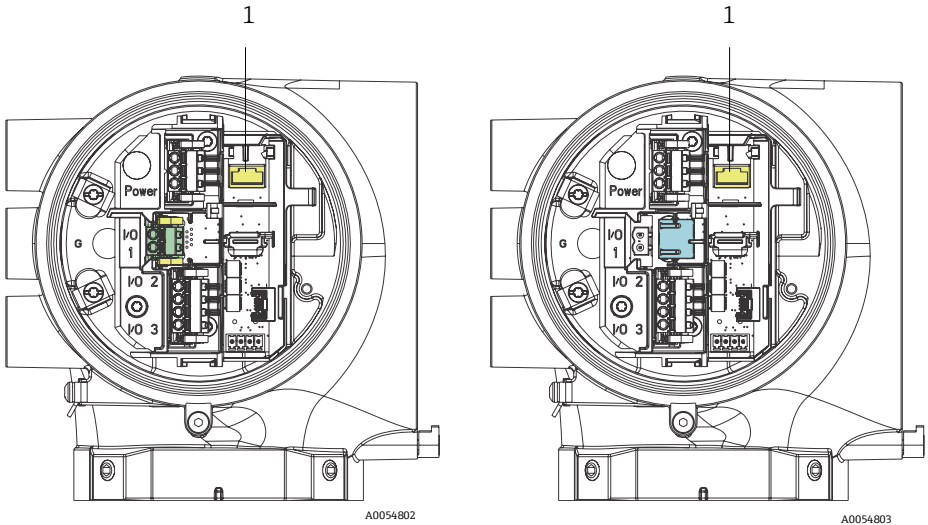

Figure 21. Service interface CDI-RJ45 (1) connections for I/O1 with Modbus RTU/RS485/2-wire (left) and Modbus TCP/Ethernet/RJ45 (right)

5.2.7 Connecting the flow switch

The JT33 analyzer can be offered with a variable flow meter equipped with an optional mechanical display and reed contact to measure the volume flow of flammable and nonflammable gases.

NOTICE

- ▶ Installation shall be in accordance with the National Electrical Code NFPA 70, Article 500 to 505, ANSI/ISA-RP12.06.01, IEC 60079-14 and Canadian Electrical Code (CEC) Appendix J for Canada.
- ▶ Only insulated cables with insulation capable of withstanding a dielectric test of at least AC 500 V or DC 750 V shall be used in intrinsically safe circuits.
- ▶ The temperature rating of terminals, cable glands and field wires affected by both ambient and service temperatures shall be suitable for a temperature of at least 75 °C (167 °F).

To connect the flow switch, run shielded interconnection cable with shield connected to FM-approved associated apparatus ground.

WARNING

- ▶ The variable area flow meter with coated parts shall be installed and maintained such that the risk of electrostatic discharge is minimized.

5.2.8 Threaded entries

NOTICE

- ▶ Thread lubricant must be applied on all conduit hub threaded connections. Using Syntheso Glep1 or equivalent lubricant on all conduit screw threads is recommended.

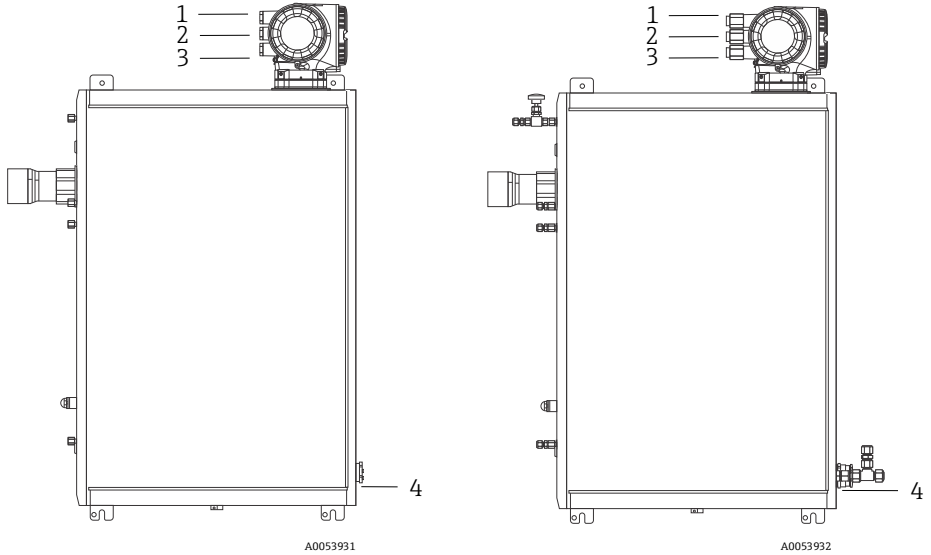

Figure 22. JT33 threaded entries on ATEX (left) and CSA (right) analyzer assemblies

Cable Entry	Description	ATEX, IECEx, UKEx	cCSAus
1	Controller power	Female M20 x 1.5	½" NPTF
2	Modbus power	Female M20 x 1.5	½" NPTF
3	2 Configurable I/O	Female M20 x 1.5	½" NPTF
4	MAC power	Male M25 x 1.5	¾" NPTM

Thread dimensions for the panel configuration are the same as shown for the enclosed sample system above.

5.2.9 Heat trace termination connection

The JT33 was designed for an exterior termination of the heat trace. To accomplish this, heat trace wiring must be looped back out of the heat trace boot during installation.

Connecting the heat trace termination

1. Identify the insulated line with heat trace and sample transport tubing.
2. Cut back the insulation until:
 - 76 cm (30 in) of the heat trace line is protruding
 - 15.2 cm (6 in) of the tubing is protruding
3. Place the heat shrink end cap over the heat trace line, tubing, and insulated line. Heat the end cap to form a seal.
4. Install insulated line into the heat trace boot and route the heat trace wire back through the boot. The supplier's bend radius for heat trace should be observed.
5. After tubing is installed and heat shrink is routed back out of the boot, apply heat to the boot to form a seal.
6. Cut back heat trace insulation and install the vendor's recommended junction box to power the heat trace.

5.3 Gas connections

Once you have verified that the JT33 TDLAS gas analyzer is functional and that the analyzer circuit is de-energized, you are ready to connect the sample supply and sample purge lines. As applicable, connect the pressure relief vent, validation source, and purge supply gas lines. All work must be performed by technicians qualified in pneumatic tubing.

WARNING

Process samples may contain hazardous material in potentially flammable or toxic concentrations.

- ▶ Personnel should have a thorough knowledge and understanding of the physical properties and safety precautions for the sample contents before installing the sample system.
- ▶ Do not exceed 3 barg (50 psig) in the sample cell. Damage to cell may result.

Using electropolished 6 mm or ¼ in, depending on order options, O.D. seamless, stainless steel tubing is recommended.

Connecting the sample supply line

1. Before connecting the sample supply line, confirm the following:
 - a. The sample probe is installed correctly at the process sample tap and that the sample probe isolation valve is closed.
 - b. The field pressure reducing station is installed properly at the sample probe and that the pressure regulator at the field pressure reducing station is closed by ensuring the adjustment knob is turned fully counterclockwise.

**WARNING****The process sample at the sample tap may be at high pressure.**

- ▶ Use extreme caution when operating the sample probe isolation valve and field pressure reducing pressure regulator.
 - ▶ All valves, regulators, switches, etc. should be operated in accordance with site lockout/tagout procedures.
 - ▶ Consult sample probe manufacturer instructions for proper installation procedures.
- c. The relief valve vent line is properly installed from the field pressure reducing station to the low-pressure flare or atmospheric vent connection.
2. Determine appropriate tubing route from the field pressure reducing station to the sample system.
 3. Run stainless steel tubing from the field pressure reducing station to the sample supply port of the sample system.
 4. Bend tubing using industrial grade benders and check tubing fit to ensure proper seating between the tubing and fittings.
 5. Fully ream all tubing ends.
 6. Prior to making the connection, blow out the line for 10 to 15 seconds with clean, dry nitrogen or air.
 7. Connect the sample supply tube to the sample system using 6 mm (1/4 in) stainless steel tubing compression-type fitting, depending on the order configuration.
 8. Tighten all new fittings 1 1/4 turns with a wrench from finger tight. For connections with previously swaged ferrules, thread the nut to the previously pulled up position, then tighten slightly with a wrench. Secure tubing to appropriate structural supports as required.
 9. Use a leak detector to check all connections for gas leaks.

Connecting the sample returns

1. Confirm the low-pressure flare or atmospheric vent header shutoff valve is closed.

**WARNING**

- ▶ All valves, regulators, switches, etc. should be operated in accordance with site lockout/tagout procedures.
2. Determine the appropriate tubing route from the sample system to the low-pressure flare or atmospheric vent header.
 3. Run stainless steel tubing from the sample return port of the sample system to the low-pressure flare or atmospheric vent header.
 4. Bend tubing using industrial grade benders and check tubing fit to ensure proper seating between the tubing and fittings.
 5. Fully ream all tubing ends.
 6. Prior to making the connection, blow out the line for 10 to 15 seconds with clean, dry nitrogen or air.

7. Connect the sample return tube to the sample system using a 6 mm (¼ in) stainless steel tubing compression-type fitting, depending on the order configuration.
8. Tighten all new fittings 1¼ turns with a wrench from finger tight. For connections with previously swaged ferrules, thread the nut to the previously pulled up position, then tighten slightly with a wrench. Secure tubing to appropriate structural supports as required.
9. Use a leak detector to check all connections for gas leaks.

5.4 Metric conversion kit

A metric conversion kit for the sample system converts the Imperial (in) analyzer system fittings to metric (mm) fittings. This kit is included with the JT33 TDLAS gas analyzer and includes the following parts:

Quantity	Description
6	Ferrule set, ¼" tube fitting
1	Ferrule set, ½" tube fitting
6	Tube nut, ¼" tube fitting, 316 stainless steel
1	Tube nut, ½" tube fitting, 316 stainless steel
6	6 mm tube fitting x ¼" tube stub, 316 stainless steel
1	12 mm tube fitting x ½" tube stub, 316 stainless steel

Required tools

- 7/8" open-ended wrench
- 5/16" open-ended wrench, for stabilizing adapter
- Felt-tip marker
- Gap inspection gauge

Installation

1. Select either the 6 mm (¼ in) or 12 mm (½ in) fitting, as appropriate.
2. Insert the tube adapter into the tube fitting. Make sure the tube adapter rests firmly on the shoulder of the tube fitting body and the nut is finger tight.
3. Mark the nut at the 6:00 position.
4. While holding the fitting body steady, tighten the tube nut 1¼ turns to the 9:00 position.
5. Use a gap inspection gauge, placing it between the nut and the body. If the gauge enters the gap, additional tightening is required.

NOTICE

- ▶ Refer to Swagelok's manufacturer instructions.

5.5 Hardware settings

For detailed information about the following hardware settings, refer to the *JT33 TDLAS gas analyzer Operating Instructions (BA02297C)*:

- Setting the flow switch
- Setting the analyzer address
- Activating the default IP address by DIP switch

5.6 Ensuring IP66 degree of protection

The measuring device fulfills all the requirements for the IP66 degree of protection, Type 4X enclosure. To guarantee IP66 degree of protection, Type 4X enclosure, carry out the following steps after the electrical connection:

1. Check that the housing seals are clean and fitted correctly.
2. Dry and clean seals or replace if necessary.
3. Tighten all housing screws and screw covers.
4. Firmly tighten the cable glands.
5. Route the cable so that it loops down before the cable entry/water trap to ensure that moisture does not enter the cable entry.

 Ensure the minimum required cable radius is met.

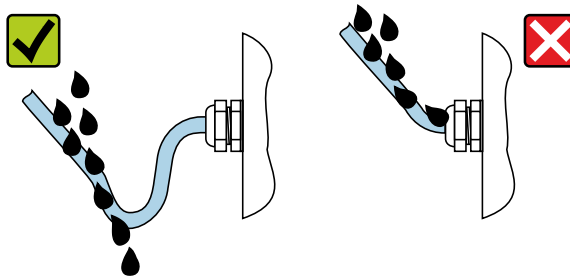

A0029278

Figure 23. Ensuring IP66 degree of protection

6. Insert dummy plugs into unused cable entries.

6 Operation options

6.1 Overview of operation options

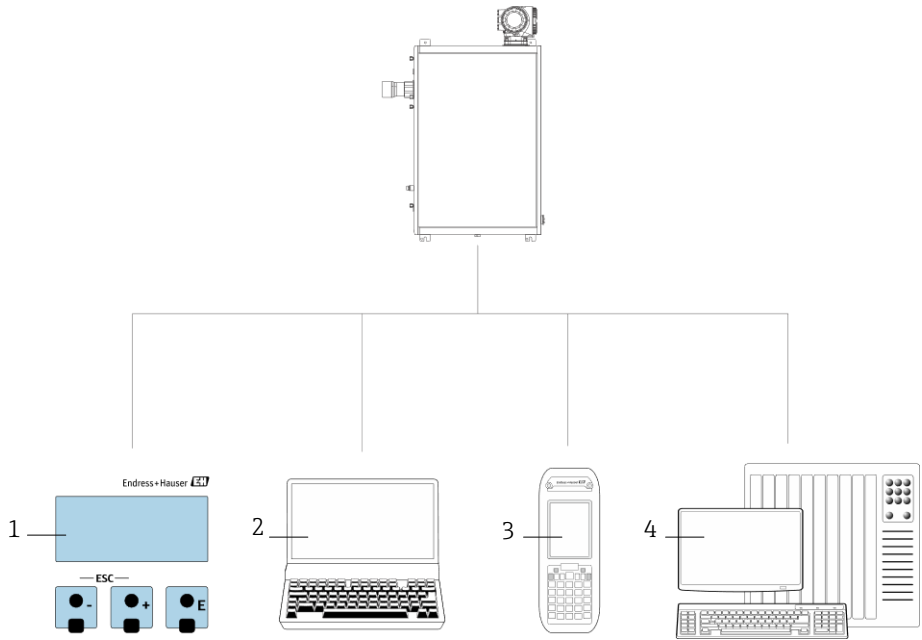

A0054380

Figure 24. Operation options

#	Name
1	Local operation through the display module
2	Computer with web browser, such as Internet Explorer
3	Mobile device, such as a cellular telephone or tablet, used on the network to access the web server or Modbus
4	Control system, such as PLC

6.2 Structure and function of the operating menu

6.2.1 Structure of the operating menu

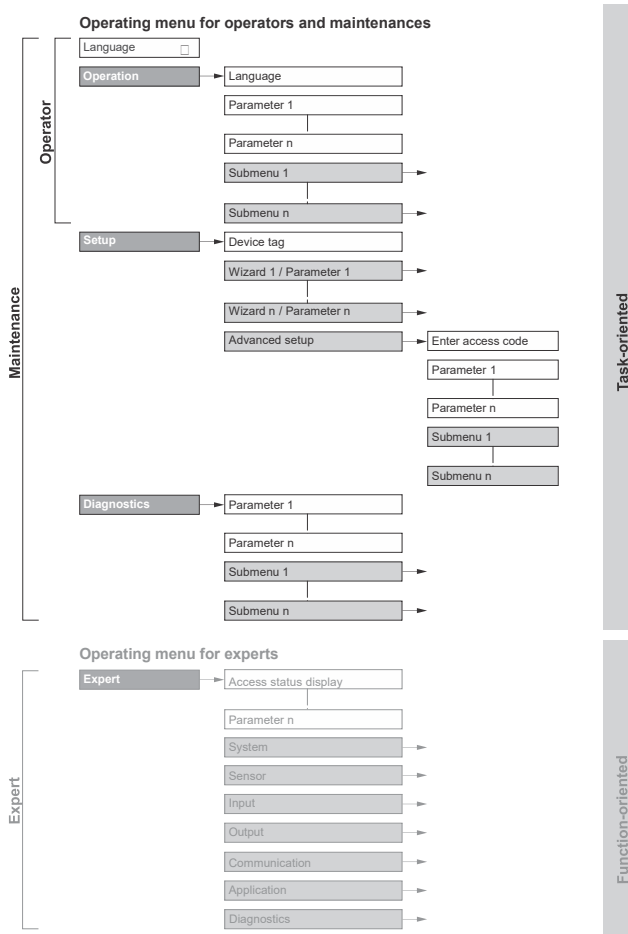

A001823

Figure 25. Schematic structure of the operating menu

6.2.2 Operating roles

The individual parts of the operating menu are assigned to certain user roles, such as operator and maintenance. Each user role contains typical tasks within the device lifecycle.



Refer to the *JT33 TDLAS gas analyzer Operating Instructions (BA02297C)* for details about the user roles and tasks.

6.3 Accessing the operating menu through the local display

6.3.1 Operational display

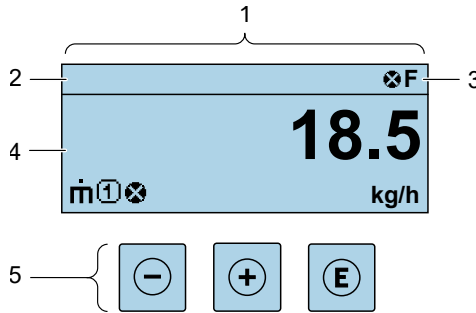

A0054806

Figure 26. Operational display

#	Name
1	Operational display
2	Device tag
3	Status area
4	Display area for measured values (4-line)
5	Operating elements →

Status area

The following symbols appear in the status area of the operational display at the top right:



- *Status signals* →
 - F:** Failure
 - C:** Function check
 - S:** Out of specification
 - M:** Maintenance required
- *Diagnostic behavior* → . The diagnostic behavior pertains to a diagnostic event that is relevant to the displayed measured variable, calculation error, or parameter misconfiguration. Refer to the **Measured variables** submenu.
 - Alarm
 - Warning
- Locking: the device is locked from the hardware
- Communication: communication through remote operation is active

Display area

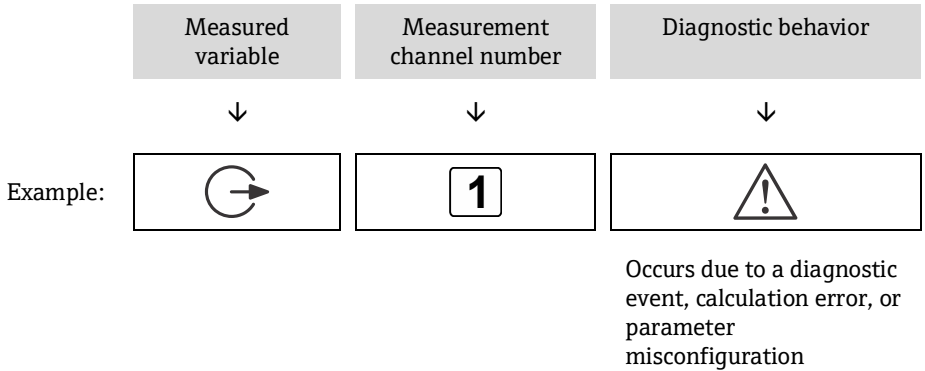
In the display area, each measured value is prefaced by certain symbol types for further description.



Measured variables

Symbol	Meaning
	Temperature Dew point temperature
	Output The measurement channel number indicates which of the outputs is displayed.
σ	Concentration
p	Pressure

Diagnostic behavior

 The number and display format of the measured values can be configured from the **Format display** parameter. Refer to the section **Configuring the local display** in the *JT33 TDLAS gas analyzer Operating Instructions*.

6.3.2 Navigation view

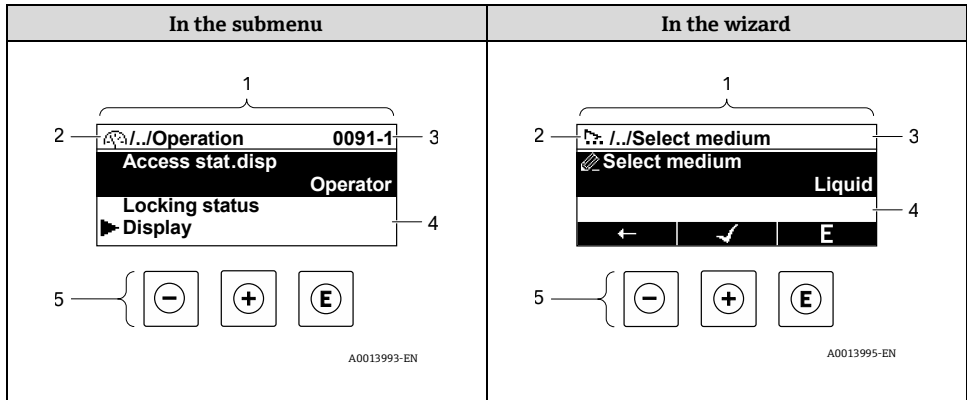

Figure 27. Navigation view

#	Name
1	Navigation view
2	Navigation path to current position
3	Status area
4	Display area for navigation
5	Operating elements →

Navigation path

The navigation path, displayed at the top left in the navigation view, consists of the following elements:

- In the submenu:
Display symbol for menu
- In the wizard:
Display symbol for wizard

Omission symbol for operating menu levels in between

- Name of current
 - Submenu
 - Wizard
 - Parameters



Example:



/ ./

Display



/ ./









Display

Status area



The following appears in the status area of the navigation view in the top right corner:

- **In the submenu:** If a diagnostic event is present, the Diagnostic behavior and Status signal.
- **In the wizard:** If a diagnostic event is present, the Diagnostic behavior and Status signal.

Display area

Symbol	Meaning
	Operation <ul style="list-style-type: none"> ▪ In the menu next to the Operation selection ▪ At the left in the navigation path in the Operation menu
	Setup <ul style="list-style-type: none"> ▪ In the menu next to the Setup selection ▪ At the left in the navigation path in the Setup menu
	Diagnostics <ul style="list-style-type: none"> ▪ In the menu next to the Diagnostics selection ▪ At the left in the navigation path in the Diagnostics menu
	Expert <ul style="list-style-type: none"> ▪ In the menu next to the Expert selection ▪ At the left in the navigation path in the Expert menu
	Submenu
	Wizard
	Parameters within a wizard No display symbol exists for parameters in submenus.
	Parameter locked. When displayed in front of a parameter name, indicates that the parameter is locked by 1 of the following methods: <ul style="list-style-type: none"> ▪ User-specific access code ▪ Hardware write protection switch

Wizard operation

Symbol	Meaning
	Switches to the previous parameter
	Confirms the parameter value and switches to the next parameter
	Opens the editing view of the parameter

6.3.3 Editing view

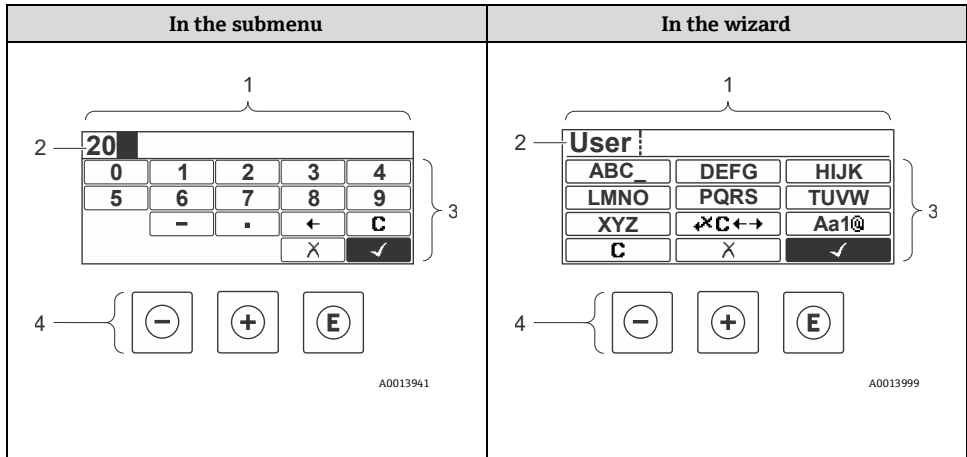









Figure 28. Editing view in the submenu and in the wizard

#	Name
1	Editing view
2	Display area of the entered values
3	Input mask
4	Operating elements → 





Input mask



The following input symbols are available in the input mask of the numeric and text editor:

Numeric editor





Symbol	Meaning
	Selection of numbers from 0 to 9
	Inserts decimal separator at the input position
	Inserts minus sign at the input position
	Confirms selection
	Moves the input position 1 position to the left
	Exits the input without applying the changes
	Clears all entered characters

Text editor



Symbol	Meaning
	Toggle <ul style="list-style-type: none"> ▪ Between uppercase and lowercase letters ▪ For entering numbers ▪ For entering special characters
	Selection of letters from uppercase A to Z
	Selection of letters from lowercase a to z
	Selection of special characters
	Confirms selection





Symbol	Meaning
	Switches to the selection of the correction tools
	Exits the input without applying the changes
	Clears all entered characters

Correction symbols under

Symbol	Meaning
	Clears all entered characters
	Moves the input position 1 position to the right
	Moves the input position 1 position to the left
	Deletes 1 character immediately to the left of the input position

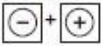
6.4 Operating elements

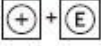
Symbol	Meaning
	<p>Minus key</p> <p>In a menu or submenu: Moves the selection bar up in a choose list</p> <p>With a wizard: Confirms the parameter value and goes to the previous parameter</p> <p>With a text and numeric editor: In the input mask, moves the selection bar backward to the left</p>
	<p>Plus key</p> <p>In a menu or submenu: Moves the selection bar down in a choose list</p> <p>With a wizard: Confirms the parameter value and goes to the next parameter</p> <p>With a text and numeric editor: Moves the selection bar forward to the right in an input screen</p>

Symbol	Meaning
	<p>Enter key</p> <p>For operational display:</p> <ul style="list-style-type: none"> ▪ Pressing the key briefly opens the operating menu ▪ Pressing the key for 2 seconds opens the context menu <p>In a menu or submenu,</p> <p>pressing the key briefly:</p> <ul style="list-style-type: none"> • Opens the selected menu, submenu, or parameter • Starts the wizard • If help text is open, closes the help text of the parameter <p>pressing the key for 2 seconds for parameter: If present, opens the help text for the function of the parameter</p> <p>With a wizard: Opens the editing view of the parameter</p> <p>With a text and numeric editor,</p> <p>pressing the key briefly:</p> <ul style="list-style-type: none"> • Opens the selected group • Carries out the selected action <p>pressing the key for 2 seconds confirms the edited parameter value</p>
	<p>Escape key combination, pressing keys simultaneously</p> <p>In a menu or submenu,</p> <p>pressing the key briefly:</p> <ul style="list-style-type: none"> • Exits the current menu level and takes you to the next higher level • If help text is open, closes the help text of the parameter <p>pressing the key for 2 seconds returns user to the operational display in home position</p> <p>With a wizard: Exits the wizard and takes you to the next higher level</p> <p>With a text and numeric editor: Closes the text or numeric editor without applying changes</p>
	<p>Minus/Enter key combination, pressing the keys simultaneously</p> <p>Reduces the contrast to a brighter setting</p>
	<p>Plus/Enter key combination, pressing and holding down the keys simultaneously</p> <p>Increases the contrast to a darker setting</p>
	<p>Minus/Plus/Enter key combination, pressing the keys simultaneously</p> <p>For operational display: Enables or disables the keypad lock; only SD02 display module</p>

6.4.1 Navigating and selecting

Different operating elements are used to navigate through the operating menu. The navigation path is displayed on the left in the header. Icons are displayed in front of the individual menus. These icons are also shown in the header during navigation.

6.4.2 Further information



For information on the following topics, see *JT33 TDLAS gas analyzer Operating Instructions (BA02297C)*:

- Calling up help text
- Changing the parameters
- User roles and related access authorization
- Disabling write protection with access code
- Enabling and disabling the keypad lock

6.5 Access the operating menu from the web browser

The device can also be operated and configured through a web browser through a service interface (CDI-RJ45) and connected for Modbus TCP signal transmission. Refer to the *JT33 TDLAS gas analyzer Operating Instructions (BA02297C)* for additional information.

6.6 Remote operation using Modbus

Refer to the *JT33 TDLAS gas analyzer Operating Instructions (BA02297C)* for connection information through the Modbus RS485 protocol and Modbus TCP protocol.

7 Commissioning

7.1 Language

Factory setting: English

7.2 Configuring the measuring device

The **Setup** menu with its guided wizards contains all the parameters needed for standard operation.

Navigation to the Setup menu

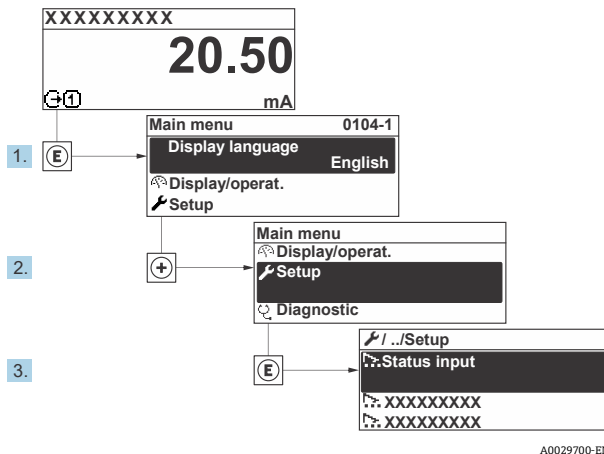

A0029700-EN

Figure 29. Local display example

i Depending on the device version, not all submenus and parameters are available in every device. The selection can vary depending on the order code.

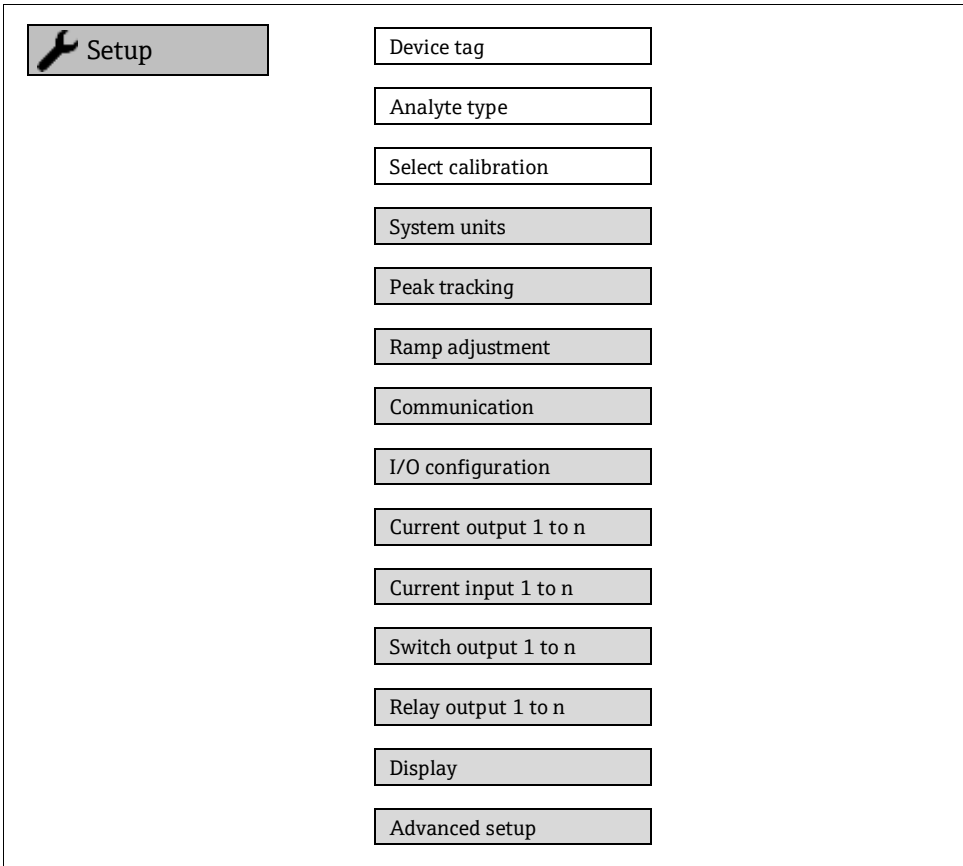

7.3 Protecting settings from unauthorized access

Refer to the *JT33 TDLAS gas analyzer Operating Instructions (BA02297C)* for detailed information on protecting the settings against unauthorized access.

8 Diagnostic information

8.1 Diagnostic information from light-emitting diodes

8.1.1 Controller

Different LEDs in the controller provide information on the device status.

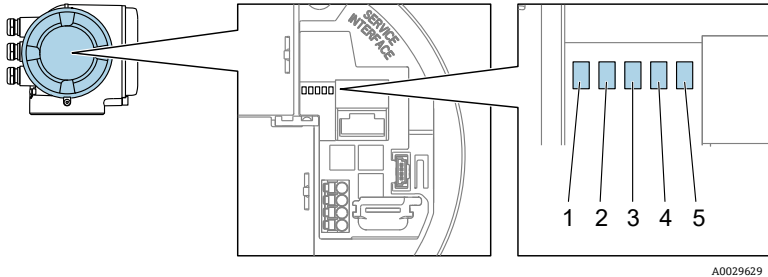

A0029629

Figure 30. LED diagnostic indicators

#	LED	Color	Meaning
1	Supply voltage	Off	Supply voltage is off or too low
		Green	Supply voltage is ok
2	Device Status	Off	Firmware error
		Green	Device status is ok
		Flashing green	Device is not configured
		Flashing red	A device event with Warning Diagnostic behavior has occurred
		Red	A device event with Alarm Diagnostic behavior has occurred
	Flashing red/green	Device restart	
3	Not used	–	–
4	Communication	White	Communication active
		Off	Communication not active

#	LED	Color	Meaning
5	Service interface (CDI) active	Off	Not connected or no connection established
		Yellow	Connected and connection established
		Flashing yellow	Service interface active

8.2 Diagnostic information on local display

8.2.1 Diagnostic message

Faults detected by the self-monitoring system of the measuring device are displayed as a diagnostic message in alternation with the operational display.

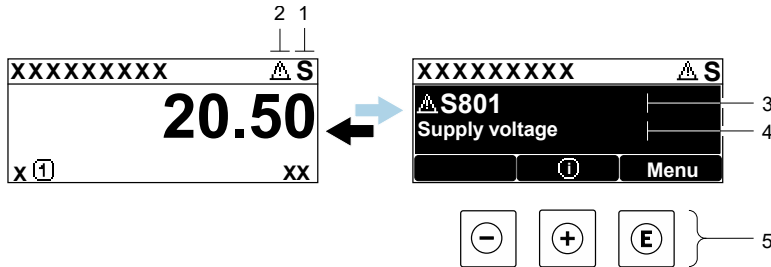

A0029426-EN

Figure 31. Diagnostic message

#	Description
1	Status signal
2	Diagnostic behavior
3	Diagnostic behavior with diagnostic code
4	Short text
5	Operating elements →

If 2 or more diagnostic events are pending simultaneously, only the message of the diagnostic event with the highest priority is shown.

Other diagnostic events that have occurred can be displayed in the **Diagnostics** menu:



- From parameters
- Through submenus

8.2.1.1 Status signals

The status signals provide information on the state and reliability of the device by categorizing the cause of the diagnostic information or event. The status signals are categorized according to VDI/VDE 2650 and NAMUR Recommendation NE 107.

Symbol	Meaning
F	Failure. A device error has occurred. The measured value is no longer valid.
C	Function check. The device is in service mode, such as during a simulation.
S	Out of specification. The device is operated outside its technical specification limits, such as outside the process temperature range.
M	Maintenance required. Maintenance is required. The measured value remains valid.

8.2.1.2 Diagnostic behavior



Symbol	Meaning
	Alarm. Measurement is interrupted. Signal outputs assume the defined alarm condition. A diagnostic message is generated.
	Warning. Measurement is resumed. The signal outputs are not affected. A diagnostic message is generated.

8.2.1.3 Diagnostic information

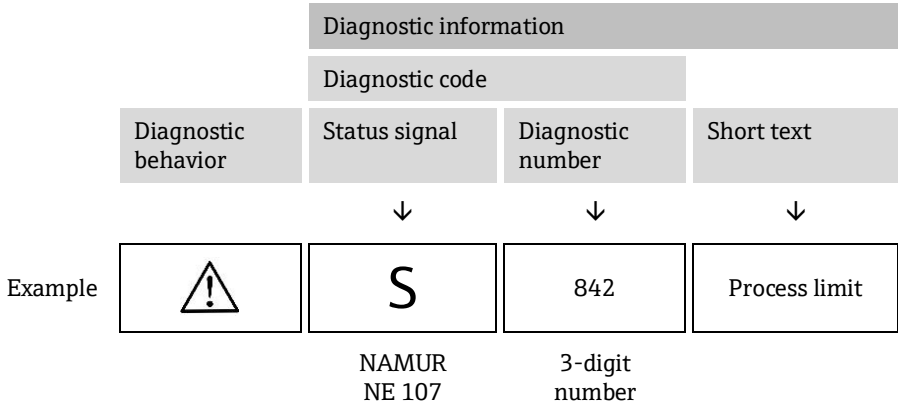
The fault can be identified using the diagnostic information. The Short text helps you by providing information about the fault. In addition, the corresponding symbol for the Diagnostic behavior is displayed in front of the diagnostic information on the local display.



8.2.1.4 Operating elements

Symbol	Meaning
	Plus key. In a menu or submenu, opens the message about remedy information.
	Enter key. In a menu or submenu, opens the operating menu.

Calling up remedial measures

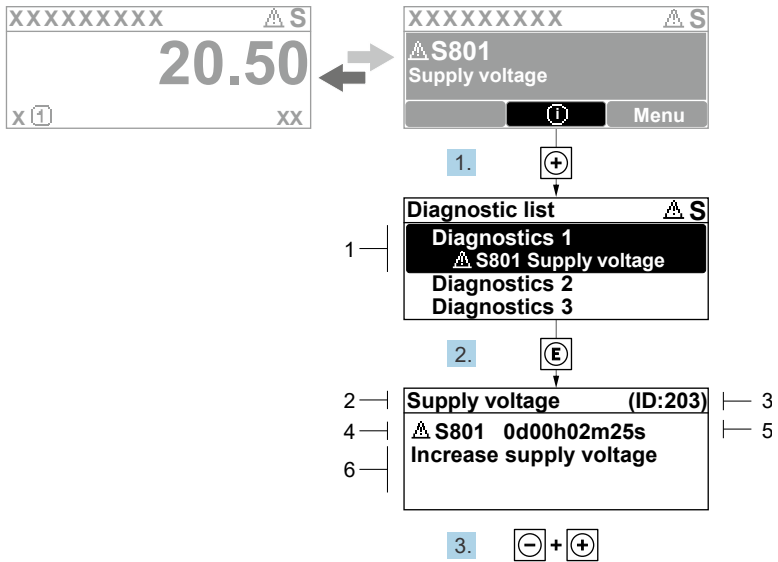

A0029431-EN

Figure 32. Message for remedial measures

#	Description
1	Diagnostic information
2	Short text
3	Service ID
4	Diagnostic behavior with diagnostic code
5	Operation time of occurrence
6	Remedial measures

The user is in the diagnostic message.

1. Press **+** (ⓘ symbol)
 - ↳ The Diagnostic list submenu opens.
2. Select the desired diagnostic event with **+** or **-** and press **⏏**.
 - ↳ The message for the remedial measures for the selected diagnostic event opens.
3. Press **-** + **+** simultaneously.
 - ↳ The message for the remedial measures closes.

The user is in the **Diagnos**tics menu at an entry for a diagnostics event, such as in the **Diagnostic list** submenu or **Previous diagnostics** parameter.

4. Press \square .

↳ The message for the remedial measures for the selected diagnostic event opens.

5. Press \square + \oplus simultaneously.

↳ The message for the remedial measures closes.

8.3 Diagnostic information in the web browser

Refer to the *JT33 TDLAS gas analyzer Operating Instructions (BA02297C)* for details about diagnostic information in the web browser.

8.4 Diagnostic information through the communication interface

Refer to the *JT33 TDLAS gas analyzer Operating Instructions (BA02297C)* for details about diagnostic information through the communication interface.

8.5 Overview of diagnostic information

The amount of diagnostic information and the number of measured variables affected increases if the measuring device has 1 or more application packages. In the case of some items of diagnostic information, the diagnostic behavior can be changed.

Refer to the *JT33 TDLAS gas analyzer Operating Instructions (BA02297C)* for diagnostic information, including a table of remedy instructions based on diagnostic number.

8.6 General troubleshooting

Troubleshooting for local display and output signals is listed below. Refer to the *JT33 TDLAS gas analyzer Operating Instructions (BA02297C)* for additional troubleshooting.

For local display

Error	Possible Causes	Solution
Local display dark and no output signals	Supply voltage does not match the value indicated on the nameplate.	Apply the correct supply voltage. Refer to the section Connecting the supply voltage and additional inputs/outputs in the Operating Instructions.
	The polarity of the supply voltage is wrong.	Correct the polarity.
	No contact between connecting cables and terminals.	Check the cable connection and correct if necessary.
	Terminals are not plugged into the I/O electronics module correctly. Terminals are not plugged into the main electronics module correctly.	Check terminals.
	I/O electronics module is defective. Main electronics module is defective.	Order spare part.
Local display is dark, but signal output is within the valid range	Display is set too bright or too dark.	<ul style="list-style-type: none"> ▪ Set the display brighter by simultaneously pressing $\boxed{+}$ + \boxed{E}. ▪ Set the display darker by simultaneously pressing $\boxed{-}$ + \boxed{E}.
	The display module cable is not plugged in correctly.	Insert the plug correctly into the main electronics module and display module.
	Display module is defective.	Order spare part.
Backlighting of local display is red	Diagnostic event with Alarm Diagnostic behavior has occurred.	Take remedial measures.

Error	Possible Causes	Solution
Message on local display: “Communication Error” “Check Electronics”	Communication between the display module and the electronics is interrupted.	Check the cable and the connector between the main electronics module and display module. Order spare part.

For output signals

Error	Possible Causes	Solution
Signal output outside the valid range	Main electronics module is defective.	Order spare part.
Device shows correct value on local display, but signal output is incorrect, though in the valid range.	Configuration error.	Check and correct the parameter configuration.
Device measures incorrectly.	Configuration error, or the device is operated outside the application.	<ol style="list-style-type: none"> 1. Check and correct parameter configuration. 2. Observe limit values specified in the Technical Data.

www.addresses.endress.com
