

Operating Instructions

Memosens CLS16E

Conductivity sensor with Memosens protocol
For contacting conductivity measurement in liquids







Table of contents









1	About this document	3	10	Technical data	15
1.1	Warnings	3	10.1	Input	15
1.2	Symbols	3	10.2	Performance characteristics	15
1.3	Documentation	3	10.3	Environment	16
2	Basic safety instructions	4	10.4	Process	16
2.1	Requirements of the personnel	4	10.5	Mechanical construction	17
2.2	Intended use	4			
2.3	Workplace safety	4	Index		18
2.4	Operational safety	5			
2.5	Product security	5			
3	Incoming acceptance and product identification	5			
3.1	Incoming acceptance	5			
3.2	Product identification	6			
3.3	Scope of delivery	6			
4	Mounting	7			
4.1	Mounting requirements	7			
4.2	Mounting the sensor	7			
4.3	Post-mounting checks	8			
5	Electrical connection	8			
5.1	Connecting the sensor	9			
5.2	Ensuring the degree of protection	9			
5.3	Post-connection check	9			
6	Commissioning	10			
7	Maintenance	10			
8	Repair	11			
8.1	General notes	11			
8.2	Spare parts	12			
8.3	Endress+Hauser services	12			
8.4	Return	12			
8.5	Disposal	13			
9	Accessories	14			
9.1	Measuring cables	14			
9.2	Sensor regeneration	14			
9.3	Calibration solutions	14			
9.4	Calibration set	15			

1 About this document

1.1 Warnings

Structure of information	Meaning
<p> DANGER</p> <p>Causes (/consequences) If necessary, Consequences of non-compliance (if applicable)</p> <ul style="list-style-type: none"> ▶ Corrective action 	<p>This symbol alerts you to a dangerous situation. Failure to avoid the dangerous situation will result in a fatal or serious injury.</p>
<p> WARNING</p> <p>Causes (/consequences) If necessary, Consequences of non-compliance (if applicable)</p> <ul style="list-style-type: none"> ▶ Corrective action 	<p>This symbol alerts you to a dangerous situation. Failure to avoid the dangerous situation can result in a fatal or serious injury.</p>
<p> CAUTION</p> <p>Causes (/consequences) If necessary, Consequences of non-compliance (if applicable)</p> <ul style="list-style-type: none"> ▶ Corrective action 	<p>This symbol alerts you to a dangerous situation. Failure to avoid this situation can result in minor or more serious injuries.</p>
<p> NOTICE</p> <p>Cause/situation If necessary, Consequences of non-compliance (if applicable)</p> <ul style="list-style-type: none"> ▶ Action/note 	<p>This symbol alerts you to situations which may result in damage to property.</p>

1.2 Symbols

-  Additional information, tips
-  Permitted
-  Recommended
-  Not permitted or not recommended
-  Reference to device documentation
-  Reference to page
-  Reference to graphic
-  Result of an individual step

1.3 Documentation

 Technical Information Memosens CLS16E, TI01527C

 Special Documentation for hygienic applications, SD02751C

In addition to these Operating Instructions, an XA with "Safety instructions for electrical apparatus in the hazardous area" is also included with sensors for use in the hazardous area.

- ▶ Please follow instructions on use in the hazardous area carefully.

2 Basic safety instructions

2.1 Requirements of the personnel

- Installation, commissioning, operation and maintenance of the measuring system may be carried out only by specially trained technical personnel.
- The technical personnel must be authorized by the plant operator to carry out the specified activities.
- The electrical connection may be performed only by an electrical technician.
- The technical personnel must have read and understood these Operating Instructions and must follow the instructions contained therein.
- Faults at the measuring point may only be rectified by authorized and specially trained personnel.



Repairs not described in the Operating Instructions provided must be carried out only directly at the manufacturer's site or by the service organization.

2.2 Intended use

The conductivity sensor is designed for the conductive measurement of the conductivity of liquids.

It is used in the following areas:

Measurements in pure and ultrapure water with hygienic requirements

Any use other than that intended puts the safety of people and the measuring system at risk. Therefore, any other use is not permitted.

The manufacturer is not liable for harm caused by improper or unintended use.

2.3 Workplace safety

As the user, you are responsible for complying with the following safety conditions:

- Installation guidelines
- Local standards and regulations
- Regulations for explosion protection

Electromagnetic compatibility

- The product has been tested for electromagnetic compatibility in accordance with the applicable international standards for industrial applications.
- The electromagnetic compatibility indicated applies only to a product that has been connected in accordance with these Operating Instructions.

2.4 Operational safety

Before commissioning the entire measuring point:

1. Verify that all connections are correct.
2. Ensure that electrical cables and hose connections are undamaged.
3. Do not operate damaged products, and protect them against unintentional operation.
4. Label damaged products as defective.

During operation:

- ▶ If faults cannot be rectified, take products out of service and protect them against unintentional operation.

2.5 Product security

The product is designed to meet state-of-the-art safety requirements, has been tested, and left the factory in a condition in which it is safe to operate. The relevant regulations and international standards have been observed.

3 Incoming acceptance and product identification

3.1 Incoming acceptance

1. Verify that the packaging is undamaged.
 - ↳ Notify the supplier of any damage to the packaging.
Keep the damaged packaging until the issue has been resolved.
2. Verify that the contents are undamaged.
 - ↳ Notify the supplier of any damage to the delivery contents.
Keep the damaged goods until the issue has been resolved.
3. Check that the delivery is complete and nothing is missing.
 - ↳ Compare the shipping documents with your order.
4. Pack the product for storage and transportation in such a way that it is protected against impact and moisture.
 - ↳ The original packaging offers the best protection.
Make sure to comply with the permitted ambient conditions.

If you have any questions, please contact your supplier or your local Sales Center.

3.2 Product identification

3.2.1 Nameplate

The nameplate provides you with the following information on your device:

- Manufacturer identification
- Extended order code
- Serial number
- Safety information and warnings

► Compare the information on the nameplate with the order.

3.2.2 Product identification

Product page

www.endress.com/cls16e

Interpreting the order code

The order code and serial number of your product can be found in the following locations:

- On the nameplate
- In the delivery papers

Obtaining information on the product

1. Go to www.endress.com.
2. Page search (magnifying glass symbol): Enter valid serial number.
3. Search (magnifying glass).
 - ↳ The product structure is displayed in a popup window.
4. Click the product overview.
 - ↳ A new window opens. Here you fill information pertaining to your device, including the product documentation.

Manufacturer address

Endress+Hauser Conducta GmbH+Co. KG
Dieselstraße 24
70839 Gerlingen
Germany

3.3 Scope of delivery

The scope of delivery includes:

- Sensor (version as ordered)
- Operating instructions
- XA, Safety instructions for electrical equipment in hazardous areas (optional)
- Final inspection report

4 Mounting

4.1 Mounting requirements

4.1.1 General installation instructions

The sensors are installed directly via the process connection.

- ▶ If using the sensor in the ultrapure water range, you must work under air-evacuated conditions.
 - ↳ Otherwise the CO_2 in the air can dissolve in the water and its (weak) dissociation can increase the conductivity by up to $3 \mu\text{S}/\text{cm}$.

4.1.2 Hygiene-compliant installation

- ▶ Easily cleanable installation of equipment according to the criteria of the EHEDG must be free of dead legs.
- ▶ If a dead leg is unavoidable, it shall be kept as short as possible. Under no circumstances shall the length of a dead leg L exceed the pipe's inner diameter D minus the equipment's enveloping diameter d . The condition $L \leq D - d$ applies.
- ▶ Furthermore, the dead leg must be self-draining, so neither product nor process fluids are retained therein.
- ▶ Within tank installations, the cleaning device must be located so that it directly flushes the dead leg.
- ▶ For further reference, see the recommendations concerning hygienic seals and installations in EHEDG Doc. 10 and the Position Paper: "Easy cleanable Pipe couplings and Process connections".

For 3-A-compliant installation, please observe the following:

- ▶ After the device has been mounted, hygienic integrity must be guaranteed.
- ▶ 3-A-compliant process connections must be used.

4.2 Mounting the sensor

1. Install the sensor via the process connection or an assembly.

2.

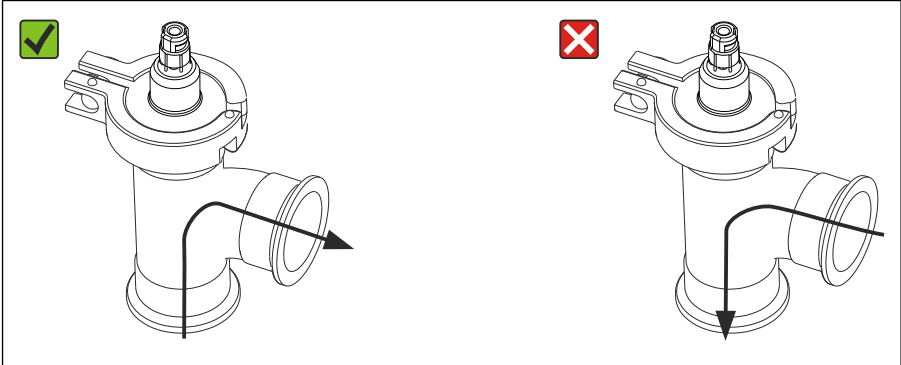

A0042910

When installing in pipes:
Pay attention to the flow direction.

3. Ensure that the electrodes are fully immersed in the medium during measurement. Immersion depth: at least 35 mm (1.38").

4.3 Post-mounting checks

1. Are the sensor and cable undamaged?
2. Is the sensor installed in the process connection and is not suspended from the cable?

5 Electrical connection

⚠ WARNING

Device is live!

Incorrect connection may result in injury or death!

- ▶ The electrical connection may be performed only by an electrical technician.
- ▶ The electrical technician must have read and understood these Operating Instructions and must follow the instructions contained therein.
- ▶ **Prior** to commencing connection work, ensure that no voltage is present on any cable.

5.1 Connecting the sensor

The electrical connection of the sensor to the transmitter is established using measuring cable CYK10.

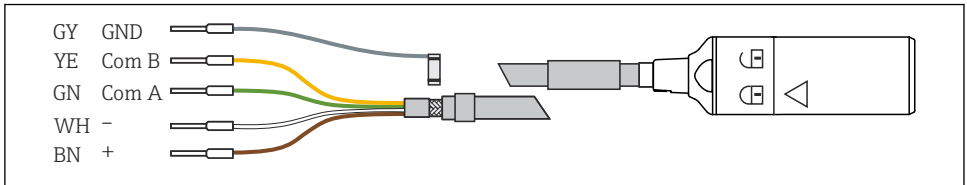

A0024019

1 Measuring cable CYK10

5.2 Ensuring the degree of protection

Only the mechanical and electrical connections which are described in these instructions, and which are necessary for the required intended use, may be established on the device delivered.

- ▶ Exercise care when carrying out the work.

Otherwise, the individual types of protection (Ingress Protection (IP), electrical safety, EMC interference immunity) agreed for this product can no longer be guaranteed due, for example, to covers being left off or cable (ends) that are loose or insufficiently secured.

5.3 Post-connection check

⚠ WARNING

Connection errors

The safety of people and of the measuring point is at risk! The manufacturer does not accept any responsibility for errors that result from failure to comply with the instructions in this manual.

- ▶ Put the measuring point into operation only if you can answer **yes** to **all** the following questions.

Product status and specifications

- ▶ Are the sensor and cable free from damage on the outside?

Electrical connection

- ▶ Is the installed cable strain-relieved and not twisted?
- ▶ Is a sufficient length of the cable cores stripped, and are the cores correctly positioned in the terminal on the transmitter?
- ▶ Are all plug-in terminals on the transmitter securely engaged?
- ▶ Are all cable entries mounted on the transmitter, tightened and leak-tight?

6 Commissioning

Prior to initial commissioning, ensure that:

- The sensor is correctly installed
- The electrical connection is correct

1. Check the temperature compensation and damping settings on the transmitter.

 Operating Instructions of the transmitter being used, e.g. BA01245C if using Liquiline CM44x or CM44xR.

WARNING

Escaping process medium

Risk of injury from high pressure, high temperatures or chemical hazards!

- ▶ Before applying pressure to an assembly with cleaning system, ensure that the system has been connected correctly.
- ▶ If you cannot reliably establish the correct connection, do not install the assembly in the process.

If using an assembly with automatic cleaning function:

2. Check that the cleaning medium (water or air, for example) is connected correctly.

3. Following commissioning:

Maintain the sensor at regular intervals.

- ↳ This is the only way to ensure reliable measurements.

 As the sensor can be operated with a nominal pressure greater than 1 bar (15 psi), it has been registered according to CSA B51 ("Boiler, pressure vessel, and pressure piping code"; category F) with a CRN (Canadian Registration Number) in all Canadian provinces.

The CRN is located on the nameplate.

7 Maintenance

WARNING

Thiocarbamide

Harmful if swallowed! Limited evidence of carcinogenicity! Possible risk of harm to the unborn child! Dangerous for the environment with long-term effects!

- ▶ Wear protective goggles, protective gloves and appropriate protective clothing.
- ▶ Avoid all contact with the eyes, mouth and skin.
- ▶ Avoid discharge into the environment.

⚠ CAUTION**Corrosive chemicals**

Risk of chemical burns to the eyes and skin and risk of damage to clothing and equipment!

- ▶ It is absolutely essential to protect the eyes and hands properly when working with acids, alkalis and organic solvents!
- ▶ Wear protective goggles and safety gloves.
- ▶ Clean away splashes on clothes and other objects to prevent any damage.
- ▶ Comply with instructions in the safety data sheets for the chemicals used.

Clean away fouling on the sensor as follows depending on the type of fouling:

1. Oily and greasy films:
Clean with grease remover, e.g. alcohol, or hot water with an alkaline agent.
2. Lime and metal hydroxide buildup and low solubility (lyophobic) organic buildup:
Dissolve buildup with diluted hydrochloric acid (3 %) and then rinse thoroughly with plenty of clear water.
3. Sulfidic buildup (from flue gas desulfurization or wastewater treatment plants):
Use a mixture of hydrochloric acid (3 %) and thiocarbamide (commercially available) and then rinse thoroughly with plenty of clear water.
4. Buildup containing protein (e.g. in the food industry):
Use a mixture of hydrochloric acid (0.5 %) and pepsin (commercially available) and then rinse thoroughly with plenty of clear water.
5. Readily soluble biological buildup:
Rinse with pressurized water.

After cleaning, rinse the sensor thoroughly with plenty of water.

8 Repair

8.1 General notes

The repair and conversion concept provides for the following:

- The product has a modular design
- Spare parts are grouped into kits which include the associated kit instructions
- Only use original spare parts from the manufacturer
- Repairs are carried out by the manufacturer's Service Department or by trained users
- Certified devices can only be converted to other certified device versions by the manufacturer's Service Department or at the factory
- Observe applicable standards, national regulations, Ex documentation (XA) and certificates

1. Carry out the repair according to the kit instructions.
2. Document the repair and conversion and enter, or have entered, in the Life Cycle Management tool (W@M).

8.2 Spare parts

Device spare parts that are currently available for delivery can be found on the website:

<https://portal.endress.com/webapp/SparePartFinder>

- ▶ Quote the serial number of the device when ordering spare parts.

8.3 Endress+Hauser services

Intact seals are a prerequisite for safe and reliable measurements. The seal should be replaced at regular intervals to guarantee maximum sensor operational safety and hygiene.

Practical repair intervals can only be determined by the user as they depend greatly on the operating conditions, such as:

- Type and temperature of the product
- Type and temperature of the cleaning agent
- Number of cleanings
- Number of sterilizations
- Operating environment

Recommended intervals for seal replacement (reference values)

Application	Window
Media with temperatures from 50 to 100 °C (122 to 212 °F)	Approx. 18 months
Media with temperatures < 50 °C (122 °F)	Approx. 36 months
Sterilization cycles, max. 150 °C (302 °F), 45 min.	Approx. 400 cycles

To ensure your sensor is operational again after being exposed to very high loads, you can have it regenerated in the factory. In the factory, the sensor is fitted with new seals and recalibrated.

Please contact your sales office for information on replacing the seal and recalibration in the factory.

8.4 Return

The product must be returned if repairs or a factory calibration are required, or if the wrong product was ordered or delivered. As an ISO-certified company and also due to legal regulations, Endress+Hauser is obliged to follow certain procedures when handling any returned products that have been in contact with medium.

To ensure the swift, safe and professional return of the device:

- ▶ Check the website www.endress.com/support/return-material for information on the procedure and general conditions.

8.5 Disposal



If required by the Directive 2012/19/EU on waste electrical and electronic equipment (WEEE), the product is marked with the depicted symbol in order to minimize the disposal of WEEE as unsorted municipal waste. Do not dispose of products bearing this marking as unsorted municipal waste. Instead, return them to the manufacturer for disposal under the applicable conditions.

9 Accessories

The following are the most important accessories available at the time this documentation was issued.

Listed accessories are technically compatible with the product in the instructions.

1. Application-specific restrictions of the product combination are possible.
Ensure conformity of the measuring point to the application. This is the responsibility of the operator of the measuring point.
2. Pay attention to the information in the instructions for all products, particularly the technical data.
3. For accessories not listed here, please contact your Service or Sales Center.

9.1 Measuring cables

Memosens data cable CYK10

- For digital sensors with Memosens technology
- Product Configurator on the product page: www.endress.com/cyk10



Technical Information TI00118C

Memosens data cable CYK11

- Extension cable for digital sensors with Memosens protocol
- Product Configurator on the product page: www.endress.com/cyk11



Technical Information TI00118C

9.2 Sensor regeneration

Replacement of seals and recalibration in the factory
Order No. 51505585

9.3 Calibration solutions

Conductivity calibration solutions CLY11

Precision solutions referenced to SRM (Standard Reference Material) by NIST for qualified calibration of conductivity measuring systems in accordance with ISO 9000

- CLY11-A, 74 $\mu\text{S}/\text{cm}$ (reference temperature 25 °C (77 °F)), 500 ml (16.9 fl.oz)
Order No. 50081902
- CLY11-B, 149.6 $\mu\text{S}/\text{cm}$ (reference temperature 25 °C (77 °F)), 500 ml (16.9 fl.oz)
Order No. 50081903



Technical Information TI00162C

9.4 Calibration set

Conducal CLY421

- Conductivity calibration set (case) for ultrapure water applications
- Complete, factory-calibrated measuring system with certificate, for comparative measurement in ultrapure water up to max. 20 $\mu\text{S}/\text{cm}$
- Product Configurator on the product page: www.endress.com/cly421



Technical Information TI00496C/07/EN

10 Technical data

10.1 Input

10.1.1 Measured values

- Conductivity
- Temperature

10.1.2 Measuring ranges

Conductivity ¹⁾	40 nS/cm to 500 $\mu\text{S}/\text{cm}$
Temperature	-5 to 150 °C (23 to 302 °F)

1) In relation to water at 25 °C (77 °F)

10.1.3 Cell constant

$k = 0.1 \text{ cm}^{-1}$

10.1.4 Temperature compensation

Pt1000 (Class A according to IEC 60751)

10.2 Performance characteristics

10.2.1 Measurement uncertainty

Each individual sensor is factory-measured in a solution with approx. 5 $\mu\text{S}/\text{cm}$ using a reference measuring system traceable to NIST or PTB. The exact cell constant is entered into the manufacturer's certificate supplied. The measurement uncertainty in determining the cell constant is 1.0 %.

10.2.2 Response time

Conductivity $t_{95} \leq 2 \text{ s}$

Temperature ¹⁾ $t_{90} \leq 9 \text{ s}$

1) DIN VDI/VDE 3522-2 (0.3 m/s laminar)

10.2.3 Measurement error

Conductivity $\leq 2 \%$ of reading, in specified measuring range

Temperature $\leq 0.5 \text{ K}$, in measuring range -5 to $120 \text{ }^\circ\text{C}$ (23 to $248 \text{ }^\circ\text{F}$)

$\leq 1.0 \text{ K}$, in measuring range 120 to $150 \text{ }^\circ\text{C}$ (248 to $302 \text{ }^\circ\text{F}$)

10.2.4 Repeatability

Conductivity $\leq 0.2 \%$ of reading, in specified measuring range

Temperature $\leq 0.05 \text{ K}$

10.3 Environment

10.3.1 Ambient temperature

-20 to $60 \text{ }^\circ\text{C}$ (-4 to $140 \text{ }^\circ\text{F}$)

10.3.2 Storage temperature

-25 to $+80 \text{ }^\circ\text{C}$ (-10 to $+180 \text{ }^\circ\text{F}$)

10.3.3 Degree of protection

IP 68 / NEMA type 6P (1.9 m water column, $20 \text{ }^\circ\text{C}$, 24 h)

10.4 Process

10.4.1 Process temperature

Normal operation -5 to $120 \text{ }^\circ\text{C}$ (23 to $248 \text{ }^\circ\text{F}$)

Sterilization (max. 45 min) Max. $150 \text{ }^\circ\text{C}$ ($302 \text{ }^\circ\text{F}$) at 6 bar (87 psi) absolute

10.4.2 Pressure

13 bar (188 psi) absolute, at $20 \text{ }^\circ\text{C}$ ($68 \text{ }^\circ\text{F}$)

9 bar (130 psi) absolute, at $120 \text{ }^\circ\text{C}$ ($248 \text{ }^\circ\text{F}$)

0.1 bar (1.5 psi) absolute (vacuum), at $20 \text{ }^\circ\text{C}$ ($68 \text{ }^\circ\text{F}$)

10.4.3 Temperature/pressure rating

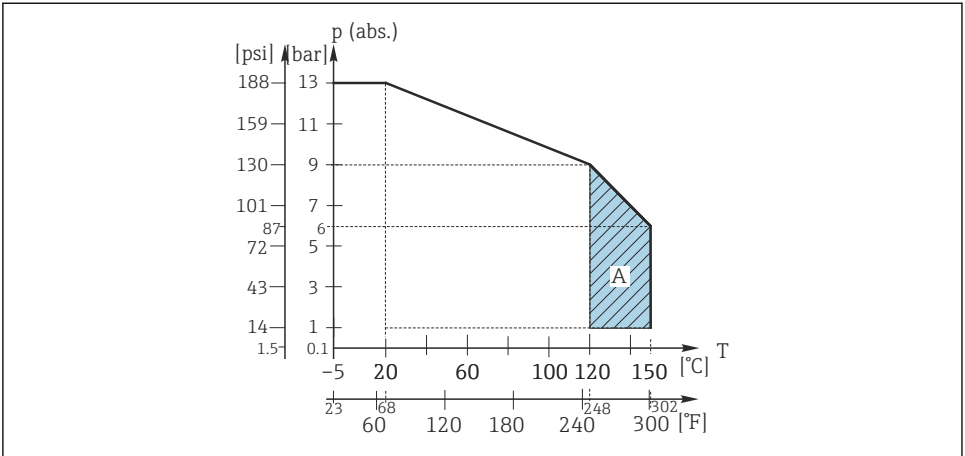

A0044756

2 Mechanical pressure-temperature resistance

A Can be sterilized for a short time (45 min.)

10.5 Mechanical construction

10.5.1 Weight

Approx. 0.13 to 0.75 kg (0.29 to 1.65 lbs) depending on version

10.5.2 Materials (in contact with medium)

Sensor

Depending on the order version:

- Electropolished, stainless steel 1.4435 (AISI 316L)
- PEEK

Seal

Depending on the order version:

- Molded seal FFKM
- Molded seal EPDM

10.5.3 Process connection

1½", 2" as per ISO 2852 (also suitable for TRI-CLAMP, DIN 32676)

Tuchenhagen VARIVENT N DN 50 to 125

NEUMO BioControl D50

10.5.4 Surface roughness

$R_a \leq 0.38 \mu\text{m}$, electropolished

Index

A

Ambient temperature 16

C

Cell constant 15

Check

 Connection 9

 Mounting 8

Connection

 Check 9

 Ensuring the degree of protection 9

D

Degree of protection

 Ensuring 9

 Technical data 16

Disposal 13

Documentation 3

E

Electrical connection 8

I

Incoming acceptance 5

Intended use 4

M

Materials 17

Measured values 15

Measurement error 16

Measurement uncertainty 15

Measuring ranges 15

Mounting

 Check 8

 Sensor 7

N

Nameplate 6

O

Operational safety 5

P

Performance characteristics 15

Pressure 16

Pressure/temperature rating 17

Process connection 17

Process temperature 16

Product identification 6

Product security 5

R

Recalibration 12

Regeneration 12

Repair 11

Repeatability 16

Replacing the seal 12

Response time 16

Return 12

S

Safety

 Operation 5

 Product 5

 Workplace safety 4

Scope of delivery 6

Sensor

 Cleaning 10

 Connecting 9

 Installing 7

Spare parts 12

Storage temperature 16

Surface roughness 17

Symbols 3

T

Technical data

 Environment 16

 Input 15

 Mechanical construction 17

 Performance characteristics 15

 Process 16

Temperature compensation 15

Temperature/pressure rating 17

U

Use 4

W

Warnings 3

Weight 17

Workplace safety 4



71649264

www.addresses.endress.com
