

# Brief Operating Instructions

## Measuring device for total solids measurement

### Proline 300

Modbus RS485 transmitter  
for total solids measurement via microwave  
transmission



These instructions are Brief Operating Instructions; they are **not** a substitute for the Operating Instructions pertaining to the device.

**Brief Operating Instructions part 2 of 2: Transmitter**  
Contain information about the transmitter.

Brief Operating Instructions part 1 of 2: Sensor →  3



A0023555

## Brief operating instructions Measuring device for total solids measurement

The device consists of a transmitter and a sensor.

The process of commissioning these two components is described in two separate manuals which together form the Brief Operating Instructions for the measuring device for total solids measurement:

- Brief Operating Instructions Part 1: Sensor
- Brief Operating Instructions Part 2: Transmitter

Please refer to both parts of the Brief Operating Instructions when commissioning the device, as the contents of the manuals complement one another:

### Brief Operating Instructions Part 1: Sensor

The Sensor Brief Operating Instructions are aimed at specialists with responsibility for installing the measuring device.

- Incoming acceptance and product identification
- Storage and transport
- Mounting procedure

### Brief Operating Instructions Part 2: Transmitter

The Transmitter Brief Operating Instructions are aimed at specialists with responsibility for commissioning, configuring and parameterizing the measuring device (until the first measured value).

- Product description
- Mounting procedure
- Electrical connection
- Operation options
- System integration
- Commissioning
- Diagnostic information

## Additional device documentation



These Brief Operating Instructions are **Brief Operating Instructions Part 2: Transmitter**.

The "Brief Operating Instructions Part 1: Sensor" are available via:

- Internet: [www.endress.com/deviceviewer](http://www.endress.com/deviceviewer)
- Smart phone/tablet: *Endress+Hauser Operations App*

Detailed information about the device can be found in the Operating Instructions and the other documentation:

- Internet: [www.endress.com/deviceviewer](http://www.endress.com/deviceviewer)
- Smart phone/tablet: *Endress+Hauser Operations App*

# Table of contents

<b>1</b>	<b>About this document</b>	<b>5</b>
1.1	Symbols used	5
<b>2</b>	<b>Safety instructions</b>	<b>7</b>
2.1	Requirements for the personnel	7
2.2	Intended use	7
2.3	Workplace safety	8
2.4	Operational safety	8
2.5	Product safety	8
2.6	IT security	8
2.7	Device-specific IT security	9
<b>3</b>	<b>Product description</b>	<b>10</b>
3.1	Product design	10
<b>4</b>	<b>Mounting procedure</b>	<b>11</b>
4.1	Mounting the sensor	11
4.2	Mounting the transmitter	11
4.3	Weather protection cover	13
4.4	Transmitter post-installation check	14
<b>5</b>	<b>Electrical connection</b>	<b>15</b>
5.1	Electrical safety	15
5.2	Connecting requirements	15
5.3	Connecting the measuring device	18
5.4	Potential equalization	22
5.5	Special connection instructions	23
5.6	Hardware settings	27
5.7	Ensuring the degree of protection	29
5.8	Post-connection check	30
<b>6</b>	<b>Operation options</b>	<b>31</b>
6.1	Overview of operation options	31
6.2	Structure and function of the operating menu	32
6.3	Access to operating menu via local display	33
6.4	Access to the operating menu via the operating tool	36
6.5	Access to the operating menu via the web server	36
<b>7</b>	<b>System integration</b>	<b>37</b>
<b>8</b>	<b>Commissioning</b>	<b>38</b>
8.1	Installation and function check	38
8.2	Setting the operating language	38
8.3	Configuring the measuring device	39
8.4	Protecting settings from unauthorized access	39
<b>9</b>	<b>Diagnostic information</b>	<b>40</b>

# 1 About this document

## 1.1 Symbols used

### 1.1.1 Safety symbols

#### DANGER

This symbol alerts you to a dangerous situation. Failure to avoid this situation will result in serious or fatal injury.

#### WARNING

This symbol alerts you to a dangerous situation. Failure to avoid this situation can result in serious or fatal injury.











#### CAUTION

This symbol alerts you to a dangerous situation. Failure to avoid this situation can result in minor or medium injury.





#### NOTICE

This symbol contains information on procedures and other facts which do not result in personal injury.

### 1.1.2 Symbols for certain types of information





Symbol	Meaning	Symbol	Meaning
	<b>Permitted</b> Procedures, processes or actions that are permitted.		<b>Preferred</b> Procedures, processes or actions that are preferred.
	<b>Forbidden</b> Procedures, processes or actions that are forbidden.		<b>Tip</b> Indicates additional information.
	Reference to documentation		Reference to page
	Reference to graphic		Series of steps
	Result of a step		Visual inspection

### 1.1.3 Electrical symbols





Symbol	Meaning	Symbol	Meaning
	Direct current		Alternating current
	Direct current and alternating current		<b>Ground connection</b> A grounded terminal which, as far as the operator is concerned, is grounded via a grounding system.

Symbol	Meaning
	<p><b>Potential equalization connection (PE: protective earth)</b> Ground terminals that must be connected to ground prior to establishing any other connections.</p> <p>The ground terminals are located on the interior and exterior of the device:</p> <ul style="list-style-type: none"> <li>▪ Interior ground terminal: potential equalization is connected to the supply network.</li> <li>▪ Exterior ground terminal: device is connected to the plant grounding system.</li> </ul>





### 1.1.4 Communication-specific symbols

Symbol	Meaning	Symbol	Meaning
	<p><b>Wireless Local Area Network (WLAN)</b> Communication via a wireless, local network.</p>		<p><b>Bluetooth</b> Wireless data transmission between devices over a short distance.</p>
	<p><b>LED</b> Light emitting diode is on.</p>		<p><b>LED</b> Light emitting diode is off.</p>
	<p><b>LED</b> Light emitting diode is flashing.</p>		

### 1.1.5 Tool symbols

Symbol	Meaning	Symbol	Meaning
	Torx screwdriver		Flat-blade screwdriver
	Phillips head screwdriver		Allen key
	Open-ended wrench		

### 1.1.6 Symbols in graphics

Symbol	Meaning	Symbol	Meaning
1, 2, 3, ...	Item numbers		Series of steps
A, B, C, ...	Views	A-A, B-B, C-C, ...	Sections
	Hazardous area		Safe area (non-hazardous area)
	Flow direction		

## 2 Safety instructions

### 2.1 Requirements for the personnel

The personnel must fulfill the following requirements for its tasks:

- ▶ Trained, qualified specialists must have a relevant qualification for this specific function and task.
- ▶ Are authorized by the plant owner/operator.
- ▶ Are familiar with federal/national regulations.
- ▶ Before starting work, read and understand the instructions in the manual and supplementary documentation as well as the certificates (depending on the application).
- ▶ Follow instructions and comply with basic conditions.

### 2.2 Intended use

#### Application and media

The measuring device described in this manual is intended only for solids content measurement in water-based liquids.

Measuring devices for use in explosive atmospheres are labeled accordingly on the nameplate.

To ensure that the measuring device is in proper condition during the operation period:

- ▶ Only use the measuring device in full compliance with the data on the nameplate and the general conditions listed in the Operating Instructions and supplementary documentation.
- ▶ Refer to the nameplate to check whether the ordered device can be operated for the intended application in areas requiring specific approvals (e.g. explosion protection, pressure equipment safety).
- ▶ Use the measuring device only for media to which the process-wetted materials are sufficiently resistant.
- ▶ Keep within the specified pressure and temperature range.
- ▶ Keep within the specified ambient temperature range.
- ▶ Protect the measuring device permanently against corrosion from environmental influences.

#### Incorrect use

Non-designated use can compromise safety. The manufacturer is not liable for damage caused by improper or non-designated use.

#### **WARNING**

#### **Danger of breakage due to corrosive or abrasive fluids and ambient conditions!**

- ▶ Verify the compatibility of the process fluid with the sensor material.
- ▶ Ensure the resistance of all fluid-wetted materials in the process.
- ▶ Keep within the specified pressure and temperature range.

**NOTICE****Verification for borderline cases:**

- ▶ For special fluids and fluids for cleaning, Endress+Hauser is glad to provide assistance in verifying the corrosion resistance of fluid-wetted materials, but does not accept any warranty or liability as minute changes in the temperature, concentration or level of contamination in the process can alter the corrosion resistance properties.

**Residual risks****⚠ CAUTION****Risk of hot or cold burns! The use of media and electronics with high or low temperatures can produce hot or cold surfaces on the device.**

- ▶ Mount suitable touch protection.
- ▶ Use suitable protective equipment.

## 2.3 Workplace safety

When working on and with the device:

- ▶ Wear the required personal protective equipment as per national regulations.

## 2.4 Operational safety

Damage to the device!

- ▶ Operate the device in proper technical condition and fail-safe condition only.
- ▶ The operator is responsible for the interference-free operation of the device.

## 2.5 Product safety

This measuring device is designed in accordance with good engineering practice to meet state-of-the-art safety requirements, has been tested, and left the factory in a condition in which it is safe to operate.

It meets general safety standards and legal requirements. It also complies with the EU directives listed in the device-specific EU Declaration of Conformity..

## 2.6 IT security

Our warranty is valid only if the product is installed and used as described in the Operating Instructions. The product is equipped with security mechanisms to protect it against any inadvertent changes to the settings.

IT security measures, which provide additional protection for the product and associated data transfer, must be implemented by the operators themselves in line with their security standards.



## 2.7 Device-specific IT security

The device offers a range of specific functions to support protective measures on the operator's side. These functions can be configured by the user and guarantee greater in-operation safety if used correctly.



For detailed information on device-specific IT security, see the Operating Instructions for the device.

### 2.7.1 Access via service interface (CDI-RJ45)

The device can be connected to a network via the service interface (CDI-RJ45). Device-specific functions guarantee the secure operation of the device in a network.

The use of relevant industrial standards and guidelines that have been defined by national and international safety committees, such as IEC/ISA62443 or the IEEE, is recommended. This includes organizational security measures such as the assignment of access authorization as well as technical measures such as network segmentation.

### 3 Product description

The device consists of a transmitter and a sensor.

The device is available as a compact version:

The transmitter and sensor form a mechanical unit.

#### 3.1 Product design

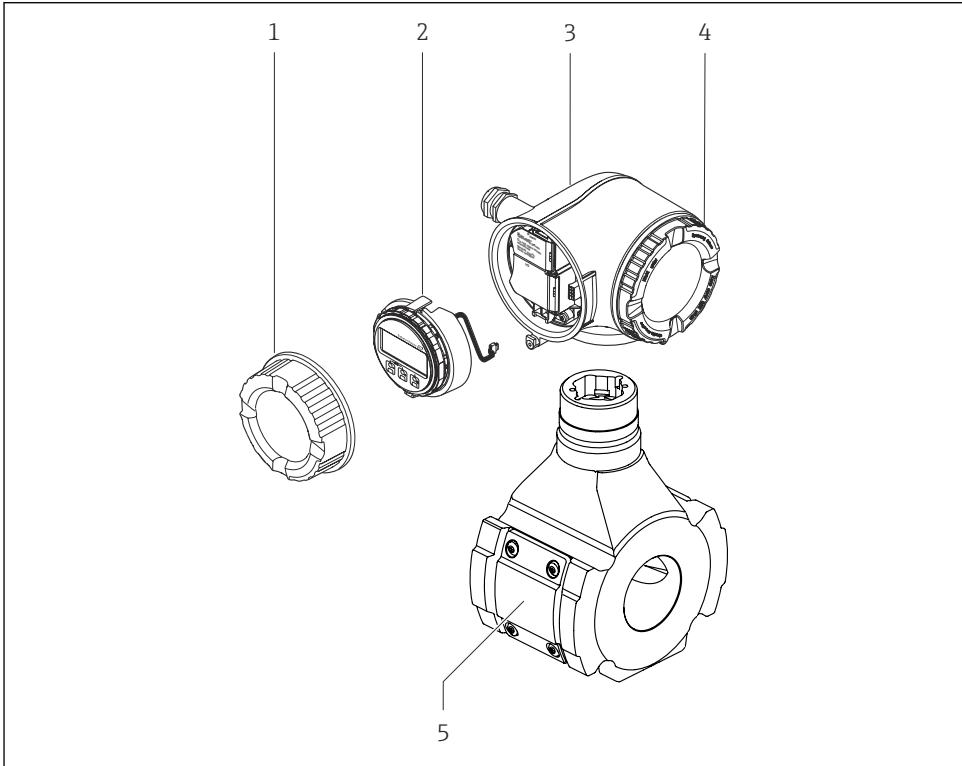

A0052634

#### 1 Important components of a measuring device

- 1 Connection compartment cover
- 2 Display module
- 3 Transmitter housing
- 4 Electronics compartment cover
- 5 Sensor



Use of the device with the remote display and operating module DKX001 →  22.

## 4 Mounting procedure

### 4.1 Mounting the sensor



For detailed information about mounting the sensor, see the Sensor Brief Operating Instructions → 3

### 4.2 Mounting the transmitter

#### 4.2.1 Turning the transmitter housing

To provide easier access to the connection compartment or display module, the transmitter housing can be turned.

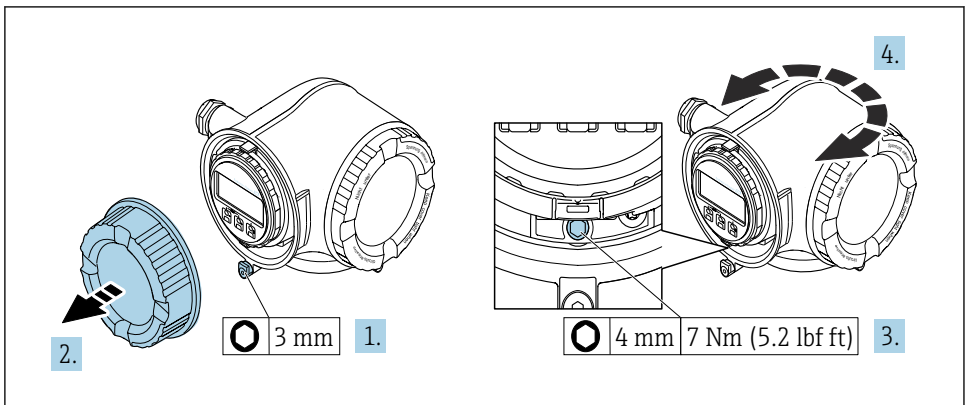

A0029993

#### 2 *Non-Ex housing*

1. Depending on the device version: Loosen the securing clamp of the connection compartment cover.
2. Unscrew the connection compartment cover.
3. Loosen the securing screw.
4. Turn the housing to the desired position.
5. Tighten the securing screw.
6. Screw on the connection compartment cover.
7. Depending on the device version: Attach the securing clamp of the connection compartment cover.

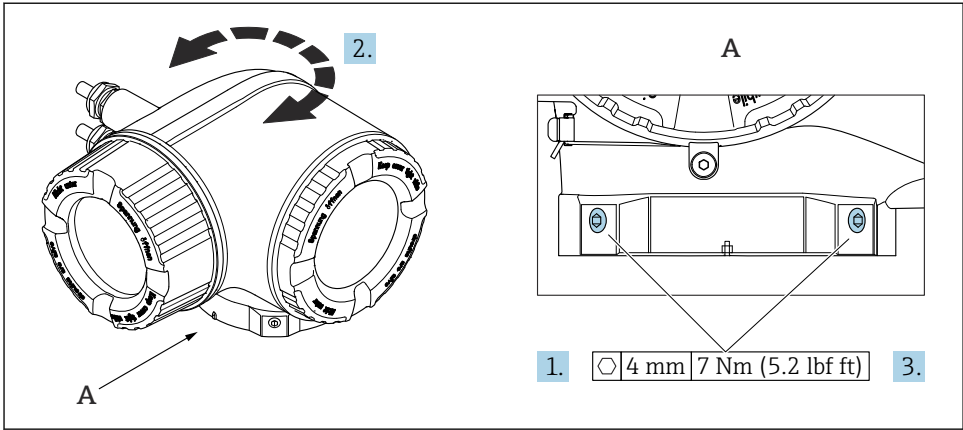

A0043150

**3** Ex housing

1. Loosen the fixing screws.
2. Turn the housing to the desired position.
3. Tighten the securing screws.

### 4.2.2 Turning the display module

The display module can be turned to optimize display readability and operability.

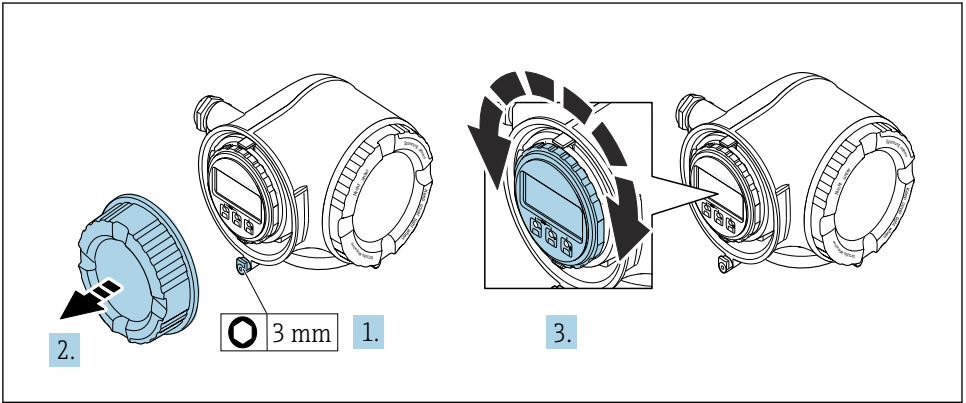

A0030035

1. Depending on the device version: Loosen the securing clamp of the connection compartment cover.
2. Unscrew the connection compartment cover.
3. Turn the display module to the desired position: max.  $8 \times 45^\circ$  in each direction.
4. Screw on the connection compartment cover.
5. Depending on the device version: Attach the securing clamp of the connection compartment cover.

### 4.3 Weather protection cover

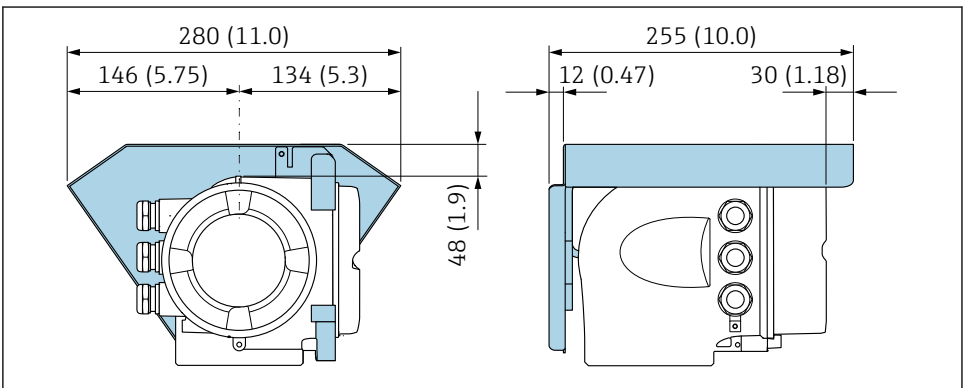

A0029553

4 Engineering unit mm (in)

## 4.4 Transmitter post-installation check

The post-installation check must always be performed after the following tasks:

- Turning the transmitter housing
- Turning the display module

Is the device undamaged (visual inspection)?	<input type="checkbox"/>
Turning the transmitter housing: <ul style="list-style-type: none"> <li>■ Is the securing screw firmly tightened?</li> <li>■ Is the connection compartment cover screwed on tightly?</li> <li>■ Is the securing clamp firmly tightened?</li> </ul>	<input type="checkbox"/>
Turning the display module: <ul style="list-style-type: none"> <li>■ Is the connection compartment cover screwed on tightly?</li> <li>■ Is the securing clamp firmly tightened?</li> </ul>	<input type="checkbox"/>

## 5 Electrical connection

### WARNING

**Live parts! Incorrect work performed on the electrical connections can result in an electric shock.**

- ▶ Set up a disconnecting device (switch or power-circuit breaker) to easily disconnect the device from the supply voltage.
- ▶ In addition to the device fuse, include an overcurrent protection unit with max. 10 A in the plant installation.

### 5.1 Electrical safety

In accordance with applicable national regulations.

### 5.2 Connecting requirements

#### 5.2.1 Required tools

- For cable entries: Use corresponding tools
- For securing clamp: Allen key 3 mm
- Wire stripper
- When using stranded cables: Crimper for wire end ferrule
- For removing cables from terminal: Flat blade screwdriver  $\leq 3$  mm (0.12 in)

#### 5.2.2 Requirements for connection cable

The connecting cables provided by the customer must fulfill the following requirements.

#### Protective grounding cable for the outer ground terminal

Conductor cross-section  $< 2.1$  mm<sup>2</sup> (14 AWG)

The use of a cable lug enables the connection of larger cross-sections.

The grounding impedance must be less than 2  $\Omega$ .

#### Permitted temperature range

- The installation guidelines that apply in the country of installation must be observed.
- The cables must be suitable for the minimum and maximum temperatures to be expected.

#### Power supply cable (incl. conductor for the inner ground terminal)

Standard installation cable is sufficient.

#### Signal cable

*Modbus RS485*

The EIA/TIA-485 standard specifies two types of cable (A and B) for the bus line which can be used for every transmission rate. Cable type A is recommended.



For detailed information about the specification of the connecting cable, see the Operating Instructions for the device.

*Current output 0/4 to 20 mA*

Standard installation cable is sufficient

*Pulse /frequency /switch output*

Standard installation cable is sufficient

*Relay output*

Standard installation cable is sufficient.

*Current input 0/4 to 20 mA*

Standard installation cable is sufficient

*Status input*

Standard installation cable is sufficient

**Cable diameter**

- Cable glands supplied:  
M20 × 1.5 with cable  $\varnothing$  6 to 12 mm (0.24 to 0.47 in)
- Spring-loaded terminals: Suitable for strands and strands with ferrules.  
Conductor cross-section 0.2 to 2.5 mm<sup>2</sup> (24 to 12 AWG).

**Requirements for connecting cable – remote display and operating module DKX001***Optionally available connecting cable*

<b>Standard cable</b>	2 × 2 × 0.34 mm <sup>2</sup> (22 AWG) PVC cable with common shield (2 pairs, pair-stranded)
<b>Flame resistance</b>	According to DIN EN 60332-1-2
<b>Oil resistance</b>	According to DIN EN 60811-2-1
<b>Shield</b>	Tin-plated copper braid, optical cover ≥ 85 %
<b>Capacitance: core/shield</b>	≤ 200 pF/m
<b>L/R</b>	≤ 24 $\mu$ H/ $\Omega$
<b>Available cable length</b>	5 m (15 ft)/10 m (35 ft)/20 m (65 ft)/30 m (100 ft)
<b>Operating temperature</b>	When mounted in a fixed position: -50 to +105 °C (-58 to +221 °F); when cable can move freely: -25 to +105 °C (-13 to +221 °F)

*Standard cable - customer-specific cable*

With the following order option, no cable is supplied with the device and must be provided by the customer:

Order code for DKX001: Order code **040** for "Cable", option **1** "None, provided by customer, max 300 m"

A standard cable with the following minimum requirements can be used as the connecting cable, even in the hazardous area (Zone 2, Class I, Division 2 and Zone 1, Class I, Division 1):



<b>Standard cable</b>	4 wires (2 pairs); pair-stranded with common shield, minimum wire cross-section 0.34 mm <sup>2</sup> (22 AWG)
<b>Shield</b>	Tin-plated copper braid, optical cover ≥ 85 %
<b>Cable impedance (pair)</b>	Minimum 80 Ω
<b>Capacitance: core/shield</b>	Maximum 1 000 nF for Zone 1, Class I, Division 1
<b>L/R</b>	Maximum 24 μH/Ω for Zone 1, Class I, Division 1

### 5.2.3 Terminal assignment

#### Transmitter: supply voltage, input/outputs

The terminal assignment of the inputs and outputs depends on the individual order version of the device. The device-specific terminal assignment is documented on an adhesive label in the terminal cover.

Supply voltage		Input/output 1		Input/output 2		Input/output 3	
1 (+)	2 (-)	26 (B)	27 (A)	24 (+)	25 (-)	22 (+)	23 (-)
Device-specific terminal assignment: adhesive label in terminal cover.							



Terminal assignment of the remote display and operating module → 22.

### 5.2.4 Shielding and grounding

#### Shielding and grounding concept

1. Maintain electromagnetic compatibility (EMC).
2. Take explosion protection into consideration.
3. Pay attention to the protection of persons.
4. Comply with national installation regulations and guidelines.
5. Observe cable specifications .
6. Keep the stripped and twisted lengths of cable shield to the ground terminal as short as possible.
7. Shield cables fully.

## Grounding of the cable shield

### NOTICE

**In systems without potential matching, the multiple grounding of the cable shield causes mains frequency equalizing currents!**

Damage to the bus cable shield.

- ▶ Only ground the bus cable shield to either the local ground or the protective ground at one end.
- ▶ Insulate the shield that is not connected.

To comply with EMC requirements:

1. Ensure the cable shield is grounded to the potential matching line at multiple points.
2. Connect every local ground terminal to the potential matching line.

### 5.2.5 Preparing the measuring device

#### NOTICE

**Insufficient sealing of the housing!**

Operational reliability of the measuring device could be compromised.

- ▶ Use suitable cable glands corresponding to the degree of protection.

1. Remove dummy plug if present.
2. If the measuring device is supplied without cable glands:  
Provide suitable cable gland for corresponding connection cable.
3. If the measuring device is supplied with cable glands:  
Observe the requirements for connection cables.

## 5.3 Connecting the measuring device

### NOTICE

**An incorrect connection compromises electrical safety!**

- ▶ Only properly trained specialist staff may perform electrical connection work.
- ▶ Observe applicable federal/national installation codes and regulations.
- ▶ Comply with local workplace safety regulations.
- ▶ Always connect the protective ground cable ⊕ before connecting additional cables.
- ▶ When using in potentially explosive atmospheres, observe the information in the device-specific Ex documentation.

### 5.3.1 Connecting the transmitter

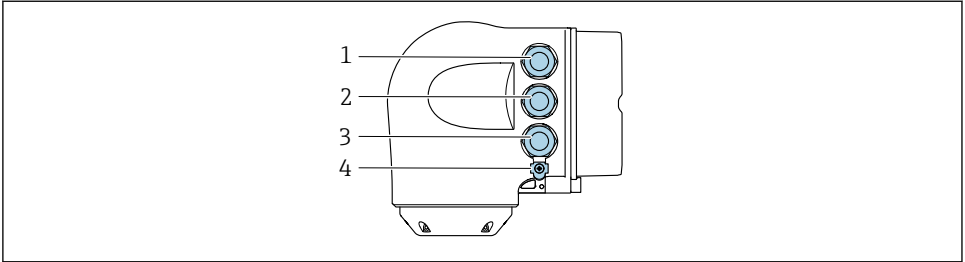

A0026781

- 1 Terminal connection for supply voltage
- 2 Terminal connection for signal transmission, input/output
- 3 Terminal connection for signal transmission, input/output or terminal connection for network connection via service interface (CDI-RJ45); optional: connection for external WLAN antenna or remote display and operating module DKX001
- 4 Protective earth (PE)

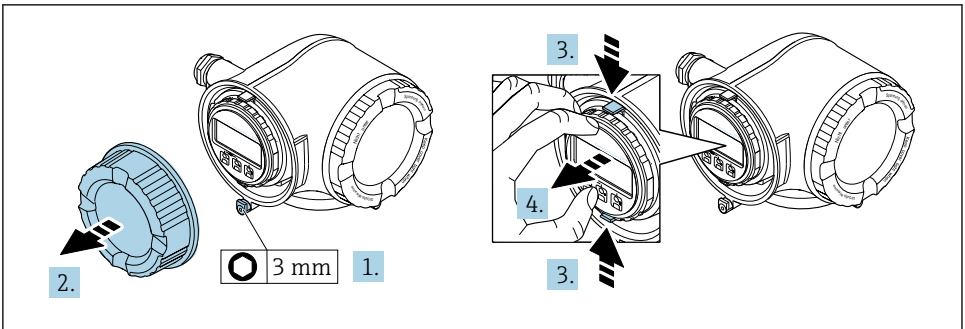

A0029813

1. Loosen the securing clamp of the connection compartment cover.
2. Unscrew the connection compartment cover.
3. Squeeze the tabs of the display module holder together.
4. Remove the display module holder.

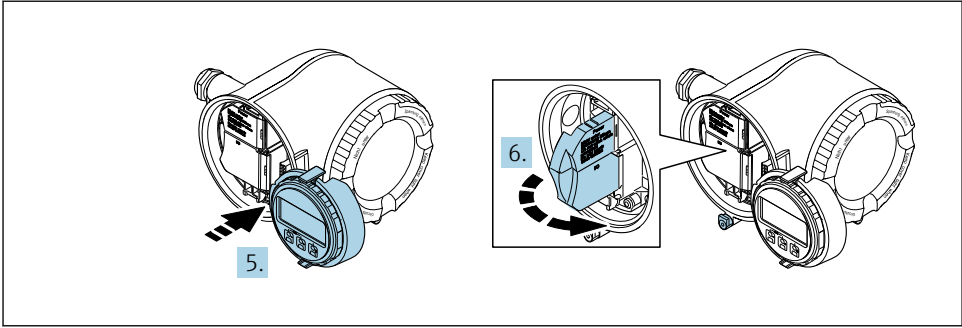

A0029814

5. Attach the holder to the edge of the electronics compartment.
6. Open the terminal cover.

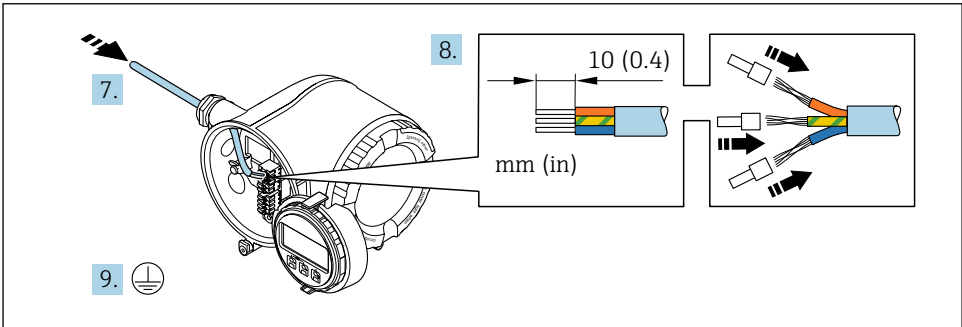

A0029815

7. Push the cable through the cable entry. To ensure tight sealing, do not remove the sealing ring from the cable entry.
8. Strip the cable and cable ends. In the case of stranded cables, also fit ferrules.
9. Connect the protective ground.

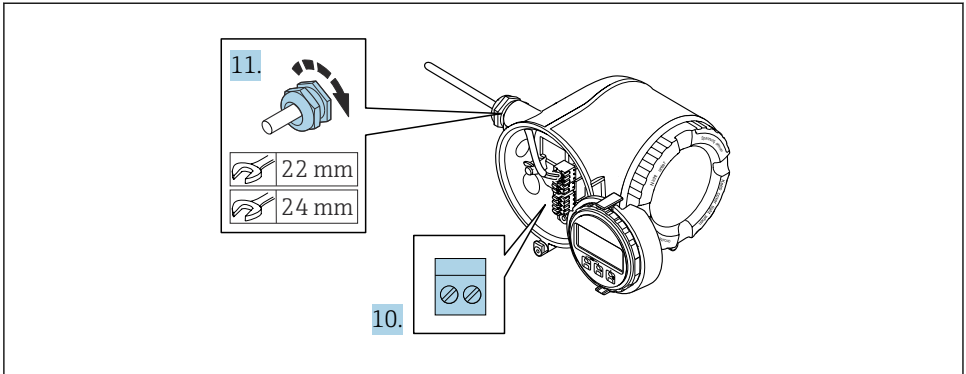

A0029816

10. Connect the cable according to the terminal assignment.
  - ↳ **Signal cable terminal assignment:** The device-specific terminal assignment is documented on an adhesive label in the terminal cover.
  - Supply voltage connection terminal assignment:** Adhesive label in the terminal cover or →  17.
11. Firmly tighten the cable glands.
  - ↳ This concludes the cable connection process.
12. Close the terminal cover.
13. Fit the display module holder in the electronics compartment.
14. Screw on the connection compartment cover.
15. Secure the securing clamp of the connection compartment cover.

### 5.3.2 Connecting the remote display and operating module DKX001

**i** The remote display and operating module DKX001 is available as an optional extra.

- The measuring device is always supplied with a dummy cover when the remote display and operating module DKX001 is ordered directly with the measuring device. Display or operation at the transmitter is not possible in this case.
- If ordered subsequently, the remote display and operating module DKX001 may not be connected at the same time as the existing measuring device display module. Only one display or operation unit may be connected to the transmitter at any one time.

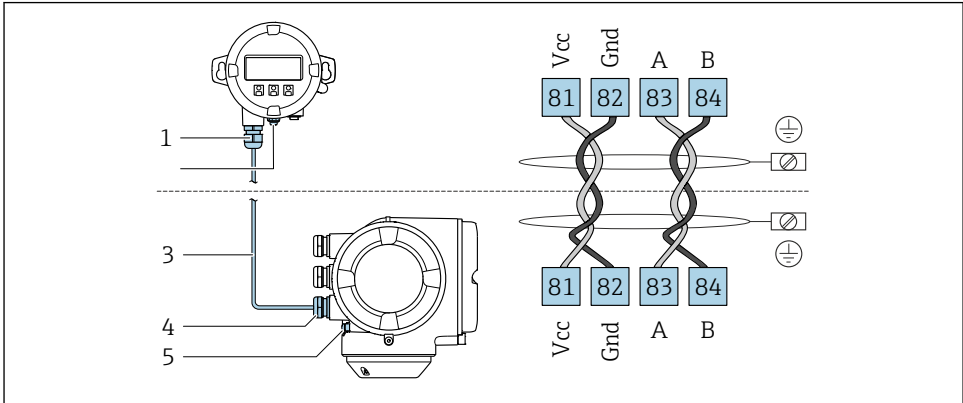

A0027518

- 1 Remote display and operating module DKX001
- 2 Terminal connection for potential equalization (PE)
- 3 Connecting cable
- 4 Measuring device
- 5 Terminal connection for potential equalization (PE)

## 5.4 Potential equalization

### 5.4.1 Requirements

For potential equalization:

- Pay attention to in-house grounding concepts
- Take account of operating conditions like the pipe material and grounding
- Medium, Connect the sensor and transmitter to the same electric potential<sup>1)</sup>
- Use a ground cable with a minimum cross-section of 6 mm<sup>2</sup> (10 AWG) and a cable lug for potential equalization connections

1)

## 5.5 Special connection instructions

### 5.5.1 Connection examples

#### Current output 4-20 mA

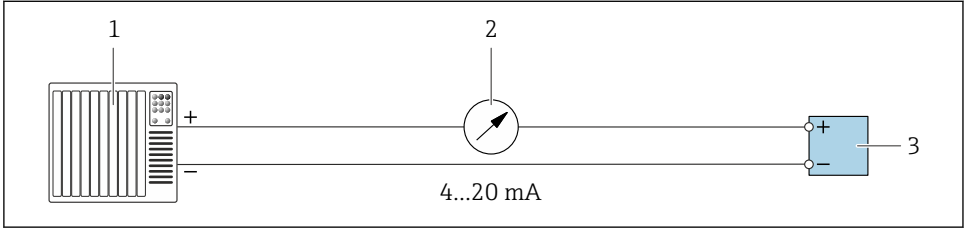

5 Connection example for 4-20 mA current output (active)

- 1 Automation system with current input (e.g. PLC)
- 2 Analog display unit: observe maximum load
- 3 Transmitter

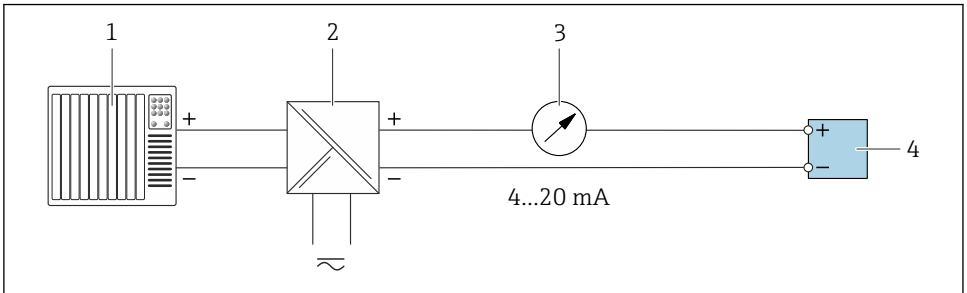

6 Connection example for 4-20 mA current output (passive)

- 1 Automation system with current input (e.g. PLC)
- 2 Active barrier for power supply (e.g. RN221N)
- 3 Analog display unit: observe maximum load
- 4 Transmitter

## Pulse/frequency output

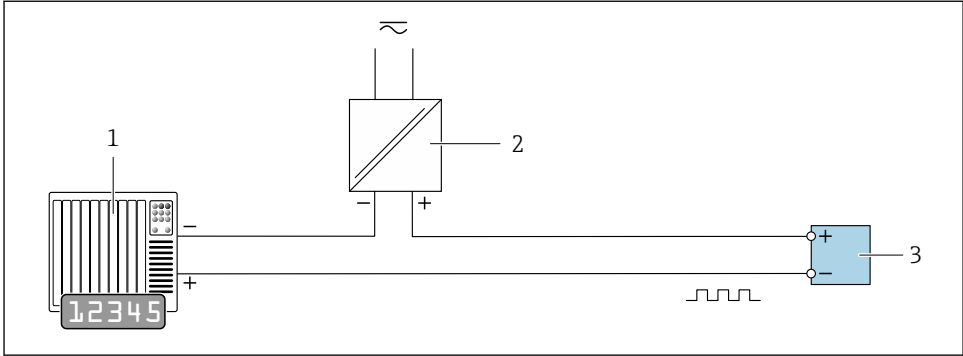

A0028761

### 7 Connection example for pulse/frequency output (passive)

- 1 Automation system with pulse/frequency input (e.g. PLC with 10 k $\Omega$  pull-up or pull-down resistor)
- 2 Power supply
- 3 Transmitter: observe input values

## Switch output

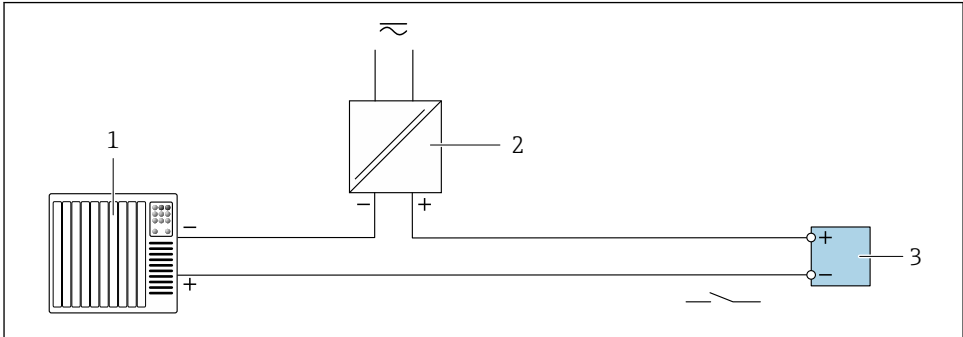

A0028760

### 8 Connection example for switch output (passive)

- 1 Automation system with switch input (e.g. PLC with a 10 k $\Omega$  pull-up or pull-down resistor)
- 2 Power supply
- 3 Transmitter: observe input values



### Relay output

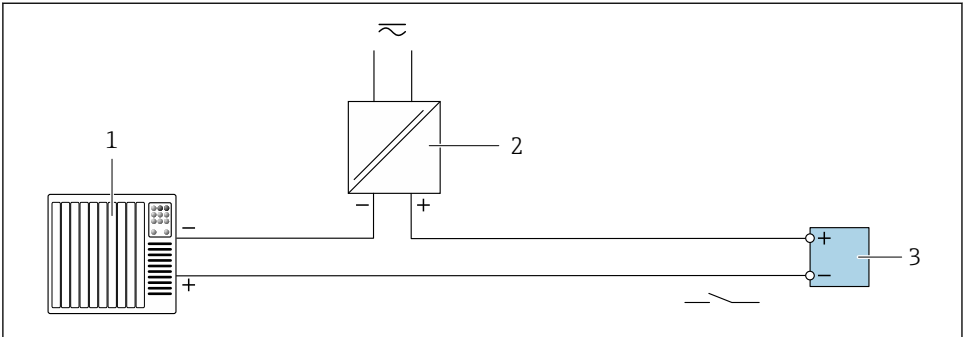

A0028760

9 Connection example for relay output (passive)

- 1 Automation system with relay input (e.g. PLC)
- 2 Power supply
- 3 Transmitter: observe input values

### Current input

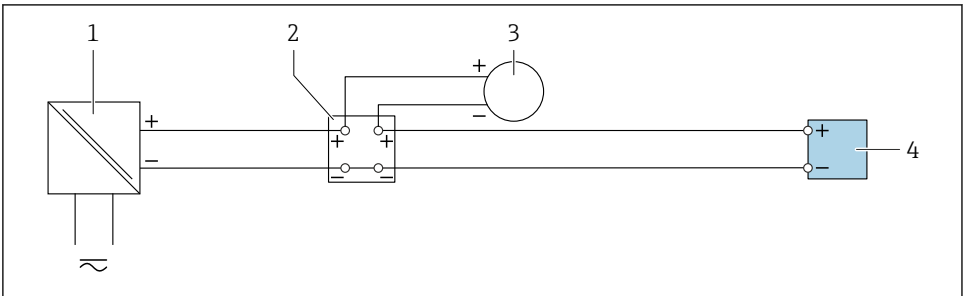

A0028915

10 Connection example for 4 to 20 mA current input

- 1 Power supply
- 2 Terminal box
- 3 External device (for reading in the flow rate value in order to calculate the load rate)
- 4 Transmitter

### Status input

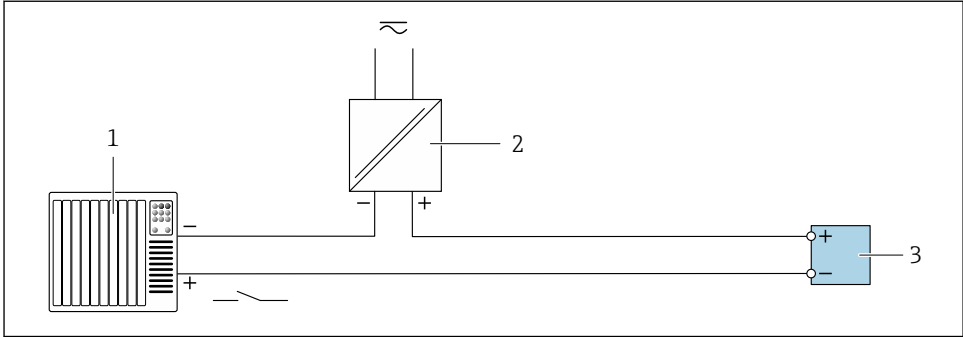

A0028764

11 Connection example for status input

- 1 Automation system with status output (e.g. PLC)
- 2 Power supply
- 3 Transmitter

## 5.6 Hardware settings

### 5.6.1 Setting the device address

The device address must always be configured for a Modbus slave. The valid device addresses are in the range from 1 to 247. Each address may only be assigned once in a Modbus RS485 network. If an address is not configured correctly, the measuring device is not recognized by the Modbus master. All measuring devices are delivered from the factory with the device address 247 and with the "software addressing" address mode.

#### Hardware addressing

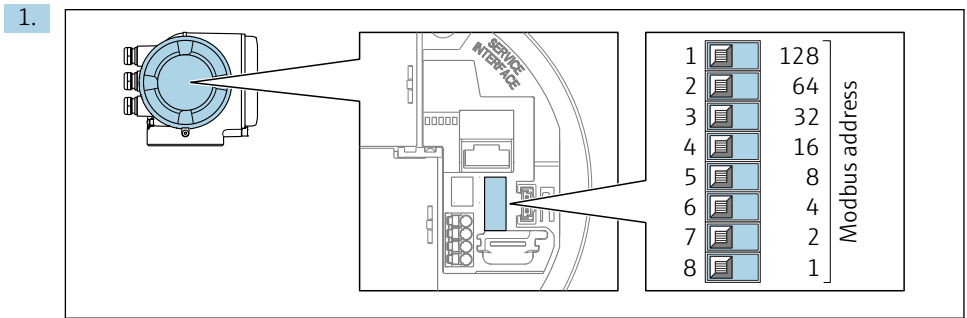

Set the desired device address using the DIP switches in the connection compartment.

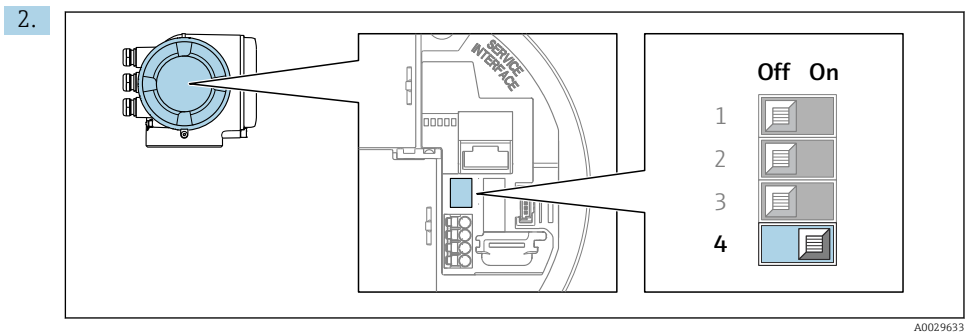

To switch addressing from software addressing to hardware addressing: set the DIP switch to **On**.

↳ The change of device address takes effect after 10 seconds.

#### Software addressing

▶ To switch addressing from hardware addressing to software addressing: set the DIP switch to **Off**.

↳ The device address configured in the **Device address** parameter takes effect after 10 seconds.

### 5.6.2 Activating the terminating resistor

To avoid incorrect communication transmission caused by impedance mismatch, terminate the Modbus RS485 cable correctly at the start and end of the bus segment.

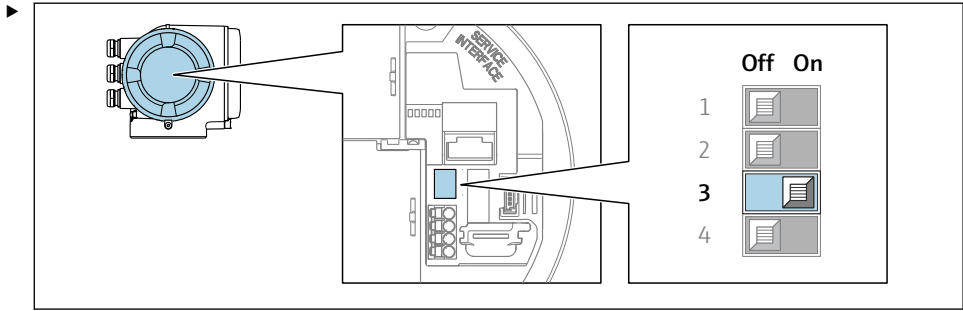

A0029632

Switch DIP switch no. 3 to **On**.

## 5.7 Ensuring the degree of protection

The measuring device fulfills all the requirements for the degree of protection IP66/67, Type 4X enclosure.

To guarantee the degree of protection IP66/67, Type 4X enclosure, carry out the following steps after electrical connection:

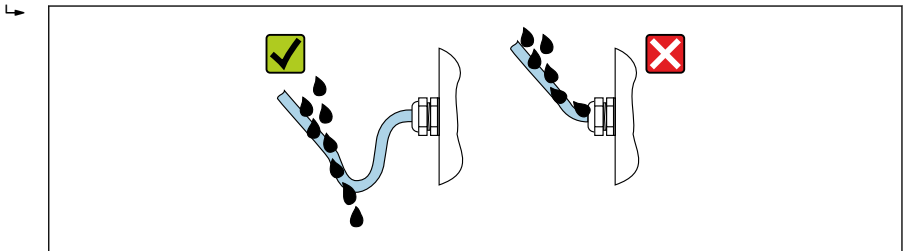

1. Check that the housing seals are clean and fitted correctly.
2. Dry, clean or replace the seals if necessary.
3. Tighten all housing screws and screw covers.
4. Firmly tighten the cable glands.
5. To ensure that moisture does not enter the cable entry:  
Route the cable so that it loops down before the cable entry ("water trap").



A0029278

6. The cable glands supplied do not ensure housing protection when not in use. They must therefore be replaced by dummy plus corresponding to the housing protection.

## 5.8 Post-connection check

Are cables or the device undamaged (visual inspection)?	<input type="checkbox"/>
Do the cables used comply with the requirements →  15?	<input type="checkbox"/>
Does the supply voltage match the specifications on the transmitter nameplate ?	<input type="checkbox"/>
Is the terminal assignment correct →  17?	<input type="checkbox"/>
Are the power supply and signal cables correctly connected?	<input type="checkbox"/>
Is the protective earthing established correctly?	<input type="checkbox"/>
Is the cable type route completely isolated? Without loops and cross-overs?	<input type="checkbox"/>
Do the cables have adequate strain relief? Are they routed securely?	<input type="checkbox"/>
<ul style="list-style-type: none"> <li>▪ Are all cable glands installed, securely tightened and leak-tight?</li> <li>▪ Cable run with "water trap" →  29?</li> </ul>	<input type="checkbox"/>
Is the sensor connected to the right transmitter?	<input type="checkbox"/>
Check the serial number on the nameplate of the sensor and transmitter.	<input type="checkbox"/>
Are all housing covers installed and securely tightened?	<input type="checkbox"/>
Is the securing clamp securely tightened?	<input type="checkbox"/>
Are dummy plugs inserted in unused cable entries and have transportation plugs been replaced with dummy plugs?	<input type="checkbox"/>

## 6 Operation options

### 6.1 Overview of operation options

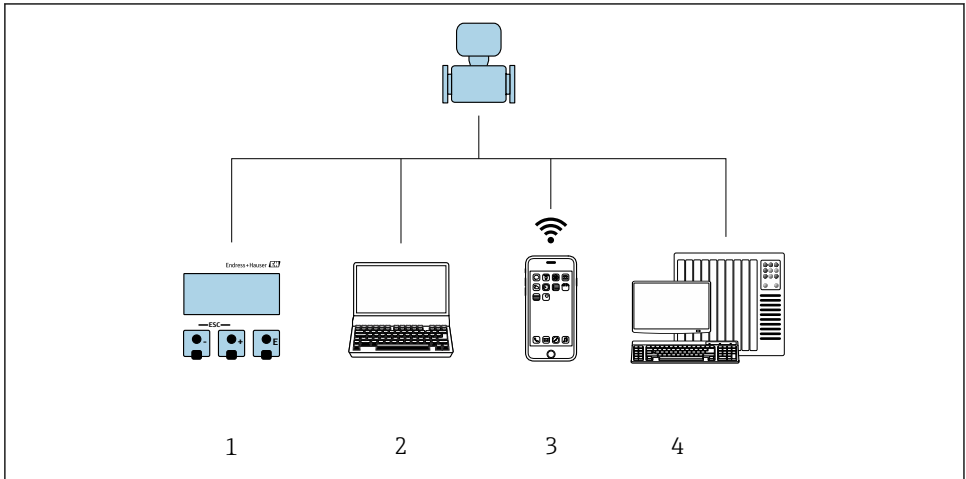

- 1 Local operation via display module
- 2 Computer with Web browser (e.g. Internet Explorer) or with operating tool (e.g. FieldCare, DeviceCare, AMS Device Manager, SIMATIC PDM)
- 3 Mobile handheld terminal with SmartBlue App
- 4 Control system (e.g. PLC)

## 6.2 Structure and function of the operating menu

### 6.2.1 Structure of the operating menu

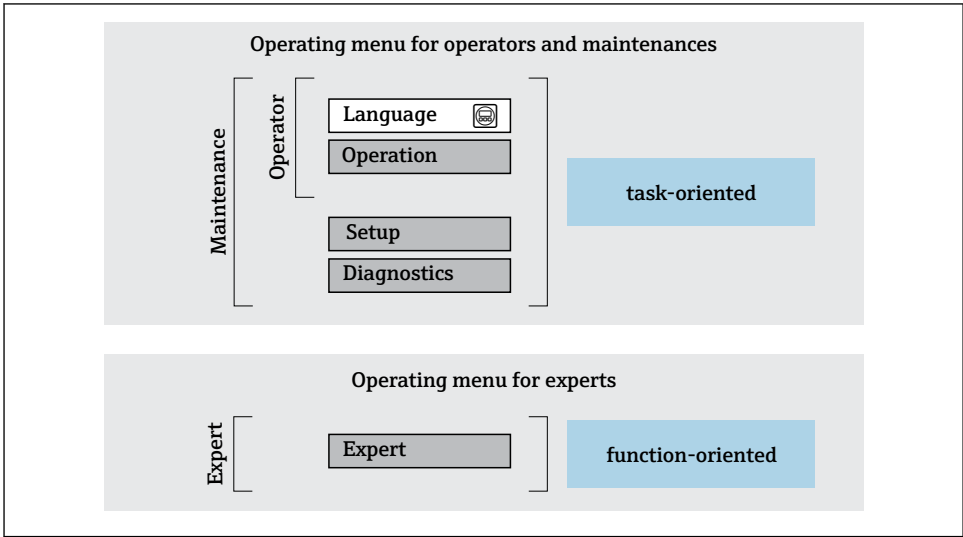



A0014059-EN

 12 Schematic structure of the operating menu

### 6.2.2 Operating philosophy

The individual parts of the operating menu are assigned to certain user roles (e.g. operator, maintenance etc.). Each user role contains typical tasks within the device life cycle.

 For detailed information on the operating philosophy, see the Operating Instructions for the device. →  3



### 6.3 Access to operating menu via local display

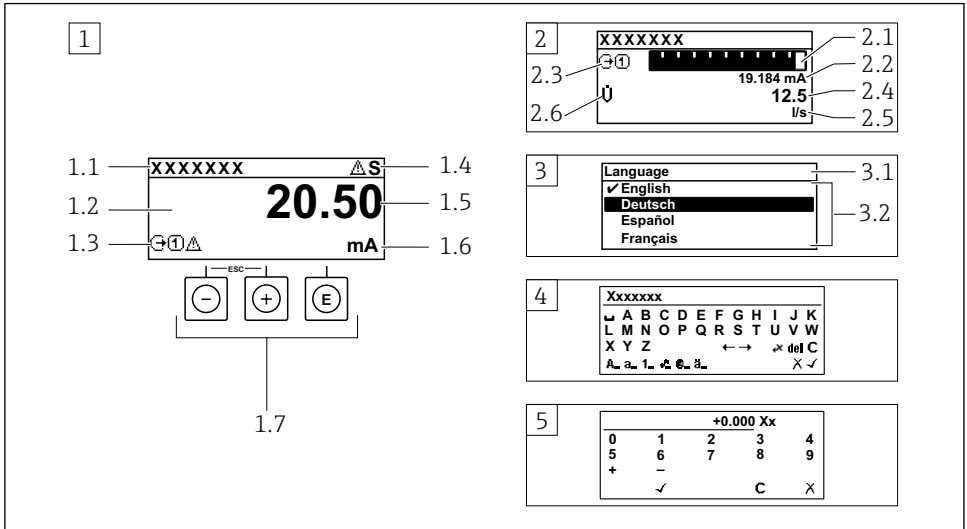

A0014013

- 1 Operational display with measured value shown as "1 value, max." (example)
  - 1.1 Device tag
  - 1.2 Display area for measured values (4-line)
  - 1.3 Explanatory symbols for measured value: Measured value type, measuring channel number, symbol for diagnostic behavior
  - 1.4 Status area
  - 1.5 Measured value
  - 1.6 Unit for the measured value
  - 1.7 Operating elements
- 2 Operational display with measured value shown as "1 bar graph + 1 value" (example)
  - 2.1 Bar graph display for measured value 1
  - 2.2 Measured value 1 with unit
  - 2.3 Explanatory symbols for measured value 1: measured value type, measuring channel number
  - 2.4 Measured value 2
  - 2.5 Unit for measured value 2
  - 2.6 Explanatory symbols for measured value 2: measured value type, measuring channel number
- 3 Navigation view: picklist of a parameter
  - 3.1 Navigation path and status area
  - 3.2 Display area for navigation: ✓ designates the current parameter value
- 4 Editing view: text editor with input mask
- 5 Editing view: numeric editor with input mask

### 6.3.1 Operational display

Explanatory symbols for the measured value	Status area
<ul style="list-style-type: none"> <li>▪ Depends on the device version, e.g.:                             <ul style="list-style-type: none"> <li>▪ : Total solids</li> <li>▪ : Load rate</li> <li>▪ : Temperature</li> <li>▪ : Conductivity</li> </ul> </li> <li>▪ : Totalizer</li> <li>▪ : Output</li> <li>▪ : Input</li> <li>▪ : Measurement channel number <sup>1)</sup></li> <li>▪ Diagnostic behavior <sup>2)</sup> <ul style="list-style-type: none"> <li>▪ : Alarm</li> <li>▪ : Warning</li> </ul> </li> </ul>	<p>The following symbols appear in the status area of the operational display at the top right:</p> <ul style="list-style-type: none"> <li>▪ Status signals                             <ul style="list-style-type: none"> <li>▪ <b>F</b>: Failure</li> <li>▪ <b>C</b>: Function check</li> <li>▪ <b>S</b>: Out of specification</li> <li>▪ <b>M</b>: Maintenance required</li> </ul> </li> <li>▪ Diagnostic behavior                             <ul style="list-style-type: none"> <li>▪ : Alarm</li> <li>▪ : Warning</li> </ul> </li> <li>▪ : Locking (locked via hardware)</li> <li>▪ : Communication via remote operation is active.</li> </ul>







- 1) If there is more than one channel for the same measured variable type (totalizer, output etc.).  
 2) For a diagnostic event that concerns the displayed measured variable.

### 6.3.2 Navigation view



Status area	Display area
<p>The following appears in the status area of the navigation view in the top right corner:</p> <ul style="list-style-type: none"> <li>▪ In the submenu                             <ul style="list-style-type: none"> <li>If a diagnostic event is present, the diagnostic behavior and status signal</li> </ul> </li> <li>▪ In the wizard                             <ul style="list-style-type: none"> <li>If a diagnostic event is present, the diagnostic behavior and status signal</li> </ul> </li> </ul>	<ul style="list-style-type: none"> <li>▪ Icons for menus                             <ul style="list-style-type: none"> <li>▪ : Operation</li> <li>▪ : Setup</li> <li>▪ : Diagnostics</li> <li>▪ : Expert</li> </ul> </li> <li>▪ : Submenus</li> <li>▪ : Wizards</li> <li>▪ : Parameters within a wizard</li> <li>▪ : Parameter locked</li> </ul>



### 6.3.3 Editing view

Text editor	Text correction symbols under
Confirms selection.	Clears all entered characters.
Exits the input without applying the changes.	Moves the input position one position to the right.
Clears all entered characters.	Moves the input position one position to the left.
Switches to the selection of the correction tools.	Deletes one character immediately to the left of the input position.
Toggle <ul style="list-style-type: none"> <li>▪ Between upper-case and lower-case letters</li> <li>▪ For entering numbers</li> <li>▪ For entering special characters</li> </ul>	

Numeric editor	
 Confirms selection.	 Moves the input position one position to the left.
 Exits the input without applying the changes.	 Inserts decimal separator at the cursor position.
 Inserts minus sign at the cursor position.	 Clears all entered characters.

### 6.3.4 Operating elements

Operating key	Meaning
	<p><b>Minus key</b></p> <p><i>In menu, submenu</i> Moves the selection bar upwards in a picklist</p> <p><i>In wizards</i> Goes to previous parameter</p> <p><i>In the text and numeric editor</i> Move the entry position to the left.</p>
	<p><b>Plus key</b></p> <p><i>In menu, submenu</i> Moves the selection bar downwards in a picklist</p> <p><i>In wizards</i> Goes to the next parameter</p> <p><i>In the text and numeric editor</i> Move the entry position to the right.</p>
	<p><b>Enter key</b></p> <p><i>In the operational display</i></p> <ul style="list-style-type: none"> <li>▪ Pressing the key briefly opens the operating menu.</li> <li>▪ Pressing the key for &gt; 3 s opens a context menu with the options: <ul style="list-style-type: none"> <li>▪ Call up the wizards: Compare measured value with reference value</li> <li>▪ Activate keypad lock</li> </ul> </li> </ul> <p><i>In menu, submenu</i></p> <ul style="list-style-type: none"> <li>▪ Pressing the key briefly: <ul style="list-style-type: none"> <li>▪ Opens the selected menu, submenu or parameter.</li> <li>▪ Starts the wizard.</li> <li>▪ If help text is open, closes the help text of the parameter.</li> </ul> </li> <li>▪ Pressing the key for 2 s in a parameter: <ul style="list-style-type: none"> <li>▪ If present, opens the help text for the function of the parameter.</li> </ul> </li> </ul> <p><i>In wizards</i> Opens the editing view of the parameter and confirms the parameter value</p> <p><i>In the text and numeric editor</i></p> <ul style="list-style-type: none"> <li>▪ Pressing the key briefly confirms your selection.</li> <li>▪ Pressing the key for 2 s confirms your entry.</li> </ul>

Operating key	Meaning
	<p><b>Escape key combination (press keys simultaneously)</b></p> <p><i>In menu, submenu</i></p> <ul style="list-style-type: none"> <li>▪ Pressing the key briefly: <ul style="list-style-type: none"> <li>▪ Exits the current menu level and takes you to the next higher level.</li> <li>▪ If help text is open, closes the help text of the parameter.</li> </ul> </li> <li>▪ Pressing the key for 2 s returns you to the operational display ("home position").</li> </ul> <p><i>In wizards</i></p> <p>Exits the wizard and takes you to the next higher level</p> <p><i>In the text and numeric editor</i></p> <p>Exits the Editing view without applying the changes.</p>
	<p><b>Minus/Enter key combination (press and hold down the keys simultaneously)</b></p> <ul style="list-style-type: none"> <li>▪ If keypad lock is active: Pressing the key for 3 s deactivates the keypad lock.</li> <li>▪ If keypad lock is not active: Pressing the key for 3 s opens the context menu including the option for activating the keypad lock.</li> </ul>

### 6.3.5 Further information



Further information on the following subjects:

- Calling up help text
- User roles and related access authorization
- Disabling write protection via access code
- Enabling and disabling the keypad lock

Operating instructions for the device →  3

## 6.4 Access to the operating menu via the operating tool



For detailed information on access via FieldCare and DeviceCare, see the Operating Instructions for the device →  3

## 6.5 Access to the operating menu via the web server



The operating menu can also be accessed via the web server. See the Operating Instructions for the device. →  3

## 7 System integration



For detailed information on system integration, see the Operating Instructions for the device →  3

- Overview of device description files:
  - Current version data for the device
  - Operating tools
- Compatibility with earlier model
- Modbus RS485 information
  - Function codes
  - Response time
  - Modbus data map

## 8 Commissioning

### 8.1 Installation and function check

Before commissioning the device:

- ▶ Make sure that the post-installation and post-connection checks have been performed successfully.
- "Post-mounting check" checklist → 📄 14
- "Post-connection check" checklist → 📄 30

### 8.2 Setting the operating language

Factory setting: English or ordered local language

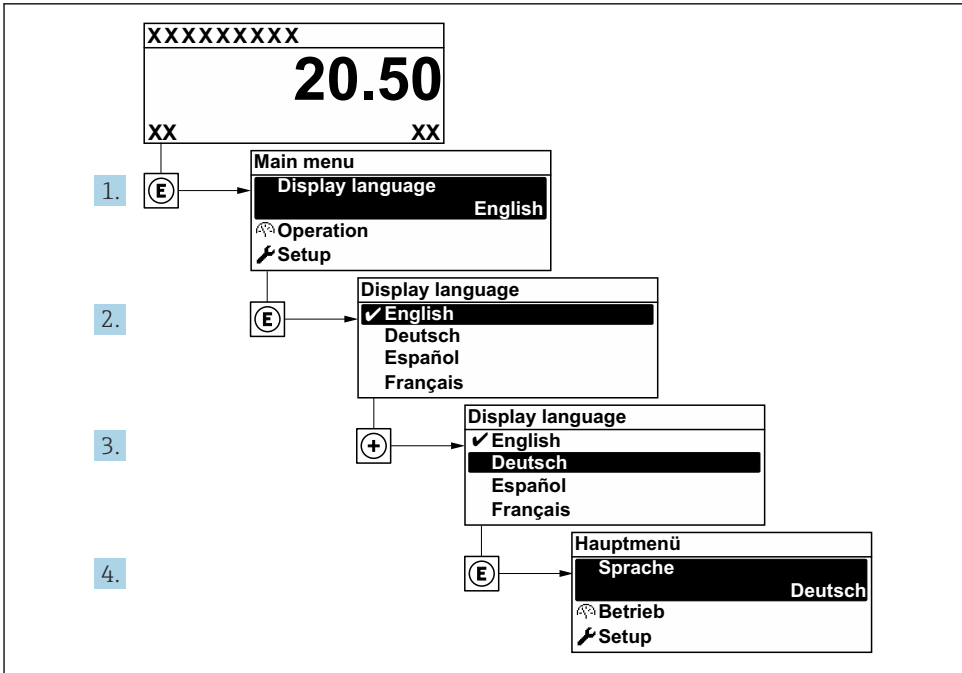

A0053789

📄 13 Using the example of the local display

### 8.3 Configuring the measuring device

The **Setup** menu with its submenus and various guided wizards is used for fast commissioning of the measuring device. They contain all the parameters required for configuration, such as for measurement or communication.



The number of submenus and parameters can vary depending on the device version. The selection can vary depending on the order code.

Example: available submenus, wizards	Meaning
Device tag	Enter the name for the measuring point.
System units	Configure the units for all measured values.
Communication	Configure the communication interface.
I/O configuration	User configurable I/O module
Current input	Configuration of the input/output type
Status input	
Current output 1 to n	
Pulse/frequency/switch output 1 to n	
Relay output	
Display	Configure the display format on the local display.
Total solids commissioning	Configure the data for the wizards: Refer to the laboratory value and carry out adjustment.
Total solids adjustment	Wizards: Refer to the laboratory value and carry out adjustment. For detailed information on the wizards, see the Operating Instructions for the device. →  3
Advanced setup	Additional parameters for configuration: <ul style="list-style-type: none"> <li>▪ Totalizer</li> <li>▪ Display</li> <li>▪ WLAN settings</li> <li>▪ Data backup</li> <li>▪ Administration</li> </ul>

### 8.4 Protecting settings from unauthorized access

The following write protection options exist in order to protect the configuration of the measuring device from unintentional modification:

- Protect access to parameters via access code
- Protect access to local operation via key locking
- Protect access to measuring device via write protection switch



For detailed information on protecting settings against unauthorized access, see the Operating Instructions for the device. → 3

## 9 Diagnostic information

Faults detected by the self-monitoring system of the measuring device are displayed as a diagnostic message in alternation with the operational display. The message about remedial measures can be called up from the diagnostic message, and contains important information on the fault.

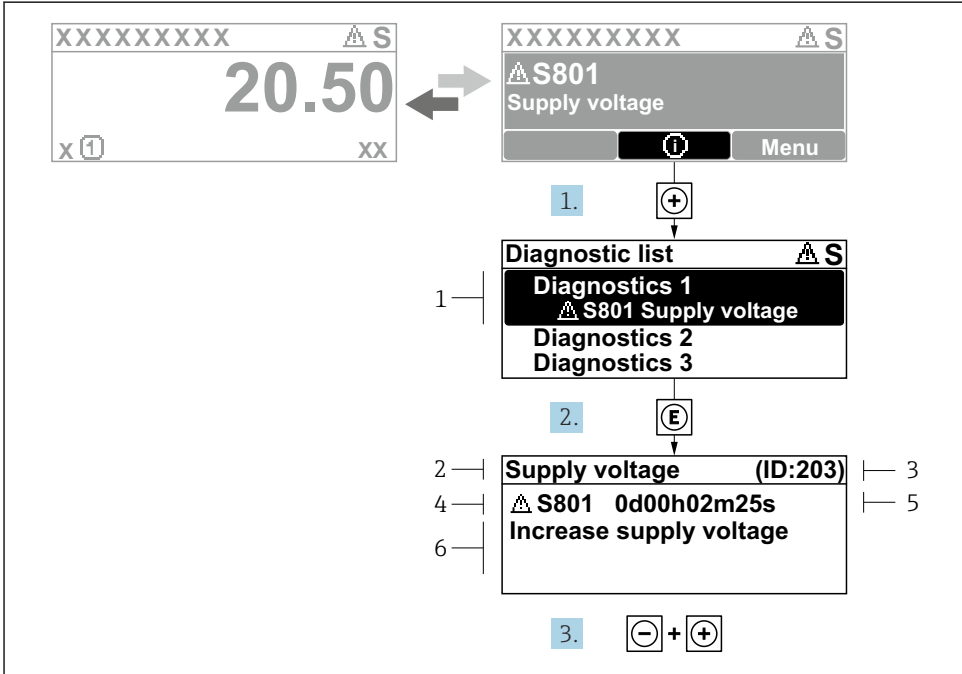

A0029431-EN

### 14 Message for remedial measures

- 1 Diagnostic information
- 2 Short text
- 3 Service ID
- 4 Diagnostic behavior with diagnostic code
- 5 Operation time when error occurred
- 6 Remedial measures

1. The user is in the diagnostic message.  
Press  $\oplus$  (Ⓢ symbol).  
↳ The **Diagnostic list** submenu opens.
2. Select the desired diagnostic event with  $\oplus$  or  $\ominus$  and press  $\text{E}$ .  
↳ The message about the remedial measures opens.
3. Press  $\ominus + \oplus$  simultaneously.  
↳ The message about the remedial measures closes.











71637052

[www.addresses.endress.com](http://www.addresses.endress.com)

---