

Description of Device Parameters

Proline Teqwave M 500

Total solids measurement via microwave transmission
Modbus RS485

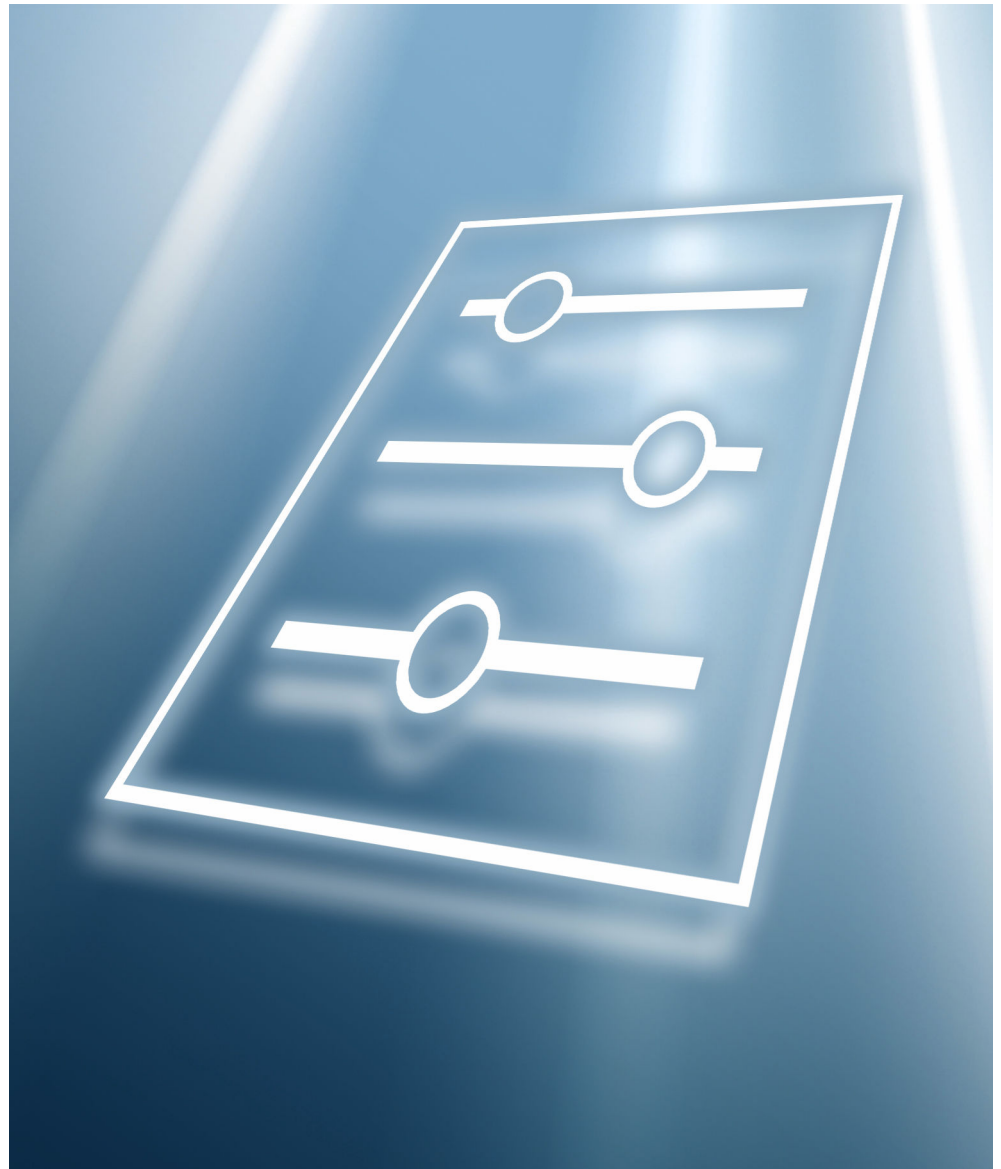

Table of contents

1	About this document	4		
1.1	Document function	4		
1.2	Target group	4		
1.3	Using this document	4		
1.3.1	Information on the document structure	4		
1.3.2	Structure of a parameter description	6		
1.4	Symbols used	6		
1.4.1	Symbols for certain types of information	6		
1.4.2	Symbols in graphics	7		
1.5	Documentation	7		
1.5.1	Standard documentation	7		
1.5.2	Supplementary device-dependent documentation	7		
2	Overview of the Expert operating menu	8		
3	Description of device parameters	11		
3.1	"System" submenu	13		
3.1.1	"Display" submenu	13		
3.1.2	"Configuration backup" submenu	32		
3.1.3	"Diagnostic handling" submenu	35		
3.1.4	"Administration" submenu	40		
3.2	"Sensor" submenu	45		
3.2.1	"Measured values" submenu	45		
3.2.2	"System units" submenu	54		
3.2.3	"Process parameters" submenu	57		
3.2.4	"External compensation" submenu	61		
3.2.5	"Sensor adjustment" submenu	62		
3.2.6	"Factory adjustment" submenu	65		
3.3	"I/O configuration" submenu	66		
3.4	"Input" submenu	68		
3.4.1	"Current input 1 to n" submenu	68		
3.4.2	"Status input 1 to n" submenu	71		
3.5	"Output" submenu	73		
3.5.1	"Current output 1 to n" submenu	74		
3.5.2	"Pulse/frequency/switch output 1 to n" submenu	85		
3.5.3	"Relay output 1 to n" submenu	103		
3.6	"Communication" submenu	109		
3.6.1	"Modbus configuration" submenu	110		
3.6.2	"Modbus information" submenu	115		
3.6.3	"Modbus data map" submenu	116		
3.6.4	"Web server" submenu	116		
3.6.5	"WLAN settings" wizard	119		
3.7	"Application" submenu	126		
3.7.1	"Totalizer 1 to n" submenu	127		
3.8	"Diagnostics" submenu	131		
3.8.1	"Diagnostic list" submenu	134		
3.8.2	"Event logbook" submenu	136		
3.8.3	"Device information" submenu	138		
3.8.4	"Main electronic module + I/O module 1" submenu	141		
3.8.5	"Sensor electronic module (ISEM)" submenu	142		
3.8.6	"I/O module 2" submenu	143		
3.8.7	"I/O module 3" submenu	145		
3.8.8	"I/O module 4" submenu	146		
3.8.9	"Display module" submenu	147		
3.8.10	"Data logging" submenu	148		
3.8.11	"Min/max values" submenu	155		
3.8.12	"Heartbeat Technology" submenu	160		
3.8.13	"Simulation" submenu	160		
4	Country-specific factory settings	170		
4.1	SI units	170		
4.1.1	System units	170		
4.1.2	Output current span	170		
4.2	US units	170		
4.2.1	System units	170		
4.2.2	Output current span	171		
5	Modbus RS485 register information	172		
5.1	Notes	172		
5.1.1	Adapted Modbus RS485 registers for process variables	172		
5.1.2	Structure of the register information	172		
5.1.3	Address model	173		
5.2	Overview of the Expert operating menu	174		
5.3	Register information	189		
5.3.1	"System" submenu	189		
5.3.2	"Sensor" submenu	193		
5.3.3	"I/O configuration" submenu	197		
5.3.4	"Input" submenu	198		
5.3.5	"Output" submenu	199		
5.3.6	"Communication" submenu	203		
5.3.7	"Application" submenu	205		
5.3.8	"Diagnostics" submenu	205		
	Index	212		

1 About this document

1.1 Document function

The document is part of the Operating Instructions and serves as a reference for parameters, providing a detailed explanation of each individual parameter of the operating menu.

1.2 Target group

The document is aimed at specialists who work with the device over the entire life cycle and perform specific configurations.

1.3 Using this document

1.3.1 Information on the document structure

The document lists the submenus and their parameters according to the structure from the **Expert** menu (→  8), which is displayed when the "**Maintenance**" user role is enabled.

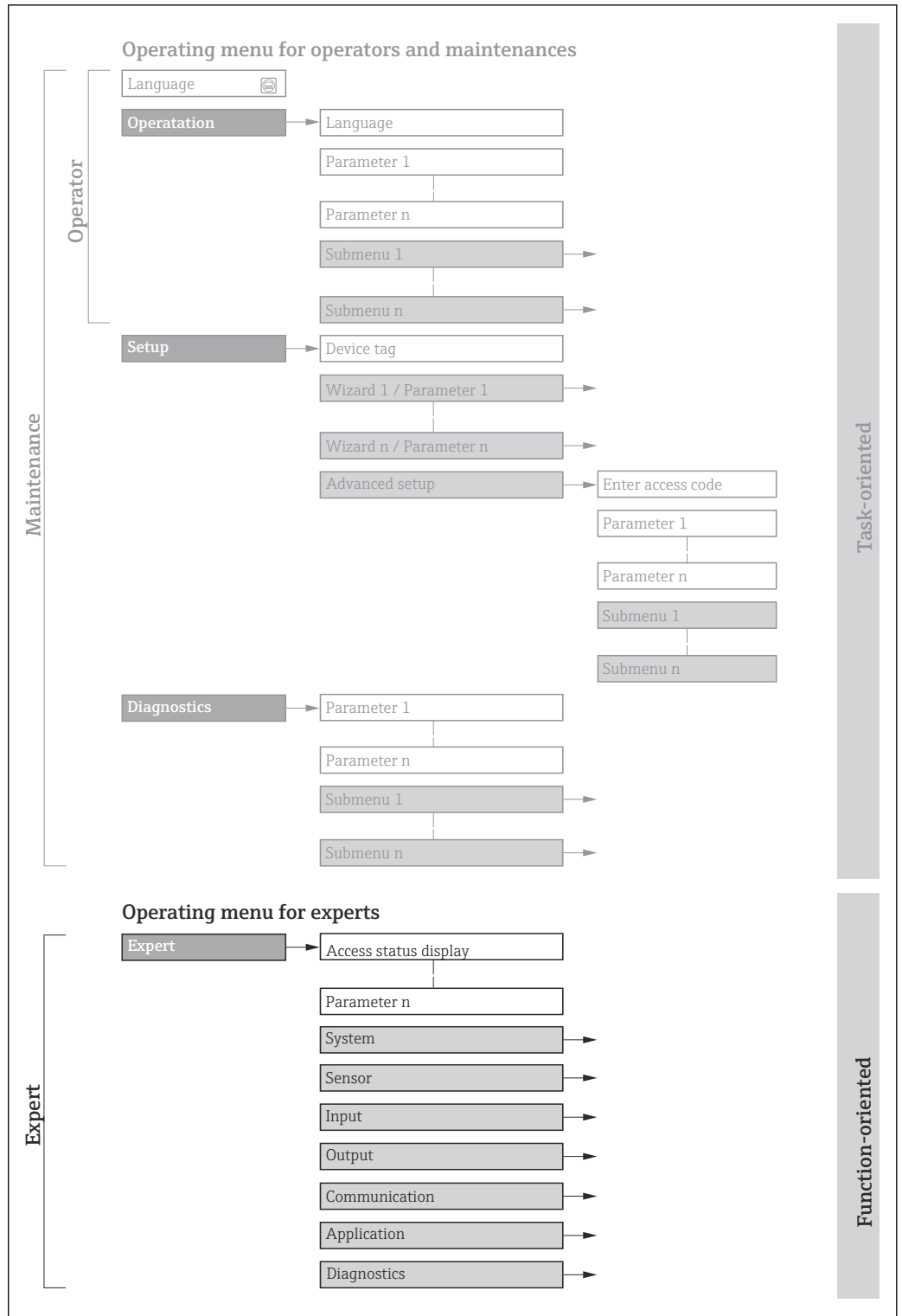



1 Sample graphic for the schematic layout of the operating menu

- Additional information regarding:
- The arrangement of the parameters according to the menu structure of the **Operation** menu, **Setup** menu, **Diagnostics** menu with a brief description: Operating Instructions
 - Operating concept of the operating menus: Operating Instructions







1.3.2 Structure of a parameter description

The individual parts of a parameter description are described in the following section:

Complete parameter name	Write-protected parameter = 
Navigation	 Navigation path to the parameter via the local display or Web browser  Navigation path to the parameter via the operating tool The names of the menus, submenus and parameters are abbreviated to the form in which they appear on the display and in the operating tool.
Prerequisite	The parameter is only available under these specific conditions
Description	Description of the parameter function
Options	List of the individual options for the parameter <ul style="list-style-type: none"> ■ Option 1 ■ Option 2
User entry	Parameter entry range
Display	Display value/data of the parameter
Factory setting	Default setting ex works
Additional information	Additional explanations (e.g. in examples): <ul style="list-style-type: none"> ■ On individual options ■ On display values/data ■ On the input range ■ On the factory setting ■ On the parameter function

1.4 Symbols used

1.4.1 Symbols for certain types of information

Symbol	Meaning
	Tip Indicates additional information.
	Reference to documentation
	Reference to page
	Reference to graphic
 <small>A0028662</small>	Operation via local display
 <small>A0028663</small>	Operation via operating tool
 <small>A0028665</small>	Write-protected parameter

1.4.2 Symbols in graphics

Symbol	Meaning
1, 2, 3 ...	Item numbers
A, B, C, ...	Views
A-A, B-B, C-C, ...	Sections

1.5 Documentation

1.5.1 Standard documentation

Technical information

Device	Documentation code
Proline Teqwave MW 500	TI01764D

Operating instructions

Device	Documentation code
Proline Teqwave MW 500 Modbus RS485	BA02323D

1.5.2 Supplementary device-dependent documentation

Special documentation

Contents	Documentation code
Heartbeat Verification application package (Modbus RS485)	SD03171D

2 Overview of the Expert operating menu

The following table provides an overview of the menu structure of the expert operating menu and its parameters. The page reference indicates where the associated description of the submenu or parameter can be found.

Expert		
Locking status		→ 11
User role		→ 12
Enter access code		→ 13
▶ System		→ 13
▶ Display		→ 13
▶ Configuration backup		→ 32
▶ Diagnostic handling		→ 35
▶ Administration		→ 40
▶ Sensor		→ 45
▶ Measured values		→ 45
▶ System units		→ 54
▶ Process parameters		→ 57
▶ External process variables		→ 61
▶ Sensor adjustment		→ 62
▶ Factory adjustment		→ 65
▶ I/O configuration		→ 66
I/O module 1 to n terminal numbers		→ 66
I/O module 1 to n information		→ 66
I/O module 1 to n type		→ 67
Apply I/O configuration		→ 67
I/O alteration code		→ 68











▶ Input	→ 68
▶ Current input 1 to n	→ 68
▶ Status input 1 to n	→ 71
▶ Output	→ 73
▶ Current output 1 to n	→ 74
▶ Pulse/frequency/switch output 1 to n	→ 85
▶ Relay output 1 to n	→ 103
▶ Communication	→ 109
▶ Modbus configuration	→ 110
▶ Modbus information	→ 115
▶ Modbus data map	→ 116
▶ Web server	→ 116
▶ WLAN settings	→ 119
▶ Application	→ 126
Reset all totalizers	→ 126
▶ Totalizer 1	→ 127
▶ Diagnostics	→ 131
Actual diagnostics	→ 131
Timestamp	→ 132
Previous diagnostics	→ 132
Timestamp	→ 133
Operating time from restart	→ 133
Operating time	→ 133
▶ Diagnostic list	→ 134

▶ Device information	→ 138
▶ Main electronic module + I/O module 1	→ 141
▶ Sensor electronic module (ISEM)	→ 142
▶ I/O module 2	→ 143
▶ I/O module 3	→ 145
▶ I/O module 4	→ 146
▶ Display module	→ 147
▶ Data logging	→ 148
▶ Min/max values	→ 155
▶ Heartbeat Technology	→ 160
▶ Simulation	→ 160

3 Description of device parameters

In the following section, the parameters are listed according to the menu structure of the local display. Specific parameters for the operating tools are included at the appropriate points in the menu structure.

Navigation  Expert

Expert	
Locking status	→  11
User role	→  12
Enter access code	→  13
▶ System	→  13
▶ Sensor	→  45
▶ I/O configuration	→  66
▶ Input	→  68
▶ Output	→  73
▶ Communication	→  109
▶ Application	→  126
▶ Diagnostics	→  131

Locking status

Navigation  Expert → Locking status

Description Displays the active write protection.

User interface

- Hardware locked
- Temporarily locked

Additional information*Display*

If two or more types of write protection are active, the write protection with the highest priority is shown on the local display. In the operating tool all active types of write protection are displayed.



Detailed information on access authorization is provided in the "User roles and associated access authorization" and "Operating concept" sections of the Operations Instructions for the device

Options

Options	Description
None	The access authorization displayed in the Access status parameter (→ 12) applies . Only appears on local display.
Hardware locked (priority 1)	The DIP switch for hardware locking is activated on the PCB board. This locks write access to the parameters (e.g. via local display or operating tool) .
Temporarily locked	Write access to the parameters is temporarily locked on account of internal processes running in the device (e.g. data upload/download, reset, etc.). Once the internal processing has been completed, the parameters can be changed once again.

User role**Navigation**

Expert → User role

Description

Displays the access authorization to the parameters via the local display, Web browser or operating tool.

User interface

- Maintenance
- Service

Factory setting

Maintenance

Additional information*Description*

Access authorization can be modified via the **Enter access code** parameter (→ 13).



If additional write protection is active, this restricts the current access authorization even further.

User interface

Detailed information on access authorization is provided in the "User roles and associated access authorization" and "Operating concept" sections of the Operations Instructions for the device

Enter access code**Navigation**
 Expert → Ent. access code
Description





Use this function to enter the user-specific release code to remove parameter write protection.

User entry

Max. 16-digit character string comprising numbers, letters and special characters









3.1 "System" submenu













Navigation
 Expert → System

▶ System		
▶ Display		→  13
▶ Configuration backup		→  32
▶ Diagnostic handling		→  35
▶ Administration		→  40

3.1.1 "Display" submenu

Navigation
 Expert → System → Display

▶ Display		
Format display		→  14
Value 1 display		→  17
0% bargraph value 1		→  17
100% bargraph value 1		→  18
Decimal places 1		→  18
Value 2 display		→  19
Decimal places 2		→  19
Value 3 display		→  20

0% bargraph value 3	→  20
100% bargraph value 3	→  21
Decimal places 3	→  21
Value 4 display	→  22
Decimal places 4	→  22
Display language	→  23
Display interval	→  29
Display damping	→  29
Header	→  30
Header text	→  30
Separator	→  31
Backlight	→  31

Format display

Navigation   Expert → System → Display → Format display

Prerequisite A local display is provided.

Description Use this function to select how the measured value is shown on the local display.





Selection

- 1 value, max. size
- 1 bargraph + 1 value
- 2 values
- 1 value large + 2 values
- 4 values

Factory setting 1 value, max. size

Additional information*Description*

The display format (size, bar graph) and number of simultaneously displayed measured values (1 to 8) can be configured. This setting only applies to normal operation.

-  The **Value 1 display** parameter (→  17)...**Value 8 display** parameter (→  28) are used to specify which measured values are shown on the local display and in what order.
- If more measured values are specified than the display mode selected permits, then the values alternate on the device display. The display time until the next change is configured using the **Display interval** parameter (→  29).

Possible measured values shown on the local display:

"1 value, max. size" option

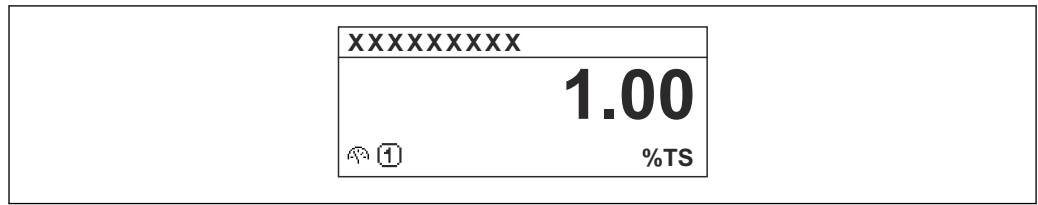

"1 bargraph + 1 value" option

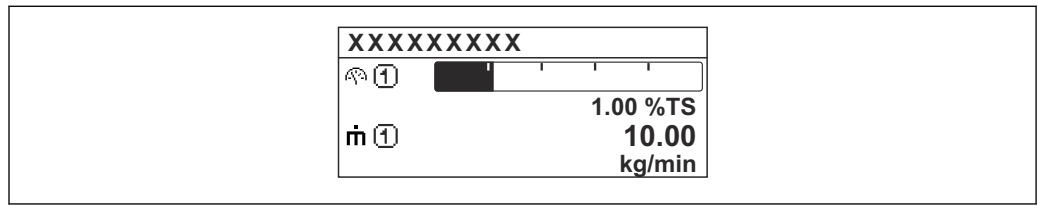

"2 values" option

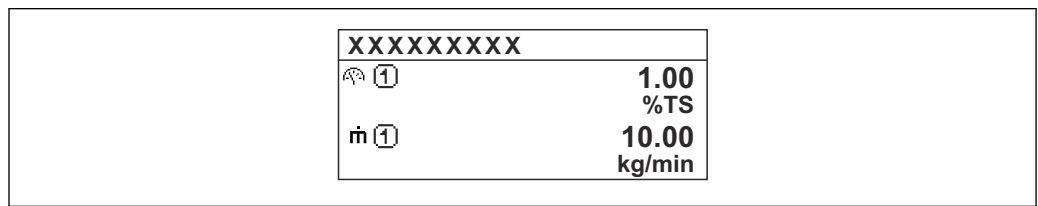

"1 value large + 2 values" option

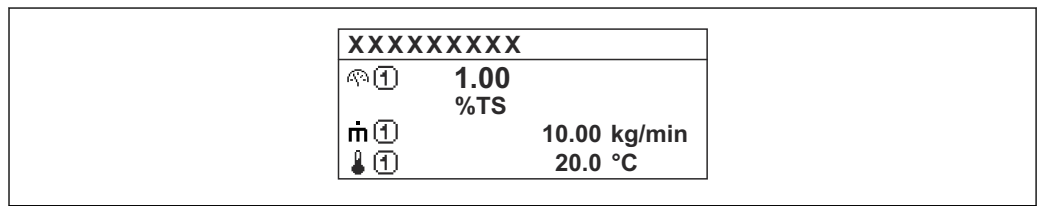

"4 values" option

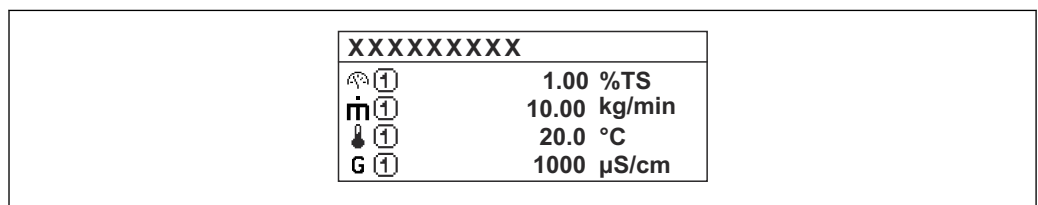

Value 1 display







Navigation	Expert → System → Display → Value 1 display
Prerequisite	<ul style="list-style-type: none"> ▪ A local display is provided. ▪ The Load rate option is only available if the volume flow of the medium is read in via the Current input 1 to n (→ 49) or the fieldbus.
Description	Use this function to select a measured value that is shown on the local display.
Selection	<ul style="list-style-type: none"> ▪ Total solids ▪ Temperature ▪ Electronics temperature ▪ Conductivity ▪ Corrected conductivity ▪ Load rate * ▪ Totalizer 1 * ▪ Current output 1 * ▪ Current output 2 * ▪ Current output 3 * ▪ Current output 4 *
Factory setting	Total solids
Additional information	<p><i>Description</i></p> <p>If several measured values are displayed one below the other, the measured value selected here will be the first value to be displayed. The value is only displayed during normal operation.</p> <p> The Format display parameter (→ 14) is used to specify how many measured values are displayed simultaneously and how.</p> <p><i>Dependency</i></p> <p> The unit of the displayed measured value is taken from the System units submenu (→ 54).</p>

0% bargraph value 1









Navigation	Expert → System → Display → 0% bargraph 1
Prerequisite	A local display is provided.
Description	Use this function to enter the 0% bar graph value to be shown on the display for the measured value 1.
User entry	Signed floating-point number
Factory setting	0 %TS





* Visibility depends on order options or device settings

Additional information	<p><i>Description</i></p> <p> The Format display parameter (→  14) is used to specify that the measured value is to be displayed as a bar graph.</p> <p><i>User entry</i></p> <p> The unit of the displayed measured value is taken from the System units submenu (→  54).</p>
-------------------------------	--

100% bargraph value 1

Navigation	  Expert → System → Display → 100% bargraph 1
Prerequisite	A local display is provided.
Description	Use this function to enter the 100% bar graph value to be shown on the display for the measured value 1.
User entry	Signed floating-point number
Factory setting	Depends on country and nominal diameter
Additional information	<p><i>Description</i></p> <p> The Format display parameter (→  14) is used to specify that the measured value is to be displayed as a bar graph.</p> <p><i>User entry</i></p> <p> The unit of the displayed measured value is taken from the System units submenu (→  54).</p>

Decimal places 1

Navigation	  Expert → System → Display → Decimal places 1
Prerequisite	A measured value is specified in the Value 1 display parameter (→  17).
Description	Use this function to select the number of decimal places for measured value 1.
Selection	<ul style="list-style-type: none"> ■ x ■ x.x ■ x.xx ■ x.xxx ■ x.xxxx
Factory setting	x.xx
Additional information	<p><i>Description</i></p> <p> This setting does not affect the accuracy of the device for measuring or calculating the value.</p>

Value 2 display

**Navigation**

Expert → System → Display → Value 2 display

Prerequisite

- A local display is provided.
- The **Load rate** option is only available if the volume flow of the medium is read in via the Current input 1 to n (→ 49) or the fieldbus.

Description

Use this function to select a measured value that is shown on the local display.

Selection

- None
- Total solids
- Temperature
- Electronics temperature
- Conductivity
- Corrected conductivity
- Load rate *
- Totalizer 1 *
- Current output 1 *
- Current output 2 *
- Current output 3 *
- Current output 4 *

Factory setting

None

Additional information*Description*

If several measured values are displayed one below the other, the measured value selected here will be the second value to be displayed. The value is only displayed during normal operation.



The **Format display** parameter (→ 14) is used to specify how many measured values are displayed simultaneously and how.

Dependency

The unit of the displayed measured value is taken from the **System units** submenu (→ 54).

Decimal places 2

**Navigation**

Expert → System → Display → Decimal places 2

PrerequisiteA measured value is specified in the **Value 2 display** parameter (→ 19).**Description**

Use this function to select the number of decimal places for measured value 2.

Selection

- x
- x.x
- x.xx
- x.xxx
- x.xxxx

* Visibility depends on order options or device settings

Factory setting x.xx

Additional information *Description*

 This setting does not affect the accuracy of the device for measuring or calculating the value.

Value 3 display

Navigation  Expert → System → Display → Value 3 display

Prerequisite

- A local display is provided.
- The **Load rate** option is only available if the volume flow of the medium is read in via the Current input 1 to n (→  49) or the fieldbus.



Description Use this function to select a measured value that is shown on the local display.

Selection For the picklist, see **Value 1 display** parameter (→  17)



Factory setting None

Additional information *Description*

If several measured values are displayed one below the other, the measured value selected here will be the third value to be displayed. The value is only displayed during normal operation.

 The **Format display** parameter (→  14) is used to specify how many measured values are displayed simultaneously and how.

Options

 The unit of the displayed measured value is taken from the **System units** submenu (→  54).

0% bargraph value 3





Navigation  Expert → System → Display → 0% bargraph 3

Prerequisite A selection was made in the **Value 3 display** parameter (→  20).







Description Use this function to enter the 0% bar graph value to be shown on the display for the measured value 3.

User entry Signed floating-point number





Factory setting 0















Additional information	<p><i>Description</i></p> <p> The Format display parameter (→  14) is used to specify that the measured value is to be displayed as a bar graph.</p> <p><i>User entry</i></p> <p> The unit of the displayed measured value is taken from the System units submenu (→  54).</p>
-------------------------------	--

100% bargraph value 3

Navigation	  Expert → System → Display → 100% bargraph 3
Prerequisite	A selection was made in the Value 3 display parameter (→  20).
Description	Use this function to enter the 100% bar graph value to be shown on the display for the measured value 3.
User entry	Signed floating-point number
Factory setting	0
Additional information	<p><i>Description</i></p> <p> The Format display parameter (→  14) is used to specify that the measured value is to be displayed as a bar graph.</p> <p><i>User entry</i></p> <p> The unit of the displayed measured value is taken from the System units submenu (→  54).</p>

Decimal places 3

Navigation	  Expert → System → Display → Decimal places 3
Prerequisite	A measured value is specified in the Value 3 display parameter (→  20).
Description	Use this function to select the number of decimal places for measured value 3.
Selection	<ul style="list-style-type: none"> ■ x ■ x.X ■ x.XX ■ x.XXX ■ x.XXXX
Factory setting	x.XX
Additional information	<p><i>Description</i></p> <p> This setting does not affect the accuracy of the device for measuring or calculating the value.</p>







Value 4 display 	
Navigation	  Expert → System → Display → Value 4 display
Prerequisite	<ul style="list-style-type: none"> ▪ A local display is provided. ▪ The Load rate option is only available if the volume flow of the medium is read in via the Current input 1 to n (→  49) or the fieldbus.
Description	Use this function to select a measured value that is shown on the local display.
Selection	For the picklist, see Value 1 display parameter (→  17)
Factory setting	None
Additional information	<p><i>Description</i></p> <p>If several measured values are displayed one below the other, the measured value selected here will be the fourth value to be displayed. The value is only displayed during normal operation.</p> <p> The Format display parameter (→  14) is used to specify how many measured values are displayed simultaneously and how.</p> <p><i>Options</i></p> <p> The unit of the displayed measured value is taken from the System units submenu (→  54).</p>
Decimal places 4 	
Navigation	  Expert → System → Display → Decimal places 4
Prerequisite	A measured value is specified in the Value 4 display parameter (→  22).
Description	Use this function to select the number of decimal places for measured value 4.
Selection	<ul style="list-style-type: none"> ▪ x ▪ x.x ▪ x.xx ▪ x.xxx ▪ x.xxxx
Factory setting	x.xx
Additional information	<p><i>Description</i></p> <p> This setting does not affect the accuracy of the device for measuring or calculating the value.</p>

Display language

Navigation	 Expert → System → Display → Display language
Prerequisite	A local display is provided.
Description	Use this function to select the configured language on the local display.
Selection	<ul style="list-style-type: none"> ■ English ■ Deutsch ■ Français ■ Español ■ Italiano ■ Nederlands ■ Portuguesa ■ Polski ■ русский язык (Russian) ■ Svenska ■ Türkçe ■ 中文 (Chinese) ■ 日本語 (Japanese) ■ 한국어 (Korean) ■ čeština (Czech)
Factory setting	English (alternatively, the ordered language is preset in the device)

Value 5 display



Navigation	 Expert → System → Display → Value 5 display
Prerequisite	<ul style="list-style-type: none"> ■ A local display is provided. ■ The Load rate option is only available if the volume flow of the medium is read in via the Current input 1 to n (→  49) or the fieldbus.
Description	Use this function to select a measured value that is shown on the local display.
Selection	For the picklist, see Value 1 display parameter (→  17)
Factory setting	None
Additional information	<p><i>Description</i></p> <p>If several measured values are displayed one below the other, the measured value selected here will be the fifth value to be displayed. The value is only displayed during normal operation.</p> <p> The Format display parameter (→  14) is used to specify how many measured values are displayed simultaneously and how.</p> <p><i>Options</i></p> <p> The unit of the displayed measured value is taken from the System units submenu (→  54).</p>

0% bargraph value 5

**Navigation**

Expert → System → Display → 0% bargraph 5

PrerequisiteAn option was selected in the **Value 5 display** parameter (→ 23).**Description**

Use this function to enter the 0% bar graph value to be shown on the display for the measured value 5.

User entry

Signed floating-point number

Factory setting

0

Additional information*Description* The **Format display** parameter (→ 14) is used to specify that the measured value is to be displayed as a bar graph.*User entry* The unit of the displayed measured value is taken from the **System units** submenu (→ 54).

100% bargraph value 5

**Navigation**

Expert → System → Display → 100% bargraph 5

PrerequisiteAn option was selected in the **Value 5 display** parameter (→ 23).**Description**

Use this function to enter the 100% bar graph value to be shown on the display for the measured value 5.

User entry

Signed floating-point number

Factory setting

0

Additional information*Description* The **Format display** parameter (→ 14) is used to specify that the measured value is to be displayed as a bar graph.*User entry* The unit of the displayed measured value is taken from the **System units** submenu (→ 54).

Decimal places 5







**Navigation**

Expert → System → Display → Decimal places 5



PrerequisiteA measured value is specified in the **Value 5 display** parameter (→ 23).

Description	Use this function to select the number of decimal places for measured value 5.
Selection	<ul style="list-style-type: none"> ■ x ■ x.x ■ x.xx ■ x.xxx ■ x.xxxx ■ x.xxxxx ■ x.xxxxxx
Factory setting	x.xx
Additional information	<p><i>Description</i></p> <p> This setting does not affect the accuracy of the device for measuring or calculating the value.</p>

Value 6 display







Navigation	 Expert → System → Display → Value 6 display
Prerequisite	<ul style="list-style-type: none"> ■ A local display is provided. ■ The Load rate option is only available if the volume flow of the medium is read in via the Current input 1 to n (→  49) or the fieldbus.
Description	Use this function to select a measured value that is shown on the local display.
Selection	For the picklist, see Value 1 display parameter (→  17)
Factory setting	None
Additional information	<p><i>Description</i></p> <p>If several measured values are displayed one below the other, the measured value selected here will be the sixth value to be displayed. The value is only displayed during normal operation.</p> <p> The Format display parameter (→  14) is used to specify how many measured values are displayed simultaneously and how.</p> <p><i>Options</i></p> <p> The unit of the displayed measured value is taken from the System units submenu (→  54).</p>

Decimal places 6



Navigation	 Expert → System → Display → Decimal places 6
Prerequisite	A measured value is specified in the Value 6 display parameter (→  25).
Description	Use this function to select the number of decimal places for measured value 6.

Selection	<ul style="list-style-type: none"> ■ X ■ X.X ■ X.XX ■ X.XXX ■ X.XXXX ■ X.XXXXX ■ X.XXXXXX
Factory setting	x.xx
Additional information	<p><i>Description</i></p> <p> This setting does not affect the accuracy of the device for measuring or calculating the value.</p>

Value 7 display



Navigation	 Expert → System → Display → Value 7 display
Prerequisite	<ul style="list-style-type: none"> ■ A local display is provided. ■ The Load rate option is only available if the volume flow of the medium is read in via the Current input 1 to n (→  49) or the fieldbus.
Description	Use this function to select a measured value that is shown on the local display.
Selection	For the picklist, see Value 1 display parameter (→  17)
Factory setting	None
Additional information	<p><i>Description</i></p> <p>If several measured values are displayed one below the other, the measured value selected here will be the seventh value to be displayed. The value is only displayed during normal operation.</p> <p> The Format display parameter (→  14) is used to specify how many measured values are displayed simultaneously and how.</p> <p><i>Options</i></p> <p> The unit of the displayed measured value is taken from the System units submenu (→  54).</p>

0% bargraph value 7



Navigation	 Expert → System → Display → 0% bargraph 7
Prerequisite	An option was selected in the Value 7 display parameter (→  26).
Description	Use this function to enter the 0% bar graph value to be shown on the display for the measured value 7.
User entry	Signed floating-point number

Factory setting 0

Additional information *Description*

 The **Format display** parameter (→  14) is used to specify that the measured value is to be displayed as a bar graph.

User entry

 The unit of the displayed measured value is taken from the **System units** submenu (→  54).

100% bargraph value 7

Navigation   Expert → System → Display → 100% bargraph 7



Prerequisite An option was selected in the **Value 7 display** parameter (→  26).

Description Use this function to enter the 100% bar graph value to be shown on the display for the measured value 7.

User entry Signed floating-point number

Factory setting 0

Additional information *Description*

 The **Format display** parameter (→  14) is used to specify that the measured value is to be displayed as a bar graph.

User entry

 The unit of the displayed measured value is taken from the **System units** submenu (→  54).

Decimal places 7

Navigation   Expert → System → Display → Decimal places 7

Prerequisite A measured value is specified in the **Value 7 display** parameter (→  26).

Description Use this function to select the number of decimal places for measured value 7.



Selection





- x
- x.x
- x.xx
- x.xxx
- x.xxxx
- x.xxxxx
- x.xxxxxx

Factory setting x.xx



Additional information	<p><i>Description</i></p> <p> This setting does not affect the accuracy of the device for measuring or calculating the value.</p>
-------------------------------	--

Value 8 display

Navigation	 Expert → System → Display → Value 8 display
Prerequisite	<ul style="list-style-type: none"> ■ A local display is provided. ■ The Load rate option is only available if the volume flow of the medium is read in via the Current input 1 to n (→  49) or the fieldbus.
Description	Use this function to select a measured value that is shown on the local display.
Selection	For the picklist, see Value 1 display parameter (→  17)
Factory setting	None





Additional information	<p><i>Description</i></p> <p>If several measured values are displayed one below the other, the measured value selected here will be the eighth value to be displayed. The value is only displayed during normal operation.</p> <p> The Format display parameter (→  14) is used to specify how many measured values are displayed simultaneously and how.</p> <p><i>Options</i></p> <p> The unit of the displayed measured value is taken from the System units submenu (→  54).</p>
-------------------------------	--

Decimal places 8



Navigation	 Expert → System → Display → Decimal places 8
Prerequisite	A measured value is specified in the Value 8 display parameter (→  28).
Description	Use this function to select the number of decimal places for measured value 8.
Selection	<ul style="list-style-type: none"> ■ x ■ x.x ■ x.xx ■ x.xxx ■ x.xxxx ■ x.xxxxx ■ x.xxxxxx
Factory setting	x.xx

Additional information	<i>Description</i>
	 This setting does not affect the accuracy of the device for measuring or calculating the value.

Display interval

Navigation	 Expert → System → Display → Display interval
Prerequisite	A local display is provided.
Description	Use this function to enter the length of time the measured values are displayed if the values alternate on the display.
User entry	1 to 10 s
Factory setting	5 s
Additional information	<i>Description</i>
	This type of alternating display only occurs automatically if the number of measured values defined exceeds the number of values the selected display format can display simultaneously.
	 <ul style="list-style-type: none"> ▪ The Value 1 display parameter (→  17)...Value 8 display parameter (→  28) are used to specify which measured values are shown on the local display. ▪ The display format for the measured values displayed is defined in the Format display parameter (→  14).

Display damping

Navigation	 Expert → System → Display → Display damping
Prerequisite	A local display is provided.
Description	Use this function to enter a time constant for the reaction time of the local display to fluctuations in the measured value caused by process conditions.
User entry	0.0 to 999.9 s
Factory setting	0.0 s
Additional information	<i>User entry</i>
	Use this function to enter a time constant (PT1 element ¹⁾) for display damping: <ul style="list-style-type: none"> ▪ At a low time constant, the display reacts quickly to fluctuating measured variables. ▪ If a high time constant is entered, the display reacts more slowly.
	 The damping is not active if the value 0 (factory setting) is entered.

1) proportional transmission behavior with first order delay

Header 🔒

Navigation	🔍📄 Expert → System → Display → Header
Prerequisite	A local display is provided.
Description	Use this function to select the contents of the header of the local display.
Selection	<ul style="list-style-type: none"> ▪ Device tag ▪ Free text
Factory setting	Device tag
Additional information	<p><i>Description</i></p> <p>The header text only appears during normal operation.</p>

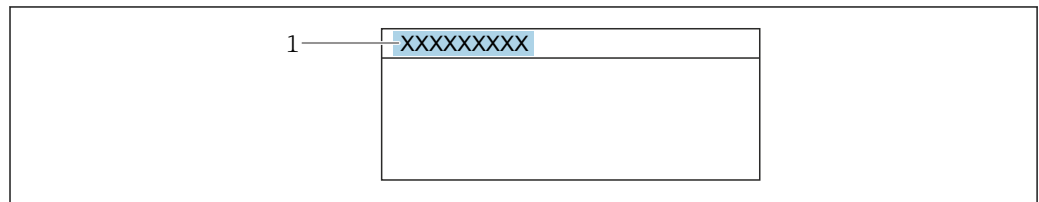

A0029422

1 Position of the header text on the display

Selection

- Device tag
Is defined in the **Device tag** parameter (→ 📄 138).
- Free text
Is defined in the **Header text** parameter (→ 📄 30).

Header text 🔒

Navigation	🔍📄 Expert → System → Display → Header text
Prerequisite	The Free text option is selected in the Header parameter (→ 📄 30).
Description	Use this function to enter a customer-specific text for the header of the local display.
User entry	Max. 12 characters, such as letters, numbers or special characters (e.g. @, %, /)
Factory setting	-----
Additional information	<p><i>Description</i></p> <p>The header text only appears during normal operation.</p>

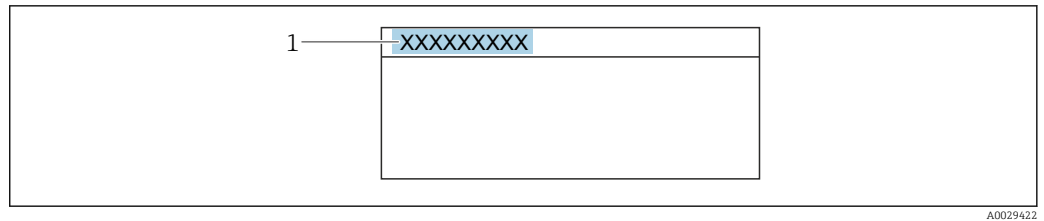

A0029422

1 Position of the header text on the display

User entry

The number of characters displayed depends on the characters used.

Separator



Navigation	Expert → System → Display → Separator
Prerequisite	A local display is provided.
Description	Use this function to select the decimal separator.
Selection	<ul style="list-style-type: none"> ▪ . (point) ▪ , (comma)
Factory setting	. (point)

Contrast display

Navigation	Expert → System → Display → Contrast display
Prerequisite	A local display is provided.
Description	Use this function to enter a value to adapt the display contrast to the ambient conditions (e.g. the lighting or viewing angle).
User entry	20 to 80 %
Factory setting	Depends on the display





Backlight

Navigation	Expert → System → Display → Backlight
Prerequisite	One of the following conditions is met: <ul style="list-style-type: none"> ▪ Order code for "Display; operation", option F "4-line, illum.; touch control" ▪ Order code for "Display; operation", option G "4-line, illum.; touch control +WLAN"

Description	Use this function to switch the backlight of the local display on and off.
Selection	<ul style="list-style-type: none"> ▪ Disable ▪ Enable
Factory setting	Enable

3.1.2 "Configuration backup" submenu

Navigation  Expert → System → Config. backup

▶ Configuration backup		
Operating time	→	 32
Last backup	→	 32
Configuration management	→	 33
Backup state	→	 33
Comparison result	→	 34

Operating time

Navigation	 Expert → System → Config. backup → Operating time
Description	Displays the length of time the device has been in operation.
User interface	Days (d), hours (h), minutes (m) and seconds (s)
Additional information	<p><i>Indication</i></p> <p>Maximum number of days: 9 999 (corresponds to approx. 27 years and 5 months)</p>

Last backup

Navigation	 Expert → System → Config. backup → Last backup
Description	Displays the time since a backup copy of the data was last saved to the device memory.
User interface	Days (d), hours (h), minutes (m) and seconds (s)

Configuration management

Navigation	Expert → System → Config. backup → Config. managem.
Description	Use this function to select an action to save the data to the device memory.
Selection	<ul style="list-style-type: none"> ■ Cancel ■ Execute backup ■ Restore * ■ Compare * ■ Clear backup data
Factory setting	Cancel
Additional information	<i>Selection</i>

Options	Description
Cancel	No action is executed and the user exits the parameter.
Execute backup	A backup copy of the current device configuration is saved from the HistoROM backup to the memory of the device. The backup copy includes the transmitter data of the device. The following message appears on local display: Backup active, please wait!
Restore	The last backup copy of the device configuration is restored from the device memory to the device's HistoROM backup. The backup copy includes the transmitter data of the device. The following message appears on local display: Restore active! Do not interrupt power supply!
Compare	The device configuration saved in the device memory is compared with the current device configuration of the HistoROM backup. The following message appears on local display: Comparing files The result can be viewed in Comparison result parameter.
Clear backup data	The backup copy of the device configuration is deleted from the memory of the device. The following message appears on local display: Deleting file

HistoROM

A HistoROM is a "non-volatile" device memory in the form of an EEPROM.

Backup state

Navigation	Expert → System → Config. backup → Backup state
Description	Displays the status of the data backup process.
User interface	<ul style="list-style-type: none"> ■ None ■ Backup in progress ■ Restoring in progress ■ Delete in progress

* Visibility depends on order options or device settings

- Compare in progress
- Restoring failed
- Backup failed

Factory setting None

Comparison result

Navigation  Expert → System → Config. backup → Compar. result

Description Displays the last result of the comparison of the data records in the device memory and in the HistoROM.

User interface ■ Settings identical
 ■ Settings not identical
 ■ No backup available
 ■ Backup settings corrupt
 ■ Check not done
 ■ Dataset incompatible

Factory setting Check not done

Additional information *Description*

 The comparison is started via the **Compare** option in the **Configuration management** parameter (→  33).

Options

Options	Description
Settings identical	The current device configuration of the HistoROM is not identical to the backup copy in the device memory. If the transformer configuration of another device has been transmitted to the device via HistoROM in Configuration management parameter, the current device configuration of the HistoROM is only partially identical to the backup copy in the device memory: The settings for the transmitter are not identical.
Settings not identical	The current device configuration of the HistoROM is not identical to the backup copy in the device memory.
No backup available	There is no backup copy of the device configuration of the HistoROM in the device memory.
Backup settings corrupt	The current device configuration of the HistoROM is corrupt or not compatible with the backup copy in the device memory.
Check not done	The device configuration of the HistoROM has not yet been compared to the backup copy in the device memory.
Dataset incompatible	The backup copy in the device memory is not compatible with the device.

HistoROM

A HistoROM is a "non-volatile" device memory in the form of an EEPROM.

3.1.3 "Diagnostic handling" submenu

Navigation  Expert → System → Diagn. handling

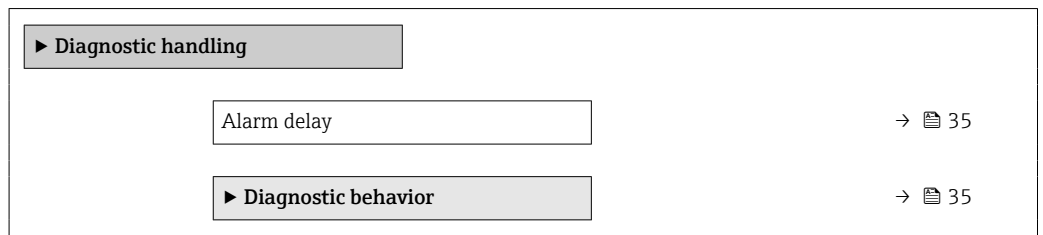

Alarm delay

Navigation  Expert → System → Diagn. handling → Alarm delay

Description Use this function to enter the time interval until the device generates a diagnostic message.

 The diagnostic message is reset without a time delay.

User entry 0 to 60 s

Factory setting 0 s

Additional information *Effect*

This setting affects the following diagnostic messages:



- 832 Electronics temperature too high
- 833 Electronics temperature too low
- 834 Process temperature too high
- 835 Process temperature too low
- 881 Signal to noise ratio too low
- 907 Permittivity out of specification
- 908 Volume fraction out of specification
- 909 Conductivity out of specification

"Diagnostic behavior" submenu

Each item of diagnostic information is assigned a specific diagnostic behavior at the factory. The user can change this assignment for specific diagnostic information in the **Diagnostic behavior** submenu (→  35).











The following options are available in the **Assign behavior of diagnostic no. xxx** parameters:

Options	Description
Alarm	The device stops measurement. The measured value output via Modbus RS485 and the totalizers assume the defined alarm condition. A diagnostic message is generated. The background lighting changes to red.
Warning	The device continues to measure. The measured value output via Modbus RS485 and the totalizers are not affected. A diagnostic message is generated.



Options	Description
Logbook entry only	The device continues to measure. The diagnostic message is only displayed in the Event logbook submenu (→  136) (Event list submenu (→  137)) and is not displayed in alternating sequence with the operational display.
Off	The diagnostic event is ignored, and no diagnostic message is generated or entered.

 For a list of all the diagnostic events, see the Operating Instructions for the device

Navigation   Expert → System → Diagn. handling → Diagn. behavior

► Diagnostic behavior	
Assign behavior of diagnostic no. 302	→  38
Assign behavior of diagnostic no. 444	→  37
Assign behavior of diagnostic no. 441	→  36
Assign behavior of diagnostic no. 442	→  37
Assign behavior of diagnostic no. 443	→  37
Assign behavior of diagnostic no. 832	→  38
Assign behavior of diagnostic no. 833	→  39
Assign behavior of diagnostic no. 834	→  39
Assign behavior of diagnostic no. 835	→  39
Assign behavior of diagnostic no. 907	→  40
Assign behavior of diagnostic no. 908	→  40

Assign behavior of diagnostic no. 441 (Current output 1 to n)



Navigation   Expert → System → Diagn. handling → Diagn. behavior → Diagnostic no. 441

Description Use this function to change the diagnostic behavior of the **441 Current output 1 to n** diagnostic message.

Selection





- Off
- Alarm
- Warning
- Logbook entry only

Factory setting Warning

Additional information  For a detailed description of the options available: →  35





Assign behavior of diagnostic no. 442 (Frequency output 1 to n)



Navigation	  Expert → System → Diagn. handling → Diagn. behavior → Diagnostic no. 442
Prerequisite	The measuring device has a pulse/frequency/switch output.
Description	Use this function to change the diagnostic behavior of the 442 Frequency output 1 to n diagnostic message.
Selection	<ul style="list-style-type: none"> ▪ Off ▪ Alarm ▪ Warning ▪ Logbook entry only
Factory setting	Warning
Additional information	 For a detailed description of the options available: →  35



Assign behavior of diagnostic no. 443 (Pulse output 1 to n)





Navigation	  Expert → System → Diagn. handling → Diagn. behavior → Diagnostic no. 443
Prerequisite	The measuring device has a pulse/frequency/switch output.
Description	Use this function to change the diagnostic behavior of the 443 Pulse output 1 to n diagnostic message.
Selection	<ul style="list-style-type: none"> ▪ Off ▪ Alarm ▪ Warning ▪ Logbook entry only
Factory setting	Warning
Additional information	 For a detailed description of the options available: →  35





Assign behavior of diagnostic no. 444 (Current input 1 to n)







Navigation	  Expert → System → Diagn. handling → Diagn. behavior → Diagnostic no. 444
Prerequisite	The device has one current input.

Description	Use this function to change the diagnostic behavior of the 444 Current input 1 to n diagnostic message.
Selection	<ul style="list-style-type: none">▪ Off▪ Alarm▪ Warning▪ Logbook entry only
Factory setting	Warning
Additional information	 For a detailed description of the options available: →  35

Assign behavior of diagnostic no. 302

Navigation	  Expert → System → Diagn. handling → Diagn. behavior → Diagnostic no. 302
Description	Use this function to change the diagnostic behavior of the 302 Device verification active diagnostic message.
Selection	<ul style="list-style-type: none">▪ Off▪ Warning▪ Logbook entry only
Factory setting	Warning
Additional information	 For a detailed description of the options available: →  35

Assign behavior of diagnostic no. 832

Navigation	  Expert → System → Diagn. handling → Diagn. behavior → Diagnostic no. 832
Description	Use this function to change the diagnostic behavior of the 832 Electronics temperature too high diagnostic message.
Selection	<ul style="list-style-type: none">▪ Off▪ Alarm▪ Warning▪ Logbook entry only
Factory setting	Warning
Additional information	 For a detailed description of the options available: →  35

Assign behavior of diagnostic no. 833

Navigation	Expert → System → Diagn. handling → Diagn. behavior → Diagnostic no. 833
Description	Use this function to change the diagnostic behavior of the 833 Electronics temperature too low diagnostic message.
Selection	<ul style="list-style-type: none"> ▪ Off ▪ Alarm ▪ Warning ▪ Logbook entry only
Factory setting	Warning
Additional information	For a detailed description of the options available: → 35

Assign behavior of diagnostic no. 834

Navigation	Expert → System → Diagn. handling → Diagn. behavior → Diagnostic no. 834
Description	Use this function to change the diagnostic behavior of the 834 Process temperature too high diagnostic message.
Selection	<ul style="list-style-type: none"> ▪ Off ▪ Alarm ▪ Warning ▪ Logbook entry only
Factory setting	Warning
Additional information	For a detailed description of the options available: → 35

Assign behavior of diagnostic no. 835

Navigation	Expert → System → Diagn. handling → Diagn. behavior → Diagnostic no. 835
Description	Use this function to change the diagnostic behavior of the 835 Process temperature too low diagnostic message.
Selection	<ul style="list-style-type: none"> ▪ Off ▪ Alarm ▪ Warning ▪ Logbook entry only
Factory setting	Warning
Additional information	For a detailed description of the options available: → 35

Assign behavior of diagnostic no. 907

Navigation	Expert → System → Diagn. handling → Diagn. behavior → Diagnostic no. 907
Description	Use this function to change the diagnostic behavior of the 907 Permittivity out of specification diagnostic message.
Selection	<ul style="list-style-type: none"> ▪ Off ▪ Alarm ▪ Warning ▪ Logbook entry only
Factory setting	Warning
Additional information	For a detailed description of the options available: → 35

Assign behavior of diagnostic no. 908

Navigation	Expert → System → Diagn. handling → Diagn. behavior → Diagnostic no. 908
Description	Use this function to change the diagnostic behavior of the 908 Volume fraction out of specification diagnostic message.
Selection	<ul style="list-style-type: none"> ▪ Off ▪ Alarm ▪ Warning ▪ Logbook entry only
Factory setting	Warning
Additional information	For a detailed description of the options available: → 35

3.1.4 "Administration" submenu

Navigation Expert → System → Administration

▶ Administration	
▶ Define access code	→ 41
▶ Reset access code	→ 42
Device reset	→ 43
Transmitter identifier	→ 44

Activate SW option	→ 44
Software option overview	→ 45

"Define access code" wizard

 The **Define access code** wizard (→ 41) is only available when operating via the local display or Web browser.

If operating via the operating tool, the **Define access code** parameter can be found directly in the **Administration** submenu. There is no **Confirm access code** parameter if the device is operated via the operating tool.

Navigation  Expert → System → Administration → Def. access code

▶ Define access code	
Define access code	→ 41
Confirm access code	→ 42



Define access code



Navigation  Expert → System → Administration → Def. access code → Def. access code

Description Use this function to enter a user-specific release code to restrict write-access to the parameters. This protects the device configuration against any inadvertent modifications via the local display, Web browser, FieldCare or DeviceCare (via CDI-RJ45 service interface).

User entry Max. 16-digit character string comprising numbers, letters and special characters

Additional information *Description*
 The write protection affects all parameters in the document marked with the  symbol. On the local display, the  symbol in front of a parameter indicates that the parameter is write-protected.

The parameters that cannot be write-accessed are grayed out in the Web browser.

 Once the access code has been defined, write-protected parameters can only be modified if the access code is entered in the **Enter access code** parameter (→ 13).

 If you lose the access code, please contact your Endress+Hauser sales organization.

User entry

A message is displayed if the access code is not in the input range.

Factory setting

If the factory setting is not changed or **0** is defined as the access code, the parameters are not write-protected and the device configuration data can be modified. The user is logged on in the **"Maintenance"** role.

Confirm access code

Navigation	Expert → System → Administration → Def. access code → Confirm code
Description	Enter the defined release code a second time to confirm the release code.
User entry	Max. 16-digit character string comprising numbers, letters and special characters

"Reset access code" submenu

Navigation Expert → System → Administration → Reset acc. code

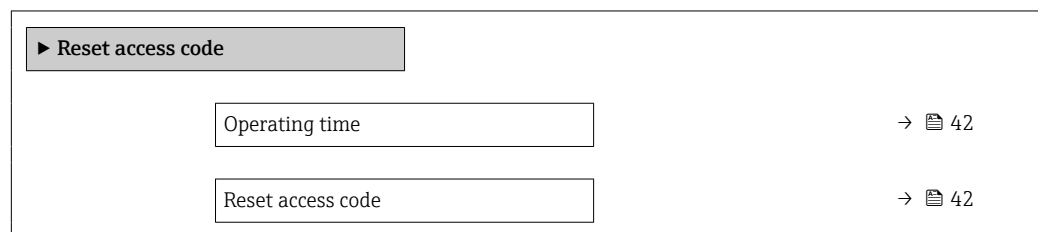

Operating time

Navigation	Expert → System → Administration → Reset acc. code → Operating time
Description	Displays the length of time the device has been in operation.
User interface	Days (d), hours (h), minutes (m) and seconds (s)
Additional information	<i>Indication</i> Maximum number of days: 9 999 (corresponds to approx. 27 years and 5 months)

Reset access code

Navigation	Expert → System → Administration → Reset acc. code → Reset acc. code
Description	Use this function to enter a reset code to reset the user-specific access codes to the factory setting .
User entry	Character string comprising numbers, letters and special characters
Factory setting	0x00

Additional information

Description



 For a reset code, contact your Endress+Hauser service organization.

User entry

The reset code can only be entered via:









- Web browser
- DeviceCare, FieldCare (via CDI RJ45 interface)
- Fieldbus

Additional parameters in the "Administration" submenu



Device reset 	
Navigation	 Expert → System → Administration → Device reset
Description	Reset the device configuration - either entirely or in part - to a defined state.
Selection	<ul style="list-style-type: none"> ■ Cancel ■ To delivery settings ■ Restart device ■ Restore S-DAT backup *
Factory setting	Cancel
Additional information	<i>Selection</i>

Options	Description
Cancel	No action is executed and the user exits the parameter.
To delivery settings	Every parameter for which a customer-specific default setting was ordered is reset to the customer-specific value. All other parameters are reset to the factory setting.
Restart device	The restart resets every parameter with data stored in volatile memory (RAM) to the factory setting (e.g. measured value data). The device configuration remains unchanged.
Restore S-DAT backup	Restores the data that is saved on the S-DAT. Additional information: This function can be used to resolve the memory issue "083 Memory content inconsistent" or to restore the S-DAT data when a new S-DAT has been installed.  This option is displayed only in an alarm condition.

* Visibility depends on order options or device settings







Transmitter identifier 	
Navigation	  Expert → System → Administration → Transm. identif.
Description	Select transmitter identifier.
User interface	<ul style="list-style-type: none"> ■ Unknown ■ 500 ■ 300
Factory setting	500
Activate SW option 	
Navigation	  Expert → System → Administration → Activate SW opt.
Description	Use this function to enter an activation code to enable an additional, ordered software option.
User entry	Max. 10-digit string of numbers.
Factory setting	Depends on the software option ordered
Additional information	<p><i>Description</i></p> <p>If a measuring device was ordered with an additional software option, the activation code is programmed in the device at the factory.</p> <p> To activate a software option subsequently, please contact your Endress+Hauser sales organization.</p> <p><i>Entering the activation code</i></p> <p> The activation code is linked to the serial number of the measuring device and varies according to the device and software option.</p> <p>If an incorrect or invalid code is entered, this results in the loss of software options that have already been activated.</p> <ul style="list-style-type: none"> ▶ Before you enter a new activation code, make a note of the current activation code . ▶ Enter the new activation code provided by Endress+Hauser when the new software option was ordered. ▶ If the code entered is incorrect or invalid, enter the old activation code . ▶ Have your Endress+Hauser sales organization check the new activation code remembering to specify the serial number or ask for the code again. <p><i>Example for a software option</i></p> <p>Order code for "Application package", option EA "Extended HistoROM"</p> <p><i>Web browser</i></p> <p> Once a software option has been activated, the page must be loaded again in the Web browser.</p>

Software option overview

Navigation	  Expert → System → Administration → SW option overv.
Description	Displays all the software options that are enabled in the device.
User interface	
Additional information	<p><i>Description</i></p> <p>Displays all the options that are available if ordered by the customer.</p> <p><i>"Extended HistoROM" option</i></p> <p>Order code for "Application package", option EA "Extended HistoROM"</p>





3.2 "Sensor" submenu

Navigation   Expert → Sensor

▶ Sensor	
▶ Measured values	→  45
▶ System units	→  54
▶ Process parameters	→  57
▶ External process variables	→  61
▶ Sensor adjustment	→  62
▶ Factory adjustment	→  65







3.2.1 "Measured values" submenu

Navigation   Expert → Sensor → Measured val.

▶ Measured values	
▶ Process variables	→  46
▶ Totalizer	→  47
▶ Input values	→  48
▶ Output values	→  50

"Process variables" submenu

Navigation  Expert → Sensor → Measured val. → Process variab.

► Process variables	
Total solids	→  46
Temperature	→  46
Electronics temperature	→  46
Conductivity	→  47
Corrected conductivity	→  47
Load rate	→  47

Total solids

Navigation  Expert → Sensor → Measured val. → Process variab. → Total solids

Description Shows total solids (fraction of total weight or concentration per volume unit).

User interface Signed floating-point number

Temperature

Navigation  Expert → Sensor → Measured val. → Process variab. → Temperature

Description Shows the medium temperature currently measured.

User interface Signed floating-point number



Electronics temperature

Navigation  Expert → Sensor → Measured val. → Process variab. → Electronics temp



Description Shows the electronics temperature currently measured.

User interface Signed floating-point number



Conductivity

Navigation	  Expert → Sensor → Measured val. → Process variab. → Conductivity
Description	Shows the conductivity currently measured.
User interface	Floating-point number



Corrected conductivity



Navigation	  Expert → Sensor → Measured val. → Process variab. → CorrConductivity
Description	Shows the conductivity measured compensated for temperature.
User interface	Floating-point number

Load rate





Navigation	  Expert → Sensor → Measured val. → Process variab. → Load rate
Prerequisite	The volume flow of the medium is read in via the Current input 1 to n (→  49) or the fieldbus.
Description	Shows the total solids flow rate.
User interface	Signed floating-point number

"Totalizer" submenu

Navigation   Expert → Sensor → Measured val. → Totalizer



▶ Totalizer	
Totalizer 1 value	→  48
Totalizer 1 overflow	→  48

Totalizer 1 value

Navigation	 Expert → Sensor → Measured val. → Totalizer → Tot. 1 value
Description	Displays the current totalizer reading.
User interface	Signed floating-point number
Additional information	<p><i>Description</i></p> <p>As it is only possible to display a maximum of 7 digits in the operating tool, the current counter value is the sum of the totalizer value and the overflow value from the Totalizer overflow 1 to n parameter if the display range is exceeded.</p> <p> In the event of an error, the totalizer adopts the mode defined in the Failure mode parameter (→  130).</p> <p><i>Display</i></p> <p> The unit of the selected process variable is defined in the Unit totalizer parameter (→  128) for the totalizer.</p>

Totalizer 1 overflow



Navigation	 Expert → Sensor → Measured val. → Totalizer → Tot. 1 overflow
Description	Displays the current totalizer overflow.
User interface	Integer with sign
Additional information	<p><i>Description</i></p> <p>If the current totalizer reading exceeds 7 digits, which is the maximum value range that can be displayed by the operating tool, the value above this range is output as an overflow. The current totalizer value is therefore the sum of the overflow value and the totalizer value from the Totalizer value 1 to n parameter.</p> <p><i>Display</i></p> <p> The unit of the selected process variable is defined in the Unit totalizer parameter (→  128) for the totalizer.</p>

"Input values" submenu

Navigation  Expert → Sensor → Measured val. → Input values

▶ Input values

▶ Current input 1 to n	→ 49
▶ Value status input 1 to n	→ 49

"Current input 1 to n" submenu

Navigation Expert → Sensor → Measured val. → Input values → Current input 1 to n

▶ Current input 1 to n	
Measured values 1 to n	→ 49
Measured current 1 to n	→ 49

Measured values 1 to n

Navigation Expert → Sensor → Measured val. → Input values → Current input 1 to n → Measured val. 1 to n

Description Displays the current input value.

User interface Signed floating-point number

Measured current 1 to n

Navigation Expert → Sensor → Measured val. → Input values → Current input 1 to n → Measur. curr. 1 to n

Description Displays the current value of the current input.

User interface 0 to 22.5 mA

"Value status input 1 to n" submenu

Navigation Expert → Sensor → Measured val. → Input values → Val.stat.inp. 1 to n



▶ Value status input 1 to n	
Value status input	→ 50

Value status input

Navigation	 Expert → Sensor → Measured val. → Input values → Val.stat.inp. 1 to n → Val.stat.inp.
Description	Displays the current input signal level.
User interface	<ul style="list-style-type: none"> ■ High ■ Low



"Output values" submenu

Navigation  Expert → Sensor → Measured val. → Output values

▶ Output values	
▶ Value current output 1 to n	→  50
▶ Pulse/frequency/switch output 1 to n	→  51
▶ Relay output 1 to n	→  53

"Value current output 1 to n" submenu



Navigation  Expert → Sensor → Measured val. → Output values → Current output 1 to n

▶ Value current output 1 to n	
Output current	→  50
Measured current	→  51

Output current

Navigation	 Expert → Sensor → Measured val. → Output values → Current output 1 to n → Output curr.
Description	Displays the current value currently calculated for the current output.
User interface	0 to 22.5 mA



Measured current

Navigation   Expert → Sensor → Measured val. → Output values → Current output 1 to n → Measur. curr.



Description Displays the actual measured value of the output current.

User interface 0 to 30 mA



"Pulse/frequency/switch output 1 to n" submenu

Navigation   Expert → Sensor → Measured val. → Output values → PFS output 1 to n

► Pulse/frequency/switch output 1 to n

Output frequency	→  51
Pulse output	→  51
Switch state	→  52

Output frequency



Navigation   Expert → Sensor → Measured val. → Output values → PFS output 1 to n → Output freq.

Prerequisite In the **Operating mode** parameter (→  87), the **Frequency** option is selected.

Description Displays the actual value of the output frequency which is currently measured.

User interface 0.0 to 12 500.0 Hz

Pulse output

Navigation   Expert → Sensor → Measured val. → Output values → PFS output 1 to n → Pulse output

Prerequisite The **Pulse** option is selected in the **Operating mode** parameter (→  87) parameter.

Description Displays the pulse frequency currently output.

User interface Positive floating-point number

Additional information *Description*

- The pulse output is an open collector output.
- This is configured at the factory in such a way that the transistor is conductive for the duration of the pulse (NO contact) and is safety-oriented.

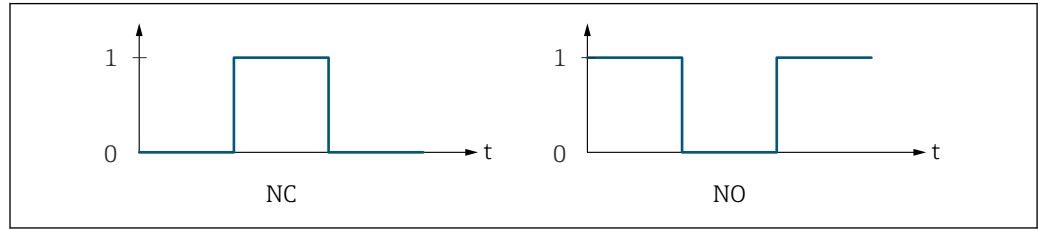

A0028726

0 Non-conductive
 1 Conductive
 NC NC contact (normally closed)
 NO NO contact (normally open)

The output behavior can be reversed via the **Invert output signal** parameter (→ 103) i.e. the transistor does not conduct for the duration of the pulse.

In addition, the behavior of the output in the event of a device alarm (**Failure mode** parameter (→ 91)) can be configured.

Switch state

Navigation Expert → Sensor → Measured val. → Output values → PFS output 1 to n → Switch state

Prerequisite The **Switch** option is selected in the **Operating mode** parameter (→ 87).

Description Displays the current switch status of the status output.

User interface

- Open
- Closed

Additional information *User interface*

- Open
The switch output is not conductive.
- Closed
The switch output is conductive.

"Relay output 1 to n" submenu

Navigation  Expert → Sensor → Measured val. → Output values → Relay output 1 to n

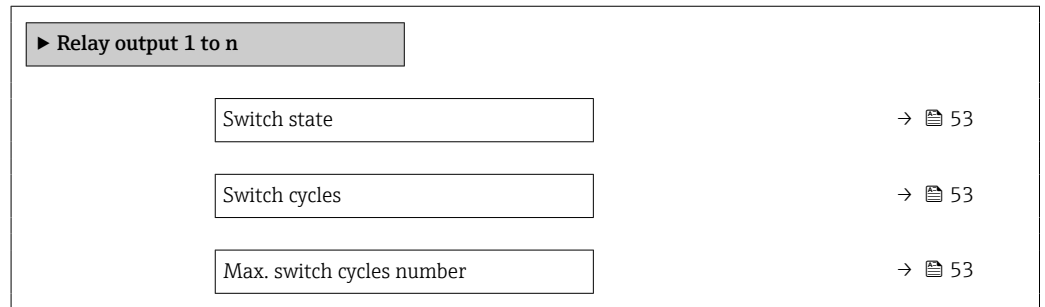

Switch state

Navigation  Expert → Sensor → Measured val. → Output values → Relay output 1 to n → Switch state

Description Displays the current status of the relay output.

User interface

- Open
- Closed

Additional information *User interface*

- Open
The relay output is not conductive.
- Closed
The relay output is conductive.

Switch cycles

Navigation  Expert → Sensor → Measured val. → Output values → Relay output 1 to n → Switch cycles

Description Displays all the switch cycles performed.

User interface Positive integer

Max. switch cycles number

Navigation  Expert → Sensor → Measured val. → Output values → Relay output 1 to n → Max. cycles no.









Description Displays the maximum number of guaranteed switch cycles.

User interface

Positive integer

3.2.2 "System units" submenu

Navigation  Expert → Sensor → System units

▶ System units	
Total solids unit	→  54
Density unit	→  55
Mass flow unit	→  55
Mass unit	→  55
Volume flow unit	→  56
Temperature unit	→  56
Conductivity unit	→  56
Date/time format	→  57

Total solids unit**Navigation**

 Expert → Sensor → System units → TotalSolidsUnit

Description

Select total solids unit.

Selection*SI units*

- %TS
- ppm
- g/l
- mg/l
- kg/m³
- mg/cm³

US units

- lb/gal (us)
- lb/ft³

Factory setting

Depends on country

Density unit



Navigation Expert → Sensor → System units → Density unit

Description Select density unit.

Selection	<i>SI units</i>	<i>US units</i>
	<ul style="list-style-type: none"> ▪ g/l ▪ mg/l ▪ kg/m³ ▪ mg/cm³ 	<ul style="list-style-type: none"> ▪ lb/gal (us) ▪ lb/ft³

Factory setting Depends on country

Mass flow unit



Navigation Expert → Sensor → System units → Mass flow unit

Prerequisite The volume flow of the medium is read in via the Current input 1 to n (→ 49).

Description Select mass flow unit.

Selection	<i>SI units</i>	<i>US units</i>
	<ul style="list-style-type: none"> ▪ kg/h ▪ kg/d ▪ t/h ▪ t/d 	<ul style="list-style-type: none"> ▪ oz/h ▪ oz/d ▪ lb/h ▪ lb/d ▪ STon/h ▪ STon/d

Factory setting Depends on country

Mass unit



Navigation Expert → Sensor → System units → Mass unit



Prerequisite The volume flow of the medium is read in via the Current input 1 to n (→ 49) or the fieldbus.

Description Select mass unit.



Selection	<i>SI units</i>	<i>US units</i>
	<ul style="list-style-type: none"> ▪ kg ▪ t 	<ul style="list-style-type: none"> ▪ oz ▪ lb ▪ STon

Factory setting Depends on country



Volume flow unit

Navigation	  Expert → Sensor → System units → Volume flow unit
Prerequisite	The volume flow of the medium is read in via the Current input 1 to n (→  49).
Description	Select volume flow unit.
Selection	<i>SI units</i> <ul style="list-style-type: none"> ■ l/h ■ l/s ■ dm³/min ■ m³/h ■ m³/s
Factory setting	l/h

Temperature unit

Navigation	  Expert → Sensor → System units → Temperature unit				
Description	Select temperature unit.				
Selection	<table style="width: 100%; border: none;"> <tr> <td style="width: 50%; vertical-align: top;"><i>SI units</i></td> <td style="width: 50%; vertical-align: top;"><i>US units</i></td> </tr> <tr> <td style="vertical-align: top;"> <ul style="list-style-type: none"> ■ °C ■ K </td> <td style="vertical-align: top;"> <ul style="list-style-type: none"> ■ °F ■ °R </td> </tr> </table>	<i>SI units</i>	<i>US units</i>	<ul style="list-style-type: none"> ■ °C ■ K 	<ul style="list-style-type: none"> ■ °F ■ °R
<i>SI units</i>	<i>US units</i>				
<ul style="list-style-type: none"> ■ °C ■ K 	<ul style="list-style-type: none"> ■ °F ■ °R 				
Factory setting	Depends on country				

Conductivity unit

Navigation	  Expert → Sensor → System units → Conductiv. unit
Description	Select conductivity unit.
Selection	<i>SI units</i> <ul style="list-style-type: none"> ■ nS/cm ■ μS/cm ■ μS/m ■ μS/mm ■ mS/m ■ mS/cm ■ S/cm ■ S/m
Factory setting	μS/cm

Date/time format

Navigation	Expert → Sensor → System units → Date/time format
Description	Select date and time format.
Selection	<ul style="list-style-type: none"> ▪ dd.mm.yy hh:mm ▪ dd.mm.yy hh:mm am/pm ▪ mm/dd/yy hh:mm ▪ mm/dd/yy hh:mm am/pm
Factory setting	dd.mm.yy hh:mm

3.2.3 "Process parameters" submenu

Navigation Expert → Sensor → Process param.

▶ Process parameters	
Temperature damping	→ 57
Conductivity damping	→ 58
Total solids override	→ 58
▶ Total solids monitoring	→ 58
▶ Partially filled pipe detection	→ 60

Temperature damping

Navigation	Expert → Sensor → Process param. → Temp. damping
Description	Enter a time constant for damping (PT1 element) of the temperature measured value. Damping reduces the effect of measured value fluctuations.
User entry	0 to 999.9 s
Factory setting	0 s

Conductivity damping

Navigation	Expert → Sensor → Process param. → Conduct. damping
Description	Enter a time constant for damping (PT1 element) of the conductivity measured value. Damping reduces the effect of measured value fluctuations.
User entry	0 to 999.9 s
Factory setting	0 s

Total solids override

Navigation	Expert → Sensor → Process param. → TotalSolOverride
Description	If suppression of the total solids measurement is enabled (On option), zero is output for the measured value. This is suitable for the cleaning processes for the pipeline, for example.
Selection	<ul style="list-style-type: none"> ■ Off ■ On
Factory setting	Off

"Total solids monitoring" submenu

Navigation Expert → Sensor → Process param. → TotSolidsMonitor

▶ Total solids monitoring	
Assign process variable	→ 58
Lower range limit	→ 59
Upper range limit	→ 59
Response time	→ 59

Assign process variable



Navigation	Expert → Sensor → Process param. → TotSolidsMonitor → Assign variable
Description	Select the process variable for total solids monitoring.

Selection

- Off
- Total solids

Factory setting Total solids

Lower range limit



Navigation   Expert → Sensor → Process param. → TotSolidsMonitor → LowerRangeLimit

Description Enter the lower limit value for the measuring range of the total solids.

User entry Signed floating-point number

Factory setting -1 %TS

Upper range limit



Navigation   Expert → Sensor → Process param. → TotSolidsMonitor → UpperRangeLimit

Description Enter the upper limit value for the measuring range of the total solids.

User entry Signed floating-point number

Factory setting 51 %TS

Response time

Navigation   Expert → Sensor → Process param. → TotSolidsMonitor → Response time



Description Enter a delay until the diagnostic message is generated in the event the measuring range is exceeded.

User entry 0 to 100 s

Factory setting 60 s

"Partially filled pipe detection" submenu

Navigation  Expert → Sensor → Process param. → Partial pipe det

▶ Partially filled pipe detection	
Partially filled pipe detection	→  60
Threshold	→  60
Response time	→  60

Partially filled pipe detection

Navigation	 Expert → Sensor → Process param. → Partial pipe det → Partial pipe det
Description	If activated, a diagnostic message is generated if the antennas are no longer in full contact with the medium.
Selection	<ul style="list-style-type: none"> ■ Off ■ On
Factory setting	Off

Threshold

Navigation	 Expert → Sensor → Process param. → Partial pipe det → Threshold
Description	Enter threshold for partially filled pipe detection. If the measured value drops below the threshold, a diagnostic message is generated.
User entry	Decibel as negative floating point number
Factory setting	-6 dB

Response time



Navigation	 Expert → Sensor → Process param. → Partial pipe det → Response time
Description	Enter a delay until the diagnostic message is generated in the event the pipe is detected as partially filled.
User entry	0 to 20.0 s

Factory setting 3 s

3.2.4 "External compensation" submenu

Navigation  Expert → Sensor → External comp.

▶ External process variables

Volume flow source	→  61
Volume flow	→  61

Volume flow source

Navigation  Expert → Sensor → ExternalProcVar. → VolumeFlowSource

Description Select the input via which the measured value of the volume flow is read in. The volume flow is used to calculate the load rate.

- Selection**
- Off
 - Current input 1 *
 - Current input 2 *
 - Current input 3 *
 - External value

Factory setting Off

Volume flow

Navigation  Expert → Sensor → ExternalProcVar. → Volume flow



Description Shows the volume flow reported by the external measuring device.

User entry Signed floating-point number

* Visibility depends on order options or device settings

3.2.5 "Sensor adjustment" submenu

Navigation  Expert → Sensor → Sensor adjustm.

▶ Sensor adjustment	
Measuring interval	→  62
▶ Process variable adjustment	→  62

Measuring interval











Navigation  Expert → Sensor → Sensor adjustm. → Measur. interval

Description Displays the interval between two measuring periods.

User interface 0 to 10 000 ms

"Process variable adjustment" submenu

Navigation  Expert → Sensor → Sensor adjustm. → Variable adjust

▶ Process variable adjustment	
Temperature offset	→  63
Temperature factor	→  63
Conductivity offset	→  63
Conductivity factor	→  63
Corrected conductivity offset	→  64
Corrected conductivity factor	→  64
Electronics temperature offset	→  64
Electronics temperature factor	→  64
Load rate offset	→  65
Load rate factor	→  65

Temperature offset



Navigation	Expert → Sensor → Sensor adjustm. → Variable adjust → Temp. offset
Description	Enter the offset by which to shift the zero point for temperature.
User entry	Signed floating-point number
Factory setting	0

Temperature factor



Navigation	Expert → Sensor → Sensor adjustm. → Variable adjust → Temp. factor
Description	Enter the multiplication factor to apply to the temperature value.
User entry	Positive floating-point number
Factory setting	1

Conductivity offset



Navigation	Expert → Sensor → Sensor adjustm. → Variable adjust → Conduct. offset
Description	Enter the offset by which to shift the zero point for conductivity.
User entry	Signed floating-point number
Factory setting	0



Conductivity factor



Navigation	Expert → Sensor → Sensor adjustm. → Variable adjust → Conduct. factor
Description	Enter the multiplication factor to apply to the conductivity value.
User entry	Positive floating-point number
Factory setting	1



Corrected conductivity offset



Navigation	  Expert → Sensor → Sensor adjustm. → Variable adjust → Corr.cond.offset
Description	Enter the offset by which to shift the zero point for the corrected conductivity.
User entry	Signed floating-point number
Factory setting	0



Corrected conductivity factor



Navigation	  Expert → Sensor → Sensor adjustm. → Variable adjust → Corr.cond.factor
Description	Enter the multiplication factor to apply to the corrected conductivity value.
User entry	Positive floating-point number
Factory setting	1



Electronics temperature offset



Navigation	  Expert → Sensor → Sensor adjustm. → Variable adjust → ElectrTempOffset
Description	Enter the offset by which to shift the zero point for the electronics temperature.
User entry	Signed floating-point number
Factory setting	0

Electronics temperature factor



Navigation	  Expert → Sensor → Sensor adjustm. → Variable adjust → ElectrTempFactor
Description	Enter the multiplication factor to apply to the electronics temperature.
User entry	Positive floating-point number
Factory setting	1

Load rate offset



Navigation	Expert → Sensor → Sensor adjustm. → Variable adjust → Load rate offset
Prerequisite	The volume flow of the medium is read in via the Current input 1 to n (→ 49).
Description	Enter the offset by which to shift the zero point for the load rate.
User entry	Signed floating-point number
Factory setting	0

Load rate factor



Navigation	Expert → Sensor → Sensor adjustm. → Variable adjust → Load rate factor
Prerequisite	The volume flow of the medium is read in via the Current input 1 to n (→ 49).
Description	Enter the multiplication factor to apply to the load rate value.
User entry	Positive floating-point number
Factory setting	1

3.2.6 "Factory adjustment" submenu

Navigation Expert → Sensor → FactoryAdjustm.

▶ **Factory adjustment**

Nominal diameter	→ 65
Date/time	→ 66

Nominal diameter

Navigation	Expert → Sensor → FactoryAdjustm. → Nominal diameter
Description	Shows the nominal diameter of the sensor.
User interface	Character string comprising numbers, letters and special characters

Date/time	
Navigation	Expert → Sensor → FactoryAdjustm. → Date/time
Description	Shows the date and time of the factory adjustment.
User interface	Character string comprising numbers, letters and special characters

3.3 "I/O configuration" submenu

Navigation Expert → I/O config.

► I/O configuration	
I/O module 1 to n terminal numbers	→ 66
I/O module 1 to n information	→ 66
I/O module 1 to n type	→ 67
Apply I/O configuration	→ 67
I/O alteration code	→ 68

I/O module 1 to n terminal numbers



Navigation	Expert → I/O config. → I/O 1 to n terminals
Description	Displays the terminal numbers used by the I/O module.
User interface	<ul style="list-style-type: none"> ■ Not used ■ 26-27 (I/O 1) ■ 24-25 (I/O 2) ■ 22-23 (I/O 3) ■ 20-21 (I/O 4)

I/O module 1 to n information



Navigation	Expert → I/O config. → I/O 1 to n info
Description	Displays information about the plugged in I/O module.

User interface	<ul style="list-style-type: none"> ■ Not plugged ■ Invalid ■ Not configurable ■ Configurable ■ MODBUS
Additional information	<p><i>"Not plugged" option</i> The I/O module is not plugged in.</p> <p><i>"Invalid" option</i> The I/O module is not plugged correctly.</p> <p><i>"Not configurable" option</i> The I/O module is not configurable.</p> <p><i>"Configurable" option</i> The I/O module is configurable.</p> <p><i>"MODBUS" option</i> The I/O module is configured for Modbus.</p>

I/O module 1 to n type

Navigation	  Expert → I/O config. → I/O 1 to n type
Prerequisite	<p>For the following order code:</p> <ul style="list-style-type: none"> ■ "Output; input 2", option D "Configurable I/O initial setting off" ■ "Output; input 3", option D "Configurable I/O initial setting off" ■ "Output; input 4", option D "Configurable I/O initial setting off"
Description	Use this function to select the I/O module type for the configuration of the I/O module.
Selection	<ul style="list-style-type: none"> ■ Off ■ Current output * ■ Current input * ■ Status input * ■ Pulse/frequency/switch output * ■ Relay output *
Factory setting	Off

Apply I/O configuration

Navigation	  Expert → I/O config. → Apply I/O config
Description	Use this function to activate the newly configured I/O module type.

* Visibility depends on order options or device settings

Selection	<ul style="list-style-type: none"> ■ No ■ Yes
Factory setting	No

I/O alteration code

Navigation	Expert → I/O config. → I/O alterat.code
Description	Use this function to enter the ordered activation code to activate the I/O configuration change.
User entry	Positive integer
Factory setting	0
Additional information	<i>Description</i> The I/O configuration is changed in the I/O module type parameter (→ 67).

3.4 "Input" submenu

Navigation Expert → Input

▶ Input	
▶ Current input 1 to n	→ 68
▶ Status input 1 to n	→ 71

3.4.1 "Current input 1 to n" submenu

Navigation Expert → Input → Current input 1 to n

▶ Current input 1 to n	
Terminal number	→ 69
Signal mode	→ 69
Current span	→ 69
0/4 mA value	→ 70
20 mA value	→ 70

Failure mode	→ 71
Failure value	→ 71

Terminal number

Navigation	 Expert → Input → Current input 1 to n → Terminal no.
Description	Displays the terminal numbers used by the current input module.
User interface	<ul style="list-style-type: none"> ■ Not used ■ 24-25 (I/O 2) ■ 22-23 (I/O 3) ■ 20-21 (I/O 4)
Additional information	<p><i>"Not used" option</i></p> <p>The current input module does not use any terminal numbers.</p>



Signal mode

Navigation	 Expert → Input → Current input 1 to n → Signal mode
Description	Use this function to select the signal mode for the current input.
Selection	<ul style="list-style-type: none"> ■ Passive ■ Active *
Factory setting	Passive







Current span

Navigation	 Expert → Input → Current input 1 to n → Current span
Description	Use this function to select the current range for the process value output and the upper and lower level for signal on alarm.
Selection	<ul style="list-style-type: none"> ■ 4...20 mA (4...20.5 mA) ■ 4...20 mA NE (3.8...20.5 mA) ■ 4...20 mA US (3.9...20.8 mA) ■ 0...20 mA (0...20.5 mA)





* Visibility depends on order options or device settings

Factory setting	Country-specific: <ul style="list-style-type: none"> ■ 4...20 mA NE (3.8...20.5 mA) ■ 4...20 mA US (3.9...20.8 mA)
Additional information	<i>Examples</i>  Sample values for the current range: Current span parameter (→  75)

0/4 mA value

Navigation	  Expert → Input → Current input 1 to n → 0/4 mA value
Description	Enter 4 mA value.
User entry	Signed floating-point number
Factory setting	0 % TS
Additional information	<i>Current input behavior</i> The current input behaves differently depending on the settings configured in the following parameters: <ul style="list-style-type: none"> ■ Current span (→  69) ■ Failure mode (→  71) <i>Configuration examples</i>  Pay attention to the configuration examples for 4 mA value parameter (→  77).

20 mA value

Navigation	  Expert → Input → Current input 1 to n → 20 mA value
Description	Enter 20 mA value.
User entry	Signed floating-point number
Factory setting	12 %TS
Additional information	<i>Configuration examples</i>  Pay attention to the configuration examples for 4 mA value parameter (→  77).

Failure mode

Navigation	Expert → Input → Current input 1 to n → Failure mode
Description	Use this function to select the input behavior when measuring a current outside the configured Current span parameter (→ 69).
Selection	<ul style="list-style-type: none"> ▪ Alarm ▪ Last valid value ▪ Defined value
Factory setting	Alarm
Additional information	<p><i>Options</i></p> <ul style="list-style-type: none"> ▪ Alarm An error message is set. ▪ Last valid value The last valid measured value is used. ▪ Defined value A user-defined measured value is used (Failure value parameter (→ 71)).

Failure value



Navigation	Expert → Input → Current input 1 to n → Failure value
Prerequisite	In the Failure mode parameter (→ 71), the Defined value option is selected.
Description	Use this function to enter the value that the device uses if it does not receive an input signal from the external device, or if the input signal is invalid.
User entry	Signed floating-point number
Factory setting	0

3.4.2 "Status input 1 to n" submenu



Navigation Expert → Input → Status input 1 to n

▶ **Status input 1 to n**

Terminal number	→ 72
Assign status input	→ 72
Value status input	→ 73



Active level	→  73
Response time status input	→  73

Terminal number



Navigation	  Expert → Input → Status input 1 to n → Terminal no.
Description	Displays the terminal numbers used by the status input module.
User interface	<ul style="list-style-type: none"> ■ Not used ■ 24-25 (I/O 2) ■ 22-23 (I/O 3) ■ 20-21 (I/O 4)
Additional information	<p><i>"Not used" option</i></p> <p>The status input module does not use any terminal numbers.</p>

Assign status input





Navigation	  Expert → Input → Status input 1 to n → Assign stat.inp.
Description	Use this function to select the function for the status input.
Selection	<ul style="list-style-type: none"> ■ Off ■ Reset totalizer 1 ■ Flow override
Factory setting	Off
Additional information	<p><i>Options</i></p> <ul style="list-style-type: none"> ■ Off The status input is switched off. ■ Reset totalizer 1 The totalizer is reset. ■ Flow override The Flow override is activated. <p> Note on the Flow override:</p> <ul style="list-style-type: none"> ■ The Flow override is enabled as long as the level is at the status input (continuous signal). ■ All other assignments react to a change in level (pulse) at the status input.

Value status input

Navigation	  Expert → Input → Status input 1 to n → Val.stat.inp.
Description	Displays the current input signal level.
User interface	<ul style="list-style-type: none"> ▪ High ▪ Low



Active level



Navigation	  Expert → Input → Status input 1 to n → Active level
Description	Use this function to determine the input signal level at which the assigned function is activated.
Selection	<ul style="list-style-type: none"> ▪ High ▪ Low
Factory setting	High

Response time status input



Navigation	  Expert → Input → Status input 1 to n → Response time
Description	Use this function to enter the minimum time period for which the input signal level must be present before the selected function is activated.
User entry	5 to 200 ms
Factory setting	50 ms

3.5 "Output" submenu

Navigation   Expert → Output

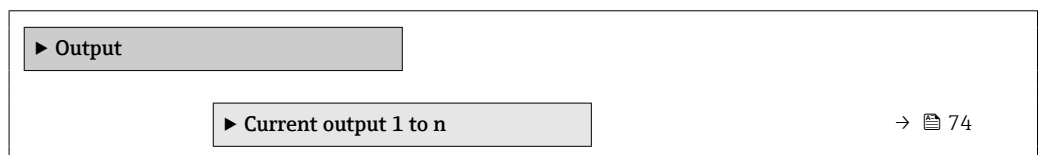

▶ Pulse/frequency/switch output 1 to n	→ 85
▶ Relay output 1 to n	→ 103

3.5.1 "Current output 1 to n" submenu

Navigation Expert → Output → Curr.output 1 to n

▶ Current output 1 to n	
Terminal number	→ 74
Signal mode	→ 75
Process variable current output	→ 75
Current range output	→ 75
Fixed current	→ 76
Lower range value output	→ 77
Upper range value output	→ 78
Measuring mode current output	→ 78
Damping current output	→ 83
Failure behavior current output	→ 83
Failure current	→ 84
Output current	→ 84
Measured current	→ 85

Terminal number

Navigation

Expert → Output → Curr.output 1 to n → Terminal no.

Description



Displays the terminal numbers used by the current output module.

User interface

- Not used
- 24-25 (I/O 2)
- 22-23 (I/O 3)
- 20-21 (I/O 4)

Additional information *"Not used" option*
 The current output module does not use any terminal numbers.

Signal mode

Navigation   Expert → Output → Curr.output 1 to n → Signal mode



Description Use this function to select the signal mode for the current output.

Selection

- Active *
- Passive *

Factory setting Active

Process variable current output

Navigation   Expert → Output → Curr.output 1 to n → Proc.var. outp

Prerequisite The **Load rate** option is only available if the volume flow of the medium is read in via the Current input 1 to n (→  49) or the fieldbus.



Description Use this function to select a process variable for the current output.

Selection

- Off
- Total solids
- Temperature
- Electronics temperature
- Conductivity
- Corrected conductivity
- Load rate *

Factory setting Total solids

Current range output

Navigation   Expert → Output → Curr.output 1 to n → Curr.range out

Description Select current range for process value output and upper/lower level for alarm signal.

Selection

- 4...20 mA NE (3.8...20.5 mA)
- 4...20 mA US (3.9...20.8 mA)
- 4...20 mA (4...20.5 mA)
- 0...20 mA (0...20.5 mA)
- Fixed value

* Visibility depends on order options or device settings

Factory setting

- Depends on country:
- 4...20 mA NE (3.8...20.5 mA)
 - 4...20 mA US (3.9...20.8 mA)

Additional information*Description*

- i** ■ In the event of a device alarm, the current output adopts the value specified in the **Failure mode** parameter (→ 83).
- The measuring range is specified via the **Lower range value output** parameter (→ 77) and **Upper range value output** parameter (→ 78).

"Fixed current" option

The current value is set via the **Fixed current** parameter (→ 76).

Example

Shows the relationship between the current range for the output of the process value and the two signal on alarm levels:

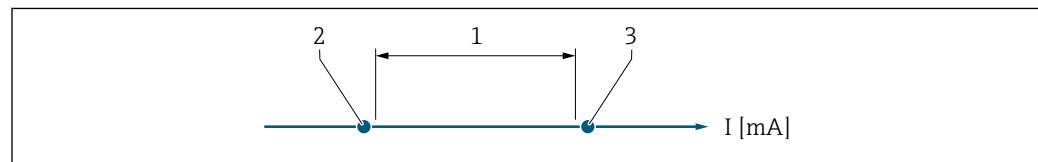

A0034351

- 1 Current range for process value
 2 Lower level for signal on alarm
 3 Upper level for signal on alarm

Selection

Selection	1	2	3
4...20 mA NE (3.8...20.5 mA)	3.8 to 20.5 mA	< 3.6 mA	> 21.95 mA
4...20 mA US (3.9...20.8 mA)	3.9 to 20.8 mA US	< 3.6 mA	> 21.95 mA
4...20 mA (4...20.5 mA)	4 to 20.5 mA	< 3.6 mA	> 21.95 mA
0...20 mA (0...20.5 mA)	0 to 20.5 mA	0 mA	> 21.95 mA

Fixed current**Navigation**

Expert → Output → Curr.output 1 to n → Fixed current

Prerequisite

The **Fixed current** option is selected in the **Current span** parameter (→ 75).

Description

Use this function to enter a constant current value for the current output.

User entry

0 to 22.5 mA

Factory setting

22.5 mA

Lower range value output



Navigation

Expert → Output → Curr.output 1 to n → Low.range outp

Prerequisite

In **Current span** parameter (→ 75), one of the following options is selected:

- 4...20 mA NE (3.8...20.5 mA)
- 4...20 mA US (3.9...20.8 mA)
- 4...20 mA (4...20.5 mA)
- 0...20 mA (0...20.5 mA)

Description

Use this function to enter a value for the start of measuring range.

User entry

Floating point number with sign

Factory setting

0 %TS

Additional information

Description

Positive and negative values are permitted depending on the process variable assigned in the **Assign current output** parameter (→ 75). In addition, the value can be greater than or smaller than the value assigned for the 20 mA current in the **Upper range value output** parameter (→ 78).

Dependency



The unit depends on the process variable selected in the **Assign current output** parameter (→ 75).

Current output behavior

The current output behaves differently depending on the settings configured in the following parameters:

- Current span (→ 75)
- Failure mode (→ 83)

Configuration examples

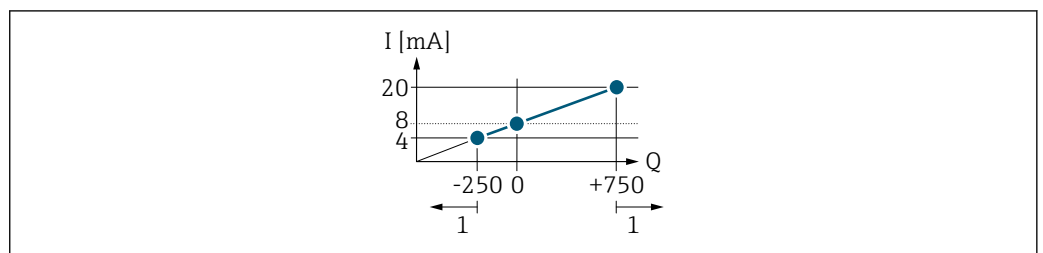

A0013757

Q Flow

I Current

1 Measuring range is exceeded or undershot

Upper range value output

Navigation	Expert → Output → Curr.output 1 to n → Upp.range outp
Prerequisite	In Current span parameter (→ 75), one of the following options is selected: <ul style="list-style-type: none"> ■ 4...20 mA NE (3.8...20.5 mA) ■ 4...20 mA US (3.9...20.8 mA) ■ 4...20 mA (4...20.5 mA) ■ 0...20 mA (0...20.5 mA)
Description	Use this function to enter a value for the end of measuring range.
User entry	Floating point number with sign
Factory setting	12 %TS
Additional information	<p><i>Description</i></p> <p>Positive and negative values are permitted depending on the process variable assigned in the Assign current output parameter (→ 75). In addition, the value can be greater than or smaller than the value assigned for the 0/4 mA current in the Lower range value output parameter (→ 77).</p> <p><i>Dependency</i></p> <p> The unit depends on the process variable selected in the Assign current output parameter (→ 75).</p> <p><i>Example</i></p> <p><i>Configuration examples</i></p> <p> Pay attention to the configuration examples for the Lower range value output parameter (→ 77).</p>



Measuring mode current output

Navigation	Expert → Output → Curr.output 1 to n → Output mode
Prerequisite	The following option is selected in the Process variable current output parameter (→ 75): Load rate One of the following options is selected in the Current span parameter (→ 75): <ul style="list-style-type: none"> ■ 4...20 mA NE (3.8...20.5 mA) ■ 4...20 mA US (3.9...20.8 mA) ■ 4...20 mA (4...20.5 mA) ■ 0...20 mA (0...20.5 mA)
Description	Use this function to select the measuring mode for the current output.



- Selection**
- Forward flow
 - Forward/Reverse flow *
 - Reverse flow compensation

Factory setting Forward flow

Additional information *Description*

 The process variable that is assigned to the current output via the **Assign current output** parameter (→  75) is displayed below the parameter.

"Forward flow" option

The current output signal is proportional to the process variable assigned. The measuring range is defined by the values that are assigned to the **Lower range value output** parameter (→  77) and the **Upper range value output** parameter (→  78).

The flow components outside the scaled measuring range are taken into account for signal output as follows:



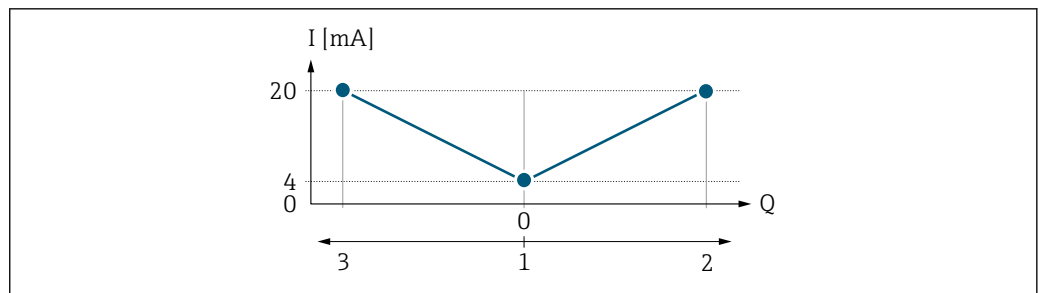

Both values are defined such that they are not equal to zero flow e.g.:

- Start of measuring range = -50 kg/h
- End of measuring range = 100 kg/h

"Forward/Reverse flow" option



- I* Current
Q Flow
 1 Start of measuring range output (0/4 mA)
 2 Forward flow
 3 Reverse flow

- The current output signal is independent of the direction of flow (absolute amount of the measured variable). The values for the **Lower range value output** parameter (→  77) and **Upper range value output** parameter (→  78) must have the same sign.
- The value for the **Upper range value output** parameter (→  78) (e.g. reverse flow) corresponds to the mirrored value for the **Upper range value output** parameter (→  78) (e.g. forward flow).

"Reverse flow compensation" option

The **Reverse flow compensation** option is primarily used to compensate for intermittent reverse flow that can arise with displacement pumps due to wear or high-viscosity medium. The reverse flow is recorded in a buffer memory and offset against the next forward flow.

In the event of prolonged and undesired reverse flow, flow values can accumulate in the buffer memory. Due to the configuration of the current output, these values are not factored in, however, i.e. there is no compensation for the reverse flow.

* Visibility depends on order options or device settings

If this option is set, the measuring device does not smoothen the flow signal. The flow signal is not attenuated.

Examples of how the current output behaves

Example 1

Defined measuring range: lower range value and upper range value with the **same** sign

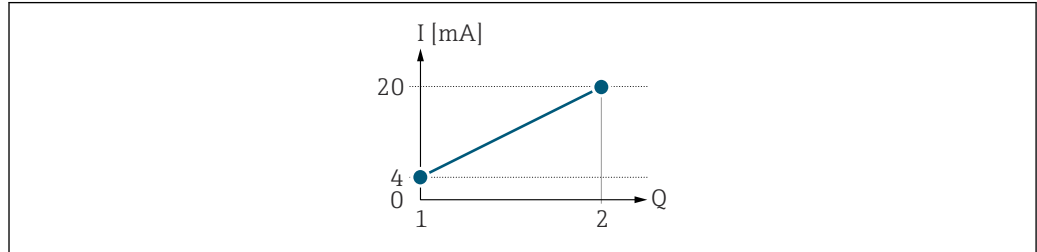

A0028084

2 Measuring range

- I Current
- Q Flow
- 1 Lower range value (Start of measuring range output)
- 2 Upper range value (end of measuring range output)

With the following flow response:

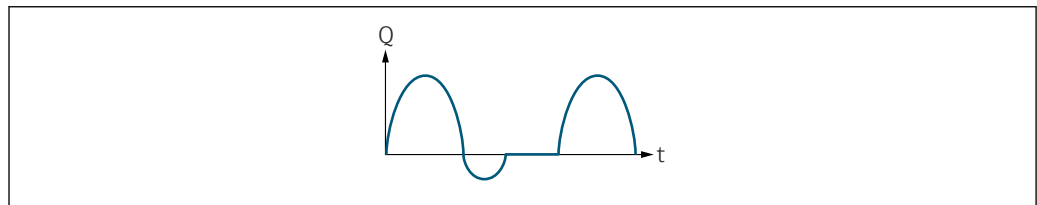

A0028091

3 Flow response

- Q Flow
- t Time

With **Forward flow** option

The current output signal is proportional to the process variable assigned. The flow components outside the scaled measuring range are not taken into account for signal output.

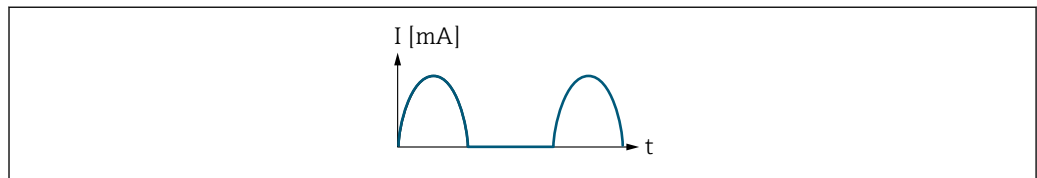

A0028092

- I Current
- t Time

With **Forward/Reverse flow** option

The current output signal is independent of the direction of flow.

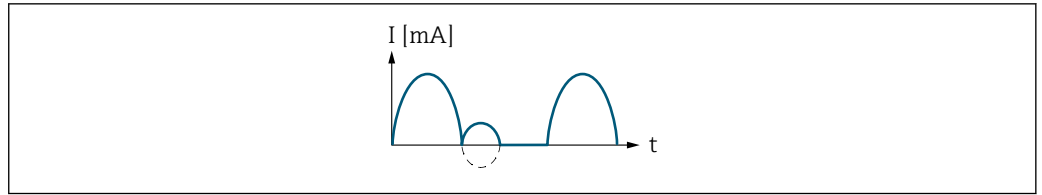

A0028093

I Current
 t Time

With **Reverse flow compensation** option

Flow components outside the measuring span are buffered, balanced and output after a maximum delay of 60 s.

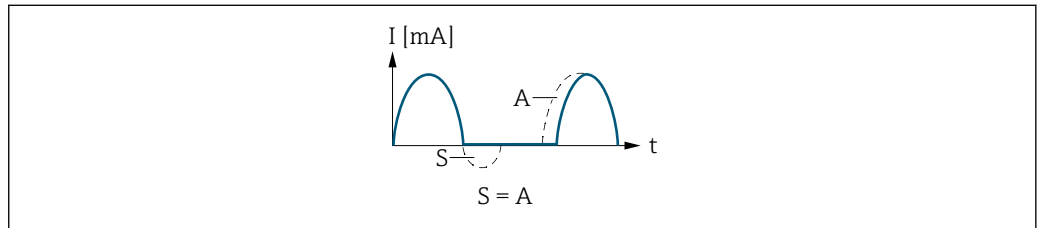

A0028094

I Current
 t Time
 S Flow components saved
 A Balancing of saved flow components

Example 2

Defined measuring range: lower range value and upper range value with **different** signs

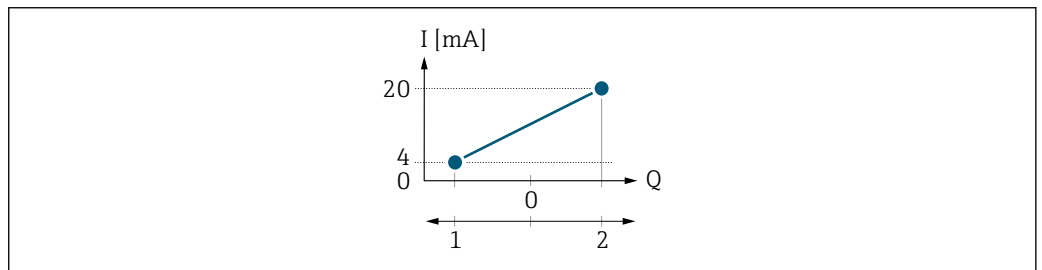

A0028095

4 Measuring range

I Current
 Q Flow
 1 Lower range value (Start of measuring range output)
 2 Upper range value (end of measuring range output)

With flow a (-) outside, b (- -) inside the measuring range

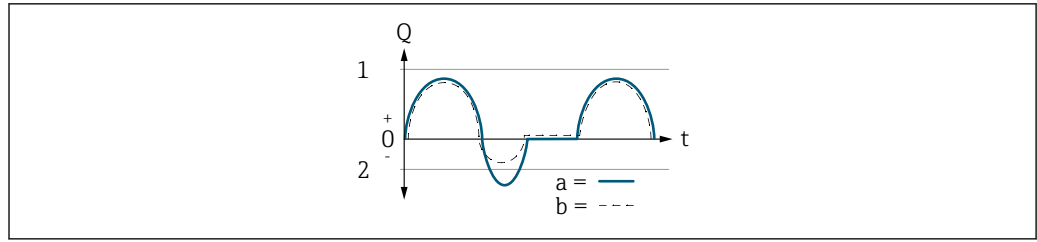

A0028098

- Q Flow
 t Time
 1 Lower range value (Start of measuring range output)
 2 Upper range value (end of measuring range output)

With **Forward flow** option

- a (-): The flow components outside the scaled measuring range cannot be taken into account for signal output.
- b (- -): The current output signal is proportional to the process variable assigned.

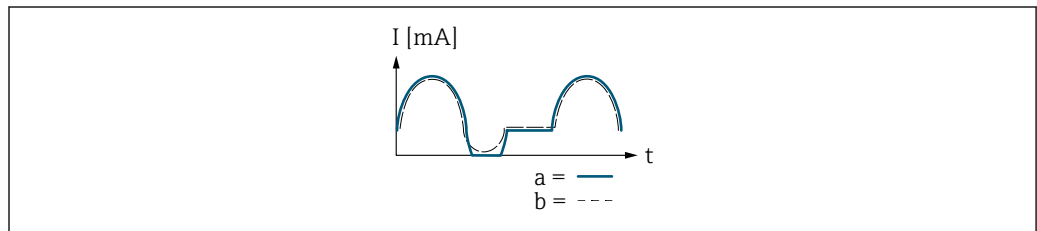

A0028100

- I Current
 t Time

With **Forward/Reverse flow** option

This option cannot be selected here since the values for the **Lower range value output** parameter (\rightarrow 77) and **Upper range value output** parameter (\rightarrow 78) have different signs.

With **Reverse flow compensation** option

Flow components outside the measuring span are buffered, balanced and output after a maximum delay of 60 s.

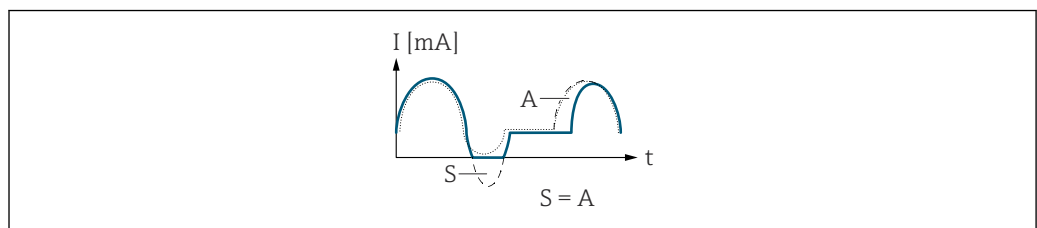

A0028101

- I Current
 t Time
 S Flow components saved
 A Balancing of saved flow components

Damping current output



Navigation	Expert → Output → Curr.output 1 to n → Damp.curr.outp
Prerequisite	A process variable is selected in the Assign current output parameter (→ 75) and one of the following options is selected in the Current span parameter (→ 75): <ul style="list-style-type: none"> ■ 4...20 mA NE (3.8...20.5 mA) ■ 4...20 mA US (3.9...20.8 mA) ■ 4...20 mA (4...20.5 mA) ■ 0...20 mA (0...20.5 mA)
Description	Use this function to enter a time constant for the reaction time of the current output signal to fluctuations in the measured value caused by process conditions.
User entry	0.0 to 999.9 s
Factory setting	1.0 s
Additional information	<i>User entry</i> Use this function to enter a time constant (PT1 element ²⁾) for current output damping: <ul style="list-style-type: none"> ■ If a low time constant is entered, the current output reacts quickly to fluctuating measured variables. ■ If a high time constant is entered, the current output reacts more slowly. Damping is switched off if 0 is entered (factory setting).

Failure behavior current output



Navigation	Expert → Output → Curr.output 1 to n → Failure behav.
Prerequisite	A process variable is selected in the Assign current output parameter (→ 75) and one of the following options is selected in the Current span parameter (→ 75): <ul style="list-style-type: none"> ■ 4...20 mA NE (3.8...20.5 mA) ■ 4...20 mA US (3.9...20.8 mA) ■ 4...20 mA (4...20.5 mA) ■ 0...20 mA (0...20.5 mA)
Description	Use this function to select the value of the current output in the event of a device alarm.
Selection	<ul style="list-style-type: none"> ■ Min. ■ Max. ■ Last valid value ■ Actual value ■ Fixed value
Factory setting	Max.

2) proportional transmission behavior with first order delay

Additional information*Description*

This setting does not affect the failsafe mode of other outputs and totalizers. This is specified in separate parameters.

"Min." option

The current output adopts the value of the lower level for signal on alarm.



The signal on alarm level is defined via the **Current span** parameter (→ 75).

"Max." option

The current output adopts the value of the upper level for signal on alarm.



The signal on alarm level is defined via the **Current span** parameter (→ 75).

"Last valid value" option

The current output adopts the last measured value that was valid before the device alarm occurred.

"Actual value" option

The current output adopts the measured value on the basis of the current flow measurement; the device alarm is ignored.

"Defined value" option

The current output adopts a defined measured value.



The measured value is defined via the **Failure current** parameter (→ 84).

Failure current**Navigation**

Expert → Output → Curr.output 1 to n → Fail. current

Prerequisite

The **Defined value** option is selected in the **Failure mode** parameter (→ 83).

Description

Use this function to enter a fixed value that the current output adopts in the event of a device alarm.

User entry

0 to 22.5 mA

Factory setting

22.5 mA

Output current**Navigation**

Expert → Output → Curr.output 1 to n → Output curr.

Description

Displays the current value currently calculated for the current output.

User interface

3.59 to 22.5 mA

















Measured current

Navigation	🏠🏠 Expert → Output → Curr.output 1 to n → Measur. curr.
Description	Displays the actual measured value of the output current.
User interface	0 to 30 mA

3.5.2 "Pulse/frequency/switch output 1 to n" submenu

Navigation 🏠🏠 Expert → Output → PFS output 1 to n

▶ Pulse/frequency/switch output 1 to n	
Terminal number	→ 📖 86
Signal mode	→ 📖 87
Operating mode	→ 📖 87
Assign pulse output	→ 📖 88
Pulse scaling	→ 📖 89
Pulse width	→ 📖 89
Measuring mode	→ 📖 90
Failure mode	→ 📖 91
Pulse output	→ 📖 91
Assign frequency output	→ 📖 92
Minimum frequency value	→ 📖 92
Maximum frequency value	→ 📖 93
Measuring value at minimum frequency	→ 📖 93
Measuring value at maximum frequency	→ 📖 93
Measuring mode	→ 📖 94

Damping output	→  94
Response time	→  95
Failure mode	→  95
Failure frequency	→  96
Output frequency	→  96
Switch output function	→  96
Assign diagnostic behavior	→  97
Assign limit	→  98
Switch-on value	→  100
Switch-off value	→  100
Assign flow direction check	→  101
Assign status	→  101
Switch-on delay	→  101
Switch-off delay	→  102
Failure mode	→  102
Switch state	→  102
Invert output signal	→  103

Terminal number

Navigation

  Expert → Output → PFS output 1 to n → Terminal no.

Description

Displays the terminal numbers used by the pulse/frequency/switch output module.

User interface

- Not used
- 24-25 (I/O 2)
- 22-23 (I/O 3)
- 20-21 (I/O 4)

Additional information

"Not used" option

The pulse/frequency/switch output module does not use any terminal numbers.

Signal mode

Navigation	Expert → Output → PFS output 1 to n → Signal mode
Description	Use this function to select the signal mode for the pulse/frequency/switch output.
Selection	<ul style="list-style-type: none"> ■ Passive ■ Active * ■ Passive NE
Factory setting	Passive

Operating mode

Navigation	Expert → Output → PFS output 1 to n → Operating mode
Prerequisite	If the Pulse option is selected, the Load rate option must be selected in the Assign pulse output parameter (→ 88).
Description	Use this function to select the operating mode of the output as a pulse, frequency or switch output.
Selection	<ul style="list-style-type: none"> ■ Pulse ■ Frequency ■ Switch
Factory setting	Pulse
Additional information	<p><i>"Pulse" option</i></p> <p>Example</p> <ul style="list-style-type: none"> ■ Flow rate approx. 100 g/s ■ Pulse value 0.1 g ■ Pulse width 0.05 ms ■ Pulse rate 1 000 Impuls/s

* Visibility depends on order options or device settings

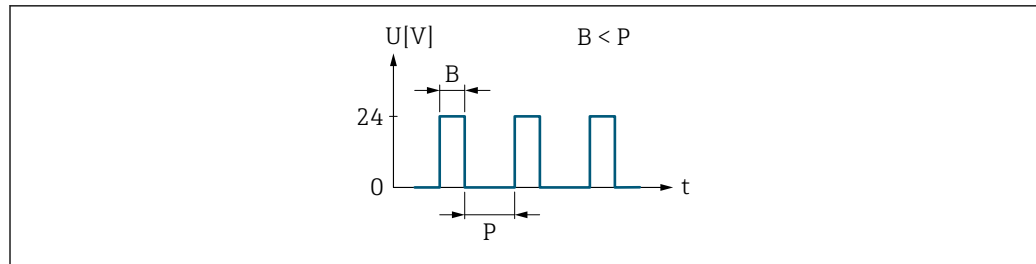

A0026883

5 Quantity-proportional pulse (pulse value) with pulse width to be configured

B Pulse width entered

P Pauses between the individual pulses

"Frequency" option

Example

- Flow rate approx. 100 g/s
- Max. frequency 10 kHz
- Flow rate at max. frequency 1000 g/s
- Output frequency approx. 1000 Hz

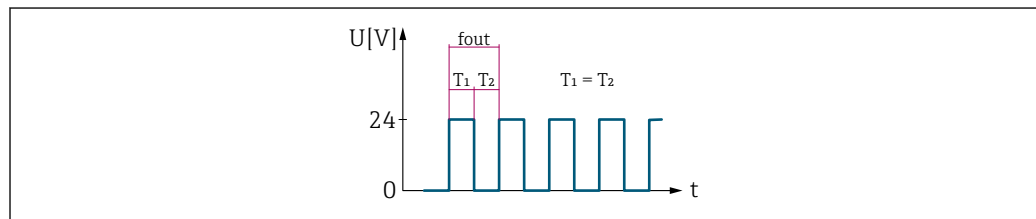

A0026886

6 Flow-proportional frequency output

Assign pulse output



Navigation

Expert → Output → PFS output 1 to n → Assign pulse

Prerequisite

The **Load rate** option is only available if the volume flow of the medium is read in via the Current input 1 to n (→ 49) or the fieldbus.

Prerequisite

The **Pulse** option is selected in **Operating mode** parameter (→ 87).

Description

Use this function to select the process variable for the pulse output.

Selection

- Off
- Load rate *

Factory setting

Off

* Visibility depends on order options or device settings

Pulse scaling

Navigation	Expert → Output → PFS output 1 to n → Pulse scaling
Prerequisite	The Pulse option is selected in the Operating mode parameter (→ 87) and a process variable is selected in the Assign pulse output parameter (→ 88).
Description	Use this function to enter the value for the measured value that a pulse is equivalent to.
User entry	Positive floating point number
Factory setting	Depends on country and nominal diameter
Additional information	<p><i>User entry</i></p> <p>Weighting of the pulse output with a quantity.</p> <p>The lower the pulse value, the</p> <ul style="list-style-type: none"> ▪ better the resolution. ▪ the higher the frequency of the pulse response.

Pulse width

Navigation	Expert → Output → PFS output 1 to n → Pulse width
Prerequisite	The Pulse option is selected in the Operating mode parameter (→ 87) and a process variable is selected in the Assign pulse output parameter (→ 88).
Description	Use this function to enter the duration of the output pulse.
User entry	0.05 to 2 000 ms
Factory setting	100 ms
Additional information	<p><i>Description</i></p> <ul style="list-style-type: none"> ▪ Define how long a pulse is (duration). ▪ The maximum pulse rate is defined by $f_{\max} = 1 / (2 \times \text{pulse width})$. ▪ The interval between two pulses lasts at least as long as the set pulse width. ▪ The maximum flow is defined by $Q_{\max} = f_{\max} \times \text{pulse value}$. ▪ If the flow exceeds these limit values, the measuring device displays the 443 Pulse output 1 to n diagnostic message.

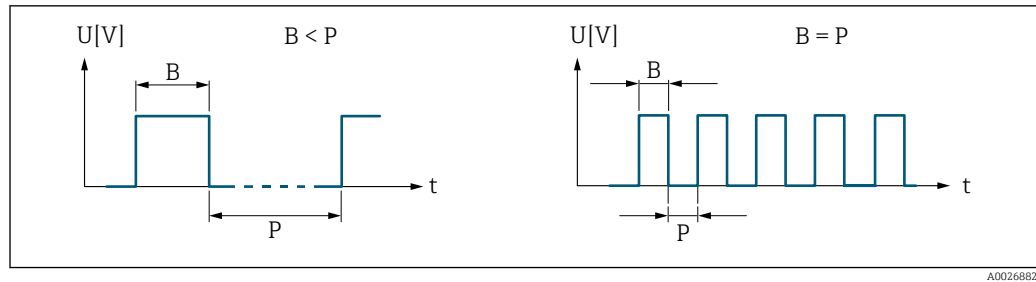

B Pulse width entered
P Pauses between the individual pulses

Example

- Pulse value: 0.1 g
- Pulse width: 0.1 ms
- $f_{\max}: 1 / (2 \times 0.1 \text{ ms}) = 5 \text{ kHz}$
- $Q_{\max}: 5 \text{ kHz} \times 0.1 \text{ g} = 0.5 \text{ kg/s}$

Measuring mode



Navigation

Expert → Output → PFS output 1 to n → Measuring mode

Description

Use this function to select the measuring mode for the pulse output.

Selection

- Forward flow
- Forward/Reverse flow
- Reverse flow
- Reverse flow compensation

Factory setting

Forward flow

Additional information





Options



- Forward flow
Positive flow is output, negative flow is not output.
- Forward/Reverse flow
Positive and negative flow are output (absolute value), but a distinction is not made between positive and negative flow.
- Reverse flow
Negative flow is output, positive flow is not output.
- Reverse flow compensation
The flow components outside the measuring range are buffered, balanced and output after a maximum delay of 60 s.

For a detailed description of the options available, see the **Measuring mode** parameter (→ 78)

Examples

For a detailed description of the configuration examples, see the **Measuring mode** parameter (→ 78)

Failure mode	
Navigation	  Expert → Output → PFS output 1 to n → Failure mode
Prerequisite	The Pulse option is selected in the Operating mode parameter (→  87) and a process variable is selected in the Assign pulse output parameter (→  88).
Description	Use this function to select the failure mode of the pulse output in the event of a device alarm.
Selection	<ul style="list-style-type: none"> ▪ Actual value ▪ No pulses
Factory setting	No pulses
Additional information	<p><i>Description</i></p> <p>The dictates of safety render it advisable to ensure that the pulse output shows a predefined behavior in the event of a device alarm.</p> <p><i>Options</i></p> <ul style="list-style-type: none"> ▪ Actual value In the event of a device alarm, the pulse output continues on the basis of the current flow measurement. The fault is ignored. ▪ No pulses In the event of a device alarm, the pulse output is "switched off". <p>NOTICE! A device alarm indicates a serious fault with the measuring device. The measurement quality may possibly be influenced and may no longer be guaranteed. The Actual value option is only recommended if it is ensured that all possible alarm conditions do not influence the measurement quality.</p>

Pulse output	
Navigation	  Expert → Output → PFS output 1 to n → Pulse output
Prerequisite	The Pulse option is selected in the Operating mode parameter (→  87) parameter.
Description	Displays the pulse frequency currently output.
User interface	Positive floating-point number
Additional information	<p><i>Description</i></p> <ul style="list-style-type: none"> ▪ The pulse output is an open collector output. ▪ This is configured at the factory in such a way that the transistor is conductive for the duration of the pulse (NO contact) and is safety-oriented.

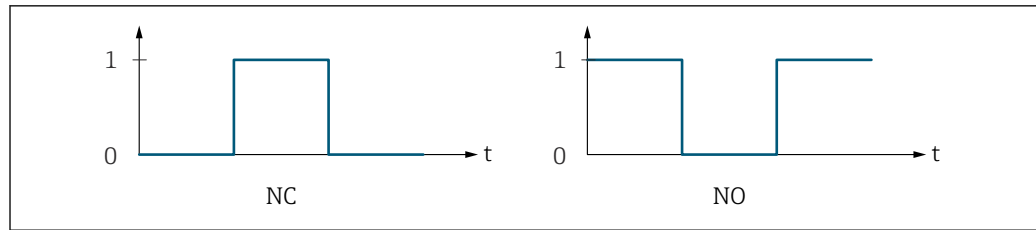

A0028726

0 Non-conductive
 1 Conductive
 NC NC contact (normally closed)
 NO NO contact (normally open)

The output behavior can be reversed via the **Invert output signal** parameter (→ [📄 103](#)) i.e. the transistor does not conduct for the duration of the pulse.

In addition, the behavior of the output in the event of a device alarm (**Failure mode** parameter (→ [📄 91](#))) can be configured.

Assign frequency output 🔒

Navigation

🔍📄 Expert → Output → PFS output 1 to n → Assign freq.

Prerequisite

- The **Frequency** option is selected in **Operating mode** parameter (→ [📄 87](#)).
- The **Load rate** option is only available if the volume flow of the medium is read in via the Current input 1 to n (→ [📄 49](#)) or the fieldbus.

Description

Use this function to select the process variable for the frequency output.

Selection

- Off
- Total solids
- Temperature
- Electronics temperature
- Conductivity
- Corrected conductivity
- Load rate *

Factory setting

Off

Minimum frequency value 🔒

Navigation

🔍📄 Expert → Output → PFS output 1 to n → Min. freq. value

Prerequisite

The **Frequency** option is selected in the **Operating mode** parameter (→ [📄 87](#)) and a process variable is selected in the **Assign frequency output** parameter (→ [📄 92](#)).

Description

Use this function to enter the minimum frequency.



User entry



0.0 to 10 000.0 Hz

* Visibility depends on order options or device settings

Factory setting 0.0 Hz

Maximum frequency value

Navigation   Expert → Output → PFS output 1 to n → Max. freq. value



Prerequisite The **Frequency** option is selected in the **Operating mode** parameter (→  87) and a process variable is selected in the **Assign frequency output** parameter (→  92).



Description Use this function to enter the end value frequency.

User entry 0.0 to 10 000.0 Hz

Factory setting 10 000.0 Hz

Measuring value at minimum frequency

Navigation   Expert → Output → PFS output 1 to n → Val. at min.freq

Prerequisite The **Frequency** option is selected in the **Operating mode** parameter (→  87) and a process variable is selected in the **Assign frequency output** parameter (→  92).

Description Use this function to enter the measured value for the start value frequency.

User entry Signed floating-point number



Factory setting Depends on country and nominal diameter



Additional information *Dependency*



The entry depends on the process variable selected in the **Assign frequency output** parameter (→  92).

Measuring value at maximum frequency



Navigation   Expert → Output → PFS output 1 to n → Val. at max.freq

Prerequisite The **Frequency** option is selected in the **Operating mode** parameter (→  87) and a process variable is selected in the **Assign frequency output** parameter (→  92).







Description Use this function to enter the measured value for the end value frequency.

User entry Signed floating-point number



Factory setting Depends on country and nominal diameter

Additional information	<p><i>Description</i></p> <p>Use this function to enter the maximum measured value at the maximum frequency. The selected process variable is output as a proportional frequency.</p> <p><i>Dependency</i></p> <p> The entry depends on the process variable selected in the Assign frequency output parameter (→  92).</p>
-------------------------------	--

Measuring mode





Navigation	  Expert → Output → PFS output 1 to n → Measuring mode
Description	Use this function to select the measuring mode for the frequency output.
Selection	<ul style="list-style-type: none"> ▪ Forward flow ▪ Forward/Reverse flow ▪ Reverse flow compensation
Factory setting	Forward flow
Additional information	<p><i>Options</i></p> <p> For a detailed description of the options available, see the Measuring mode parameter (→  78)</p> <p><i>Examples</i></p> <p> For a detailed description of the configuration examples, see the Measuring mode parameter (→  78)</p>

Damping output





Navigation	  Expert → Output → PFS output 1 to n → Damping out.
Description	Use this function to enter a time constant for the reaction time of the output signal to fluctuations in the measured value.
User entry	0 to 999.9 s
Factory setting	0.0 s

Additional information	<p><i>User entry</i></p> <p>Use this function to enter a time constant (PT1 element³⁾) for frequency output damping:</p> <ul style="list-style-type: none"> ▪ If a low time constant is entered, the current output reacts particularly quickly to fluctuating measured variables. ▪ On the other hand, the current output reacts more slowly if a high time constant is entered. <p> Damping is switched off if 0 is entered (factory setting).</p> <p>The frequency output is subject to separate damping that is independent of all preceding time constants.</p>
-------------------------------	---

Response time

Navigation	  Expert → Output → PFS output 1 to n → Response time
Prerequisite	The Frequency option is selected in the Operating mode parameter (→  87) and an option is selected in the Assign frequency output parameter (→  92).
Description	Shows how quickly the output reaches 63% of a measured value change.
User interface	Positive floating-point number
Factory setting	0 s





Failure mode

Navigation	  Expert → Output → PFS output 1 to n → Failure mode
Prerequisite	The Frequency option is selected in the Operating mode parameter (→  87) and a process variable is selected in the Assign frequency output parameter (→  92).
Description	Use this function to select the failure mode of the frequency output in the event of a device alarm.
Selection	<ul style="list-style-type: none"> ▪ Actual value ▪ Defined value ▪ 0 Hz
Factory setting	0 Hz



3) proportional transmission behavior with first order delay

Additional information	<p><i>Options</i></p> <ul style="list-style-type: none"> ■ Actual value In the event of a device alarm, the frequency output continues on the basis of the current flow measurement. The device alarm is ignored. ■ Defined value In the event of a device alarm, the frequency output continues on the basis of a predefined value. The Failure frequency (→  96) replaces the current measured value, making it possible to bypass the device alarm. The actual measurement is switched off for the duration of the device alarm. ■ 0 Hz In the event of a device alarm, the frequency output is "switched off". <p>NOTICE! A device alarm indicates a serious fault with the measuring device. The measurement quality may possibly be influenced and may no longer be guaranteed. The Actual value option is only recommended if it is ensured that all possible alarm conditions do not influence the measurement quality.</p>
-------------------------------	--



Failure frequency

Navigation	  Expert → Output → PFS output 1 to n → Failure freq.
Prerequisite	In the Operating mode parameter (→  87), the Frequency option is selected, in the Assign frequency output parameter (→  92) a process variable is selected, and in the Failure mode parameter (→  95), the Defined value option is selected.
Description	Enter frequency output value in alarm condition.
User entry	0.0 to 12 500.0 Hz
Factory setting	0.0 Hz

Output frequency





Navigation	  Expert → Output → PFS output 1 to n → Output freq.
Prerequisite	In the Operating mode parameter (→  87), the Frequency option is selected.
Description	Displays the actual value of the output frequency which is currently measured.
User interface	0.0 to 12 500.0 Hz







Switch output function

Navigation	  Expert → Output → PFS output 1 to n → Switch out funct
Prerequisite	The Switch option is selected in the Operating mode parameter (→  87).

Description	Use this function to select a function for the switch output.
Selection	<ul style="list-style-type: none"> ■ Off ■ On ■ Diagnostic behavior ■ Limit ■ Flow direction check ■ Status
Factory setting	Off
Additional information	<ul style="list-style-type: none"> ■ Off The switch output is permanently switched off (open, non-conductive). ■ On The switch output is permanently switched on (closed, conductive). ■ Diagnostic behavior The switch output is switched on (closed, conductive), if there is a pending diagnostic event of the assigned behavioral category. ■ Limit The switch output is switched on (closed, conductive), if a limit value specified for the process variable is reached. ■ Flow direction check The switch output is switched on (closed, conductive), when the flow direction changes (forward or reverse flow). ■ Status The switch output is switched on (closed/conductive) to display the device status for the selected detection method, e.g. empty pipe detection.

Assign diagnostic behavior

Navigation	  Expert → Output → PFS output 1 to n → Assign diag. beh
Prerequisite	<ul style="list-style-type: none"> ■ In the Operating mode parameter (→  87), the Switch option is selected. ■ In the Switch output function parameter (→  96), the Diagnostic behavior option is selected.
Description	Use this function to select the diagnostic event category that is displayed for the switch output.
Selection	<ul style="list-style-type: none"> ■ Alarm ■ Alarm or warning ■ Warning
Factory setting	Alarm

Additional information	<i>Description</i>
	 If no diagnostic event is pending, the switch output is closed and conductive.
	<i>Selection</i>
	<ul style="list-style-type: none"> ■ Alarm The switch output signals only diagnostic events in the alarm category. ■ Alarm or warning The switch output signals diagnostic events in the alarm and warning category. ■ Warning The switch output signals only diagnostic events in the warning category.
<hr/>	
Assign limit	
Navigation	 Expert → Output → PFS output 1 to n → Assign limit
Prerequisite	<ul style="list-style-type: none"> ■ The Switch option is selected in Operating mode parameter (→  87). ■ The Limit option is selected in Switch output function parameter (→  96). ■ The Load rate option is only available if the volume flow of the medium is read in via the Current input 1 to n (→  49) or the fieldbus.
Description	Use this function to select a process variable for the limit function.
Selection	<ul style="list-style-type: none"> ■ Off ■ Total solids ■ Temperature ■ Electronics temperature ■ Conductivity ■ Corrected conductivity ■ Load rate * ■ Totalizer 1 *
Factory setting	Temperature
Additional information	<i>Description</i>
	Behavior of status output when Switch-on value > Switch-off value: <ul style="list-style-type: none"> ■ Process variable > Switch-on value: transistor is conductive ■ Process variable < Switch-off value: transistor is non-conductive

* Visibility depends on order options or device settings

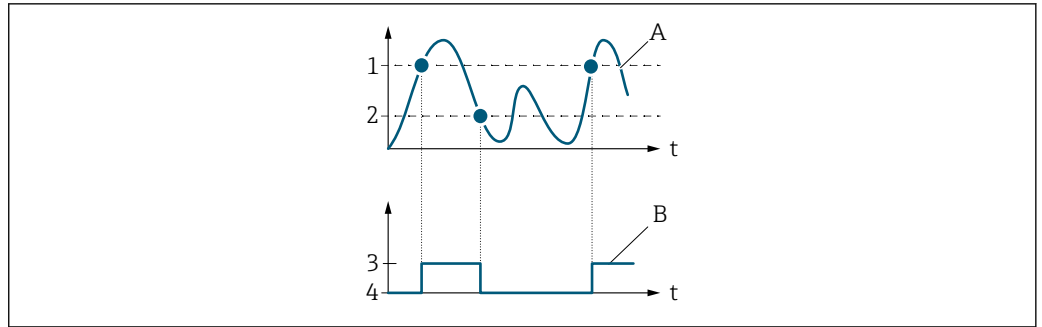

A0026891

- 1 Switch-on value
- 2 Switch-off value
- 3 Conductive
- 4 Non-conductive
- A Process variable
- B Status output

Behavior of status output when Switch-on value < Switch-off value:

- Process variable < Switch-on value: transistor is conductive
- Process variable > Switch-off value: transistor is non-conductive

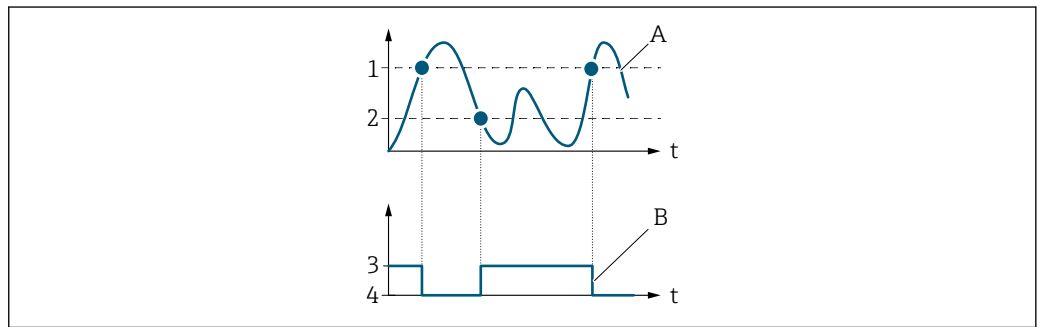

A0026892

- 1 Switch-off value
- 2 Switch-on value
- 3 Conductive
- 4 Non-conductive
- A Process variable
- B Status output

Behavior of status output when Switch-on value = Switch-off value:

- Process variable > Switch-on value: transistor is conductive
- Process variable < Switch-off value: transistor is non-conductive

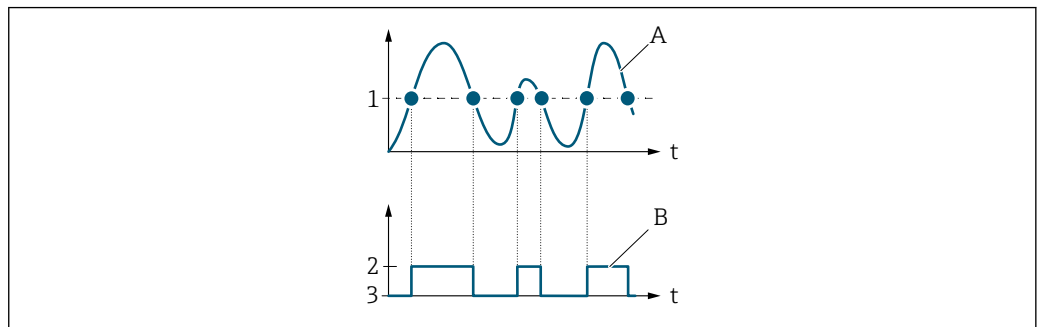

A0026893

- 1 Switch-on value = Switch-off value
- 2 Conductive
- 3 Non-conductive
- A Process variable
- B Status output

Switch-on value
**Navigation**

Expert → Output → PFS output 1 to n → Switch-on value

Prerequisite

- The **Switch** option is selected in the **Operating mode** parameter (→ 87).
- The **Limit** option is selected in the **Switch output function** parameter (→ 96).

Description

Use this function to enter the measured value for the switch-on point.

User entry

Floating point number with sign

Factory setting

0 °C

Additional information*Description*

Use this function to enter the limit value for the switch-on value (process variable > switch-on value = closed, conductive).

When using a hysteresis: Switch-on value > Switch-off value.

Dependency

The unit depends on the process variable selected in the **Assign limit** parameter (→ 98).

Switch-off value
**Navigation**

Expert → Output → PFS output 1 to n → Switch-off value

Prerequisite

- The **Switch** option is selected in the **Operating mode** parameter (→ 87).
- The **Limit** option is selected in the **Switch output function** parameter (→ 96).

Description

Use this function to enter the measured value for the switch-off point.

User entry

Floating point number with sign

Factory setting

0 °C

Additional information*Description*

Use this function to enter the limit value for the switch-off value (process variable < switch-off value = open, non-conductive).

When using a hysteresis: Switch-on value > Switch-off value.

Dependency

The unit depends on the process variable selected in the **Assign limit** parameter (→ 98).

Assign flow direction check

Navigation	Expert → Output → PFS output 1 to n → Assign dir.check
Prerequisite	<ul style="list-style-type: none"> ▪ The Switch option is selected in the Operating mode parameter (→ 87). ▪ The Flow direction check option is selected in the Switch output function parameter (→ 96).
Description	Use this function to select a process variable for monitoring the flow direction.
Selection	
Factory setting	Off





Assign status

Navigation	Expert → Output → PFS output 1 to n → Assign status
Prerequisite	<ul style="list-style-type: none"> ▪ The Switch option is selected in Operating mode parameter (→ 87). ▪ The Status option is selected in Switch output function parameter (→ 96).
Description	Select the device function whose status you want to display.
Selection	<ul style="list-style-type: none"> ▪ Off ▪ Partially filled pipe detection
Factory setting	Partially filled pipe detection
Additional information	<p><i>Options</i></p> <p>When the switch-on point for the selected device function is reached, the output is switched on (closed, conductive). Otherwise, the output is non-conductive.</p>



Switch-on delay

Navigation	Expert → Output → PFS output 1 to n → Switch-on delay
Prerequisite	<ul style="list-style-type: none"> ▪ The Switch option is selected in the Operating mode parameter (→ 87). ▪ The Limit option is selected in the Switch output function parameter (→ 96).
Description	Use this function to enter a delay time for switching on the switch output.
User entry	0.0 to 100.0 s
Factory setting	0.0 s



Switch-off delay 

Navigation	  Expert → Output → PFS output 1 to n → Switch-off delay
Prerequisite	<ul style="list-style-type: none"> ▪ The Switch option is selected in the Operating mode parameter (→  87). ▪ The Limit option is selected in the Switch output function parameter (→  96).
Description	Use this function to enter a delay time for switching off the switch output.
User entry	0.0 to 100.0 s
Factory setting	0.0 s

Failure mode 

Navigation	  Expert → Output → PFS output 1 to n → Failure mode
Description	Use this function to select a failsafe mode for the switch output in the event of a device alarm.
Selection	<ul style="list-style-type: none"> ▪ Actual status ▪ Open ▪ Closed
Factory setting	Open
Additional information	<p><i>Options</i></p> <ul style="list-style-type: none"> ▪ Actual status In the event of a device alarm, faults are ignored and the current behavior of the input value is output by the switch output. The Actual status option behaves in the same way as the current input value. ▪ Open In the event of a device alarm, the switch output's transistor is set to non-conductive. ▪ Closed In the event of a device alarm, the switch output's transistor is set to conductive.

Switch state

Navigation	  Expert → Output → PFS output 1 to n → Switch state
Prerequisite	The Switch option is selected in the Operating mode parameter (→  87).
Description	Displays the current switch status of the status output.
User interface	<ul style="list-style-type: none"> ▪ Open ▪ Closed

Additional information

User interface

- Open
The switch output is not conductive.
- Closed
The switch output is conductive.

Invert output signal



Navigation

Expert → Output → PFS output 1 to n → Invert outp.sig.

Description

Use this function to select whether to invert the output signal.

Selection

- No
- Yes

Factory setting

No

Additional information

Selection

No option (passive - negative)

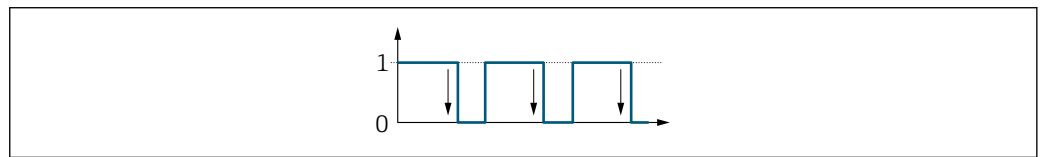

A0026693

Yes option (passive - positive)

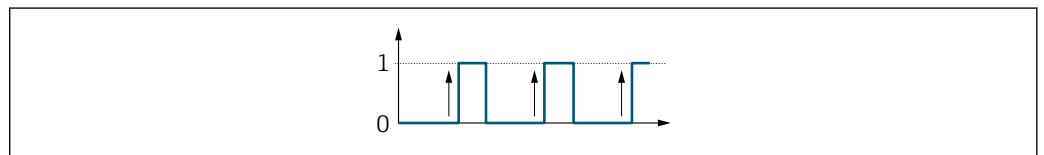

A0026692











3.5.3 "Relay output 1 to n" submenu

Navigation



Expert → Output → Relay output 1 to n

▶ **Relay output 1 to n**



Terminal number	→ 104
Relay output function	→ 104
Assign flow direction check	→ 105

Assign limit	→  105
Assign diagnostic behavior	→  106
Assign status	→  106
Switch-off value	→  107
Switch-off delay	→  107
Switch-on value	→  107
Switch-on delay	→  108
Failure mode	→  108
Switch state	→  109
Powerless relay status	→  109

Terminal number



Navigation	  Expert → Output → Relay output 1 to n → Terminal no.
Description	Displays the terminal numbers used by the relay output module.
User interface	<ul style="list-style-type: none"> ■ Not used ■ 24-25 (I/O 2) ■ 22-23 (I/O 3) ■ 20-21 (I/O 4)
Additional information	<p><i>"Not used" option</i></p> <p>The relay output module does not use any terminal numbers.</p>

Relay output function





Navigation	  Expert → Output → Relay output 1 to n → Relay outp.func.
Description	Use this function to select an output function for the relay output.
Selection	<ul style="list-style-type: none"> ■ Closed ■ Open ■ Diagnostic behavior ■ Limit ■ Flow direction check ■ Status

Factory setting	Closed
Additional information	<p><i>Selection</i></p> <ul style="list-style-type: none"> ■ Closed The relay output is permanently switched on (closed, conductive). ■ Open The relay output is permanently switched off (open, non-conductive). ■ Diagnostic behavior Indicates if the diagnostic event is present or not. Is used to output diagnostic information and to react to it appropriately at the system level. ■ Limit Indicates if a specified limit value has been reached for the process variable. Is used to output diagnostic information relating to the process and to react to it appropriately at the system level. ■ Flow direction check Indicates the flow direction (forward or reverse flow). ■ Digital Output Indicates the device status depending on whether empty pipe detection or low flow cut off is selected.

Assign flow direction check

Navigation	  Expert → Output → Relay output 1 to n → Assign dir.check
Prerequisite	The Flow direction check option is selected in the Relay output function parameter (→  104).
Description	Use this function to select a process variable for monitoring the flow direction.
Selection	
Factory setting	Off



Assign limit

Navigation	  Expert → Output → Relay output 1 to n → Assign limit
Prerequisite	<ul style="list-style-type: none"> ■ The Limit option is selected in Relay output function parameter (→  104). ■ The Load rate option is only available if the volume flow of the medium is read in via the Current input 1 to n (→  49) or the fieldbus.
Description	Use this function to select a process variable for the limit value function.
Selection	<ul style="list-style-type: none"> ■ Off ■ Total solids ■ Temperature ■ Electronics temperature ■ Conductivity

- Corrected conductivity
- Load rate *
- Totalizer 1 *

Factory setting Temperature

Assign diagnostic behavior

Navigation   Expert → Output → Relay output 1 to n → Assign diag. beh

Prerequisite In the **Relay output function** parameter (→  104), the **Diagnostic behavior** option is selected.

Description Use this function to select the category of the diagnostic events that are displayed for the relay output.

Selection ■ Alarm
 ■ Alarm or warning
 ■ Warning



Factory setting Alarm

Additional information *Description*
 If no diagnostic event is pending, the relay output is closed and conductive.

Selection

- Alarm
The relay output signals only diagnostic events in the alarm category.
- Alarm or warning
The relay output signals diagnostic events in the alarm and warning category.
- Warning
The relay output signals only diagnostic events in the warning category.

Assign status

Navigation   Expert → Output → Relay output 1 to n → Assign status

Prerequisite In the **Relay output function** parameter (→  104), the **Digital Output** option is selected.

Description Use this function to select the device status for the relay output.

Selection ■ Off
 ■ Partially filled pipe detection

Factory setting Off

* Visibility depends on order options or device settings

Switch-off value











Navigation	Expert → Output → Relay output 1 to n → Switch-off value
Prerequisite	The Limit option is selected in the Relay output function parameter (→ 104).
Description	Use this function to enter the measured value for the switch-off point.
User entry	Floating point number with sign
Factory setting	0 °C
Additional information	<p><i>Description</i></p> <p>Use this function to enter the limit value for the switch-off value (process variable < switch-off value = open, non-conductive).</p> <p> When using a hysteresis: Switch-on value > Switch-off value.</p> <p><i>Dependency</i></p> <p> The unit is dependent on the process variable selected in the Assign limit parameter (→ 105).</p>

Switch-off delay



Navigation	Expert → Output → Relay output 1 to n → Switch-off delay
Prerequisite	In the Relay output function parameter (→ 104), the Limit option is selected.
Description	Use this function to enter a delay time for switching off the switch output.
User entry	0.0 to 100.0 s
Factory setting	0.0 s

Switch-on value

Navigation	Expert → Output → Relay output 1 to n → Switch-on value
Prerequisite	The Limit option is selected in the Relay output function parameter (→ 104).
Description	Use this function to enter the measured value for the switch-on point.
User entry	Floating point number with sign
Factory setting	0 °C

Additional information	<p><i>Description</i></p> <p>Use this function to enter the limit value for the switch-on value (process variable > switch-on value = closed, conductive).</p> <p> When using a hysteresis: Switch-on value > Switch-off value.</p> <p><i>Dependency</i></p> <p> The unit is dependent on the process variable selected in the Assign limit parameter (→  105).</p>
<hr/>	
Switch-on delay	
<hr/>	
Navigation	  Expert → Output → Relay output 1 to n → Switch-on delay
Prerequisite	In the Relay output function parameter (→  104), the Limit option is selected.
Description	Use this function to enter a delay time for switching on the switch output.
User entry	0.0 to 100.0 s
Factory setting	0.0 s
<hr/>	
Failure mode	
<hr/>	
Navigation	  Expert → Output → Relay output 1 to n → Failure mode
Description	Use this function to select the failure mode of the relay output in the event of a device alarm.
Selection	<ul style="list-style-type: none"> ■ Actual status ■ Open ■ Closed
Factory setting	Open
Additional information	<p><i>Selection</i></p> <ul style="list-style-type: none"> ■ Actual status In the event of a device alarm, faults are ignored and the current behavior of the input value is output by the relay output. The Actual status option behaves in the same way as the current input value. ■ Open In the event of a device alarm, the relay output's transistor is set to non-conductive. ■ Closed In the event of a device alarm, the relay output's transistor is set to conductive.

Switch state

Navigation	 Expert → Output → Relay output 1 to n → Switch state
Description	Displays the current status of the relay output.
User interface	<ul style="list-style-type: none"> ■ Open ■ Closed
Additional information	<i>User interface</i> <ul style="list-style-type: none"> ■ Open The relay output is not conductive. ■ Closed The relay output is conductive.





Powerless relay status



Navigation	 Expert → Output → Relay output 1 to n → Powerless relay
Description	Use this function to select the quiescent state for the relay output.
Selection	<ul style="list-style-type: none"> ■ Open ■ Closed
Factory setting	Open
Additional information	<i>Selection</i> <ul style="list-style-type: none"> ■ Open The relay output is not conductive. ■ Closed The relay output is conductive.









3.6 "Communication" submenu

Navigation  Expert → Communication

▶ Communication	
▶ Modbus configuration	→  110
▶ Modbus information	→  115
▶ Modbus data map	→  116
▶ Web server	→  116

3.6.1 "Modbus configuration" submenu

Navigation  Expert → Communication → Modbus config.

► Modbus configuration	
Bus address	→  110
Baudrate	→  110
Data transfer mode	→  111
Parity	→  111
Byte order	→  112
Telegram delay	→  113
Failure mode	→  113
Bus termination	→  114
Fieldbus writing access	→  114

Bus address

Navigation	 Expert → Communication → Modbus config. → Bus address
Description	For entering the device address.
User entry	1 to 247
Factory setting	247

Baudrate

Navigation	 Expert → Communication → Modbus config. → Baudrate
Description	Use this function to select a transmission rate.
Selection	<ul style="list-style-type: none"> ■ 1200 BAUD ■ 2400 BAUD ■ 4800 BAUD ■ 9600 BAUD ■ 19200 BAUD ■ 38400 BAUD

- 57600 BAUD
- 115200 BAUD
- 230400 BAUD

Factory setting 19200 BAUD

Data transfer mode

Navigation   Expert → Communication → Modbus config. → Data trans. mode

Description Use this function to select the data transmission mode.

Selection



- ASCII
- RTU

Factory setting RTU

Additional information *Options*

- ASCII
Transmission of data in the form of readable ASCII characters. Error protection via LRC.
- RTU
Transmission of data in binary form. Error protection via CRC16.

Parity

Navigation   Expert → Communication → Modbus config. → Parity

Description Use this function to select the parity bit.

Selection

- Odd
- Even
- None / 1 stop bit
- None / 2 stop bits

Factory setting Even

Additional information *Options*

Picklist **ASCII** option:

- 0 = **Even** option
- 1 = **Odd** option

Picklist **RTU** option:

- 0 = **Even** option
- 1 = **Odd** option
- 2 = **None / 1 stop bit** option
- 3 = **None / 2 stop bits** option

Byte order



Navigation

Expert → Communication → Modbus config. → Byte order

Description

Use this function to select the sequence in which the bytes are transmitted. The transmission sequence must be coordinated with the Modbus master.

Selection

- 0-1-2-3
- 3-2-1-0
- 1-0-3-2
- 2-3-0-1

Factory setting

1-0-3-2

Additional information

Description

The byte sequence is not standardized by the Modbus protocol. However, if the host system and the measuring device do not use the same byte sequence, correct data exchange is not possible.

Changing the byte sequence in the host system often requires an extensive knowledge and significant programming efforts. Endress+Hauser introduced the **Byte order** parameter (→ 112) for this reason.

This makes it possible to use the standard settings of the host system and change the byte sequence on the measuring device by trial and error. If correct data exchange cannot be achieved by changing the byte sequence, the settings for the byte sequence of the host system must be adapted accordingly.

Byte transmission sequence

Byte addressing, i.e. the transmission sequence of the bytes, is not specified in the Modbus specification. For this reason, it is important to coordinate or match the addressing method between the master and slave during commissioning. This can be configured in the measuring device using the **Byte order** parameter (→ 112).

The bytes are transmitted depending on the selection in the **Byte order** parameter (→ 112):

FLOAT				
	Sequence			
Options	1.	2.	3.	4.
1 - 0 - 3 - 2 *	Byte 1 (MMMMMMMM)	Byte 0 (MMMMMMMM)	Byte 3 (SEEEEEEE)	Byte 2 (EMMMMMMM)
0 - 1 - 2 - 3	Byte 0 (MMMMMMMM)	Byte 1 (MMMMMMMM)	Byte 2 (EMMMMMMM)	Byte 3 (SEEEEEEE)
2 - 3 - 0 - 1	Byte 2 (EMMMMMMM)	Byte 3 (SEEEEEEE)	Byte 0 (MMMMMMMM)	Byte 1 (MMMMMMMM)
3 - 2 - 1 - 0	Byte 3 (SEEEEEEE)	Byte 2 (EMMMMMMM)	Byte 1 (MMMMMMMM)	Byte 0 (MMMMMMMM)
* = factory setting, S = sign, E = exponent, M = mantissa				

INTEGER		
	Sequence	
Options	1.	2.

1 - 0 - 3 - 2 * 3 - 2 - 1 - 0	Byte 1 (MSB)	Byte 0 (LSB)
0 - 1 - 2 - 3 2 - 3 - 0 - 1	Byte 0 (LSB)	Byte 1 (MSB)
* = factory setting, MSB = most significant byte, LSB = least significant byte		

STRING					
Presentation taking the example of a device parameter with a data length of 18 bytes.					
	Sequence				
Options	1.	2.	...	17.	18.
1 - 0 - 3 - 2 * 3 - 2 - 1 - 0	Byte 17 (MSB)	Byte 16	...	Byte 1	Byte 0 (LSB)
0 - 1 - 2 - 3 2 - 3 - 0 - 1	Byte 16	Byte 17 (MSB)	...	Byte 0 (LSB)	Byte 1
* = factory setting, MSB = most significant byte, LSB = least significant byte					

Telegram delay



Navigation

Expert → Communication → Modbus config. → Telegram delay

Description

Use this function to enter a delay time after which the measuring device replies to the request telegram of the Modbus master. This allows communication to be adapted to slow Modbus RS485 masters.

User entry

0 to 100 ms

Factory setting

6 ms

Failure mode



Navigation

Expert → Communication → Modbus config. → Failure mode

Description

Use this function to select the measured value output in the event of a diagnostic message via Modbus communication.

Selection



- NaN value
- Last valid value

Factory setting

NaN value

Additional information	<p><i>Options</i></p> <ul style="list-style-type: none"> ▪ NaN value The device outputs the NaN value ⁴⁾. ▪ Last valid value The device outputs the last valid measured value before the fault occurred. <p> This effect of this parameter depends on the option selected in the Assign diagnostic behavior parameter.</p>
-------------------------------	---

Bus termination

Navigation	 Expert → Communication → Modbus config. → Bus termination
Description	Displays whether the terminating resistor is enabled or disabled.
User interface	<ul style="list-style-type: none"> ▪ Off ▪ On
Factory setting	Off
Additional information	<p><i>Selection</i></p> <ul style="list-style-type: none"> ▪ Off The terminating resistor is disabled. ▪ On The terminating resistor is enabled. <p> For detailed information about enabling the terminating resistor, see the Operating Instructions for the device, "Enabling the terminating resistor" section</p>

Fieldbus writing access

Navigation	 Expert → Communication → Modbus config. → Fieldb.writ.acc.
Description	Use this function to restrict access to the measuring device via fieldbus (Modbus protocol).
Selection	<ul style="list-style-type: none"> ▪ Read + write ▪ Read only
Factory setting	Read + write

⁴⁾ Not a Number

Additional information*Description*

If read and/or write protection is enabled, the parameter can only be controlled and reset via local operation. Access is no longer possible via operating tools.



This does not affect cyclic measured value transmission to the higher-order system, which is always guaranteed.

Selection

- Read + write
The parameters are read and write parameters.
- Read only
- The parameters are read only parameters.

3.6.2 "Modbus information" submenu*Navigation*

Expert → Communication → Modbus info

▶ Modbus information	
Device ID	→ ⓘ 115
Device revision	→ ⓘ 115

Device ID**Navigation**

Expert → Communication → Modbus info → Device ID

Description

Displays the device ID for identifying the measuring device.

User interface

4-digit hexadecimal number

Device revision**Navigation**

Expert → Communication → Modbus info → Device revision

Description

Displays the device revision.

User interface

4-digit hexadecimal number

3.6.3 "Modbus data map" submenu

Navigation  Expert → Communication → Modbus data map

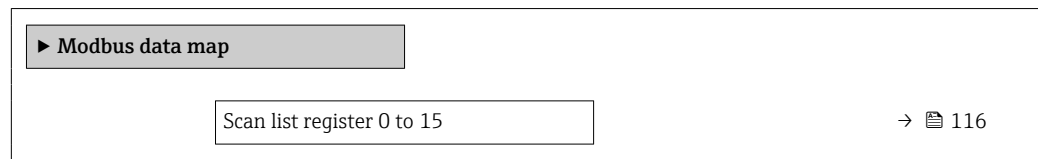

Scan list register 0 to 15

Navigation

 Expert → Communication → Modbus data map → Scan list reg.0 to 15

Description

Use this function to enter the scan list register. By entering the register address (1-based), up to 16 device parameters can be grouped by assigning them to the scan list registers 0 to 15. The data of the device parameters assigned here are read out via the register addresses 5051 to 5081.

User entry

1 to 65 535

Factory setting

1

3.6.4 "Web server" submenu

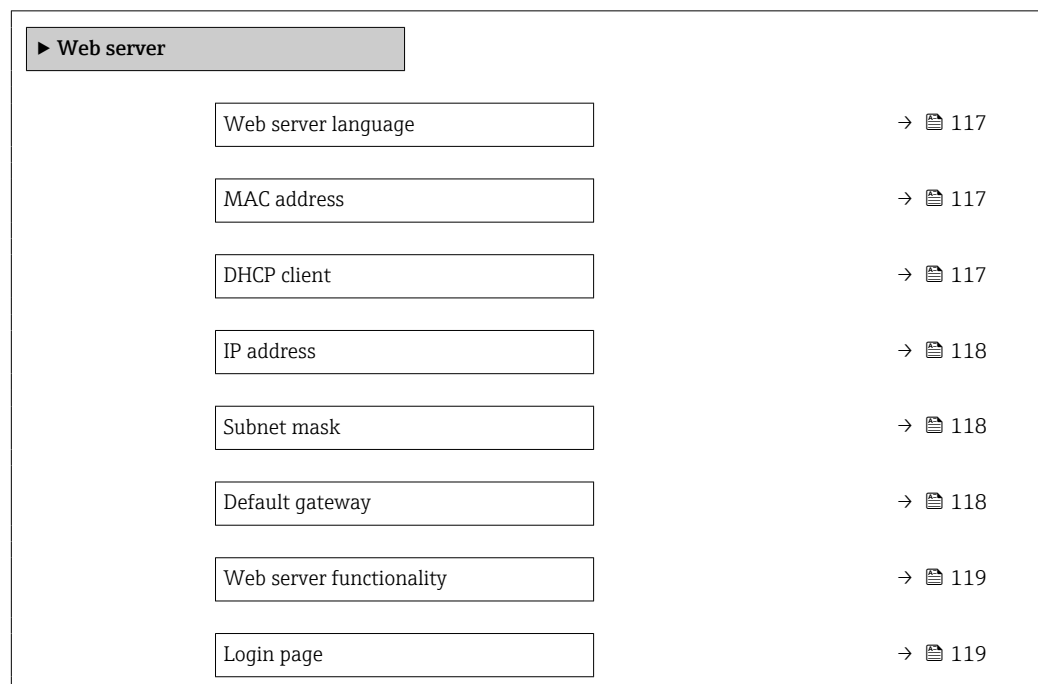

Navigation  Expert → Communication → Web server



Web server language



Navigation	  Expert → Communication → Web server → Webserv.language
Description	Use this function to select the language configured for the Web server.
Selection	<ul style="list-style-type: none"> ■ English ■ Deutsch ■ Français ■ Español ■ Italiano ■ Nederlands ■ Portuguesa ■ Polski ■ русский язык (Russian) ■ Svenska ■ Türkçe ■ 中文 (Chinese) ■ 日本語 (Japanese) ■ 한국어 (Korean) ■ čeština (Czech)
Factory setting	English

MAC address

Navigation	  Expert → Communication → Web server → MAC Address
Description	Displays the MAC ⁵⁾ address of the measuring device.
User interface	Unique 12-digit character string comprising letters and numbers
Factory setting	Each measuring device is given an individual address.
Additional information	<p><i>Example</i></p> <p>For the display format 00:07:05:10:01:5F</p>

DHCP client





Navigation	  Expert → Communication → Web server → DHCP client
Description	Use this function to activate and deactivate the DHCP client functionality.
Selection	<ul style="list-style-type: none"> ■ Off ■ On





5) Media Access Control

Factory setting On



Additional information *Effect*

If the DHCP client functionality of the web server is selected, the IP address (→  118), Subnet mask (→  118) and Default gateway (→  118) are set automatically.



- Identification is via the MAC address of the measuring device.
- The IP address (→  118) in the **IP address** parameter (→  118) is ignored as long as the **DHCP client** parameter (→  117) is active. This is also the case, in particular, if the DHCP server cannot be reached. The IP address (→  118) in the parameter of the same name is only used if the **DHCP client** parameter (→  117) is inactive.

IP address



Navigation   Expert → Communication → Web server → IP address

Description Display or enter the IP address of the Web server integrated in the measuring device.

User entry 4 octet: 0 to 255 (in the particular octet)

Factory setting 192.168.1.212

Subnet mask

Navigation   Expert → Communication → Web server → Subnet mask

Description Display or enter the subnet mask.

User entry 4 octet: 0 to 255 (in the particular octet)

Factory setting 255.255.255.0

Default gateway

Navigation   Expert → Communication → Web server → Default gateway

Description Display or enter the Default gateway (→  118).

User entry 4 octet: 0 to 255 (in the particular octet)

Factory setting 0.0.0.0

Web server functionality



Navigation Expert → Communication → Web server → Webserver funct.

Description Use this function to switch the Web server on and off.

- Selection**
- Off
 - HTML Off
 - On

Factory setting On

Additional information *Description*

Once disabled, the Web server functionality can only be enabled again via the local display, the FieldCare operating tool or the DeviceCare operating tool.

Selection

Option	Description
Off	<ul style="list-style-type: none"> ■ The Web server is completely disabled. ■ Port 80 is locked.
HTML Off	The HTML version of the Web server is not available.
On	<ul style="list-style-type: none"> ■ The complete Web server functionality is available. ■ JavaScript is used. ■ The password is transferred in an encrypted state. ■ Any change to the password is also transferred in an encrypted state.

Login page



Navigation Expert → Communication → Web server → Login page

Description Use this function to select the format of the login page.









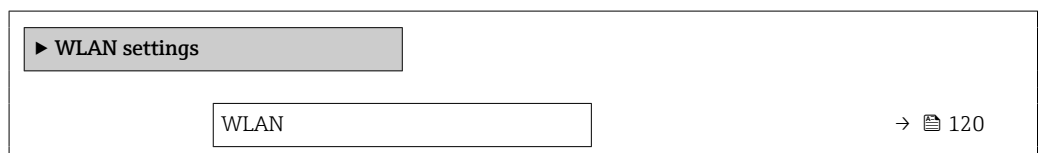











- Selection**
- Without header
 - With header

Factory setting With header

3.6.5 "WLAN settings" wizard

Navigation Expert → Communication → WLAN settings



WLAN mode	→  121
SSID name	→  121
Network security	→  121
Security identification	→  122
User name	→  122
WLAN password	→  122
WLAN IP address	→  123
WLAN MAC address	→  123
WLAN subnet mask	→  123
WLAN MAC address	→  123
WLAN passphrase	→  123
WLAN MAC address	→  123
Assign SSID name	→  124
SSID name	→  124
2.4 GHz WLAN channel	→  124
Select antenna	→  125
Connection state	→  125
Received signal strength	→  125
WLAN IP address	→  123
Gateway IP address	→  126
IP address domain name server	→  126

WLAN
**Navigation**
  Expert → Communication → WLAN settings → WLAN
Description

Use this function to enable and disable the WLAN connection.

Selection

- Disable
- Enable

Factory setting Enable

WLAN mode

Navigation   Expert → Communication → WLAN settings → WLAN mode



Description Use this function to select the WLAN mode.

Selection

- WLAN access point
- WLAN Client

Factory setting WLAN access point

SSID name

Navigation   Expert → Communication → WLAN settings → SSID name

Prerequisite The client is activated.

Description Use this function to enter the user-defined SSID name (max. 32 characters) of the WLAN network.

User entry –

Factory setting –

Network security

Navigation   Expert → Communication → WLAN settings → Network security

Description Use this function to select the type of security for the WLAN interface.

Selection



- Unsecured
- WPA2-PSK
- EAP-PEAP with MSCHAPv2 *
- EAP-PEAP MSCHAPv2 no server authentic. *
- EAP-TLS *

Factory setting WPA2-PSK

* Visibility depends on order options or device settings



Additional information	<p><i>Selection</i></p> <ul style="list-style-type: none"> ■ Unsecured Access the WLAN connection without identification. ■ WPA2-PSK Access the WLAN connection with a network key. ■ EAP-PEAP with MSCHAPv2 Access the WLAN connection with a password-based authentication protocol. ■ EAP-PEAP MSCHAPv2 no server authentic. Access the WLAN connection with a password-based protocol without server authentication. ■ EAP-TLS Access the WLAN connection with a certificate-based, two-way authentication of the client and network.
-------------------------------	--

Security identification

Navigation	  Expert → Communication → WLAN settings → Sec. identific.
Description	Use this function to select the security settings (download via the menu: Data Management > Security > Download WLAN).
User interface	<ul style="list-style-type: none"> ■ Trusted issuer certificate ■ Device certificate ■ Device private key



User name



Navigation	  Expert → Communication → WLAN settings → User name
Description	Use this function to enter the username of the WLAN network.
User entry	–
Factory setting	–

WLAN password



Navigation	  Expert → Communication → WLAN settings → WLAN password
Description	Use this function to enter the WLAN password for the WLAN network.
User entry	–
Factory setting	–

WLAN IP address



Navigation	Expert → Communication → WLAN settings → WLAN IP address
Description	Use this function to enter the IP address of the measuring device's WLAN connection.
User entry	4 octet: 0 to 255 (in the particular octet)
Factory setting	192.168.1.212

WLAN MAC address

Navigation	Expert → Communication → WLAN settings → WLAN MAC address
Description	Displays the MAC ⁶⁾ address of the measuring device.
User interface	Unique 12-digit character string comprising letters and numbers
Factory setting	Each measuring device is given an individual address.
Additional information	<i>Example</i> For the display format 00:07:05:10:01:5F

WLAN subnet mask



Navigation	Expert → Communication → WLAN settings → WLAN subnet mask
Description	Use this function to enter the subnet mask.
User entry	4 octet: 0 to 255 (in the particular octet)
Factory setting	255.255.255.0

WLAN passphrase





Navigation	Expert → Communication → WLAN settings → WLAN passphrase
Prerequisite	The WPA2-PSK option is selected in the Security type parameter (→ 121).
Description	Use this function to enter the network key.





6) Media Access Control

User entry	8 to 32-digit character string comprising numbers, letters and special characters (without spaces)
Factory setting	Serial number of the measuring device (e.g. L100A802000)



Assign SSID name

Navigation	  Expert → Communication → WLAN settings → Assign SSID name
Description	Use this function to select which name is used for the SSID ⁷⁾ .
Selection	<ul style="list-style-type: none"> ▪ Device tag ▪ User-defined
Factory setting	User-defined
Additional information	<p><i>Selection</i></p> <ul style="list-style-type: none"> ▪ Device tag The device tag name is used as the SSID. ▪ User-defined A user-defined name is used as the SSID.

SSID name

Navigation	  Expert → Communication → WLAN settings → SSID name
Prerequisite	<ul style="list-style-type: none"> ▪ The User-defined option is selected in the Assign SSID name parameter (→  124). ▪ The WLAN access point option is selected in the WLAN mode parameter (→  121).
Description	Use this function to enter a user-defined SSID name.
User entry	Max. 32-digit character string comprising numbers, letters and special characters
Factory setting	



2.4 GHz WLAN channel

Navigation	  Expert → Communication → WLAN settings → WLAN channel
Description	Use this function to enter the 2.4 GHz WLAN channel.
User entry	1 to 11
Factory setting	6

7) Service Set Identifier

Additional information	<i>Description</i>
	 <ul style="list-style-type: none"> ▪ It is only necessary to enter a 2.4 GHz WLAN channel if multiple WLAN devices are in use. ▪ If just one measuring device is in use, it is recommended to keep the factory setting.



Select antenna

Navigation	  Expert → Communication → WLAN settings → Select antenna
Description	Use this function to select whether the external or internal antenna is used for reception.
Selection	<ul style="list-style-type: none"> ▪ External antenna ▪ Internal antenna
Factory setting	Internal antenna



Connection state

Navigation	 Expert → Communication → WLAN settings → Connection state
Description	The connection status is displayed.
User interface	<ul style="list-style-type: none"> ▪ Connected ▪ Not connected
Factory setting	Not connected



Received signal strength

Navigation	  Expert → Communication → WLAN settings → Rec.sig.strength
Description	Displays the signal strength received.
User interface	<ul style="list-style-type: none"> ▪ Low ▪ Medium ▪ High
Factory setting	High

Gateway IP address

Navigation	  Expert → Communication → WLAN settings → Gateway IP addr.
Description	Use this function to enter the IP address of the gateway.
User interface	Character string comprising numbers, letters and special characters
Factory setting	192.168.1.212

IP address domain name server



Navigation	  Expert → Communication → WLAN settings → IP address DNS
Description	Use this function to enter the IP address of the domain name server.
User interface	Character string comprising numbers, letters and special characters
Factory setting	192.168.1.212

3.7 "Application" submenu

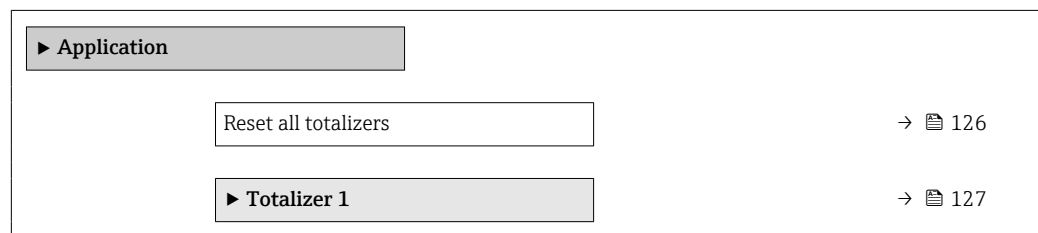
Navigation   Expert → Application



Reset all totalizers



Navigation	  Expert → Application → Reset all tot.
Description	Use this function to reset all totalizers to the value 0 and restart the totaling process. This deletes all the previously aggregated flow values.
Selection	<ul style="list-style-type: none"> ■ Cancel ■ Reset + totalize
Factory setting	Cancel

Additional information







Selection

Options	Description
Cancel	No action is executed and the user exits the parameter.
Reset + totalize	Resets the totalizer to 0 and restarts the totaling process. The previously aggregated load quantity is thus deleted.

3.7.1 "Totalizer 1 to n" submenu



Navigation   Expert → Application → Totalizer 1 to n

▶ Totalizer 1

- Assign process variable 1 →  127
- Process variable unit 1 →  128
- Totalizer 1 operation mode →  128
- Totalizer 1 control →  129
- Preset value 1 →  130
- Totalizer 1 failure behavior →  130

Assign process variable 1

Navigation

  Expert → Application → Totalizer 1 → AssignVariab. 1

Prerequisite

The **Load rate** option is only available if the volume flow of the medium is read in via the Current input 1 to n (→  49) or the fieldbus.

Description

Use this function to select a process variable for the Totalizer 1 to n.

Selection

- Off
- Load rate *

Factory setting

Off

* Visibility depends on order options or device settings

Additional information*Description*

If the option selected is changed, the device resets the totalizer to 0.

Options

If the **Off** option is selected, only the **Assign process variable** parameter (→ 127) is still displayed in the **Totalizer 1 to n** submenu. All other parameters in the submenu are hidden.

Process variable unit 1**Navigation**

Expert → Application → Totalizer 1 → VariableUnit 1

Prerequisite

A process variable is selected in the **Assign process variable** parameter (→ 127) of the **Totalizer 1 to n** submenu.

Description

Use this function to select the process variable unit for the Totalizer 1 to n (→ 127).

Selection*SI units*

- kg
- t

US units

- oz
- lb
- STon

or

Other units

None *

* Visibility depends on order options or device settings

Factory setting

Depends on country

Additional information*Description*

The unit is selected separately for the totalizer and is independent of the option selected in the **System units** submenu (→ 54).

Options

The selection is dependent on the process variable selected in the **Assign process variable** parameter (→ 127).

Totalizer 1 operation mode**Navigation**

Expert → Application → Totalizer 1 → Operat. mode 1

Prerequisite



A process variable is selected in the **Assign process variable** parameter (→ 127) of the **Totalizer 1 to n** submenu.

Description

Use this function to select how the totalizer summates the flow.

- Selection**
 - Net
 - Forward
 - Reverse
- Factory setting** Net
- Additional information** *Selection*
 - Net flow total
Flow values in the forward and reverse flow direction are totalized and balanced against one another. Net flow is registered in the flow direction.
 - Forward flow total
Only the flow in the forward flow direction is totalized.
 - Reverse flow total
Only the flow in the reverse flow direction is totalized (= reverse flow quantity).





Totalizer 1 control

- Navigation**  Expert → Application → Totalizer 1 → Tot. 1 control
- Prerequisite** A process variable is selected in the **Assign process variable** parameter (→  127) of the **Totalizer 1 to n** submenu.
- Description** Use this function to select the control of totalizer value 1-3.
- Selection**
 - Totalize
 - Reset + hold
 - Preset + hold
 - Reset + totalize
 - Preset + totalize
 - Hold
- Factory setting** Totalize
- Additional information** *Selection*

Options	Description
Totalize	The totalizer is started or continues running.
Reset + hold	The totaling process is stopped and the totalizer is reset to 0.
Preset + hold ¹⁾	The totaling process is stopped and the totalizer is set to its defined start value from the Preset value parameter.
Reset + totalize	The totalizer is reset to 0 and the totaling process is restarted.
Preset + totalize ¹⁾	The totalizer is set to the defined start value in the Preset value parameter and the totaling process is restarted.
Hold	Totalizing is stopped.



1) Visible depending on the order options or device settings

Preset value 1

Navigation	 Expert → Application → Totalizer 1 → Preset value 1
Prerequisite	A process variable is selected in the Assign process variable parameter (→  127) of the Totalizer 1 to n submenu.
Description	Use this function to enter a start value for the Totalizer 1 to n.
User entry	Signed floating-point number
Factory setting	0 kg
Additional information	<p><i>User entry</i></p> <p> The unit of the selected process variable is defined in the Unit totalizer parameter (→  128) for the totalizer.</p>

















Totalizer 1 failure behavior



Navigation	 Expert → Application → Totalizer 1 → FailureBehav. 1
Prerequisite	A process variable is selected in the Assign process variable parameter (→  127) of the Totalizer 1 to n submenu.
Description	Use this function to select how a totalizer behaves in the event of a device alarm.
Selection	<ul style="list-style-type: none"> ▪ Hold ▪ Continue ▪ Last valid value + continue
Factory setting	Hold
Additional information	<p><i>Description</i></p> <p> This setting does not affect the failsafe mode of other totalizers and the outputs. This is specified in separate parameters.</p> <p><i>Selection</i></p> <ul style="list-style-type: none"> ▪ Stop The totalizer is stopped in the event of a device alarm. ▪ Actual value The totalizer continues to count based on the actual (current) measured value; the device alarm is ignored. ▪ Last valid value The totalizer continues to count based on the last valid measured value before the device alarm occurred.



3.8 "Diagnostics" submenu

Navigation   Expert → Diagnostics

► Diagnostics	
Actual diagnostics	→  131
Previous diagnostics	→  132
Operating time from restart	→  133
Operating time	→  133
► Diagnostic list	→  134
► Event logbook	→  136
► Device information	→  138
► Main electronic module + I/O module 1	→  141
► Sensor electronic module (ISEM)	→  142
► I/O module 2	→  143
► I/O module 3	→  145
► I/O module 4	→  146
► Display module	→  147
► Data logging	→  148
► Min/max values	→  155
► Heartbeat Technology	→  160
► Simulation	→  160





Actual diagnostics

Navigation



  Expert → Diagnostics → Actual diagnos.

Prerequisite





A diagnostic event has occurred.

Description	Displays the current diagnostic message. If two or more messages occur simultaneously, the message with the highest priority is shown on the display.
User interface	Symbol for diagnostic behavior, diagnostic code and short message.
Additional information	<p><i>Display</i></p> <p> Additional pending diagnostic messages can be viewed in the Diagnostic list submenu (→  134).</p> <p> Via the local display: the time stamp and corrective measures referring to the cause of the diagnostic message can be accessed via the  key.</p> <p><i>Example</i></p> <p>For the display format: F271 Main electronic failure</p>



Timestamp

Navigation	 Expert → Diagnostics → Timestamp
Description	Displays the operating time when the current diagnostic message occurred.
User interface	Days (d), hours (h), minutes (m) and seconds (s)
Additional information	<p><i>Display</i></p> <p> The diagnostic message can be viewed via the Actual diagnostics parameter (→  131).</p> <p><i>Example</i></p> <p>For the display format: 24d12h13m00s</p>

Previous diagnostics

Navigation	  Expert → Diagnostics → Prev.diagnostics
Prerequisite	Two diagnostic events have already occurred.
Description	Displays the diagnostic message that occurred before the current message.
User interface	Symbol for diagnostic behavior, diagnostic code and short message.
Additional information	<p><i>Display</i></p> <p> Via the local display: the time stamp and corrective measures referring to the cause of the diagnostic message can be accessed via the  key.</p> <p><i>Example</i></p> <p>For the display format: F271 Main electronic failure</p>

Timestamp

Navigation	 Expert → Diagnostics → Timestamp
Description	Displays the operating time when the last diagnostic message before the current message occurred.
User interface	Days (d), hours (h), minutes (m) and seconds (s)
Additional information	<p><i>Display</i></p> <p> The diagnostic message can be viewed via the Previous diagnostics parameter (→  132).</p> <p><i>Example</i></p> <p>For the display format: 24d12h13m00s</p>

Operating time from restart





Navigation	 Expert → Diagnostics → Time fr. restart
Description	Use this function to display the time the device has been in operation since the last device restart.
User interface	Days (d), hours (h), minutes (m) and seconds (s)

Operating time





Navigation	 Expert → Diagnostics → Operating time
Description	Displays the length of time the device has been in operation.
User interface	Days (d), hours (h), minutes (m) and seconds (s)
Additional information	<p><i>Indication</i></p> <p>Maximum number of days: 9 999(corresponds to approx. 27 years and 5 months)</p>

3.8.1 "Diagnostic list" submenu

Navigation  Expert → Diagnostics → Diagnostic list

▶ Diagnostic list	
Diagnostics 1	→  134
Diagnostics 2	→  134
Diagnostics 3	→  135
Diagnostics 4	→  135
Diagnostics 5	→  136

Diagnostics 1

Navigation	 Expert → Diagnostics → Diagnostic list → Diagnostics 1
Description	Displays the current diagnostics message with the highest priority.
User interface	Symbol for diagnostic behavior, diagnostic code and short message.
Additional information	<p><i>Display</i></p> <p> Via the local display: the time stamp and corrective measures referring to the cause of the diagnostic message can be accessed via the  key.</p> <p><i>Examples</i></p> <p>For the display format:</p> <ul style="list-style-type: none"> ▪  F271 Main electronic failure ▪  F276 I/O module failure

Diagnostics 2

Navigation	 Expert → Diagnostics → Diagnostic list → Diagnostics 2
Description	Displays the current diagnostics message with the second-highest priority.
User interface	Symbol for diagnostic behavior, diagnostic code and short message.

Additional information*Display*

Via the local display: the time stamp and corrective measures referring to the cause of the diagnostic message can be accessed via the key.

Examples

For the display format:

- F271 Main electronic failure
- F276 I/O module failure

Diagnostics 3

Navigation

Expert → Diagnostics → Diagnostic list → Diagnostics 3

Description

Displays the current diagnostics message with the third-highest priority.

User interface

Symbol for diagnostic behavior, diagnostic code and short message.

Additional information*Display*

Via the local display: the time stamp and corrective measures referring to the cause of the diagnostic message can be accessed via the key.

Examples

For the display format:

- F271 Main electronic failure
- F276 I/O module failure

Diagnostics 4

Navigation

Expert → Diagnostics → Diagnostic list → Diagnostics 4

Description

Displays the current diagnostics message with the fourth-highest priority.

User interface

Symbol for diagnostic behavior, diagnostic code and short message.

Additional information*Display*





Via the local display: the time stamp and corrective measures referring to the cause of the diagnostic message can be accessed via the key.

Examples

For the display format:

- F271 Main electronic failure
- F276 I/O module failure

Diagnostics 5

Navigation	 Expert → Diagnostics → Diagnostic list → Diagnostics 5
Description	Displays the current diagnostics message with the fifth-highest priority.
User interface	Symbol for diagnostic behavior, diagnostic code and short message.
Additional information	<p><i>Display</i></p> <p> Via the local display: the time stamp and corrective measures referring to the cause of the diagnostic message can be accessed via the  key.</p> <p><i>Examples</i></p> <p>For the display format:</p> <ul style="list-style-type: none"> ▪  F271 Main electronic failure ▪  F276 I/O module failure

3.8.2 "Event logbook" submenu

Displays event messages

Event messages are displayed in chronological order. The event history includes both diagnostic events and information events. The symbol in front of the timestamp indicates whether the event has started or ended.

Navigation  Expert → Diagnostics → Event logbook

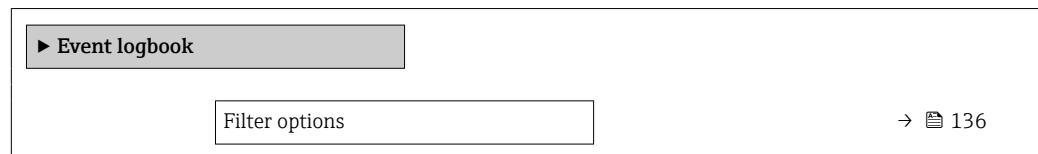

Filter options



Navigation	 Expert → Diagnostics → Event logbook → Filter options
Description	Use this function to select the category whose event messages are displayed in the event list of the local display.
Selection	<ul style="list-style-type: none"> ▪ All ▪ Failure (F) ▪ Function check (C) ▪ Out of specification (S) ▪ Maintenance required (M) ▪ Information (I)
Factory setting	All

Additional information*Description*

The status signals are categorized in accordance with VDI/VDE 2650 and NAMUR Recommendation NE 107:

- F = Failure
- C = Function Check
- S = Out of Specification
- M = Maintenance Required

"Event list" submenu

The **Event list** submenu is only displayed if operating via the local display.

If operating via the FieldCare operating tool, the event list can be read out with a separate FieldCare module.

If operating via the Web browser, the event messages can be found directly in the **Event logbook** submenu.

Navigation

Expert → Diagnostics → Event logbook → Event list

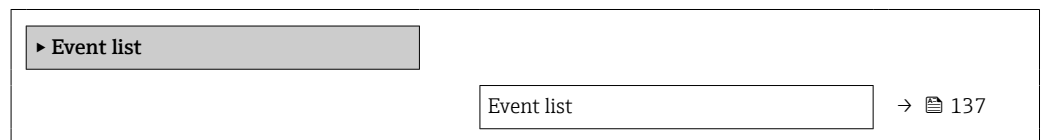
**Event list****Navigation**

Expert → Diagnostics → Event logbook → Event list

Description

Displays the history of event messages of the category selected in the **Filter options** parameter (→ 136).

User interface

- For a "Category I" event message
Information event, short message, symbol for event recording and operating time when error occurred
- For a "Category F, C, S, M" event message (status signal)
Diagnostics code, short message, symbol for event recording and operating time when error occurred

Additional information*Description*

A maximum of 20 event messages are displayed in chronological order.

If the **Extended HistoROM** application package (order option) is enabled in the device, the event list can contain up to 100 entries .

The following symbols indicate whether an event has occurred or has ended:

- ↻: Occurrence of the event
- ↺: End of the event

Examples

For the display format:









- I1091 Configuration modified
↻ 24d12h13m00s
- ⊗F271 Main electronic failure
↻ 01d04h12min30s

HistoROM

A HistoROM is a "non-volatile" device memory in the form of an EEPROM.

3.8.3 "Device information" submenu

Navigation  Expert → Diagnostics → Device info

▶ Device information	
Device tag	→  138
Serial number	→  139
Firmware version	→  139
Device name	→  140
Order code	→  140
Extended order code 1	→  140
Extended order code 2	→  140
Extended order code 3	→  141
ENP version	→  141

Device tag

Navigation

 Expert → Diagnostics → Device info → Device tag

Description

Displays a unique name for the measuring point so it can be identified quickly within the plant. It is displayed in the header.

User interface	Max. 32 characters, such as letters, numbers or special characters (e.g. @, %, /).
Factory setting	Teqwave M
Additional information	<i>User interface</i>

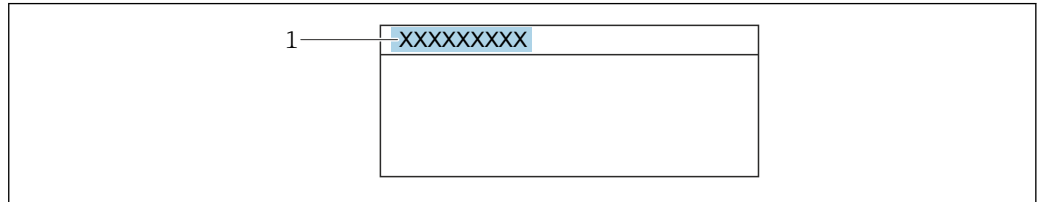

A0029422

1 Position of the header text on the display









The number of characters displayed depends on the characters used.

Serial number

Navigation	Expert → Diagnostics → Device info → Serial number
Description	Displays the serial number of the measuring device. The number can be found on the nameplate of the sensor and transmitter.
User interface	Max. 11-digit character string comprising letters and numbers.
Additional information	<i>Description</i> Uses of the serial number <ul style="list-style-type: none"> ▪ To identify the measuring device quickly, e.g. when contacting Endress+Hauser. ▪ To obtain specific information on the measuring device using the Device Viewer: www.endress.com/deviceviewer



Firmware version

Navigation	Expert → Diagnostics → Device info → Firmware version
Description	Displays the device firmware version installed.
User interface	Character string in the format xx.yy.zz
Additional information	<i>Display</i> The Firmware version is also located: <ul style="list-style-type: none"> ▪ On the title page of the Operating instructions ▪ On the transmitter nameplate



Device name	
Navigation	 Expert → Diagnostics → Device info → Device name
Description	Displays the name of the transmitter. It can also be found on the nameplate of the transmitter.
User interface	Character string comprising numbers, letters and special characters
Order code 	
Navigation	 Expert → Diagnostics → Device info → Order code
Description	Displays the device order code.
User interface	Character string composed of letters, numbers and certain punctuation marks (e.g. /).
Additional information	<p><i>Description</i></p> <p>The order code is generated from the extended order code through a process of reversible transformation. The extended order code indicates the attributes for all the device features in the product structure. The device features are not directly readable from the order code.</p> <p> Uses of the order code</p> <ul style="list-style-type: none"> ▪ To order an identical spare device. ▪ To identify the device quickly and easily, e.g. when contacting Endress+Hauser.
Extended order code 1 	
Navigation	 Expert → Diagnostics → Device info → Ext. order cd. 1
Description	<p>Displays the first part of the extended order code.</p> <p>On account of length restrictions, the extended order code is split into a maximum of 3 parameters.</p>
User interface	Character string
Additional information	<p><i>Description</i></p> <p>The extended order code indicates the version of all the features of the product structure for the measuring device and thus uniquely identifies the measuring device.</p>
Extended order code 2 	
Navigation	 Expert → Diagnostics → Device info → Ext. order cd. 2
Description	Displays the second part of the extended order code.

User interface	Character string
Additional information	For additional information, see Extended order code 1 parameter (→  140)



Extended order code 3



Navigation	  Expert → Diagnostics → Device info → Ext. order cd. 3
Description	Displays the third part of the extended order code.
User interface	Character string
Additional information	For additional information, see Extended order code 1 parameter (→  140)

ENP version



Navigation	  Expert → Diagnostics → Device info → ENP version
Description	Displays the version of the electronic nameplate.
User interface	Character string
Factory setting	2.02.00
Additional information	<p><i>Description</i></p> <p>This electronic nameplate stores a data record for device identification that includes more data than the nameplates attached to the outside of the device.</p>

3.8.4 "Main electronic module + I/O module 1" submenu



Navigation   Expert → Diagnostics 1 → Main elec.+I/O1

<div style="background-color: #cccccc; padding: 2px;">▶ Main electronic module + I/O module 1</div>	
Firmware version	→  142
Build no. software	→  142
Bootloader revision	→  142



Firmware version

Navigation	  Expert → Diagnostics → Main elec.+I/O1 → Firmware version
Description	Use this function to display the software revision of the module.
User interface	Positive integer



Build no. software



Navigation	  Expert → Diagnostics → Main elec.+I/O1 → Build no. softw.
Description	Use this function to display the software build number of the module.
User interface	Positive integer

Bootloader revision



Navigation	  Expert → Diagnostics → Main elec.+I/O1 → Bootloader rev.
Description	Use this function to display the bootloader revision of the software.
User interface	Positive integer

3.8.5 "Sensor electronic module (ISEM)" submenu



Navigation   Expert → Diagnostics → Sens. electronic

► Sensor electronic module (ISEM)	
Firmware version	→  143
Build no. software	→  143
Bootloader revision	→  143



Firmware version

Navigation	  Expert → Diagnostics → Sens. electronic → Firmware version
Description	Use this function to display the software revision of the module.
User interface	Positive integer

Build no. software





Navigation	  Expert → Diagnostics → Sens. electronic → Build no. softw.
Description	Use this function to display the software build number of the module.
User interface	Positive integer

Bootloader revision

Navigation	  Expert → Diagnostics → Sens. electronic → Bootloader rev.
Description	Use this function to display the bootloader revision of the software.
User interface	Positive integer

3.8.6 "I/O module 2" submenu

Navigation   Expert → Diagnostics → I/O module 2

► I/O module 2	
I/O module 2 terminal numbers	→  144
Firmware version	→  144
Build no. software	→  144
Bootloader revision	→  144

I/O module 2 terminal numbers

Navigation	 Expert → Diagnostics → I/O module 2 → I/O 2 terminals
Description	Displays the terminal numbers used by the I/O module.
User interface	<ul style="list-style-type: none">■ Not used■ 26-27 (I/O 1)■ 24-25 (I/O 2)■ 22-23 (I/O 3)■ 20-21 (I/O 4)

Firmware version

Navigation	 Expert → Diagnostics → I/O module 2 → Firmware version
Description	Use this function to display the software revision of the module.
User interface	Positive integer

Build no. software





Navigation	 Expert → Diagnostics → I/O module 2 → Build no. softw.
Description	Use this function to display the software build number of the module.
User interface	Positive integer

Bootloader revision

Navigation	 Expert → Diagnostics → I/O module 2 → Bootloader rev.
Description	Use this function to display the bootloader revision of the software.
User interface	Positive integer

3.8.7 "I/O module 3" submenu

Navigation  Expert → Diagnostics → I/O module 3

▶ I/O module 3	
I/O module 3 terminal numbers	→  145
Firmware version	→  145
Build no. software	→  145
Bootloader revision	→  146

I/O module 3 terminal numbers

Navigation  Expert → Diagnostics → I/O module 3 → I/O 3 terminals

Description Displays the terminal numbers used by the I/O module.

User interface

- Not used
- 26-27 (I/O 1)
- 24-25 (I/O 2)
- 22-23 (I/O 3)
- 20-21 (I/O 4)

Firmware version

Navigation  Expert → Diagnostics → I/O module 3 → Firmware version

Description Use this function to display the software revision of the module.

User interface Positive integer



Build no. software

Navigation  Expert → Diagnostics → I/O module 3 → Build no. softw.

Description Use this function to display the software build number of the module.





User interface Positive integer

Bootloader revision



Navigation	  Expert → Diagnostics → I/O module 3 → Bootloader rev.
Description	Use this function to display the bootloader revision of the software.
User interface	Positive integer

3.8.8 "I/O module 4" submenu



Navigation   Expert → Diagnostics → I/O module 4

▶ I/O module 4	
I/O module 4 terminal numbers	→  146
Firmware version	→  146
Build no. software	→  147
Bootloader revision	→  147

I/O module 4 terminal numbers

Navigation	  Expert → Diagnostics → I/O module 4 → I/O 4 terminals
Description	Displays the terminal numbers used by the I/O module.
User interface	<ul style="list-style-type: none"> ■ Not used ■ 26-27 (I/O 1) ■ 24-25 (I/O 2) ■ 22-23 (I/O 3) ■ 20-21 (I/O 4)*



Firmware version

Navigation	  Expert → Diagnostics → I/O module 4 → Firmware version
Description	Use this function to display the software revision of the module.

* Visibility depends on order options or device settings

User interface Positive integer



Build no. software

Navigation   Expert → Diagnostics → I/O module 4 → Build no. softw.

Description Use this function to display the software build number of the module.

User interface Positive integer



Bootloader revision

Navigation   Expert → Diagnostics → I/O module 4 → Bootloader rev.

Description Use this function to display the bootloader revision of the software.

User interface Positive integer

3.8.9 "Display module" submenu

Navigation   Expert → Diagnostics → Display module

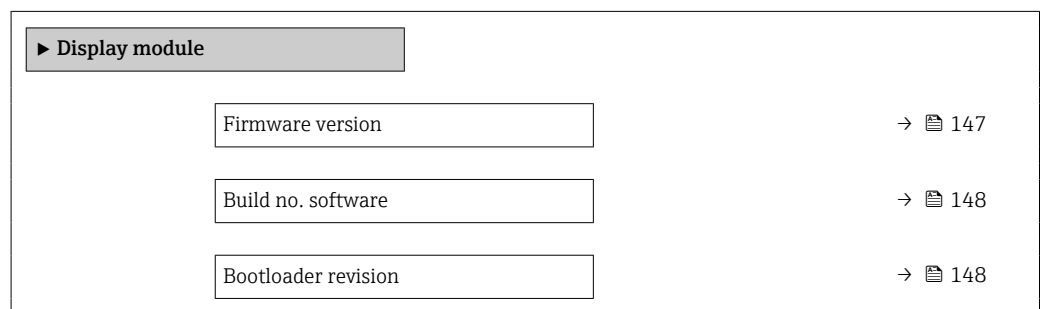

Firmware version

Navigation   Expert → Diagnostics → Display module → Firmware version

Description Use this function to display the software revision of the module.

User interface Positive integer

Build no. software











Navigation	 Expert → Diagnostics → Display module → Build no. softw.
Description	Use this function to display the software build number of the module.
User interface	Positive integer

Bootloader revision

Navigation	 Expert → Diagnostics → Display module → Bootloader rev.
Description	Use this function to display the bootloader revision of the software.
User interface	Positive integer

3.8.10 "Data logging" submenu

Navigation  Expert → Diagnostics → Data logging

▶ Data logging	
Assign channel 1	→  149
Assign channel 2	→  149
Assign channel 3	→  150
Assign channel 4	→  150
Logging interval	→  150
Clear logging data	→  151
Data logging	→  152
Logging delay	→  152
Data logging control	→  152
Data logging status	→  153
Entire logging duration	→  153

Assign channel 1

Navigation	Expert → Diagnostics → Data logging → Assign chan. 1
Prerequisite	<ul style="list-style-type: none"> ▪ The Load rate option is only available if the volume flow of the medium is read in via the Current input 1 to n (→ 49) or the fieldbus. ▪ The Extended HistoROM application package is available. <p> The software options currently enabled are displayed in the Software option overview parameter (→ 45).</p>
Description	Use this function to assign a process variable to the data logging channel.
Selection	<ul style="list-style-type: none"> ▪ Off ▪ Total solids ▪ Temperature ▪ Electronics temperature ▪ Conductivity ▪ Corrected conductivity ▪ Load rate * ▪ Current output 1 * ▪ Current output 2 * ▪ Current output 3 * ▪ Current output 4 *
Factory setting	Off
Additional information	<p><i>Description</i></p> <p>A total of 1000 measured values can be logged. This means:</p> <ul style="list-style-type: none"> ▪ 1000 data points if 1 logging channel is used ▪ 500 data points if 2 logging channels are used ▪ 333 data points if 3 logging channels are used ▪ 250 data points if 4 logging channels are used <p>Once the maximum number of data points is reached, the oldest data points in the data log are cyclically overwritten in such a way that the last 1000, 500, 333 or 250 measured values are always in the log (ring memory principle).</p> <p> The log contents are cleared if the option selected is changed.</p>

Assign channel 2



Navigation	Expert → Diagnostics → Data logging → Assign chan. 2
Prerequisite	<ul style="list-style-type: none"> ▪ The Load rate option is only available if the volume flow of the medium is read in via the Current input 1 to n (→ 49) or the fieldbus. ▪ The Extended HistoROM application package is available. <p> The software options currently enabled are displayed in the Software option overview parameter (→ 45).</p>
Description	Use this function to assign a process variable to the logging channel.

* Visibility depends on order options or device settings

Selection For the picklist, see **Assign channel 1** parameter (→  149)



Factory setting Off

Assign channel 3

Navigation   Expert → Diagnostics → Data logging → Assign chan. 3

Prerequisite

- The **Load rate** option is only available if the volume flow of the medium is read in via the Current input 1 to n (→  49) or the fieldbus.
- The **Extended HistoROM** application package is available.



 The software options currently enabled are displayed in the **Software option overview** parameter (→  45).

Description Use this function to assign a process variable to the logging channel.

Selection For the picklist, see **Assign channel 1** parameter (→  149)



Factory setting Off

Assign channel 4

Navigation   Expert → Diagnostics → Data logging → Assign chan. 4

Prerequisite

- The **Load rate** option is only available if the volume flow of the medium is read in via the Current input 1 to n (→  49) or the fieldbus.
- The **Extended HistoROM** application package is available.



 The software options currently enabled are displayed in the **Software option overview** parameter (→  45).

Description Use this function to assign a process variable to the logging channel.

Selection For the picklist, see **Assign channel 1** parameter (→  149)

Factory setting Off

Logging interval

Navigation   Expert → Diagnostics → Data logging → Logging interval

Prerequisite The **Extended HistoROM** application package is available.

 The software options currently enabled are displayed in the **Software option overview** parameter (→  45).

Description Use this function to enter the logging interval T_{log} for data logging.

User entry 0.1 to 3 600.0 s

Factory setting 1.0 s

Additional information *Description*

This defines the interval between the individual data points in the data log, and thus the maximum loggable process time T_{\log} :

- If 1 logging channel is used: $T_{\log} = 1000 \times t_{\log}$
- If 2 logging channels are used: $T_{\log} = 500 \times t_{\log}$
- If 3 logging channels are used: $T_{\log} = 333 \times t_{\log}$
- If 4 logging channels are used: $T_{\log} = 250 \times t_{\log}$

Once this time elapses, the oldest data points in the data log are cyclically overwritten such that a time of T_{\log} always remains in the memory (ring memory principle).



 The log contents are cleared if the length of the logging interval is changed.

Example



If 1 logging channel is used:

- $T_{\log} = 1000 \times 1 \text{ s} = 1\,000 \text{ s} \approx 15 \text{ min}$
- $T_{\log} = 1000 \times 10 \text{ s} = 10\,000 \text{ s} \approx 3 \text{ h}$
- $T_{\log} = 1000 \times 80 \text{ s} = 80\,000 \text{ s} \approx 1 \text{ d}$
- $T_{\log} = 1000 \times 3\,600 \text{ s} = 3\,600\,000 \text{ s} \approx 41 \text{ d}$

Clear logging data

Navigation   Expert → Diagnostics → Data logging → Clear logging

Prerequisite The **Extended HistoROM** application package is available.

 The software options currently enabled are displayed in the **Software option overview** parameter (→  45).

Description Use this function to clear the entire logging data.

Selection

- Cancel
- Clear data

Factory setting Cancel

Additional information *Selection*

- Cancel
The data is not cleared. All the data is retained.
- Clear data
The logging data is cleared. The logging process starts from the beginning.

Data logging

Navigation	Expert → Diagnostics → Data logging → Data logging
Description	Use this function to select the data logging method.
Selection	<ul style="list-style-type: none"> ■ Overwriting ■ Not overwriting
Factory setting	Overwriting
Additional information	<p><i>Selection</i></p> <ul style="list-style-type: none"> ■ Overwriting The device memory applies the FIFO principle. ■ Not overwriting Data logging is canceled if the measured value memory is full (single shot).

Logging delay





Navigation	Expert → Diagnostics → Data logging → Logging delay
Prerequisite	In the Data logging parameter (→ 152), the Not overwriting option is selected.
Description	Use this function to enter the time delay for measured value logging.
User entry	0 to 999 h
Factory setting	0 h
Additional information	<p><i>Description</i></p> <p>Once data logging has been started with the Data logging control parameter (→ 152), the device does not save any data for the duration of the delay time entered.</p>

Data logging control





Navigation	Expert → Diagnostics → Data logging → Data log.control
Prerequisite	In the Data logging parameter (→ 152), the Not overwriting option is selected.
Description	Use this function to start and stop measured value logging.
Selection	<ul style="list-style-type: none"> ■ None ■ Delete + start ■ Stop
Factory setting	None

Additional information	<i>Selection</i> <ul style="list-style-type: none"> ■ None Initial measured value logging status. ■ Delete + start All the measured values recorded for all the channels are deleted and measured value logging starts again. ■ Stop Measured value logging is stopped.
-------------------------------	--

Data logging status

Navigation	  Expert → Diagnostics → Data logging → Data log. status
Prerequisite	In the Data logging parameter (→  152), the Not overwriting option is selected.
Description	Displays the measured value logging status.
User interface	<ul style="list-style-type: none"> ■ Done ■ Delay active ■ Active ■ Stopped
Factory setting	Done
Additional information	<i>Selection</i> <ul style="list-style-type: none"> ■ Done Measured value logging has been performed and completed successfully. ■ Delay active Measured value logging has been started but the logging interval has not yet elapsed. ■ Active The logging interval has elapsed and measured value logging is active. ■ Stopped Measured value logging is stopped.

Entire logging duration

Navigation	  Expert → Diagnostics → Data logging → Logging duration
Prerequisite	In the Data logging parameter (→  152), the Not overwriting option is selected.
Description	Displays the total logging duration.
User interface	Positive floating-point number
Factory setting	0 s

"Display channel 1" submenu



Navigation  Expert → Diagnostics → Data logging → Displ.channel 1

**Display channel 1****Navigation**

 Expert → Diagnostics → Data logging → Displ.channel 1

Prerequisite

The **Extended HistoROM** application package is available.

 The software options currently enabled are displayed in the **Software option overview** parameter (→  45).

Description

Displays the measured value trend for the logging channel in the form of a chart.

Additional information

Description

- x-axis: depending on the number of channels selected displays 250 to 1000 measured values of a process variable.
- y-axis: displays the approximate measured value span and constantly adapts this to the ongoing measurement.

"Display channel 2" submenu

Navigation  Expert → Diagnostics → Data logging → Displ.channel 2

**Display channel 2****Navigation**

 Expert → Diagnostics → Data logging → Displ.channel 2

Prerequisite

A process variable is specified in the **Assign channel 2** parameter.

Description

See the **Display channel 1** parameter →  154

"Display channel 3" submenu

Navigation  Expert → Diagnostics → Data logging → Displ.channel 3

**Display channel 3**

Navigation  Expert → Diagnostics → Data logging → Displ.channel 3

Prerequisite A process variable is specified in the **Assign channel 3** parameter.

Description See the **Display channel 1** parameter →  154

"Display channel 4" submenu

Navigation  Expert → Diagnostics → Data logging → Displ.channel 4

**Display channel 4**

Navigation  Expert → Diagnostics → Data logging → Displ.channel 4

Prerequisite A process variable is specified in the **Assign channel 4** parameter.

Description See the **Display channel 1** parameter →  154

3.8.11 "Min/max values" submenu

Navigation   Expert → Diagnostics → Min/max val.

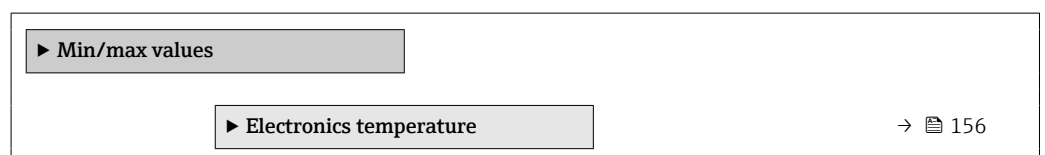

▶ Main electronics temperature	→ 156
▶ Sensor electronics temperature (ISEM)	→ 157
▶ Medium temperature	→ 158
▶ Total solids	→ 159
▶ Conductivity	→ 159

"Electronics temperature" submenu

Navigation  Expert → Diagnostics → Min/max val. → Electronics temp

▶ Electronics temperature

Minimum value

Navigation	 Expert → Diagnostics → Min/max val. → Electronics temp → Minimum value
Description	Shows the lowest electronics temperature measured to date.
User interface	Positive floating-point number

Maximum value

Navigation	 Expert → Diagnostics → Min/max val. → Electronics temp → Maximum value
Description	Shows the highest electronics temperature measured to date.
User interface	Positive floating-point number



"Main electronics temperature" submenu

Navigation  Expert → Diagnostics → Min/max val. → Main elect.temp.



▶ Main electronics temperature

Maximum value	→ ⓘ 157
Minimum value	→ ⓘ 157



Minimum value

Navigation	  Expert → Diagnostics → Min/max val. → Main elect.temp. → Minimum value
Description	Displays the lowest previously measured temperature value of the electronics module in the transmitter.
User interface	Signed floating-point number
Additional information	<i>Dependency</i>  The unit is taken from the Temperature unit parameter (→ ⓘ 56)

Maximum value



Navigation	  Expert → Diagnostics → Min/max val. → Main elect.temp. → Maximum value
Description	Displays the highest previously measured temperature value of the electronics module in the transmitter.
User interface	Signed floating-point number
Additional information	<i>Dependency</i>  The unit is taken from the Temperature unit parameter (→ ⓘ 56)

"Sensor electronics temperature (ISEM)" submenu



Navigation 
 Expert → Diagnostics → Min/max val. → Sensor elec.temp

<div style="background-color: #e0e0e0; padding: 2px; border: 1px solid black;"> ▶ Sensor electronics temperature (ISEM) </div>	
Maximum value	→ ⓘ 158
Minimum value	→ ⓘ 158

Minimum value



Navigation	  Expert → Diagnostics → Min/max val. → Sensor elec.temp → Minimum value
Description	Shows the lowest temperature measured to date for the sensor electronic module.
User interface	Signed floating-point number

Maximum value



Navigation	  Expert → Diagnostics → Min/max val. → Sensor elec.temp → Maximum value
Description	Shows the highest temperature measured to date for the sensor electronic module.
User interface	Signed floating-point number

"Medium temperature" submenu



Navigation   Expert → Diagnostics → Min/max val. → Medium temp.

▶ Medium temperature	
Maximum value	→  158
Minimum value	→  158

Minimum value

Navigation	  Expert → Diagnostics → Min/max val. → Medium temp. → Minimum value
Description	Shows the lowest medium temperature measured to date.
User interface	Signed floating-point number

Maximum value

Navigation	  Expert → Diagnostics → Min/max val. → Medium temp. → Maximum value
Description	Shows the highest medium temperature measured to date.

User interface Signed floating-point number

"Total solids" submenu

Navigation  Expert → Diagnostics → Min/max val. → Total solids

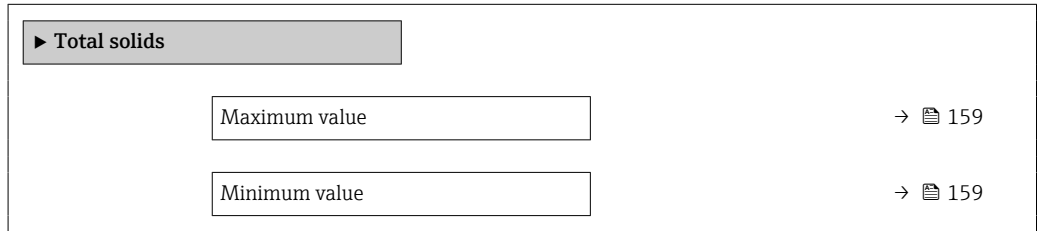

Maximum value

Navigation  Expert → Diagnostics → Min/max val. → Total solids → Maximum value

Description Shows the highest total solids value measured to date.

User interface Positive floating-point number

Minimum value

Navigation  Expert → Diagnostics → Min/max val. → Total solids → Minimum value

Description Shows the lowest total solids value measured to date.



User interface Positive floating-point number

"Conductivity" submenu

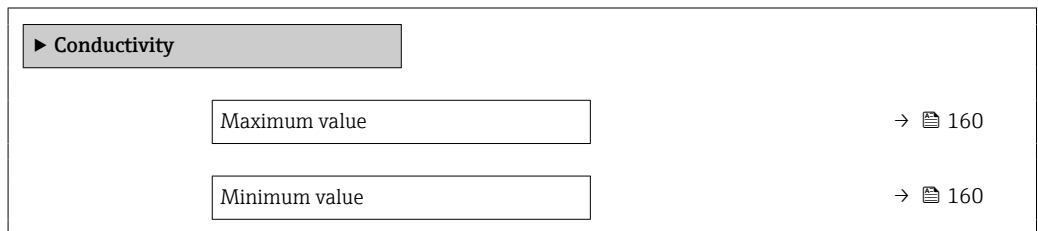

Navigation  Expert → Diagnostics → Min/max val. → Conductivity





Maximum value



Navigation	  Expert → Diagnostics → Min/max val. → Conductivity → Maximum value
Description	Shows the highest conductivity measured to date.
User interface	Positive floating-point number

Minimum value

Navigation	  Expert → Diagnostics → Min/max val. → Conductivity → Minimum value
Description	Shows the lowest conductivity measured to date.
User interface	Positive floating-point number









3.8.12 "Heartbeat Technology" submenu











 For detailed information on the parameter descriptions of the **Heartbeat Verification** application package, see the Special Documentation for the device →  7

Navigation   Expert → Diagnostics → Heartbeat Techn.

3.8.13 "Simulation" submenu



Navigation   Expert → Diagnostics → Simulation

► Simulation	
Assign simulation process variable	→  161
Process variable value	→  162
Current input 1 to n simulation	→  162
Value current input 1 to n	→  162
Status input 1 to n simulation	→  163
Input signal level 1 to n	→  163
Current output 1 to n simulation	→  163
Current output value	→  164

Frequency output 1 to n simulation	→  164
Frequency output 1 to n value	→  165
Pulse output simulation 1 to n	→  165
Pulse value 1 to n	→  166
Switch output simulation 1 to n	→  166
Switch state 1 to n	→  167
Relay output 1 to n simulation	→  167
Switch state 1 to n	→  168
Device alarm simulation	→  168
Diagnostic event category	→  169
Diagnostic event simulation	→  169

Assign simulation process variable

Navigation

  Expert → Diagnostics → Simulation → Assign proc.var.

Prerequisite

The **Load rate** option is only available if the volume flow of the medium is read in via the Current input 1 to n (→  49) or the fieldbus.

Description

Select a process variable for the simulation process that is activated.

Selection



- Off
- Load rate *
- Total solids
- Temperature
- Electronics temperature
- Conductivity
- Corrected conductivity

Factory setting



Off

* Visibility depends on order options or device settings



Process variable value 

Navigation	  Expert → Diagnostics → Simulation → Proc. var. value
Description	Enter the simulation value for the selected process variable.
User entry	Signed floating-point number
Factory setting	0

Current input 1 to n simulation 

Navigation	  Expert → Diagnostics → Simulation → Curr.inp 1 to n sim.
Description	Option for switching simulation of the current input on and off. The display alternates between the measured value and a diagnostic message of the "Function check" category (C) while simulation is in progress.  The desired simulation value is defined in the Value current input 1 to n parameter.
Selection	<ul style="list-style-type: none"> ■ Off ■ On
Factory setting	Off
Additional information	<i>Selection</i> <ul style="list-style-type: none"> ■ Off Current simulation is switched off. The device is in normal measuring mode or another process variable is being simulated. ■ On Current simulation is active.

Value current input 1 to n 

Navigation	  Expert → Diagnostics → Simulation → Value curr.inp 1 to n
Prerequisite	In the Current input 1 to n simulation parameter, the On option is selected.
Description	Use this function to enter the current value for the simulation. In this way, users can verify the correct configuration of the current input and the correct function of upstream feed-in units.
User entry	0 to 22.5 mA

Status input 1 to n simulation

Navigation	Expert → Diagnostics → Simulation → Status inp 1 to n sim
Description	Use this function to switch simulation of the status input on and off. The display alternates between the measured value and a diagnostic message of the "Function check" category (C) while simulation is in progress.
Selection	<ul style="list-style-type: none"> ■ Off ■ On
Factory setting	Off
Additional information	<p><i>Description</i></p> <p> The desired simulation value is defined in the Input signal level parameter (→ 163).</p> <p><i>Selection</i></p> <ul style="list-style-type: none"> ■ Off Simulation for the status input is switched off. The device is in normal measuring mode or another process variable is being simulated. ■ On Simulation for the status input is active.

Input signal level 1 to n



Navigation	Expert → Diagnostics → Simulation → Signal level 1 to n
Prerequisite	In the Status input simulation parameter (→ 163), the On option is selected.
Description	Use this function to select the signal level for the simulation of the status input. In this way, users can verify the correct configuration of the status input and the correct function of upstream feed-in units.
Selection	<ul style="list-style-type: none"> ■ High ■ Low

Current output 1 to n simulation

Navigation	Expert → Diagnostics → Simulation → Curr.outp 1 to n sim.
Description	Use this function to switch simulation of the current output on and off. The display alternates between the measured value and a diagnostic message of the "Function check" category (C) while simulation is in progress.
Selection	<ul style="list-style-type: none"> ■ Off ■ On

Factory setting Off

Additional information *Description*

 The desired simulation value is defined in the **Value current output 1 to n** parameter.

Selection

- Off
Current simulation is switched off. The device is in normal measuring mode or another process variable is being simulated.
- On
Current simulation is active.

Current output value

Navigation  Expert → Diagnostics → Simulation → Curr.outp val.

Prerequisite In the **Current output 1 to n simulation** parameter, the **On** option is selected.

Description Use this function to enter a current value for the simulation. In this way, users can verify the correct adjustment of the current output and the correct function of downstream switching units.

User entry 3.59 to 22.5 mA

Additional information *Dependency*
The input range is dependent on the option selected in the **Current span** parameter (→  75).

Frequency output 1 to n simulation

Navigation  Expert → Diagnostics → Simulation → Freq.outp 1 to n sim.







Prerequisite In the **Operating mode** parameter (→  87), the **Frequency** option is selected.









Description Use this function to switch simulation of the frequency output on and off. The display alternates between the measured value and a diagnostic message of the "Function check" category (C) while simulation is in progress.

Selection

- Off
- On



Factory setting Off

Additional information	Description
	 The desired simulation value is defined in the Frequency value 1 to n parameter.
	<i>Selection</i>
	<ul style="list-style-type: none"> ▪ Off Frequency simulation is switched off. The device is in normal measuring mode or another process variable is being simulated. ▪ On Frequency simulation is active.
<hr/> Frequency output 1 to n value 	
Navigation	 Expert → Diagnostics → Simulation → Freq.outp 1 to n val.
Prerequisite	In the Frequency simulation 1 to n parameter, the On option is selected.
Description	Use this function to enter a frequency value for the simulation. In this way, users can verify the correct adjustment of the frequency output and the correct function of downstream switching units.
User entry	0.0 to 12 500.0 Hz
<hr/> Pulse output simulation 1 to n 	
Navigation	 Expert → Diagnostics → Simulation → Puls.outp.sim. 1 to n
Prerequisite	In the Operating mode parameter (→  87), the Pulse option is selected.
Description	Use this function to switch simulation of the pulse output on and off. The display alternates between the measured value and a diagnostic message of the "Function check" category (C) while simulation is in progress.
Selection	<ul style="list-style-type: none"> ▪ Off ▪ Fixed value ▪ Down-counting value
Factory setting	Off



Additional information	<i>Description</i>
	 The desired simulation value is defined in the Pulse value 1 to n parameter.
	<i>Selection</i>
	<ul style="list-style-type: none"> ■ Off Pulse simulation is switched off. The device is in normal measuring mode or another process variable is being simulated. ■ Fixed value Pulses are continuously output with the pulse width specified in the Pulse width parameter (→  89). ■ Down-counting value The pulses specified in the Pulse value parameter (→  166) are output.
<hr/>	
Pulse value 1 to n 	
Navigation	 Expert → Diagnostics → Simulation → Pulse value 1 to n
Prerequisite	In the Pulse output simulation 1 to n parameter, the Down-counting value option is selected.
Description	Use this function to enter a pulse value for the simulation. In this way, users can verify the correct adjustment of the pulse output and the correct function of downstream switching units.
User entry	0 to 65 535
<hr/>	
Switch output simulation 1 to n 	
Navigation	 Expert → Diagnostics → Simulation → Switch sim. 1 to n
Prerequisite	In the Operating mode parameter (→  87), the Switch option is selected.
Description	Use this function to switch simulation of the switch output on and off. The display alternates between the measured value and a diagnostic message of the "Function check" category (C) while simulation is in progress.
Selection	<ul style="list-style-type: none"> ■ Off ■ On
Factory setting	Off





Additional information	<p><i>Description</i></p> <p> The desired simulation value is defined in the Switch state 1 to n parameter.</p> <p><i>Selection</i></p> <ul style="list-style-type: none"> ▪ Off Switch simulation is switched off. The device is in normal measuring mode or another process variable is being simulated. ▪ On Switch simulation is active.
-------------------------------	--

Switch state 1 to n

Navigation	  Expert → Diagnostics → Simulation → Switch state 1 to n
Description	Use this function to select a switch value for the simulation. In this way, users can verify the correct adjustment of the switch output and the correct function of downstream switching units.
Selection	<ul style="list-style-type: none"> ▪ Open ▪ Closed
Additional information	<p><i>Selection</i></p> <ul style="list-style-type: none"> ▪ Open Switch simulation is switched off. The device is in normal measuring mode or another process variable is being simulated. ▪ Closed Switch simulation is active.

Relay output 1 to n simulation

Navigation	  Expert → Diagnostics → Simulation → Relay out. 1 to n sim
Description	Use this function to switch simulation of the relay output on and off. The display alternates between the measured value and a diagnostic message of the "Function check" category (C) while simulation is in progress.
Selection	<ul style="list-style-type: none"> ▪ Off ▪ On
Factory setting	Off

Additional information	<p><i>Description</i></p> <p> The desired simulation value is defined in the Switch state 1 to n parameter.</p> <p><i>Selection</i></p> <ul style="list-style-type: none"> ▪ Off Relay simulation is switched off. The device is in normal measuring mode or another process variable is being simulated. ▪ On Relay simulation is active.
<hr/>	
Switch state 1 to n 	
Navigation	 Expert → Diagnostics → Simulation → Switch state 1 to n
Prerequisite	The On option is selected in the Switch output simulation 1 to n parameter parameter.
Description	Use this function to select a relay value for the simulation. In this way, users can verify the correct adjustment of the relay output and the correct function of downstream switching units.
Selection	<ul style="list-style-type: none"> ▪ Open ▪ Closed
Additional information	<p><i>Selection</i></p> <ul style="list-style-type: none"> ▪ Open Relay simulation is switched off. The device is in normal measuring mode or another process variable is being simulated. ▪ Closed Relay simulation is active.
<hr/>	
Device alarm simulation 	
Navigation	 Expert → Diagnostics → Simulation → Dev. alarm sim.
Description	Use this function to switch the device alarm on and off.
Selection	<ul style="list-style-type: none"> ▪ Off ▪ On
Factory setting	Off
Additional information	<p><i>Description</i></p> <p>The display alternates between the measured value and a diagnostic message of the "Function check" category (C) while simulation is in progress.</p>

Diagnostic event category

**Navigation**

Expert → Diagnostics → Simulation → Event category

Description

Use this function to select the category of the diagnostic events that are displayed for the simulation in the **Diagnostic event simulation** parameter (→ 169).

Selection

- Sensor
- Electronics
- Configuration
- Process

Factory setting

Process

Diagnostic event simulation

**Navigation**

Expert → Diagnostics → Simulation → Diagnostic event

Description

Use this function to select a diagnostic event for the simulation process that is activated.

Selection

- Off
- Diagnostic event picklist (depends on the category selected)

Factory setting

Off

Additional information*Description*

For the simulation, you can choose from the diagnostic events of the category selected in the **Diagnostic event category** parameter (→ 169).

4 Country-specific factory settings

4.1 SI units

 The country-specific factory setting in SI units is made for all countries except the USA and Canada.

4.1.1 System units

Process variable	Unit
Total solids	%TS
Density	g/l
Mass flow	kg/h
Mass	kg
Volume	l/h
Temperature	°C
Conductivity	μS/cm
Load rate	kg/h

 For further information on system units, see: **System units** submenu (→  54)

4.1.2 Output current span

Output	Current range
Current output 1 to n	4 to 20 mA NAMUR

 For further information on the current ranges, see: **Current range output** parameter (→  75)



4.2 US units

 The country-specific factory setting in US units is made for the USA and Canada.

4.2.1 System units

Process variable	Unit
Total solids	%TS
Density	lb/ft ³
Mass flow	lb/h
Mass	lb
Volume	l/h
Temperature	°F

Process variable	Unit
Conductivity	$\mu\text{S/cm}$
Load rate	lb/h

 For further information on system units, see: **System units** submenu (\rightarrow  54)

4.2.2 Output current span

Output	Current range
Current output 1 to n	4 to 20 mA US

 For further information on the current ranges, see: **Current range output** parameter (\rightarrow  75)



5 Modbus RS485 register information

5.1 Notes

5.1.1 Adapted Modbus RS485 registers for process variables



There are four-digit Modbus RS485 registers now available for the process variables **Total solids** and **Load rate**.

 The Modbus RS485 registers for the process variables **Total solids** and **Load rate** listed in the following chapter 5.3 "Register information" → 5.3.2 "Sensor" → "Measured values" → "Process variables") are **no longer valid**. The valid Modbus RS485 registers are described in the following table.

Navigation: Expert → Sensor → Measured values → Process variables					
Parameter	Register	Data type	Access	Selection / User entry / User interface	→ 
Total solids	5089 ... 5090	Float	Read	Signed floating-point number	→  46
Load rate	5091 ... 5092	Float	Read	Signed floating-point number	→  47

5.1.2 Structure of the register information

The individual parts of a parameter description are described in the following section:

Navigation: navigation path to the parameter					
Parameter	Register	Data type	Access type	User interface/ Selection/User entry	→ 
Name of parameter	Indicated in decimal numerical format	<ul style="list-style-type: none"> ▪ Float length = 4 byte ▪ Integer length = 2 byte ▪ String length, depending on parameter 	Possible type of access to parameter: <ul style="list-style-type: none"> ▪ Read access via function codes 03, 04 or 23 ▪ Write access via function codes 06, 16 or 23 	Options List of the individual options for the parameter <ul style="list-style-type: none"> ▪ Option 1 ▪ Option 2 ▪ Option 3 (+)  (+) = Factory setting depends on country, order options or device settings User entry Specific value or input range for the parameter	Page number information and cross-reference to the standard parameter description

NOTICE

If non-volatile device parameters are modified via the MODBUS RS485 function codes 06, 16 or 23, the change is saved in the EEPROM of the measuring device.

The number of writes to the EEPROM is technically restricted to a maximum of 1 million.

- ▶ Make sure to comply with this limit since, if it is exceeded, data loss and measuring device failure will result.
- ▶ Avoid constantly writing non-volatile device parameters via the MODBUS RS485.

5.1.3 Address model

The Modbus RS485 register addresses of the measuring device are implemented in accordance with the "Modbus Applications Protocol Specification V1.1".

In addition, systems are used that work with the register address model "Modicon Modbus Protocol Reference Guide (PI-MBUS-300 Rev. J)".

Depending on the function code used, a number is added at the start of the register address with this specification:

- "3" → "Read" access
- "4" → "Write" access

Function code	Access type	Register in accordance with "Modbus Applications Protocol Specification"	Register in accordance with "Modicon Modbus Protocol Reference Guide"
03 04 23	Read	XXXX Example: total solids = 52245	3XXXX Example: total solids = 352245
06 16 23	Write	XXXX Example: reset totalizer = 2609	4XXXX Example: reset totalizer = 42609

5.2 Overview of the Expert operating menu

The following table provides an overview of the menu structure of the expert operating menu and its parameters. The page reference indicates where the associated description of the submenu or parameter can be found.

























Navigation  Expert

Expert		
Locking status		→ 189
User role		→ 189
Enter access code		→ 189
System		→ 189
Display		→ 189
Display language		→ 189
Format display		→ 189
Value 1 display		→ 189
0% bargraph value 1		→ 189
100% bargraph value 1		→ 189
Decimal places 1		→ 189
Value 2 display		→ 190
Decimal places 2		→ 190
Value 3 display		→ 190
0% bargraph value 3		→ 190
100% bargraph value 3		→ 190
Decimal places 3		→ 190
Value 4 display		→ 190
Decimal places 4		→ 190
Display interval		→ 190

Display damping	→ 190
Header	→ 190
Header text	→ 190
Separator	→ 190
Contrast display	→ 190
Backlight	→ 190
► Configuration backup	→ 191
Operating time	→ 191
Last backup	→ 191
Configuration management	→ 191
Backup state	→ 191
Comparison result	→ 191
► Diagnostic handling	→ 191
Alarm delay	→ 191
► Diagnostic behavior	→ 191
Assign behavior of diagnostic no. 302	→ 191
Assign behavior of diagnostic no. 444	→ 191
Assign behavior of diagnostic no. 441	→ 191
Assign behavior of diagnostic no. 442	→ 191
Assign behavior of diagnostic no. 443	→ 192
Assign behavior of diagnostic no. 832	→ 192
Assign behavior of diagnostic no. 833	→ 192
Assign behavior of diagnostic no. 834	→ 192
Assign behavior of diagnostic no. 835	→ 192

	Assign behavior of diagnostic no. 907	→ 192
	Assign behavior of diagnostic no. 908	→ 192
▶ Administration		→ 192
▶ Define access code		→ 192
Define access code		→ 192
Confirm access code		→ 192
▶ Reset access code		→ 193
Operating time		→ 193
Reset access code		→ 193
Device reset		→ 192
Transmitter identifier		→ 192
Activate SW option		→ 192
Software option overview		→ 192
▶ Sensor		→ 193
▶ Measured values		→ 193
▶ Process variables		→ 193
Total solids		→ 193
Temperature		→ 193
Electronics temperature		→ 193
Conductivity		→ 193
Corrected conductivity		→ 193
Load rate		→ 193
▶ Totalizer		→ 193
Totalizer 1 value		→ 193
Totalizer 1 overflow		→ 193

























▶ Input values	→ 193
▶ Current input 1 to n	→ 193
▶ Value status input 1 to n	→ 193
▶ Output values	→ 194
▶ Value current output 1 to n	→ 194
▶ Pulse/frequency/switch output 1 to n	→ 194
▶ Relay output 1 to n	→ 194
▶ System units	→ 195
Total solids unit	→ 195
Density unit	→ 195
Mass flow unit	→ 195
Mass unit	→ 195
Volume flow unit	→ 195
Temperature unit	→ 195
Conductivity unit	→ 195
Date/time format	→ 195
▶ Process parameters	→ 196
Temperature damping	→ 196
Conductivity damping	→ 196
Total solids override	→ 196
▶ Total solids monitoring	→ 196
Assign process variable	→ 196
Lower range limit	→ 196

Upper range limit	→  196
Response time	→  196
▶ Partially filled pipe detection	→  196
Partially filled pipe detection	→  196
Threshold	→  196
Response time	→  196
▶ External process variables	→  196
Volume flow source	→  196
Volume flow	→  196
▶ Sensor adjustment	→  196
Measuring interval	→  196
▶ Process variable adjustment	→  197
Temperature offset	→  197
Temperature factor	→  197
Conductivity offset	→  197
Conductivity factor	→  197
Corrected conductivity offset	→  197
Corrected conductivity factor	→  197
Electronics temperature offset	→  197
Electronics temperature factor	→  197
Load rate offset	→  197
Load rate factor	→  197
▶ Factory adjustment	→  197
Nominal diameter	→  197
Date/time	→  197

▶ I/O configuration	→ 197
I/O module 1 to n terminal numbers	→ 197
I/O module 1 to n information	→ 197
I/O module 1 to n type	→ 197
Apply I/O configuration	→ 197
I/O alteration code	→ 197
▶ Input	→ 198
▶ Current input 1 to n	→ 198
Terminal number	→ 198
Signal mode	→ 198
Current span	→ 198
0/4 mA value	→ 198
20 mA value	→ 198
Failure mode	→ 198
Failure value	→ 198
▶ Status input 1 to n	→ 198
Terminal number	→ 198
Assign status input	→ 198
Value status input	→ 198
Active level	→ 198
Response time status input	→ 198
▶ Output	→ 199
▶ Current output 1 to n	→ 199
Terminal number	→ 199
Signal mode	→ 199

























Process variable current output	→ 199
Current range output	→ 199
Fixed current	→ 199
Lower range value output	→ 199
Upper range value output	→ 199
Measuring mode current output	→ 199
Damping current output	→ 199
Failure behavior current output	→ 199
Failure current	→ 199
Output current	→ 199
Measured current	→ 199
► Pulse/frequency/switch output 1 to n	→ 200
Terminal number	→ 200
Signal mode	→ 200
Operating mode	→ 200
Assign pulse output	→ 200
Pulse scaling	→ 200
Pulse width	→ 200
Measuring mode	→ 200
Failure mode	→ 200
Pulse output	→ 200
Assign frequency output	→ 200
Minimum frequency value	→ 200
Maximum frequency value	→ 200

Measuring value at minimum frequency	→ 200
Measuring value at maximum frequency	→ 200
Measuring mode	→ 200
Damping output	→ 200
Response time	→ 201
Failure mode	→ 201
Failure frequency	→ 201
Output frequency	→ 201
Switch output function	→ 201
Assign diagnostic behavior	→ 201
Assign limit	→ 201
Switch-on value	→ 201
Switch-off value	→ 201
Assign flow direction check	→ 201
Assign status	→ 201
Switch-on delay	→ 201
Switch-off delay	→ 201
Failure mode	→ 201
Switch state	→ 201
Invert output signal	→ 201
► Relay output 1 to n	→ 202
Terminal number	→ 202
Relay output function	→ 202
Assign flow direction check	→ 202

Assign limit	→  202
Assign diagnostic behavior	→  202
Assign status	→  202
Switch-off value	→  202
Switch-off delay	→  202
Switch-on value	→  202
Switch-on delay	→  202
Failure mode	→  202
Switch state	→  202
Powerless relay status	→  202
► Communication	→  203
► Modbus configuration	→  203
Bus address	→  203
Baudrate	→  203
Data transfer mode	→  203
Parity	→  203
Byte order	→  203
Telegram delay	→  203
Failure mode	→  203
Bus termination	→  203
Fieldbus writing access	→  203
► Modbus information	→  203
Device ID	→  203
Device revision	→  203

▶ Modbus data map	→ 204
Scan list register 0 to 15	→ 204
▶ Web server	→ 204
Web server language	→ 204
MAC address	→ 204
DHCP client	→ 204
IP address	→ 204
Subnet mask	→ 204
Default gateway	→ 204
Web server functionality	→ 204
Login page	→ 204
▶ Application	→ 205
Reset all totalizers	→ 205
▶ Totalizer 1	→ 205
Assign process variable 1	→ 205
Process variable unit 1	→ 205
Totalizer 1 operation mode	→ 205
Totalizer 1 control	→ 205
Preset value 1	→ 205
Totalizer 1 failure behavior	→ 205
▶ Diagnostics	→ 205
Actual diagnostics	→ 205
Previous diagnostics	→ 205
Operating time from restart	→ 205
Operating time	→ 205

► Diagnostic list	→ 📄 206
Diagnostics 1	→ 📄 206
Diagnostics 2	→ 📄 206
Diagnostics 3	→ 📄 206
Diagnostics 4	→ 📄 206
Diagnostics 5	→ 📄 206
► Event logbook	→ 📄 206
Filter options	→ 📄 206
► Device information	→ 📄 206
Device tag	→ 📄 206
Serial number	→ 📄 206
Firmware version	→ 📄 206
Device name	→ 📄 206
Order code	→ 📄 206
Extended order code 1	→ 📄 206
Extended order code 2	→ 📄 206
Extended order code 3	→ 📄 206
ENP version	→ 📄 206
► Main electronic module + I/O module 1	→ 📄 207
Firmware version	→ 📄 207
Build no. software	→ 📄 207
Bootloader revision	→ 📄 207
► Sensor electronic module (ISEM)	→ 📄 207
Firmware version	→ 📄 207

Build no. software	→  207
Bootloader revision	→  207
▶ I/O module 2	→  207
I/O module 2 terminal numbers	→  207
Firmware version	→  207
Build no. software	→  207
Bootloader revision	→  207
▶ I/O module 3	→  207
I/O module 3 terminal numbers	→  207
Firmware version	→  207
Build no. software	→  207
Bootloader revision	→  207
▶ I/O module 4	→  208
I/O module 4 terminal numbers	→  208
Firmware version	→  208
Build no. software	→  208
Bootloader revision	→  208
▶ Display module	→  208
Firmware version	→  208
Build no. software	→  208
Bootloader revision	→  208
▶ Data logging	→  208
Assign channel 1	→  208
Assign channel 2	→  208
Assign channel 3	→  208

Assign channel 4	→ 📄 208
Logging interval	→ 📄 208
Clear logging data	→ 📄 208
Data logging	→ 📄 208
Logging delay	→ 📄 208
Data logging control	→ 📄 208
Data logging status	→ 📄 209
Entire logging duration	→ 📄 209
▶ Min/max values	→ 📄 209
▶ Electronics temperature	→ 📄 209
▶ Main electronics temperature	→ 📄 209
Maximum value	→ 📄 209
Minimum value	→ 📄 209
▶ Sensor electronics temperature (ISEM)	→ 📄 209
Maximum value	→ 📄 209
Minimum value	→ 📄 209
▶ Medium temperature	→ 📄 209
Maximum value	→ 📄 209
Minimum value	→ 📄 209
▶ Total solids	→ 📄 209

Maximum value	→ 209
Minimum value	→ 209
► Conductivity	→ 209
Maximum value	→ 209
Minimum value	→ 209
► Heartbeat Technology	→ 210
► Simulation	→ 210
Assign simulation process variable	→ 210
Process variable value	→ 210
Current input 1 to n simulation	→ 210
Value current input 1 to n	→ 210
Status input 1 to n simulation	→ 210
Input signal level 1 to n	→ 210
Current output 1 to n simulation	→ 210
Current output value	→ 210
Frequency output 1 to n simulation	→ 210
Frequency output 1 to n value	→ 210
Pulse output simulation 1 to n	→ 210
Pulse value 1 to n	→ 210
Switch output simulation 1 to n	→ 210
Switch state 1 to n	→ 210
Relay output 1 to n simulation	→ 210
Switch state 1 to n	→ 210
Device alarm simulation	→ 210

Diagnostic event category	→ 📄 211
Diagnostic event simulation	→ 📄 211



5.3 Register information

Navigation: Expert					
Parameter	Register	Data type	Access	Selection / User entry / User interface	→ 
Locking status	4918	Integer	Read	256 = Hardware locked 512 = Temporarily locked	11
User role	2178	Integer	Read	1 = Maintenance 2 = Service	12
Enter access code	2177	Integer	Read / Write	Max. 16-digit character string comprising numbers, letters and special characters	13

5.3.1 "System" submenu

"Display" submenu

Navigation: Expert → System → Display					
Parameter	Register	Data type	Access	Selection / User entry / User interface	→ 
Display language	3673	Integer	Read / Write	0 = English 1 = Deutsch 2 = Français 3 = Español 4 = Italiano 5 = Nederlands 8 = Svenska 11 = 日本語 (Japanese) 12 = Portuguesa 13 = Polski 14 = русский язык (Russian) 15 = čeština (Czech) 16 = 中文 (Chinese) 18 = Türkçe 20 = 한국어 (Korean)	23
Format display	3625	Integer	Read / Write	0 = 1 value, max. size 1 = 1 bargraph + 1 value 2 = 2 values 3 = 1 value large + 2 values 4 = 4 values	14
Value 1 display	3963	Integer	Read / Write	4 = Conductivity 6 = Total solids 6 = Temperature 7 = Load rate * 8 = Corrected conductivity 9 = Totalizer 1 * 39 = Electronics temperature 121 = Current output 1 * 122 = Current output 2 * 123 = Current output 3 * 124 = Current output 4 *	17
0% bargraph value 1	4136 to 4137	Float	Read / Write	Signed floating-point number	17
100% bargraph value 1	4142 to 4143	Float	Read / Write	Signed floating-point number	18
Decimal places 1	3365	Integer	Read / Write	0 = x 1 = x.x 2 = x.xx 3 = x.xxx 4 = x.xxxx	18

Navigation: Expert → System → Display					
Parameter	Register	Data type	Access	Selection / User entry / User interface	→ 
Value 2 display	3964	Integer	Read / Write	4 = Conductivity 6 = Total solids 6 = Temperature 7 = Load rate * 8 = Corrected conductivity 9 = Totalizer 1 * 39 = Electronics temperature 121 = Current output 1 * 122 = Current output 2 * 123 = Current output 3 * 124 = Current output 4 * 251 = None	19
Decimal places 2	4049	Integer	Read / Write	0 = x 1 = x.x 2 = x.xx 3 = x.xxx 4 = x.xxxx	19
Value 3 display	3966	Integer	Read / Write	For the picklist, see Value 1 display parameter (→  17)	20
0% bargraph value 3	4138 to 4139	Float	Read / Write	Signed floating-point number	20
100% bargraph value 3	4140 to 4141	Float	Read / Write	Signed floating-point number	21
Decimal places 3	4050	Integer	Read / Write	0 = x 1 = x.x 2 = x.xx 3 = x.xxx 4 = x.xxxx	21
Value 4 display	3965	Integer	Read / Write	For the picklist, see Value 1 display parameter (→  17)	22
Decimal places 4	4051	Integer	Read / Write	0 = x 1 = x.x 2 = x.xx 3 = x.xxx 4 = x.xxxx	22
Display interval	3604 to 3605	Float	Read / Write	1 to 10 s	29
Display damping	3554 to 3555	Float	Read / Write	0.0 to 999.9 s	29
Header	3624	Integer	Read / Write	0 = Device tag 1 = Free text	30
Header text	3968 to 3973	String	Read / Write	Max. 12 characters, such as letters, numbers or special characters (e.g. @, %, /)	30
Separator	3671	Integer	Read / Write	▪ . (point) ▪ , (comma)	31
Contrast display	3674 to 3675	Float	Read / Write	20 to 80 %	31
Backlight	3967	Integer	Read / Write	0 = Disable 1 = Enable	31

* Visibility depends on order options or device settings

"Configuration backup" submenu

Navigation: Expert → System → Configuration backup					
Parameter	Register	Data type	Access	Selection / User entry / User interface	→
Operating time	2631	String	Read	Days (d), hours (h), minutes (m) and seconds (s)	32
Last backup	6430	String	Read	Days (d), hours (h), minutes (m) and seconds (s)	32
Configuration management	5500	Integer	Read / Write	0 = Cancel 1 = Execute backup 2 = Restore * 4 = Clear backup data 5 = Compare *	33
Backup state	5502	Integer	Read	1 = Backup in progress 2 = Restoring in progress 4 = Delete in progress 5 = Compare in progress 6 = Restoring failed 7 = Backup failed 251 = None	33
Comparison result	5514	Integer	Read	0 = Settings identical 1 = Settings not identical 2 = No backup available 3 = Check not done 4 = Backup settings corrupt 5 = Dataset incompatible	34

* Visibility depends on order options or device settings

"Diagnostic handling" submenu

Navigation: Expert → System → Diagnostic handling					
Parameter	Register	Data type	Access	Selection / User entry / User interface	→
Alarm delay	6808 to 6809	Float	Read / Write	0 to 60 s	35

"Diagnostic behavior" submenu

Navigation: Expert → System → Diagnostic handling → Diagnostic behavior					
Parameter	Register	Data type	Access	Selection / User entry / User interface	→
Assign behavior of diagnostic no. 302	6484	Integer	Read / Write	0 = Off 1 = Logbook entry only 2 = Warning	38
Assign behavior of diagnostic no. 444	5120	Integer	Read / Write	0 = Off 1 = Logbook entry only 2 = Warning 3 = Alarm	37
Assign behavior of diagnostic no. 441	4742	Integer	Read / Write	0 = Off 1 = Logbook entry only 2 = Warning 3 = Alarm	36
Assign behavior of diagnostic no. 442	4919	Integer	Read / Write	0 = Off 1 = Logbook entry only 2 = Warning 3 = Alarm	37

Navigation: Expert → System → Diagnostic handling → Diagnostic behavior					
Parameter	Register	Data type	Access	Selection / User entry / User interface	→ 
Assign behavior of diagnostic no. 443	5000	Integer	Read / Write	0 = Off 1 = Logbook entry only 2 = Warning 3 = Alarm	37
Assign behavior of diagnostic no. 832	6440	Integer	Read / Write	0 = Off 1 = Logbook entry only 2 = Warning 3 = Alarm	38
Assign behavior of diagnostic no. 833	6439	Integer	Read / Write	0 = Off 1 = Logbook entry only 2 = Warning 3 = Alarm	39
Assign behavior of diagnostic no. 834	6438	Integer	Read / Write	0 = Off 1 = Logbook entry only 2 = Warning 3 = Alarm	39
Assign behavior of diagnostic no. 835	6437	Integer	Read / Write	0 = Off 1 = Logbook entry only 2 = Warning 3 = Alarm	39
Assign behavior of diagnostic no. 907	48428	Integer	Read / Write	0 = Off 1 = Logbook entry only 2 = Warning 3 = Alarm	40
Assign behavior of diagnostic no. 908	48440	Integer	Read / Write	0 = Off 1 = Logbook entry only 2 = Warning 3 = Alarm	40

"Administration" submenu

Navigation: Expert → System → Administration					
Parameter	Register	Data type	Access	Selection / User entry / User interface	→ 
Device reset	6817	Integer	Read / Write	0 = Cancel 1 = Restart device 2 = To delivery settings 25 = Restore S-DAT backup *	43
Transmitter identifier	4510	Integer	Read	0 = Unknown 1 = 300 2 = 500	44
Activate SW option	2795	Integer	Read / Write	Max. 10-digit string of numbers.	44
Software option overview	2902	Integer	Read		45

* Visibility depends on order options or device settings

"Define access code" wizard

Navigation: Expert → System → Administration → Define access code					
Parameter	Register	Data type	Access	Selection / User entry / User interface	→ 
Define access code	8677 to 8684	String	Read / Write	Max. 16-digit character string comprising numbers, letters and special characters	41
Confirm access code	8685 to 8692	String	Read / Write	Max. 16-digit character string comprising numbers, letters and special characters	42

"Reset access code" submenu

Navigation: Expert → System → Administration → Reset access code					
Parameter	Register	Data type	Access	Selection / User entry / User interface	→ 
Operating time	2631	String	Read	Days (d), hours (h), minutes (m) and seconds (s)	42
Reset access code	8880 to 8895	String	Read / Write	Character string comprising numbers, letters and special characters	42

5.3.2 "Sensor" submenu**"Measured values" submenu***"Process variables" submenu*

Navigation: Expert → Sensor → Measured values → Process variables					
Parameter	Register	Data type	Access	Selection / User entry / User interface	→ 
Total solids	52245 to 52246	Float	Read	Signed floating-point number	46
Temperature	2017 to 2018	Float	Read	Signed floating-point number	46
Electronics temperature	2271 to 2272	Float	Read	Signed floating-point number	46
Conductivity	2099 to 2100	Float	Read	Floating-point number	47
Corrected conductivity	3977 to 3978	Float	Read	Floating-point number	47
Load rate	52263 to 52264	Float	Read	Signed floating-point number	47

"Totalizer" submenu

Navigation: Expert → Sensor → Measured values → Totalizer					
Parameter	Register	Data type	Access	Selection / User entry / User interface	→ 
Totalizer 1 value	2610 to 2611	Float	Read	Signed floating-point number	48
Totalizer 1 overflow	2612 to 2613	Float	Read	Integer with sign	48

*"Input values" submenu**"Current input 1 to n" submenu*

Navigation: Expert → Sensor → Measured values → Input values → Current input 1 to n					
Parameter	Register	Data type	Access	Selection / User entry / User interface	→ 
Measured values 1 to n	1: 6151 to 6152 2: 6153 to 6154 3: 6155 to 6156	Float	Read	Signed floating-point number	49
Measured current 1 to n	1: 6131 to 6132 2: 6133 to 6134 3: 6135 to 6136	Float	Read	0 to 22.5 mA	49

"Value status input 1 to n" submenu

Navigation: Expert → Sensor → Measured values → Input values → Value status input 1 to n					
Parameter	Register	Data type	Access	Selection / User entry / User interface	→ 
Value status input	1: 2746 2: 4699 3: 4700	Integer	Read	0 = Low 1 = High	50

*"Output values" submenu**"Value current output 1 to n" submenu*

Navigation: Expert → Sensor → Measured values → Output values → Value current output 1 to n					
Parameter	Register	Data type	Access	Selection / User entry / User interface	→ 
Output current	1: 5931 to 5932 2: 5933 to 5934 3: 5935 to 5936	Float	Read	0 to 22.5 mA	50
Measured current	1: 5779 to 5780 2: 5781 to 5782 3: 5783 to 5784	Float	Read	0 to 30 mA	51

"Pulse/frequency/switch output 1 to n" submenu

Navigation: Expert → Sensor → Measured values → Output values → Pulse/frequency/switch output 1 to n					
Parameter	Register	Data type	Access	Selection / User entry / User interface	→ 
Output frequency	1: 3462 to 3463 2: 3464 to 3465 3: 9910 to 9911	Float	Read	0.0 to 12 500.0 Hz	51
Pulse output	1: 3082 to 3083 2: 3084 to 3085 3: 4718 to 4719	Float	Read	Positive floating-point number	51
Switch state	1: 2485 2: 2486 3: 9917	Integer	Read	1 = Open 6 = Closed	52

"Relay output 1 to n" submenu

Navigation: Expert → Sensor → Measured values → Output values → Relay output 1 to n					
Parameter	Register	Data type	Access	Selection / User entry / User interface	→ 
Switch state	1: 3518 2: 3519 3: 9875	Integer	Read	1 = Open 6 = Closed	53
Switch cycles	1: 7625 2: 7627 3: 7629	Integer	Read	Positive integer	53
Max. switch cycles number	1: 21919 2: 21921 3: 21923	Integer	Read	Positive integer	53

"System units" submenu

Navigation: Expert → Sensor → System units					
Parameter	Register	Data type	Access	Selection / User entry / User interface	→ 
Total solids unit	52093	Integer	Read / Write	= 4 = kg/m ³ 11 = lb/ft ³ 12 = lb/gal (us) 22 = mg/cm ³ 97 = g/l 139 = ppm 170 = mg/l	54
Density unit	2107	Integer	Read / Write	4 = kg/m ³ 11 = lb/ft ³ 12 = lb/gal (us) 22 = mg/cm ³ 97 = g/l 170 = mg/l	55
Mass flow unit	2101	Integer	Read / Write	6 = kg/h 7 = kg/d 10 = t/h 11 = t/d 14 = oz/h 15 = oz/d 18 = lb/h 19 = lb/d 22 = STon/h 23 = STon/d	55
Mass unit	2102	Integer	Read / Write	51 = kg 52 = t 53 = oz 54 = lb 55 = STon	55
Volume flow unit	2103	Integer	Read / Write	5 = dm ³ /min 8 = m ³ /s 10 = m ³ /h 16 = l/s 18 = l/h	56
Temperature unit	2109	Integer	Read / Write	0 = °C 1 = K 2 = °F 3 = °R	56
Conductivity unit	2121	Integer	Read / Write	3 = S/m 4 = S/cm 5 = mS/m 7 = μS/m 9 = μS/mm 10 = nS/cm 66 = mS/cm 67 = μS/cm	56
Date/time format	2150	Integer	Read / Write	0 = dd.mm.yy hh:mm 1 = mm/dd/yy hh:mm am/pm 2 = dd.mm.yy hh:mm am/pm 3 = mm/dd/yy hh:mm	57

"Process parameters" submenu

Navigation: Expert → Sensor → Process parameters					
Parameter	Register	Data type	Access	Selection / User entry / User interface	→
Temperature damping	30006 to 30007	Float	Read / Write	0 to 999.9 s	57
Conductivity damping	46420 to 46421	Float	Read / Write	0 to 999.9 s	58
Total solids override	29992	Integer	Read / Write	0 = Off 1 = On	58

"Total solids monitoring" submenu

Navigation: Expert → Sensor → Process parameters → Total solids monitoring					
Parameter	Register	Data type	Access	Selection / User entry / User interface	→
Assign process variable	48877	Integer	Read / Write	0 = Off 6 = Total solids	58
Lower range limit	50894 to 50895	Float	Read / Write	Signed floating-point number	59
Upper range limit	50898 to 50899	Float	Read / Write	Signed floating-point number	59
Response time	50896 to 50897	Float	Read / Write	0 to 100 s	59

"Partially filled pipe detection" submenu

Navigation: Expert → Sensor → Process parameters → Partially filled pipe detection					
Parameter	Register	Data type	Access	Selection / User entry / User interface	→
Partially filled pipe detection	52238	Integer	Read / Write	0 = Off 1 = On	60
Threshold	52236 to 52237	Float	Read / Write	Decibel as negative floating point number	60
Response time	52239 to 52240	Float	Read / Write	0 to 20.0 s	60

"External process variables" submenu

Navigation: Expert → Sensor → External process variables					
Parameter	Register	Data type	Access	Selection / User entry / User interface	→
Volume flow source	48284	Integer	Read / Write	0 = Off 2 = External value 11 = Current input 1 * 12 = Current input 2 * 13 = Current input 3 *	61
Volume flow	50100 to 50101	Float	Read / Write	Signed floating-point number	61

* Visibility depends on order options or device settings

"Sensor adjustment" submenu

Navigation: Expert → Sensor → Sensor adjustment					
Parameter	Register	Data type	Access	Selection / User entry / User interface	→
Measuring interval	31066 to 31067	Float	Read	0 to 10000 ms	62

"Process variable adjustment" submenu

Navigation: Expert → Sensor → Sensor adjustment → Process variable adjustment					
Parameter	Register	Data type	Access	Selection / User entry / User interface	→ 
Temperature offset	29988 to 29989	Float	Read / Write	Signed floating-point number	63
Temperature factor	48221 to 48222	Float	Read / Write	Positive floating-point number	63
Conductivity offset	29990 to 29991	Float	Read / Write	Signed floating-point number	63
Conductivity factor	48869 to 48870	Float	Read / Write	Positive floating-point number	63
Corrected conductivity offset	25094 to 25095	Float	Read / Write	Signed floating-point number	64
Corrected conductivity factor	29976 to 29977	Float	Read / Write	Positive floating-point number	64
Electronics temperature offset	46301 to 46302	Float	Read / Write	Signed floating-point number	64
Electronics temperature factor	46303 to 46304	Float	Read / Write	Positive floating-point number	64
Load rate offset	48873 to 48874	Float	Read / Write	Signed floating-point number	65
Load rate factor	46448 to 46449	Float	Read / Write	Positive floating-point number	65

"Factory adjustment" submenu

Navigation: Expert → Sensor → Factory adjustment					
Parameter	Register	Data type	Access	Selection / User entry / User interface	→ 
Nominal diameter	2048 to 2057	String	Read	Character string comprising numbers, letters and special characters	65
Date/time	10166 to 10175	String	Read	Character string comprising numbers, letters and special characters	66

5.3.3 "I/O configuration" submenu

Navigation: Expert → I/O configuration					
Parameter	Register	Data type	Access	Selection / User entry / User interface	→ 
I/O module 1 to n terminal numbers	1: 6541 2: 6542 3: 6543 4: 6544	Integer	Read	0 = Not used 1 = 26-27 (I/O 1) 2 = 24-25 (I/O 2) 3 = 22-23 (I/O 3) 4 = 20-21 (I/O 4)	66
I/O module 1 to n information	1: 8659 2: 8660 3: 8661 4: 8662	Integer	Read	1 = MODBUS 2 = Configurable 3 = Not configurable 254 = Not plugged 255 = Invalid	66
I/O module 1 to n type	1: 6417 2: 6418 3: 6419 4: 6420	Integer	Read / Write	0 = Off 1 = Current output * 2 = Current input * 3 = Pulse/frequency/switch output * 5 = Status input * 6 = Relay output *	67
Apply I/O configuration	8665	Integer	Read / Write	0 = Yes 1 = No	67
I/O alteration code	6427	Integer	Read / Write	Positive integer	68

* Visibility depends on order options or device settings

5.3.4 "Input" submenu

"Current input 1 to n" submenu

Navigation: Expert → Input → Current input 1 to n					
Parameter	Register	Data type	Access	Selection / User entry / User interface	→ 
Terminal number	1: 6548 2: 6549 3: 6550	Integer	Read	0 = Not used 2 = 24-25 (I/O 2) 3 = 22-23 (I/O 3) 4 = 20-21 (I/O 4)	69
Signal mode	1: 6424 2: 6425 3: 6426	Integer	Read / Write	0 = Passive 2 = Active*	69
Current span	1: 6147 2: 6148 3: 6149	Integer	Read / Write	0 = 4...20 mA (4...20.5 mA) 1 = 4...20 mA US (3.9...20.8 mA) 2 = 4...20 mA NE (3.8...20.5 mA) (+) 3 = 0...20 mA (0...20.5 mA)	69
0/4 mA value	1: 6111 to 6112 2: 6113 to 6114 3: 6115 to 6116	Float	Read / Write	Signed floating-point number	70
20 mA value	1: 6119 to 6120 2: 6121 to 6122 3: 6123 to 6124	Float	Read / Write	Signed floating-point number	70
Failure mode	1: 6159 2: 6160 3: 6161	Integer	Read / Write	1 = Last valid value 2 = Alarm 6 = Defined value	71
Failure value	1: 6163 to 6164 2: 6165 to 6166 3: 6167 to 6168	Float	Read / Write	Signed floating-point number	71

* Visibility depends on order options or device settings

"Status input 1 to n" submenu

Navigation: Expert → Input → Status input 1 to n					
Parameter	Register	Data type	Access	Selection / User entry / User interface	→ 
Terminal number	1: 6554 2: 6555 3: 6556	Integer	Read	0 = Not used 2 = 24-25 (I/O 2) 3 = 22-23 (I/O 3) 4 = 20-21 (I/O 4)	72
Assign status input	1: 2506 2: 4687 3: 4688	Integer	Read / Write	0 = Off 1 = Flow override 3 = Reset totalizer 1	72
Value status input	1: 2746 2: 4699 3: 4700	Integer	Read	0 = Low 1 = High	73
Active level	1: 2530 2: 4690 3: 4691	Integer	Read / Write	0 = Low 1 = High	73
Response time status input	1: 3404 to 3405 2: 5753 to 5754 3: 5755 to 5756	Float	Read / Write	5 to 200 ms	73

5.3.5 "Output" submenu

"Current output 1 to n" submenu

Navigation: Expert → Output → Current output 1 to n					
Parameter	Register	Data type	Access	Selection / User entry / User interface	→ 
Terminal number	1: 6545 2: 6546 3: 6547	Integer	Read	0 = Not used 2 = 24-25 (I/O 2) 3 = 22-23 (I/O 3) 4 = 20-21 (I/O 4)	74
Signal mode	1: 6421 2: 6422 3: 6423	Integer	Read / Write	0 = Passive* 2 = Active*	75
Process variable current output	1: 5927 2: 5928 3: 5929	Integer	Read / Write	0 = Off 4 = Conductivity 6 = Total solids 6 = Temperature 7 = Load rate* 8 = Corrected conductivity 39 = Electronics temperature	75
Current range output	1: 5923 2: 5924 3: 5925	Integer	Read / Write	0 = 4...20 mA (4...20.5 mA) 1 = 4...20 mA US (3.9...20.8 mA) 2 = 4...20 mA NE (3.8...20.5 mA) 3 = 0...20 mA (0...20.5 mA) 4 = Fixed value	75
Fixed current	1: 5987 to 5988 2: 5989 to 5990 3: 5991 to 5992	Float	Read / Write	0 to 22.5 mA	76
Lower range value output	1: 6195 to 6196 2: 6197 to 6198 3: 6199 to 6200	Float	Read / Write	Floating point number with sign	77
Upper range value output	1: 5915 to 5916 2: 5917 to 5918 3: 5919 to 5920	Float	Read / Write	Floating point number with sign	78
Measuring mode current output	1: 5899 2: 5900 3: 5901	Integer	Read / Write	0 = Forward flow 2 = Reverse flow compensation 13 = Forward/Reverse flow*	78
Damping current output	1: 5903 to 5904 2: 5905 to 5906 3: 5907 to 5908	Float	Read / Write	0.0 to 999.9 s	83
Failure behavior current output	1: 5911 2: 5912 3: 5913	Integer	Read / Write	0 = Min. 1 = Max. 4 = Actual value 5 = Last valid value 6 = Fixed value	83
Failure current	1: 5979 to 5980 2: 5981 to 5982 3: 5983 to 5984	Float	Read / Write	0 to 22.5 mA	84
Output current	1: 5931 to 5932 2: 5933 to 5934 3: 5935 to 5936	Float	Read	3.59 to 22.5 mA	84
Measured current	1: 5779 to 5780 2: 5781 to 5782 3: 5783 to 5784	Float	Read	0 to 30 mA	85

* Visibility depends on order options or device settings

"Pulse/frequency/switch output 1 to n" submenu

Navigation: Expert → Output → Pulse/frequency/switch output 1 to n					
Parameter	Register	Data type	Access	Selection / User entry / User interface	→ 
Terminal number	1: 6551 2: 6552 3: 6553	Integer	Read	0 = Not used 2 = 24-25 (I/O 2) 3 = 22-23 (I/O 3) 4 = 20-21 (I/O 4)	86
Signal mode	1: 6235 2: 6236 3: 6237	Integer	Read / Write	0 = Passive 2 = Active* 3 = Passive NE	87
Operating mode	1: 4479 2: 4480 3: 9907	Integer	Read / Write	0 = Pulse 1 = Switch 53 = Frequency	87
Assign pulse output	1: 2461 2: 2462 3: 4685	Integer	Read / Write	0 = Off 7 = Load rate*	88
Pulse scaling	1: 3034 to 3035 2: 3036 to 3037 3: 4714 to 4715	Float	Read / Write	Positive floating point number	89
Pulse width	1: 2836 to 2837 2: 2838 to 2839 3: 4702 to 4703	Float	Read / Write	0.05 to 2 000 ms	89
Measuring mode	1: 2394 2: 2395 3: 4683	Integer	Read / Write	0 = Forward flow 1 = Reverse flow 2 = Reverse flow compensation 13 = Forward/Reverse flow	90
Failure mode	1: 2948 2: 2949 3: 4708	Integer	Read / Write	0 = Actual value 1 = No pulses	91
Pulse output	1: 3082 to 3083 2: 3084 to 3085 3: 4718 to 4719	Float	Read	Positive floating-point number	91
Assign frequency output	1: 2614 2: 2615 3: 9915	Integer	Read / Write	0 = Off 4 = Conductivity 6 = Total solids 6 = Temperature 7 = Load rate* 8 = Corrected conductivity 39 = Electronics temperature	92
Minimum frequency value	1: 3526 to 3527 2: 3528 to 3529 3: 5767 to 5768	Float	Read / Write	0.0 to 10 000.0 Hz	92
Maximum frequency value	1: 2996 to 2997 2: 2998 to 2999 3: 4710 to 4711	Float	Read / Write	0.0 to 10 000.0 Hz	93
Measuring value at minimum frequency	1: 5887 to 5888 2: 5889 to 5890 3: 5891 to 5892	Float	Read / Write	Signed floating-point number	93
Measuring value at maximum frequency	1: 3514 to 3515 2: 3516 to 3517 3: 5759 to 5760	Float	Read / Write	Signed floating-point number	93
Measuring mode	1: 2922 2: 2923 3: 4706	Integer	Read / Write	0 = Forward flow 2 = Reverse flow compensation 13 = Forward/Reverse flow	94
Damping output	1: 3522 to 3523 2: 3524 to 3525 3: 5763 to 5764	Float	Read / Write	0 to 999.9 s	94

Navigation: Expert → Output → Pulse/frequency/switch output 1 to n					
Parameter	Register	Data type	Access	Selection / User entry / User interface	→ 
Response time	1: 5875 to 5876 2: 5877 to 5878 3: 5879 to 5880	Float	Read	Positive floating-point number	95
Failure mode	1: 2367 2: 2368 3: 4681	Integer	Read / Write	0 = Actual value 1 = 0 Hz 2 = Defined value	95
Failure frequency	1: 3510 to 3511 2: 3512 to 3513 3: 9908 to 9909	Float	Read / Write	0.0 to 12 500.0 Hz	96
Output frequency	1: 3462 to 3463 2: 3464 to 3465 3: 9910 to 9911	Float	Read	0.0 to 12 500.0 Hz	96
Switch output function	1: 3022 2: 3023 3: 9914	Integer	Read / Write	0 = Off 1 = On 2 = Diagnostic behavior 3 = Flow direction check 4 = Limit 5 = Status	96
Assign diagnostic behavior	1: 3096 2: 3097 3: 9913	Integer	Read / Write	0 = Alarm 1 = Warning 2 = Alarm or warning	97
Assign limit	1: 3184 2: 3185 3: 4722	Integer	Read / Write	0 = Off 4 = Conductivity 6 = Total solids 6 = Temperature 7 = Load rate * 8 = Corrected conductivity 16 = Totalizer 1 * 39 = Electronics temperature	98
Switch-on value	1: 3242 to 3243 2: 3244 to 3245 3: 4728 to 4729	Float	Read / Write	Floating point number with sign	100
Switch-off value	1: 3234 to 3235 2: 3236 to 3237 3: 4724 to 4725	Float	Read / Write	Floating point number with sign	100
Assign flow direction check	1: 3363 2: 3364 3: 4732	Integer	Read / Write		101
Assign status	1: 3374 2: 3375 3: 4734	Integer	Read / Write	0 = Off 1 = Partially filled pipe detection	101
Switch-on delay	1: 6247 to 6248 2: 6249 to 6250 3: 6251 to 6252	Float	Read / Write	0.0 to 100.0 s	101
Switch-off delay	1: 6239 to 6240 2: 6241 to 6242 3: 6243 to 6244	Float	Read / Write	0.0 to 100.0 s	102
Failure mode	1: 3384 2: 3385 3: 9912	Integer	Read / Write	0 = Actual status 1 = Open 6 = Closed	102
Switch state	1: 2485 2: 2486 3: 9917	Integer	Read	1 = Open 6 = Closed	102
Invert output signal	1: 2583 2: 2584 3: 9916	Integer	Read / Write	0 = Yes 1 = No	103

* Visibility depends on order options or device settings

"Relay output 1 to n" submenu

Navigation: Expert → Output → Relay output 1 to n					
Parameter	Register	Data type	Access	Selection / User entry / User interface	→ 
Terminal number	1: 8278 2: 8279 3: 8280	Integer	Read	0 = Not used 2 = 24-25 (I/O 2) 3 = 22-23 (I/O 3) 4 = 20-21 (I/O 4)	104
Relay output function	1: 2488 2: 2489 3: 9876	Integer	Read / Write	1 = Open 2 = Diagnostic behavior 3 = Flow direction check 4 = Limit 5 = Status 6 = Closed	104
Assign flow direction check	1: 8251 2: 8252 3: 8253	Integer	Read / Write		105
Assign limit	1: 8248 2: 8249 3: 8250	Integer	Read / Write	0 = Off 4 = Conductivity 6 = Total solids 6 = Temperature 7 = Load rate * 8 = Corrected conductivity 16 = Totalizer 1 * 39 = Electronics temperature	105
Assign diagnostic behavior	1: 8245 2: 8246 3: 8247	Integer	Read / Write	0 = Alarm 1 = Warning 2 = Alarm or warning	106
Assign status	1: 8272 2: 8273 3: 8274	Integer	Read / Write	0 = Off 1 = Partially filled pipe detection	106
Switch-off value	1: 8260 to 8261 2: 8262 to 8263 3: 8264 to 8265	Float	Read / Write	Floating point number with sign	107
Switch-off delay	1: 8254 to 8255 2: 8256 to 8257 3: 8258 to 8259	Float	Read / Write	0.0 to 100.0 s	107
Switch-on value	1: 8233 to 8234 2: 8235 to 8236 3: 8237 to 8238	Float	Read / Write	Floating point number with sign	107
Switch-on delay	1: 8266 to 8267 2: 8268 to 8269 3: 8270 to 8271	Float	Read / Write	0.0 to 100.0 s	108
Failure mode	1: 8242 2: 8243 3: 8244	Integer	Read / Write	0 = Actual status 1 = Open 6 = Closed	108
Switch state	1: 3518 2: 3519 3: 9875	Integer	Read	1 = Open 6 = Closed	109
Powerless relay status	1: 7009 2: 7010 3: 7011	Integer	Read / Write	1 = Open 6 = Closed	109

* Visibility depends on order options or device settings

5.3.6 "Communication" submenu

"Modbus configuration" submenu

Navigation: Expert → Communication → Modbus configuration					
Parameter	Register	Data type	Access	Selection / User entry / User interface	→ 
Bus address	4910	Integer	Read / Write	1 to 247	110
Baudrate	4912	Integer	Read / Write	0 = 1200 BAUD 1 = 2400 BAUD 2 = 4800 BAUD 3 = 9600 BAUD 4 = 19200 BAUD 5 = 38400 BAUD 6 = 57600 BAUD 7 = 115200 BAUD 8 = 230400 BAUD	110
Data transfer mode	4913	Integer	Read / Write	0 = RTU 1 = ASCII	111
Parity	4914	Integer	Read / Write	0 = Even 1 = Odd 2 = None / 2 stop bits 3 = None / 1 stop bit	111
Byte order	4915	Integer	Read / Write	0 = 0-1-2-3 1 = 3-2-1-0 2 = 2-3-0-1 3 = 1-0-3-2	112
Telegram delay	4916 to 4917	Float	Read / Write	0 to 100 ms	113
Failure mode	4920	Integer	Read / Write	1 = Last valid value 255 = NaN value	113
Bus termination	5774	Integer	Read	0 = Off 1 = On	114
Fieldbus writing access	6807	Integer	Read / Write	0 = Read + write 1 = Read only	114

"Modbus information" submenu

Navigation: Expert → Communication → Modbus information					
Parameter	Register	Data type	Access	Selection / User entry / User interface	→ 
Device ID	2547	Integer	Read	4-digit hexadecimal number	115
Device revision	4481	Integer	Read	4-digit hexadecimal number	115

"Modbus data map" submenu

Navigation: Expert → Communication → Modbus data map					
Parameter	Register	Data type	Access	Selection / User entry / User interface	→ 
Scan list register 0 to 15	0: 5001 1: 5002 2: 5003 3: 5004 4: 5005 5: 5006 6: 5007 7: 5008 8: 5009 9: 5010 10: 5011 11: 5012 12: 5013 13: 5014 14: 5015 15: 5016	Integer	Read / Write	1 to 65 535	116

"Web server" submenu

Navigation: Expert → Communication → Web server					
Parameter	Register	Data type	Access	Selection / User entry / User interface	→ 
Web server language	4219	Integer	Read / Write	0 = English 1 = Deutsch 2 = Français 3 = Español 4 = Italiano 5 = Nederlands 8 = Svenska 11 = 日本語 (Japanese) 12 = Portuguesa 13 = Polski 14 = русский язык (Russian) 15 = čeština (Czech) 16 = 中文 (Chinese) 18 = Türkçe 20 = 한국어 (Korean)	117
MAC address	4210 to 4218	String	Read	Unique 12-digit character string comprising letters and numbers	117
DHCP client	21781	Integer	Read / Write	0 = Off 1 = On	117
IP address	4155 to 4162	String	Read / Write	4 octet: 0 to 255 (in the particular octet)	118
Subnet mask	4163 to 4170	String	Read / Write	4 octet: 0 to 255 (in the particular octet)	118
Default gateway	4171 to 4178	String	Read / Write	4 octet: 0 to 255 (in the particular octet)	118
Web server functionality	4220	Integer	Read / Write	0 = Off 1 = On 2 = HTML Off	119
Login page	5802	Integer	Read / Write	0 = Without header 1 = With header	119

5.3.7 "Application" submenu

Navigation: Expert → Application					
Parameter	Register	Data type	Access	Selection / User entry / User interface	→ 
Reset all totalizers	2609	Integer	Read / Write	0 = Cancel 1 = Reset + totalize	126

"Totalizer 1" submenu

Navigation: Expert → Application → Totalizer 1					
Parameter	Register	Data type	Access	Selection / User entry / User interface	→ 
Assign process variable 1	2601	Integer	Read / Write	0 = Off 7 = Load rate *	127
Process variable unit 1	4604	Integer	Read / Write	51 = kg 52 = t 53 = oz 54 = lb 55 = STon 251 = None *	128
Totalizer 1 operation mode	2605	Integer	Read / Write	0 = Net 1 = Forward 2 = Reverse	128
Totalizer 1 control	2608	Integer	Read / Write	0 = Totalize 1 = Reset + totalize 2 = Preset + hold 3 = Reset + hold 4 = Preset + totalize 5 = Hold	129
Preset value 1	2590 to 2591	Float	Read / Write	Signed floating-point number	130
Totalizer 1 failure behavior	2606	Integer	Read / Write	0 = Hold 1 = Continue 2 = Last valid value + continue	130

* Visibility depends on order options or device settings

5.3.8 "Diagnostics" submenu

Navigation: Expert → Diagnostics					
Parameter	Register	Data type	Access	Selection / User entry / User interface	→ 
Actual diagnostics	2732	Integer	Read	Symbol for diagnostic behavior, diagnostic code and short message.	131
Previous diagnostics	2734	Integer	Read	Symbol for diagnostic behavior, diagnostic code and short message.	132
Operating time from restart	2624	String	Read	Days (d), hours (h), minutes (m) and seconds (s)	133
Operating time	2631	String	Read	Days (d), hours (h), minutes (m) and seconds (s)	133

"Diagnostic list" submenu

Navigation: Expert → Diagnostics → Diagnostic list					
Parameter	Register	Data type	Access	Selection / User entry / User interface	→ 
Diagnostics 1	2736	Integer	Read	Symbol for diagnostic behavior, diagnostic code and short message.	134
Diagnostics 2	2738	Integer	Read	Symbol for diagnostic behavior, diagnostic code and short message.	134
Diagnostics 3	2740	Integer	Read	Symbol for diagnostic behavior, diagnostic code and short message.	135
Diagnostics 4	2742	Integer	Read	Symbol for diagnostic behavior, diagnostic code and short message.	135
Diagnostics 5	2744	Integer	Read	Symbol for diagnostic behavior, diagnostic code and short message.	136

"Event logbook" submenu

Navigation: Expert → Diagnostics → Event logbook					
Parameter	Register	Data type	Access	Selection / User entry / User interface	→ 
Filter options	4596	Integer	Read / Write	0 = Failure (F) 4 = Maintenance required (M) 8 = Function check (C) 12 = Out of specification (S) 16 = Information (I) 255 = All	136

"Device information" submenu

Navigation: Expert → Diagnostics → Device information					
Parameter	Register	Data type	Access	Selection / User entry / User interface	→ 
Device tag	2026 to 2041	String	Read	Max. 32 characters, such as letters, numbers or special characters (e.g. @, %, /).	138
Serial number	7003 to 7008	String	Read	Max. 11-digit character string comprising letters and numbers.	139
Firmware version	7277 to 7280	String	Read	Character string in the format xx.yy.zz	139
Device name	7238 to 7245	String	Read	Character string comprising numbers, letters and special characters	140
Order code	2058 to 2067	String	Read	Character string composed of letters, numbers and certain punctuation marks (e.g. /).	140
Extended order code 1	2212 to 2221	String	Read	Character string	140
Extended order code 2	2222 to 2231	String	Read	Character string	140
Extended order code 3	2232 to 2241	String	Read	Character string	141
ENP version	4003 to 4010	String	Read	Character string	141

"Main electronic module + I/O module 1" submenu

Navigation: Expert → Diagnostics → Main electronic module + I/O module 1					
Parameter	Register	Data type	Access	Selection / User entry / User interface	→ 
Firmware version	7039	Integer	Read	Positive integer	142
Build no. software	2326	Integer	Read	Positive integer	142
Bootloader revision	2264	Integer	Read	Positive integer	142

"Sensor electronic module (ISEM)" submenu

Navigation: Expert → Diagnostics → Sensor electronic module (ISEM)					
Parameter	Register	Data type	Access	Selection / User entry / User interface	→ 
Firmware version	7039	Integer	Read	Positive integer	143
Build no. software	2326	Integer	Read	Positive integer	143
Bootloader revision	2264	Integer	Read	Positive integer	143

"I/O module 2" submenu

Navigation: Expert → Diagnostics → I/O module 2					
Parameter	Register	Data type	Access	Selection / User entry / User interface	→ 
I/O module 2 terminal numbers	6542	Integer	Read	0 = Not used 1 = 26-27 (I/O 1) 2 = 24-25 (I/O 2) 3 = 22-23 (I/O 3) 4 = 20-21 (I/O 4)	144
Firmware version	7039	Integer	Read	Positive integer	144
Build no. software	2326	Integer	Read	Positive integer	144
Bootloader revision	2264	Integer	Read	Positive integer	144

"I/O module 3" submenu

Navigation: Expert → Diagnostics → I/O module 3					
Parameter	Register	Data type	Access	Selection / User entry / User interface	→ 
I/O module 3 terminal numbers	6543	Integer	Read	0 = Not used 1 = 26-27 (I/O 1) 2 = 24-25 (I/O 2) 3 = 22-23 (I/O 3) 4 = 20-21 (I/O 4)	145
Firmware version	7039	Integer	Read	Positive integer	145
Build no. software	2326	Integer	Read	Positive integer	145
Bootloader revision	2264	Integer	Read	Positive integer	146

"I/O module 4" submenu





Navigation: Expert → Diagnostics → I/O module 4					
Parameter	Register	Data type	Access	Selection / User entry / User interface	→ 
I/O module 4 terminal numbers	6544	Integer	Read	0 = Not used 1 = 26-27 (I/O 1) 2 = 24-25 (I/O 2) 3 = 22-23 (I/O 3) 4 = 20-21 (I/O 4) *	146
Firmware version	7039	Integer	Read	Positive integer	146
Build no. software	2326	Integer	Read	Positive integer	147
Bootloader revision	2264	Integer	Read	Positive integer	147

* Visibility depends on order options or device settings

"Display module" submenu

Navigation: Expert → Diagnostics → Display module					
Parameter	Register	Data type	Access	Selection / User entry / User interface	→ 
Firmware version	7039	Integer	Read	Positive integer	147
Build no. software	2326	Integer	Read	Positive integer	148
Bootloader revision	2264	Integer	Read	Positive integer	148

"Data logging" submenu

Navigation: Expert → Diagnostics → Data logging					
Parameter	Register	Data type	Access	Selection / User entry / User interface	→ 
Assign channel 1	2445	Integer	Read / Write	0 = Off 4 = Conductivity 6 = Total solids 6 = Temperature 7 = Load rate * 8 = Corrected conductivity 39 = Electronics temperature 121 = Current output 1 * 122 = Current output 2 * 123 = Current output 3 * 124 = Current output 4 *	149
Assign channel 2	2446	Integer	Read / Write	For the picklist, see Assign channel 1 parameter (→  149)	149
Assign channel 3	2548	Integer	Read / Write	For the picklist, see Assign channel 1 parameter (→  149)	150
Assign channel 4	4286	Integer	Read / Write	For the picklist, see Assign channel 1 parameter (→  149)	150
Logging interval	4288 to 4289	Float	Read / Write	0.1 to 3 600.0 s	150
Clear logging data	4287	Integer	Read / Write	0 = Cancel 2 = Clear data	151
Data logging	5950	Integer	Read / Write	0 = Overwriting 1 = Not overwriting	152
Logging delay	5938	Integer	Read / Write	0 to 999 h	152
Data logging control	5930	Integer	Read / Write	0 = None 1 = Stop 2 = Delete + start	152

Navigation: Expert → Diagnostics → Data logging					
Parameter	Register	Data type	Access	Selection / User entry / User interface	→ 
Data logging status	5937	Integer	Read	0 = Done 1 = Stopped 2 = Active 3 = Delay active	153
Entire logging duration	2827 to 2828	Float	Read	Positive floating-point number	153

* Visibility depends on order options or device settings

"Min/max values" submenu

"Electronics temperature" submenu

"Main electronics temperature" submenu

Navigation: Expert → Diagnostics → Min/max values → Main electronics temperature					
Parameter	Register	Data type	Access	Selection / User entry / User interface	→ 
Maximum value	4649 to 4650	Float	Read	Signed floating-point number	157
Minimum value	4651 to 4652	Float	Read	Signed floating-point number	157

"Sensor electronics temperature (ISEM)" submenu

Navigation: Expert → Diagnostics → Min/max values → Sensor electronics temperature (ISEM)					
Parameter	Register	Data type	Access	Selection / User entry / User interface	→ 
Maximum value	30003 to 30004	Float	Read	Signed floating-point number	158
Minimum value	30013 to 30014	Float	Read	Signed floating-point number	158

"Medium temperature" submenu

Navigation: Expert → Diagnostics → Min/max values → Medium temperature					
Parameter	Register	Data type	Access	Selection / User entry / User interface	→ 
Maximum value	48675 to 48676	Float	Read	Signed floating-point number	158
Minimum value	48677 to 48678	Float	Read	Signed floating-point number	158

"Total solids" submenu

Navigation: Expert → Diagnostics → Min/max values → Total solids					
Parameter	Register	Data type	Access	Selection / User entry / User interface	→ 
Maximum value	53238 to 53239	Float	Read	Positive floating-point number	159
Minimum value	53236 to 53237	Float	Read	Positive floating-point number	159

"Conductivity" submenu

Navigation: Expert → Diagnostics → Min/max values → Conductivity					
Parameter	Register	Data type	Access	Selection / User entry / User interface	→ 
Maximum value	48591 to 48592	Float	Read	Positive floating-point number	160
Minimum value	48593 to 48594	Float	Read	Positive floating-point number	160

"Heartbeat Technology" submenu**"Simulation" submenu**

Navigation: Expert → Diagnostics → Simulation					
Parameter	Register	Data type	Access	Selection / User entry / User interface	→ 
Assign simulation process variable	29999	Integer	Read / Write	0 = Off 4 = Conductivity 6 = Total solids 6 = Temperature 7 = Load rate * 8 = Corrected conductivity 39 = Electronics temperature	161
Process variable value	30000 to 30001	Float	Read / Write	Signed floating-point number	162
Current input 1 to n simulation	1: 6127 2: 6128 3: 6129	Integer	Read / Write	0 = Off 1 = On	162
Value current input 1 to n	1: 6139 to 6140 2: 6141 to 6142 3: 6143 to 6144	Float	Read / Write	0 to 22.5 mA	162
Status input 1 to n simulation	1: 2620 2: 4693 3: 4694	Integer	Read / Write	0 = Off 1 = On	163
Input signal level 1 to n	1: 2638 2: 4696 3: 4697	Integer	Read / Write	0 = Low 1 = High	163
Current output 1 to n simulation	1: 5939 2: 5940 3: 5941	Integer	Read / Write	0 = Off 1 = On	163
Current output value	5995 to 5996	Float	Read / Write	3.59 to 22.5 mA	164
Frequency output 1 to n simulation	1: 6203 2: 6204 3: 6205	Integer	Read / Write	0 = Off 1 = On	164
Frequency output 1 to n value	1: 6207 to 6208 2: 6209 to 6210 3: 6211 to 6212	Float	Read / Write	0.0 to 12 500.0 Hz	165
Pulse output simulation 1 to n	1: 6215 2: 6216 3: 6217	Integer	Read / Write	0 = Off 1 = Down-counting value 2 = Fixed value	165
Pulse value 1 to n	1: 6219 2: 6220 3: 6221	Integer	Read / Write	0 to 65 535	166
Switch output simulation 1 to n	1: 6223 2: 6224 3: 6225	Integer	Read / Write	0 = Off 1 = On	166
Switch state 1 to n	1: 6227 2: 6228 3: 6229	Integer	Read / Write	1 = Open 6 = Closed	167
Relay output 1 to n simulation	1: 7523 2: 7524 3: 7525	Integer	Read / Write	0 = Off 1 = On	167
Switch state 1 to n	1: 8239 2: 8240 3: 8241	Integer	Read / Write	1 = Open 6 = Closed	168
Device alarm simulation	6812	Integer	Read / Write	0 = Off 1 = On	168

Navigation: Expert → Diagnostics → Simulation					
Parameter	Register	Data type	Access	Selection / User entry / User interface	→ 
Diagnostic event category	4261	Integer	Read / Write	0 = Sensor 1 = Electronics 2 = Configuration 3 = Process	169
Diagnostic event simulation	4259	Integer	Read / Write	<ul style="list-style-type: none"> ■ Off ■ Diagnostic event picklist (depends on the category selected) 	169

* Visibility depends on order options or device settings

Index

- 0 ... 9**
- 0/4 mA value (Parameter) 70
 - 0% bargraph value 1 (Parameter) 17
 - 0% bargraph value 3 (Parameter) 20
 - 0% bargraph value 5 (Parameter) 24
 - 0% bargraph value 7 (Parameter) 26
 - 2.4 GHz WLAN channel (Parameter) 124
 - 20 mA value (Parameter) 70
 - 100% bargraph value 1 (Parameter) 18
 - 100% bargraph value 3 (Parameter) 21
 - 100% bargraph value 5 (Parameter) 24
 - 100% bargraph value 7 (Parameter) 27
- A**
- Activate SW option (Parameter) 44
 - Active level (Parameter) 73
 - Actual diagnostics (Parameter) 131
 - Adapted Modbus RS485 registers 172
 - Administration (Submenu) 40
 - Alarm delay (Parameter) 35
 - Application (Submenu) 126
 - Apply I/O configuration (Parameter) 67
 - Assign behavior of diagnostic no. 302 (Parameter) . . . 38
 - Assign behavior of diagnostic no. 441 (Parameter) . . . 36
 - Assign behavior of diagnostic no. 442 (Parameter) . . . 37
 - Assign behavior of diagnostic no. 443 (Parameter) . . . 37
 - Assign behavior of diagnostic no. 444 (Parameter) . . . 37
 - Assign behavior of diagnostic no. 832 (Parameter) . . . 38
 - Assign behavior of diagnostic no. 833 (Parameter) . . . 39
 - Assign behavior of diagnostic no. 834 (Parameter) . . . 39
 - Assign behavior of diagnostic no. 835 (Parameter) . . . 39
 - Assign behavior of diagnostic no. 907 (Parameter) . . . 40
 - Assign behavior of diagnostic no. 908 (Parameter) . . . 40
 - Assign channel 1 (Parameter) 149
 - Assign channel 2 (Parameter) 149
 - Assign channel 3 (Parameter) 150
 - Assign channel 4 (Parameter) 150
 - Assign diagnostic behavior (Parameter) 97, 106
 - Assign flow direction check (Parameter) 101, 105
 - Assign frequency output (Parameter) 92
 - Assign limit (Parameter) 98, 105
 - Assign process variable (Parameter) 58
 - Assign process variable 1 (Parameter) 127
 - Assign pulse output (Parameter) 88
 - Assign simulation process variable (Parameter) 161
 - Assign SSID name (Parameter) 124
 - Assign status (Parameter) 101, 106
 - Assign status input (Parameter) 72
- B**
- Backlight (Parameter) 31
 - Backup state (Parameter) 33
 - Baudrate (Parameter) 110
 - Bootloader revision (Parameter) 142, 143, 144, 146, 147, 148
- C**
- Build no. software (Parameter) 142, 143, 144, 145, 147, 148
 - Bus address (Parameter) 110
 - Bus termination (Parameter) 114
 - Byte order (Parameter) 112
 - Clear logging data (Parameter) 151
 - Communication (Submenu) 109
 - Comparison result (Parameter) 34
 - Conductivity (Parameter) 47
 - Conductivity (Submenu) 159
 - Conductivity damping (Parameter) 58
 - Conductivity factor (Parameter) 63
 - Conductivity offset (Parameter) 63
 - Conductivity unit (Parameter) 56
 - Configuration backup (Submenu) 32
 - Configuration management (Parameter) 33
 - Confirm access code (Parameter) 42
 - Connection state (Parameter) 125
 - Contrast display (Parameter) 31
 - Corrected conductivity (Parameter) 47
 - Corrected conductivity factor (Parameter) 64
 - Corrected conductivity offset (Parameter) 64
 - Current input 1 to n (Submenu) 49, 68
 - Current input 1 to n simulation (Parameter) 162
 - Current output 1 to n (Submenu) 74
 - Current output 1 to n simulation (Parameter) 163
 - Current output value (Parameter) 164
 - Current range output (Parameter) 75
 - Current span (Parameter) 69
- D**
- Damping current output (Parameter) 83
 - Damping output (Parameter) 94
 - Data logging (Parameter) 152
 - Data logging (Submenu) 148
 - Data logging control (Parameter) 152
 - Data logging status (Parameter) 153
 - Data transfer mode (Parameter) 111
 - Date/time (Parameter) 66
 - Date/time format (Parameter) 57
 - Decimal places 1 (Parameter) 18
 - Decimal places 2 (Parameter) 19
 - Decimal places 3 (Parameter) 21
 - Decimal places 4 (Parameter) 22
 - Decimal places 5 (Parameter) 24
 - Decimal places 6 (Parameter) 25
 - Decimal places 7 (Parameter) 27
 - Decimal places 8 (Parameter) 28
 - Default gateway (Parameter) 118
 - Define access code (Parameter) 41
 - Define access code (Wizard) 41
 - Density unit (Parameter) 55
 - Device alarm simulation (Parameter) 168
 - Device ID (Parameter) 115

- Device information (Submenu) 138
- Device name (Parameter) 140
- Device reset (Parameter) 43
- Device revision (Parameter) 115
- Device tag (Parameter) 138
- DHCP client (Parameter) 117
- Diagnostic behavior (Submenu) 35
- Diagnostic event category (Parameter) 169
- Diagnostic event simulation (Parameter) 169
- Diagnostic handling (Submenu) 35
- Diagnostic list (Submenu) 134
- Diagnostics (Submenu) 131
- Diagnostics 1 (Parameter) 134
- Diagnostics 2 (Parameter) 134
- Diagnostics 3 (Parameter) 135
- Diagnostics 4 (Parameter) 135
- Diagnostics 5 (Parameter) 136
- Direct access
 - 0% bargraph value 5 24
 - 0% bargraph value 7 26
 - 2.4 GHz WLAN channel 124
 - 100% bargraph value 5 24
 - 100% bargraph value 7 27
 - Assign SSID name 124
 - Connection state 125
 - Decimal places 5 24
 - Decimal places 6 25
 - Decimal places 7 27
 - Decimal places 8 28
 - Gateway IP address 126
 - IP address domain name server 126
 - Network security 121
 - Received signal strength 125
 - Relay output 1 to n simulation 167
 - Security identification 122
 - Select antenna 125
 - SSID name 121, 124
 - Switch state 1 to n 168
 - Timestamp 132, 133
 - User name 122
 - Value 5 display 23
 - Value 6 display 25
 - Value 7 display 26
 - Value 8 display 28
 - WLAN 120
 - WLAN IP address 123
 - WLAN MAC address 123
 - WLAN mode 121
 - WLAN passphrase 123
 - WLAN password 122
 - WLAN subnet mask 123
- Display (Submenu) 13
- Display channel 1 (Submenu) 154
- Display channel 2 (Submenu) 154
- Display channel 3 (Submenu) 155
- Display channel 4 (Submenu) 155
- Display damping (Parameter) 29
- Display interval (Parameter) 29
- Display language (Parameter) 23
- Display module (Submenu) 147
- Document
 - Design 4
 - Explanation of the structure of a parameter description 6
 - Function 4
 - Symbols used 6
 - Target group 4
 - Using the document 4
- Document function 4
- E**
 - Electronics temperature (Parameter) 46
 - Electronics temperature (Submenu) 156
 - Electronics temperature factor (Parameter) 64
 - Electronics temperature offset (Parameter) 64
 - ENP version (Parameter) 141
 - Enter access code (Parameter) 13
 - Entire logging duration (Parameter) 153
 - Event list (Submenu) 137
 - Event logbook (Submenu) 136
 - Expert (Menu) 11, 174
 - Extended order code 1 (Parameter) 140
 - Extended order code 2 (Parameter) 140
 - Extended order code 3 (Parameter) 141
 - External compensation (Submenu) 61
- F**
 - Factory adjustment (Submenu) 65
 - Factory settings 170
 - SI units 170
 - US units 170
 - Failure behavior current output (Parameter) 83
 - Failure current (Parameter) 84
 - Failure frequency (Parameter) 96
 - Failure mode (Parameter) 71, 91, 95, 102, 108, 113
 - Failure value (Parameter) 71
 - Fieldbus writing access (Parameter) 114
 - Filter options (Parameter) 136
 - Firmware version (Parameter)
 - 139, 142, 143, 144, 145, 146, 147
 - Fixed current (Parameter) 76
 - Format display (Parameter) 14
 - Frequency output 1 to n simulation (Parameter) 164
 - Frequency output 1 to n value (Parameter) 165
 - Function
 - see Parameter
- G**
 - Gateway IP address (Parameter) 126
- H**
 - Header (Parameter) 30
 - Header text (Parameter) 30
 - Heartbeat Technology (Submenu) 160
- I**
 - I/O alteration code (Parameter) 68
 - I/O configuration (Submenu) 66
 - I/O module 1 to n information (Parameter) 66

I/O module 1 to n terminal numbers (Parameter) 66
 I/O module 1 to n type (Parameter) 67
 I/O module 2 (Submenu) 143
 I/O module 2 terminal numbers (Parameter)
 144, 145, 146
 I/O module 3 (Submenu) 145
 I/O module 3 terminal numbers (Parameter)
 144, 145, 146
 I/O module 4 (Submenu) 146
 I/O module 4 terminal numbers (Parameter)
 144, 145, 146
 Input (Submenu) 68
 Input signal level 1 to n (Parameter) 163
 Input values (Submenu) 48
 Invert output signal (Parameter) 103
 IP address (Parameter) 118
 IP address domain name server (Parameter) 126

L

Last backup (Parameter) 32
 Load rate (Parameter) 47
 Load rate factor (Parameter) 65
 Load rate offset (Parameter) 65
 Locking status (Parameter) 11
 Logging delay (Parameter) 152
 Logging interval (Parameter) 150
 Login page (Parameter) 119
 Lower range limit (Parameter) 59
 Lower range value output (Parameter) 77

M

MAC address (Parameter) 117
 Main electronic module + I/O module 1 (Submenu) . 141
 Main electronics temperature (Submenu) 156
 Mass flow unit (Parameter) 55
 Mass unit (Parameter) 55
 Max. switch cycles number (Parameter) 53
 Maximum frequency value (Parameter) 93
 Maximum value (Parameter) . . 156, 157, 158, 159, 160
 Measured current (Parameter) 51, 85
 Measured current 1 to n (Parameter) 49
 Measured values (Submenu) 45
 Measured values 1 to n (Parameter) 49
 Measuring interval (Parameter) 62
 Measuring mode (Parameter) 90, 94
 Measuring mode current output (Parameter) 78
 Measuring value at maximum frequency (Parameter) 93
 Measuring value at minimum frequency (Parameter) 93
 Medium temperature (Submenu) 158
 Menu
 Expert 11, 174
 Min/max values (Submenu) 155
 Minimum frequency value (Parameter) 92
 Minimum value (Parameter) . . 156, 157, 158, 159, 160
 Modbus configuration (Submenu) 110
 Modbus data map (Submenu) 116
 Modbus information (Submenu) 115

N

Network security (Parameter) 121
 Nominal diameter (Parameter) 65

O

Operating mode (Parameter) 87
 Operating time (Parameter) 32, 42, 133
 Operating time from restart (Parameter) 133
 Order code (Parameter) 140
 Output (Submenu) 73
 Output current (Parameter) 50, 84
 Output frequency (Parameter) 51, 96
 Output values (Submenu) 50

P

Parameter

 Structure of description 6
 Parity (Parameter) 111
 Partially filled pipe detection (Parameter) 60
 Partially filled pipe detection (Submenu) 60
 Powerless relay status (Parameter) 109
 Preset value 1 (Parameter) 130
 Previous diagnostics (Parameter) 132
 Process parameters (Submenu) 57
 Process variable adjustment (Submenu) 62
 Process variable current output (Parameter) 75
 Process variable unit 1 (Parameter) 128
 Process variable value (Parameter) 162
 Process variables (Submenu) 46
 Pulse output (Parameter) 51, 91
 Pulse output simulation 1 to n (Parameter) 165
 Pulse scaling (Parameter) 89
 Pulse value 1 to n (Parameter) 166
 Pulse width (Parameter) 89
 Pulse/frequency/switch output 1 to n (Submenu) 51, 85

R

Received signal strength (Parameter) 125
 Relay output 1 to n (Submenu) 53, 103
 Relay output 1 to n simulation (Parameter) 167
 Relay output function (Parameter) 104
 Reset access code (Parameter) 42
 Reset access code (Submenu) 42
 Reset all totalizers (Parameter) 126
 Response time (Parameter) 59, 60, 95
 Response time status input (Parameter) 73

S

Scan list register 0 to 15 (Parameter) 116
 Security identification (Parameter) 122
 Select antenna (Parameter) 125
 Sensor (Submenu) 45
 Sensor adjustment (Submenu) 62
 Sensor electronic module (ISEM) (Submenu) 142
 Sensor electronics temperature (ISEM) (Submenu) . . 157
 Separator (Parameter) 31
 Serial number (Parameter) 139
 Signal mode (Parameter) 69, 75, 87
 Simulation (Submenu) 160

- Software option overview (Parameter) 45
 - SSID name (Parameter) 121, 124
 - Status input 1 to n (Submenu) 71
 - Status input 1 to n simulation (Parameter) 163
 - Submenu
 - Administration 40
 - Application 126
 - Communication 109
 - Conductivity 159
 - Configuration backup 32
 - Current input 1 to n 49, 68
 - Current output 1 to n 74
 - Data logging 148
 - Device information 138
 - Diagnostic behavior 35
 - Diagnostic handling 35
 - Diagnostic list 134
 - Diagnostics 131
 - Display 13
 - Display channel 1 154
 - Display channel 2 154
 - Display channel 3 155
 - Display channel 4 155
 - Display module 147
 - Electronics temperature 156
 - Event list 137
 - Event logbook 136
 - External compensation 61
 - Factory adjustment 65
 - Heartbeat Technology 160
 - I/O configuration 66
 - I/O module 2 143
 - I/O module 3 145
 - I/O module 4 146
 - Input 68
 - Input values 48
 - Main electronic module + I/O module 1 141
 - Main electronics temperature 156
 - Measured values 45
 - Medium temperature 158
 - Min/max values 155
 - Modbus configuration 110
 - Modbus data map 116
 - Modbus information 115
 - Output 73
 - Output values 50
 - Partially filled pipe detection 60
 - Process parameters 57
 - Process variable adjustment 62
 - Process variables 46
 - Pulse/frequency/switch output 1 to n 51, 85
 - Relay output 1 to n 53, 103
 - Reset access code 42
 - Sensor 45
 - Sensor adjustment 62
 - Sensor electronic module (ISEM) 142
 - Sensor electronics temperature (ISEM) 157
 - Simulation 160
 - Status input 1 to n 71
 - System 13
 - System units 54
 - Total solids 159
 - Total solids monitoring 58
 - Totalizer 47
 - Totalizer 1 to n 127
 - Value current output 1 to n 50
 - Value status input 1 to n 49
 - Web server 116
 - Subnet mask (Parameter) 118
 - Switch cycles (Parameter) 53
 - Switch output function (Parameter) 96
 - Switch output simulation 1 to n (Parameter) 166
 - Switch state (Parameter) 52, 53, 102, 109
 - Switch state 1 to n (Parameter) 167, 168
 - Switch-off delay (Parameter) 102, 107
 - Switch-off value (Parameter) 100, 107
 - Switch-on delay (Parameter) 101, 108
 - Switch-on value (Parameter) 100, 107
 - System (Submenu) 13
 - System units (Submenu) 54
- T**
- Target group 4
 - Telegram delay (Parameter) 113
 - Temperature (Parameter) 46
 - Temperature damping (Parameter) 57
 - Temperature factor (Parameter) 63
 - Temperature offset (Parameter) 63
 - Temperature unit (Parameter) 56
 - Terminal number (Parameter) 69, 72, 74, 86, 104
 - Threshold (Parameter) 60
 - Timestamp (Parameter) 132, 133
 - Total solids (Parameter) 46
 - Total solids (Submenu) 159
 - Total solids monitoring (Submenu) 58
 - Total solids override (Parameter) 58
 - Total solids unit (Parameter) 54
 - Totalizer (Submenu) 47
 - Totalizer 1 control (Parameter) 129
 - Totalizer 1 failure behavior (Parameter) 130
 - Totalizer 1 operation mode (Parameter) 128
 - Totalizer 1 overflow (Parameter) 48
 - Totalizer 1 to n (Submenu) 127
 - Totalizer 1 value (Parameter) 48
 - Transmitter identifier (Parameter) 44
- U**
- Upper range limit (Parameter) 59
 - Upper range value output (Parameter) 78
 - User name (Parameter) 122
 - User role (Parameter) 12
- V**
- Value 1 display (Parameter) 17
 - Value 2 display (Parameter) 19
 - Value 3 display (Parameter) 20
 - Value 4 display (Parameter) 22
 - Value 5 display (Parameter) 23

Value 6 display (Parameter)	25
Value 7 display (Parameter)	26
Value 8 display (Parameter)	28
Value current input 1 to n (Parameter)	162
Value current output 1 to n (Submenu)	50
Value status input (Parameter)	50, 73
Value status input 1 to n (Submenu)	49
Volume flow unit (Parameter)	56

W

Web server (Submenu)	116
Web server functionality (Parameter)	119
Web server language (Parameter)	117
Wizard	
Define access code	41
WLAN settings	119
WLAN (Parameter)	120
WLAN IP address (Parameter)	123
WLAN MAC address (Parameter)	123
WLAN mode (Parameter)	121
WLAN passphrase (Parameter)	123
WLAN password (Parameter)	122
WLAN settings (Wizard)	119
WLAN subnet mask (Parameter)	123



www.addresses.endress.com
