

Operating Instructions

Liquicap FTZ61

Transmitter for foam detection in single-use bioreactors

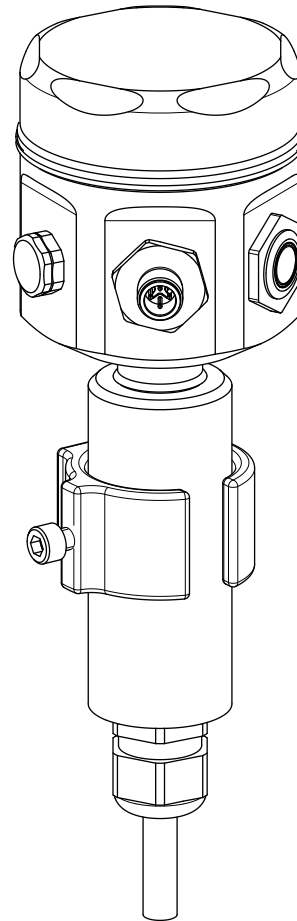

- Make sure the document is stored in a safe place such that it is always available when working on or with the device.
- To avoid danger to individuals or the facility, read the "Basic safety instructions" section carefully, as well as all other safety instructions in the document that are specific to working procedures.
- The manufacturer reserves the right to modify technical data without prior notice. Your Endress+Hauser sales organization will supply you with current information and updates to this manual.

Table of contents

1	About this document	4	7.4	Change calibration	19
1.1	Document function	4	8	Operation	20
1.2	Symbols	4	8.1	Push button for empty calibration	20
1.2.1	Safety symbols	4	8.2	Human interface and display elements	21
1.2.2	Symbols for certain types of information	4	9	Diagnostics and troubleshooting ...	23
1.2.3	Symbols in graphics	5	9.1	Fault diagnostics	23
1.2.4	Electrical symbols	5	9.2	Error current/Warning	24
1.2.5	Symbols on device	5	10	Maintenance and servicing	25
1.3	Documentation	5	10.1	Cleaning the housing	25
2	Safety instructions	6	10.2	Disposal information	25
2.1	Intended use	6	11	Technical data	26
2.2	Installation, commissioning and operation	6	11.1	Power supply	26
2.3	Workplace safety	6	11.2	Data cable	26
2.3.1	Hazardous areas	6	11.3	Sensor cable	26
2.4	Operational safety	6	11.4	Input	27
2.5	Product safety	7	11.5	Output	27
3	Product description	8	11.6	Performance characteristics	27
3.1	Product design	8	11.7	Operating conditions: Environment	27
3.2	Data cable	8	11.8	Mechanical construction	28
3.3	Mounting bracket	9	12	Declarations	29
3.4	Function	10	Index	30	
4	Incoming acceptance	11			
4.1	Scope of delivery	11			
4.2	Incoming acceptance test	11			
4.3	Storage	11			
4.4	Consumables	11			
5	Installation	12			
5.1	Mounting	12			
5.2	Installation	12			
5.3	Dimensions	13			
5.4	Post installation check	15			
6	Electrical connections	16			
6.1	Connecting the device	16			
6.1.1	Potential equalization	16			
6.1.2	Connector	16			
6.1.3	Failure information	16			
6.1.4	Connecting procedure	17			
6.2	Connecting the sensor	17			
6.3	Post connection check	17			
6.3.1	Sealing the housing	17			
7	Commissioning	18			
7.1	Installation and function check	18			
7.2	Empty calibration	18			
7.3	Full calibration	18			

1 About this document

1.1 Document function

These Operating Instructions contain all the information that is required in various phases of the life cycle of the device: from product identification, incoming acceptance and storage, to mounting, connection, operation and commissioning through to troubleshooting, maintenance and disposal.

1.2 Symbols

1.2.1 Safety symbols

DANGER

This symbol alerts you to a dangerous situation. Failure to avoid this situation will result in serious or fatal injury.

WARNING

This symbol alerts you to a potentially dangerous situation. Failure to avoid this situation can result in serious or fatal injury.











CAUTION

This symbol alerts you to a potentially dangerous situation. Failure to avoid this situation can result in minor or medium injury.

NOTICE

This symbol alerts you to a potentially harmful situation. Failure to avoid this situation can result in damage to the product or something in its vicinity.



1.2.2 Symbols for certain types of information

Symbol	Meaning
	Permitted Procedures, processes or actions that are permitted.
	Preferred Procedures, processes or actions that are preferred.
	Forbidden Procedures, processes or actions that are forbidden.
	Tip Indicates additional information.
	Reference to documentation.
	Reference to page.
	Reference to graphic.
	Notice or individual step to be observed.
	Series of steps.
	Result of a step.

1.2.3 Symbols in graphics

Symbol	Meaning
1, 2, 3 ...	Item numbers
1 , 2 , 3 ...	Series of steps
A, B, C, ...	Views
A-A, B-B, C-C, ...	Sections

1.2.4 Electrical symbols

Symbol	Meaning
	Ground connection A grounded terminal which is grounded via a grounding system.
	Protective ground connection A terminal that has to be grounded before other connections can be made.

1.2.5 Symbols on device

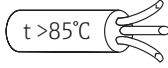
Symbol	Meaning
	Documentation Reference to device documentation.
	Temperature resistance of the connecting cables Indicates that the connecting cables must be able to withstand temperatures of at least 85 °C (185 °F).

1.3 Documentation

 For an overview of the scope of the associated Technical Documentation, refer to the following:

- *Device Viewer* (www.endress.com/deviceviewer): Enter the serial number from the nameplate
- *Endress+Hauser Operations app*: Enter serial number from nameplate or scan matrix code on nameplate.

2 Safety instructions

2.1 Intended use

This device is a compact instrument for the capacitive measurement of foam level in non-conducting containers, e.g. plastic or glass, in industrial settings, in particular single-use bags for cell culture.

The device and corresponding self-adhesive sensor patch are **not** designed to be in direct contact with foam. The measurement system is intended exclusively for mounting on the outer side of the container.

Non-designated use can compromise safety. The manufacturer is not liable for damage caused by improper or non-designated use.

2.2 Installation, commissioning and operation

The device has been safely built with state-of-the-art technology and meets all applicable standards and EU directives. However, if it is used improperly or if it is not put to its intended use, it can be a source of application-related dangers, such as product overflow due to incorrect installation or configuration. Therefore, the installation, electrical connection, commissioning, operation and maintenance of the measuring device only may be carried out by trained specialist personnel authorized by the facility's owner/operator for this purpose.

The specialist personnel must have read and understood these Operating Instructions and must follow them. Modifications or repairs to the device can be carried out only by the manufacturer on an authorized distributor.

NOTICE

Proper operation may be impaired by opening the device or changing the configuration.

- ▶ Do not open the device during operation.
- ▶ Do not make any changes to the device's internal configuration during operation.



Keep this manual safe. In case of loss, the up-to-date version is available for download →  5.

2.3 Workplace safety

When working on and with the device:

- ▶ Wear the required personal protective equipment as per national regulations.

2.3.1 Hazardous areas

NOTICE

Operation safety

- ▶ This device is not intended for use in potentially explosive areas.

2.4 Operational safety

Damage to the device!

- ▶ Operate the device in proper technical condition and fail-safe condition only.
- ▶ The operator is responsible for the interference-free operation of the device.

Modifications to the device

Unauthorized modifications to the device are not permitted and can lead to unforeseeable dangers!

- ▶ If modifications are nevertheless required, consult with the manufacturer.

Repair

To ensure continued operational safety and reliability:

- ▶ Carry out repairs on the device only if they are expressly permitted.
- ▶ Observe federal/national regulations pertaining to the repair of an electrical device.
- ▶ Use only original spare parts and accessories.

2.5 Product safety

This measuring device is designed in accordance with good engineering practice to meet state-of-the-art safety requirements, has been tested, and left the factory in a condition in which it is safe to operate.

It meets general safety standards and legal requirements. It also complies with the EU directives listed in the device-specific EU Declaration of Conformity. The manufacturer confirms this by affixing the CE mark to the device.

3 Product description

Transmitter for the detection of foam generated during cell culture processes in single-use plastic bags.

3.1 Product design

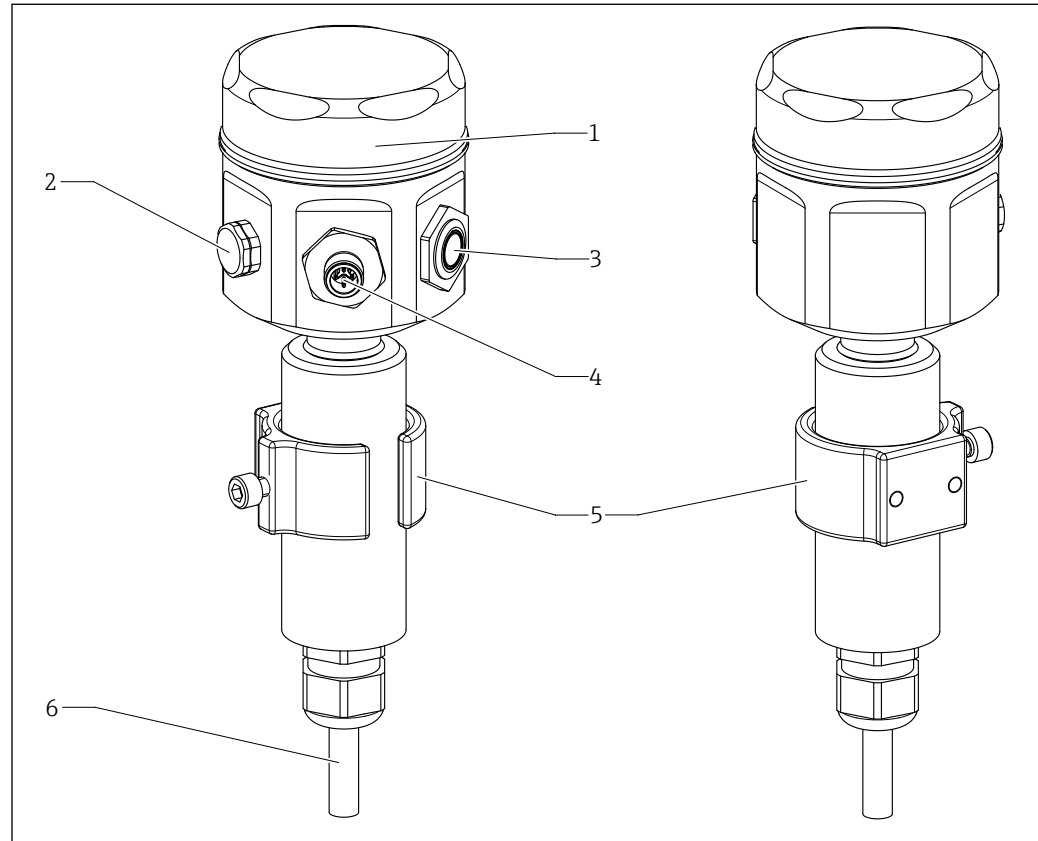

A0054675

- 1 Housing cover
- 2 Pressure compensation filter
- 3 Push-button for empty calibration
- 4 M12 data cable connector
- 5 Mounting bracket (M5 screw holes)
- 6 Cable to sensor

3.2 Data cable

Use the provided data cable to connect the device to the control unit or programmable logic controller (PLC).

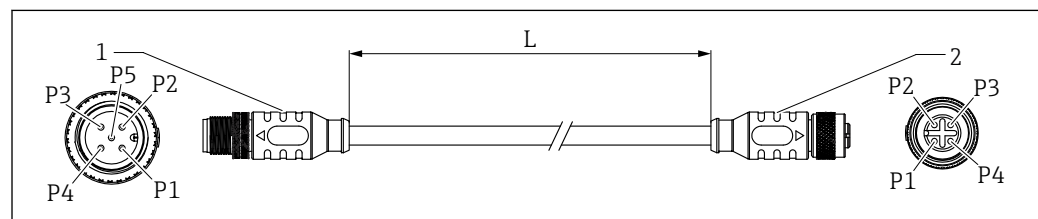

A0054671

L 5000 ± 60 mm (197 ± 2.36 in)

1	Pin	Connector to controller (PLC), M12, 5 pins, A-coded, Pin assignment
	P1	Signal 4 to 20 mA (+)
	P2	Signal (-)
	P3-P5	NC
2	Pin	Connector to device, M12, 4 pins, A-coded, Pin assignment
	P1	Signal 4 to 20 mA (+)
	P2	NC
	P3	Signal (-)
	P4	Shield of cable (ground, housing)

3.3 Mounting bracket

Use the provided mounting bracket to attach the device to the rail of the bag holder.

 Use an additional adapter to allow suitable attachment to the metal frame.

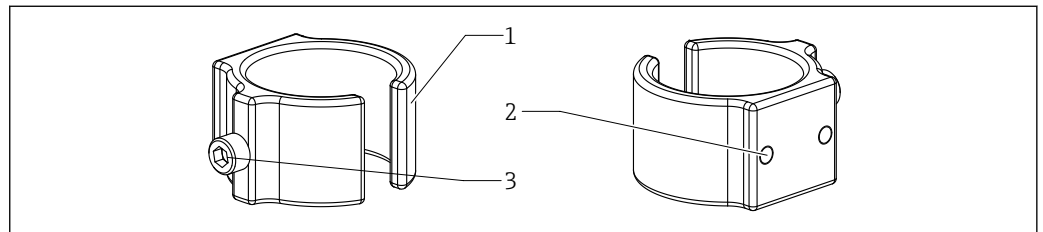

A0054676

- 1 Mounting bracket
- 2 M5 screw holes for attaching the transmitter mounting adapter (on customer side)
- 3 M6 screw for attaching the transmitter to the mounting bracket

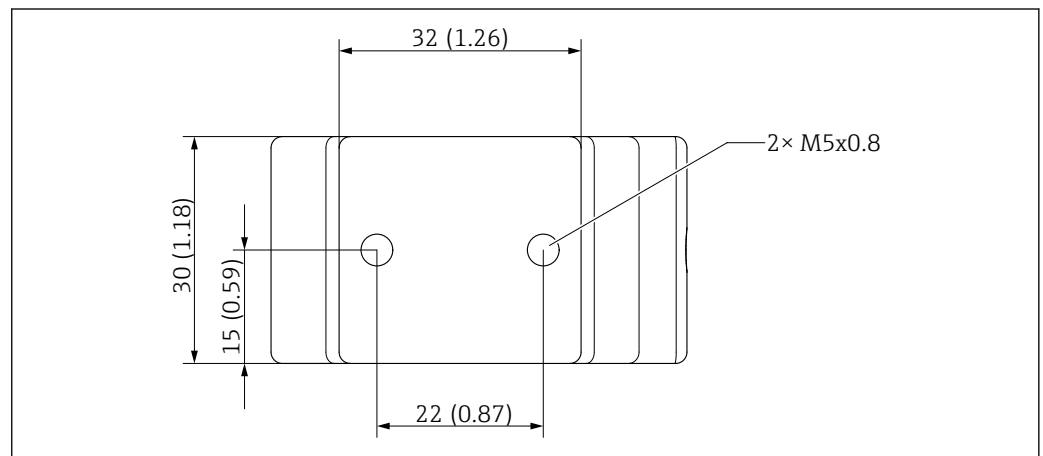

A0054925

-  1 Hole pattern of the mounting bracket, dimensions in mm (in)

3.4 Function

The device determines the change in capacitance of a capacitive sensor depending on how much the active section of the sensor is covered by foam.

The sensor uses a three-electrode arrangement:

- Sensor electrode
- Ground electrode
- Guard electrode

The device measures the capacitance between the sensor electrode and the ground electrode. The guard electrode limits the effects of external interferences.

4 Incoming acceptance

4.1 Scope of delivery

Scope of delivery

Transmitter	Order number
Liquicap FTZ61 transmitter	FTZ61-xxx

Can be ordered optionally

Sensor	Order number
Self-adhesive sensor for FTZ61	FZZ61-xxx

Accessories

Component	Order number
Mounting bracket for FTZ61	71647578
Data cable 5 m (16 ft) for FTZ61	71647581

4.2 Incoming acceptance test

- Check the packaging and the contents for damage.
- Check the shipment. Make sure nothing is missing and that the scope of delivery matches the order.

4.3 Storage

Store the device so that it is protected from impact.

The permitted storage temperature is -20 to $+85$ °C (-4 to 185 °F).

The maximum permitted storage air humidity is 80%.

4.4 Consumables

The self-adhesive single-use sensors for Liquicap FTZ61 are supplied separately (apart from the device).

5 Installation

5.1 Mounting

The transmitter can be mounted with the corresponding mounting bracket →  9, →  8.



1. Fasten the mounting bracket firmly to the transmitter using the M6 screw (included in the scope of delivery).
2. Use a compatible adapter to attach the transmitter at a suitable position on the metal frame, e.g. on a rail (on customer side).



Additional mounting information:

- Ground the mounting point electrically.
- The mounting adapter (not included in the scope of delivery) must be made of metal.
- Protect the housing from impact.

5.2 Installation

1. Install the device as described →  12.
2. Connect the device to the control unit or PLC using the supplied data cable (M12).
3. The device must be supplied with power as soon as it is connected.
4. Attach the self-adhesive sensor to the plastic bag and connect it →  17.

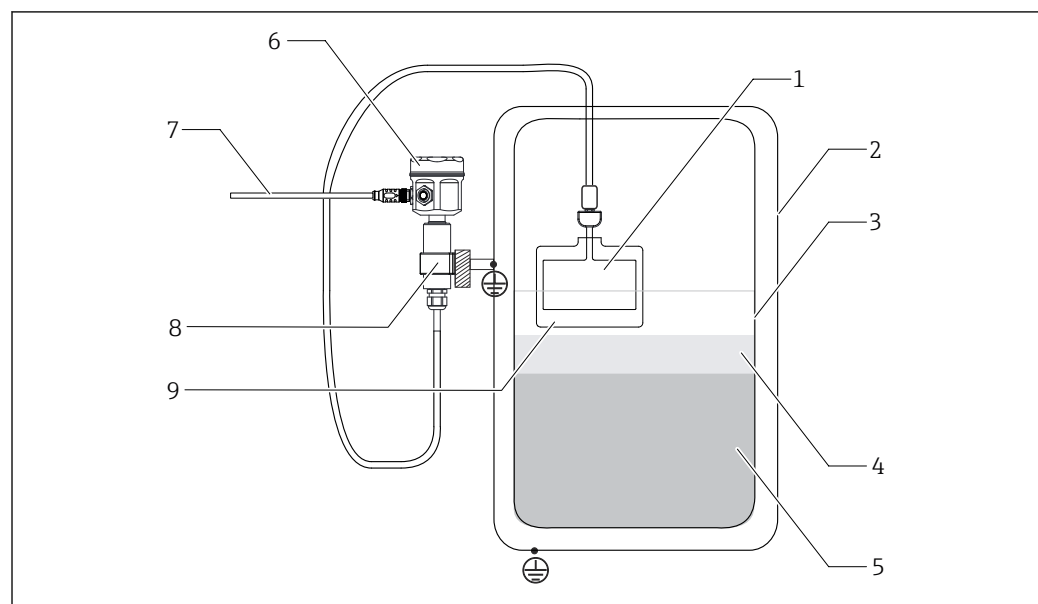

A0054672

- 1 Self-adhesive single-use sensor for Liquicap FTZ61
- 2 Metal container
- 3 Plastic container (single-use bag)
- 4 Foam
- 5 Liquid (cell culture)
- 6 Transmitter Liquicap FTZ61
- 7 Data cable M12 to control unit or PLC
- 8 Mounting bracket
- 9 Sensor cover



If multiple devices are mounted on the same metal holder, use cable labels to distinguish the devices.

5.3 Dimensions

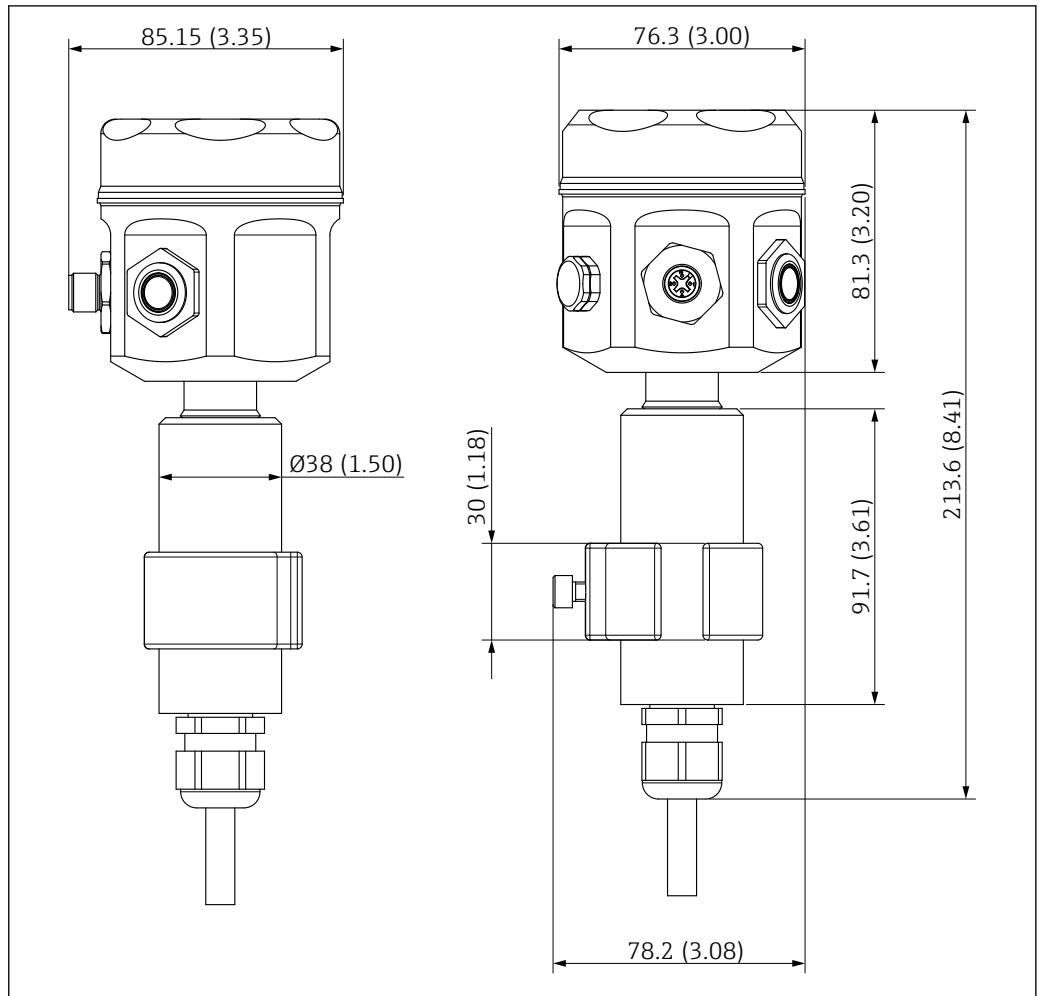

A0054677

2 Dimensions of the transmitter in mm (in)

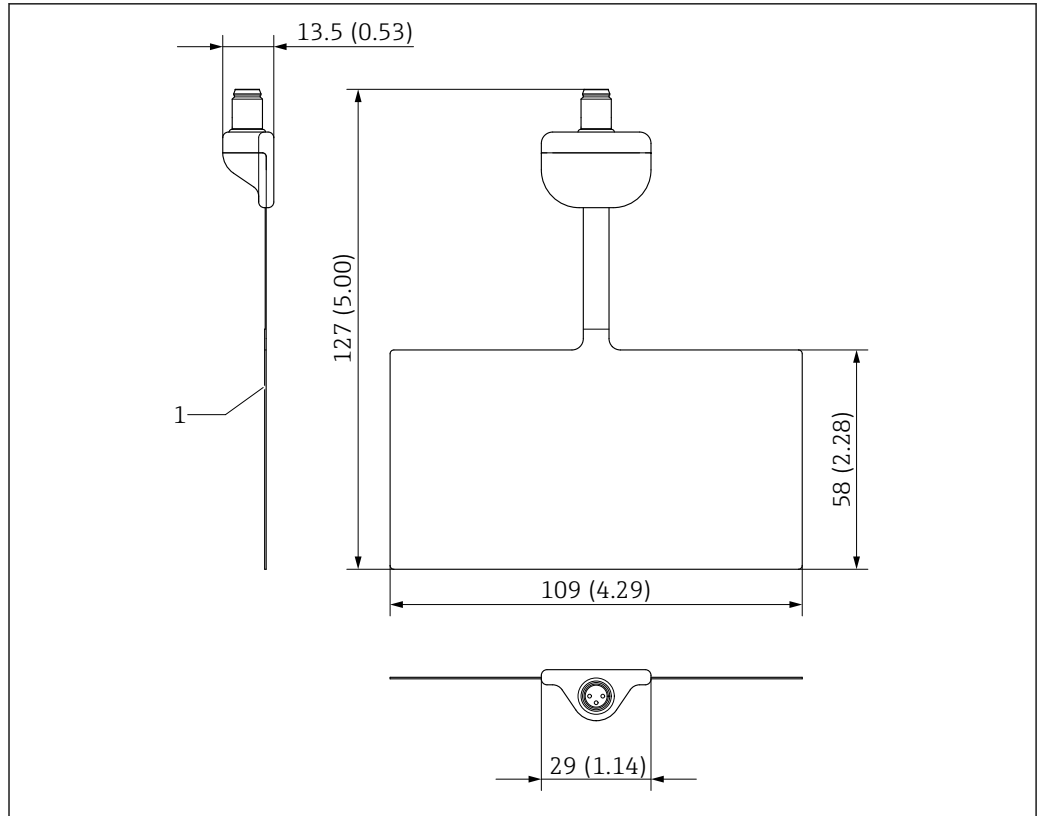

A0055248

3 Dimensions of the sensor in mm (in)

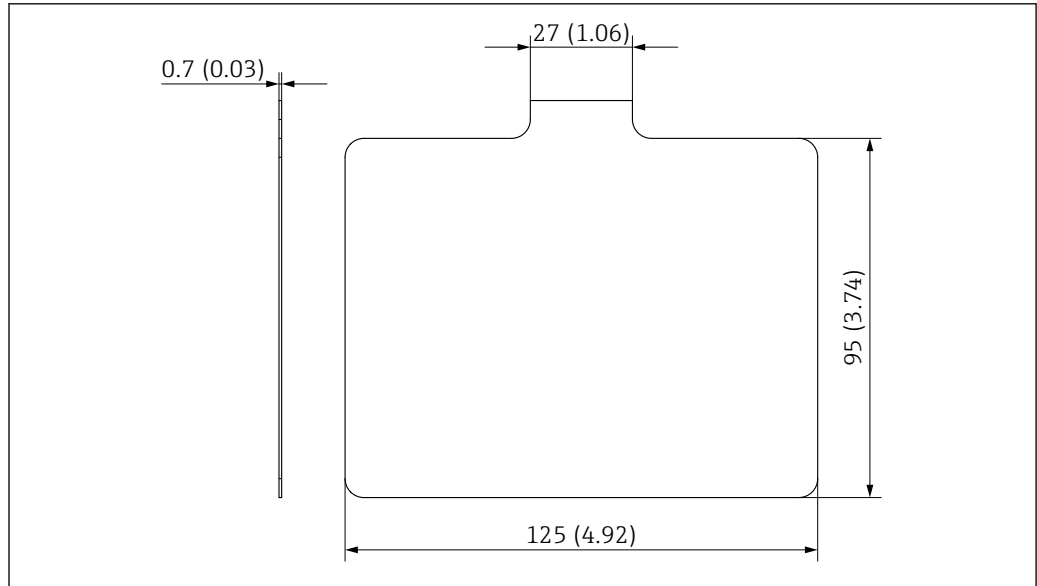

A0055250

4 Dimensions of the sensor cover in mm (in)

5.4 Post installation check



After installing the measuring instrument, carry out the following checks:

- Is the device damaged (visual inspection)?
- Does the measuring system comply with the measuring point specifications, ambient temperature etc.?
- Are the measuring point numbers and labeling correct (visual inspection)?
- Is the measuring system sufficiently protected from moisture and direct sunlight?
- Is the sensor firmly attached without visible air pockets beneath?
- Is the sensor cover also attached on top of the sensor?

6 Electrical connections

NOTICE

To prevent damage to the device:

- ▶ Before connecting the device to the control unit or PLC, ensure that the supply voltage is within the specifications →  16, →  26.
- ▶ Use the supplied data cable →  8 to connect the device to the control unit or the PLC.
- ▶ The device has to be connected to ground via the supplied mounting bracket.
- ▶ A separate circuit breaker must be provided in accordance with IEC/EN 61010.
- ▶ The device must be operated with a 50 mA fine-wire fuse or a maximum input current limited to 50 mA.

6.1 Connecting the device

6.1.1 Potential equalization

Potential equalization can be made via the supplied mounting bracket. The mounting point must therefore be electrically grounded and have the same potential as the bag holder.

6.1.2 Connector

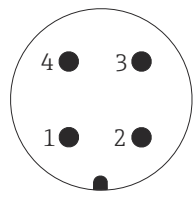
	Pin	Assignment
	1	Signal (+)
	2	NC
	3	Signal (-)
4	Ground	
		Housing
		Ground/Housing

Compatible devices

If possible, the two-wire DC connection should be connected as follows:

- To the programmable logic controller (PLC)
- To analog input modules 4 to 20 mA in accordance with EN 61131-2

Power supply unit



Supply voltage	11 to 35 V _{DC}
Power consumption	≤ 700 mW
Reverse polarity protection	yes
Separation voltage	0.5 kV
Overvoltage category	II

6.1.3 Failure information

Underranging	Decrease from 4.0 mA to 3.8 mA
Overranging	Increase from 20.0 mA to 20.5 mA
Power or device failure	< 3.6 mA

6.1.4 Connecting procedure



Note the following when connecting the device to the PLC:

- Plug the 4-pin connector of the data cable →  8 directly into the M12 socket →  8.
- Connect the 5-pin connector to the PLC.

 To ensure continuous operational safety and reliability, only use original data cables and spare parts from Endress+Hauser Flowtec AG.

6.2 Connecting the sensor

 For proper operation, the wall thickness of the bag should not exceed 2 mm (0.8 in).

1. Ensure that the bag is filled with liquid and is under sufficient pressure.
2. Select a position over the bag above the liquid level to place the sensor. This position must not be covered by foam.
3. Remove the protective film from the self-adhesive sensor.
4. Firmly attach the sensor to the selected position. Make sure that the sensor is aligned horizontally and that the connector points in the direction the sensor cable is coming from (usually pointing upwards).
 - ↳ If the sensor is firmly pressed against the metal container (armature) during operation, make sure to attach the supplied sensor cover over the sensor →  12.
5. Connect the sensor to the transmitter Liquicap FTZ61.
6. Perform an empty calibration →  18.

6.3 Post connection check

Perform the following checks after wiring the measuring instrument:

- Is the terminal assignment correct?
- Is the housing cover completely screwed on?
Sealing the housing cover →  17
- Are the data and sensor cable connectors completely screwed on?
- Is the output current higher than 3.6 mA?

6.3.1 Sealing the housing

No water should enter the device when performing installation, connection and configuration tasks. Always seal the housing cover and cable entries securely.

The O-ring seal on the housing cover is shipped with a coat of special lubricant applied. This allows the cover to seal tightly and ensures that the aluminum thread does not become seized during closing.

Never use mineral oil-based grease as this destroys the O-ring.



Replace the O-ring seal (order number 52028179) on the housing cover if it is worn or damaged.

 Brief Operating Instructions KA00620F

7 Commissioning

7.1 Installation and function check

Make sure that the post-installation check and the final check have been completed before starting the measurement:

- "Post-installation" checklist →  12
- "Post-connection" checklist →  16

7.2 Empty calibration

As a minimum, the "empty calibration" must be carried out.

The empty calibration stores the capacitance value of the sensor when no foam or liquid covers the sensor patch. The output current is then 4 mA.

To perform an empty calibration:

1. Attach the self-adhesive sensor (without medium coverage).
2. Set the function switch to position 2.
3. Perform empty calibration. Press the push button for empty calibration (D) for at least 2 s until the green LED flashes.
 - ↳ The current output now shows 4 mA.

As no full calibration has been carried out, the full capacitance (corresponds to 20 mA) is determined via the configured offset value
(full capacitance = empty capacitance + offset capacitance).

NOTICE

Missing O-ring or improper sealing of the device will lead to insufficient housing tightness.

Damage to the device.

- ▶ Only open the device in dry environments.
- ▶ Always seal the housing cover and cable entries securely.
- ▶ Sealing the housing →  17

7.3 Full calibration

In order to adapt the measurement even better to the actual process conditions, a full calibration can be carried out, if there is a significant foam coverage of the sensor.

1. Attach the self-adhesive sensor (with medium coverage).
2. Set the function switch to position 3.
3. Perform full calibration (press Key "+" (C) until the green LED flashes).
 - ↳ The current output now shows 20 mA.

NOTICE

Missing O-ring or improper sealing of the device will lead to insufficient housing tightness.

Damage to the device.

- ▶ Only open the device in dry environments.
- ▶ Always seal the housing cover and cable entries securely.
- ▶ Sealing the housing →  17

7.4 Change calibration

Reset the current calibration situation

1. Set the function switch to position 2 or 3
2. Press both keys for approx. 10 s until the yellow LED flashes (both calibration points are deleted)

Overwrite the current calibration

1. Select empty or full calibration (position 2 or 3 of the function switch)
2. Carry out a new calibration



The full calibration must have a higher capacitive measured value than the empty calibration. → The red LED flashes if the value for the full calibration is lower than the value for the empty calibration.

NOTICE

Missing O-ring or improper sealing of the device will lead to insufficient housing tightness.

Damage to the device.

- ▶ Only open the device in dry environments.
- ▶ Always seal the housing cover and cable entries securely.
- ▶ Sealing the housing →  17

8 Operation

8.1 Push button for empty calibration

The device features a single push-button (B) for performing empty calibration.

- i** The empty calibration assigns the currently measured capacitance to an output current of 4 mA.
- i** The empty calibration via push-button (B) is only possible if the function switch (A) is in position 2.

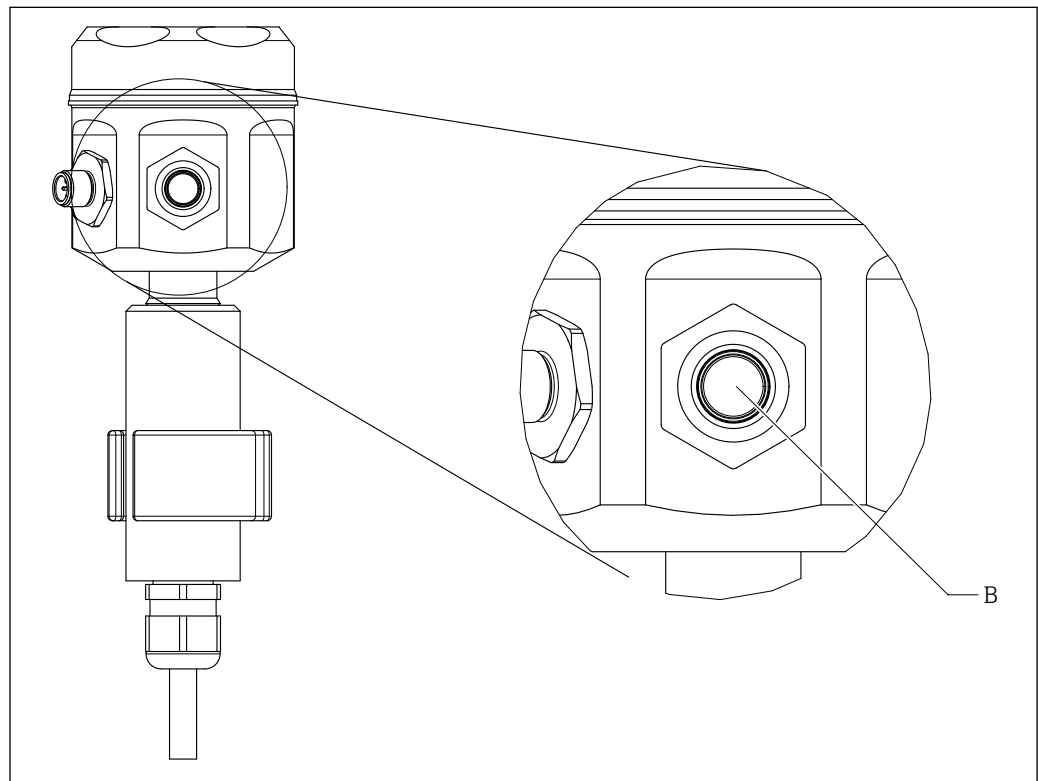

A0054678

B Push-button for empty calibration

8.2 Human interface and display elements

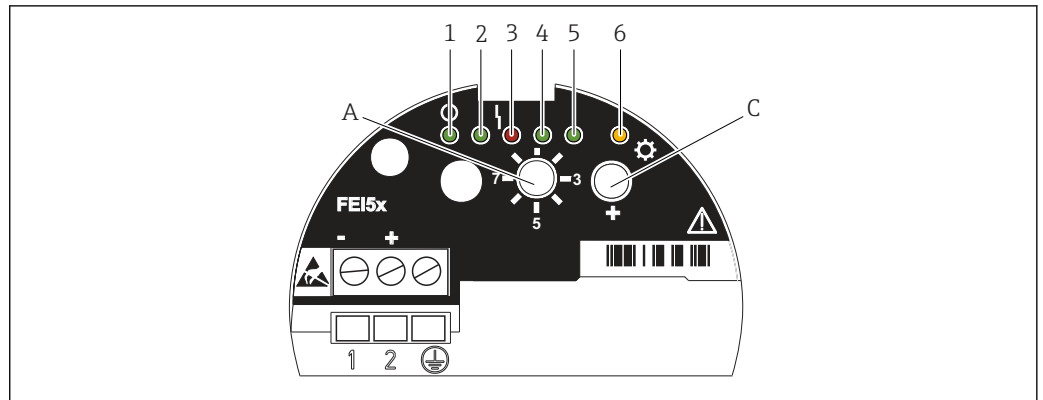

5 Green LED 1 (ready for operation), red LED 3 (error indicated), yellow LED 6 (switching state)

i To select a function, press the push-button (B) or key "+" (C) for at least 2 s. Release the push-button or key when the LED signals change.

Function switch position (A)	Function	Push-button (B)	Key "+" (C)	Light emitting diodes						
				(1) green	(2) green	(3) red	(4) green	(5) green	(6) yellow	
<p>A0054691</p>	Diagnostic operation and Measuring operation			Flashes (Operational LED)		(warning/ alarm)				¹⁾
	Factory reset	Press both keys for 20 s		On	→	→	→	→	→	¹⁾
2	Measuring operation and Empty calibration	Press		On (present)						¹⁾
	Reset: Calibration	Press both keys for 10 s		On	→	→	→	→	→	¹⁾
3	Full calibration		Press					On (present)		¹⁾
	Reset: Calibration	Press both keys for 10 s		On	→	→	→	→	→	¹⁾
4	Span (ΔC) capacitance	Press for ←	Press for →	5 pF	10 pF (Default)	50 pF	100 pF	200 pF		¹⁾
5	Damping value τ (approx. 63% of the full-scale value reached)	Press for ←	Press for →	0.1 s	0.3 s	0.5 s	1.0 s (Default)			¹⁾
6-8	Without function									¹⁾

1) The LED flashes if no calibration has been carried out yet.

i In positions 2 to 5 the device switches to measuring operation automatically after 30 s.

NOTICE

Missing O-ring or improper sealing of the device will lead to insufficient housing tightness.

Damage to the device.

- ▶ Only open the device in dry environments.
- ▶ Always seal the housing cover and cable entries securely.
- ▶ Sealing the housing →  17

9 Diagnostics and troubleshooting

9.1 Fault diagnostics

The diagnostics provide information about the operating status of the device. The results of the diagnostics are displayed by LEDs 1, 2, 4 and 5. If the diagnostics detect multiple faults, these are shown according to their priority. A serious fault (e.g. priority 3) is always displayed before a less serious fault (e.g. priority 5).

To activate the fault diagnostics, proceed as follows:

1. Set the function switch to position 1 (diagnostic operation and measuring operation).
2. Press the push-button (B).
3. The fault table below lists possible causes of faults and information on how to eliminate them.

LEDs for diagnostics						Cause	Remedy	Priority
1 (green)	2 (green)	3 (red)	4 (green)	5 (green)	6 (yellow)			
						Measure capacitance too large	Check sensor for short circuit	0
On						Internal fault	Replace electronics	1
	On				On	Calibration point(s) are outside the measuring range	Recalibrate	2
On				On		Calibration points are interchanged	Recalibrate	3
	On					The calibration point is too close to the measuring range limit	Reduce the switch point or select a new mounting location	4
On	On					No calibration has yet been carried out	Carry out empty or full calibration	5
			On			Internal fault	Contact Endress+Hauser Service	6
On			On			The capacitance change from sensor "empty" to sensor "full" is too small	Contact Endress+Hauser Service	7
	On		On			Sensor DAT (EEPROM) data are invalid	Carry out download from the electronic insert	8
On	On		On			Internal fault	Contact Endress+Hauser Service	9
				On		The measured temperature is outside the permitted temperature range	Operate the device only in the specified temperature range	10

NOTICE

Missing O-ring or improper sealing of the device will lead to insufficient housing tightness.

Damage to the device.

- ▶ Only open the device in dry environments.
- ▶ Always seal the housing cover and cable entries securely.
- ▶ Sealing the housing →  17

9.2 Error current/Warning

All internal errors will produce an output current < 3.6 mA.

If the capacitance value is greater than 500 pF, an error message is displayed (red LED flashes). If this error is active, no calibration can be performed.

If an error current occurs after an empty calibration, follow this procedure:

1. Disconnect the sensor from the sensor cable.
2. Perform an empty calibration again.
3. If the output current is now 4 mA, then replace the sensor.

NOTICE

Missing O-ring or improper sealing of the device will lead to insufficient housing tightness.

Damage to the device.

- ▶ Only open the device in dry environments.
- ▶ Always seal the housing cover and cable entries securely.
- ▶ Sealing the housing →  17

10 Maintenance and servicing

No special maintenance work is required.

NOTICE

Avoid damage to the device

- ▶ The housing cover may only be removed by qualified personnel.
- ▶ Do not attempt to modify the internal electronics of the device, as this may result in the configuration and measurement specifications being lost.

10.1 Cleaning the housing

Only use cleaning agents for cleaning that do not attack the housing surface or the seals.

10.2 Disposal information

All information on the proper disposal of the device is provided by the supplier.



If required by the Directive 2012/19/EU on waste electrical and electronic equipment (WEEE), the product is marked with the depicted symbol in order to minimize the disposal of WEEE as unsorted municipal waste. Do not dispose of products bearing this marking as unsorted municipal waste. Instead, return them to the manufacturer for disposal under the applicable conditions.

⚠ WARNING

Danger to personnel and environment from fluids that are hazardous to health.

- ▶ Ensure that the measuring device and all cavities are free of fluid residues that are hazardous to health or the environment, e.g. substances that have permeated into crevices or diffused through plastic.

Observe the following notes during disposal:

- ▶ Observe valid federal/national regulations.
- ▶ Ensure proper separation and reuse of the device components.

11 Technical data

11.1 Power supply

Supply voltage	11 to 35 V _{DC}
Power consumption	700 mW
Reverse polarity protection	yes
Separation voltage	0.5 kV
Electrical connection	For connecting to programmable logic controllers (PLC), AI modules 4 to 20 mA in accordance with EN 61131-2.





11.2 Data cable

Diameter	3.8 mm (0.15 in)
Length	5000 ± 60 mm (197 ± 2.36 in)
Jacket color and material	Black, TPU
Connector to transmitter	M12, female, 4 pins, A-coded Pin assignment: <ul style="list-style-type: none"> ▪ 1: Signal (+) ▪ 2: Not connected ▪ 3: Signal (-) ▪ 4: Shield of cable (ground, housing) Cable shield is connected to the shell of the connector.
Connector to PLC	M12, male, 5 pins, A-coded Pin assignment: <ul style="list-style-type: none"> ▪ 1: Foam signal (U hi) ▪ 2: U lo ▪ 3-5: Not connected Cable shield is connected to the shell of the connector.

11.3 Sensor cable

Diameter	10.5 mm (0.41 in)
Length	2900 ± 90 mm (114 ± 3.54 in)
Color	Gray, close to RAL7001
Material	Silicone
Connector to sensor	M8, female, 3 pins, A-coded Pin assignment: <ul style="list-style-type: none"> ▪ 1: Guard electrode ▪ 2: Not connected ▪ 3: Ground electrode ▪ 4: Sensor electrode

11.4 Input

Measurement frequency	500 kHz
Measurement span	10 pF (default) Selectable up to 200 pF →  21.  Corresponds to the 4 to 20 mA output signal.  5 pF not recommended.
Maximum measurable capacitance	500 pF  This is the maximum capacitance the device is capable to measure. It is not to be confused with the measurement span.

11.5 Output

Output signal	4 to 20 mA, galvanically isolated <ul style="list-style-type: none"> ▪ Underranging: down to 3.8 mA ▪ Overranging: up to 20.5 mA
Alarm output	< 3.6 mA

11.6 Performance characteristics

Reproducibility	0.1 % related to full-scale value (500 pF) Valid for the internal electronic insert only!
Ambient temperature effect	< 0.06 % / 10 K related to full-scale value (500 pF)

11.7 Operating conditions: Environment

General	Indoor use only
Degree of protection	IP65 as per EN 60529 Type 4X as per NEMA 250
Ambient temperature range	0 to +40 °C (32 to 104 °F)
Storage temperature	-20 to +85 °C (-4 to 185 °F)
Humidity	< 80 %
Operating altitude	≤ 2 000 m (6 500 ft) above sea level (as per IEC 61010-1 Edition 3.1)
Overvoltage category	Category II
Electromagnetic compatibility	<ul style="list-style-type: none"> ▪ Interference emission to EN 55011:2011, Electrical Equipment Class B ▪ Interference immunity in accordance with EN 61326-1:2013 (Table 2), Appendix A (Industrial) and NAMUR Recommendation NE 21:2017
Cleaning	Make sure that the cleaning agent used does not corrode the housing surface or the seals

11.8 Mechanical construction

Dimensions	→  12
Weight	Approx. 1,4 kg (3,09 lb)
Materials	Material specifications as per ANSI and DIN-EN Materials are not in contact with measured medium <ul style="list-style-type: none">▪ Cable gland: nickel-plated brass▪ Stainless steel housing F15: 316L (1.4404)▪ Cover seal: silicone▪ Pressure compensation filter: PBT-GF20, PA

12 Declarations

-

Index

A

About this document 4

C

CE mark 7

Commissioning 18

Connecting the device 16

Connecting the sensor 17

D

Data cable 8, 26

Declaration of Conformity 7

Diagnostics and troubleshooting 23

Dimensions 13

Display elements 21

Disposal 25

Document

 Function 4

 Symbols 4

Document function 4

E

Electrical connections 16

Empty calibration 18

Environment 27

Error current 24

F

Fault diagnostics 23

Full calibration 18

H

Human interface 21

I

Incoming acceptance 11

Input 27

Installation 12

Intended use 6

M

Maintenance 25

Mechanical construction 28

Mounting bracket 9

O

Operation 20

Operational safety 6

Output 27

P

Performance characteristics 27

Post connection check 17

Post installation check 15

Power supply 26

Product description 8

Product safety 7

S

Safety 6

 Intended use 6

Sensor cable 26

Servicing 25

T

Technical data 26

 Data cable 26

 Environment 27

 Input 27

 Mechanical construction 28

 Output 27

 Performance characteristics 27

 Power supply 26

 Sensor cable 26

W

Workplace safety 6



71644413

www.addresses.endress.com
