

# Safety Instructions

## Levelflex FMP50-FMP57

PROFIBUS PA, FOUNDATION Fieldbus

ATEX, IECEx: Ex ia IIC T6 Ga  
Ex ia IIC T6 Ga/Gb





# Levelflex FMP50-FMP57

PROFIBUS PA, FOUNDATION Fieldbus

## Table of contents

Associated documentation .....	4
Supplementary documentation .....	4
Certificates and declarations .....	4
Manufacturer address .....	5
Other standards .....	5
Extended order code .....	5
Safety instructions: General .....	9
Safety instructions: Specific conditions of use .....	9
Safety instructions: Installation .....	12
Safety instructions: Zone 0 .....	15
Temperature tables .....	15
Connection data .....	17

## Associated documentation

All documentation is available on the Internet:  
[www.endress.com/Deviceviewer](http://www.endress.com/Deviceviewer)  
 (enter the serial number from the nameplate).



If not yet available, a translation into EU languages can be ordered.

To commission the device, please observe the Operating Instructions pertaining to the device:

### PROFIBUS PA

- BA01005F (FMP50)
- BA01006F (FMP51, FMP52, FMP54)
- BA01007F (FMP53)
- BA01008F (FMP55)
- BA01009F (FMP56, FMP57)

### FOUNDATION Fieldbus

- BA01051F (FMP50)
- BA01052F (FMP51, FMP52, FMP54)
- BA01053F (FMP53)
- BA01054F (FMP55)
- BA01055F (FMP56, FMP57)

## Supplementary documentation

Explosion protection brochure: CP00021Z

The explosion protection brochure is available on the Internet:  
[www.endress.com/Downloads](http://www.endress.com/Downloads)

## Certificates and declarations

### EU Declaration of Conformity

Declaration Number:  
 EU 01118

The EU Declaration of Conformity is available on the Internet:  
[www.endress.com/Downloads](http://www.endress.com/Downloads)

### EU type-examination certificate

Certificate number:  
 KEMA 10 ATEX 0093 X

List of applied standards: See EU Declaration of Conformity.

### IEC Declaration of Conformity

Certificate number:  
 IECEx KEM 10.0043 X

Affixing the certificate number certifies conformity with the following standards (depending on the device version):

- IEC 60079-0 : 2017
- IEC 60079-11 : 2011
- IEC 60079-26 : 2021

**Manufacturer address**

Endress+Hauser SE+Co. KG  
 Hauptstraße 1  
 79689 Maulburg, Germany  
 Address of the manufacturing plant: See nameplate.

**Other standards**

Among other things, the following standards shall be observed in their current version for proper installation:

- IEC/EN 60079-14: "Explosive atmospheres - Part 14: Electrical installations design, selection and erection"
- EN 1127-1: "Explosive atmospheres - Explosion prevention and protection - Part 1: Basic concepts and methodology"

**Extended order code**

The extended order code is indicated on the nameplate, which is affixed to the device in such a way that it is clearly visible. Additional information about the nameplate is provided in the associated Operating Instructions.

**Structure of the extended order code**

FMP5x      –      \*\*\*\*\*      +      A\*B\*C\*D\*E\*F\*G\*..  
*(Device type)*                      *(Basic specifications)*                      *(Optional specifications)*

\* = Placeholder  
 At this position, an option (number or letter) selected from the specification is displayed instead of the placeholders.

*Basic specifications*

The features that are absolutely essential for the device (mandatory features) are specified in the basic specifications. The number of positions depends on the number of features available. The selected option of a feature can consist of several positions.

### Optional specifications

The optional specifications describe additional features for the device (optional features). The number of positions depends on the number of features available. The features have a 2-digit structure to aid identification (e.g. JA). The first digit (ID) stands for the feature group and consists of a number or a letter (e.g. J = Test, Certificate). The second digit constitutes the value that stands for the feature within the group (e.g. A = 3.1 material (wetted parts), inspection certificate).

More detailed information about the device is provided in the following tables. These tables describe the individual positions and IDs in the extended order code which are relevant to hazardous locations.

### Extended order code: Levelflex



The following specifications reproduce an extract from the product structure and are used to assign:

- This documentation to the device (using the extended order code on the nameplate).
- The device options cited in the document.

### Device type

FMP50, FMP51, FMP52, FMP53, FMP54, FMP55, FMP56, FMP57

### Basic specifications

Position 1, 2 (Approval)		
Selected option		Description
FMP50	BA	ATEX II 1 G Ex ia IIC T6...T1 Ga
	IA	IECEX Ex ia IIC T6...T1 Ga
FMP51-57	BA	ATEX II 1 G Ex ia IIC T6...T1 Ga
	BB	ATEX II 1/2 G Ex ia IIC T6...T1 Ga/Gb
	IA	IECEX Ex ia IIC T6...T1 Ga
	IB	IECEX Ex ia IIC T6...T1 Ga/Gb

Position 3 (Power Supply, Output)		
Selected option		Description
FMP5x	E	2-wire, FOUNDATION Fieldbus, switch output (PFS)
	G	2-wire, PROFIBUS PA, switch output (PFS)

<b>Position 4 (Display, Operation)</b>		
<b>Selected option</b>		<b>Description</b>
FMP5x	A	Without, via communication
	C	SD02, 4-line, push buttons + data backup function
	E	SD03, 4-line, illum., touch control + data backup function
	L <sup>1) 2)</sup>	Prepared for display FHX50 + M12 connection
	M <sup>1) 2)</sup>	Prepared for display FHX50 + custom connection
	N <sup>1) 3)</sup>	Prepared for display FHX50 + NPT1/2"

- 1) FHX50 is approved according to DEK12.0046X or DEKRA 12ATEX0151X.
- 2) In connection with Position 5 = A: Observe the specifications in the "Overvoltage protection" and "Temperature tables" chapters!
- 3) Only in connection with Position 5 = B, C

<b>Position 5 (Housing)</b>		
<b>Selected option</b>		<b>Description</b>
FMP5x	A	GT19 dual compartment, plastics PBT
	C	GT20 dual compartment, Alu coated
FMP51 FMP52 FMP54-57	B	GT18 dual compartment, 316L

<b>Position 9, 10 (Seal)</b>		
<b>Selected option</b>		<b>Description</b>
FMP50	A1	Viton, -20...80 °C
FMP51	A4	Viton, -30...150 °C
	B3	EPDM, -40...120 °C
	C3	Kalrez, -20...200 °C
	E1	FVMQ, -50...150 °C
FMP53	AD	FKM, FDA, USP Cl. VI, -10...150 °C
	B5	EPDM, FDA, USP Cl. VI, -20...130 °C
	C4	Kalrez, FDA, USP Cl. VI, -20...150 °C
FMP54	D1	Graphite, -196...280 °C (XT)
	D2	Graphite, -196...450 °C (HT)
FMP56	AB	Viton, -30...120 °C
	B3	EPDM, -40...120 °C

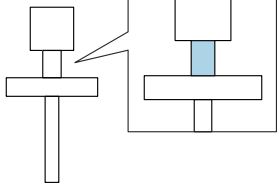
Position 9, 10 (Seal)		
Selected option	Description	
FMP57	A4	Viton, -30...150 °C
	B3	EPDM, -40...120 °C
	C5	Kalrez, -5...185 °C
<p> Shown in the temperature tables exemplary as follows:</p> 		

### Optional specifications

ID Jx (Test, Certificate)		
Selected option	Description	
FMP51 <sup>1)</sup> FMP54	JN <sup>2)</sup>	Ambient temperature transmitter -50 °C

- 1) Only in connection with Position 9, 10 = E1  
 2) Only in connection with Position 5 = B, C

ID Nx, Ox (Accessory Mounted)		
Selected option	Description	
FMP5x	NA	Overvoltage protection
FMP51 FMP52 FMP55	NC	Gas-tight feed through



**Safety instructions:**  
**General**

- The device is intended to be used in explosive atmospheres as defined in the scope of IEC 60079-0 or equivalent national standards. If no potentially explosive atmospheres are present or if additional protective measures have been taken: The device may be operated according to the manufacturer's specifications.
- Staff must meet the following conditions for mounting, electrical installation, commissioning and maintenance of the device:
  - Be suitably qualified for their role and the tasks they perform
  - Be trained in explosion protection
  - Be familiar with national regulations
- Install the device according to the manufacturer's instructions and national regulations.
- Do not operate the device outside the specified electrical, thermal and mechanical parameters.
- Only use the device in media to which the wetted materials have sufficient durability.
- Avoid electrostatic charging:
  - Of plastic surfaces (e.g. enclosure, sensor element, special varnishing, attached additional plates, ...)
  - Of isolated capacities (e.g. isolated metallic plates)
- Alterations to the device can affect the explosion protection and must be carried out by staff authorized to perform such work by Endress+Hauser.
- Refer to the temperature tables for the relationship between the permitted ambient temperature for the sensor and/or transmitter, depending on the range of application and the temperature class.
- When replacing the probe electronics or opening the connection between the remote cable and the probe, a jumper plug must be used or a short-circuit must be established between the probe contact and the potential equalization conductor to avoid electrostatically charging the probe.

**Safety instructions:**  
**Specific conditions of use**

Permitted ambient temperature range at the electronics enclosure:  
 $-40\text{ °C} \leq T_a \leq +80\text{ °C}$

*Optional specification, ID JX = JN*

Permitted ambient temperature range at the electronics enclosure:  
 $-50\text{ °C} \leq T_a \leq +80\text{ °C}$

- Observe the information in the temperature tables.
- In the case of process connections made of polymeric material or with polymeric coatings, avoid electrostatic charging of the plastic surfaces.
- To avoid electrostatic charging: Do not rub surfaces with a dry cloth.
- In the event of additional or alternative special varnishing on the enclosure or other metal parts or for adhesive plates:
  - Observe the danger of electrostatic charging and discharge.
  - Do not install in the vicinity of processes ( $\leq 0.5$  m) generating strong electrostatic charges.
- Secure probes against swinging: e.g. by fixing them to the wall or floor or by installing them in the ground tube.

*Basic specification, Position 1, 2 = BB, IB*

- The probe must not be subjected to abrasive or corrosive medium that may adversely affect the partition for the zone separation.
- The zone partition wall of the device is a gas-tight feed through made of stainless-steel adapter and glass conductor bushing.

Sensor	Zone partition wall material	Wall thickness	Diameter
FMP51-53 FMP55-57	Stainless-steel adapter	26 mm	54 mm
	Glass conductor bushing	11.2 mm	18.4 mm
	Welding seam	> 0.2 mm	-
FMP54	Stainless-steel adapter	21 mm	45 mm
	Glass conductor bushing	11.2 mm	18.4 mm
	Welding seam	> 0.2 mm	-

*Basic specification, Position 5 = A*

Avoid electrostatic charging of the enclosure (e.g. friction, cleaning, maintenance, strong medium flow).

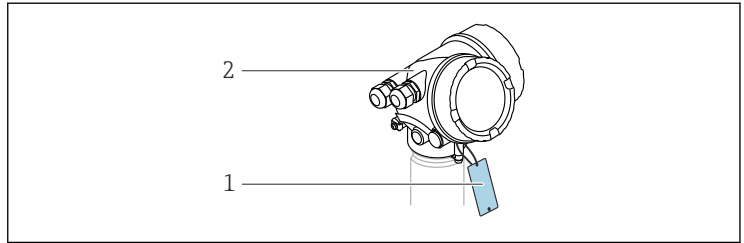

A0032146

- 1 *Isolated capacitance:*  
*with one metal plate:  $\leq 3$  pF (permitted in all areas for Equipment Groups II and III)*  
*with two to three metal plates:  $\leq 10$  pF (not permitted in Zone 0 and for Equipment Group IIC)*
- 2 *Enclosure*

*Basic specification, Position 5 = C*

In Zone 0, avoid sparks caused by impact and friction.

*Device type FMP52, FMP55 and Device type FMP5x with non-conductive plastic coated probes*

A probe coated with non-conductive material can be used if avoiding electrostatic charging (e.g. through friction, cleaning, maintenance, strong medium flow).

## Safety instructions: Installation

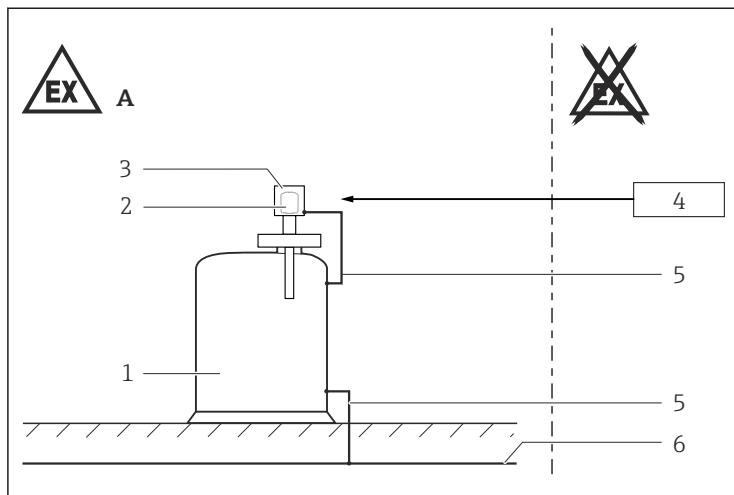

A0025536

- A Zone 0, Zone 1  
 1 Tank; Zone 0, Zone 1  
 2 Electronic insert  
 3 Enclosure  
 4 Certified associated apparatus  
 5 Potential equalization line  
 6 Potential equalization

- After aligning (rotating) the enclosure, retighten the fixing screw (see Operating Instructions).
- Install the device to exclude any mechanical damage or friction during the application. Pay particular attention to flow conditions and tank fittings.
- Continuous service temperature of the connecting cable:  $-40\text{ °C}$  to  $\geq +85\text{ °C}$ ; in accordance with the range of service temperature taking into account additional influences of the process conditions ( $T_{a,\min}$ ), ( $T_{a,\max} + 20\text{ K}$ ).

### Optional specification, ID Jx = JN

Continuous service temperature of the connecting cable:  $-50\text{ °C}$  to  $\geq +85\text{ °C}$ ; in accordance with the range of service temperature taking into account additional influences of the process conditions ( $T_{a,\min}$ ), ( $T_{a,\max} + 20\text{ K}$ ).

### Basic specification, Position 4 = N

Observe the requirements according to IEC/EN 60079-14 for conduit systems and the wiring and installation instructions of the suitable Safety Instructions (XA). In addition, observe national regulations and standards for conduit systems.

### **Intrinsic safety**

- The device is only suitable for connection to certified, intrinsically safe equipment with explosion protection Ex ia / Ex ib.
- The intrinsically safe input power circuit of the device is isolated from ground. If the device is only equipped with one input, the dielectric strength of the input is at least  $500 V_{\text{rms}}$ . If the device is equipped with more than one input, the dielectric strength of each individual input to ground is at least  $500 V_{\text{rms}}$ , and the dielectric strength of the inputs vis-à-vis one another is also at least  $500 V_{\text{rms}}$ .
- Observe the pertinent guidelines when interconnecting intrinsically safe circuits.
- The device can be connected to the Endress+Hauser FXA291 service tool: refer to the Operating Instructions and specifications in the "Overvoltage protection" chapter.
- When the intrinsically safe Ex ia circuits of the device are connected to certified intrinsically safe circuits of Category Ex ib for Equipment Groups IIC or IIB, the type of protection changes to Ex ib [ia] IIC or Ex ib [ia] IIB. Regardless of the power supply, all the internal circuits correspond to Ex ia IIC type of protection (e.g. service interface, external display, sensor).

### **Potential equalization**

- Integrate the device into the local potential equalization.
- Grounding the screen, see the following figure.

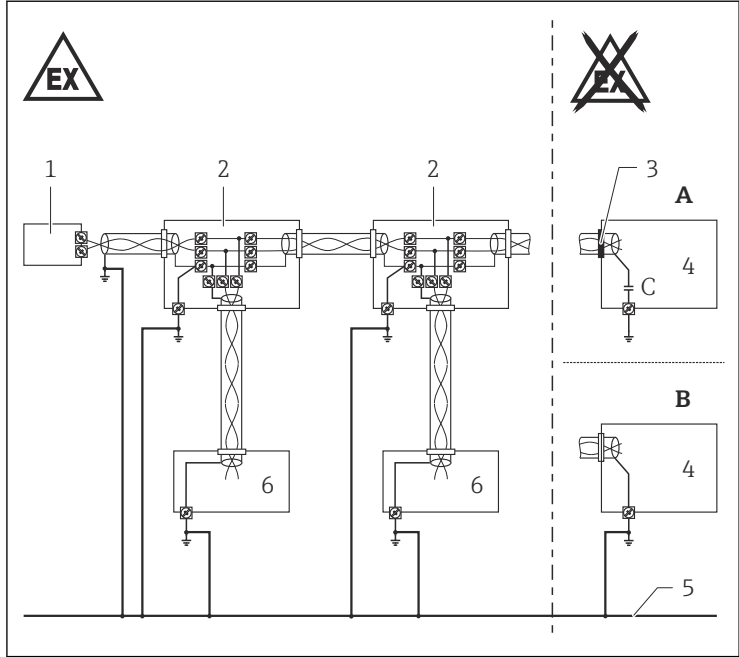

A0022352

- A Version 1: Use small capacitors (e.g. 1 nF, 1 500 V dielectric strength, ceramic). Total capacitance connected to the screen may not exceed 10 nF.
- B Version 2
- 1 Terminating resistor
  - 2 Distributor/T box
  - 3 Screen insulated
  - 4 Supply unit/Segment coupler
  - 5 Potential equalization (secured in high degree)
  - 6 Field device

### Overvoltage protection

- If an overvoltage protection against atmospheric over voltages is required: no other circuits may leave the enclosure during normal operation without additional measures.
- For installations which require overvoltage protection to comply with national regulations or standards, install the device using overvoltage protection (e.g. HAW56x from Endress+Hauser).
- Observe the safety instructions of the overvoltage protection.

Optional specification, ID Nx, Ox = NA  
(Overvoltage protection Type OVP20)

The intrinsically safe input power circuit of the device is isolated from ground. If the device is only equipped with one input, the dielectric strength of the input is at least 290 V<sub>rms</sub>. If the device is equipped with

more than one input, the dielectric strength of each individual input to ground is at least  $290 V_{\text{rms}}$ , and the dielectric strength of the inputs vis-à-vis one another is also at least  $290 V_{\text{rms}}$ .

### Safety instructions: Zone 0

- Associated devices with galvanic isolation between the intrinsically safe and non-intrinsically safe circuits are preferred.
- Only use the device in media to which the silicone rubber potting compound of the electronic insert and the enclosure made of PBT, aluminum or 316L have sufficient durability.
- If there is a risk of dangerous potential differences within Zone 0 (e.g. through the occurrence of atmospheric electricity), implement suitable measures for intrinsically safe circuits in Zone 0.

### Temperature tables

→ Safety Instructions: XA02253F

 The safety instructions for temperature tables are available on the Internet: [www.endress.com/Downloads](http://www.endress.com/Downloads)

 *Optional specification, ID Nx, Ox = NA  
(Overvoltage protection type OVP20)*

When using the internal overvoltage protection: Reduce the admissible ambient temperature at the enclosure by 5 K.

*Basic specification, Position 5 = A*

When using the remote display FHX50: Reduce the admissible ambient temperature at the enclosure by 3 K.

 Observe the permitted temperature range at the probe.

### Explanation of how to use the temperature tables

 Unless otherwise indicated, the positions always refer to the basic specification.

1st column: Position 5 = A, B, ...

2nd column: Position 3 = A, B, ..

- (1): 1 channel used
- (2): 2 channels used

3rd column: Temperature classes T6 (85 °C) to T1 (450 °C)

Column P1 to P6: Position (temperature value) on the axes of the derating

- $T_a$ : Ambient temperature in °C
- $T_p$ : Process temperature in °C

**i** Column P6 is only relevant for version B of the derating.

Example table

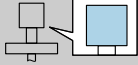
 = C	(1)	P1		P2		P3		P4		P5		P6	
		T <sub>p</sub>	T <sub>a</sub>	T <sub>p</sub>	T <sub>a</sub>	T <sub>p</sub>	T <sub>a</sub>	T <sub>p</sub>	T <sub>a</sub>	T <sub>p</sub>	T <sub>a</sub>	T <sub>p</sub>	T <sub>a</sub>
E, G	T6	-40	60	60	60	85	54	85	-40	-40	-40	-	-
	T5	-40	75	75	75	100	69	100	-40	-40	-40	-	-
	T4	-40	80	80	80	135	72	135	-40	-40	-40	-	-

Example diagrams of possible deratings

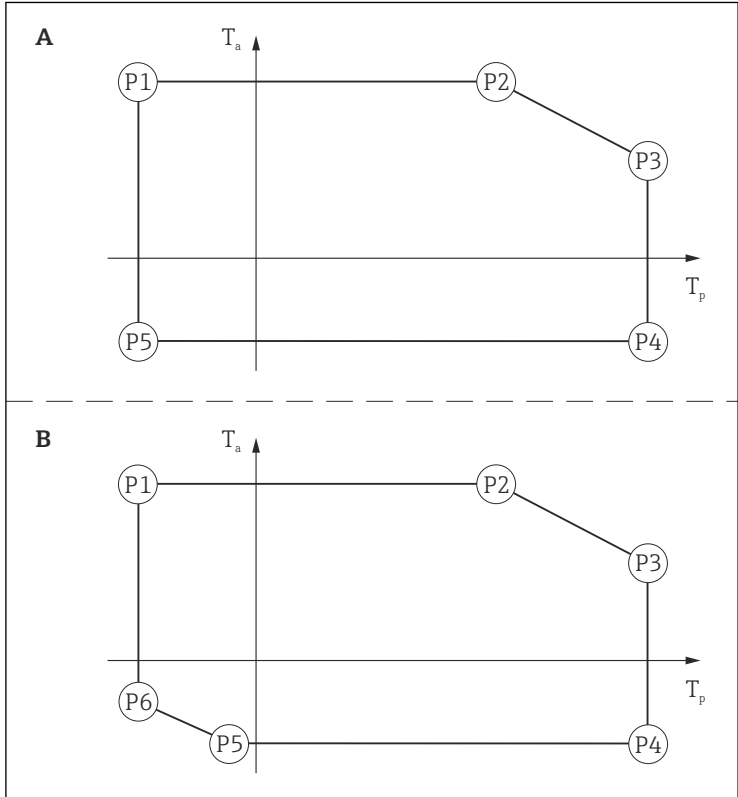

A0022717



**Connection data** *Optional specification, ID Nx, Ox = NA  
(Overvoltage protection Type OVP20)*

When using the internal overvoltage protection: No changes to the connection values.

**Ex ia**

Power supply and signal circuit with protection type: intrinsic safety  
Ex ia IIC, Ex ia IIB.

Terminal 1 (+), 2 (-)		Terminal 3 (+), 4 (-)
FISCO	Entity	Switch output (PFS)
$U_i = 17.5\text{ V}$	$U_i = 30\text{ V}$	$U_i = 30\text{ V}$
$I_i = 550\text{ mA}$	$I_i = 300\text{ mA}$	$I_i = 300\text{ mA}$
$P_i = 5.5\text{ W}$	$P_i = 1.2\text{ W}$	$P_i = 1\text{ W}$
effective inner inductance $L_i = 10\text{ }\mu\text{H}$ effective inner capacitance $C_i = 5\text{ nF}$		effective inner inductance $L_i = 0$ effective inner capacitance $C_i = 6\text{ nF}$

**Service interface (CDI)**

Taking the following values into consideration, the device can be connected to the certified Endress+Hauser FXA291 service tool or a similar interface:

Service interface													
$U_i = 7.3\text{ V}$ effective inner inductance $L_i = \text{negligible}$ effective inner capacitance $C_i = \text{negligible}$													
$U_o = 7.3\text{ V}$ $I_o = 100\text{ mA}$ $P_o = 160\text{ mW}$													
$L_o\text{ (mH)} =$	5.00	2.00	1.00	0.50	0.20	0.15	0.10	0.05	0.02	0.01	0.005	0.002	0.001
$C_o\text{ (}\mu\text{F)}^{1) =}$	0.73	1.20	1.60	2.00	2.60	-	3.20	4.00	5.50	7.30	10.00	12.70	12.70
$C_o\text{ (}\mu\text{F)}^{2) =}$	-	0.49	0.90	1.40	-	2.00	-	-	-	-	-	-	-

- 1) Values according to PTB "ispark" program
- 2) Values according to IEC/EN 60079-25, Annex C or equivalent national standards







71683041

[www.addresses.endress.com](http://www.addresses.endress.com)

---