

Operating Instructions

J22 TDLAS gas analyzer



Table of Contents

1 Introduction.....	5	5.6 Access the operating menu from the web browser	58
1.1 Document function	5	5.7 Remote operation using Modbus.....	64
1.2 Symbols used.....	5	6 Modbus communication.....	65
1.3 Documentation	6	6.1 Overview of device description files	65
1.4 U.S. export compliance.....	6	6.2 Modbus RS485 or Modbus TCP Function codes	65
1.5 Registered trademarks	6	6.3 Response time	65
1.6 Manufacturer address	7	6.4 Modbus data map	66
2 Safety	8	6.5 Modbus registers	67
2.1 Personnel qualifications.....	8	7 Commissioning	68
2.2 Potential risks affecting personnel	8	7.1 Language	68
2.3 Product safety	9	7.2 Configuring the measuring device.....	68
2.4 Device-specific IT security.....	10	7.3 Defining the tag name.....	69
3 Product description	12	7.4 Setting the analyte type	69
3.1 J22 TDLAS gas analyzer model types	12	7.5 Selecting the measurement calibration	69
3.2 Sample conditioning system components	14	7.6 Setting system units	70
3.3 Product identification.....	14	7.7 Setting the dew point	71
3.4 Equipment labels.....	15	7.8 Setting peak tracking.....	72
3.5 Symbols on the equipment	16	7.9 Configuring the communication interface.....	72
4 Installation	18	7.10 Configuring the current input.....	74
4.1 Installing the heat trace boot.....	18	7.11 Configuring the current output.....	75
4.2 Lifting and moving the analyzer	18	7.12 Configuring the switch output	76
4.3 Mounting the analyzer.....	19	7.13 Configuring the relay output.....	78
4.4 Turning the display module.....	24	7.14 Configuring the local display	79
4.5 Protective chassis and ground connections.....	25	7.15 Advanced settings.....	80
4.6 Electrical connections.....	25	8 Operation	88
4.7 Gas connections	37	8.1 Reading measured values.....	88
4.8 Metric conversion kit.....	39	8.2 Showing data logging	90
4.9 Hardware settings	40	8.3 Adapting the measuring device to the process conditions	92
4.10 Ensuring IP66 degree of protection	44	8.4 Simulation	94
5 Operation options.....	45	8.5 Protecting settings from unauthorized access... 95	
5.1 Overview of operation options.....	45	9 Verification, diagnostics and troubleshooting	99
5.2 Structure and function of the operating menu..	46	9.1 Diagnostic information from light emitting diodes.....	99
5.3 Local operation	48	9.2 Diagnostic information on local display.....	100
5.4 Accessing the operating menu through the local display	48		
5.5 Operating elements	53		

9.3	Diagnostic information in the web browser	102
9.4	Diagnostic information through the communication interface	103
9.5	Adapting the diagnostic behavior	104
9.6	Overview of diagnostic information	104
9.7	Pending diagnostic events	108
9.8	Event logbook	109
9.9	Resetting the measuring device.....	110
9.10	Device information	111
9.11	Signal alarms	112
9.12	Protocol-specific data	113
9.13	General troubleshooting	114
10	Maintenance/service.....	117
10.1	Cleaning and decontamination	117
10.2	Spare parts	117
10.3	Troubleshooting/repairs	117
10.4	Intermittent operation	122
10.5	Packing, shipping, and storage.....	123
10.6	Service contact	123
10.7	Disclaimers.....	124
10.8	Warranty	124
11	Spare parts	125
11.1	Controller	125
11.2	J22 TDLAS gas analyzer	126
11.3	J22 TDLAS gas analyzer on panel	127
11.4	J22 TDLAS gas analyzer with enclosure.....	128
11.5	Controller spare parts details.....	129
11.6	Sample conditioning system spare parts details	137
12	Technical data	150
12.1	Electrical and communications.....	150
12.2	Application data.....	150
12.3	Physical specifications.....	151
12.4	Area classification.....	151
12.5	Supported operating tools.....	153
12.6	Web server	153
12.7	HistoROM data management	153
12.8	Data backup.....	153
12.9	Manual data transfer.....	154
12.10	Automatic event list	154
12.11	Manual data logging	154
12.12	Diagnostics functions	154
12.13	Heartbeat Technology	154
13	Drawings.....	156
14	Dew point conversion.....	160
14.1	Introduction.....	160
14.2	MDP calculation	161



1 Introduction

1.1 Document function



This operating instruction contains information required to install and operate the J22 TDLAS gas analyzer. It is important to closely review the sections of this manual to ensure the analyzer performs as specified.

1.2 Symbols used







1.2.1 Warnings

Structure of Information	Meaning
 WARNING Causes (/consequences) If necessary, consequences of non-compliance (if applicable) ▶ Corrective action	This symbol alerts you to a dangerous situation. Failure to avoid the dangerous situation can result in a fatal or serious injury.
 CAUTION Causes (/consequences) If necessary, consequences of non-compliance (if applicable) ▶ Corrective action	This symbol alerts you to a dangerous situation. Failure to avoid this situation can result in minor or more serious injuries.
NOTICE Cause/situation If necessary, consequences of non-compliance (if applicable) ▶ Action/note	This symbol alerts you to situations which may result in damage to property.



1.2.2 Safety symbols

Symbol	Description
	Hazardous voltage and risk of electric shock.
	INVISIBLE LASER RADIATION - Avoid exposure to the beam. Class 3B Radiation Product. Refer servicing to manufacturer-qualified personnel.
	The Ex mark signals to Authorities Having Jurisdiction and end-users in Europe that the product complies with the essential ATEX Directive for explosion protection.

1.2.3 Informational symbols

Symbol	Meaning
	Permitted: Procedures, processes or actions that are permitted.
	Forbidden: Procedures, processes or actions that are forbidden.
	Tip: Indicates additional information.
	Reference to page
	Reference to graphic
	Notice or individual step to be observed
1., 2., 3. ...	Series of steps
	Result of a step

1.2.4 Communication symbols

Symbol	Description
	LED Light emitting diode is off.
	LED Light emitting diode is on.
	LED Light emitting diode is flashing.

1.3 Documentation

All documentation is available:

- On the USB provided with the analyzer
- Endress+Hauser's website: www.endress.com

Each analyzer shipped from the factory is packaged with documents specific to the model that was purchased. This document is an integral part of the complete document package, which also includes:

Part Number	Document Type	Description
XA02708C	Safety Instruction	Requirements for installing or operating the J22 TDLAS gas analyzer related to personnel or equipment safety for ATEX/IECEX/UKEX, cCSAus certifications.
XA03086C	Safety Instruction	Requirements for installing or operating the J22 TDLAS gas analyzer related to personnel or equipment safety for INMETRO (Brazil) certification.
XA03087C	Safety Instruction	Requirements for installing or operating the J22 TDLAS gas analyzer related to personnel or equipment safety for CML (Japan) certification.
XA03090C	Safety Instruction	Requirements for installing or operating the J22 TDLAS gas analyzer related to personnel or equipment safety for KC: ATEX/IECEX Zone 1 certification.
XA03211C	Safety Instruction	Requirements for installing or operating the J22 TDLAS gas analyzer related to personnel or equipment safety for PESO: ATEX/IECEX Zone 1 certification (for India).
TI01607C	Technical Information	Planning aid for your device. The document contains all the technical data on the analyzer.
GP01198C	Description of Device Parameters	Provides customers with Modbus register information needed to establish remote communication with the J22.
SD03286C	Special Documentation	Description, guidelines, and procedure for validation of TDLAS gas analyzers.
EA01501C	Installation Instructions	Instructions for replacing measurement components for the J22 TDLAS gas analyzer.
EA01426C	Installation Instructions	Installation instructions for the J22 and JT33 TDLAS gas analyzer firmware upgrade.
EA01507C	Installation Instructions	Installation instructions for replacing the J22 and JT33 TDLAS gas analyzer electronics and display.

For additional instruction manuals, refer to the Endress+Hauser website to download the published documentation: www.endress.com.

1.4 U.S. export compliance

The policy of Endress+Hauser is in strict compliance with U.S. export control laws as detailed in the website of the [Bureau of Industry and Security](http://www.bis.gov) at the U.S. Department of Commerce.

1.5 Registered trademarks

Modbus®

Registered trademark of SCHNEIDER AUTOMATION, INC.

1.6 Manufacturer address

Endress+Hauser
11027 Arrow Route
Rancho Cucamonga, CA 91730
United States
www.endress.com

2 Safety

Each analyzer shipped from the factory includes safety instructions and documentation to the responsible party or operator of the equipment for the purpose of installation and maintenance.

WARNING

Technicians are expected to be trained and follow all safety protocols that have been established by the customer in accordance with the area hazard classification to service or operate the analyzer.

- ▶ This may include, but is not limited to, toxic and flammable gas monitoring protocols, lockout/tagout procedures, the use of personal protective equipment (PPE) requirements, hot work permits and other precautions that address safety concerns related to the use and operation of process equipment located in hazardous areas.

2.1 Personnel qualifications

Personnel must meet the following conditions for mounting, electrical installation, commissioning and maintenance of the device. This includes, but is not limited to:

- Suitably qualified for their role and the tasks they perform
- Understand the general principles and types of protection and markings
- Understand the aspects of equipment design which affect the protection concept
- Understand the additional importance of permit to work systems and safe isolation in relation to explosion protection
- Familiar with national and local regulations and guidelines, such as CEC, NEC ATEX/IECEX or UKEX
- Familiar with lockout/tagout procedures, toxic gas monitoring protocols, and personal protective equipment (PPE) requirements

Personnel shall also be able to demonstrate competency in the:

- Use of documentation
- Production of documentation in inspection reports
- Practical skills necessary for the preparation and implementation of relevant concepts of protection
- Use and production of installation records

WARNING

Substitution of components is not permitted.

- ▶ Substitution of components may impair intrinsic safety.

2.2 Potential risks affecting personnel

This section addresses the appropriate actions to undertake when faced with hazardous situations during or before service of the analyzer. It is not possible to list all potential hazards within this document. The user is responsible for identifying and mitigating any potential hazards present when servicing the analyzer.

2.2.1 Electrocution hazard

WARNING

- ▶ Complete this action before performing any service that requires working near the main input power or disconnecting any wiring or other electrical components.
1. Shut off power at the main disconnect external to the analyzer.
 2. Only use tools with a safety rating for protection against accidental contact with voltage up to 1000V (IEC 900, ASTF-F1505-04, VDE 0682/201).

2.2.2 Laser safety

The J22 TDLAS gas analyzer is a Class 1 laser product, which poses no threat to equipment operators. The laser internal to the analyzer controller is classified Class 3B and could cause eye damage if the beam is viewed directly.

WARNING

- ▶ Before servicing, shut off all power to the analyzer.

2.3 Product safety

The J22 TDLAS gas analyzer is designed in accordance with good engineering practice to meet state-of-the-art safety requirements, has been tested, and left the factory in a condition in which it is safe to operate.

It meets general safety standards and legal requirements. It also complies with the EU directives listed in the specific EU Declaration of Conformity. Endress+Hauser confirms this by affixing the CE mark to the analyzer system.

2.3.1 General

- Adhere to all warning labels to prevent damage to the unit.
- Do not operate the device outside the specified electrical, thermal and mechanical parameters.
- Only use the device in media to which the wetted materials have sufficient durability.
- Modifications to the device can affect the explosion protection and must be carried out by staff authorized to perform such work by Endress+Hauser.
- Only open the controller cover if the following conditions are met:
 - An explosive atmosphere is not present
 - All device technical data is observed (see nameplate)
 - An electrostatic charge (e.g., caused by friction, cleaning, or maintenance) is avoided on the attached stainless steel nameplate, if present, and on painted metallic housings that are not integrated into the local potential equalization (ground) system
- In potentially explosive atmospheres:
 - Do not disconnect any electrical connections while the equipment is energized.
 - Do not open the connection compartment cover when energized or the area is known to be hazardous.
- Install the controller circuit wiring according to the Canadian Electrical Code (CEC) respective National Electrical Code (NEC) using threaded conduit or other wiring methods in accordance with articles 501 to 505, and/or IEC 60079-14.
- Install the device according to the manufacturer's instructions and regulations.
- The flameproof joints of this equipment are outside the minimums specified in IEC/EN 60079-1 and shall not be repaired by the user.

2.3.2 General pressure

The system is designed and tested with appropriate margins to ensure that it is safe under normal operating conditions, which include temperature, pressure, and gas content. The operator is responsible for ensuring that the system is shut off when these conditions are no longer valid.

2.3.3 Electrostatic discharge

The coating and the adhesive label is non-conducting and may generate an ignition capable level of electrostatic discharge under certain extreme conditions. The user should ensure that the equipment is not installed in a location where it may be subjected to external conditions, such as high pressure steam, which may cause a build-up of electrostatic charges on non-conducting surfaces. To clean the equipment, use only a damp cloth.

2.3.4 Chemical compatibility

Never use vinyl acetate, acetone, or other organic solvents to clean the analyzer housing or labels.

2.3.5 Canadian Registration Number

In addition to the requirements above for general pressure safety, Canadian Registration Number (CRN) systems must be maintained using CRN approved components without any modification to the sample conditioning system (SCS) or analyzer.

2.3.6 IT security

Our warranty is valid only if the device is installed and used as described in the Operating Instructions. The device is equipped with security mechanisms to protect it against any inadvertent changes to the settings.

IT security measures, which provide additional protection for the device and associated data transfer, must be implemented by the operators themselves in line with their security standards.

2.4 Device-specific IT security

The device offers a range of specific functions to support protective measures on the operator's side. These functions can be configured by the user and guarantee greater operational safety if used correctly. An overview of the most important functions is provided in the following section.

Function/interface	Factory setting	Recommendation
Write protection from hardware write protection switch	Not enabled	On an individual basis following risk assessment.
Access code (also applies for web server login)	Not enabled (0000)	Assign a customized access code during commissioning.
WLAN (order option in display module)	Enabled	On an individual basis following risk assessment.
WLAN security mode	Enabled (WPA2- PSK)	Do not change.
WLAN passphrase (password)	Serial number	Assign an individual WLAN passphrase during commissioning.
WLAN mode	Access Point	On an individual basis following risk assessment.
Web server	Enabled	On an individual basis following risk assessment.
CDI-RJ45 service interface	–	On an individual basis following risk assessment.

2.4.1 Protecting access through hardware write protection

Write access to the device parameters from the local display and the web browser can be disabled with a write protection switch (DIP switch on the motherboard). When hardware write protection is enabled, only read access to the parameters is possible.

Hardware write protection is disabled when the device is delivered. See *Using the write protection switch* → .

2.4.2 Protecting access with a password

Different passwords are available to protect write access to the device parameters or access to the device through the WLAN interface:

- **User-specific access code.** Protect write access to the device parameters from the local display or web browser. Access authorization is clearly regulated through the use of a user-specific access code.
- **WLAN passphrase.** The network key protects a connection between an operating unit (e.g., notebook or tablet) and the device through the WLAN interface that can be ordered as an option.
- **Infrastructure mode.** When the device is operated in infrastructure mode, the WLAN passphrase corresponds to the WLAN passphrase configured on the operator side.

2.4.3 User-specific access code

Write access to the device parameters through the local display and web browser can be protected by the modifiable, user-specific access code. Refer to *Write protection through access code* → . When the device is delivered, the device does not have an access code and is equivalent to **0000** (open).

2.4.4 Access from web server

The device can be operated and configured from a web browser with the integrated web server. Refer to *Access the operating menu from the web browser* → . The connection is through the service interface (CDI-RJ45), the connection for TCP/IP signal transmission (RJ45 connector), or the WLAN interface.

The web server is enabled when the device is delivered. The web server can be disabled if necessary (e.g., after commissioning) from the **web server functionality** parameter.

The J22 TDLAS gas analyzer and status information can be hidden on the login page. This prevents unauthorized access to the information.

2.4.5 Access through service interface

The device can be accessed from the service interface (CDI-RJ45). Device specific functions guarantee the secure operation of the device in a network.

NOTICE

- ▶ Connection to the service interface (CDI-RJ45) shall only be permitted by trained personnel on a temporary basis for the purpose of test, repair or overhaul of the equipment, and only if the area where the equipment is to be installed is known to be non-hazardous.

The use of relevant industrial standards and guidelines that have been defined by national and international safety committees, such as IEC/ISA62443 or the IEEE, is recommended. This includes organizational security measures such as the assignment of access authorization as well as technical measures such as network segmentation.

3 Product description

3.1 J22 TDLAS gas analyzer model types

The J22 TDLAS gas analyzer is available in several configurations, including the stand-alone analyzer or an analyzer with sample system panel mount or enclosure.

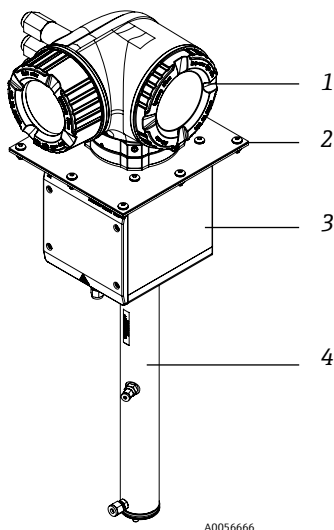

Fig 1. J22 TDLAS gas analyzer configuration

#	Description
1	Controller
2	Mounting plate (optional)

#	Description
3	Optical head enclosure assembly
4	Measurement cell assembly

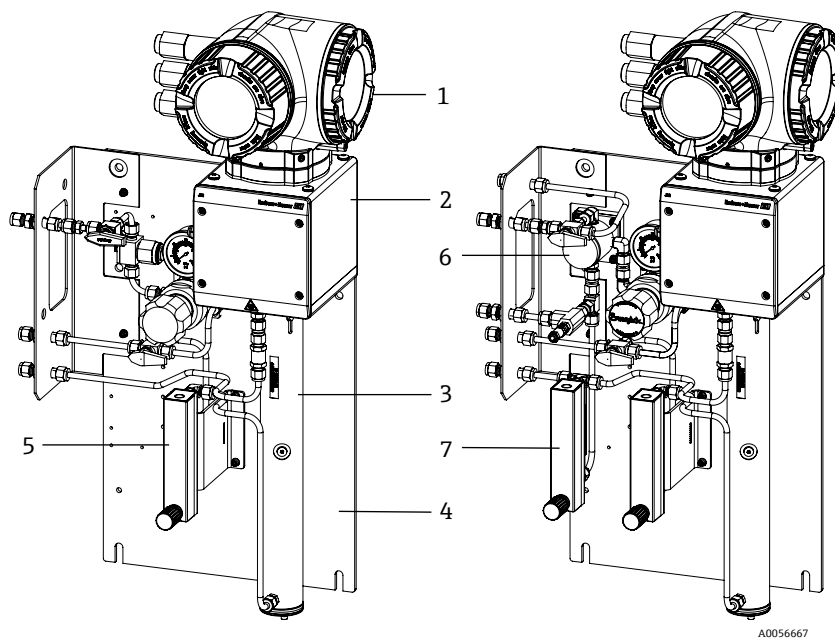

Fig 2. J22 TDLAS gas analyzer on panel with flow meter options (1)

#	Description
1	Controller
2	Optical head enclosure assembly
3	Measurement cell assembly
4	Sample system panel

#	Description
5	Flow meter - 1 (analyzer)
6	Membrane separator with bypass
7	Flow meters - 2 (bypass and analyzer)

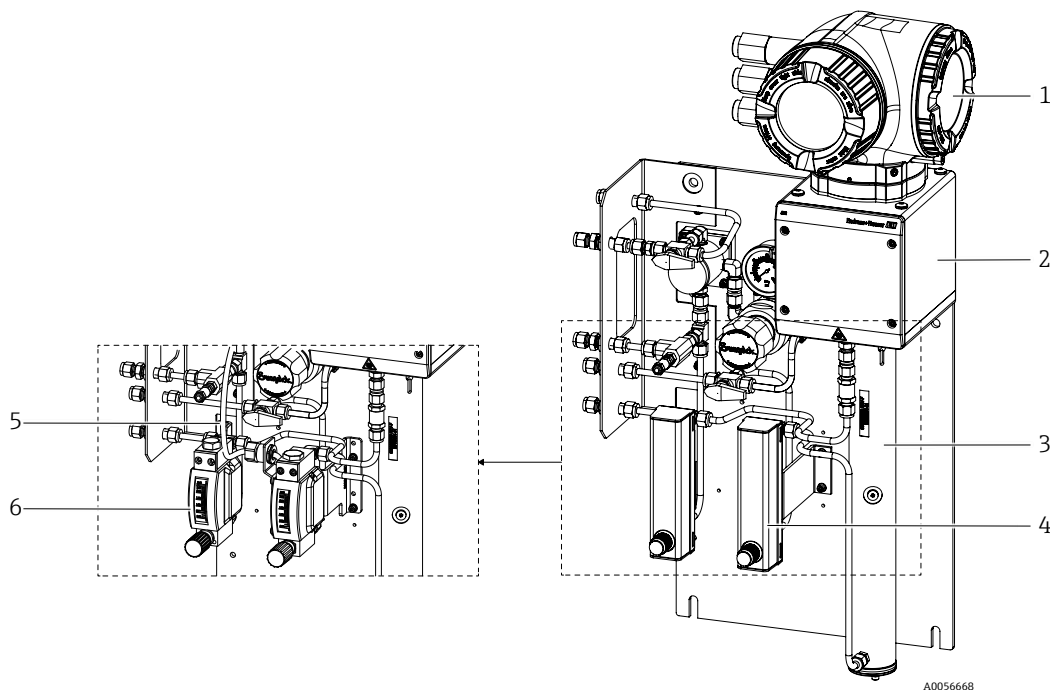

Fig 3. J22 TDLAS gas analyzer on panel with flow meter options (2)

#	Description
1	Controller
2	Optical head enclosure assembly
3	Measurement cell assembly

#	Description
4	Flow meters (bypass and analyzer, optional)
5	Flow sensor wire (optional)
6	Armored flow meters (optional)

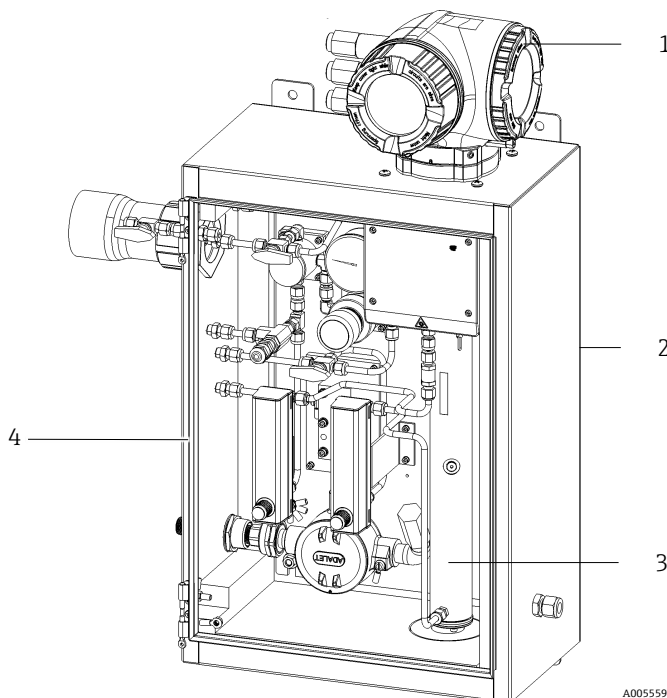

Fig 4. J22 TDLAS gas analyzer with enclosed SCS (sample conditioning system)

#	Description
1	Controller
2	Optical head enclosure assembly

#	Description
3	Measurement cell assembly
4	Sample system in an enclosure

3.2 Sample conditioning system components

A sample conditioning system (SCS) is optional with the J22. The SCS has been specifically designed to deliver a sample stream that is representative of the process systems stream at the time of sampling. J22 analyzers are designed for use with extractive natural gas sampling stations. The following shows the SCS and describes the standard and optional components available and the gas connections.

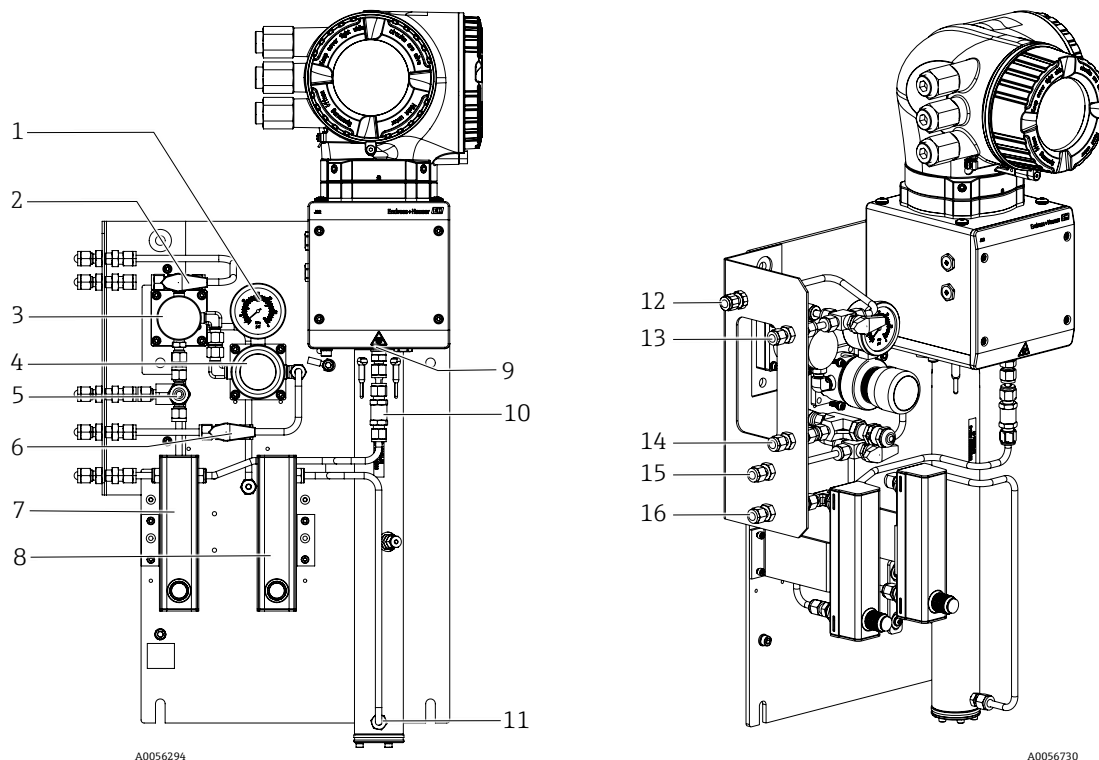

Fig 5. J22 TDLAS gas analyzer with SCS on panel - sample system and gas connections

#	Description
1	Pressure gauge
2	Gas select valve (purge in/sample in)
3	Membrane separator (optional)
4	Pressure regulator
5	Pressure relief valve (optional)
6	Reference gas on/off
7	Bypass flow indicator and control (optional)
8	Analyzer flow indicator and control

#	Description
9	Cell outlet port
10	Check valve (optional)
11	Cell inlet port
12	Sample purge in, 140-310 kPa (20-45 psi) (optional)
13	Sample in, 140-310 kPa (20-45 psi)
14	Relief vent, Factory set, 350 kPa (50 psig) to safe area (optional)
15	Reference gas in, 15-70 kPa (2-10 psi)
16	Sample vent, to safe area

3.3 Product identification

The following options are available for identification of the measuring device:

- Nameplate specifications
- Order code with breakdown of the analyzer features on the delivery note

For an overview of the scope of the associated technical documentation, refer to *Associated documentation*.

3.4 Equipment labels

3.4.1 Nameplate

Analyzer-specific information, approvals, and warnings are listed on these labels in the blank areas shown below.

Warning: DO NOT OPEN IN AN EXPLOSIVE ATMOSPHERE is listed on all nameplates.

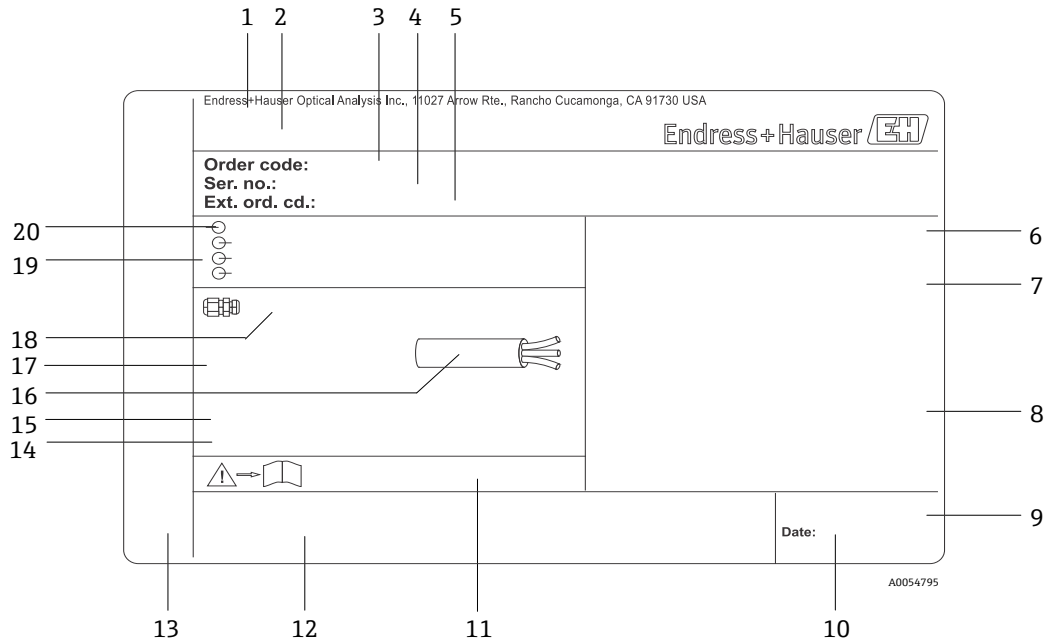

Figure 6. J22 TDLAS gas analyzer nameplate template

#	Description
1	Manufacturing name and location
2	Product name
3	Order code
4	Serial number (SN)
5	Extended order code
6	Degree of protection
7	Space for approvals for use in hazardous areas, certificate numbers, and warnings
8	Electrical connection data: available inputs and outputs
9	2-D matrix code (serial number)
10	Manufacturing date: year-month

#	Description
11	Document number of safety-related supplementary documentation
12	Space for approval markings (e.g., CE mark)
13	Space for degree of protection of connection and electronics compartment when used in hazardous areas
14	Space for additional information (special products)
15	Permitted temperature range for cable
16	Permitted ambient temperature (Ta)
17	Information on cable gland
18	Cable entry
19	Available inputs and outputs, supply voltage
20	Electrical connection data: supply voltage

3.4.2 Order code

The analyzer can be reordered using the appropriate order code as found on the Nameplate in the figure.

Extended order code

The complete extended order code including the analyzer model (product root) and basic specifications (mandatory features) are always listed. A description of the features and options found in the order code can be found on endress.com under the J22 product page.

3.5 Symbols on the equipment

3.5.1 Electrical symbols

Symbol	Description
	Protective Earth (PE) A terminal which is bonded to conductive parts of equipment for safety purposes and is intended to be connected to an external protective earthing system.

3.5.2 Informational symbols

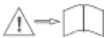
Symbol	Description
	Refer to the Technical Documentation for more information.

3.5.3 Warning symbols

Symbol	Description
	INVISIBLE LASER RADIATION - Avoid exposure to the beam. A Class 3B laser is used inside the measurement cell, accessible only during service or repair. Refer servicing to manufacturer-qualified personnel.

3.5.4 Controller labels

POWER
Nicht unter Spannung offen
Do not open when energized
Ne pas ouvrir sous tension

Terminate power prior to accessing equipment to prevent damage to the analyzer.

Warning: DO NOT OPEN IN
EXPLOSIVE ATMOSPHERE
Attention: NE PAS OUVRIR EN
ATMOSPHERE EXPLOSIVE

Use caution before opening the analyzer enclosure to avoid injury.

3.5.5 Laser safety labels

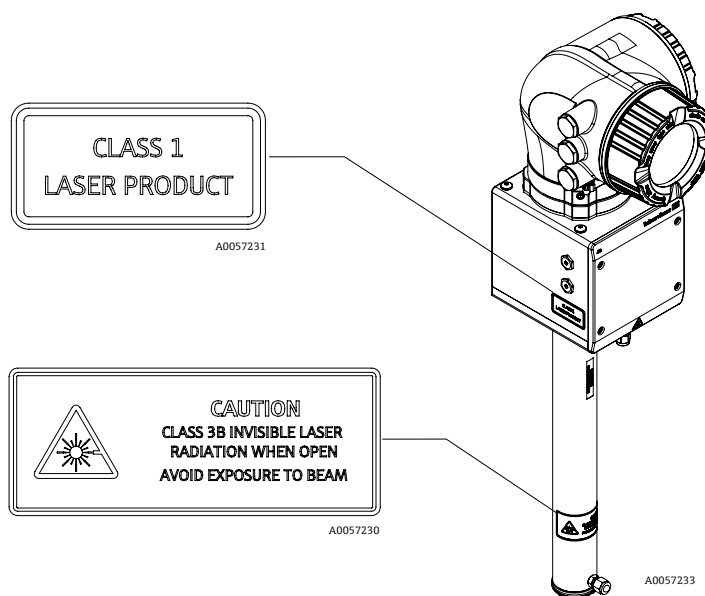

Fig 7. Location of laser safety labels

4 Installation

For safety requirements and guidance, refer to *Safety* → . For environmental and wiring requirements, refer to *Technical Data* → .

Tools and hardware

- T20 Torx screwdriver
- 24 mm open-ended wrench
- 3 mm flat blade screwdriver
- #2 Phillips screwdriver
- 1.5 mm hex driver
- 3 mm hex driver
- Tape measure
- Felt-tip marker
- Level
- Seamless, stainless steel tubing (electro-polished). Tubing thickness depends on the type of gas connections ordered:
 - For metric gas connections: 6 mm O.D. x 1 mm tubing thickness
 - For imperial gas connections: ¼" O.D. x 0.035" tubing thickness

4.1 Installing the heat trace boot

The heat trace boot for J22 TDLAS gas analyzer with an enclosure is an available option. For ease of shipping, the heat trace boot may have been removed at the factory. To reinstall the heat trace boot, follow the instructions below.

Tools and hardware

- Bushing
- Lubricated O-ring
- Heat trace boot

To install the heat trace boot

1. Locate the appropriate opening on the exterior of the sample conditioning system where labeled.
2. Open the sample conditioning system enclosure door and insert the bushing into the opening until the base is flush against the inside wall of the enclosure.
3. Apply the lubricated O-ring to the threaded bushing on the outside of the enclosure until flush against the outside wall.

NOTICE

- ▶ Ensure there is no contamination of the O-ring lubricant prior to installation.
4. Holding the threaded connector from the inside of the enclosure, thread the boot onto the bushing and turn in a clockwise motion until hand tight.
 5. Torque the 2 in (approximately 50 mm) plastic heat trace boot to 7 Nm (63 lbf-in).

NOTICE

- ▶ Do not overtighten. The boot assembly can break.

4.2 Lifting and moving the analyzer

The analyzer should be lifted and moved by a minimum of two individuals.

NOTICE

- ▶ Never lift the analyzer by the controller enclosure or conduit runs, cable glands, cables, tubing, or any other part protruding through the enclosure wall or edge of the panel or enclosure.
- ▶ Always carry the load using the following points/method shown under section Mounting the Analyzer.

CAUTION

- ▶ Distribute the weight evenly among personnel to avoid injury.

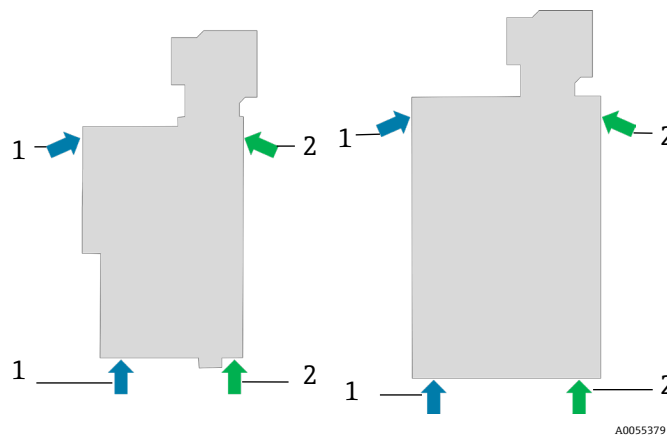

Fig 8. J22 lifting positions for panel (left) and enclosure (right) installations

#	Description
1	Person 1 hand positions
2	Person 2 hand positions

4.3 Mounting the analyzer

Mounting is based on the style of analyzer. When ordered without a sample conditioning system, the J22 can be installed with an optional mounting plate for installation. When installed with a sample conditioning system, the analyzer can be wall or post-mounted.

When mounting the analyzer, position the instrument so that it is not difficult to operate adjacent devices. Refer to the layout diagrams in *Drawings* → for detailed mounting dimensions.

4.3.1 Analyzer-only mounting

When the J22 is ordered without a sample conditioning system then there are several mounting options. The analyzer will ship with a rear panel mount bracket. The bracket is affixed to the optical enclosure with four M6 x 1.0 tapered screws. Four additional mounting holes allow the user to mount the analyzer to their own panel.

The plate mounting option is designed for users who will install the J22 analyzer within their own enclosure. The J22 should be installed vertically with the analyzer controller exposed to the exterior of the enclosure.

Hardware required

- Mounting hardware (supplied with plate)
- Gasket (supplied with plate, not required for rear panel mount bracket)
- For rear panel mount installations: user-supplied M6 screws are required to secure the analyzer to the panel.

To mount the analyzer

1. Refer to the mounting bracket dimensions in *Drawings* → to provide a proper cut-out in the customer-supplied enclosure.
2. For plate-mount installations, lower the analyzer through the enclosure hole so the plate aligns with the gasket.
3. Secure analyzer in place with eight M6 x 1.0 screws and corresponding nuts. Tighten to a minimum 13 Nm (115 lbf-in).

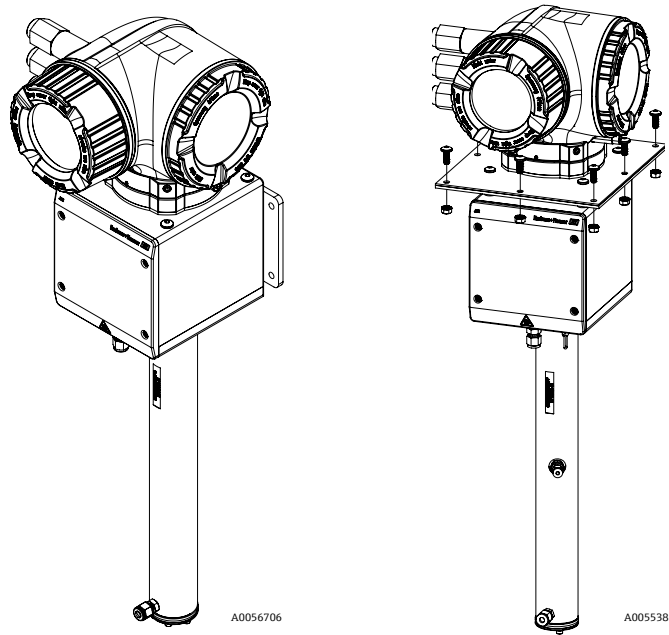

Fig 9. Rear-panel and plate mounting bracket and hardware

4.3.2 Wall mounting

NOTICE

The J22 TDLAS gas analyzer is designed for operation within the specified ambient temperature range. Intense sun exposure in some areas may cause the temperature inside the analyzer to exceed the ambient temperature specification.

- ▶ A sunshade or canopy installed over the analyzer for outdoor installations is recommended in those instances.
- ▶ Hardware used for mounting the J22 TDLAS gas analyzer must be able to support 4 times the weight of the device, approximately 19 kg (40 lb) to 43 kg (95 lb), depending on configuration.

Tools and hardware

- Mounting hardware
- Spring nuts
- Machine screws and nuts to fit the size of the mounting hole

To install the enclosure

1. Install the bottom 2 mounting bolts to the mounting frame or wall. Do not fully tighten the bolts. Leave approximately a 10 mm (¼ in) gap to slide the analyzer mounting tabs onto the bottom bolts.
2. Safely lift the analyzer using the appropriate installation equipment. Refer to *Lifting and moving the analyzer* → .
3. Lift the analyzer onto the bottom bolts and slide the slotted bottom mounting tabs over the bolts. Allow the two bottom bolts to take the weight of the analyzer while stabilizing in a vertical orientation.

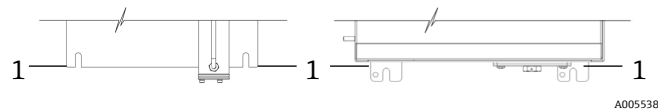

Fig 10. J22 slotted tab locations (1) for panel (left) and enclosure (right) mounts

4. Tilt the analyzer towards the mounting frame or wall to align and secure the 2 top bolts.



Figure 11. Top mounting tabs of enclosure

5. Tighten all 4 bolts.

4.3.3 Panel Mounting

For the J22 TDLAS gas analyzer with a panel-mounted sample conditioning system, four spacers are provided as stand-offs between the rear of the panel and the mounting surface to create clearance for the screws on the back of the panel. Install the factory-provided spacers as shown below.

Spacer (P/N 1300002478) dimensions:

- OD: 19 mm (0.75 in)
- ID: 8.1 mm (0.32 in)
- Thickness: 13 mm (0.51 in)

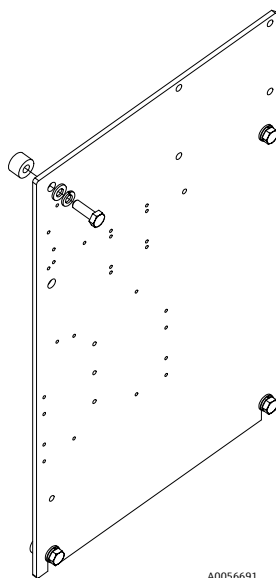



Fig 12. J22 panel spacers

4.3.4 Plate mounting

The plate mounting option is designed for users who will install the J22 analyzer within their own enclosure. The J22 should be installed vertically with the analyzer controller exposed to the exterior of the enclosure.

i When mounting the analyzer, position the instrument so that it is not difficult to operate adjacent devices.

Tools and hardware

- Mounting hardware (supplied with plate)
 - Gasket (supplied with plate)
1. Refer to the mounting plate dimensions in *Drawings* →  to provide a proper cut-out in the customer-supplied enclosure.
 2. Lower analyzer through the enclosure hole so the plate aligns with the gasket.
 3. Secure analyzer in place with eight M6 x 1.0 screws and corresponding nuts. Tighten to a minimum 13 Nm (115 lbf-in).

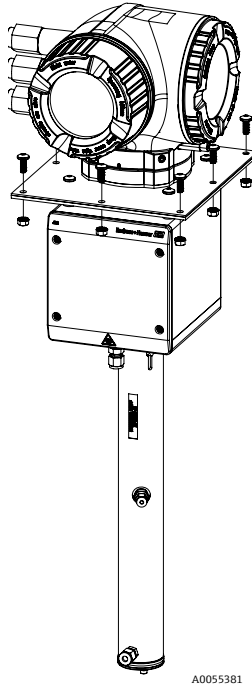

Fig 13. Plate mounting bracket and hardware

4.3.5 Post mounting

NOTICE

The J22 TDLAS gas analyzer is designed for operation within the specified ambient temperature range. Intense sun exposure in some areas may cause the temperature inside the analyzer to exceed the ambient temperature specification.

- ▶ A sunshade or canopy installed over the analyzer for outdoor installations is recommended in those instances.
- ▶ When mounting the analyzer, position the instrument so that it is not difficult to operate adjacent devices.
- ▶ Hardware used to mount the J22 TDLAS gas analyzer must be able to support four times the weight of the device, approximately 19 kg (40 lb) to 43 kg (95 lb) depending on configuration.

Tools and hardware

- Mounting hardware
- Channel nuts
- Machine screws, bolts and nuts to fit the size of the mounting hole
- Washers
- Fastener clamps
- Support rails

1. Insert proper length bolts with washers through the fastener clamp and install into the M10 channel nuts (1).

Bolt Length	Post Diameter	
	Distance (mm)	Distance (in)
M10 x 1.5 x 120	60 to 79 mm	2.4 to 3.1 in
M10 x 1.5 x 150	79 to 92 mm	3.1 to 3.6 in
M10 x 1.5 x 170	92 to 102 mm	3.6 to 4.0 in

2. Torque both bolts to 24.5 Nm (216.9 lbf-in).
3. Position channel nuts 172 mm (6.8 in) apart in the support rail (2).

NOTICE

- ▶ Ensure channel nuts are seated properly in the channel (2).

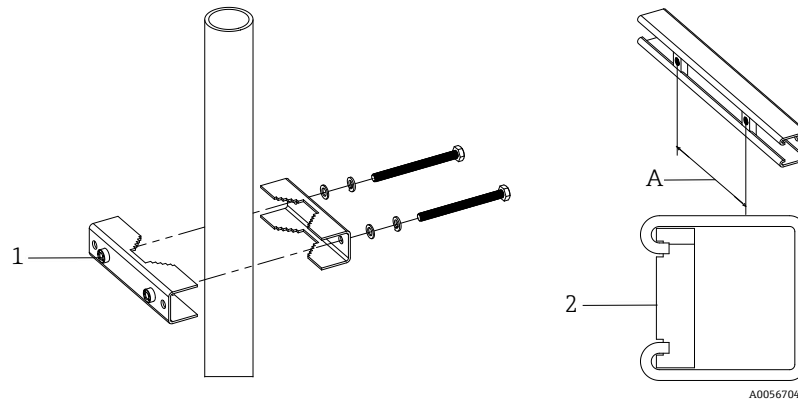

Fig 14. Channel nut installation on support rail

#	Description
1	Channel nut through hole
2	Support rail
A	172 mm

4. Insert bolts and washers into the through-holes in the fastener clamp (4).
5. Install the support rail onto the post mount assembly using the provided channel nuts (3).

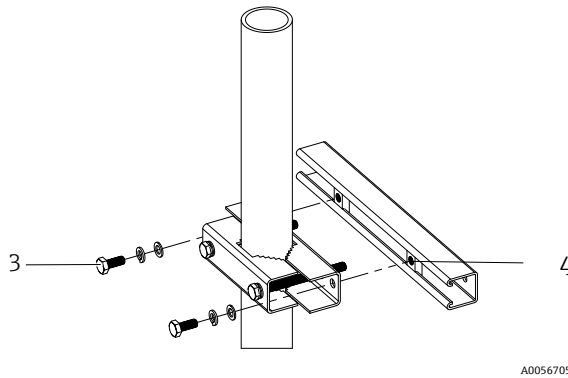

Fig 15. Support rail installation

#	Description
3	Channel nut
4	Support rail

6. Torque bolts to 24.5 Nm (216.9 lbf-in).

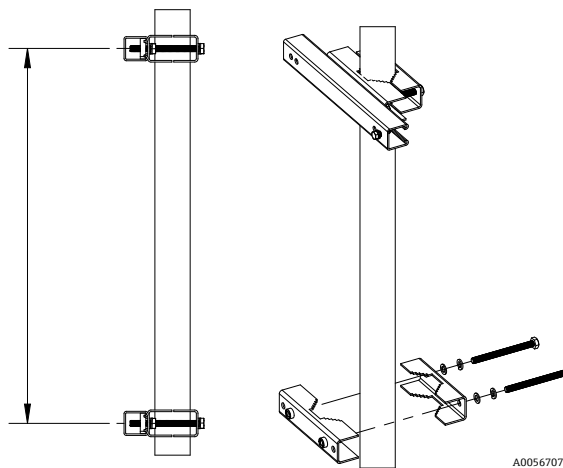

Fig 16. Support rail installation

7. Place clamps on post based on the system configuration.

System Type	Distance (mm)	Distance (in)
J22 TDLAS gas analyzer with SCS on Panel	337	13.3
J22 TDLAS gas analyzer with Enclosed SCS	641	25.2

8. Repeat steps 1 through 6 for second support rail.
9. Insert M8-1.25 x 25 bolts into support rail and through-holes on the enclosure or sample system panel.

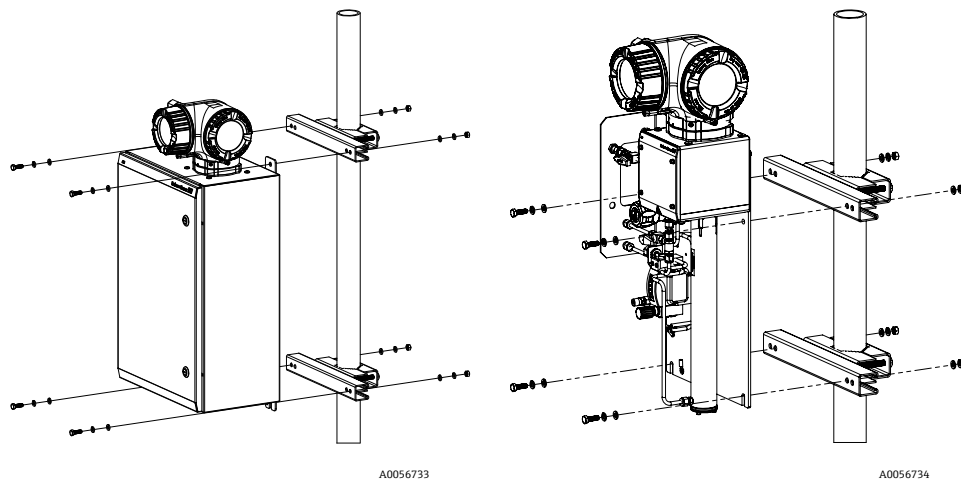

Fig 17. Support rail installation

10. Insert washers and M8 nuts on the back side of the support rail.
11. Torque bolts to 20.75 Nm (183.7 lbf-in).

4.4 Turning the display module

The display module can be turned to optimize readability and operability.

1. Loosen the securing clamp of the connection compartment cover.
2. Unscrew the connection compartment cover.
3. Turn the display module to the desired position: max. $8 \times 45^\circ$ in every direction.

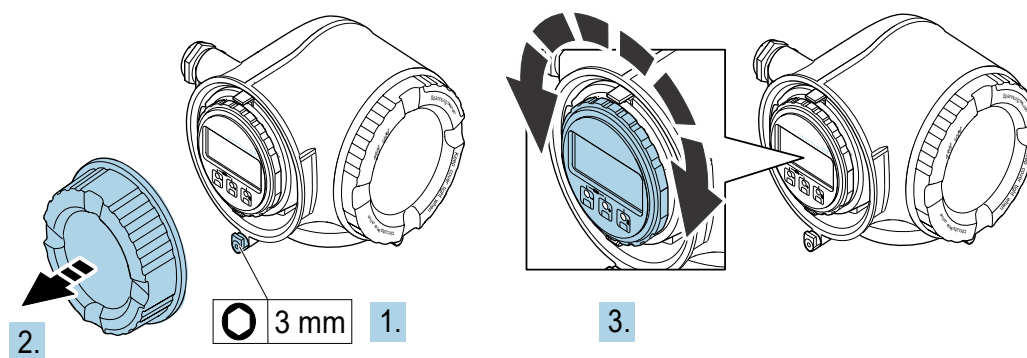

Fig 18. Turning the display module

4. Screw on the connection compartment cover.
5. Fit the securing clamp of the connection compartment cover.

4.5 Protective chassis and ground connections

Before connecting any electrical signal or power, connect the protective and chassis grounds.

Requirements for protective chassis and ground connections are as follows:

- Protective and chassis grounds must be of equal or greater size than any other current-carrying conductors, including the heater located in the sample conditioning system.
- Protective and chassis grounds to remain connected until all other wiring is removed.
- Protective grounding wire current carrying capacity must be the same as the main supply, at a minimum.
- Earth bonding/chassis ground shall be at least 6 mm² (10 AWG).

Protective ground cables

- Analyzer: 2.1 mm² (14 AWG)
- Enclosure: 6 mm² (10 AWG)

The grounding impedance must be less than 1 Ω.

WARNING

The optional stainless steel label tag is not bonded to earth.

- ▶ The maximum average capacitance of the tag determined by measurement is maximum 30 pF. This shall be considered by the user to determine suitability of the equipment in a specific application.

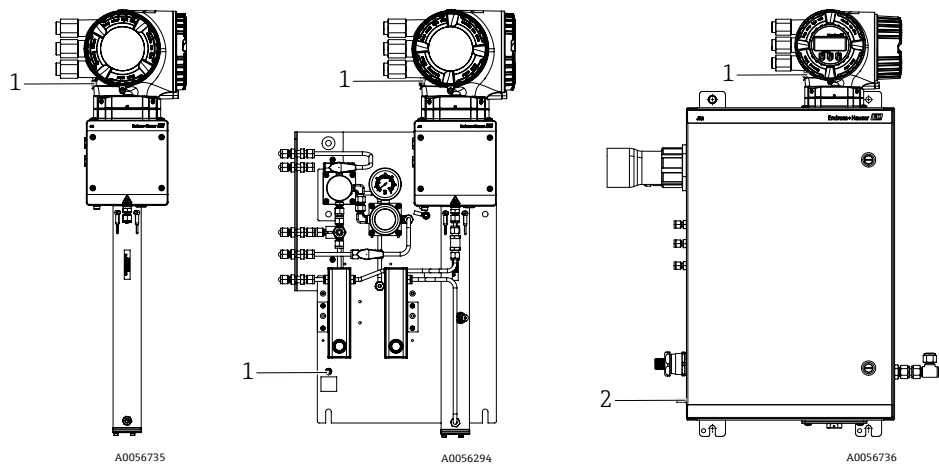

Fig 19. Ground connections

#	Description
1	Protective ground screw, M6-1.0 x 8 mm, ISO-4762
2	Protective ground stud, M6 x 1.0 x 20 mm

4.6 Electrical connections

WARNING

Hazardous voltage and risk of electric shock.

- ▶ Turn off lockout system power before opening the electronics enclosure and making any connections.

The installer is responsible for complying with all local installation codes.

- ▶ Field wiring (Power and Signal) shall be accomplished using wiring methods approved for hazardous locations as per the Canadian Electrical Code (CEC) Appendix J, the National Electric Code (NEC) Article 501 or 505 and IEC 60079-14.
- ▶ Use copper conductors only.
- ▶ For models of the J22 TDLAS gas analyzer with the SCS mounted within an enclosure, the inner sheath of the supply cable for the heater circuit shall be sheathed with thermoplastic, thermosetting, or elastometric material.

It shall be circular and compact. Any bedding or sheath shall be extruded. Fillers, if any, shall be non-hygroscopic.

- ▶ The minimum length of the cable shall exceed 3 meters.

Analyzer electrical connections

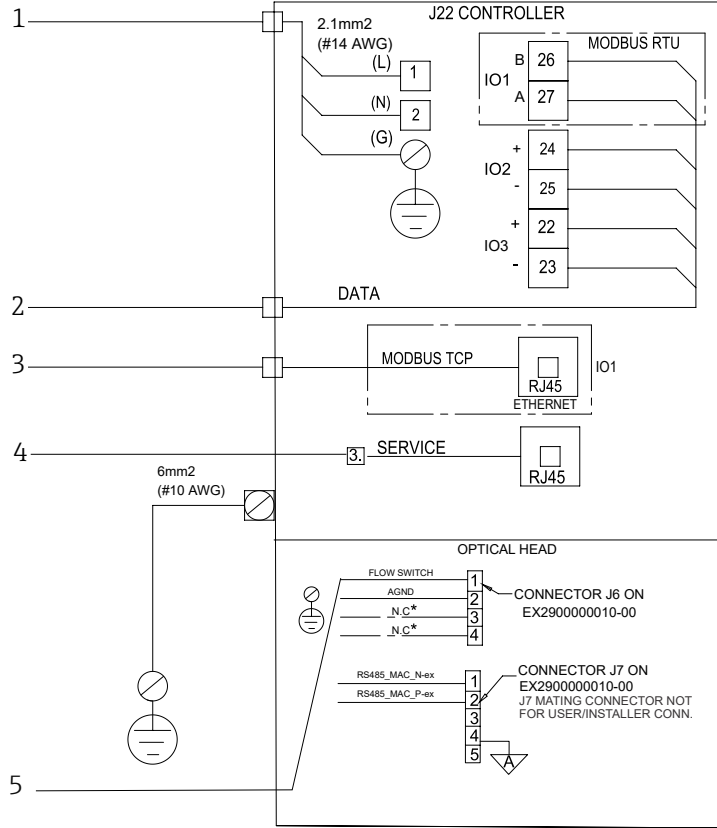

A0055382

Fig 20. J22 analyzer electrical connections

#	Description
1	AC 100 to 240 VAC ± 10%; DC 24 VDC ± 20%
2	IO options: Modbus RTU, 4-20 mA/Status out, Relay
3	10/100 Ethernet (optional), Network option Modbus TCP

#	Description
4	Connection to the Service port shall only be permitted temporarily by trained personnel for test, repair or overhaul of the equipment, and if the area where the equipment is installed is known to be non-hazardous
5	Flow switch connection

Terminals 26 and 27 are used for Modbus RTU (RS485) only. Terminals 26 and 27 are replaced by an RJ45 connector for Modbus TCP. N.C. is used for “No connection.”

NOTICE

Connector J7 on the optical head is for Endress+Hauser factory connection only.

- ▶ Do not use for installation or customer connection.

4.6.1 External cable entry points

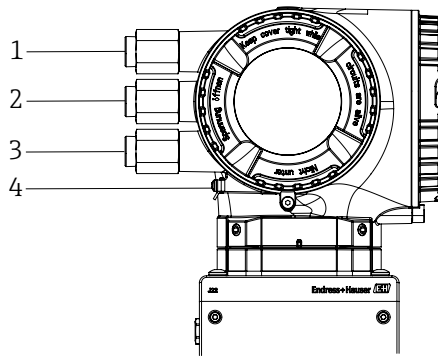

A0056737

Fig 21. Threaded entries

#	Description	#	Description
1	Cable entry for supply voltage	3	Cable entry for signal transmission; IO2, IO3
2	Cable entry for signal transmission; IO1, or Modbus RS485, or Ethernet network connection (RJ45)	4	Protective earth ground

4.6.2 Connecting Modbus RS485

Opening the terminal cover

1. Loosen the securing clamp of the connection compartment cover.
2. Unscrew the connection compartment cover.
3. Squeeze the tabs of the display module holder together.
4. Remove the display module holder.

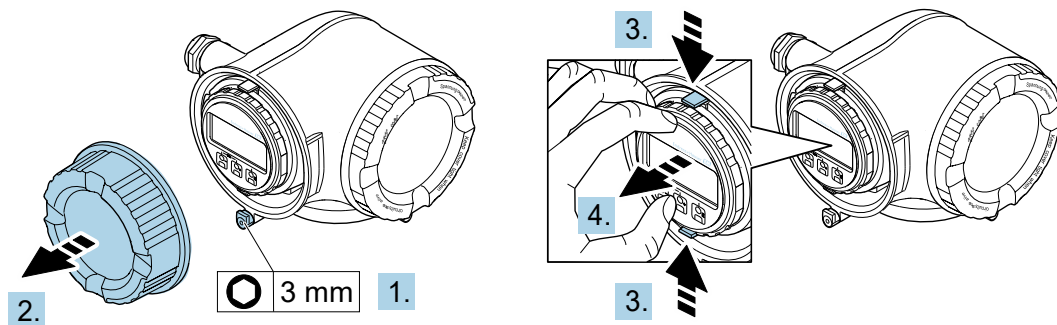

A0029813

Fig 22. Removing the display module holder

5. Attach the holder to the edge of the electronics compartment.
6. Open the terminal cover.

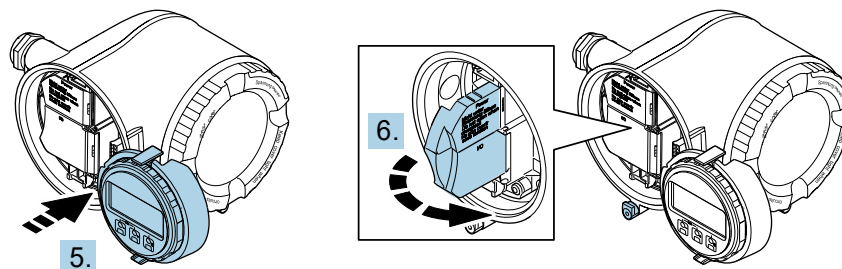

A0029814

Fig 23. Opening the terminal cover

Connecting the cables

1. Push the cable through the cable entry. To ensure tight sealing, do not remove the sealing ring from the cable entry.

NOTICE

- The temperature of the J22 TDLAS gas analyzer can reach 67 °C (153 °F) in 60 °C (140 °F) ambient at the cable entry and branching point. This must be considered when selecting field wiring and cable entry devices.

2. Strip the cable and cable ends. In the case of stranded cables, also fit ferrules.
3. Connect the protective ground.

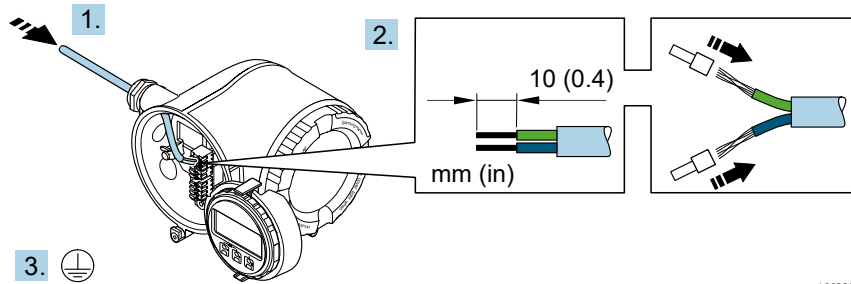

Fig 24. Feeding wiring and connecting the protective ground

4. Connect the cable in accordance with the **signal cable terminal assignment**. The device-specific terminal assignment is documented on an adhesive label in the terminal cover.
5. Firmly tighten the cable glands.

↳ This concludes the cable connection process.

i Step 5 is not used for CSA-certified products. Under CEC and NEC requirements, conduit is used in place of cable glands.

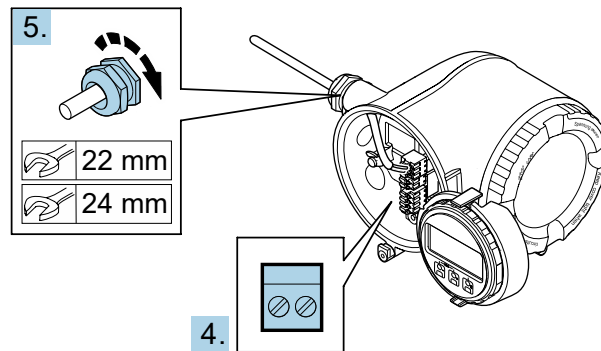

Fig 25. Connecting the cables and tightening glands

6. Close the terminal cover.
7. Fit the display module holder in the electronics compartment.
8. Screw on the connection compartment cover.
9. Secure the securing clamp of the connection compartment cover.

4.6.3 Connecting Modbus TCP

In addition to connecting the device through Modbus TCP and the available inputs/outputs, connecting through the service interface (CDI-RJ45) is available. Refer to *Connecting through the service interface (CDI-RJ45)* →

Opening the terminal cover

1. Loosen the securing clamp of the connection compartment cover.
2. Unscrew the connection compartment cover.
3. Squeeze the tabs of the display module holder together.
4. Remove the display module holder.

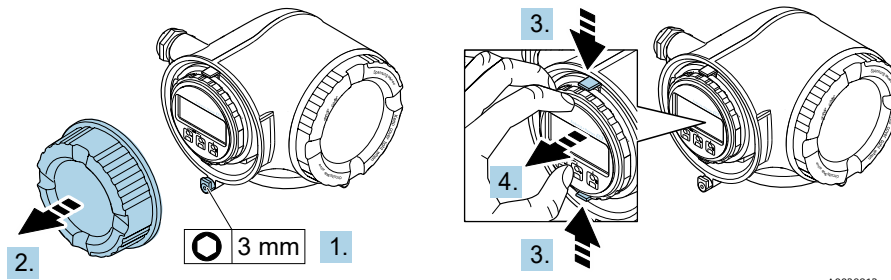

A0029813

Fig 26. Removing the display module holder

5. Attach the holder to the edge of the electronics compartment.
6. Open the terminal cover.

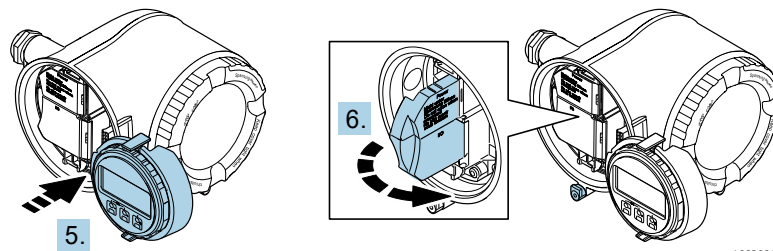

A0029814

Fig 27. Opening the terminal cover

Connecting the cables

1. Push the cable through the cable entry. To ensure tight sealing, do not remove the sealing ring from the cable entry.
 2. Strip the cable and cable ends and connect to the RJ45 connector.
 3. Connect the protective ground.
 4. Plug in the RJ45 connector.
 5. Firmly tighten the cable glands.
- ↳ This concludes the Modbus TCP connection process.

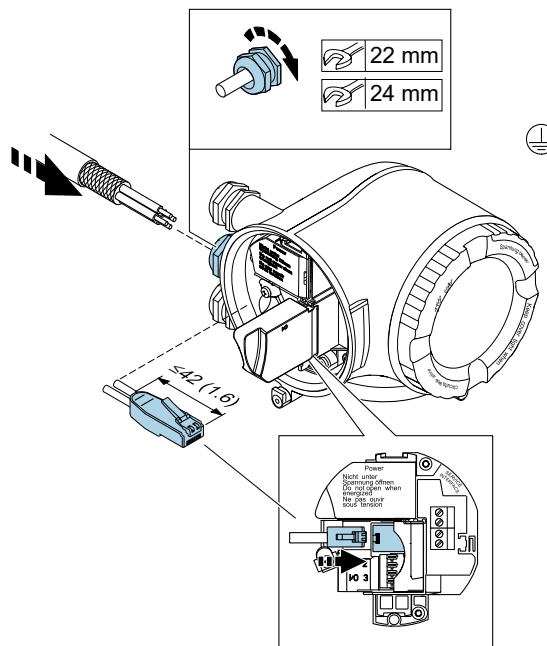

A0054800

Fig 28. Connecting the RJ45 cable

6. Close the terminal cover.

7. Fit the display module holder in the electronics compartment.
8. Screw on the connection compartment cover.
9. Secure the securing clamp of the connection compartment cover.

4.6.4 Connecting the supply voltage and additional inputs/outputs

⚠ WARNING

The temperature of the J22 TDLAS gas analyzer can reach 67 °C (153 °F) in 60 °C (140 °F) ambient at the cable entry and branching point.

- ▶ These temperatures must be considered when selecting field wiring and cable entry devices.
- ▶ The main electronic assembly shall be protected by a building installation overcurrent protection rated for 10 amp or less.

1. Push the cable through the cable entry. To ensure tight sealing, do not remove the sealing ring from the cable entry.
2. Strip the cable and cable ends. In the case of stranded cables, also fit ferrules.
3. Connect the protective ground.

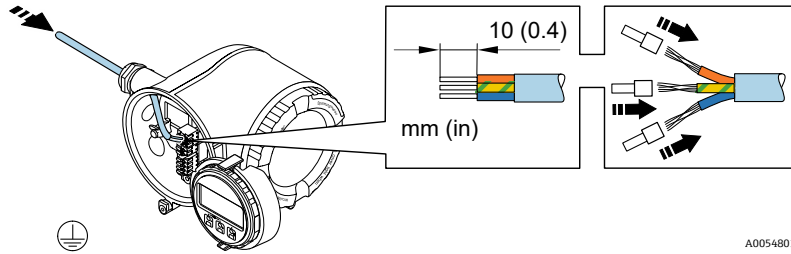

Fig 29. Feeding wiring and connecting the protective ground

4. Connect the cable in accordance with the **terminal assignment**.
 - ▶ **Signal cable terminal assignment.** The device-specific terminal assignment is documented on an adhesive label in the terminal cover.
 - ▶ **Supply voltage terminal assignment.** Adhesive label in the terminal cover.
 - ▶ Connection examples follow:

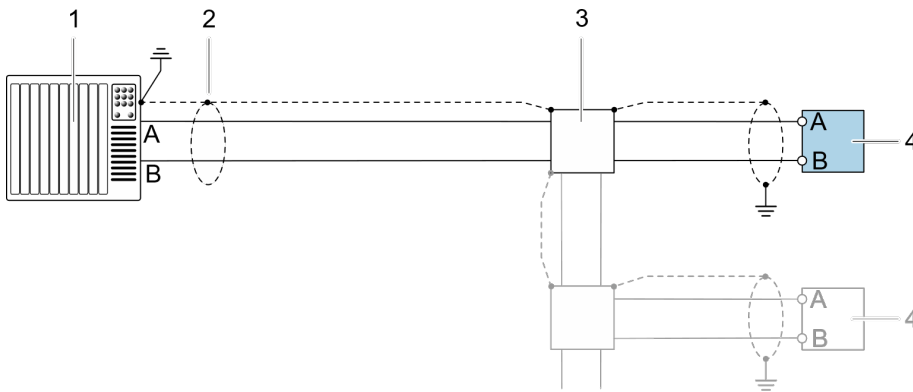

Fig 30. Connection example for Modbus RS485, non-hazardous area and Zone 2/Div.2

#	Description
1	Control system (e.g., PLC)
2	Cable shield provided at one end. The cable shield must be grounded at both ends to comply with PMC requirements; observe cable specifications

#	Description
3	Distribution box
4	Transmitter

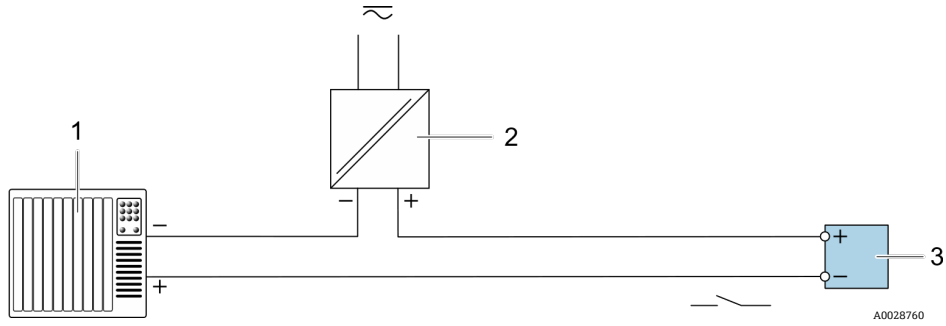

Fig 31. Connection example for switch output (passive)

#	Description
1	Automation system with switch input (e.g., PLC with a 10 kΩ pull-up or pull-down resistor)
2	Power supply

#	Description
3	Distribution box
4	Transmitter

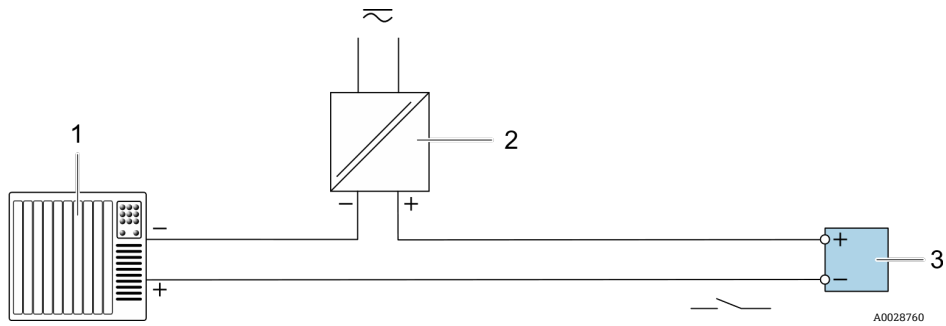

Fig 32. Connection example for relay output (passive)

#	Description
1	Automation system with relay input (e.g., PLC)
2	Power supply

#	Description
3	Distribution box
4	Transmitter: observe input values, see <i>Electrical and communications specifications</i> →

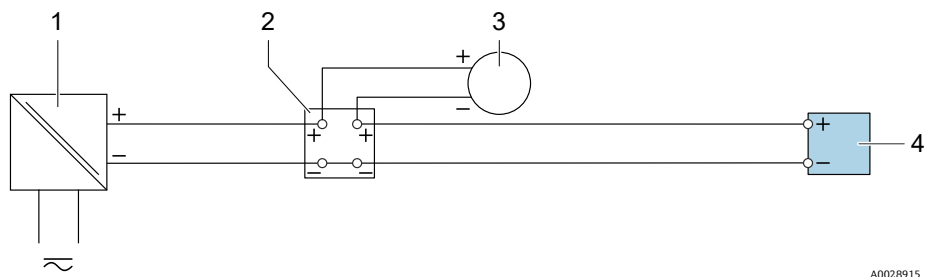

Fig 33. Connection example for 4 to 20 mA current input

#	Description
1	Power supply
2	Terminal box

#	Description
3	External measuring device (to read in pressure or temperature, for instance)
4	Transmitter

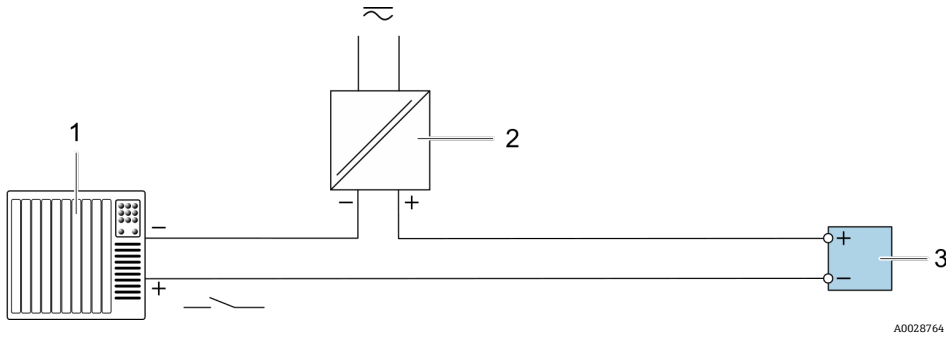

Fig 34. Connection example for status input

#	Description
1	Automation system with status output (e.g., PLC)
2	Power supply
3	Transmitter

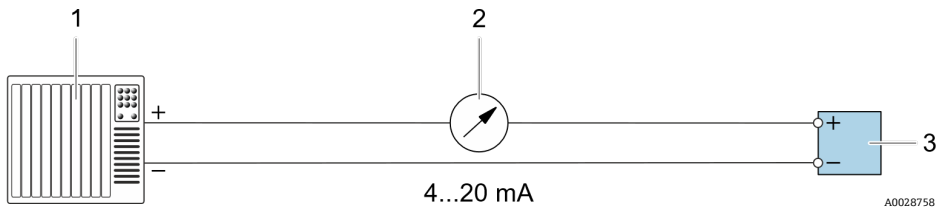

Fig 35. Connection example for 4-20 mA current output (active)

#	Description
1	Automation system with current input (e.g., PLC)
2	Analog display unit: observe maximum load
3	Transmitter

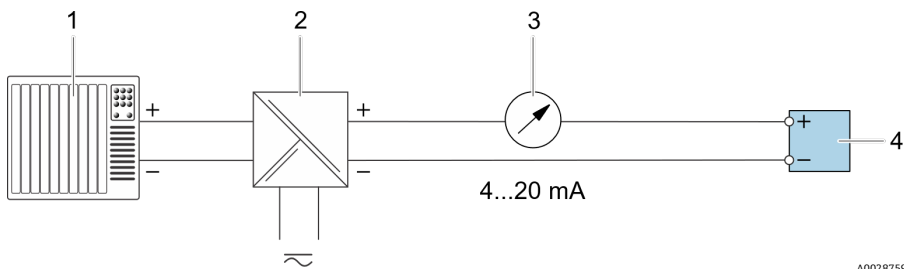

Fig 36. Connection example for 4-20 mA current output (passive)

#	Description
1	Automation system with current input (e.g., PLC)
2	Active barrier for power supply (e.g., RN221N)

#	Description
3	Analog display unit: observe maximum load
4	Transmitter

5. Firmly tighten the cable glands.
↳ This concludes the cable connection process.
6. Close the terminal cover.
7. Fit the display module holder in the electronics compartment.
8. Screw on the connection compartment cover.
9. Secure the securing clamp of the connection compartment cover.

i Conduit is required for the power connection for the CSA-certified J22 TDLAS gas analyzer. The ATEX-certified model requires armored cable steel wire or braided wire.

4.6.5 Removing a cable

1. To remove a wire from the terminal, use a flat-blade screwdriver to push the slot between the two terminal holes.
2. Simultaneously pull the cable end out of the terminal.

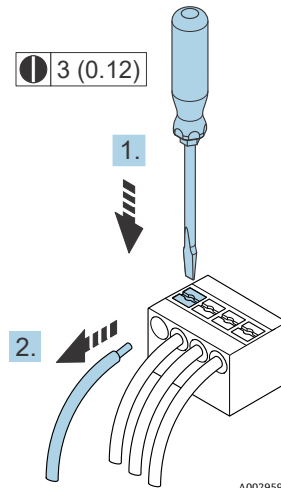

Fig 37. Removing a cable. Engineering unit: mm (in)

After installing all interconnecting wiring or cabling, ensure any remaining conduit or cable entries are plugged with certified accessories according to the intended use of the product.

WARNING

- ▶ Conduit seals and glands specific to the application (CSA or Ex d IP66) should be used where appropriate in compliance with local regulations.

4.6.6 Connecting the controller to a network

This section only presents the basic options for integrating the device into a network. To connect the controller correctly, refer to *External cable entry points* → and the sections that follow.

4.6.7 Connecting through the service interface

The J22 TDLAS gas analyzer includes a connection to the service interface (CDI-RJ45).

NOTICE

- ▶ Connection to the service interface (CDI-RJ45) shall only be permitted by trained personnel on a temporary basis for the purpose of test, repair, or overhaul of the equipment, and only if the area where the equipment is to be installed is known to be non-hazardous.

Note the following when connecting:

- Recommended cable: CAT 5e, CAT 6 or CAT 7, with shielded connector
- Maximum cable thickness: 6 mm (0.24 in)
- Length of connector including bend protection: 42 mm (1.65 in)
- Bending radius: 5 x cable thickness

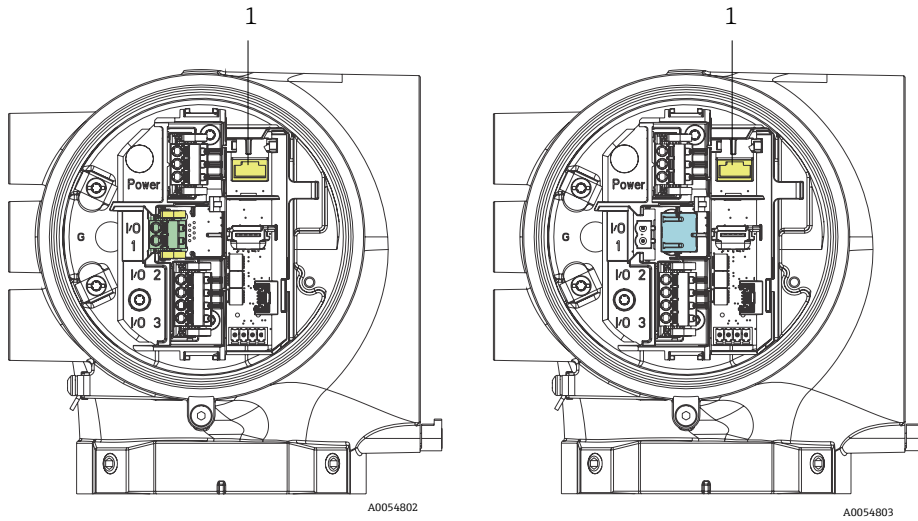

Fig 38. Service interface (CDI-RJ45) connections (1) for IO1 with Modbus RTU/RS485/2-wire (left) and Modbus TCP/Ethernet/RJ45 (right)

4.6.8 Connecting enclosure heater power (optional)

Wiring connections for sample conditioning system enclosure

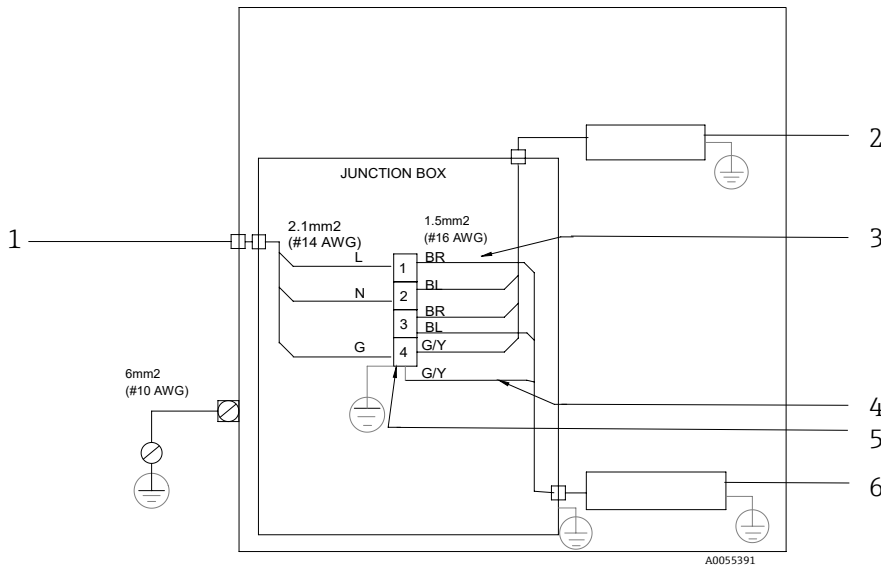

Fig 39. J22 SCS enclosure electrical connections

#	Description
1	100 to 240 VAC ± 10%, 50/60 HZ; main power
2	Heater
3	Blue wire is used in thermostat phase, no ground wire
4	Ground wire is not installed for CSA thermostat. Only applies to ATEX version.
5	Use copper wire only

#	Description
6	Thermostat
BL	Blue wire
BR	Brown wire
G/Y	Green/yellow wire

⚠ WARNING

- ▶ For models of the J22 TDLAS gas analyzer with the SCS mounted within an enclosure, the inner sheath of the supply cable for the heater circuit shall be sheathed with thermoplastic, thermosetting, or elastomeric material.

It shall be circular and compact. Any bedding or sheath shall be extruded. Fillers, if any, shall be non-hygroscopic.

i Conduit is required for the power connection for the CSA certified J22 TDLAS gas analyzer. The ATEX-certified model requires armored cable steel wire or braided wire.

1. Confirm power is off to the system.
2. Open the sample system enclosure door.
3. Using a 1.5 mm hex driver, turn the set screw on the power junction box (JB) counterclockwise. Set aside the cover.

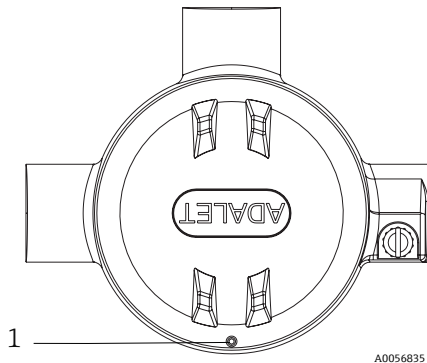

Fig 40. Junction box screw location (1)

4. Feed cable or wires (2.1 mm², #14 AWG) through the heater power inlet and into the junction box.

⚠ WARNING

- ▶ Conduit seals and glands specific to the application should be used where appropriate in compliance with local regulations.
- ▶ For models of the J22 TDLAS gas analyzer with enclosed SCS featuring a heater with optional imperial connections, a suitable equipment seal shall be installed within 5 cm (2 in) of the outer enclosure wall of the heating circuit.

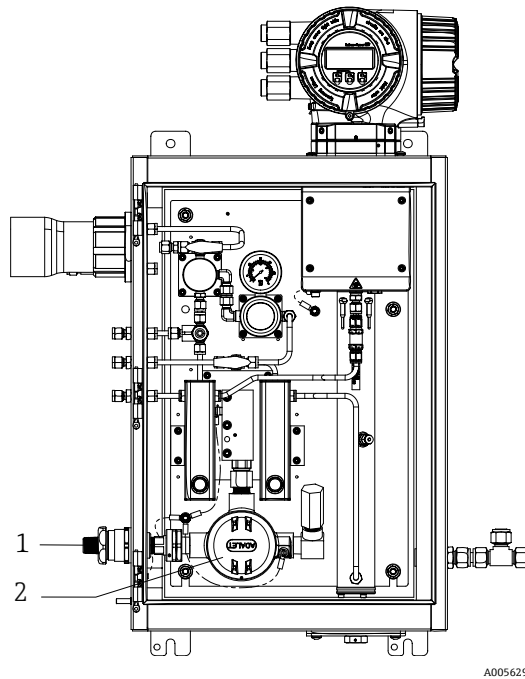
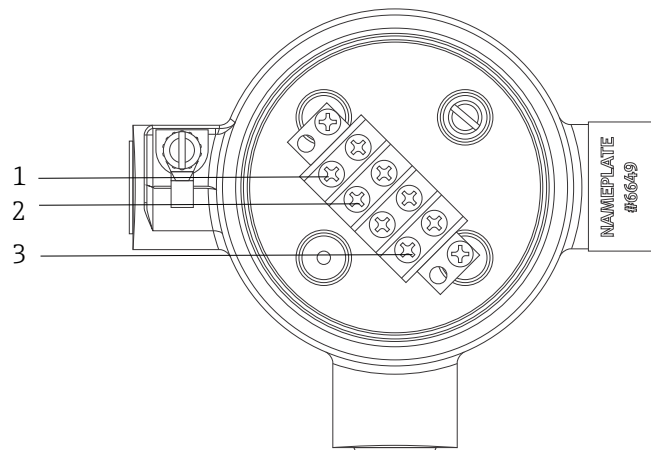

Fig 41. Heater power entry and junction box

#	Description
1	Threaded entry for heater power
2	Heater power junction box (JB)

5. Strip back the jacket and insulation of the wires just enough to connect to the power terminal blocks.
6. Connect the ground wire to the terminal block.



A0056893

Fig 42. Heater electrical connections

#	Description
1	Line
2	Neutral
3	Ground

7. Attach the neutral and hot wires to the power terminal blocks using a Phillips screwdriver.

i EU: Wire colors: Brown/blue (power), green/yellow (ground).
 USA: Wire colors: Black/white (power), green or green/yellow (ground).
 Use copper wire only with temperature rating $-40\text{ }^{\circ}\text{C}$ ($-40\text{ }^{\circ}\text{F}$) to $105\text{ }^{\circ}\text{C}$ ($221\text{ }^{\circ}\text{F}$).

8. Replace the junction box cover and secure the locking screw.
9. Close the sample system enclosure door.

4.6.9 Connecting the flow switch

The J22 TDLAS gas analyzer can be offered with a variable flow meter equipped with an optional mechanical display and reed contact to measure the volume flow of flammable and non-flammable gases.

NOTICE

- ▶ Installation shall be in accordance with the National Electric Code® NFPA 70, Article 500 to 505, ANSI/ISA-RP 12.06.01, IEC 60079-14 and Canadian Electrical Code (CEC) Appendix J for Canada.
- ▶ The equipment is not capable of passing a 500V r.m.s. dielectric strength test in accordance with Clause 6.3.13 of IEC 60079-11 between the intrinsically safe connections and the equipment enclosure. This shall be taken into account in any equipment installation.
- ▶ Certified cable through gland Ex eb IIC and IP66 rated suitable for temperature range of $-20\text{ }^{\circ}\text{C}$ ($-4\text{ }^{\circ}\text{F}$) to $60\text{ }^{\circ}\text{C}$ ($140\text{ }^{\circ}\text{F}$) shall be used.
- ▶ Only insulated cables with insulation capable of withstanding a dielectric test of at least 500 VAC or 750 VDC shall be used in intrinsically safe circuits.

To connect the flow switch, run a shielded interconnection cable with the shield connected to an FM-approved associated apparatus ground. The maximum temperature of terminals, cable glands and wires should be no greater than $60\text{ }^{\circ}\text{C}$ dependent on ambient and product temperature.

WARNING

- ▶ The variable area flow meter with coated parts shall be installed and maintained such that the risk of electrostatic discharge is minimized.

4.6.10 Threaded entries

Threaded entry locations for the panel configuration are the same as shown for the enclosed sample system below.

NOTICE

- ▶ Thread lubricant must be applied on all conduit hub threaded connections. Using Syntheso Glep1 or an equivalent lubricant on all conduit screw threads is recommended.

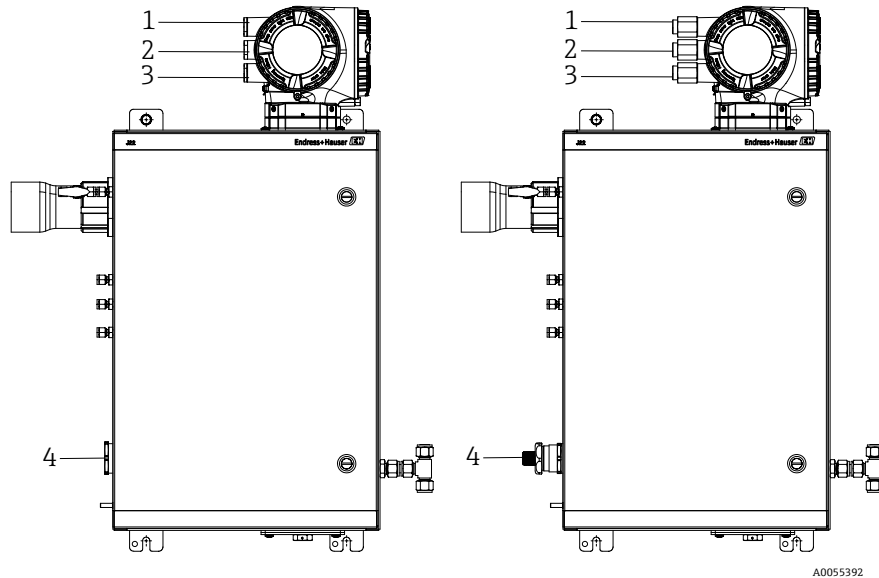

Fig 43. J22 threaded entries for enclosure for ATEX (left) and imperial (right) connections

Cable Entry	Description	ATEX, IECEx, INMETRO	Optional imperial connections
1	Controller power	M20 x 1.5	½" NPTF
2	Modbus output	M20 x 1.5	½" NPTF
3	(2) Configurable IO (IO2, IO3)	M20 x 1.5	½" NPTF
4	Heater power	M25 x 1.5	½" NPTM

4.6.11 Heat trace termination connection

The J22 was designed for an exterior termination of the heat trace. To accomplish this, heat trace wiring must be looped back out of the heat trace boot during installation.

Connecting the heat trace termination

1. Identify the insulated line with heat trace and sample transport tubing.
2. Cut back the insulation until:
 - 76 cm (30 in) of the heat trace line is protruding
 - 6 in (15.24 cm) of the tubing is protruding
3. Place the heat shrink end cap over the heat trace line, tubing, and insulated line. Heat the end cap to form a seal.
4. Install insulated line into the heat trace boot and route the heat trace wire back through the boot. Follow the supplier's bend radius for the heat trace.
5. After tubing is installed and heat shrink is routed back out of the boot, apply heat to the boot to form a seal.
6. Cut back the heat trace insulation and install the vendor's recommended junction box to power the heat trace.

4.7 Gas connections

Once you have verified that the J22 TDLAS gas analyzer is functional and that the analyzer circuit is de-energized, you are ready to connect the sample supply, sample purge, pressure relief vent (if applicable), validation source (if applicable) and purge supply (if applicable) gas lines. All work must be performed by technicians qualified in pneumatic tubing.

WARNING

Process samples may contain hazardous material in potentially flammable or toxic concentrations.

- ▶ Personnel should have a thorough knowledge and understanding of the physical properties and safety precautions for the sample contents before installing the sample system.
- ▶ Do not exceed 0.7 barg (10 psig) in the sample cell. Damage to cell may result.

Seamless, stainless steel tubing (electropolished) is recommended. For metric gas connections, use 6 mm O.D. x 1 mm tubing thickness. For imperial gas connections, use ¼" O.D. x 0.035" tubing thickness. For supply and return port locations, refer to *Technical drawings* → .

Connecting the sample supply line

1. Before connecting the sample supply line, confirm the following:
 - a. The sample probe is correctly installed at the process sample tap and that the sample probe isolation valve is closed.
 - b. The field pressure reducing station is installed properly at the sample probe and that the pressure regulator at the field pressure reducing station is closed (adjustment knob turned fully counterclockwise).

WARNING

The process sample at the sample tap may be at high pressure.

- ▶ Use extreme caution when operating the sample probe isolation valve and field pressure reducing pressure regulator.
 - ▶ All valves, regulators, switches, etc. should be operated in accordance with site lockout/tagout procedures.
 - ▶ Consult sample probe manufacturer instructions for proper installation procedures.
2. The relief valve vent line is properly installed from the field pressure reducing station to the low-pressure flare or atmospheric vent connection.
 3. Determine appropriate tubing route from the field pressure reducing station to the sample system.
 4. Run stainless steel tubing from the field pressure reducing station to the sample supply port of the sample system.
 5. Bend tubing using industrial grade benders and check tubing fit to ensure proper seating between the tubing and fittings.
 6. Fully ream all tubing ends.
 7. Blow out the line for 10 to 15 seconds with clean, dry nitrogen or air prior to making the connection.
 8. Connect the sample return tube to the sample system using a 6 mm (¼ in) stainless steel tubing compression-type fitting.
 9. Tighten all new fittings 1¼ turns with a wrench from finger tight. For connections with previously swaged ferrules:
 - a. Thread the nut to the previously pulled up position,
 - b. Tighten slightly with a wrench.
 - c. Secure tubing to appropriate structural supports as required.
 10. Check all connections for gas leaks using a leak detector.

Connecting the sample returns

1. Confirm the low-pressure flare or atmospheric vent header shut-off valve is closed.

WARNING

- ▶ All valves, regulators, switches, etc. should be operated in accordance with site lockout/tagout procedures.
2. Determine the appropriate tubing route from the sample system to the low-pressure flare or atmospheric vent header.
 3. Run stainless steel tubing from sample return port of the sample system to the low-pressure flare or atmospheric vent header.
 4. Bend tubing using industrial grade benders and check tubing fit to ensure proper seating between the tubing and fittings.
 5. Fully ream all tubing ends.
 6. Blow out the line for 10 to 15 seconds with clean, dry nitrogen or air prior to making the connection.
 7. Connect the sample return tube to the sample system using a 6 mm (¼ in) stainless steel tubing compression-type fitting.

8. Tighten all new fittings 1 ¼ turns with a wrench from finger tight. For connections with previously swaged ferrules:
 - a. Thread the nut to the previously pulled up position,
 - b. Tighten slightly with a wrench.
 - c. Secure tubing to appropriate structural supports as required.
9. Check all connections for gas leaks using a leak detector.

4.8 Metric conversion kit

A metric conversion kit for the sample system converts the Imperial (in) analyzer system fittings to metric (mm) fittings. This kit can be provided with the J22 TDLAS gas analyzer at the time of product ordering. The kit includes the following parts:

Quantity	Description
6	Ferrule set, ¼" tube fitting
1	Ferrule set, ½" tube fitting
6	Tube nut, ¼" tube fitting, 316SS
1	Tube nut, ½" tube fitting, 316SS
6	6 mm-Tube fitting x ¼" tube stub, 316SS
1	12 mm-Tube fitting x ½" tube stub, 316SS

Required tools

- 7/8" Open-ended wrench
- 5/16" Open-ended wrench (for stabilizing adapter)
- Felt-tip marker
- Gap inspection gauge

Installation

1. Select either the 6 mm (¼ in) or 12 mm (½ in) fitting as appropriate.
2. Insert the tube adapter into the tube fitting. Make sure the tube adapter rests firmly on the shoulder of the tube fitting body and the nut is finger tight.
3. Mark the nut at the 6:00 position.
4. While holding the fitting body steady, tighten the tube nut 1 ¼ turns to the 9:00 position.
5. Use a gap inspection gauge, placing it between the nut and the body. If the gauge enters the gap, additional tightening is required.

NOTICE

- ▶ Refer to Swagelok's manufacturer instructions.

4.9 Hardware settings

Refer to the following figure during the hardware start-up operation.

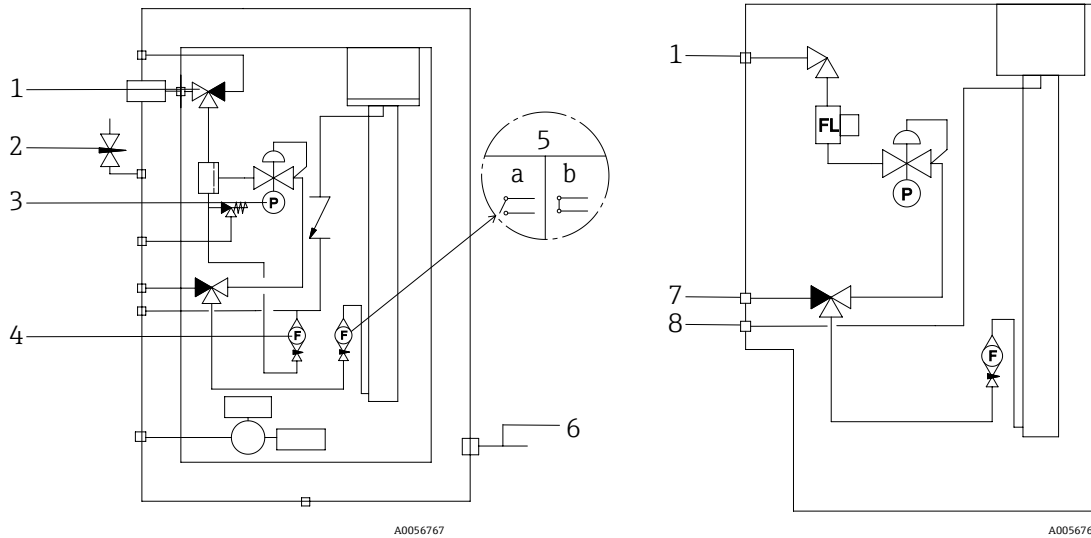

Fig 44. J22 TDLAS gas analyzer flow diagram for fully loaded (left) and minimum (right) sample systems

#	Description
1	Sample supply valve (2- or 3-way)
2	Enclosure purge inlet
3	Pressure gauge
4	Bypass flow meter

#	Description
5	Analyzer flow meter; a) no flow, b) flow
6	Enclosure purge outlet
7	Validation inlet
8	System vent

i For systems with the optional sample system enclosure purge, run purge before start-up. Refer to *Enclosure purge* →

- For systems with an enclosure, open the enclosure door.
- Set the pressure gauge (3) to 69 to 103 kPa (10 to 14.9 psi).
- Set the flow rate to 1 lpm and run the purge for at least 4 minutes for safety, and until the moisture reading is below an acceptable error level.
- Change the sample supply (1) valve to flow gas.
- Position the validation/sample gas to open.
- Set the pressure gauge (3) to setpoint.

⚠ WARNING

- ▶ Do not exceed 172 kPa (25 psig) setting on the pressure gauge.
- ▶ Do not exceed 345 kPa (50 psi) from the pressure reducing station.
- ▶ For CRN systems: Do not exceed 103 Kpa (14.9 psi) setting on the pressure gauge.

- Adjust the bypass flow meter (4) to set point, then adjust the analyzer flow meter (5) using the process gas at the maximum expected backpressure.

i Adjust the flow if the gas composition or backpressure changes.

- For systems with an enclosure, close the enclosure door.

4.9.1 Setting the flow switch

The flow switch is factory set to 0.3 lpm and should not require adjustment at installation. However, to check or re-set the flow switch, use the following procedure:

- Using a multimeter in continuity mode, probe the red and brown wires.

- Adjust the flow rate to a minimum 0.3 lpm and move the read cartridge until continuity is found. It is recommended to monitor Alarm 904. Refer to *Overview of diagnostic information* → .

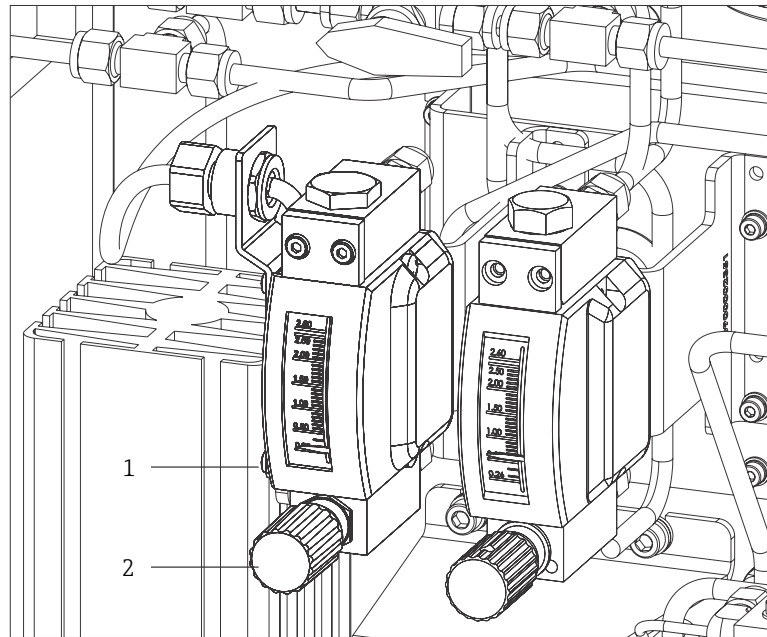

A0054805

Fig 45. Flow switch adjustments

#	Description
1	Adjustable nut
2	Needle valve

- Loosen the nut on the flow switch.
- Adjust the reed cartridge to the desired value, minimum 0.3 lpm, until the alarm is activated.
- Set the flow to the desired flow rate of 0.5 to 1 lpm. The alarm should resolve and change state.
- Secure the nut.

 In normal operation, the alarm has a 60 second delay.

4.9.2 Setting the analyzer address

Depending on the fieldbus, the hardware addressing works differently; Modbus RS485 uses a device address or Modbus TCP uses an IP address.

Hardware addressing for Modbus RS485

The device address must always be configured for a Modbus server. The valid device addresses are in the range from 1 to 247. If an address is not configured correctly, the measuring device is not recognized by the Modbus client. All measuring devices are delivered from the factory with the device address 247 and with the software addressing address mode.

 Each address may only be assigned once in a Modbus RS485 network.
If all DIP switches are ON or OFF, all hardware addressing is OFF.

Modbus device address range	1 to 247
Addressing mode	Software addressing; all DIP switches for hardware addressing are set to OFF.

- Loosen the securing clamp of the connection compartment cover.
- Unscrew the connection compartment cover.
- Set the desired device address using the DIP switches in the connection compartment.

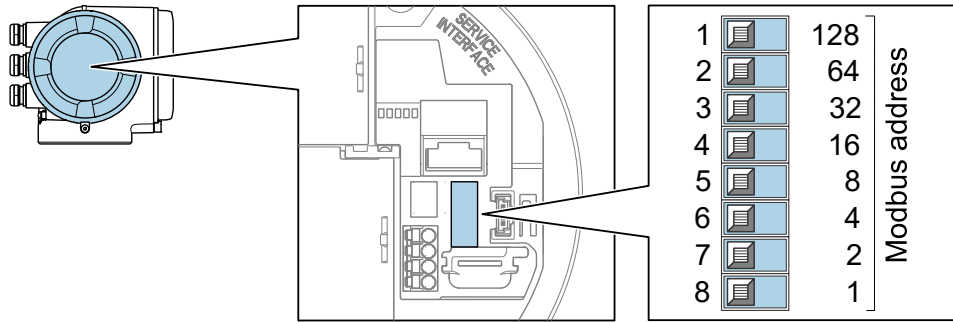

A0029634

Fig 46. Modbus address DIP switches

4. The change of device address takes effect after 10 seconds.
5. Replace the compartment cover and secure the clamp.

Enabling the terminating resistor

To avoid incorrect communication transmission caused by impedance mismatch, terminate the Modbus RS485 cable correctly at the start and end of the bus segment.

- ▶ Set DIP switch 3 to On.

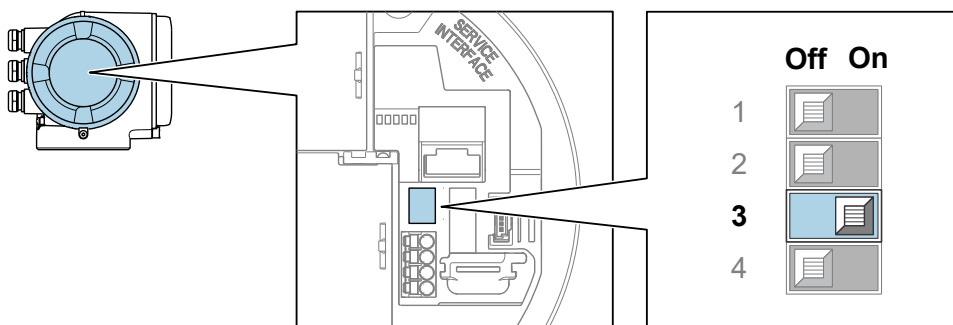

A0029632

Fig 47. Off/on DIP switch selection for enabling the terminating resistor

Hardware addressing for Modbus TCP

The IP address for the J22 can be configured from DIP switches.

Addressing data

The IP address and configuration options are listed below:

1st octet	2nd octet	3rd octet	4th octet
192.	168.	1.	XXX

- i** The 1st, 2nd, and 3rd octet can only be configured through software addressing.
The 4th octet can be configured through software addressing and hardware addressing.

IP address range	1 to 254 (4th octet)
IP address broadcast	255
Addressing mode ex works	Software addressing: all DIP switches for hardware addressing are set to OFF.
IP address ex works	DHCP server active

- i** Software addressing: The IP address is entered through the IP address parameter. For more information, see the *Description of Device Parameters* →

Setting the IP address



Risk of electric shock when opening the controller housing.

- ▶ Disconnect from power supply before opening the controller housing.

i The default IP address may **not** be activated.

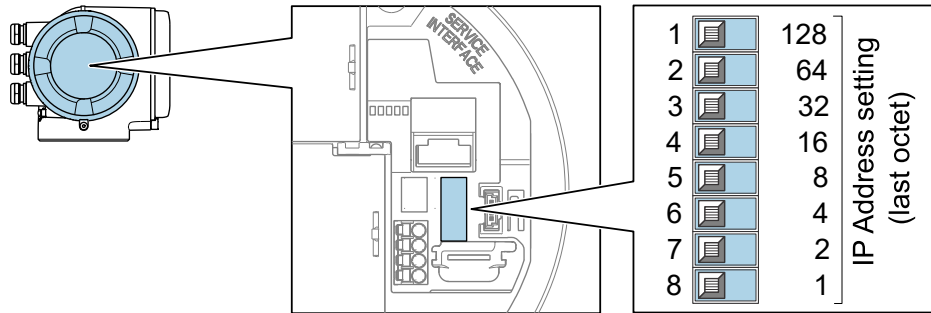

A0029635

Fig 48. DIP switches for setting the IP address

1. Loosen the securing clamp of the connection compartment cover.
2. Unscrew the connection compartment cover.
3. Set the desired IP address using the corresponding DIP switches on the I/O electronics module.
4. Replace the compartment cover and secure the clamp.
5. Reconnect the device to the power supply.

↳ The configured device address is used once the device is restarted.

4.9.3 Activating the default IP address

The DHCP function is enabled in the device at the factory, i.e. the device expects an IP address to be assigned by the network. This function can be disabled and the device can be set to the default IP address 192.168.1.212 by DIP switch.

Activating the default IP address by DIP switch



Risk of electric shock when opening the controller housing.

- ▶ Disconnect from power supply before opening the controller housing.

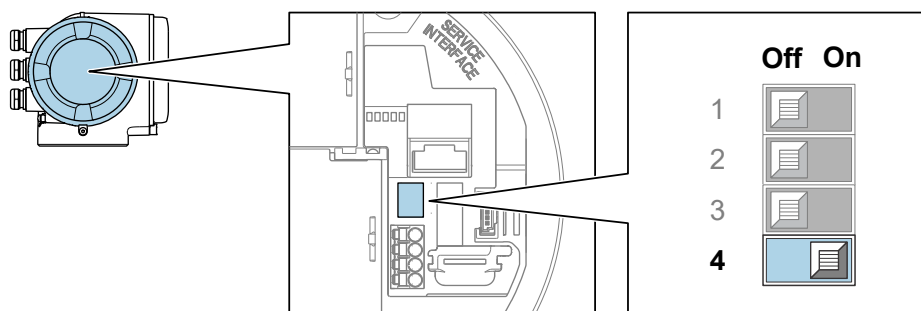

A0029633

Fig 49. Off/on DIP switch for default IP address

1. Loosen the securing clamp of the connection compartment cover.
2. Unscrew the connection compartment cover and disconnect the local display from the main electronics module where necessary.
3. Set DIP switch No. 4 on the I/O electronics module from OFF → ON.
4. Replace the compartment cover and secure the clamp.
5. Reconnect the device to the power supply.

↳ The default IP address is used once the device is restarted.

4.10 Ensuring IP66 degree of protection

The measuring device fulfills all the requirements for the IP66 degree of protection, Type 4X enclosure. To guarantee IP66 degree of protection, Type 4X enclosure, carry out the following steps after the electrical connection:

1. Check that the housing seals are clean and fitted correctly.
2. Dry, clean, or replace the seals if necessary.
3. Tighten all housing screws and screw covers.
4. Firmly tighten the cable glands.
5. Route the cable so that it loops down before the cable entry (water trap) to ensure that moisture does not enter the cable entry.

 Ensure the minimum required cable radius is met.

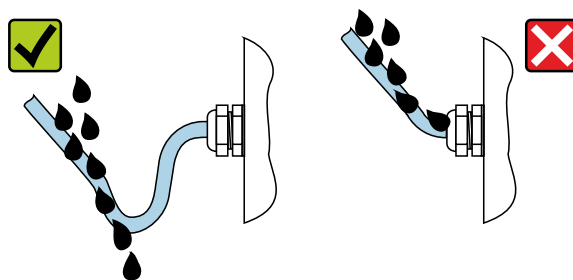

A0029278

Fig 50. Ensuring IP66 degree of protection

6. Insert dummy plugs into unused cable entries.

5 Operation options

5.1 Overview of operation options

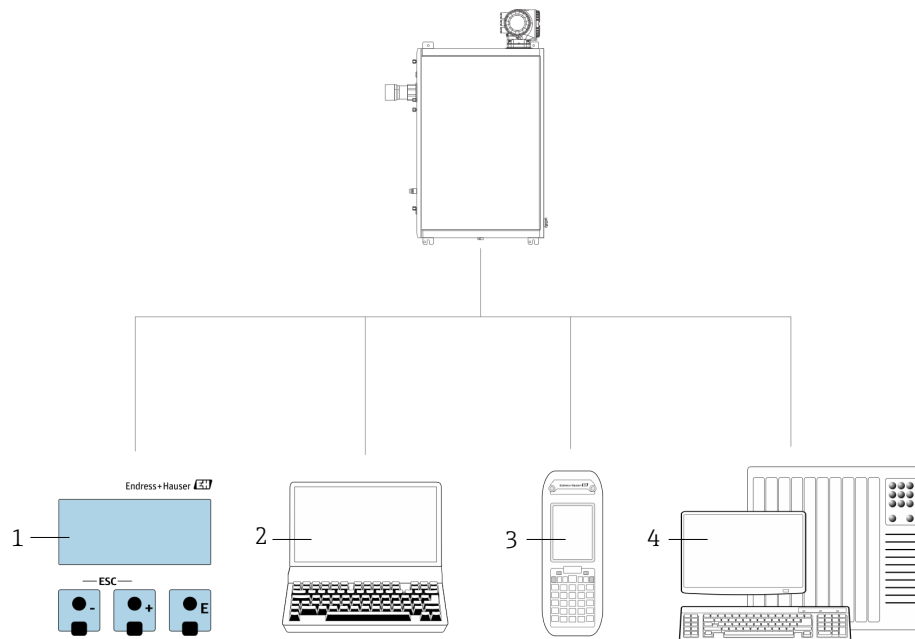

A0054380

Fig 51. Operation options

#	Name
1	Local operation through the display module
2	Computer with web browser, such as Internet Explorer
3	Mobile device, such as a cellular telephone or tablet, used on the network to access the web server or Modbus
4	Control system, such as PLC

5.2 Structure and function of the operating menu

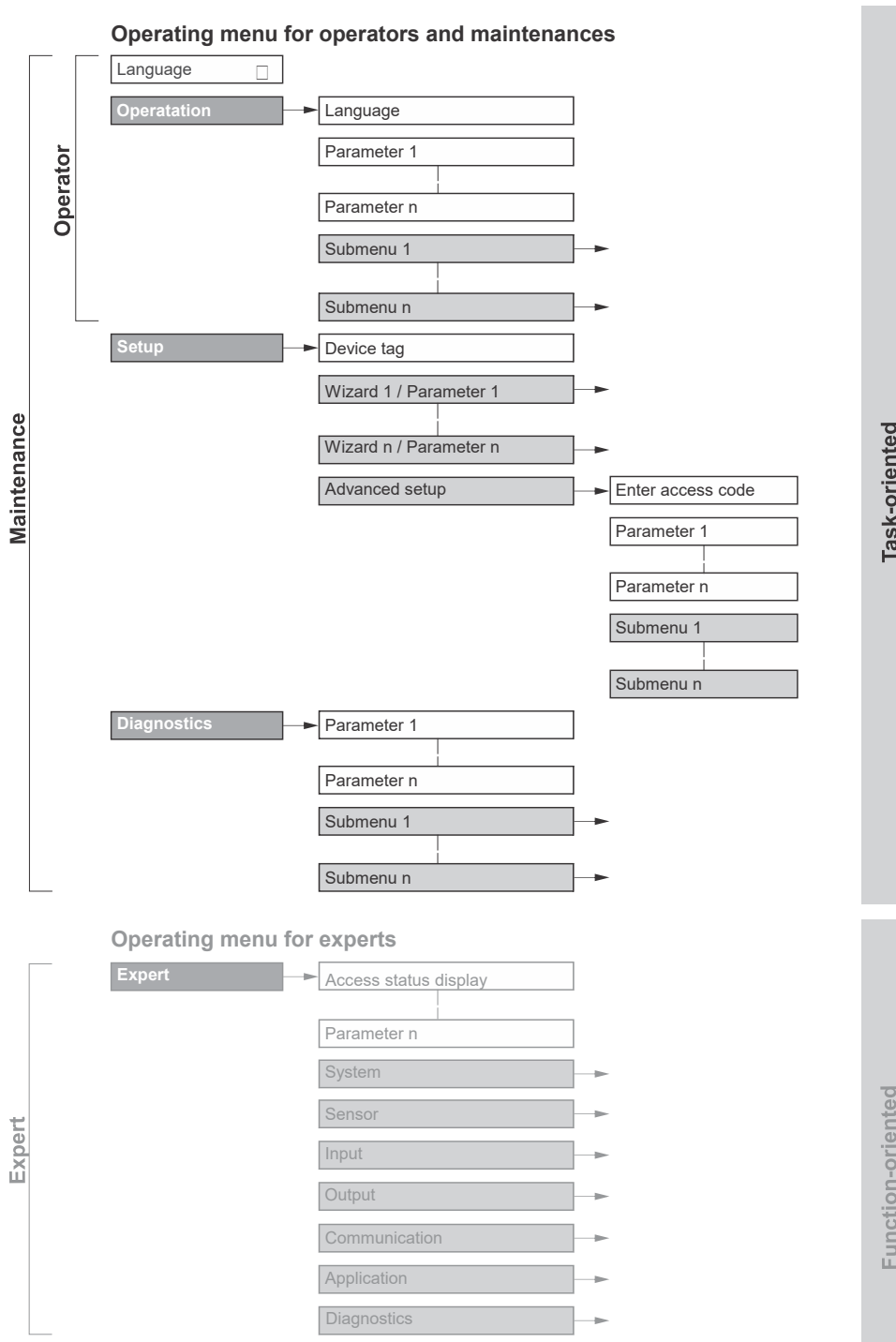

A0018237-EN

Fig 52. Schematic structure of the operating menu

5.2.1 Operating roles

The individual parts of the operating menu are assigned to certain user roles (operator, maintenance, etc.). Each user role contains typical tasks within the device lifecycle.

Functional role/Menu		User Role and Tasks	Content/Meaning
Task Oriented	Display Language	Role Operator, Maintenance Tasks during operation: <ul style="list-style-type: none"> ▪ Configuring the operational display ▪ Reading measured values 	<ul style="list-style-type: none"> ▪ Defining the operating language ▪ Defining the web server operating language
	Operation		<ul style="list-style-type: none"> ▪ Configuring the operational display (e.g., display format)
	Setup	Maintenance role Commissioning: <ul style="list-style-type: none"> ▪ Configuration of the measurement ▪ Configuration of the inputs and outputs ▪ Configuration of the communication interface 	Wizards for fast commissioning: <ul style="list-style-type: none"> ▪ Set the system units ▪ Configuration of the communication interface ▪ Display I/O configuration ▪ Configure the inputs and outputs ▪ Configuring the operational display ▪ Define the output conditioning Advanced setup <ul style="list-style-type: none"> ▪ For more customized configuration of the measurement (adaptation to special measuring conditions) ▪ Administration (define access code, reset measuring device)
	Diagnostics	Maintenance role Fault elimination: <ul style="list-style-type: none"> ▪ Diagnostics and elimination of process and device errors ▪ Measured value simulation 	Contains all parameters for error detections and analyzing process errors: <ul style="list-style-type: none"> ▪ Diagnostic list. Contains up to 5 currently pending diagnostics messages. ▪ Event logbook. Contains event messages that have occurred. ▪ Device information. Contains information for identifying the device. ▪ Measured values. Contains all current measured values. ▪ Data logging submenu. Storage and visualization of measured values ▪ Heartbeat technology. The functionality of the device is checked on demand and the verification results are documented. ▪ Simulation. Is used to simulate measured values or output values.
Function Oriented	Expert	Tasks that require detailed knowledge of the function of the device: <ul style="list-style-type: none"> ▪ Commissioning measurements under difficult conditions ▪ Optimal adaptation of the measurement to difficult conditions ▪ Error diagnostics in difficult cases ▪ Detailed configuration of the communication interface 	Contains all the parameters of the device. The structure of this menu is based on the function blocks of the device: <ul style="list-style-type: none"> ▪ System. Contains all higher-order device parameters that do not concern the measurement or the communication interface. ▪ Sensor. Configuration of the measurement. ▪ Output. Configuration of the analog current outputs and switch outputs. ▪ Input. Configuration of the analog current inputs. ▪ Communication. Configuration of the digital communication interface and the web server. ▪ Diagnostics. Error detection and analysis of process and device errors, and for device simulation and Heartbeat Technology.

5.3 Local operation

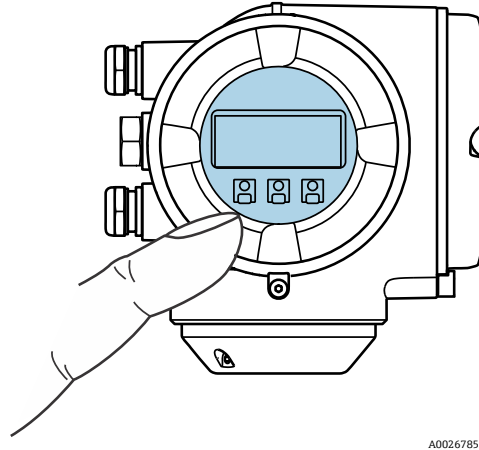

Fig 53. Operation with touch control

Display elements

- 4-line, illuminated, graphic display
- White background lighting; switches to red in event of device errors
- Format for displaying measured variables and status variables can be individually configured
- Permitted ambient temperature for the display: -20 to 60 °C (-4 to 140 °F). The readability of the display may be impaired at temperatures outside the temperature range.

Operating elements

- External operation through touch control (3 optical keys) without opening the housing: ⊕, ⊖, E
- Operating elements also accessible in various hazardous areas

5.4 Accessing the operating menu through the local display

5.4.1 Operational display

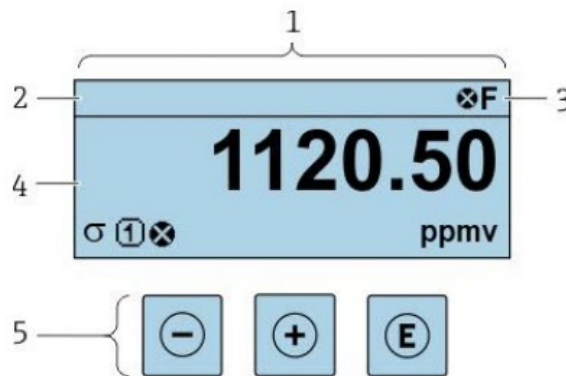

Fig 54. Operational display

- 1 Operational display
- 2 Device tag
- 3 Status area
- 4 Display area for measured values (4-line)
- 5 Operating elements → ⊖ ⊕ E

Status area

The following symbols appear in the status area of the operational display at the top right:

- *Status signals* →
- **F.** Failure
- **C.** Function check
- **S.** Out of specification
- **M.** Maintenance required
- *Diagnostic behavior* → . The diagnostic behavior pertains to a diagnostic event that is relevant to the *displayed measured variable, calculation error or parameter misconfiguration* → .
- Alarm
- Warning
- Locking (the device is locked from the hardware)
- Communication (communication through remote operation is active)

Display area

In the display area, each measured value is prefaced by certain symbol types for further description:

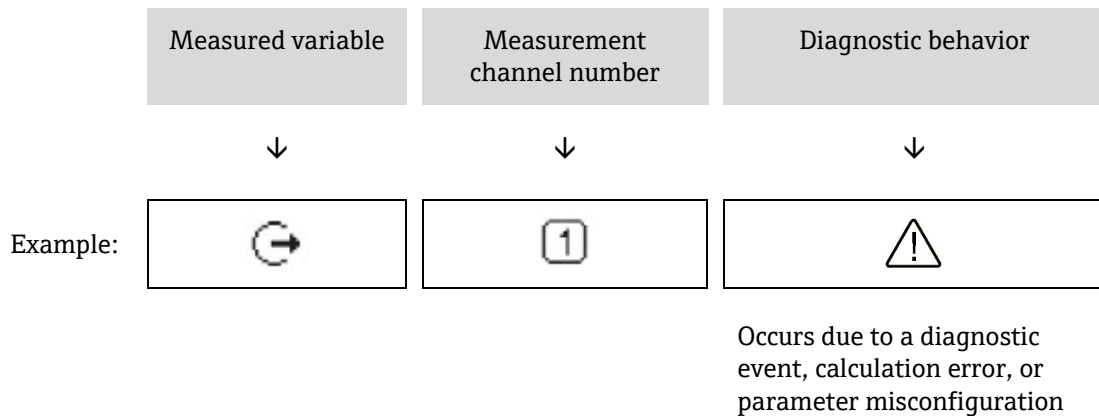

Measured variables

Symbol	Meaning
	Temperature Dew point temperature
	Output The measurement channel number indicates which of the outputs is displayed.
σ	Concentration
p	Pressure

Diagnostic behavior

The number and display format of the measured values can be configured from the *Format display parameter* → .

5.4.2 Navigation view

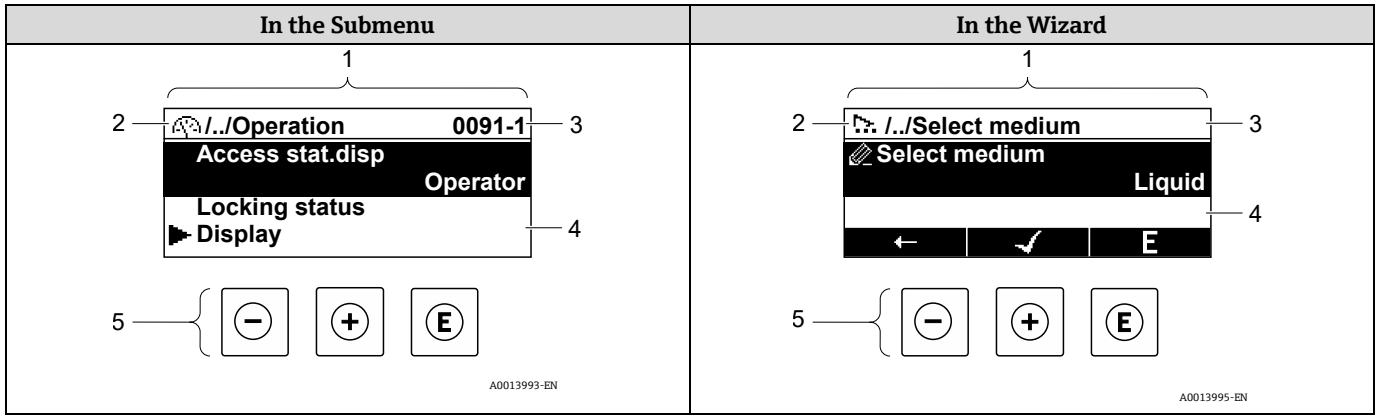

Fig 55. Navigation view

#	Name
1	Navigation view
2	Navigation path to current position
3	Status area
4	Display area for navigation
5	Operating elements →

Navigation path

The navigation path, displayed at the top left in the navigation view, consists of the following elements:

<ul style="list-style-type: none"> In the submenu: display symbol for menu In the wizard: display symbol for wizard 	Omission symbol for operating menu levels in between	Name of current <ul style="list-style-type: none"> Submenu Wizard Parameters
↓	↓	↓
Example:	/ .. /	Display
	/ .. /	Display







Status area

The following appears in the status area of the navigation view in the top right corner:



- In the submenu:** If a diagnostic event is present, the Diagnostic behavior and Status signal.
- In the wizard:** If a diagnostic event is present, the Diagnostic behavior and Status signal.
- For information, refer to *Diagnostic information on the local display* → .

Display area

Symbol	Meaning
	Operation <ul style="list-style-type: none"> In the menu next to the Operation selection At the left in the navigation path in the Operation menu

Symbol	Meaning
	Setup <ul style="list-style-type: none"> In the menu next to the Setup selection At the left in the navigation path in the Setup menu
	Diagnostics <ul style="list-style-type: none"> In the menu next to the Diagnostics selection At the left in the navigation path in the Diagnostics menu
	Expert <ul style="list-style-type: none"> In the menu next to the Expert selection At the left in the navigation path in the Expert menu
	Submenu
	Wizard
	Parameters within a wizard No display symbol exists for parameters in submenus.
	Parameter locked. When displayed in front of a parameter name, indicates that the parameter is locked by one of the following methods: <ul style="list-style-type: none"> User-specific access code Hardware write protection switch

Wizard operation

Symbol	Meaning
	Switches to the previous parameter.
	Confirms the parameter value and switches to the next parameter.
	Opens the editing view of the parameter.

5.4.3 Editing view

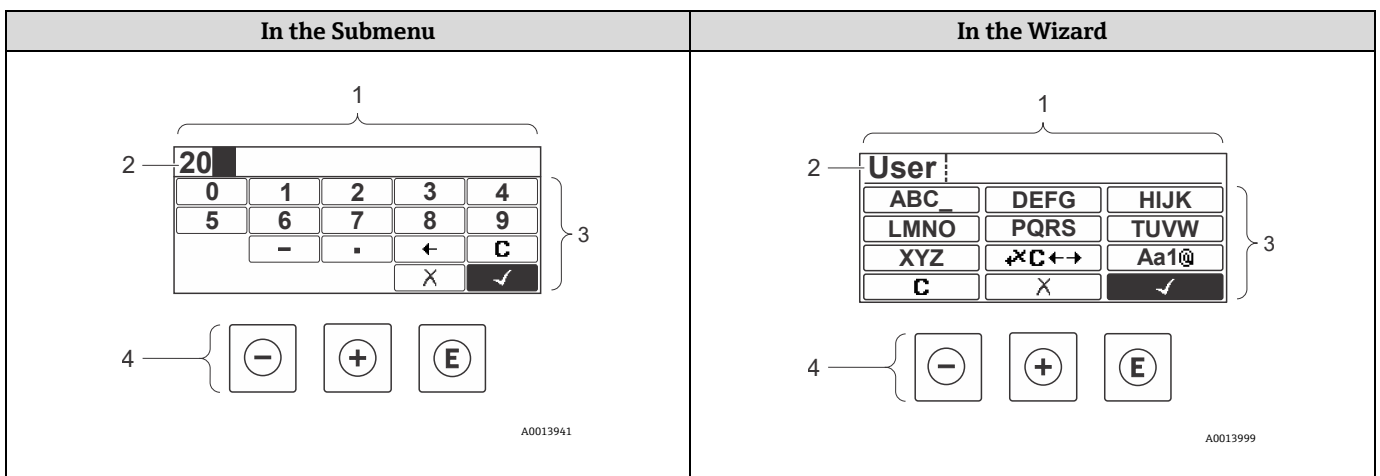



Fig 56. Editing view in the submenu and in the wizard









#	Name
1	Editing view
2	Display area of the entered values

3	Input mask
4	<i>Operating elements</i> → 











Input mask

The following input symbols are available in the input mask of the numeric and text editor:



Numeric editor



Symbol	Meaning
 ... 	Selection of numbers from 0 to 9.
	Inserts decimal separator at the input position.
	Inserts minus sign at the input position.
	Confirms selection.
	Moves the input position one position to the left.
	Exits the input without applying the changes.
	Clears all entered characters.

Text editor



Symbol	Meaning
	Toggle <ul style="list-style-type: none"> Between upper-case and lower-case letters For entering numbers For entering special characters
 ... 	Selection of letters from A to Z (upper case).
 ... 	Selection of letters from a to z (lower case).
 ... 	Selection of special characters.
	Confirms selection.
	Switches to the selection of the correction tools.
	Exits the input without applying the changes.
	Clears all entered characters.

Correction symbols under

Symbol	Meaning
	Clears all entered characters.
	Moves the input position one position to the right.

Symbol	Meaning
	Moves the input position one position to the left.
	Deletes one character immediately to the left of the input position.

5.5 Operating elements

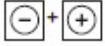
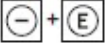
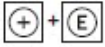
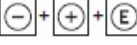
Symbol	Meaning
	<p>Minus key</p> <p><i>In a menu, submenu:</i> Moves the selection bar upwards in a choose list.</p> <p><i>With a Wizard:</i> Confirms the parameter value and goes to the previous parameter.</p> <p><i>With a text and numeric editor:</i> In the input mask, moves the selection bar to the left (backwards).</p>
	<p>Plus key</p> <p><i>In a menu, submenu:</i> Moves the selection bar downwards in a choose list.</p> <p><i>With a Wizard:</i> Confirms the parameter value and goes to the next parameter.</p> <p><i>With a text and numeric editor:</i> Moves the selection bar to the right (forwards) in an input screen.</p>
	<p>Enter key</p> <p><i>For operational display:</i></p> <ul style="list-style-type: none"> ▪ Pressing the key briefly opens the operating menu. ▪ Pressing the key for 2 seconds opens the context menu. <p><i>In a menu, submenu:</i></p> <ul style="list-style-type: none"> ▪ Pressing the key briefly: <ul style="list-style-type: none"> ▪ Opens the selected menu, submenu or parameter. ▪ Starts the wizard. ▪ If help text is open, closes the help text of the parameter. ▪ Pressing the key for 2 seconds for parameter: If present, opens the help text for the function of the parameter. <p><i>With a Wizard:</i> Opens the editing view of the parameter.</p> <p><i>With a text and numeric editor:</i></p> <ul style="list-style-type: none"> ▪ Pressing the key briefly: <ul style="list-style-type: none"> ▪ Opens the selected group. ▪ Carries out the selected action. ▪ Pressing the key for 2 seconds confirms the edited parameter value.
	<p>Escape key combination (press keys simultaneously)</p> <p><i>In a menu, submenu</i></p> <ul style="list-style-type: none"> ▪ Pressing the key briefly: <ul style="list-style-type: none"> ▪ Exits the current menu level and takes you to the next higher level. ▪ If help text is open, closes the help text of the parameter. ▪ Pressing the key for 2 seconds returns you to the operational display (home position). <p><i>With a Wizard:</i> Exits the wizard and takes you to the next higher level.</p> <p><i>With a text and numeric editor:</i> Closes the text or numeric editor without applying changes.</p>
	<p>Minus/Enter key combination (press the keys simultaneously)</p> <p>Reduces the contrast (brighter setting).</p>
	<p>Plus/Enter key combination (press and hold down the keys simultaneously)</p> <p>Increases the contrast (darker setting).</p>
	<p>Minus/Plus/Enter key combination (press the keys simultaneously)</p> <p><i>For operational display:</i> Enables or disables the keypad lock (only SD02 display module).</p>

5.5.1 Opening the context menu

Using the context menu, the user can call up the following menus quickly and directly from the operational display:

- Setup
- Data backup
- Simulation

Calling up and closing the context menu

The user is in the operational display.

1. Press  for 2 seconds.
 - ↳ The context menu opens.

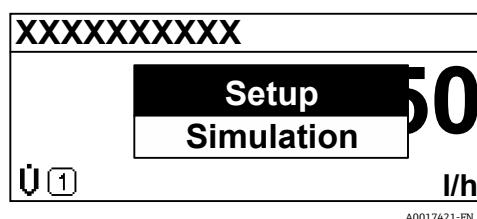





Fig 57. Context menu



2. Press  +  simultaneously.
 - ↳ The context menu is closed and the operational display appears.

Calling up the menu from the context menu

1. Open the context menu.
2. Press  to navigate to the desired menu.
3. Press  to confirm the selection.
 - ↳ The selected menu opens.

5.5.2 Navigating and selecting

Different operating elements are used to navigate through the operating menu. The navigation path is displayed on the left in the header. Icons are displayed in front of the individual menus. These icons are also shown in the header during navigation. Refer to the example below for an overview of the navigation path.

 For an explanation of the navigation view with symbols and operating elements, see *Navigation view* → .

Example: Setting the number of displayed measured values to 2 values

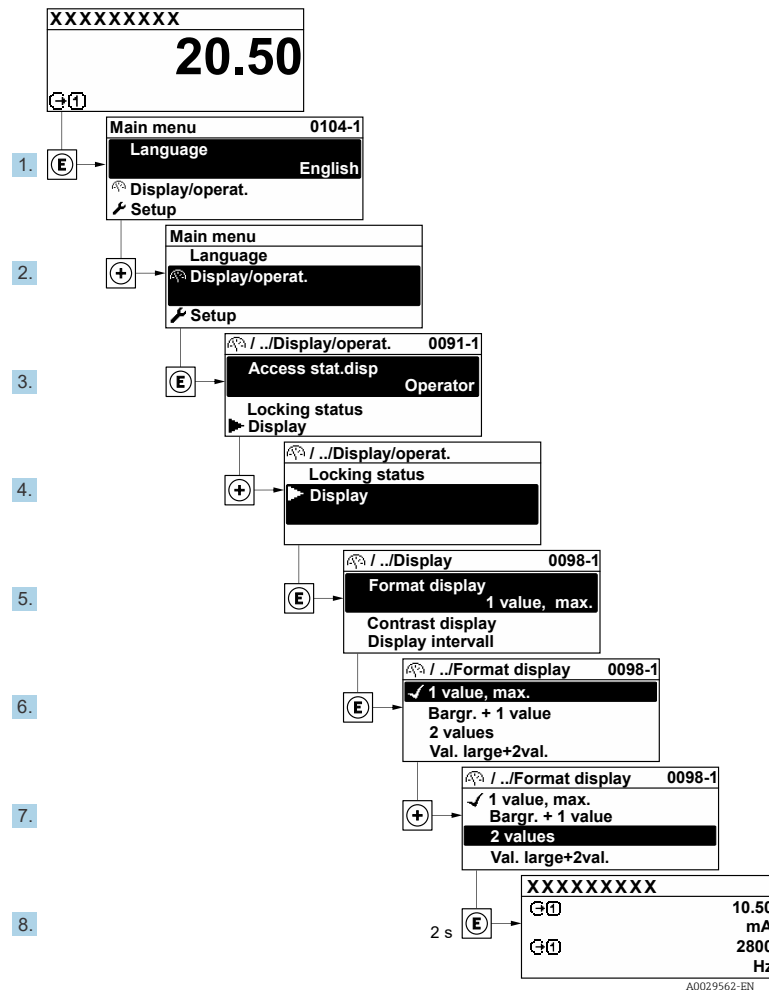

Fig 58. Setting the number of displayed measured values to 2 values

5.5.3 Calling up help text

Help text is available for some parameters and can be called up from the navigation view. The help text provides a brief explanation of the parameter function and thereby supports swift and safe commissioning.

Calling up and closing the help text

The user is in the navigation view and the selection bar is on a parameter.

1. Press **E** for 2 seconds.
 - ↳ The help text for the selected parameter opens.

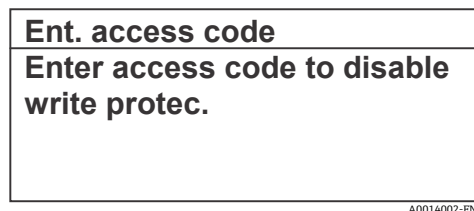



Fig 59. Help text for parameter "Enter access code"

2. Press **E** + **+** simultaneously.
 - ↳ The help text is closed.

5.5.4 Changing the parameters



For a description of the editing display, consisting of *text editor and numeric editor*, with symbols → , for a description of the *operating elements* → .

Example: Changing the tag name in the Tag description parameter from 001-FT-101 to 001-FT-102

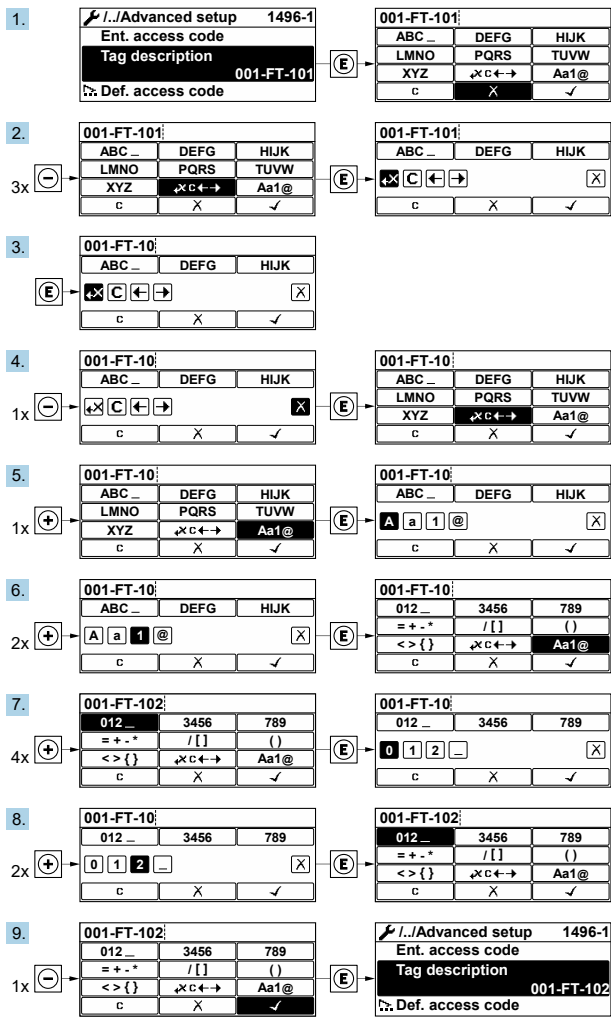

A0029563-EN

Fig 60. Changing the tag name in “Tag description” parameter

A message is displayed if the value entered is outside the permitted value range.

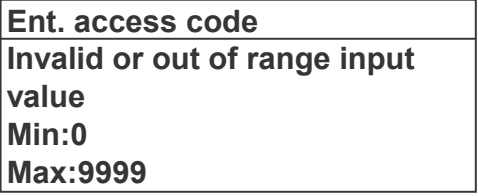

A0014049-EN

Fig 61. Value entered is outside permitted value range

5.5.5 User roles and related access authorization

The two user roles Operator and Maintenance have different write access to the parameters if the customer defines a user-specific access code. This protects the device configuration through the local display from unauthorized access. Refer to *Protecting settings from unauthorized access* → .

Access authorization to parameters: Operator user role

Access Code Status	Read Access	Write Access
An access code has not yet been defined (Factory setting).	✓	✓

Access Code Status	Read Access	Write Access
After an access code has been defined.	✓	— ¹



1

Access authorization to parameters: Maintenance user role



Access Code Status	Read Access	Write Access
An access code has not yet been defined (Factory setting).	✓	✓
After an access code has been defined.	✓	✓ ²

 The user role with which the user is currently logged on is indicated by the **Access status** parameter. Navigation path: Operation → Access status.

5.5.6 Disabling write protection with access code

If the -symbol appears on the local display in front of a parameter, the parameter is write-protected by a user-specific access code and its value cannot be changed at the moment using local operation. See *Write protection through access code* → .

Parameter write protection through local operation can be disabled by entering the user-specific access code in the Enter access code parameter from the respective access option.

1. After you press , the input prompt for the access code appears.
2. Enter the access code.
 - ↳ The -symbol in front of the parameters disappears; all previously write-protected parameters are now re-enabled.

5.5.7 Enabling and disabling the keypad lock

The keypad lock makes it possible to block access to the entire operating menu through local operation. As a result, it is no longer possible to navigate through the operating menu or change the values of individual parameters. Users can only read the measured values on the operational display.

The keypad lock is switched on and off from the context menu.

Switching on the keypad lock

The keypad lock is switched on automatically:

- Each time the device is restarted.
- If the device has not been operated for longer than one minute in the measured value display.

1. The device is in the measured value display.

Press  for at least 2 seconds.

↳ A context menu appears.

2. In the context menu, select the Keylock on option.

↳ The keypad lock is switched on.

 If the user attempts to access the operating menu while the keypad lock is active, the message **Keylock on** appears.

Switching off the keypad lock

1. The keypad lock is switched on.

¹ Despite the defined access code, certain parameters can always be modified and thus are exempted from the write protection, as they do not affect the measurement. Refer to *Write protection through access code* → .

² If an incorrect access code is entered, the user obtains the access rights of the Operator user role.

Press  for at least 2 seconds.

↳ A context menu appears.

2. In the context menu, select the Keylock off option.

↳ The keypad lock is switched off.

5.6 Access the operating menu from the web browser

Thanks to the integrated web server, the device can be operated and configured using a service interface (CDI-RJ45) and connected for Modbus TCP signal transmission. The structure of the operating menu is the same as for the local display. In addition to the measured values, status information on the device is displayed and allows the user to monitor the status of the device. The measuring device data can also be managed and the network parameters can be configured.

5.6.1 Prerequisites

Computer hardware

Hardware	Interface
	CDI-RJ45
Interface	The computer must have an RJ45 interface.
Connection	Standard Ethernet cable with RJ45 connector.
Screen	Recommended size: ≥12 in (depends on the screen resolution)

Computer software

Software	Interface
	CDI-RJ45
Recommended operating systems	<ul style="list-style-type: none"> ▪ Microsoft Windows 7 or higher. ▪ Mobile operating systems: <ul style="list-style-type: none"> ▪ iOS ▪ Android
Web browsers supported	<ul style="list-style-type: none"> ▪ Microsoft Internet Explorer 8 or higher ▪ Microsoft Edge ▪ Mozilla Firefox ▪ Google Chrome ▪ Safari



Computer settings

Settings	Interface
	CDI-RJ45
User rights	Appropriate user rights (e.g., administrator rights) for TCP/IP and proxy server settings are necessary (for adjusting the IP address, subnet mask, etc.).
Proxy server settings of the web browser	The web browser setting <i>Use a Proxy Server for Your LAN</i> must be deselected .
JavaScript	<p>JavaScript must be enabled.</p> <p> If JavaScript cannot be enabled, enter <code>http://192.168.1.212/basic.html</code> in the address line of the web browser. A fully functional but simplified version of the operating menu structure starts in the web browser.</p> <p>When installing a new firmware version: To enable correct data display, clear the temporary memory (cache) of the web browser under Internet options.</p>

Settings	Interface	
	CDI-RJ45	
Network connections	Only the active network connections to the measuring device should be used.	
	Switch off all other network connections such as WLAN.	Switch off all other network connections.

 For connection problems see *Diagnostics and troubleshooting* → .

Measuring device

Settings	Interface	
	CDI-RJ45	
Measuring device	The measuring device has an RJ45 interface.	
Web server	Web server must be enabled; Factory setting: ON. For information on enabling the web server, see <i>enabling the web server</i> →  .	
IP address	If the IP address of the device is not known: <ul style="list-style-type: none"> ■ The IP address can be read out from local operation: Diagnostics → Device information → IP address ■ Communication with the web server can be established from the default IP address 192.168.1.212. The DHCP function is enabled in the device at the factory, i.e. the device expects an IP address to be assigned by the network. This function can be disabled and the device can be set to the default IP address 192.168.1.212: set DIP switch No. 4 from OFF → ON. See <i>Set the default IP address</i> → . 	

5.6.2 Connecting to the analyzer through the service interface (CDI-RJ45)

Preparing the measuring device

1. Loosen the securing clamp of the connection compartment cover.
2. Unscrew the connection compartment cover.
3. Unhitch the display module and place on the side of the controller housing, then open the transparent shield cover from the RJ45 connector.
4. Connect the computer to the RJ45 connector from the standard Ethernet connecting cable.

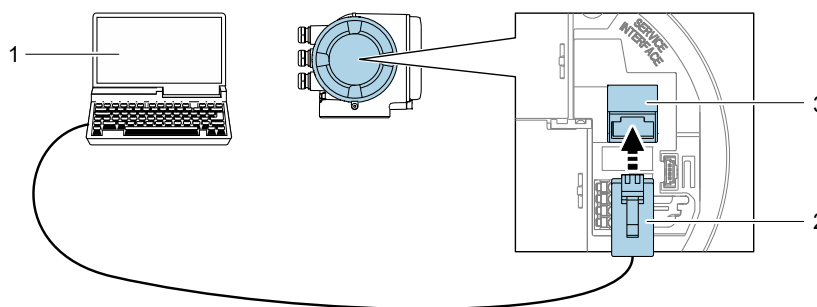





Fig 62. Connecting through CDI-RJ45

#	Name
1	Computer with web browser for accessing the integrated device web server
2	Standard Ethernet connecting cable with RJ45 connector
3	Service interface (CDI-RJ45) of the measuring device with access to the integrated web server

Configuring the Internet protocol of the computer

The measuring device works with the Dynamic Host Configuration Protocol (DHCP) on leaving the factory. The IP address of the measuring device is automatically assigned by the DHCP server.

The IP address can be assigned to the measuring device in a variety of ways:

- **DHCP, Factory setting:** The IP address is automatically assigned to the measuring device by the DHCP server.
- *The IP address is set with DIP switches* → .
- **Software addressing:** The IP address is entered from the *IP address parameter* → .
- **DIP switch for default IP address:** To establish the network connection through the *service interface (CDI-RJ45)* → , the fixed IP address 192.168.1.212 is used.

The following information refers to the default Ethernet settings of the device.

1. Turn on the measuring device.
2. Connect to the computer using *a cable* → .
3. If a second network card is not used, close all the applications on the notebook.
 - ↳ Applications requiring Internet or a network, such as email, SAP applications, Internet or Windows Explorer.
4. Close any open Internet browsers.
5. Configure the properties of the Internet protocol (TCP/IP) as defined in the table below:
 - Only activate one service interface (CDI-RJ45 service interface).
 - If simultaneous communication is necessary: configure different IP address ranges, e.g., 192.168.0.1 and 192.168.1.212 (CDI-RJ45 service interface).

 IP address of the device: 192.168.1.212 (factory setting)

IP address	192.168.1.XXX; for XXX all numerical sequences except: 0, 212 and 255 → e.g., 192.168.1.213
Subnet mask	255.255.255.0
Default gateway	192.168.1.212 or leave cells empty

NOTICE

- ▶ Avoid simultaneous access to the measuring device through the service interface (CDI-RJ45). This could cause a network conflict.

5.6.3 Starting the web browser

1. Start the web browser on the computer.
2. Enter the IP address of the web server in the address line of the web browser: 192.168.1.212
 - ↳ The login page displays.

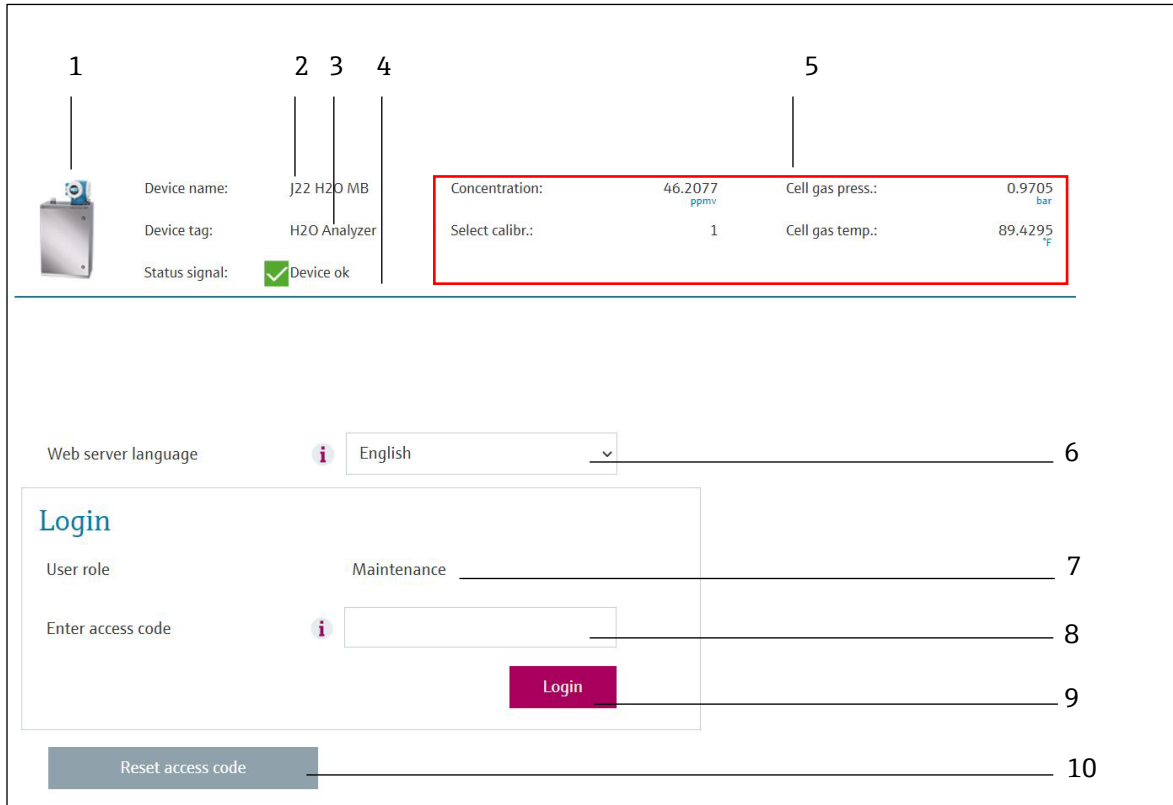

Fig 63. Login page

A0029417

#	Description	#	Description
1	Picture of device	6	Operating language
2	Device name	7	User role
3	Device tag	8	Access code
4	Status signal	9	Login
5	Current measured values	10	Resetting the access code → 📄

If a login page does not appear, or if the page is incomplete → 📄.

5.6.4 Logging on

1. Select the preferred operating language for the web browser.
2. Enter the user-specific access code.
0000
This is the factory-set access code, which can be changed by customer.
3. Click **OK** to confirm your entry.

i If no action is performed for 10 minutes, the web browser automatically returns to the login page.

5.6.5 User interface

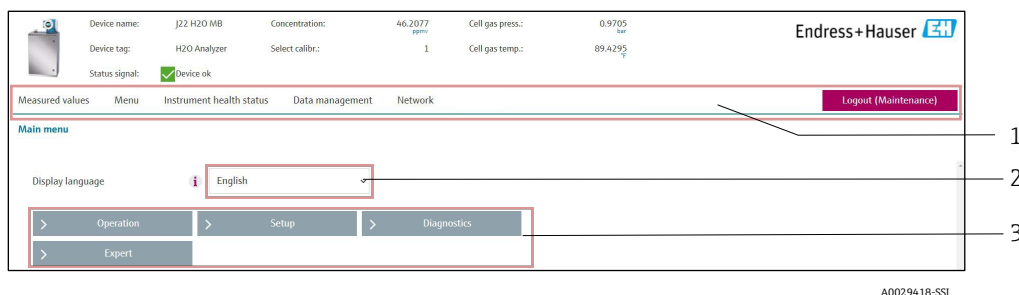

Fig 64. Web browser user interface

#	Description
1	Function row
2	Operating language
3	Navigation area

Header

The following information appears in the header:

- Device tag
- Device status with Status signal →
- Current measured values

Function row

Functions	Meaning
Measured values	Displays the measured values of the measuring device.
Menu	Access to the operating menu from the measuring device The structure of the operating menu is the same as for the local display
Device status	Displays the diagnostic messages currently pending, listed in order of priority.
Data management	<ul style="list-style-type: none"> ▪ Data exchange between PC and measuring device: <ul style="list-style-type: none"> ▪ Load the configuration from the measuring device (XML format, save configuration) ▪ Save the configuration to the measuring device (XML format, restore configuration) ▪ Export the event list (.csv file) ▪ Export parameter settings (.csv file, create documentation of the measuring point configuration) ▪ Export the Heartbeat verification log (PDF file, only available with the Heartbeat Verification application package) ▪ Export SD card log files (.csv file) ▪ Flashing a firmware version
Network configuration	Configuration and checking of all the parameters required for establishing the connection to the measuring device: <ul style="list-style-type: none"> ▪ Network settings (e.g., IP address, MAC address) ▪ Device information (e.g., serial number, firmware version)
Logout	End the operation and call up the login page.

Navigation area

If a function is selected in the function bar, the submenus of the function open in the navigation area. The user can now navigate through the menu structure.

Working area

Depending on the selected function and the related submenus, various actions can be performed in this area:

- Configuring parameters
- Reading measured values
- Calling up help text
- Starting an upload/download

5.6.6 Disabling the web server

The web server of the measuring device can be switched on and off as required using the **web server functionality** parameter.

Navigation Expert menu → Communication → Web server

Parameter	Description	Selection	Factory setting
Web server functionality	Switch the web server on and off.	<ul style="list-style-type: none"> ▪ Off ▪ On 	On

Function scope of the web server functionality parameter

Option	Description
Off	<ul style="list-style-type: none"> ▪ The web server is completely disabled. ▪ Port 80 is locked.
On	<ul style="list-style-type: none"> ▪ The complete functionality of the web server is available. ▪ JavaScript is used. ▪ The password is transferred in an encrypted state. ▪ Any change to the password is also transferred in an encrypted state.

Enabling the web server

If the web server is disabled it can only be re-enabled with the web server functionality parameter through the local display.

5.6.7 Logging out

Before logging out, perform a data backup through the **Data management** function.

1. Select the **Logout** entry in the function row.
 - ↳ The home page with the Login box appears.
2. Close the web browser.
3. Reset the modified properties of the Internet protocol (TCP/IP) if they are no longer needed. See *Modbus RS485 or Modbus TCP information* → .



If communication with the web server was established through the default IP address 192.168.1.212, DIP switch No. 10 must be reset from **ON** → **OFF**. Afterwards, the IP address of the device is active again for network communication.

5.7 Remote operation using Modbus

5.7.1 Connecting the analyzer through Modbus RS485 protocol

This communication interface is available through Modbus RTU over RS485.

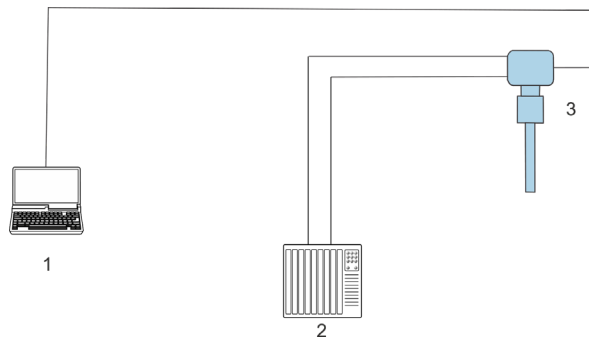

A0055166

Fig 65. Connecting through Modbus RTU over RS485 protocol

#	Description
1	Computer with web browser for temporarily accessing the web server for settings and diagnostics
2	Automation/control system, such as PLC
3	JT33 TDLAS gas analyzer

5.7.2 Connecting the analyzer through Modbus TCP protocol

This communication interface is available through Modbus TCP/IP network: star topology.

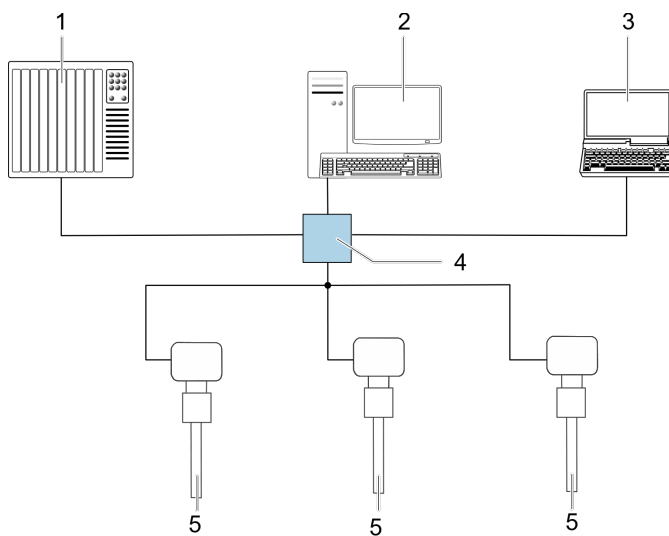

A0055167

Fig 66. Connecting through Modbus TCP protocol

#	Description
1	Automation/control system, such as PLC
2	Workstation for measurement operation
3	Computer with web browser for accessing the integrated device web server
4	Ethernet switch
5	J22 TDLAS gas analyzer

6 Modbus communication

6.1 Overview of device description files

Current version data for the device.

Firmware version	01.04	<ul style="list-style-type: none"> ■ On the title page of the Operating instructions ■ Diagnostics → Device information → Firmware version
Release date of firmware version	11.2022	---

6.2 Modbus RS485 or Modbus TCP Function codes

Function codes are used to define which read or write action is carried out through the Modbus protocol. The measuring device supports the following function codes:

Code	Name	Description	Application
03	Read holding register	Client reads one or more Modbus registers from the device. A maximum of 125 consecutive registers can be read with 1 telegram: 1 register = 2 bytes. The measuring device does not make a distinction between function codes 03 and 04; these codes therefore yield the same result.	Read device parameters with read and write access
04	Read input register	Client reads one or more Modbus registers from the device. A maximum of 125 consecutive registers can be read with 1 telegram: 1 register = 2 bytes. The measuring device does not make a distinction between function codes 03 and 04; these codes therefore yield the same result.	Read device parameters with read Access
06	Write single registers	Client writes a new value to one Modbus register of the measuring device. Use function code 16 to write multiple registers with just 1 telegram.	Write only 1 device parameter
08	Diagnostics	Client checks the communication connection to the measuring device. The following Diagnostics codes are supported: <ul style="list-style-type: none"> ■ Sub-function 00 = Return query data (loopback test) ■ Sub-function 02 = Return diagnostics register 	
16	Write multiple registers	Client writes a new value to multiple Modbus registers of the device. A maximum of 120 consecutive registers can be written with 1 telegram. If the required device parameters are not available as a group, yet must nevertheless be addressed with a single telegram, use <i>Modbus data map</i> →  .	Write multiple device parameters
23	Read/Write multiple registers	Client reads and writes a maximum of 118 Modbus registers of the measuring device simultaneously with 1 telegram. Write access is executed before read access.	Write and read multiple device parameters



Broadcast messages are only allowed with function codes 06, 16, and 23.

6.3 Response time

Response time of the measuring device to the request telegram of the Modbus client is typically 3 to 5 ms.

6.4 Modbus data map

Function of the Modbus data map

The device offers a special memory area, the Modbus data map (for a maximum of 16 device parameters), to allow users to call up multiple device parameters through Modbus RS485 or Modbus TCP and not only individual device parameters or a group of consecutive device parameters. Modbus TCP/IP clients and servers listen and receive Modbus data through port 502.

Grouping of device parameters is flexible and the Modbus client can read or write to the entire data block simultaneously with a single request telegram.

Structure of the Modbus data map

The Modbus data map consists of two data sets:

- **Scan list: Configuration area.** The device parameters to be grouped are defined in a list in that their Modbus RS485 or Modbus TCP register addresses are entered in the list.
- **Data area.** The measuring device reads out the register addresses entered in the scan list cyclically and writes the associated device data (values) to the data area.

6.4.1 Scan list configuration

For configuration, the Modbus RS485 or Modbus TCP register addresses of the device parameters to be grouped must be entered in the scan list. Please note the following basic requirements of the scan list:

Max. entries	16 device parameters
Supported device parameters	Only parameters with the following characteristics are supported: <ul style="list-style-type: none"> ▪ Access type: read or write access ▪ Data type: float or integer

Configuring the scan list through Modbus RS485 or Modbus TCP

Carried out using register addresses 5001 – 5016

Scan list

No.	Modbus RS485 or Modbus TCP register	Data type	Configuration register
0	Scan list register 0	Integer	Scan list register 0
...	...	Integer	
15	Scan list register 15	Integer	Scan list register 15

6.4.2 Reading out data through Modbus RS485 or Modbus TCP

The Modbus client accesses the data area of the Modbus data map to read out the current values of the device parameters defined in the scan list.

Client access to data area	From register addresses 5051 to 5081
-----------------------------------	--------------------------------------

Data area

Device parameter value	Modbus RS485 or Modbus TCP register	Data type ¹	Access ²
Value of scan list register 0	5051	Integer/float	Read/write
Value of scan list register 1	5053	Integer/float	Read/write
Value of scan list register
Value of scan list register 15	5081	Integer/float	Read/write

6.5 Modbus registers

Parameter	Register	Data Type	Access	Range
Concentration	9455 to 9456	Float	Read	Signed floating-point number
Dew point 1	21458 to 21459	Float	Read	Signed floating-point number
Dew point 2	21800 to 21801	Float	Read	Signed floating-point number
Cell gas temperature	21854 to 21855	Float	Read	Signed floating-point number
Cell gas pressure	25216 to 25217	Float	Read	Signed floating-point number
Diagnostic service ID	2732	Integer	Read	0 to 65535
Diagnostic number	6801	Integer	Read	0 to 65535
Diagnostic Status signal	2075	Integer	Read	0: OK 1: Failure (F) 2: Function check (C) 8: Out of specification (S) 4: Maintenance required (M) 16: --- 32: Not categorized
Diagnostic string	6821 to 6830	String	Read	Diagnostic number, service ID and Status signal
Pipeline pressure	9483 to 9484	Float	Read/Write	0 to 500 bar; write to this value when Pipeline pressure mode = External value
Start validation	30015	Integer	Read/Write	0: Cancel, 1: Start

¹ Data type depends on the device parameters entered in the scan list.

² Data access depends on the device parameters entered in the scan list. If the device parameter entered supports read and write access, the parameter can also be accessed from the data area.

7 Commissioning

7.1 Language

Factory setting: English

7.2 Configuring the measuring device

The Setup menu with its guided wizards contains all the parameters needed for standard operation.

Navigation to the Setup menu

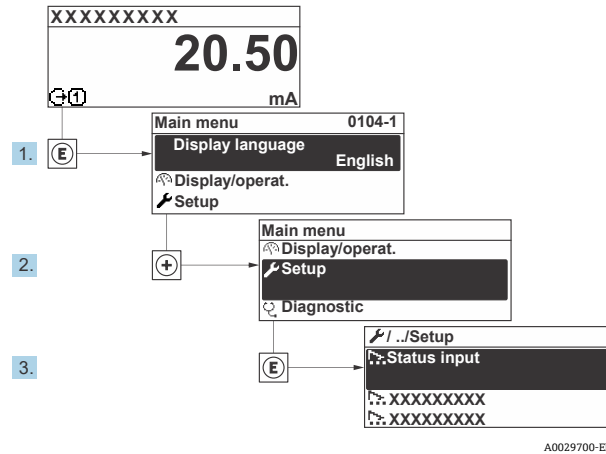
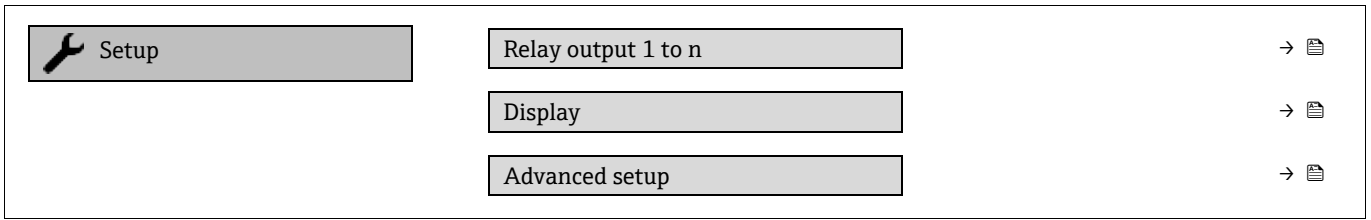

Fig 67. Local display example

i Depending on the device version, not all submenus and parameters are available in every device. The selection can vary depending on the order code.

Setup	Device tag	→
	Analyte type	→
	Select calibration	→
	System units	→
	Dew point	→
	Peak tracking	→
	Communication	→
	I/O configuration	→
	Current output 1 to n	→
	Current input 1 to n	→
	Switch output 1 to n	→



7.3 Defining the tag name

To enable fast identification of the measuring point within the system, you can enter a unique designation using the Device tag parameter and thus change the Factory setting.

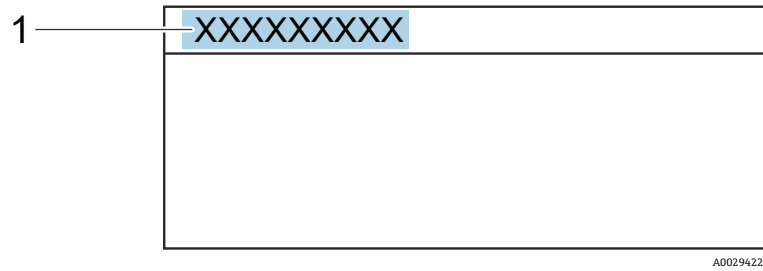

Fig 68. Header of the operational display with tag name (1)

Navigation Setup menu → Device tag

Parameter	Description	User entry	Factory setting
Device tag	Enter the name for the measuring point.	Max. 32 characters, such as number or special characters (e.g., @, %, /)	H ₂ O analyzer

7.4 Setting the analyte type

Sets the analyte type measured by the analyzer.

Navigation Setup menu → Analyte type

Parameter	Description	User entry	Factory setting
Analyte type	The analyte measured by the analyzer.	–	H ₂ O

7.5 Selecting the measurement calibration

Select the calibration to be measured for your device.

Navigation Setup menu → Select calibration

Parameter	Description	User entry	Factory setting
Select calibration	Select the calibration for measurement. (User defined.) In most cases, calibrations are as follows: 1) Process stream as defined by customer order 2) Methane background 3) Nitrogen background 4) Not used	<ul style="list-style-type: none"> ▪ 1 ▪ 2 ▪ 3 ▪ 4 	1

7.6 Setting system units

In the System units submenu, the units of all the measured values can be set.

i Depending on the device version, not all submenus and parameters are available in every device. The selection can vary depending on the order code.

Navigation Setup menu → System units

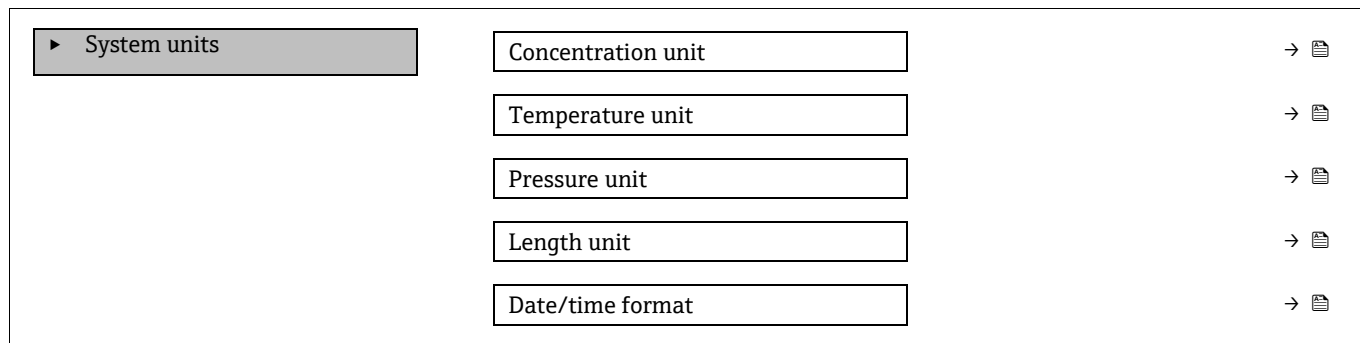

Parameter	Description	User entry	User selected options
Concentration unit	Sets the display unit for concentration. The selected unit applies for concentration.	<ul style="list-style-type: none"> ■ ppmv ■ ppbv ■ % vol ■ lb/MMscf ■ mg/sm³ ■ mg/Nm³ ■ user conc. 	ppmv
Temperature unit	Select temperature difference unit. The selected unit applies for cell gas temperature standard deviation.	SI units <ul style="list-style-type: none"> ■ °C ■ K US units <ul style="list-style-type: none"> ■ °F ■ °R 	Approval specific: <ul style="list-style-type: none"> ■ °C ■ °F
Pressure unit	Select process pressure unit. The selected unit applies for cell gas pressure.	SI units <ul style="list-style-type: none"> ■ MPa a ■ MPa g ■ kPa a ■ kPa g ■ Pa a ■ Pa g ■ bar ■ bar g ■ mbar ■ mBarg US units <ul style="list-style-type: none"> ■ psig a ■ psig g 	Approval specific: <ul style="list-style-type: none"> ■ mbar a ■ psi a
Length unit	Sets the display unit for length. The selected unit applies for cell length.	<ul style="list-style-type: none"> ■ m ■ ft ■ in ■ mm ■ μm 	m
Date/time format	Sets the display unit for Date/time format.	<ul style="list-style-type: none"> ■ dd.mm.yy hh:mm ■ dd.mm.yy hh:mm am/pm ■ mm/dd/yy hh:mm ■ mm/dd/yy hh:mm am/pm 	dd.mm.yy hh:mm

7.7 Setting the dew point

The dew point submenu configures parameters needed to perform a moisture dew point calculation.

Navigation Setup menu → Dew point

▶ Dew point	Dew point method 1	→
	Dew point method 2	→
	Conversion type	→
	Pipeline pressure mode	→
	Pipeline pressure fixed	→
	Pipeline pressure	→

Parameter	Prerequisite	Description	User entry	Factory setting
Dew point method 1	—	Sets the method used to calculate dew point temperature.	<ul style="list-style-type: none"> ■ Off ■ ASTM¹ ■ ASTM² ■ ISO³ ■ AB 	ASTM2
Dew point method 2	—	Sets the method used to calculate dew point temperature.	<ul style="list-style-type: none"> ■ Off ■ ASTM¹ ■ ASTM² ■ ISO³ ■ AB 	Off
Conversion type	Used if Dew point is enabled by selecting a method above.	Sets conversion type used to calculate dew point temperature.	<ul style="list-style-type: none"> ■ Ideal ■ Real 	Ideal
Pipeline pressure mode	Used if Dew point is enabled by selecting a method above.	Sets the method the pipeline pressure is input for the dew point calculation.	<ul style="list-style-type: none"> ■ Current input 1 to n ■ Fixed value ■ External value 	Fixed value
Pipeline pressure fixed	Used if fixed value is selected from Pipeline pressure mode.	Sets a fixed pressure at which the dew point temperature is calculated.	Floating point number	<ul style="list-style-type: none"> ■ 50000 mbar a ■ 725 psi a
Pipeline pressure	Used if Current input or External value is selected from Pipeline pressure mode.	The pipeline pressure value used by the dew point calculation based on the Pipeline pressure mode setting. Current input is the value from the selected I/O slot 1 to n. External value is the value set from the Modbus fieldbus. See Modbus registers → for more info.	None, read only	None, read only

¹ ASTM D1142 equation 1



² ASTM D1142 equation 2

³ ISO 18453 Natural Gas

7.8 Setting peak tracking

The peak tracking submenu controls the software utility that keeps the laser scan centered on the absorption peak. Under some circumstances, the peak tracking function can get lost and lock onto the wrong peak. If the system alarm displays, the peak tracking function should be reset.

Navigation Setup menu → Peak Tracking









▶ Peak tracking	Peak track analyzer control	→ 
	Peak track reset	→ 
	Peak track average number	→ 

Parameter	Prerequisite	Description	User entry	Factory setting
Peak track analyzer control	–	Sets peak tracking capability to OFF or ON.	<ul style="list-style-type: none"> ■ Off ■ On 	Off
Peak track reset	Used if peak tracking is set above.	Resets peak tracking.	<ul style="list-style-type: none"> ■ Off ■ Reset 	Off
Peak track average number	Used if peak tracking is set above.	Sets number of measurements before making a peak tracking adjustment.	Positive integer	10

7.9 Configuring the communication interface

The **Communication** submenu guides you systematically through all the parameters that have to be configured for selecting and setting the communication interface.

Navigation Setup menu → Communication

▶ Communication	Bus address ¹	→ 
	Baudrate ¹	→ 
	Data trans. Mode ¹	→ 
	Parity ¹	→ 
	Byte order ²	→ 
	Prio. IP address ³	→ 
	Inactivity timeout ³	→ 
	Max connections ³	→ 
	Failure mode ²	→ 

¹ Modbus RS485 only

² Both Modbus RS485 and TCP

³ Modbus TCP only

Parameter	Prerequisite	Description	User entry	Factory setting
Bus address	Modbus RS485 only	Enter device address.	1 to 247	247
Baudrate	Modbus RS485 device	Define data transfer speed.	<ul style="list-style-type: none"> ■ 1200 BAUD ■ 2400 BAUD ■ 4800 BAUD ■ 9600 BAUD ■ 19200 BAUD ■ 38400 BAUD ■ 57600 BAUD ■ 115200 BAUD 	19200 BAUD
Data trans. mode	Modbus RS485 device	Select data transfer mode.	<ul style="list-style-type: none"> ■ ASCII ■ RTU 	RTU
Parity	Modbus RS485 device	Select parity bits.	Picklist ASCII option: <ul style="list-style-type: none"> ■ 0 = Even option ■ 1 = Odd option Picklist RTU option: <ul style="list-style-type: none"> ■ 0 = Even option ■ 1 = Odd option ■ 2 = None / 1 stop bit option ■ 3 = None / 2 stop bits option 	Even
Byte order	Both Modbus RS485 and Modbus TCP	Select byte transmission sequence.	<ul style="list-style-type: none"> ■ 0-1-2-3 ■ 3-2-1-0 ■ 1-0-3-2 ■ 2-3-0-1 	1-0-3-2
Prio. IP address	Modbus TCP device	The IP address for which connections are accepted by the priority pool.	IP address	0.0.0.0
Inactivity timeout	Modbus TCP device	Time before a connection can be terminated due to inactivity. A setting of zero means no timeout.	0 to 99 seconds	0 seconds
Max connections	Modbus TCP device	Maximum number of concurrent connections. Priority pool connections take precedence and are never denied connection thus causing the oldest connection to be terminated.	1 to 4	4
Failure mode	Both Modbus RS485 and Modbus TCP	Select measured value output behavior when a diagnostic message occurs through Modbus communication. Not a Num (NaN).	—	—

7.10 Configuring the current input

The Current input wizard guides the user systematically through all the parameters that have to be set for configuring the current input.

Navigation Setup menu → Current input

▶ Current input 1 to n	Current span	→
	Terminal number	→
	Signal mode	→
	0/4 mA value	→
	20 mA value	→
	Failure mode	→
	Failure current	→

Parameter	Prerequisite	Description	User entry	Factory setting
Current span	—	Select current range for process value output and upper/lower level for alarm signal.	<ul style="list-style-type: none"> ■ 4...20 mA ■ 4...20 mA NE ■ 4...20 mA US ■ 0...20 mA 	Approval-specific: <ul style="list-style-type: none"> ■ 4...20 mA NE ■ 4...20 mA US
Terminal number	—	Shows the terminal numbers used by the current input module.	<ul style="list-style-type: none"> ■ Not used ■ 24-25 (I/O 2) ■ 22-23 (I/O 3) 	—
Signal mode	The measuring device is not approved for use in the hazardous area with Ex-i protection type.	Select the signal mode for the current input.	<ul style="list-style-type: none"> ■ Passive ■ Active 	Passive
0/4 mA value	—	Enter 4 mA value.	Signed floating-point number	Approval-specific: <ul style="list-style-type: none"> ■ mbar a ■ psi a
20 mA value	—	Enter 20 mA value.	Signed floating-point number	Approval-specific: <ul style="list-style-type: none"> ■ mbar a ■ psi a
Failure mode	—	Define input behavior in alarm condition.	<ul style="list-style-type: none"> ■ Alarm ■ Last valid value ■ Defined value 	Alarm
Failure current	In the <i>Failure mode</i> parameter, the Defined value option is selected.	Enter the value to be used by the device if input value from external device is missing.	Signed floating-point number	0

7.11 Configuring the current output

The Current output wizard systematically guides you through all the parameters that have to be set for configuring the current output.

Navigation Setup menu → Current output

▶ Current output 1 to n	Pro.var. outp	→
	Terminal number	→
	Current range output	→
	Signal mode	→
	Lower range value output	→
	Upper range value output	→
	Damping current	→
	Fixed current	→
	Fail.behav.out	→
	Failure current	→

Parameter	Prerequisite	Description	User entry	Factory setting
Pro.var. outp	–	Select process variable for current output.	<ul style="list-style-type: none"> ■ Off ■ Concentration ■ Dew point 1¹ ■ Dew point 2¹ ■ Cell gas temperature 	Concentration
Terminal number	–	Shows the terminal numbers used by the current output module.	<ul style="list-style-type: none"> ■ Not used ■ 24-25 (I/O 2) ■ 22-23 (I/O 3) 	–
Current range output	–	Select current range for process value output and upper/lower level for alarm signal.	<ul style="list-style-type: none"> ■ 4...20 mA NE ■ 4...20 mA US ■ 4...20 mA ■ 0...20 mA ■ Fixed value 	Approval specific: <ul style="list-style-type: none"> ■ 4...20 mA NE ■ 4...20 mA US
Signal mode	–	Select the signal mode for the current output.	<ul style="list-style-type: none"> ■ Passive ■ Active 	Passive
Lower range value output	One of the following options is selected in the <i>Current span</i> parameter: <ul style="list-style-type: none"> ■ 4...20 mA NE ■ 4...20 mA US ■ 4...20 mA ■ 0...20 mA 	Enter 4 mA value.	Signed floating-point number	0 ppmv
Upper range value output	One of the following options is selected in the <i>Current span</i> parameter:	Enter 20 mA value.	Signed floating-point number	Depends on calibration range

¹ Options may be dependent on other parameter settings.

Parameter	Prerequisite	Description	User entry	Factory setting
	<ul style="list-style-type: none"> ■ 4...20 mA NE ■ 4...20 mA US ■ 4...20 mA ■ 0...20 mA 			
Damping current	One of the following options is selected in the <i>Current span</i> parameter: <ul style="list-style-type: none"> ■ 4...20 mA NE ■ 4...20 mA US ■ 4...20 mA ■ 0...20 mA 	Set reaction time for output signal to fluctuations in the measured value.	0.0 to 999.9 seconds	0 seconds
Fixed current	In the <i>Current span</i> parameter, the Fixed current option is selected.		0 to 22.5 mA	22.5 mA
Fail.behav.out	One of the following options is selected in the <i>Current span</i> parameter: <ul style="list-style-type: none"> ■ 4...20 mA NE ■ 4...20 mA US ■ 4...20 mA ■ 0...20 mA 	Define output behavior in alarm condition.	<ul style="list-style-type: none"> ■ Min ■ Max. ■ Last valid value ■ Actual value ■ Fixed value 	Max.
Failure current	In the <i>Failure mode</i> parameter, the Defined value option is selected.	Enter current output value in alarm condition.	0 to 22.5 mA	22.5 mA

7.12 Configuring the switch output

The switch output wizard guides you systematically through all the parameters that can be set for configuring the selected output type.

Navigation Setup menu → switch output

<div style="background-color: #cccccc; padding: 2px 5px; border: 1px solid black;">▶ Switch output 1 to n</div>	<input style="width: 90%; height: 20px; border: 1px solid black;" type="text" value="Operating mode"/>	→
	<input style="width: 90%; height: 20px; border: 1px solid black;" type="text" value="Terminal number"/>	→
	<input style="width: 90%; height: 20px; border: 1px solid black;" type="text" value="Signal mode"/>	→
	<input style="width: 90%; height: 20px; border: 1px solid black;" type="text" value="Switch output function"/>	→
	<input style="width: 90%; height: 20px; border: 1px solid black;" type="text" value="Assign diagnostic behavior"/>	→
	<input style="width: 90%; height: 20px; border: 1px solid black;" type="text" value="Assign limit"/>	→
	<input style="width: 90%; height: 20px; border: 1px solid black;" type="text" value="Assign status"/>	→
	<input style="width: 90%; height: 20px; border: 1px solid black;" type="text" value="Switch-on value"/>	→
	<input style="width: 90%; height: 20px; border: 1px solid black;" type="text" value="Switch-off value"/>	→
	<input style="width: 90%; height: 20px; border: 1px solid black;" type="text" value="Switch-on delay"/>	→
	<input style="width: 90%; height: 20px; border: 1px solid black;" type="text" value="Switch-off delay"/>	→
	<input style="width: 90%; height: 20px; border: 1px solid black;" type="text" value="Invert output signal"/>	→

Parameter	Prerequisite	Description	User entry	Factory setting
Operating mode	–	Define the output as a switch output.	Switch	Switch
Terminal number	–	Shows the terminal numbers used by the switch output module.	<ul style="list-style-type: none"> ▪ Not used ▪ 24-25 (I/O 2) ▪ 22-23 (I/O 3) 	–
Signal mode	–	Select the signal mode for the switch output.	<ul style="list-style-type: none"> ▪ Passive ▪ Active ▪ Passive NE 	Passive
Switch output function	–	Select function for switch output.	<ul style="list-style-type: none"> ▪ Off ▪ On ▪ Diagnostic behavior ▪ Limit ▪ Status 	Diagnostic behavior
Assign diagnostic behavior	In the <i>Switch output function</i> parameter, the Diagnostic behavior option is selected.	Select Diagnostic behavior for switch output.	<ul style="list-style-type: none"> ▪ Alarm ▪ Alarm or warning ▪ Warning 	Alarm
Assign limit	In the <i>Switch output function</i> parameter, the Limit option is selected.	Select process variable for limit function.	<ul style="list-style-type: none"> ▪ Off ▪ Concentration ▪ Dew point 1¹ ▪ Dew point 2¹ 	Off
Assign status	The Status option is selected in the <i>Switch output function</i> parameter.	Select the device status for switch output.	<ul style="list-style-type: none"> ▪ Off ▪ Validation control 	Off
Switch-on value	In the <i>Switch output function</i> parameter, the Limit option is selected.	Enter measured value for the switch-on point.	Signed floating-point number	0 ppmv
Switch-off value	In the <i>Switch output function</i> parameter, the Limit option is selected.	Enter measured value for the switch-off point.	Signed floating-point number	0 ppmv
Switch-on delay	The Limit option is selected in the <i>Switch output function</i> parameter.	Define delay for the switch-on of status output.	0.0 to 100.0 s	0.0 s
Switch-off delay	The Limit option is selected in the <i>Switch output function</i> parameter.	Define delay for the switch-off of status output.	0.0 to 100.0 s	0.0 s
Invert output signal	–	Invert the output signal.	<ul style="list-style-type: none"> ▪ No ▪ Yes 	No

¹ Options may be dependent on other parameter settings.

7.13 Configuring the relay output

The Relay output wizard guides the user systematically through all the parameters that have to be set for configuring the relay output.

Navigation Setup menu → Relay output 1 to n

▶ Relay output 1 to n	Relay output function	→
	Terminal number	→
	Assign limit	→
	Assign diagnostic behavior	→
	Assign status	→
	Switch-off value	→
	Switch-on value	→
	Switch-off delay	→
	Switch-on delay	→
	Failure mode	→

Parameter	Prerequisite	Description	User entry	Factory setting
Relay output function	—	Select the function for the relay output.	<ul style="list-style-type: none"> ■ Closed ■ Open ■ Diagnostic behavior ■ Limit ■ Status 	Diagnostic behavior
Terminal number	—	Shows the terminal numbers used by the relay output module.	<ul style="list-style-type: none"> ■ Not used ■ 24-25 (I/O 2) ■ 22-23 (I/O 3) 	—
Assign limit	In the <i>Relay output function</i> parameter, the Limit option is selected.	Select process variable for limit function.	<ul style="list-style-type: none"> ■ Off ■ Concentration ■ Dew point 1¹ ■ Dew point 2¹ 	Off
Assign diagnostic behavior	In the <i>Relay output function</i> parameter, the Diagnostic behavior option is selected.	Select Diagnostic behavior for switch output.	<ul style="list-style-type: none"> ■ Alarm ■ Alarm or warning ■ Warning 	Alarm
Assign status	In the <i>Relay output function</i> parameter, the Digital Output option is selected.	Select device status for switch output.	<ul style="list-style-type: none"> ■ Off ■ Validation control 	Off
Switch-off value	In the <i>Relay output function</i> parameter, the Limit option is selected.	Enter measured value for the switch-off point.	Signed floating-point number	0 ppmv
Switch-on value	In the <i>Relay output function</i> parameter, the Limit option is selected.	Enter measured value for the switch-on point.	Signed floating-point number	0 ppmv









¹ Options may be dependent on other parameter settings.

Parameter	Prerequisite	Description	User entry	Factory setting
Switch-off delay	In the <i>Relay output function</i> parameter, the Limit option is selected.	Define delay for the switch-off of status output.	0.0 to 100.0 s	0.0 s
Switch-on delay	In the <i>Relay output function</i> parameter, the Limit option is selected.	Define delay for the switch-on of status output.	0.0 to 100.0 s	0.0 s
Failure mode	–	Define output behavior in alarm condition.	<ul style="list-style-type: none"> ■ Actual status ■ Open ■ Closed 	Open

7.14 Configuring the local display

The Display wizard guides you systematically through all the parameters that can be configured for configuring the local display.

Navigation Setup menu → Display

▶ Display	Format display	→ 
	Value 1 display	→ 
	0% bargraph value 1	→ 
	100% bargraph value 1	→ 
	Value 2 display	→ 
	Value 3 display	→ 
	0% bargraph value 3	→ 
	100% bargraph value 3	→ 
	Value 4 display	→ 

Parameter	Prerequisite	Description	User entry	Factory setting
Format display	A local display is provided.	Select how measured values are shown on the display.	<ul style="list-style-type: none"> ■ 1 value, max. size ■ 1 bargraph + 1 value ■ 2 values ■ 1 value large + 2 values ■ 4 values 	1 value, max. size
Value 1 display	A local display is provided.	Select the measured value that is shown on the display.	<ul style="list-style-type: none"> ■ Concentration ■ Dewpoint 1 ■ Dewpoint 2 ■ Cell gas pressure ■ Cell gas temperature 	Concentration
0% bargraph value 1	A local display is provided.	Enter 0% value for bar graph display	Signed floating-point number	0 ppmv
100% bargraph value 1	A local display is provided.	Enter 100% value for bar graph display	Signed floating-point number	Depends on calibration range

Parameter	Prerequisite	Description	User entry	Factory setting
Value 2 display	A local display is provided.	Select the measured value that is shown on the local display.	<ul style="list-style-type: none"> ■ None ■ Concentration ■ Dewpoint 1 ■ Dewpoint 2 ■ Cell gas pressure ■ Cell gas temperature 	Dewpoint 1
Value 3 display	A local display is provided.	Select the measured value that is shown on the local display.	For the picklist, see the Value 2 display parameter	Cell gas pressure
0% bargraph value 3	A selection was made in the <i>Value 3 display</i> parameter.	Enter 0% value for bar graph display.	Signed floating-point number	700 mbar a
100% bargraph value 3	A selection was made in the <i>Value 3 display</i> parameter.	Enter 100% value for bar graph display.	Signed floating-point number	1700 mbar a
Value 4 display	A local display is provided.	Select the measured value that is shown on the local display.	For the picklist, see the Value 2 display parameter	Cell gas temperature

7.15 Advanced settings

The Advanced setup submenu together with its submenus contains parameters for specific settings.

Navigation to the Advanced setup submenu

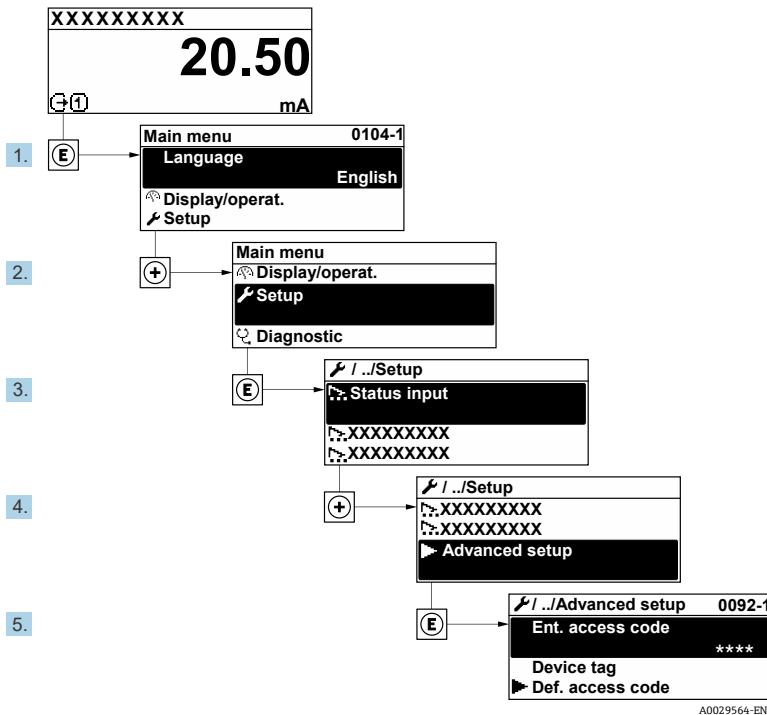

Fig 69. Navigation to the advanced setup menu

i The number of submenus can vary depending on the device version. Some submenus are not dealt with in the Operating Instructions. These submenus and the parameters they contain are explained in the Special Documentation for the device.

Navigation Setup menu → Advanced setup

7.15.1 Stream submenu

In the stream submenu, you can set parameters related to the stream that needs to be measured.

Navigation Setup menu → Advanced setup → Stream

Parameter	Description	User entry	Factory setting
Analyte type	The analyte measured by the analyzer.	–	H ₂ O
Select calibration	Changes and sets the calibration	<ul style="list-style-type: none"> ■ 1 ■ 2 ■ 3 ■ 4 	1
Rolling average number	Sets the number of measurements included in the running average.	Positive integer	4

7.15.2 Sensor adjustment submenu

The sensor adjustment submenu contains parameters that pertain to the functionality of the sensor.

Navigation Setup menu → Advanced setup → Sensor adjustment

▶ Sensor adjustment	Concentration adjust	→
	Concentration multiplier (RATA)	→
	Concentration offset (RATA)	→
	2fbase curve source	→
	2fbase curve RT update	→
▶ Calibration 1 to n		→

Parameter	Prerequisite	Description	User entry	Factory setting
Concentration adjust	–	Enables or disables adjustment factors.	<ul style="list-style-type: none"> ■ On ■ Off 	Off
Concentration multiplier (RATA)	Used if Concentration Adjust is enabled.	Slope adjustment factor.	Signed floating point number	1.0
Concentration offset (RATA)	Used if Concentration Adjust is enabled.	Offset adjustment factor.	Signed floating point number	0
2fbase curve source	Used if Base Curve subtraction is enabled.	Selects which reference to subtract.	<ul style="list-style-type: none"> ■ Ref0Curve ■ RefORTCurve 	Ref0Curve
2fbase curve RT update	Used if Base Curve subtraction is enabled.	Option to update the stored RT base curve	<ul style="list-style-type: none"> ■ Cancel ■ Start 	Cancel

7.15.2.1 Calibration 1 to n submenu

Up to four calibrations are available. Only the active calibration will be displayed at any one time.

Navigation Setup menu → Advanced setup → Sensor adjustment → Calibration

▶ Calibration 1 to n	Laser midpoint default	→
	Laser ramp default	→
	Laser modulation amplitude default	→

Parameter	Description	User entry	Factory setting
Laser midpoint default	The factory set midpoint of the current ramp for the laser in 2f spectroscopy.	Positive Floating point number	Per calibration
Laser ramp default	The factory set span of the current ramp for the laser in 2f spectroscopy.	Positive Floating point number	Per calibration
Laser modulation amplitude default	The factory set amplitude of the current modulation for the laser in 2f spectroscopy.	Positive Floating point number	Per calibration

7.15.3 Stream change compensation calibration submenu

This submenu contains parameters to configure the stream change compensation adjustment. Up to four calibrations are available. Only the active calibration will be displayed at any one time.

Navigation Setup menu → Advanced setup → Stream change compensation

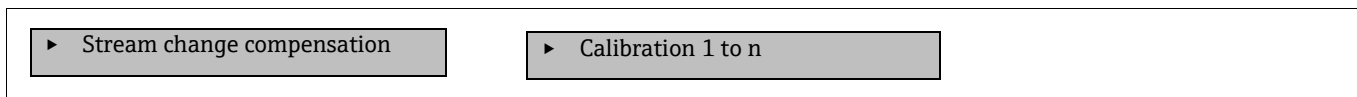

Navigation Setup menu → Advanced setup → Stream change compensation → Calibration 1 to n

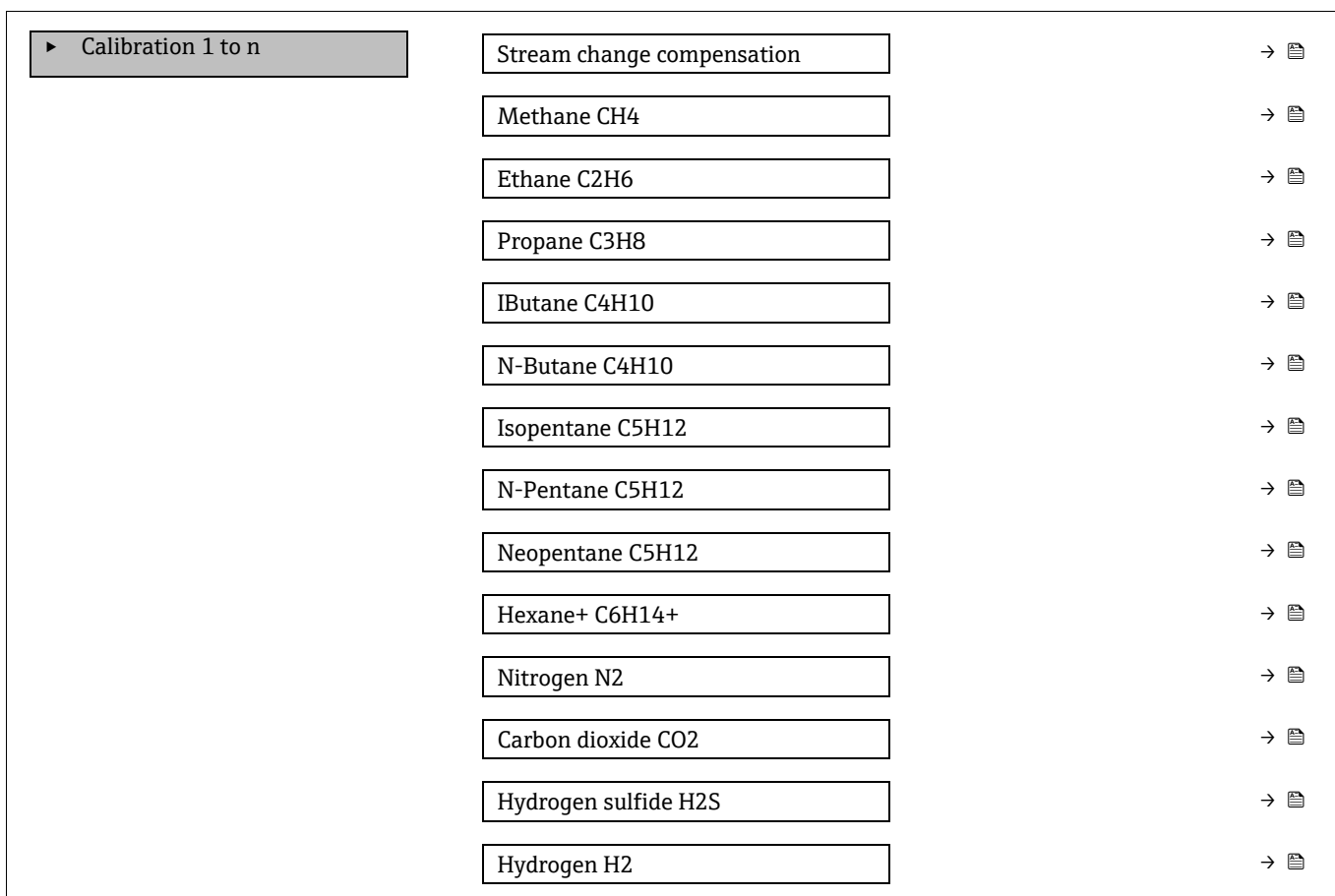

 The term “mol” in the table below is an abbreviation for mole fraction.





















Parameter	Description	User entry	Factory setting
Stream change compensation	Enables or disables the Stream Change Compensation feature.	<ul style="list-style-type: none"> ▪ On ▪ Off 	Off
Methane CH ₄	Sets the mole fraction of Methane in the dry gas mixture.	0.4 to 1.0 mol	0.75 mol
Ethane C ₂ H ₆	Sets the mole fraction of Ethane in the dry gas mixture.	0.0 to 0.2 mol	0.1 mol
Propane C ₃ H ₈	Sets the mole fraction of Propane in the dry gas mixture.	0.0 to 0.15 mol	0.05 mol
IButane C ₄ H ₁₀	Sets the mole fraction of Ibutane in the dry gas mixture.	0.0 to 0.1 mol	0 mol
N-Butane C ₄ H ₁₀	Sets the mole fraction of N-Butane in the dry gas mixture.	0.0 to 0.1 mol	0 mol
Isopentane C ₅ H ₁₂	Sets the mole fraction of Isopentane in the dry gas mixture.	0.0 to 0.1 mol	0 mol
N-Pentane C ₅ H ₁₂	Sets the mole fraction of N-Pentane in the dry gas mixture.	0.0 to 0.1 mol	0 mol

Parameter	Description	User entry	Factory setting
Neopentane C5H12	Sets the mole fraction of Neopentane in the dry gas mixture	0.0 to 0.1 mol	0 mol
Hexane+ C6H14+	Sets the mole fraction of Hexane+ in the dry gas mixture	0.0 to 0.1 mol	0 mol
Nitrogen N2	Sets the mole fraction of Nitrogen in the dry gas mixture.	0.0 to 0.55 mol	0 mol
Carbon dioxide CO2	Sets the mole fraction of Carbon dioxide in the dry gas mixture.	0.0 to 0.3 mol	0.1 mol
Hydrogen sulfide H2S	Sets the mole fraction of Hydrogen sulfide in the dry gas mixture.	0.0 to 0.05 mol	0 mol
Hydrogen H2	Sets the mole fraction of Hydrogen in the dry gas mixture.	0.0 to 0.2 mol	0 mol

7.15.4 Additional display configurations submenu

In the Display submenu you can set all the parameters associated with the configuration of the local display.

Navigation Setup menu → Advanced setup → Display

► Display	Format display	→ 
	Value 1 display	→ 
	0% bargraph value 1	→ 
	100% bargraph value 1	→ 
	Decimal places 1	→ 
	Value 2 display	→ 
	Decimal places 2	→ 
	Value 3 display	→ 
	0% bargraph value 3	→ 
	100% bargraph value 3	→ 
	Decimal places 3	→ 
	Value 4 display	→ 
	Decimal places 4	→ 
	Display language	→ 
	Display interval	→ 
	Display damping	→ 
	Header	→ 
	Header text	→ 
	Separator	→ 
	Backlight	→ 





Parameter	Prerequisite	Description	User entry	Factory setting
Format display	A local display is provided.	Select how measured values are shown on the display.	<ul style="list-style-type: none"> ■ 1 value, max. size ■ 1 bargraph + 1 value ■ 2 values ■ 1 value large + 2 values ■ 4 values 	1 value, max. size
Value 1 display	A local display is provided.	Select the measured value that is shown on the display.	<ul style="list-style-type: none"> ■ Concentration ■ Dewpoint 1 ■ Dewpoint 2 ■ Cell gas pressure ■ Cell gas temperature 	Concentration
0% bargraph value 1	A local display is provided.	Enter 0% value for bar graph display	Signed floating-point number	0 ppmv
100% bargraph value 1	A local display is provided.	Enter 100% value for bar graph display	Signed floating-point number	Depends on calibration range
Decimal places 1	A measured value is specified in the <i>Value 1 display</i> parameter.	Select the number of decimal places for the display value.	<ul style="list-style-type: none"> ■ x ■ x.x ■ x.xx ■ x.xxx ■ x.xxxx 	x.xx
Value 2 display	A local display is provided.	Select the measured value that is shown on the local display.	<ul style="list-style-type: none"> ■ None ■ Concentration ■ Dewpoint 1 ■ Dewpoint 2 ■ Cell gas pressure ■ Cell gas temperature 	Dewpoint 1
Decimal places 2	A measured value is specified in the <i>Value 2 display</i> parameter.	Select the number of decimal places for the display value.	<ul style="list-style-type: none"> ■ x ■ x.x ■ x.xx ■ x.xxx ■ x.xxxx 	x.xx
Value 3 display	A local display is provided.	Select the measured value that is shown on the local display.	For the picklist, see the Value 2 display parameter	Cell gas pressure
0% bargraph value 3	A selection was made in the <i>Value 3 display</i> parameter.	Enter 0% value for bar graph display.	Signed floating-point number	700 mbar a
100% bargraph value 3	A selection was made in the <i>Value 3 display</i> parameter.	Enter 100% value for bar graph display.	Signed floating-point number	1700 mbar a
Decimal places 3	A measured value is specified in the <i>Value 3 display</i> parameter.	Select the number of decimal places for the display value.	<ul style="list-style-type: none"> ■ x ■ x.x ■ x.xx ■ x.xxx ■ x.xxxx 	x.xx
Value 4 display	A local display is provided.	Select the measured value that is shown on the local display.	For the picklist, see the Value 2 display parameter	Cell gas temperature
Decimal places 4	A measured value is specified in the <i>Value 4 display</i> parameter.	Select the number of decimal Places for the display value.	<ul style="list-style-type: none"> ■ x ■ x.x ■ x.xx ■ x.xxx ■ x.xxxx 	x.xx

Parameter	Prerequisite	Description	User entry	Factory setting
Display language	A local display is provided.	Set display language	Picklist	English
Display interval	A local display is provided.	Set time measured values are shown on display if display alternates between values.	1 to 10 s	5 s
Display damping	A local display is provided.	Set display reaction time to fluctuations in the measured value.	0.0 to 999.9 s	0.0 s
Header	A local display is provided.	Select header contents on local display.	<ul style="list-style-type: none"> ■ Device tag ■ Free text 	Device tag
Header text	In the <i>Header</i> parameter, the Free text option is selected.	Enter display header text.	Max. 12 characters such as letters, numbers, or special characters (e.g., @, %, /)	-----
Separator	A local display is provided.	Select decimal separator for displaying numerical values.	<ul style="list-style-type: none"> ■ . (point) ■ , (comma) 	. (point)
Backlight	One of the following conditions is met: <ul style="list-style-type: none"> ■ Order code for “Display; operation”, option F “4-line, illum.; touch control” ■ Order code for “Display; operation”, option G “4-line, illum.; touch control +WLAN” ■ Order code for “Display; operation”, option O “remote 4-line display, illum; 10m/30ft cable; touch control” 	Switch the local display backlight on and off.	<ul style="list-style-type: none"> ■ Disable ■ Enable 	Enable

7.15.5 Configuration management submenu

After commissioning, you can save the current device configuration or restore the previous device configuration. You can do so using the **Configuration management** parameter and the related options found in the **Configuration backup** submenu.

Navigation Setup menu → Advanced setup → Configuration backup

▶ Configuration backup	Operating time	→ 
	Last backup	→ 
	Configuration management	→ 
	Backup state	→ 
	Comparison result	→ 

Parameter	Description	User interface/User entry	Factory setting
Operating time	Indicates how long the device has been in operation.	Days (d), hours (h), minutes (m) and seconds (s)	–
Last backup	Shows when the last data backup was saved to embedded HistoROM.	Days (d), hours (h), minutes (m) and seconds (s)	–

Parameter	Description	User interface/User entry	Factory setting
Configuration management	Select action for managing the device data in the embedded HistoROM.	<ul style="list-style-type: none"> ■ Cancel ■ Execute backup ■ Restore ■ Compare ■ Clear backup data 	Cancel
Backup state	Shows the current status of data saving or restoring.	<ul style="list-style-type: none"> ■ None ■ Backup in progress ■ Restoring in progress ■ Delete in progress ■ Compare in progress ■ Restoring failed ■ Backup failed 	None
Comparison result	Comparison of current device data with embedded HistoROM.	<ul style="list-style-type: none"> ■ Settings identical ■ Settings not identical ■ No backup available ■ Backup settings corrupt ■ Check not done ■ Dataset incompatible 	Check not done

Function scope of the Configuration management parameter

Options	Description
Cancel	No action is executed and the user exits the parameter.
Execute backup	A backup copy of the current device configuration is saved from the integrated HistoROM to the memory of the device. The backup copy includes the controller data of the device.
Restore	The last backup copy of the device configuration is restored from the device memory to the device's integrated HistoROM. The backup copy includes the controller data of the device.
Compare	The device configuration saved in the device memory is compared with the current device configuration of the integrated HistoROM.
Clear backup data	The backup copy of the device configuration is deleted from the memory of the device.

NOTICE

- ▶ **Integrated HistoROM:** A HistoROM is a non-volatile device memory in the form of an EEPROM.
- ▶ While this action is in progress, the configuration cannot be edited from the local display and a message on the processing status appears on the display.

8 Operation

8.1 Reading measured values

With the Measured values submenu, it is possible to read all the measured values.

Navigation Diagnostics menu → Measured values

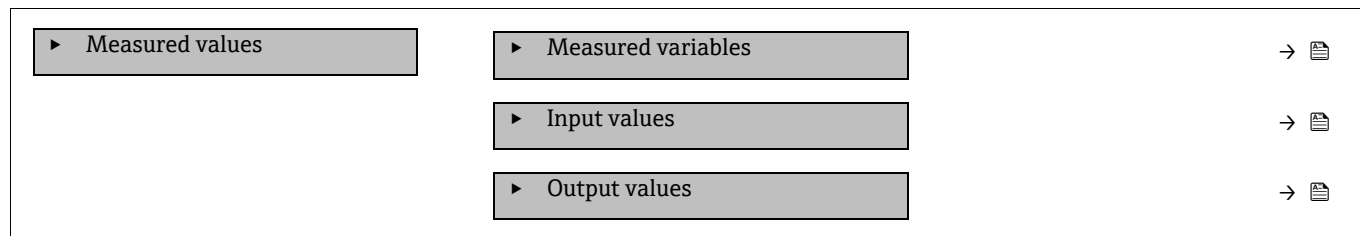

8.1.1 Measured variables submenu

The Measured variables submenu contains the calculation result parameters from the last measurement.

Navigation Diagnostics menu → Measured values → Measured variables

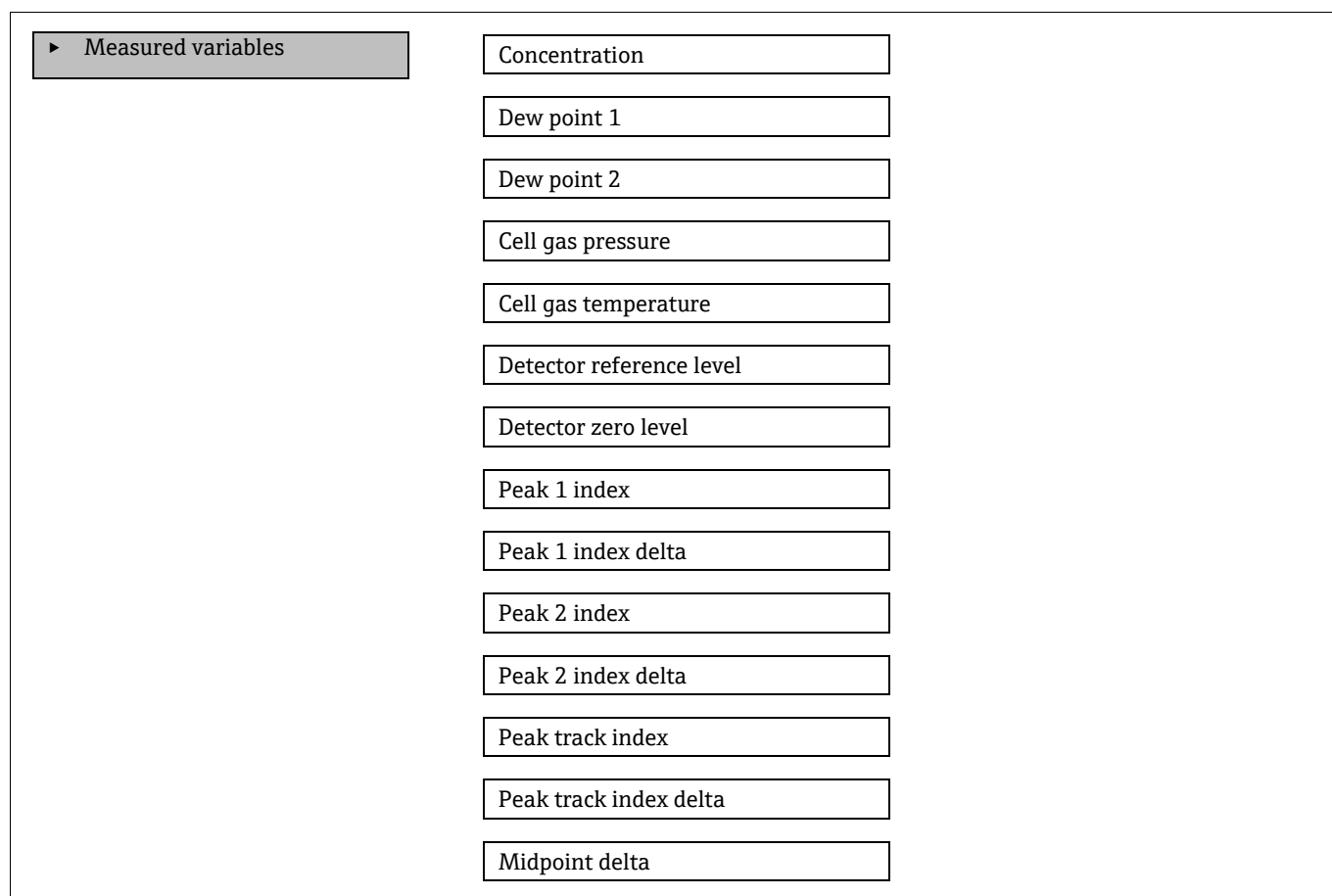

8.1.2 Input values submenu

The Input values submenu guides you systematically to the individual input values.

Navigation Diagnostics menu → Measured values → Input values

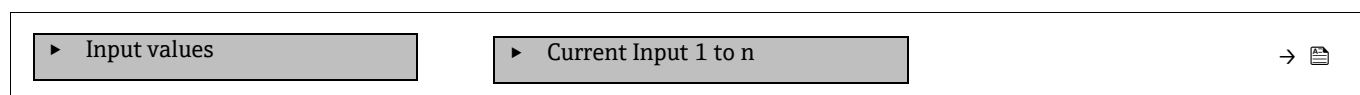

8.1.2.1 Current Input 1 to n submenu

The Current Input 1 to n submenu contains all the parameters needed to display the current measured values for every current input.

Navigation Diagnostics menu → Measured values → Input values → Current input 1 to n

▶ Current input 1 to n	Measured values 1 to n	→
	Measured current 1 to n	→

Parameter	Description	User interface
Measured values 1 to n	Displays the current input value.	Signed floating point number
Measured current 1 to n	Displays the current value of the current input.	0 to 22.5 mA

8.1.3 Output values submenu

The Output values submenu contains all the parameters needed to display the current measured values for every output.

Navigation Diagnostics menu → Measured values → Output values

▶ Output values	▶ Current output 1 to n	→
	▶ Switch output 1 to n	→
	▶ Relay output 1 to n	→

8.1.3.1 Current output 1 to n submenu

The Value current output submenu contains all the parameters needed to display the current measured values for every current output.

Navigation Diagnostics menu → Measured values → Output values → Value current output 1 to n

▶ Current output 1 to n	Output current 1	→
	Measured current 1 to n	→

Parameter	Description	User interface
Output current 1	Displays the current value currently calculated for the current output.	3.59 to 22.5 mA
Measured current	Displays the current value currently measured for the current output.	0 to 30 mA

8.1.3.2 Switch output 1 to n submenu

The switch output 1 to n submenu contains all the parameters needed to display the current measured values for every switch output.

Navigation Diagnostics menu → Measured values → Output values → Switch output 1 to n

▶ Switch output 1 to n	Switch status 1 to n	→
------------------------	----------------------	---

Parameter	Prerequisite	Description	User interface/User entry	Factory setting
Switch status 1 to n	The Switch option is selected in the Operating mode parameter.	Displays the current 'switch' output status.	Open Closed	—

8.1.3.3 Relay output 1 to n submenu

The Relay output 1 to n submenu contains all the parameters needed to display the current measured values for every relay output.

Navigation Diagnostics menu → Measured values → Output values → Relay output 1 to n

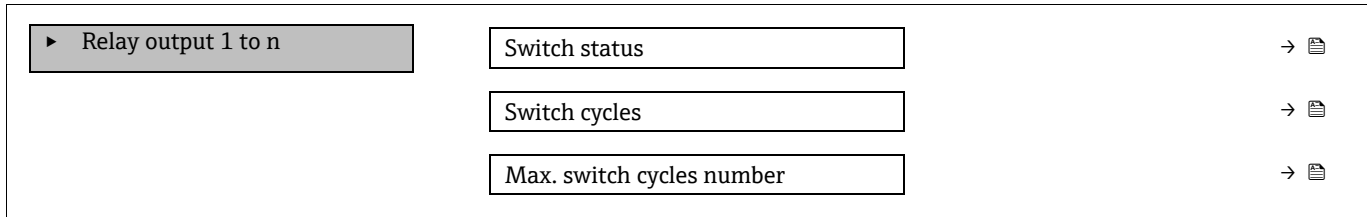

Parameter	Description	User interface
Switch status	Shows the current relay switch status.	Open Closed
Switch cycles	Shows number of all performed switch cycles.	Positive integer
Max. switch cycles number	Shows the maximal number of guaranteed switch cycles.	Positive integer

8.2 Showing data logging

The Extended HistoROM application package enables the Data logging submenu to display. This contains all the parameters for the measured value history. Data logging is also available through the *web browser* →

Function range:

- A total of 1000 measured values can be stored
- 4 logging channels
- Adjustable logging interval for data logging
- Display of the measured value trend for each logging channel in the form of a chart:

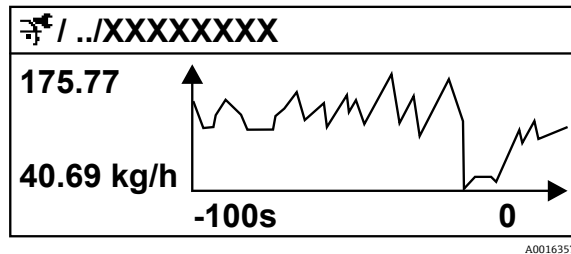











Fig 70. Chart of a measured value trend

Axis	Description
x	Depending on the number of channels selected, chart displays 250 to 1000 measured values of a process variable.
y	Chart displays the approximate measured value span and constantly adapts this to the ongoing measurement.

 If the length of the logging interval or the assignment of the process variables to the channels is changed, the content of the data logging is deleted.

Navigation Diagnostics menu → Data logging

▶ Data logging	Assign channel 1 to n	→ 
	Logging interval	→ 
	Clear logging data	→ 
	Data logging	→ 
	Logging delay	→ 
	Data logging control	→ 
	Data logging status	→ 
	Entire logging duration	→ 

Parameter	Prerequisite	Description	User interface/User entry	Factory setting
Assign channel 1 to n	The Extended HistoROM application package is available.	Assign process variable to logging channel.	<ul style="list-style-type: none"> ■ Off ■ Concentration¹ ■ Dew point 1 ■ Dew point 2 ■ Cell gas pressure ■ Cell gas temperature ■ Flow switch state ■ Current output 1 to n 	Off
Logging interval	The Extended HistoROM application package is available.	Define the logging interval for data logging. This value defines the time interval between the individual data points in the memory.	0.1 to 999.0 s	1.0 s
Clear logging data	The Extended HistoROM application package is available.	Clear the entire logging data.	<ul style="list-style-type: none"> ■ Cancel ■ Clear data 	Cancel
Data logging	—	Select the data logging method.	<ul style="list-style-type: none"> ■ Overwriting ■ Not overwriting 	Overwriting
Logging delay	In the <i>Data logging</i> parameter, the Not overwriting option is selected.	Enter the time delay for measured value logging.	0 to 999 h	0 h
Data logging control	In the <i>Data logging</i> parameter, the Not overwriting option is selected.	Start and stop measured value logging.	<ul style="list-style-type: none"> ■ None ■ Delete + start ■ Stop 	None
Data logging status	In the <i>Data logging</i> parameter, the Not overwriting option is selected.	Displays the measured value logging status.	<ul style="list-style-type: none"> ■ Done ■ Delay active ■ Active ■ Stopped 	Done

¹ Visibility depends on order options or device settings.

Parameter	Prerequisite	Description	User interface/User entry	Factory setting
Entire logging duration	In the <i>Data logging</i> parameter, the Not overwriting option is selected.	Displays the total logging duration.	Positive floating point number	0 s

8.3 Adapting the measuring device to the process conditions

The following are available for this purpose:

- Basic settings using the Setup menu
- Advanced settings using the *Advanced setup submenu* →

Navigation Setup menu

Setup	Device tag	→
	Analyte type	
	Select calibration	
	▶ System units	→
	▶ Dew points	
	▶ Peak tracking	
	▶ Communication	→
	▶ I/O configuration	→
	▶ Current output 1 to n	→
	▶ Current input 1 to n	→
	▶ Switch output	→
	▶ Relay output 1 to n	→
	▶ Display	→
	▶ Advance setup	→

8.3.1 Displaying the I/O configuration

The I/O configuration submenu guides the user systematically through all the parameters in which the configuration of the I/O modules is displayed.

Navigation Setup menu → I/O configuration

▶ I/O configuration	I/O module 1 to n terminal numbers	→
	I/O module 1 to n information	→
	I/O module 1 to n type	→

<input style="border: 1px solid black; width: 80%; height: 20px;" type="text" value="Apply I/O configuration"/> →
--

Parameter	Description	User entry	Factory setting
I/O module 1 to n terminal numbers	Shows the terminal numbers used by the I/O module.	<ul style="list-style-type: none"> ▪ Not used ▪ 26-27 (I/O 1) ▪ 24-25 (I/O 2)¹ ▪ 22-23 (I/O 3)¹ 	-
I/O module 1 to n information	Shows information of the plugged I/O module.	<ul style="list-style-type: none"> ▪ Not plugged ▪ Invalid ▪ Not configurable ▪ Configurable 	-
I/O module 1 to n type	Shows the I/O module type.	<ul style="list-style-type: none"> ▪ Off ▪ Current output² ▪ Switch output² 	-
Apply I/O configuration	Apply parameterization of the freely configurable I/O module.	<ul style="list-style-type: none"> ▪ No ▪ Yes 	No

8.3.2 Using parameters for device administration

The **Administration** submenu systematically guides the user through all the parameters that can be used for device administration purposes.

Navigation Setup menu → Advanced setup → Administration

<div style="border: 1px solid black; background-color: #cccccc; padding: 2px; margin-bottom: 5px;">▶ Administration</div>	<input style="width: 80%; height: 20px;" type="text" value="Device reset"/> →
<div style="border: 1px solid black; background-color: #cccccc; padding: 2px; margin-bottom: 5px;">▶ Define access code</div>	<input style="width: 80%; height: 20px;" type="text"/> →
<div style="border: 1px solid black; background-color: #cccccc; padding: 2px;">▶ Reset access code</div>	<input style="width: 80%; height: 20px;" type="text"/> →

8.3.2.1 Resetting the device

Navigation Setup menu → Advanced setup → Administration → Device reset

Parameter	Description	User entry	Factory setting
Device reset	Reset the device configuration, either entirely or in part, to a defined state.	<ul style="list-style-type: none"> ▪ Cancel ▪ Restart device 	Cancel

8.3.2.2 Defining the access code

Navigation Setup menu → Advanced setup → Administration → Define access code

<div style="border: 1px solid black; background-color: #cccccc; padding: 2px; margin-bottom: 5px;">▶ Define access code</div>	<input style="width: 80%; height: 20px;" type="text" value="Define access code"/> →
<div style="border: 1px solid black; background-color: #cccccc; padding: 2px;">▶ Confirm access code</div>	<input style="width: 80%; height: 20px;" type="text"/> →

¹ Based on order configuration

² Visibility depends on order options or device setting

Parameter	Description	User entry
Define access code	Restrict write-access to parameters to protect the configuration of the device against unintentional changes.	Max. 16-digit character string comprising numbers, letters and special characters
Confirm access code	Confirm the entered access code.	Max. 16-digit character string comprising numbers, letters and special characters

8.3.2.3 Resetting the access code

Navigation Setup menu → Advanced setup → Administration → Reset access code

▶ Reset access code

Operating time

→

Reset access code

→

Parameter	Description	User entry	Factory setting
Operating time	Indicates how long the device has been in operation.	Days (d), hours (h), minutes (m) and seconds (s)	–
Reset access code	Reset access code to Factory settings. For a reset code, refer to <i>Service contact</i> → . The reset code can only be entered from the web browser.	Character string comprising numbers, letters and special characters	0x00

8.4 Simulation

The *Simulation* submenu enables you to simulate, without a real flow situation, various process variables in the process and the device alarm mode and to verify downstream signal chains (switching valves or closed-control loops).

Navigation Diagnostics menu → Simulation

▶ Simulation

Current input 1 to n simulation

→

Value current input 1 to n

→

Current output 1 to n simulation

→

Current output value 1 to n

→

Switch output simulation 1 to n

→

Switch state 1 to n

→

Relay output 1 to n simulation

→

Switch state 1 to n

→

Device alarm simulation

→

Diagnostic even category

→



Diagnostic event simulation

→

Parameter	Prerequisite	Description	User interface/User entry	Factory setting
Current input 1 to n simulation	–	Switch the simulation of the current output on and off.	<ul style="list-style-type: none"> ▪ Off ▪ On 	Off
Value current input 1 to n	In the <i>Current input 1 to n simulation</i> parameter, the On option is selected.	Enter the current value for simulation.	0 to 22.5 mA	Set to the actual input current when the simulation is set to On.
Current output 1 to n simulation	–	Switch the simulation of the current output on and off.	<ul style="list-style-type: none"> ▪ Off ▪ On 	Off
Current output value 1 to n	In the <i>Current output 1 to n simulation</i> parameter, the On option is selected.	Enter the current value for simulation.	3.59 to 22.5 mA	3.59 mA
Switch output simulation 1 to n	In the <i>Operating mode</i> parameter, the Switch option is selected.	Switch the simulation of the switch output on and off.	<ul style="list-style-type: none"> ▪ Off ▪ On 	Off
Switch state 1 to n	–	Select the status of the status output for the simulation.	<ul style="list-style-type: none"> ▪ Open ▪ Closed 	Open
Relay output 1 to n simulation	–	–	<ul style="list-style-type: none"> ▪ Off ▪ On 	Off
Switch state 1 to n	In the <i>Switch output simulation 1 to n</i> parameter, the On option is selected.	–	<ul style="list-style-type: none"> ▪ Open ▪ Closed 	Open
Device alarm simulation	–	Switch the device alarm on and off.	<ul style="list-style-type: none"> ▪ Off ▪ On 	Off
Diagnostic even category	–	Select a diagnostic event category.	<ul style="list-style-type: none"> ▪ Sensor ▪ Electronics ▪ Configuration ▪ Process 	Process
Diagnostic event simulation	–	Select a diagnostic event to simulate this event.	<ul style="list-style-type: none"> ▪ Off ▪ Diagnostic event picklist (depends on the category selected) 	Off

8.5 Protecting settings from unauthorized access

The following write protection options exist in order to protect the J22 TDLAS gas analyzer software configuration from unintentional modification:

- Protect access to parameters with access code
- Protect access to local operation with keypad locking → 
- Protect access to measuring device with *write protection switch* → 

8.5.1 Write protection with an access code

By enabling user-specific access code, the parameters for the measuring device configuration are write-protected and their values can no longer be changed through local operation.

8.5.2 Defining the access code through local display

1. Navigate to the **Define access code** parameter.
2. Define a max. 16-digit character string comprising numbers, letters and special characters as the access code.

3. Enter the access code again in the *Confirm access code parameter* →  to confirm the code.

↳ The -symbol appears in front of all write-protected parameters.

The device automatically locks the write-protected parameters again if a key is not pressed for 10 minutes in the navigation and editing view. The device locks the write-protected parameters automatically after 60 s if the user returns to the operational display mode from the navigation and editing view.

If parameter write protection is activated through an access code, it can only be deactivated with the same *access code* → .

The user role with which the user is currently logged on through the local display is indicated by the **Access status** parameter. Navigation path: Operation → Access status.

8.5.2.1 Parameters that can be modified from the local display

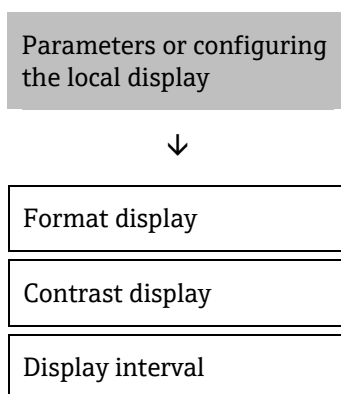

Parameters that do not affect the measurement are excepted from write protection through the local display. Despite the user-specific access code, they can be modified even when other parameters are locked. These include format display, contrast display, and display interval parameters.



8.5.3 Defining the access code through the web browser

To define the access code through the web browser

- ▶ If parameter write protection is activated through an access code, it can only be deactivated with the same *access code* → .
- ▶ The user role with which the user is currently logged on the web browser is indicated by the **Access status** parameter. Navigation path: Operation → Access status.

1. Navigate to the *Define access code parameter* → .
2. Define a 4-digit numeric code as an access code.
3. Enter the access code again in the *Confirm access code parameter* →  to confirm the code.

↳ The web browser switches to the login page.

 If no action is performed for 10 minutes, the web browser automatically returns to the login page.

8.5.4 Resetting the access code

If you misplace the user-specific access code, it is possible to reset the code to the Factory setting. A reset code must be entered for this purpose. The user-specific access code can then be redefined.

To reset the access code from the web browser (through CDI-RJ45 service interface):

To obtain a reset code, contact your *Endress+Hauser service* →  organization.

1. Navigate to the **Reset access code** parameter.
2. Enter the reset code.

↳ The access code has been reset to the factory setting 0000. It can now be redefined.

8.5.5 Using the write protection switch

The write protection switch allows write access to be locked in the entire operating menu, with exception of the Contrast display parameter. This write protection is global, unlike the parameter write protection with a user-specific access code.

Write protection switch prevents editing of parameter values through the following:

- Local display
- Modbus RS485 protocol
- Modbus TCP protocol

To enable hardware write protection:

Set the write protection (WP) switch No. 1 on the main electronics module to the **ON** position.

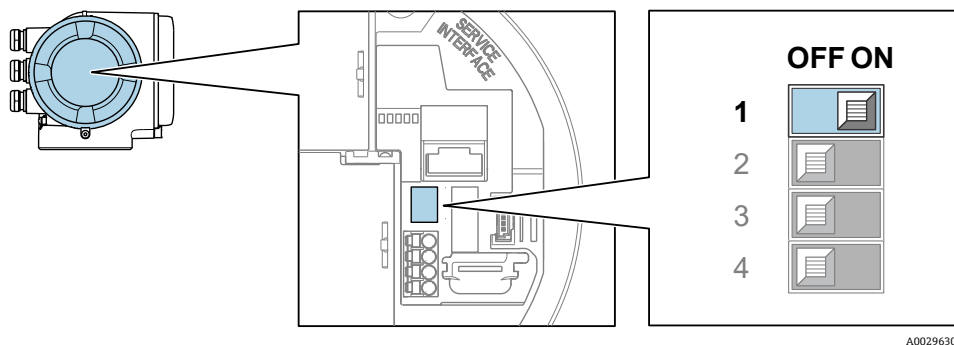

Fig 71. Off/on DIP switch for write protection



↳ In the Locking status parameter, the Hardware locked option is displayed. In addition, on the local display the -symbol appears in front of the parameters in the header and in the navigation view.



Fig 72. Hardware locked symbol in operational display

To disable hardware write protection:

Set the write protection (WP) switch on the main electronics module to the **OFF** position (factory setting).

↳ No option is displayed in the Locking status parameter. On the local display, the -symbol disappears from in front of the parameters in the header of the display and in the navigation view.

NOTICE



- ▶ DIP switch No. 2 manages customer transfer applications, which are not used in this device. Keep this switch in the OFF position.

8.5.6 Reading the device locking status

Device active write protection: Locking status parameter

Navigation Operation menu → Locking status

Function scope of the locking status parameter

Options	Description
None	The access status displayed in the <i>Access status parameter</i> →  applies. Only appears on local display.
Hardware locked	DIP switch No. 1 for <i>hardware locking</i> →  is activated on the PCB board. This action locks write access to the parameters (e.g., from the local display or operating tool).
Temporarily locked	Write access to the parameters is temporarily locked due to internal processes running in the device (e.g., data upload/download, reset, etc.). Once the internal processing has been completed, the parameters can be changed.

9 Verification, diagnostics and troubleshooting

9.1 Diagnostic information from light emitting diodes

9.1.1 Controller

Different LEDs in the controller provide information on the device status.

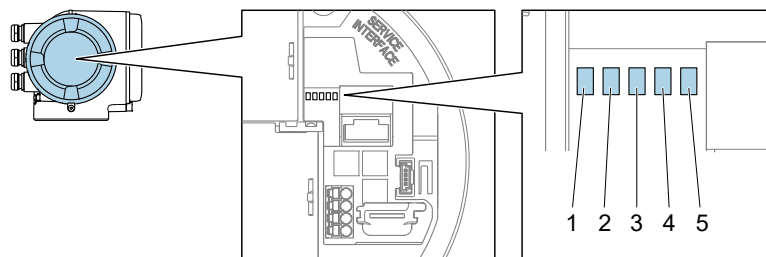

A0029629

Fig 73. LED diagnostic indicators

#	LED	Color	Meaning
1	Supply voltage	Off	Supply voltage is off or too low
		Green	Supply voltage is ok
2	Device Status	Off	Firmware error
		Green	Device status is ok
		Flashing green	Device is not configured
		Flashing red	A device event with Warning Diagnostic behavior has occurred
		Red	A device event with Alarm Diagnostic behavior has occurred
	Flashing red/green	Device restart	
3	Not used	—	—
4	Communication	White	Communication active
		Off	Communication not active
5	Service interface (CDI) active	Off	Not connected or no connection established
		Yellow	Connected and connection established
		Flashing yellow	Service interface active

9.2 Diagnostic information on local display

9.2.1 Diagnostic message

Faults detected by the self-monitoring system of the measuring device are displayed as a diagnostic message in alternation with the operational display.

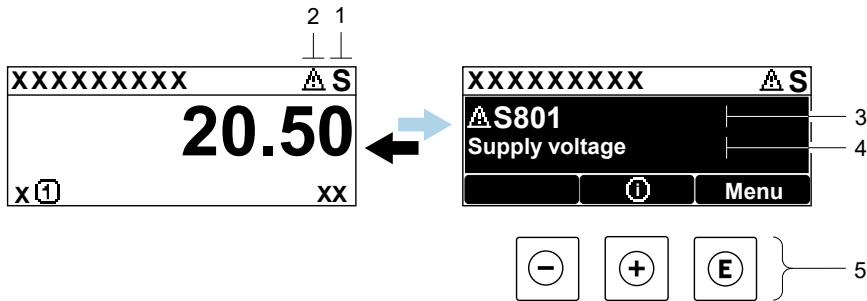

A0029426-EN

Fig 74. Diagnostic message

#	Description
1	Status signal
2	Diagnostic behavior
3	Diagnostic behavior with diagnostic code
4	Short text
5	<i>Operating elements</i> →

If two or more diagnostic events are pending simultaneously, only the message of the diagnostic event with the highest priority is shown.

Other diagnostic events that have occurred can be displayed in the *Diagnostics* menu:

- From parameters
- Through submenus →

9.2.1.1 Status signals

The Status signals provide information on the state and reliability of the device by categorizing the cause of the diagnostic information (diagnostic event). The Status signals are categorized according to *VDI/VDE 2650* and *NAMUR Recommendation NE 107*: F = Failure, C = Function Check, S = Out of Specification, M = Maintenance Required.

Symbol	Meaning
F	Failure. A device error has occurred. The measured value is no longer valid.
C	Function check. The device is in service mode (e.g., during a simulation).
S	Out of specification. The device is operated outside its technical specification limits (e.g., outside the process temperature range)
M	Maintenance required. Maintenance is required. The measured value remains valid.

9.2.1.2 Diagnostic behavior

Symbol	Meaning
	Alarm. Measurement is interrupted. Signal outputs assume the defined alarm condition. A diagnostic message is generated.

Symbol	Meaning
	Warning. Measurement is resumed. The signal outputs are not affected. A diagnostic message is generated.

9.2.1.3 Diagnostic information

The fault can be identified using the diagnostic information. The Short text helps you by providing information about the fault. In addition, the corresponding symbol for the Diagnostic behavior is displayed in front of the diagnostic information on the local display.

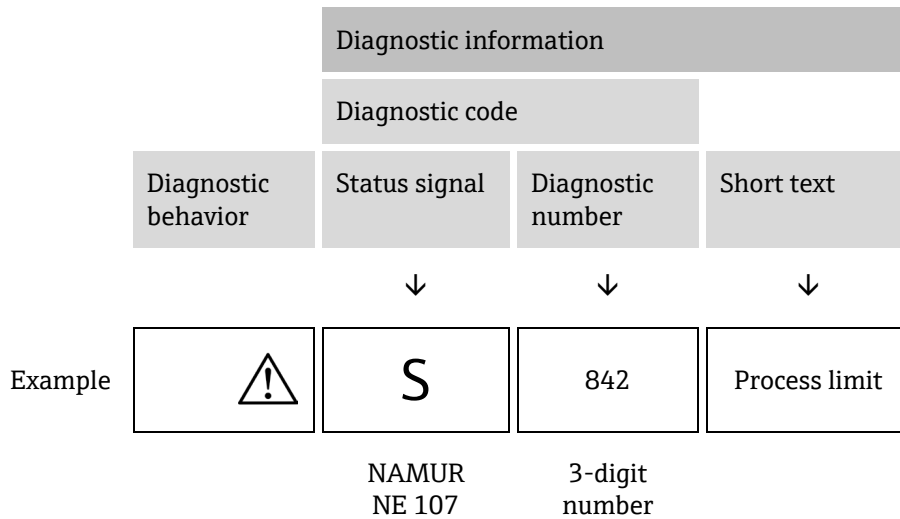

9.2.1.4 Operating elements

Symbol	Meaning
	Plus key. In a menu or submenu, opens the message about remedy information.
	Enter key. In a menu or submenu, opens the operating menu.

Calling up remedial measures

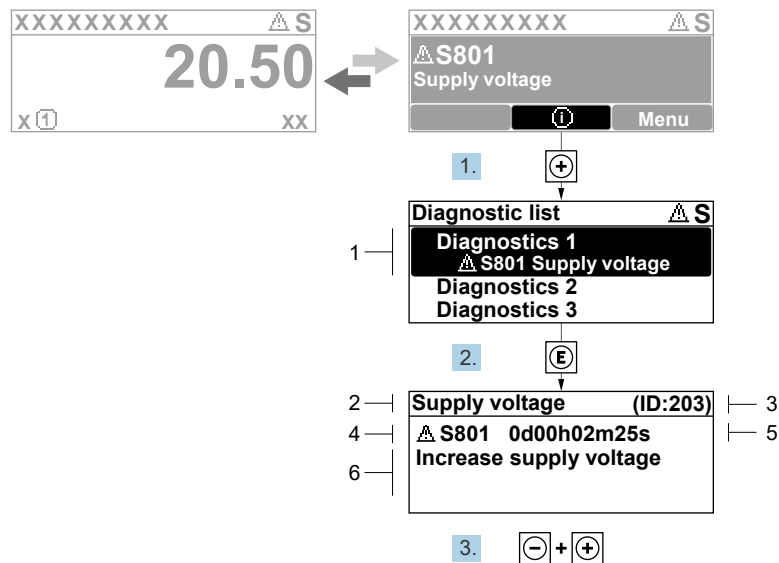

Fig 75. Message for remedial measures

A0029431-EN

#	Description
1	Diagnostic information
2	Short text
3	Service ID
4	Diagnostic behavior with diagnostic code
5	Operation time of occurrence
6	Remedial measures

The user is in the diagnostic message.

1. Press (ⓘ symbol)
 - ↳ The Diagnostic list submenu opens.
2. Select the desired diagnostic event with or and press .
 - ↳ The message for the remedial measures for the selected diagnostic event opens.
3. Press + simultaneously.
 - ↳ The message for the remedial measures closes.

The user is in the *Diagnostics* menu at an entry for a diagnostics event, e.g., in the *Diagnostic list* submenu or *Previous diagnostics* parameter.

1. Press .
 - ↳ The message for the remedial measures for the selected diagnostic event opens.
2. Press + simultaneously.
 - ↳ The message for the remedial measures closes.

9.3 Diagnostic information in the web browser

9.3.1 Diagnostic options

Any faults detected by the measuring device are displayed in the web browser on the home page once the user has logged on.

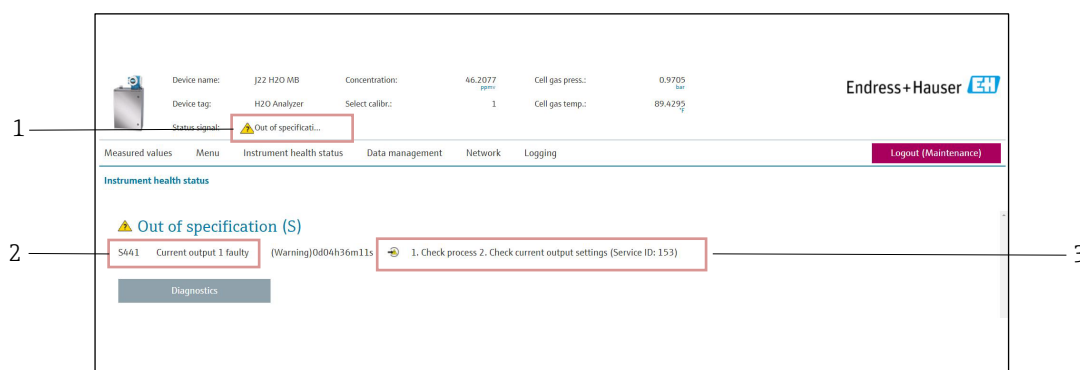

A0031056-SSI

Fig 76. Diagnostic information in the web browser





#	Name
1	Status area with status signal
2	Diagnostic information. Refer to <i>Pending diagnostic events</i> → .
3	Remedy information with Service ID

In addition, diagnostic events which have occurred can be shown in the Diagnostics menu:

- From parameters
- Through submenus → 

Status signals

The Status signals are categorized in accordance with VDI/VDE 2650 and NAMUR Recommendation NE 107.

Symbol	Meaning
	Failure. A device error has occurred. The measured value is no longer valid.
	Function check. The device is in service mode (e.g., during a simulation).
	Out of specification. The device is operated outside its technical specification limits (e.g., outside the process temperature range).
	Maintenance required. Maintenance is required. The measured value is still valid.

9.3.2 Calling up remedy information

Remedy information is provided for every diagnostic event to ensure that problems can be rectified quickly. These measures are displayed in red along with the diagnostic event and the related diagnostic information.

9.4 Diagnostic information through the communication interface

9.4.1 Reading out diagnostic information

Diagnostic information can be read out from the Modbus RS485 or Modbus TCP register addresses. See *Modbus registers* →  for more information:

- From register address 6821 (data type = string): diagnosis code, e.g., F270
- From register address 6801 (data type = integer): diagnosis number, e.g., 270

For an overview of diagnostic events with *diagnosis number and diagnosis code* → .

9.4.2 Configuring error response mode

The error response mode for Modbus RS485 or Modbus TCP communication can be configured in the *Communication submenu using 2* parameters.

Navigation Setup → Communication

Parameter	Description	User entry	Factory setting
Failure mode	Select measured value output behavior when a diagnostic message occurs through Modbus communication. This effect of this parameter depends on the option selected in the Assign Diagnostic behavior parameter.	<ul style="list-style-type: none"> ▪ NaN value ▪ Last valid value  NaN = not a number	NaN value

9.5 Adapting the diagnostic behavior

Each item of diagnostic information is assigned a specific Diagnostic behavior at the factory. The user can change this assignment for specific diagnostic information in the *Diagnostic behavior* submenu.

Navigation Expert → Setup → Diagnostic handling → Diagnostic behavior

You can assign the following options to the Diagnostic number as the diagnostic behavior:

Options	Description
Alarm	The device stops measurement. The measured value output from Modbus RS485 and Modbus TCP assume the defined alarm condition. A diagnostic message is generated. The background lighting changes to red.
Warning	The device continues to measure. The measured value output from Modbus RS485 and Modbus TCP are not affected. A diagnostic message is generated.
Logbook entry only	The device continues to measure. The diagnostic message is displayed only in the <i>Event logbook</i> submenu (<i>Event list</i> submenu) and is not displayed in alternation with the operational display.
Off	The diagnostic event is ignored, and no diagnostic message is generated or entered.

9.6 Overview of diagnostic information

The amount of diagnostic information and the number of measured variables affected increase if the measuring device has one or more application packages. In the case of some items of diagnostic information, the Diagnostic behavior can be changed. See *Adapting the diagnostic information* → .

Diagnostic number	Short text	Remedy instructions	Status signal (from factory)	Diagnostic behavior (from factory)
Diagnostic of sensor				
082	Data storage	<ol style="list-style-type: none"> 1. Check module connections. 2. Contact service. 	F	Alarm
083	Memory content	<ol style="list-style-type: none"> 1. Restart device. 2. Restore HistoROM S-DAT backup. ('Device reset' parameter) 3. Replace HistoROM S-DAT. 	F	Alarm
100	Laser off	<ol style="list-style-type: none"> 1. Restart device. 2. Replace Sensor electronics. 3. Replace sensor (OH). 	F	Alarm
101	Laser off	<ol style="list-style-type: none"> 1. Wait for laser to heat up to temperature. 2. Replace sensor (OH). 	F	Alarm
102	Laser temperature sensor faulty	<ol style="list-style-type: none"> 1. Restart device. 2. Replace Sensor electronics. 3. Replace sensor (OH). 	C	Warning
103	Laser temperature unstable	<ol style="list-style-type: none"> 1. Check ambient temperature ramp meets specification. 2. Replace sensor electronics. 3. Replace sensor (OH). 	F	Alarm
104	Laser temperature settling	Wait for laser temperature to settle.	C	Warning
105	Cell pressure connection defective	<ol style="list-style-type: none"> 1. Check connection to pressure cell. 2. Replace pressure cell. 	F	Alarm
106	Sensor (Optical Head) faulty	<ol style="list-style-type: none"> 1. Restart device. 2. Replace sensor (OH). 	F	Alarm

Diagnostic number	Short text	Remedy instructions	Status signal (from factory)	Diagnostic behavior (from factory)
107	Detector zero range exceeded	1. Check process. 2. Check spectrum.	M, C	Warning
108	Detector reference level range exceeded	1. Check process. 2. Check spectrum.	M, C	Warning
109	Peak index @1 out of range	1. Check process. 2. Check spectrum. 3. Reset peak tracking.	F	Alarm
110	Peak track adjustment exceeded	1. Check process. 2. Check spectrum. 3. Reset peak tracking.	F	Alarm
111	Peak track adjustment warning	1. Check process. 2. Check spectrum. 3. Reset peak tracking.	F	Alarm
Diagnostic of electronics				
201	Device failure	1. Restart device. 2. Contact service.	F	Alarm
242	Software incompatible	1. Check software. 2. Flash or change main electronics module.	F	Alarm
252	Modules incompatible	1. Check electronic modules. 2. Change electronic modules.	F	Alarm
262	Sensor electronic connection faulty	1. Check or replace connection cable between sensor electronic module (ISEM) and main electronics. 2. Check or replace ISEM or main electronics.	F	Alarm
270	Main electronic failure	Change main electronic module.	F	Alarm
271	Main electronic failure	1. Restart device. 2. Change main electronic module.	F	Alarm
272	Main electronic failure	1. Restart device. 2. Contact service.	F	Alarm
273	Main electronic failure	Change electronic.	F	Alarm
275	I/O module 1 to n defective	Change I/O module.	F	Alarm
276	I/O module 1 to n faulty	1. Restart device. 2. Change I/O module.	F	Alarm
283	Memory content	1. Reset device. 2. Contact service.	F	Alarm
300	Sensor electronics (ISEM) faulty	1. Restart device. 2. Replace sensor electronics.	F	Alarm
301	SD memory card error	1. Check SD card. 2. Restart device.	C	Warning
302	Device verification in progress	Device verification active, please wait.	C	Warning
303	I/O @1 configuration changed	1. Apply I/O module configuration (parameter 'Apply I/O configuration'). 2. Afterwards reload device description and check wiring.	M	Warning



Diagnostic number	Short text	Remedy instructions	Status signal (from factory)	Diagnostic behavior (from factory)
311	Electronic failure	1. Do not reset device. 2. Contact service.	M	Warning
330	Flash file invalid	1. Update firmware of device. 2. Restart device.	M	Warning
331	Firmware update failed	1. Update firmware of device. 2. Restart device.	F	Warning
332	Writing in HistoROM backup failed	Replace User interface board Ex d/XP: replace controller	F	Alarm
361	I/O module 1 to n faulty	1. Restart device. 2. Check electronic modules. 3. Change I/O Module or main electronics.	F	Alarm
372	Sensor electronics (ISEM) faulty	1. Restart device. 2. Check if failure recurs. 3. Replace ISEM.	F	Alarm
373	Sensor electronic (ISEM) faulty	1. Transfer data or reset device. 2. Contact service.	F	Alarm
375	I/O - 1 to n communication failed	1. Restart device. 2. Check if failure recurs. 3. Replace module rack inclusive electronic modules.	F	Alarm
382	Data storage	1. Insert T-DAT. 2. Replace T-DAT.	F	Alarm
383	Memory content	1. Restart device. 2. Delete T-DAT from the 'Reset device' parameter. 3. Replace T-DAT.	F	Alarm
387	HistoROM data faulty	Contact service organization.	F	Alarm
Diagnostic of configuration/service				
410	Data transfer	1. Check connection. 2. Retry data transfer.	F	Alarm
412	Processing download	Download active, please wait.	C	Warning
431	Trim 1 to n	Carry out trim.	C	Warning
437	Configuration incompatible	1. Restart device. 2. Contact service.	F	Alarm
438	Dataset	1. Check data set file. 2. Check device configuration. 3. Upload and download new configuration.	M	Warning
441	Current output 1 to n	1. Check process. 2. Check current output settings.	S	Warning
444	Current input 1 to n	1. Check process. 2. Check current input settings.	S	Warning
484	Failure mode simulation	Deactivate simulation.	C	Alarm
485	Measured variable simulation	Deactivate simulation	C	Warning
486	Current input 1 to n simulation	Deactivate simulation.	C	Warning



Diagnostic number	Short text	Remedy instructions	Status signal (from factory)	Diagnostic behavior (from factory)
491	Current output 1 to n simulation	Deactivate simulation.	C	Warning
494	Switch output simulation 1 to n	Deactivate simulation switch output.	C	Warning
495	Diagnostic event simulation	Deactivate simulation.	C	Warning
500	Laser current out of range	1. Check spectrum. 2. Reset peak tracking.	M, C	Warning
501	Stream Change Comp. (SCC) config. faulty	1. Check gas composition settings. 2. Check gas composition sum.	C	Warning
520	I/O 1 to n hardware configuration invalid	1. Check I/O hardware configuration. 2. Replace wrong I/O module. 3. Plug the module of double pulse output on correct slot.	F	Alarm
594	Relay output simulation	Deactivate simulation switch output.	C	Warning
Diagnostic of process/environment				
803	Current loop @1	1. Check wiring. 2. Change I/O module.	F	Alarm
832	Electronics temperature too high	Reduce ambient temperature.	S	Warning
833	Electronics temperature too low	Increase ambient temperature.	S	Warning
900	Cell pressure range exceeded	1. Check process pressure. 2. Adapt process pressure.	S	Warning
901	Cell temperature range exceeded	1. Check ambient temperature. 2. Check process temperature.	S	Warning
902	Spectrum clipped	1. Check process. 2. Check spectrum.	C	Warning
903	Validation active	1. Switch stream from validation to process. 2. Disable validation. 3. Restart device.	C	Warning
904	Cell gas flow not detected	1. Cell gas flow not detected. 2. Check process gas flow rate. 3. Adjust flow switch.	S	Warning
905	Validation failed	1. Check validation settings 2. Check validation gas 3. Reset diagnostic event	S	Warning

9.7 Pending diagnostic events

The *Diagnostics* menu allows the user to view the current diagnostic event and the previous diagnostic event separately.

To call up the measures for resolving a diagnostic event:

- Through the local display → 
- In the web browser → 

 Other pending diagnostic events can be displayed in the *Diagnostic list submenu* → .

Navigation Diagnostics menu

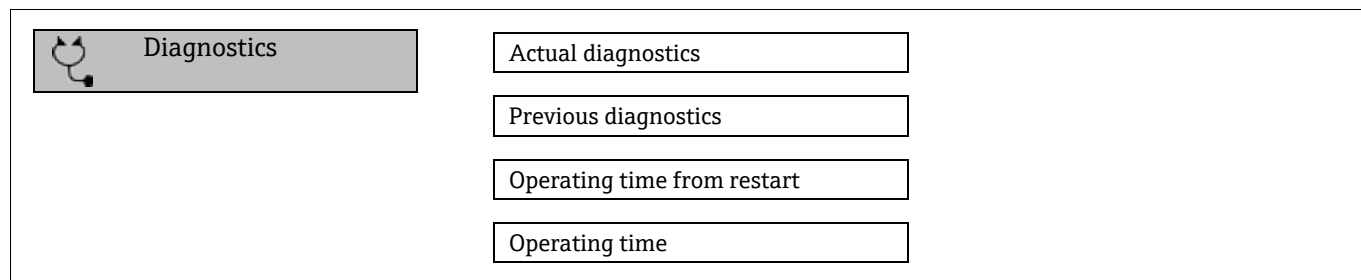

Parameter	Description	User entry	Factory setting
Actual diagnostics	A diagnostic event has occurred.	Shows the current occur-ed diagnostic event along with its diagnostic information. If two or more messages occur simultaneously, the message with the highest priority is shown on the display.	Symbol for diagnostic behavior, diagnostic code and short message.
Previous diagnostics	Two diagnostic events have already occurred.	Shows the diagnostic event that occurred prior to the current diagnostic event along with its diagnostic information.	Symbol for diagnostic behavior, diagnostic code and short message.
Operating time from restart	–	Shows the time the device has been in operation since the last device restart.	Days (d), hours (h), minutes (m) and seconds (s)
Operating time	–	Indicates how long the device has been in operation.	Days (d), hours (h), minutes (m) and seconds (s)

9.7.1 Diagnostic list

Up to 5 currently pending diagnostic events can be displayed in the *Diagnostic list* submenu along with the associated diagnostic information. If more than 5 diagnostic events are pending, the events with the highest priority are shown on the display.

Navigation Diagnostics → Diagnostic list

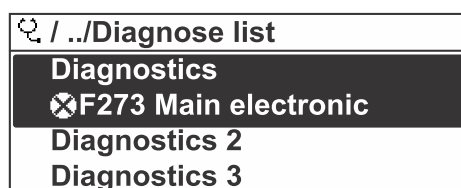

A0014006-EN

Fig 77. Diagnostics list local display example

To call up the measures for resolving a diagnostic event:

- Through the local display → 

- In the web browser →

9.8 Event logbook

9.8.1 Event history

A chronological overview of the event messages that have occurred is provided in the *Events list* submenu.

Navigation Diagnostics → Event logbook submenu → Event list

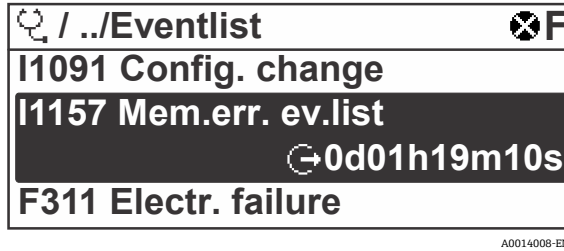

Fig 78. Event list local display example

With the Extended HistoROM application package, the event list contains up to 100 entries displayed in chronological order. The event history includes entries for:

- Diagnostic events →
- Information events →

In addition to the time of its occurrence, each event is also assigned a symbol that indicates whether the event has occurred or is ended:

- Diagnostic event
 - ☺: Occurrence of the event
 - ☹: End of the event
- Information event
 - ☺: Occurrence of the event

To call up the measures for resolving a diagnostic event:

- Through the local display →
- In the web browser →

9.8.2 Filtering the event logbook

Using the Filter options parameter, you can define which category of event message is displayed in the Events list submenu.

Navigation Diagnostics → Event logbook → Filter options

Filter categories

- All
- Failure (F)
- Function check (C)
- Out of specification (S)
- Maintenance required (M)
- Information (I)

9.8.3 Overview of information events

Unlike a diagnostic event, an information event is displayed in the event logbook only and not in the diagnostic list.

Options	Description	Options	Description
I1000	----- (Device ok)	I1513	Download finished
I1079	Sensor changed	I1514	Upload started
I1089	Power on	I1515	Upload finished

Options	Description	Options	Description
I1090	Configuration reset	I1618	I/O module replaced
I1091	Configuration changed	I1619	I/O module replaced
I1092	HistoROM backup deleted	I1621	I/O module replaced
I1137	Electronic changed	I1622	Calibration changed
I1151	History reset	I1625	Write protection activated
I1156	Memory error trend	I1626	Write protection deactivated
I1157	Memory error event list	I1627	Web server login successful
I1256	Display: access status changed	I1629	CDI login successful
I1278	I/O module restarted	I1631	Web server access changed
I1335	Firmware changed	I1632	Display login failed
I1361	Web server login failed	I1633	CDI login failed
I1397	Fieldbus: access status changed	I1634	Reset to Factory settings
I1398	CDI: access status changed	I1635	Reset to delivery settings
I1440	Main electronic module changed	I1639	Max. switch cycles number reached
I1442	I/O module changed	I1649	Hardware write protection activated
I1444	Device verification passed	I1650	Hardware write protection deactivated
I1445	Device verification failed	I1712	New flash file received
I1459	I/O module verification failed	I1725	Sensor electronic module (ISEM) changed
I1461	Sensor verification failed	I1726	Configuration backup failed
I1462	Sensor electronic module verific.	I11201	SD card removed
I1512	Download started		

9.9 Resetting the measuring device

Using the Device reset parameter it is possible to reset the entire device configuration or some of the configuration to a defined state.

9.9.1 Function scope of the Device reset parameter

Options	Description
Cancel	No action is executed and the user exits the parameter.
Restart device	The restart resets every parameter whose data are in the volatile memory (RAM) to the Factory setting (e.g., measured value data). The device configuration remains unchanged.

9.10 Device information

The Device information submenu contains all parameters that display different information for device identification.

Navigation Diagnostics menu → Device information

 Device information	Device tag
	Serial number
	Firmware version
	Device name
	Order code
	Extended order code 1
	Extended order code 2
	ENP version

Parameter	Description	User entry	Factory setting
Device tag	Shows name of measuring point.	Max. 32 characters, such as letters, numbers or special characters (e.g., @, %, /).	J22 H ₂ O MB
Serial number	Shows the serial number of the measuring device.	A maximum of 11-digit character string comprising letters and numbers.	–
Firmware version	Shows the device firmware version installed.	Character string in the format: xx.yy.zz	–
Device name	Shows the name of the controller. The name can also be found on the analyzer nameplate.	J22 H ₂ O	–
Order code	Shows the device order code. The order code can be found on the analyzer nameplate in the “Order code” field.	Character string composed of letters, numbers and certain punctuation marks (e.g., /).	–
Extended order code 1	Shows the 1st part of the extended order code. The order code can also be found on the analyzer nameplate in the in the “Ext. ord. cd.” field.	Character string	–
Extended order code 2	Shows the 2nd part of the extended order code. The order code can also be found on the analyzer nameplate in the in the “Ext. ord. cd.” field.	Character string	–
ENP version	Shows the version of the electronic nameplate (ENP).	Character string	2.02.00

9.11 Signal alarms

Depending on the interface, failure information is displayed as follows:

9.11.1 Modbus RS485 and Modbus TCP

Failure Mode	Choose from: <ul style="list-style-type: none"> ■ NaN value instead of current value ■ Last valid value
--------------	---

9.11.2 Current output 0/4 to 20mA

4 to 20 mA

Failure Mode	Choose from: <ul style="list-style-type: none"> ■ 4 to 20 mA in accordance with NAMUR recommendation NE 43 ■ 4 to 20 mA in accordance with US ■ Min value: 3.59 mA ■ Max. value: 22.5 mA ■ Freely definable value between: 3.59 to 22.5 mA ■ Actual value ■ Last valid value
--------------	---

0 to 20 mA

Failure Mode	Choose from: <ul style="list-style-type: none"> ■ Maximum alarm: 22 mA ■ Freely definable value between: 0 to 20.5 mA
--------------	---

9.11.3 Relay output

Failure Mode	Choose from: <ul style="list-style-type: none"> ■ Current status ■ Open ■ Closed
--------------	---

9.11.4 Local display

Plain text display	With information on cause and remedial measures
Backlight	Red backlighting indicates a device error



Status signal as per NAMUR recommendation NE 107.

9.11.5 Interface/protocol

- Through digital communication: Modbus RS485 and Modbus TCP
- Through service interface

Plain text display	With information on cause and remedial measures
--------------------	---

9.11.6 Web server

Plain text display	With information on cause and remedial measures
--------------------	---

9.11.7 Light emitting diodes (LED)

Status information	<p>Status indicated by various light emitting diodes. The following information is displayed depending on the device version:</p> <ul style="list-style-type: none"> ▪ Supply voltage active ▪ Data transmission active ▪ Device alarm/error has occurred ▪  Diagnostic information from light emitting diodes.
--------------------	--

9.12 Protocol-specific data









Protocol	Modbus Applications Protocol Specification V1.1
Response times	<ul style="list-style-type: none"> ▪ Direct data access: typically 25 to 50 ms ▪ Auto-scan buffer (data range): typically 3 to 5 ms
Device type	Server
Server address range ¹	1 to 247
Broadcast address range ¹	0
Function codes	<ul style="list-style-type: none"> ▪ 03: Read holding register ▪ 04: Read input register ▪ 06: Write single registers ▪ 08: Diagnostics ▪ 16: Write multiple registers ▪ 23: Read/write multiple registers
Broadcast messages	<p>Supported by the following function codes:</p> <ul style="list-style-type: none"> ▪ 06: Write single registers ▪ 16: Write multiple registers ▪ 23: Read/write multiple registers
Supported baudrate ¹	<ul style="list-style-type: none"> ▪ 1 200 BAUD ▪ 2 400 BAUD ▪ 4 800 BAUD ▪ 9 600 BAUD ▪ 19 200 BAUD ▪ 38 400 BAUD ▪ 57 600 BAUD ▪ 115 200 BAUD
Priority pool IP address	IP address

¹ Modbus RS485 only

Inactivity timeout	0 to 99 seconds
Max connections	1 to 4
Data transfer mode	<ul style="list-style-type: none"> ■ ASCII ¹ ■ RTU ¹ ■ TCP ¹
Data access	Each device parameter can be accessed through Modbus RS485 and Modbus TCP.

9.13 General troubleshooting

For local display

Error	Possible Causes	Solution
Local display dark and no output signals	Supply voltage does not match the value indicated on the nameplate.	Apply the correct <i>supply voltage</i> →  .
	The polarity of the supply voltage is wrong.	Correct the polarity.
	No contact between connecting cables and terminals.	Check the cable connection and correct if necessary.
	Terminals are not plugged into the I/O electronics module correctly. Terminals are not plugged into the main electronics module correctly.	Check terminals.
	I/O electronics module is defective. Main electronics module is defective.	Order <i>spare part</i> →  .
Local display is dark, but signal output is within the valid range	Display is set too bright or too dark.	<ul style="list-style-type: none"> ■ Set the display brighter by simultaneously pressing  + . ■ Set the display darker by simultaneously pressing  + .
	The display module cable is not plugged in correctly.	Insert the plug correctly into the main electronics module and display module.
	Display module is defective.	Order <i>spare part</i> →  .
Backlighting of local display is red	Diagnostic event with Alarm Diagnostic behavior has occurred.	Take remedial measures.
Message on local display: “Communication Error” “Check Electronics”	Communication between the display module and the electronics is interrupted.	Check the cable and the connector between the main electronics module and display module. Order <i>replacement part</i> →  .







For output signals

Error	Possible Causes	Solution
Signal output outside the valid range	Main electronics module is defective.	Order <i>spare part</i> →  125.
Device shows correct value on local display, but signal output is incorrect, though in the valid range.	Configuration error	Check and correct the parameter configuration.

¹ Modbus TCP only

Error	Possible Causes	Solution
Device measures incorrectly.	Configuration error or device is operated outside the application.	<ol style="list-style-type: none"> 1. Check and correct parameter configuration. 2. Observe limit values specified in the Technical Data.

For access

Error	Possible Causes	Solution
No write access to parameters	Hardware write protection enabled	Set the write protection switch on main electronics module to the <i>Off position</i> → 
	Current user role has limited access authorization	<ol style="list-style-type: none"> 1. Check <i>user role</i> →  2. Enter correct customer-specific <i>access code</i> → 
No connection from Modbus RS485	Modbus RS485 cable incorrectly terminated	Check <i>terminating resistor</i> → 
	Incorrect settings for the communication interface	Check the <i>Modbus RS485 configuration</i> → 
No connection from Modbus TCP	Modbus TCP cable incorrectly terminated	Check <i>terminating resistor</i> → 
	Incorrect settings for the communication interface	Check the <i>Modbus TCP configuration</i> → 
Not connecting to web server	Web server disabled	–
	Incorrect setting for the Ethernet interface of the computer	Check the network settings with the IT manager.
Not connecting to web server ¹	Incorrect IP IP address is not known	<ol style="list-style-type: none"> 1. If addressing through hardware: open the controller and check the IP address configured (last octet). 2. Check the IP address of the J22 with the network manager. 3. If the IP address is unknown, set DIP switch no. 01 to ON, restart the device and enter the factory IP address 192.168.1.212.
	Web browser setting Use a Proxy Server for Your LAN is enabled	<p>Disable the use of the proxy server in the web browser settings of the computer. Using the example of Internet Explorer:</p> <ol style="list-style-type: none"> 1. Under Control Panel, open Internet options. 2. Select the Connections tab and then double-click LAN settings. 3. In the LAN settings, disable the use of the proxy server and select OK to confirm.
	Apart from the active network connection to the device, other network connections are also being used	<ul style="list-style-type: none"> ▪ Confirm no other network connections are established by the computer (also no WLAN) and close other programs with network access to the computer. ▪ If using a docking station, make sure that a network connection to another network is not active.
Web browser frozen and operation no longer possible	Data transfer active	Wait until data transfer or current action is finished.
	Connection lost	<ol style="list-style-type: none"> 1. Check cable connection and power supply.

¹ For Modbus TCP

Error	Possible Causes	Solution
		2. Refresh the web browser and restart if necessary.
Content of web browser incomplete or difficult to read	Not using optimum version of web server.	1. Use the correct web browser version. 2. Clear the web browser cache and restart the web browser.
	Unsuitable view settings.	Change the font size/display ratio of the web browser.
Incomplete or no display of contents in the web browser	<ul style="list-style-type: none">■ JavaScript not enabled■ JavaScript cannot be enabled	1. Enable JavaScript. 2. Enter <code>http://XXX.XXX.X.XXX/basic.html</code> as the IP address.

10 Maintenance/service

Technicians are expected to be educated in the handling of hazardous sample gas and shall follow all safety protocols established by the customer that are necessary for servicing the analyzer. This may include, but is not limited to, lockout/tagout procedures, toxic gas monitoring protocols, personal protective equipment (PPE) requirements, hot work permits and other precautions that address safety concerns related to performing service on process equipment located in hazardous areas.

Personnel shall use protective gear (e.g., gloves, masks, etc.) while exposed to gases or vapor streams.

10.1 Cleaning and decontamination

To keep the sampling lines clean

1. Make sure that a membrane separator filter (included with most systems) is installed ahead of the analyzer and operating normally. Replace the membrane if necessary. If liquid enters the cell and accumulates on the internal optics, a **DC spectrum power range exceeded** fault will result.
2. Turn off the sample valve at the tap in accordance with site lockout, tagout rules.
3. Disconnect the gas sampling line from the sample supply port of the analyzer.
4. Wash the sampling line with isopropyl alcohol or acetone and blow dry with mild pressure from a dry air or nitrogen source.
5. Once the sampling line is completely free of solvent, reconnect the gas sampling line to the sample supply port of the analyzer.
6. Check all connections for gas leaks. Using a liquid leak detector is recommended.

To clean the J22 TDLAS gas analyzer exterior

The housing should be cleaned only with a moist cloth to avoid electrostatic discharge.

WARNING

- ▶ Never use vinyl acetate, acetone or other organic solvents to clean the analyzer housing or labels.

10.2 Spare parts

All parts required for operation of the J22 TDLAS gas analyzer must be supplied by *Endress+Hauser* or an *authorized agent* → .

10.3 Troubleshooting/repairs

Any repairs carried out by the customer or on behalf of the customer must be recorded in a site dossier and kept available for inspectors.

10.3.1 Replacing the membrane separator filter

Make sure that a membrane separator filter is operating normally. If liquid enters the cell and accumulates on the internal optics, a **DC spectrum power range exceeded** fault will result.

1. Close the sample supply valve.
2. Unscrew the cap from the membrane separator.

If the membrane filter is dry:

3. Check if there are any contaminants or discoloring of the white membrane. If yes, the filter should be replaced.
4. Remove the O-ring and replace the membrane filter.
5. Replace the O-ring on top of the membrane filter.
6. Place the cap back onto the membrane separator and tighten.
7. Check upstream of the membrane for liquid contamination. Clean and dry out before re-opening the sample supply valve.

If liquid or contaminants are detected on the filter:

8. Drain any liquids and clean with isopropyl alcohol.

9. Clean any liquids or contaminants from the base of the membrane separator.
10. Replace the filter and the O-ring.
11. Place the cap onto the membrane separator and tighten.
12. Check upstream of the membrane for liquid contamination. Clean and dry out before re-opening the sample supply valve.

10.3.2 Replacing the 7 micron filter

Tools and hardware

- 1" open-ended wrench
- 1" crow's foot wrench
- Torque wrench (capable of 73.4 Nm [650-in lb])

WARNING

- ▶ Residual hazardous media may be left in the filter.
1. Close the sample supply valve.
 2. Conduct a sample system purge →  if suspected hazardous elements are present.
 3. Stabilize the body with a wrench and loosen the bonnet.

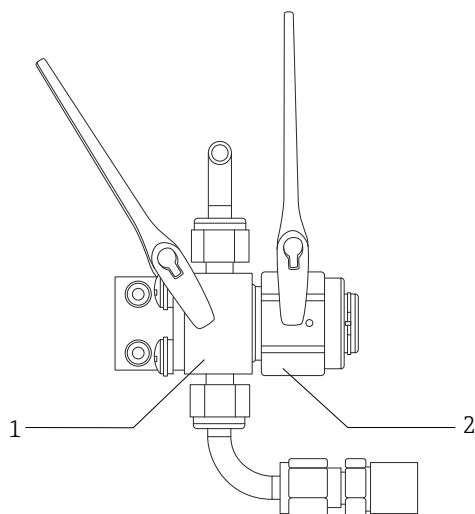

A0054810

Fig 79. Loosen filter parts

#	Description
1	Filter body
2	Filter bonnet

4. Remove the bonnet, gasket and filter element as shown in the figure below.
 - ▶ If replacing the gasket, discard the old gasket.
 - ▶ If replacing the filter element, discard the old filter.

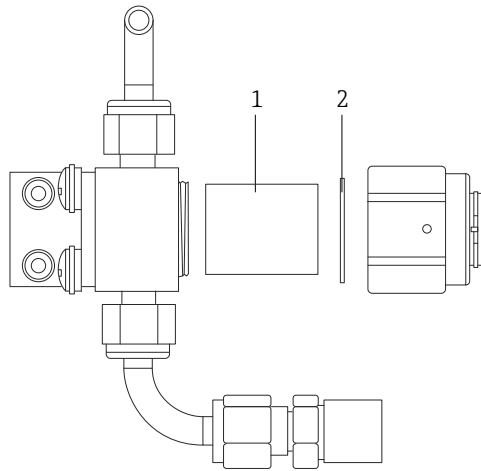

A0054825

Fig 80. Remove filter and gasket

#	Description
1	Filter element
2	Gasket

5. If replacing the old filter element, clean the filter with isopropyl alcohol.
6. Press the open end of the filter element into the body.
7. Center the gasket on the bonnet seal surface.

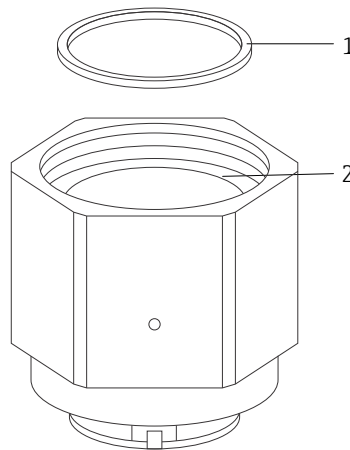

A0054826

Fig 81. Centering gasket on bonnet seal surface

#	Description
1	Gasket
2	Bonnet seal surface

8. Thread the bonnet onto the body until the body threads are no longer visible.





If the bonnet does not fully thread onto the body, the gasket is not centered on the bonnet seal surface.

9. Stabilize the body with a wrench and tighten the bonnet to 62.2 Nm (550 lbf-in). Test for proper operation.

10.3.3 Cleaning the cell assembly mirror

If contamination makes its way into the cell and accumulates on the internal optics, a **DC spectrum power range exceeded** fault results. If mirror contamination is suspected, contact Service before attempting to clean the mirrors. If advised to do so, use the following procedure. Carefully review the notices and warnings below.

NOTICE

- ▶ Do NOT clean the top mirror. If the top mirror is visibly contaminated or scratched in the clean area (see mirror figure below), refer to *Service* → .
- ▶ Cell assembly mirror cleaning should only be performed when there is a small amount of contamination. Otherwise, refer to *Service* → .
- ▶ Careful marking of the mirror orientation is critical to restoring system performance upon reassembly after cleaning.
- ▶ Always handle the optical assembly by the edge of the mount. Never touch coated surfaces of the mirror.
- ▶ Pressurized gas duster products are not recommended for cleaning components. The propellant may deposit liquid droplets onto the optic surface.
- ▶ Never rub an optical surface, especially with dry tissues, as this can mar or scratch the coated surface.
- ▶ This procedure should be used ONLY when necessary and is not part of routine maintenance.

⚠ WARNING

INVISIBLE LASER RADIATION: The sample cell assembly contains a low-power, 35 mW maximum, CW Class 3B invisible laser with a wavelength between 750 to 3000 nm.

- ▶ Never open the sample cell flanges or the optical assembly unless the power is turned off.

⚠ WARNING

Process samples may contain hazardous material in potentially flammable and toxic concentrations.

- ▶ Personnel should have a thorough knowledge and understanding of the physical properties and safety precautions for the sample contents before operating the SCS.
- ▶ All valves, regulators, and switches should be operated in accordance with site lockout/tagout procedures.

The procedure for cleaning the cell assembly mirror is broken into 3 parts:

- Purging the SCS and removing the mirror assembly
- Cleaning the cell assembly mirror
- Replacing the mirror assembly and components

For analyzers without an Endress-provided sample conditioning system (SCS), refer to instructions provided with your sampling system and follow only the procedure for cleaning the cell assembly mirror.

Tools and materials

- Lens cleaning cloth (Cole-Parmer® EW-33677-00 Texwipe TX1009 Low-Particulate Wipes or equivalent)
- Reagent-grade isopropyl alcohol (Cole-Parmer® EW-88361-80 or equivalent)
- Small drop dispenser bottle (Nalgene® FEP drop-dispenser bottle or equivalent)
- Acetone-impenetrable gloves (Honeywell North CE412W Chemsoft Nitrile gloves or equivalent)
- Hemostat (Fisherbrand™ 13-812-24 Rochester-Pean Serrated Forceps or equivalent)
- Bulb blower or dry compressed air/nitrogen
- Torque wrench
- 3 mm hex driver
- Non-out-gassing grease
- Flashlight

To purge the SCS and remove the mirror assembly

1. Power down the analyzer.
2. Isolate the SCS from the process sample tap.
3. If possible, purge the system with nitrogen for 10 minutes.
4. On the underside of the SCS enclosure, remove the plate covering the measurement cell located inside the enclosure and set aside. Retain screws.

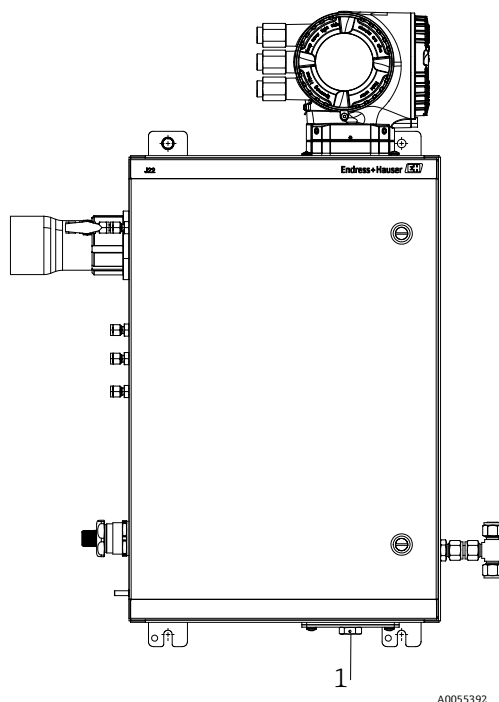

Fig 82. Measurement cell plate location (1)

5. Gently remove the mirror assembly from the cell by removing the 4 socket head cap screws and set the mirror assembly on a clean, stable, flat surface.

To clean the cell assembly mirror

1. Examine the top window inside the sample cell. Ensure that there is no contamination on the top window.
2. Using a bulb blower or dry compressed air/nitrogen, remove dust and other large particles of debris.
3. Put on clean acetone-impenetrable gloves.
4. Double fold a clean sheet of lens cleaning cloth. Using hemostats or your fingers, clamp near and along the fold to form a "brush."
5. Place a few drops of isopropyl alcohol onto the mirror and rotate the mirror to spread the liquid evenly across the mirror surface.
6. With gentle, uniform pressure, wipe the mirror from one edge to the other with the cleaning cloth only once and only in one direction to remove the contamination. Discard the cloth.
7. Repeat with a clean sheet of lens cleaning cloth to remove the streak left by the first wipe.
8. Repeat step 6, if necessary, until there is no visible contamination in the required clean area of the mirror. In the figure below, the shaded ring shows the area of the mirror that must be clean and free of scratches.
If the mirror is not clean and free of scratches in the required area, replace the mirror assembly.

To replace the mirror assembly and components

1. Replace the O-ring and ensure it is properly seated.
2. Add a very thin layer of non-outgassing grease to the O-ring.
3. Carefully replace the mirror assembly onto the cell (it is not necessary to maintain the original orientation).
4. Tighten the socket head cap screws evenly with a torque wrench to 3.5 Nm (30 lbf-in).
5. Replace the plate on the outside of the SCS enclosure.

10.3.4 Enclosure purge

i The optional enclosure purge is performed when the sample gas contains high concentrations of H₂S.

When maintenance of the J22 TDLAS gas analyzer is required, follow one of the two methods described below prior to opening the enclosure door.

Purging the enclosure with a gas sensor



WARNING

- ▶ Ensure an appropriate sensor is used based on the toxic components in the process gas stream.
1. Allow the sample gas to continue flowing through the system.
 2. Open the tee-fitting cap on the exhaust port on the lower right side of the enclosure and insert a sensor to determine if there is H₂S inside the enclosure.
 3. If no hazardous gas is detected, proceed with opening the enclosure door.
 4. If hazardous gas is detected, follow the instructions below for purging the enclosure.

Purging the enclosure when no gas sensor is available

1. Turn off the sample gas to the system.
2. Connect the purge gas to the purge inlet on the upper right side of the enclosure.
3. Open the exhaust on the bottom right side of the enclosure and connect a piece of tubing that vents to safe area.
4. Input the purge gas at 2 liters per minute.
5. Operate the purge for 22 minutes.

Purging the sample system (optional)

1. Shut off gas to the analyzer.
2. Ensure the vent and bypass, if present, are open.
3. Connect the *purge gas to port (12)* → .
4. Switch the *valve (2) from process to purge* → .
5. Set the flow rate to 1 liter per minute and run the purge for at least 10 minutes for safety.

Repair verification

When repairs have been completed correctly, alarms will clear from the system.

10.4 Intermittent operation

If the analyzer is to be stored or shut down for a short period, follow the instructions for isolating the measurement cell and sample conditioning system (SCS).

CAUTION

- ▶ **Confirm the power source is disconnected at the switch or circuit breaker. Make sure the switch or breaker is in the OFF position and locked with a padlock.**
1. Purge the system as follows:
 - a. Shut off the process gas flow.
 - b. Allow all residual gas to dissipate from the lines.
 - c. Connect a nitrogen (N₂) purge supply, regulated to the specified sample supply pressure, to the sample supply port.
 - d. Confirm that any valves controlling the sample flow effluent to the low-pressure flare or atmospheric vent are open.
 - e. Turn on the purge supply to purge the system and clear any residual process gases.
 - f. Turn off the purge supply.
 - g. Allow all residual gas to dissipate from the lines.
 - h. Close any valves controlling the sample flow effluent to the low-pressure flare or atmospheric vent.
 2. Disconnect power and wiring from the analyzer system:
 - a. Disconnect power to the system.
 - b. Confirm all digital or analog signals are turned off at the location from which they are being monitored.
 - c. Disconnect the phase and neutral wires from the analyzer.
 - d. Disconnect the protective ground wire from the analyzer system.
 3. Disconnect all tubing and signal connections.
 4. Cap all inlets and outlets to prevent foreign material such as dust or water from entering the system.
 5. Ensure the analyzer is free from dust, oils, or any foreign material. Follow the instructions found in *Cleaning and decontamination* → .

- Pack the equipment in the original packaging in which it was shipped, if available. If the original packaging material is no longer available, the equipment should be adequately secured (to prevent excessive shock or vibration).
- If returning the analyzer to the factory, complete the Decontamination Form provided by Endress+Hauser and attach to the outside of the shipping package as instructed before *shipping* → .

10.5 Packing, shipping, and storage

The J22 TDLAS gas analyzer Systems and auxiliary equipment are shipped from the factory in appropriate packaging. Depending on the size and weight, the packaging may consist of a cardboard-skinned container or a wooden palletized crate. All inlets and vents are capped and protected when packaged for shipment. The system should be packed in the original packaging when shipped or stored for any length of time.

If the analyzer has been installed and or operated (even for purposes of a demonstration), the system should be decontaminated (purged with an inert gas) before powering down the analyzer.

WARNING

Process samples may contain hazardous material in potentially flammable and/or toxic concentrations.

- ▶ Personnel should have a thorough knowledge and understanding of the physical properties of the sample and prescribed safety precautions before installing, operating or maintaining the analyzer.

Preparing the analyzer for shipment or storage

- Purge the system as follows:
 - Shut off the process gas flow.
 - Allow all residual gas to dissipate from the lines.
 - Conduct enclosure purge (optional), if provided with the system.
 - Connect a purge supply (N₂) regulated to the specified sample supply pressure to the sample supply port.
 - Confirm that any valves controlling the sample flow effluent to the low pressure flare or atmospheric vent are open.
 - Turn on the purge supply and purge the system to clear any residual process gases.
 - Turn off the purge supply.
 - Allow all residual gas to dissipate from the lines.
 - Close any valves controlling the sample flow effluent to the low pressure flare or atmospheric vent.
- Disconnect power to the system.
- Disconnect all tubing and signal connections.
- Cap all inlets, outlets, vents or gland openings (to prevent foreign material such as dust or water from entering the system) using the original fittings supplied as part of the packaging from the factory.
- Pack the equipment in the original packaging in which it was shipped, if available. If the original packaging material is no longer available, the equipment should be adequately secured (to prevent excessive shock or vibration).
- If returning the analyzer to the factory, contact Service for a Decontamination Form Service contact. Attach the form to the outside of the shipping package as instructed before shipping.

Storage

The packaged analyzer should be stored in a sheltered environment that is temperature controlled between -20 °C to 50 °C (-4 °F to 122 °F), and should not be exposed to rain, snow, caustic or corrosive environments.

10.6 Service contact

For Service, refer to our website (<https://www.endress.com/contact>) for the list of local sales channels in your area.

10.6.1 Before contacting Service

Before contacting Service, prepare the following information to send with your inquiry:

- Analyzer serial number (SN)
- Contact information
- Description of the problem or questions

Access to the information above will expedite the response to technical requests.

10.6.2 Factory return

If returning the analyzer or components is required, obtain a **Service Repair Order (SRO) number** from Service before returning to the factory. Service can determine whether the analyzer can be serviced on site or should be returned to the factory. All returns should be shipped to:

Endress+Hauser
11027 Arrow Route
Rancho Cucamonga, CA 91730
United States

10.7 Disclaimers

Endress+Hauser accepts no responsibility for consequential damages arising from the use of this equipment. Liability is limited to replacement and/or repair of defective components.

This manual contains information protected by copyright. No part of this guide may be photocopied or reproduced in any form without prior written consent from Endress+Hauser.

10.8 Warranty

For a period of 18 months from date of shipment or 12 months in operation, whichever comes first, Endress+Hauser warrants that all products sold by it shall be free from defects in material and workmanship under normal use and service when correctly installed and maintained. Endress+Hauser's sole liability and Customer's sole and exclusive remedy for a breach of warranty is limited to Endress+Hauser's repair or replacement (at Endress+Hauser's sole option) of the product or part thereof which is returned at Customer's expense to Endress+Hauser's plant. This warranty shall apply only if Customer notifies Endress+Hauser in writing of the defective product promptly after the discovery of the defect and within the warranty period. Products may only be returned by Customer when accompanied by a return authorization reference number (SRO) issued by Endress+Hauser. Freight expenses for products returned by Customer will be prepaid by Customer. Endress+Hauser shall pay for shipment back to Customer for products repaired under warranty. For products returned for repair that are not covered under warranty, Endress+Hauser's standard repair charges shall be applicable in addition to all shipping expenses.

11 Spare parts

11.1 Controller

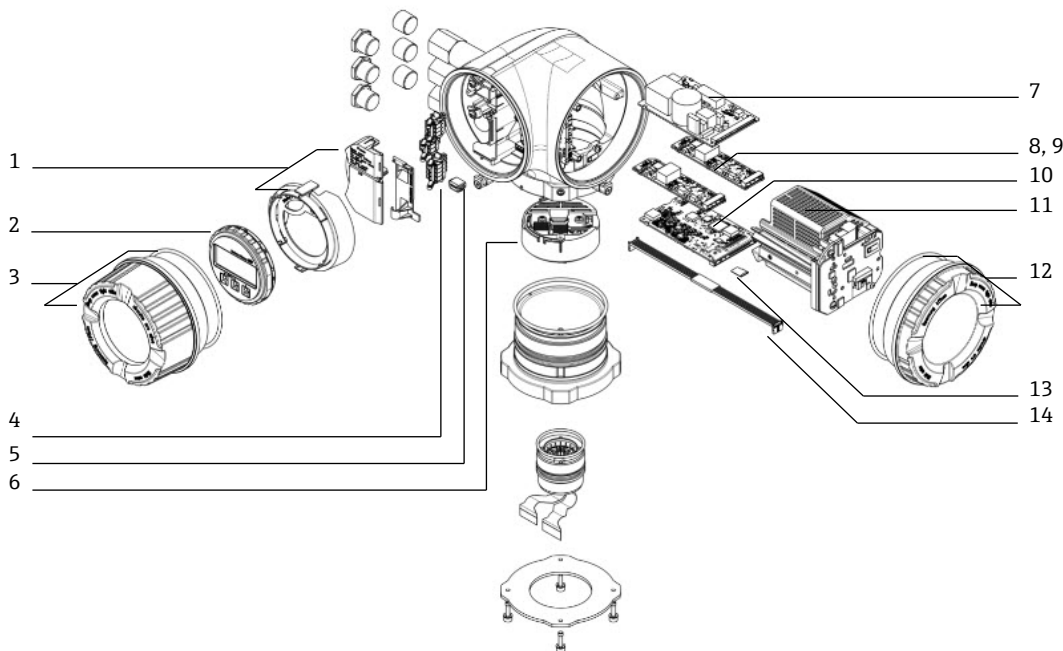

Fig 83. Controller spare parts

#	Endress+Hauser material number	Description	2-year quantity
1	70188831	Kit, Protective Cover	
2	70188832	Kit, Display Module	
3	70188828	Kit, Cover with Glass, Aluminum	1
4	70188834	Kit, Connection Terminal, Option RS485	
5	70188835	Kit, Memory, T-DAT	
6	70188818	Kit, Sensor Electronics 01	
7	70188837	Kit, Power Supply, 100 to 230 VAC	
7	70188838	Kit, Power Supply, 24 VDC	
8	70188839	Kit, I/O Module, Configurable I/O	
9	70188840	Kit, I/O Module, Relay output	
10	70188841	Kit, I/O Module, Slot 1, RS485	
10	70206730	Kit, I/O Module, Slot 1, RJ45	
11	70188833	Kit, Module Cartridge	
12	70188829	Kit, Cover, Electronics, Aluminum	
13	70188836	Kit, Memory, Micro SD Card	
14	70188819	Kit, Cable, Controller Sensor	1

11.2 J22 TDLAS gas analyzer

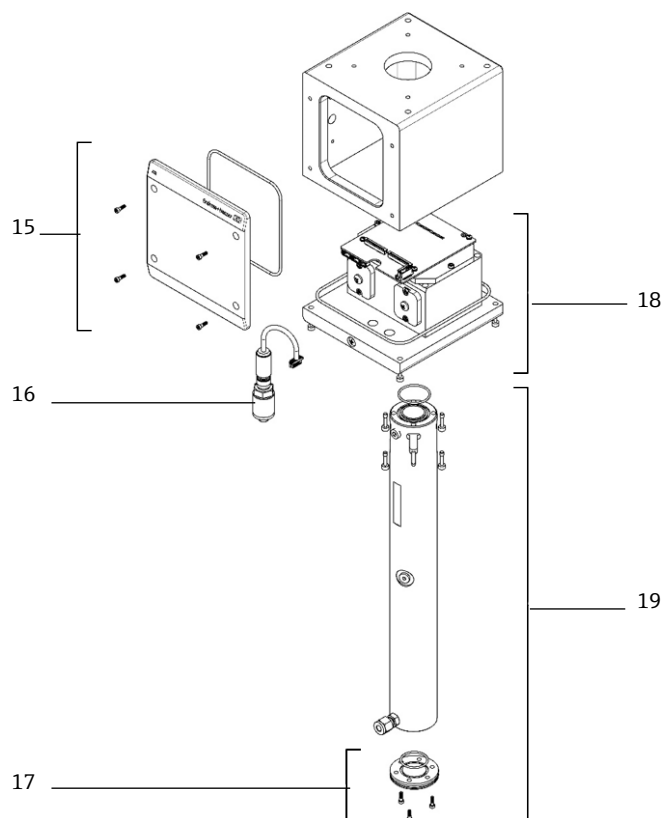

Fig 84. J22 analyzer spare parts

#	Endress+Hauser material number	Description	2-year quantity
15	70188820	Kit, Cover, Optical Head Enclosure	
16	70188825	Kit, Pressure Sensor, Digital	1
17	70188822	Kit, Mirror, Flat	
18	70188824	Kit, Optical Head 01, Calibrated	
19	70188821	Kit, Cell Tube and Mirror, 0.8 m	
	70188827	Kit, Service Tools	1
	70188826	Kit, spectrometer seals	1

11.3 J22 TDLAS gas analyzer on panel

NOTICE

- ▶ Sample Conditioning System (SCS) components and layout are similar for both the panel and enclosed model configurations.

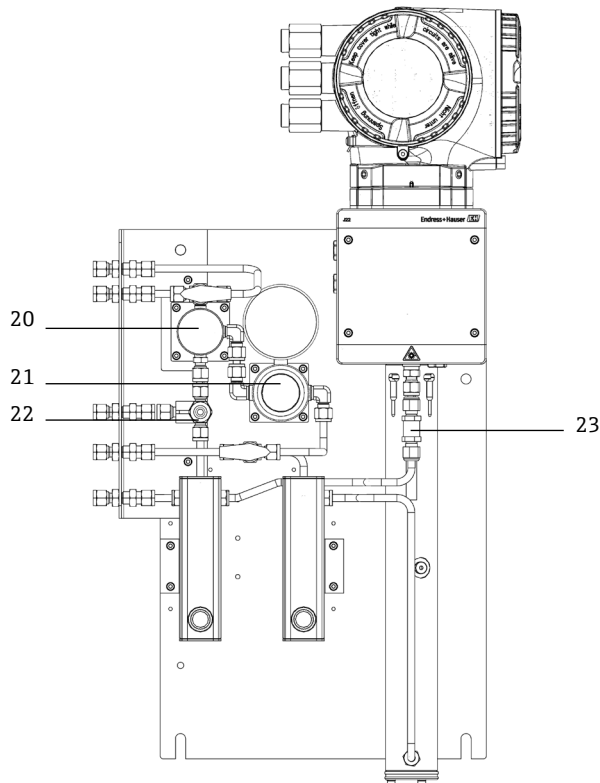

Fig 85. J22 on a panel spare parts

#	Endress+Hauser material number	Description	2-year quantity
20	70188845	Kit, Membrane Separator	
20	70188846	Kit, Membrane Separator, Element	1
21	70188850	Kit, Pressure Regulator, Parker	
21	70188852	Kit, Repair, Pressure Regulator	1
22	70188849	Kit, Relief Valve	
23	70188848	Kit, Check Valve	

11.4 J22 TDLAS gas analyzer with enclosure

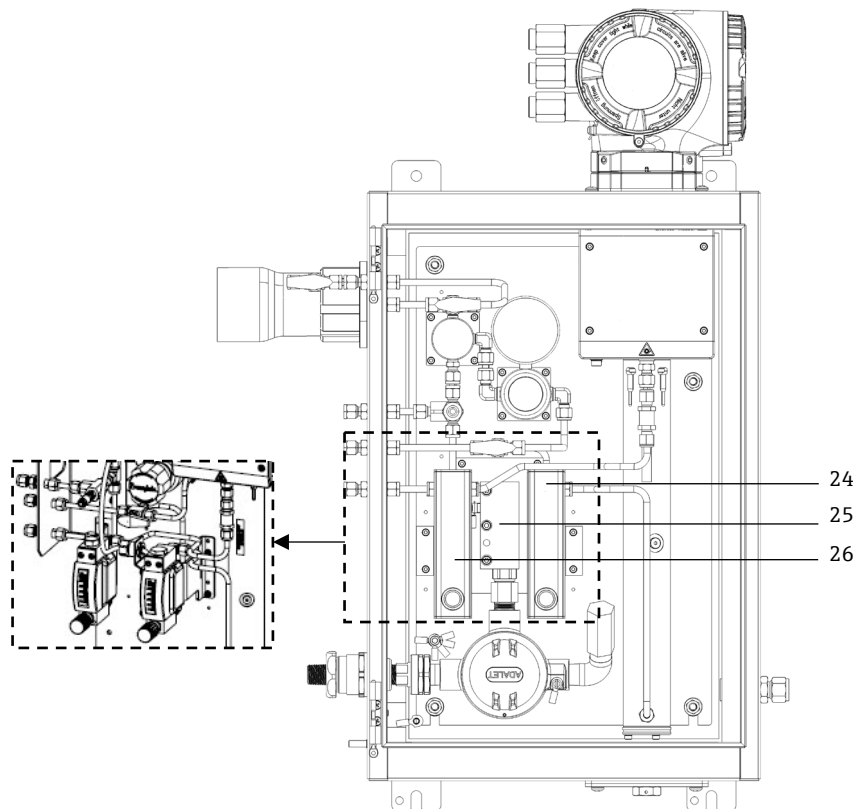

Fig 86. J22 with enclosure spare parts

#	Endress+Hauser material number	Description	2-year quantity
24	70206775	Kit, Flow Meter, Krohne, Armored, with Flow Switch (ATEX)	
24	70206776	Kit, Flow Meter, Krohne, Armored, with Flow Switch (CSA)	
24, 26	70206735	Kit, Flow Meter, King, Glass	
24, 26	70206736	Kit, Flow Meter, Krohne, Glass	
24, 26	70206772	Kit, Flow Meter. King, Armored	
24, 26	70206774	Kit, Flow Meter, Krohne, Armored	
25	70188857	Kit, Heater, ATEX/IECEX (Enclosed SCS Model Only)	
25	70188858	Kit, Heater, CSA (Enclosed SCS Model Only)	
-	70188856	Kit, Flow Restrictor	
-	-	Kit, Metric Fittings	

11.4.1 General

#	Endress+Hauser material number	Description	2-year quantity
-	70156817	Kit, Cleaning Tools, Optical Cell (USA/Canada only)	1
-	70156818	Kit, Cleaning Tools, Optical Cell, No Chemicals (International)	1

11.5 Controller spare parts details

11.5.1 Sensor electronics Endress+Hauser material number 70188818

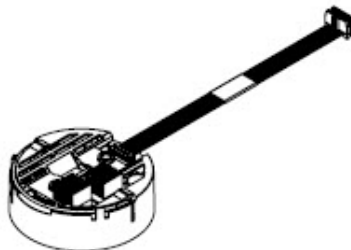

Materials

- ISEM electronics assembly

11.5.2 Controller-sensor cable, Endress+Hauser material number 70188819

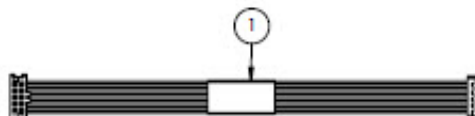

Materials

- Cable, P3 to ISEM MCU digital board

11.5.3 Optical head enclosure cover, Endress+Hauser material number 70188820

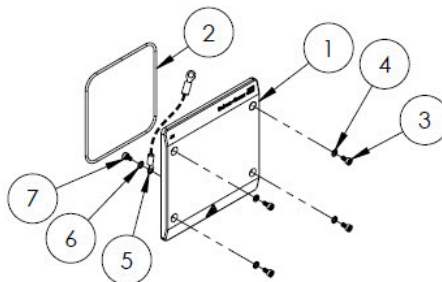

Materials

1. Cover, optical head enclosure
2. O-ring, FKM
3. Socket head screw, M4-0.7 x 8(4)
4. Lock washer (4)
5. Ground cable
6. Ext tooth washer
7. Socket head screw, M4-0.7 x 6

11.5.4 0.8m cell tube and mirror, Endress+Hauser material number 70188821

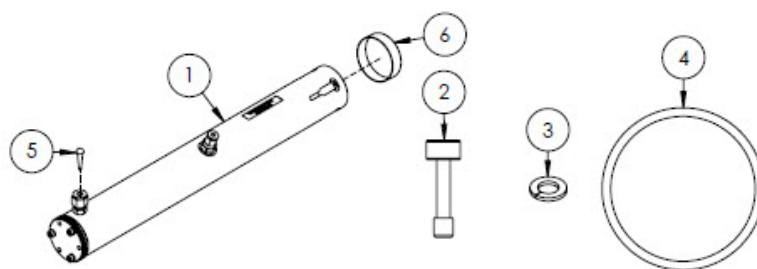

Materials

1. Cell tube assembly, 0.8 m
2. Socket head screw, M4-0.7 x 16 (4)
3. Lock washer (4)
4. O-ring, FKM
5. Tapered vinyl plug
6. Vinyl cap

NOTICE

- ▶ When installing the cell tube assembly onto the analyzer, torque the screws (item 2) to 4.5 Nm (39.8 lbf-in).
- ▶ Grease the O-ring (item 4) with Syntheso Glep 1 or equivalent prior to installing.
- ▶ NACE and MTR reports available upon request.

11.5.5 Flat mirror, Endress+Hauser material number 70188822

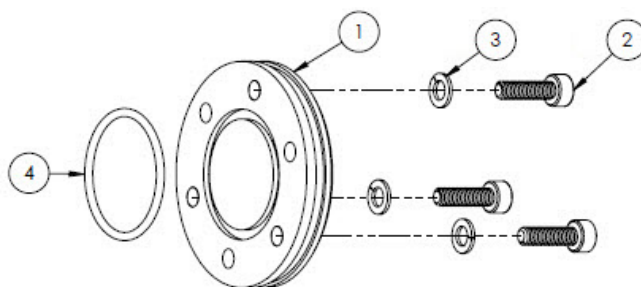

Materials

1. Mirror, 0.8 m
2. Socket head screw, M4-0.7 x 14(3)
3. Lock washer (3)
4. O-ring, FKM

NOTICE

- ▶ When installing the mirror onto the cell tube assembly, torque the screws (item 2) to 2.6 Nm (23 lbf-in).
- ▶ Grease the O-ring (item 4) with Syntheso Glep 1, or equivalent, prior to installing.
- ▶ NACE and MTR reports available upon request.

11.5.6 Calibrated optical head, Endress+Hauser material number 70188824

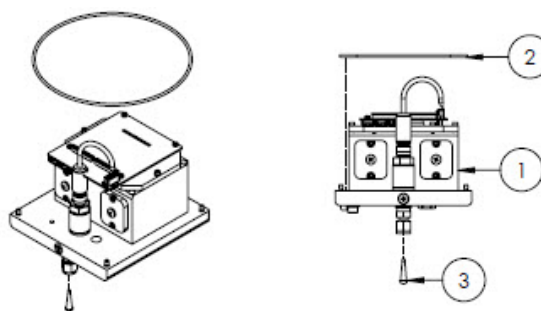

Materials

1. Optical head assembly
2. O-ring, FKM
3. Tapered vinyl plug

NOTICE

- ▶ Measurement range and background gas composition must be supplied at time of order.
- ▶ The O-ring (item 2) is installed in the O-ring groove within the optical head enclosure. Lightly grease the O-ring before installing.
- ▶ Grease the O-ring (item 2) with Syntheso Glep 1, or equivalent, before installation.
- ▶ NACE and MTR reports available upon request.

11.5.7 Digital pressure sensor, Endress+Hauser material number 70188825

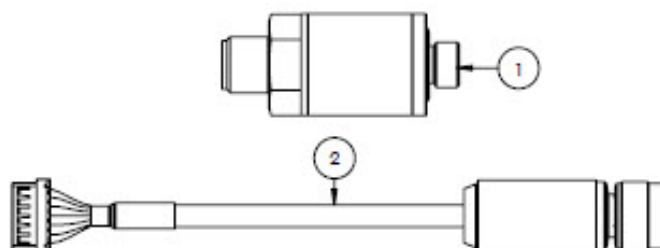

Materials

1. Pressure sensor, digital
2. Cable assembly, pressure, digital

NOTICE

- ▶ Grease the pressure sensors thread with Syntheso Glep 1, or equivalent, before installation.
- ▶ CRN compliant component.

11.5.8 Spectrometer seals, Endress+Hauser material number 70188826

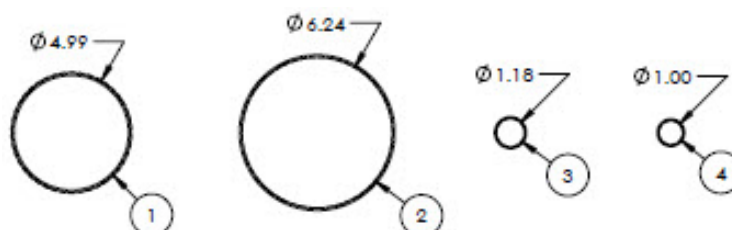

Materials

1. O-ring, FKM, #159, 4.99 x 0.103
2. O-ring, FKM, #164, 6.24 x 0.103
3. O-ring, FKM, #025, 1.18 x 0.070

- 4. O-ring, FKM, 1.00 x 0.070

NOTICE

- ▶ O-ring (item 1) is installed onto the cover, optical head enclosure.
- ▶ O-ring (item 2) is installed onto the optical head enclosure.
- ▶ O-ring (item 3) is installed onto the cell tube assembly.
- ▶ O-ring (item 4) is installed onto the 0.1 m metal mirror.
- ▶ Grease all O-rings with Syntheso Glep 1, or equivalent, before installation.

11.5.9 Service tools, Endress+Hauser material number 70188827

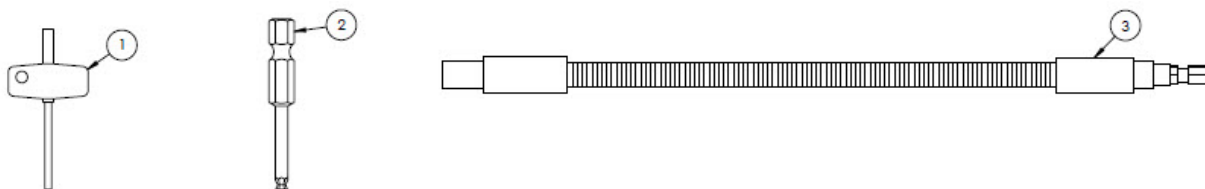

Materials

- 1. Torx, 3" overall
- 2. ¼" Hex shank, 3 mm hex size
- 3. Flex driver, 18 Nm (156 lbf-in) MAX

11.5.10 Cover with glass, Endress+Hauser material number 70188828

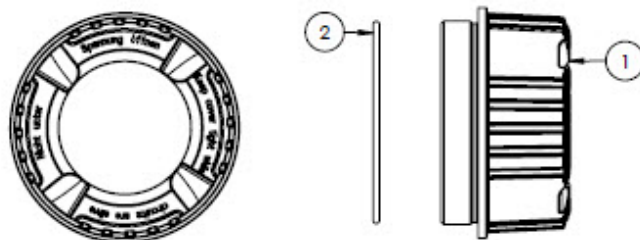

Materials

- 1. Cover
- 2. O-ring

NOTICE

- ▶ Grease the O-ring with Syntheso Glep 1, or equivalent, before installation.

11.5.11 Electronics cover, Endress+Hauser material number 70188829

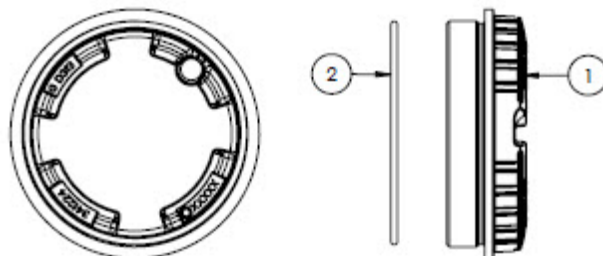

Materials

- 1. Cover
- 2. O-ring

NOTICE

- ▶ Grease the O-ring with Syntheso Glep 1, or equivalent, before installation.

11.5.12 Protective cover, Endress+Hauser material number 70188831

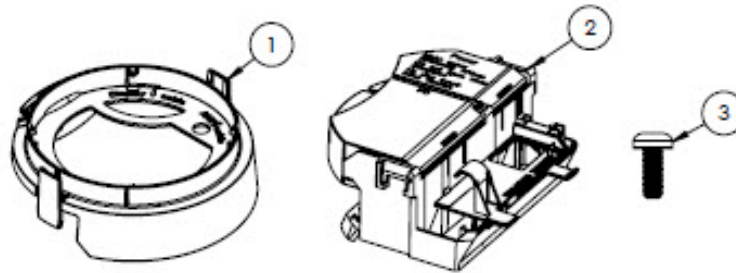

Materials

1. Cover, display holder
2. Cover terminal compartment
3. Screw, Torx M4 x 10 mm
4. Labels

11.5.13 Display module, Endress+Hauser material number 70188832

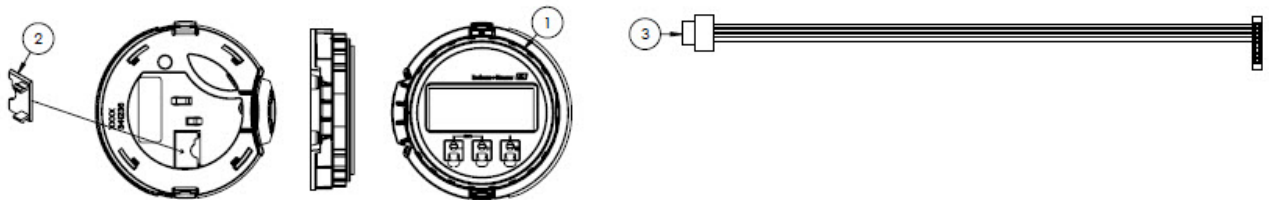

Materials

1. Display module
2. Cover, connector to display
3. Ribbon cable assembly

11.5.14 Module cartridge, Endress+Hauser material number 70188833

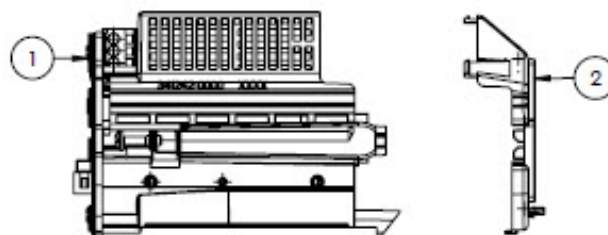

Materials

1. Circuit carrier electronics
2. Cover, electronics

11.5.15 Connection terminal, Endress+Hauser material number 70188834

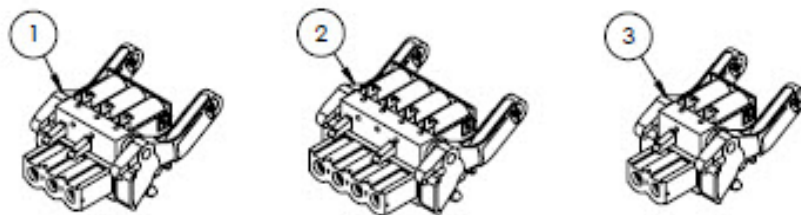

Materials

1. Power terminal connector, 2 pol
2. I/O2 and 3 terminal connector, 4 pol
3. I/O1 terminal connector, 2 pol

NOTICE

- ▶ Use connectors 1, 2, and 3 for RS485 option.
- ▶ Use connectors 1 and 2 for RJ45 option.

11.5.16 T-DAT Memory, Endress+Hauser material number 70188835

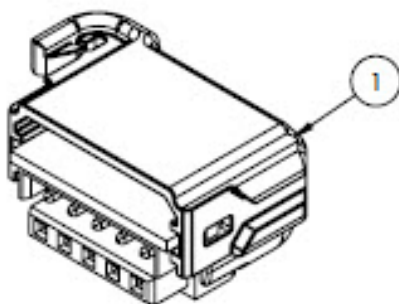

Materials

1. PCBA, DAT-transmitter

11.5.17 Micro SD card memory, Endress+Hauser material number 70188836

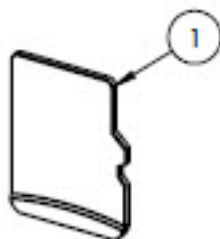

Materials

1. PCBA, SD card micro

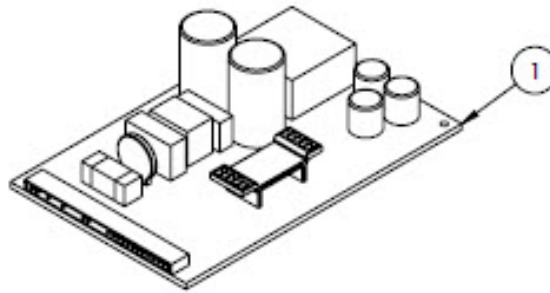
11.5.18 Power supply, 100-230 VAC, Endress+Hauser material number 70188837**Materials**

1. PCBA, Power supply 100-230 VAC

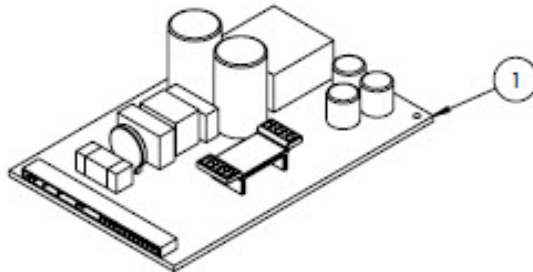
11.5.19 Power supply, 24 VDC, Endress+Hauser material number 70188838**Materials**

1. PCBA, power supply 24 VDC

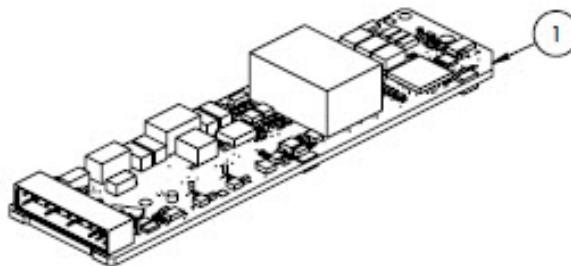
11.5.20 Configurable I/O module, Endress+Hauser material number 70188839**Materials**

1. PCBA, I/O board. configurable I/O

11.5.21 Relay output I/O module, Endress+Hauser material number 70188840

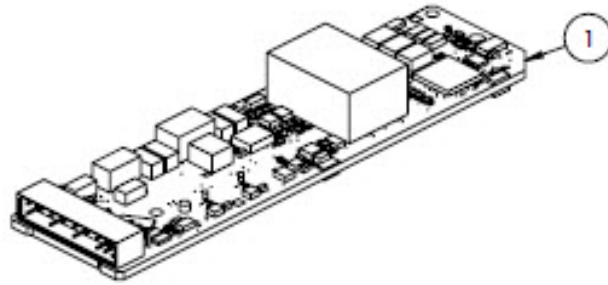

Materials

1. PCBA, I/O board, relay output

11.5.22 RS485 Slot 1 I/O module, Endress+Hauser material number 70188841

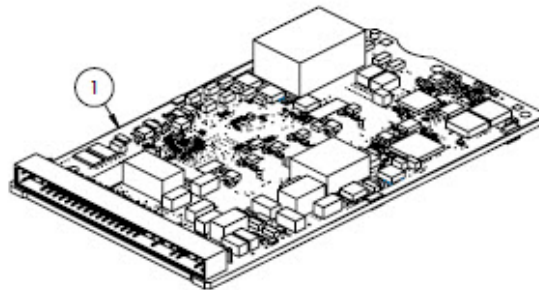

Materials

1. PCBA, CPU/modem, Slot 1 RS485

11.5.23 RJ45 Slot 1 I/O module, Endress+Hauser material number 70206730

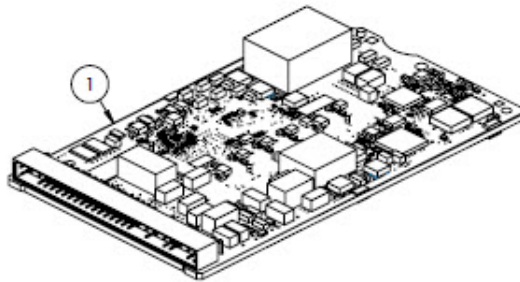

Materials

1. PCBA, CPU/modem, Slot 1 RJ45

11.6 Sample conditioning system spare parts details

11.6.1 Analyzer gas fittings, Endress+Hauser material number 70188842

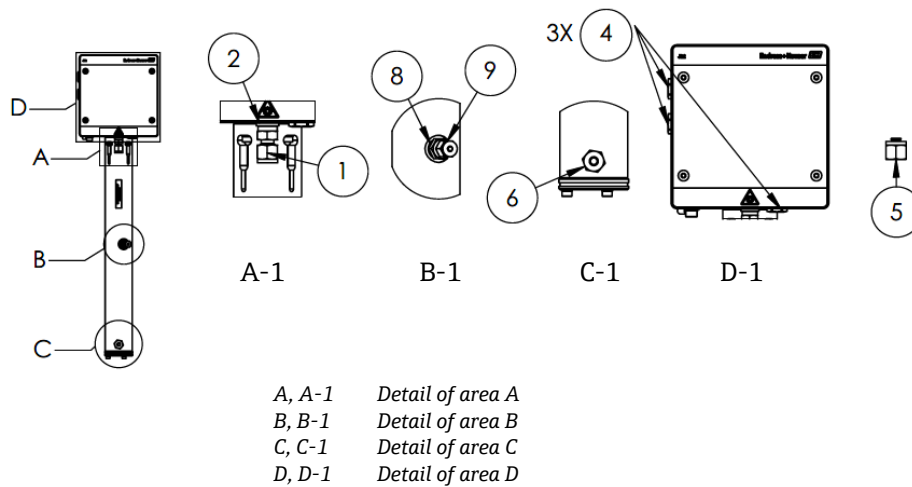

Materials

1. Connector fitting
2. Sealing washer
3. Hollow hex plug. 1/8" NPTM. Item 3 is located behind 1 and 2 in A-1 on cell tube.
4. Sealing hex plug M12 x 1.5, O-ring (3)
5. 1/4" tube fitting (TF) plug (2)
6. Connector fitting
7. Tape, TFE
8. Connector fitting
9. 1/8" plug

NOTICE

- ▶ Use 2 to 3 wraps of tape (item 7) on all connectors and plugs during installation.
- ▶ Torque hollow hex plug (item 3) to 2.6 Nm (23 lbf-in).
- ▶ Torque sealing hex plug to 7.0 Nm (62 lbf-in).
- ▶ NACE and MTR reports available upon request.
- ▶ CRN compliant component.

11.6.2 1/4" gas fitting connector, with purge, Endress+Hauser material number 70188843

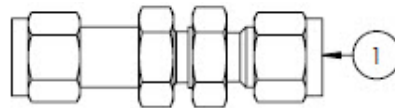

Materials

1. Tube, union bulkhead 1/4" tube fitting (TF) (6)

NOTICE

- ▶ Torque nut on 1/4" swaged bulkhead to 12.0 Nm (106 lbf-in).
- ▶ NACE and MTR reports available upon request.
- ▶ CRN compliant component.

11.6.3 ¼" gas fitting connector, without purge, Endress+Hauser material number 70188844

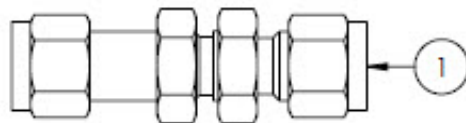

Materials

1. Tube, union bulkhead ¼" TF (tube fitting) (5)

NOTICE

- ▶ Torque nut on ¼" swaged bulkhead to 12.0 Nm (106 lbf-in).
- ▶ NACE and MTR reports available upon request.
- ▶ CRN compliant component.

11.6.4 Membrane separator, Endress+Hauser material number 70188845

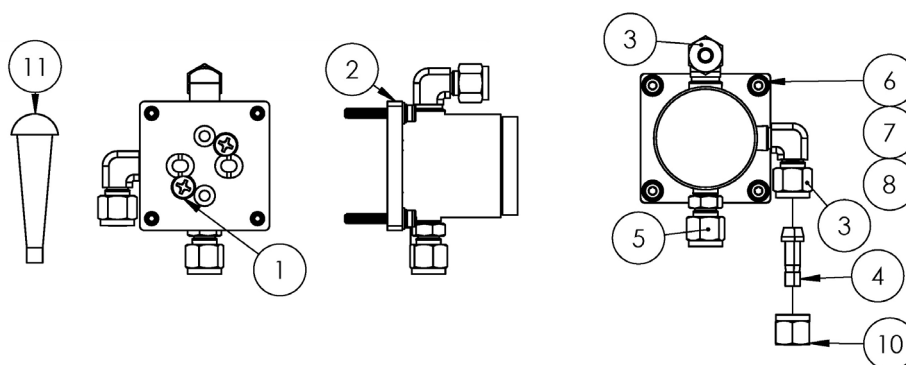

Materials

1. Phillips flat head screw #10-32 x 0.500 (2)
2. Pressure regulator bracket
3. Male elbow (2)
4. Port connector ¼" TF (tube fitting)
5. Connector fitting
6. Flat washer (4)
7. Lock washer (4)
8. Socket head screw, M4-0.7 x 25(4)
9. Tape, TFE
10. Tube nut, ¼" TF (tube fitting)
11. Tapered vinyl plug (3)

NOTICE

- ▶ Use 2 to 3 wraps of tape on all connectors during installation.
- ▶ NACE and MTR reports available upon request.
- ▶ Install port connector (item 4) in the field.
- ▶ CRN compliant component.

11.6.5 Membrane element kit, Endress+Hauser material number 70188846



Materials

1. Membrane kit, type 7
2. O-ring, FKM, Genie 120

NOTICE

- ▶ Grease the O-ring (item 2) with Syntheso Glep 1, or equivalent, before installation.
- ▶ CRN compliant component.

11.6.6 7 micron filter, Endress+Hauser material number 70188847

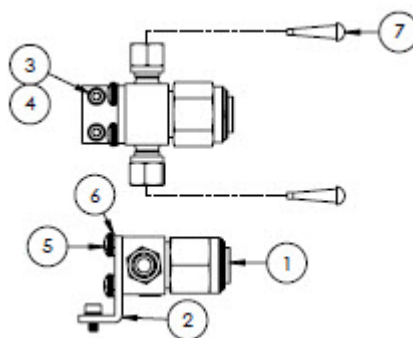

Materials

1. Filter, T-type
2. Bracket, Swagelok T-filter
3. Lock washer (2)
4. Socket head screw, M4-0.7 x 8(2)
5. Phillips pan head screw, M5-0.8(2)
6. Lock washer (2)
7. Tapered vinyl plug (2)

NOTICE

- ▶ Torque the screws (item 4) to 2.6 Nm (23 lbf-in).
- ▶ Torque the screws (item 5) to 5.1 Nm (45.1 lbf-in).
- ▶ NACE and MTR reports available upon request.
- ▶ CRN compliant component.

11.6.7 7 micron filter repair kit, Endress+Hauser material number 70206803

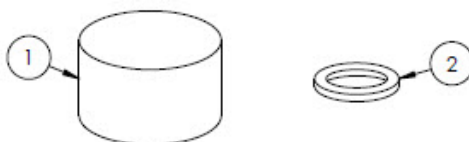

Materials

1. 7 μ filter element
2. 7 μ filter gasket

NOTICE

- ▶ CRN compliant component.

11.6.8 Check valve, Endress+Hauser material number 70188848

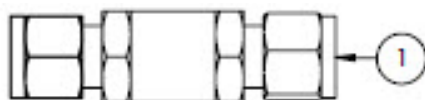

Materials

1. Check valve

NOTICE

- ▶ NACE and MTR reports available upon request.
- ▶ CRN compliant component.

11.6.9 Relief valve, Endress+Hauser material number 70188849

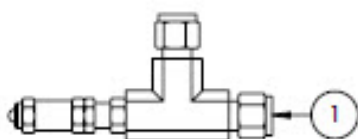

Materials

1. Relief valve

NOTICE

- ▶ NACE and MTR reports available upon request.
- ▶ Relief valve must be set for 350 kPa (50 psig). Verify prior to installation.

11.6.10 Parker pressure regulator, Endress+Hauser material number 70188850

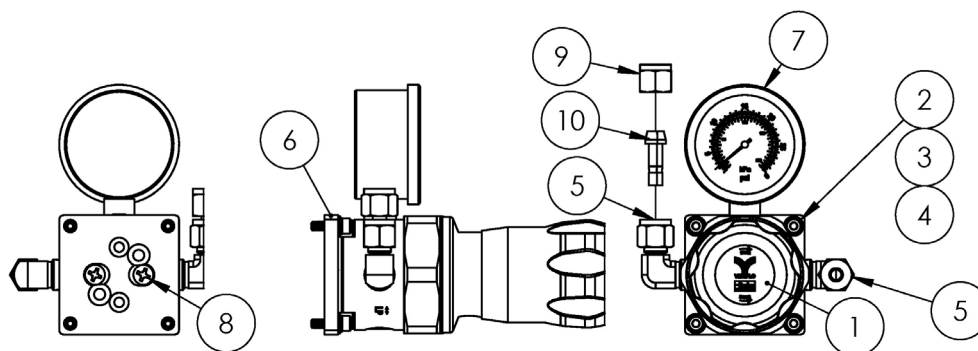

Materials

1. Pressure regulator
2. Flat washer (4)
3. Lock washer (4)
4. Socket head screw, M4-0.7 x 14 (4)
5. Male elbow (2)
6. Bracket, pressure regulator
7. Pressure gauge
8. Phillips flat head screw, #10-32 x 0.500 (2)
9. Tube nut, 1/4" TF (tube fitting)
10. Port connector, 1/4" TF (tube fitting)
11. Tape, TFE

NOTICE

- ▶ Apply 2 to 3 wraps of tape (item 11) to male elbow (item 5) before installation.
- ▶ Torque screws (item 4) to 2.6 Nm (23 lbf-in)

- ▶ Torque screws (item 8) to 11.0 Nm (97.4 lbf-in).
- ▶ NACE and MTR reports available upon request.
- ▶ CRN compliant component.
- ▶ Items 9 and 10 to be shipped loose.

11.6.11 Neon pressure regulator, Endress+Hauser material number 70188852

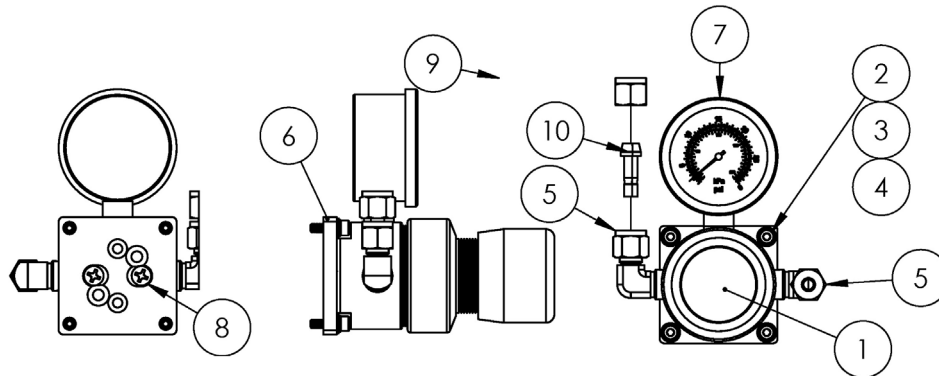

Materials

1. Pressure regulator
2. Flat washer (4)
3. Lock washer (4)
4. Socket head screw, M4-0.7 x 14 (4)
5. Male elbow (2)
6. Bracket, pressure regulator
7. Pressure gauge
8. Phillips flat head screw, #10-32 x 0.500 (2)
9. Tube nut, 1/4" TF (tube fitting)
10. Port connector, 1/4" TF (tube fitting)
11. Tape, TFE

NOTICE

- ▶ Apply 2 to 3 wraps of tape (item 11) to male elbow (item 5) before installation.
- ▶ Torque screws (item 4) to 2.6 Nm (23 lbf-in)
- ▶ Torque screws (item 8) to 11.0 Nm (97.4 lbf-in).
- ▶ NACE and MTR reports available upon request.
- ▶ Items 9 and 10 to be shipped loose.

11.6.12 Flow restrictor, Endress+Hauser material number 70188856

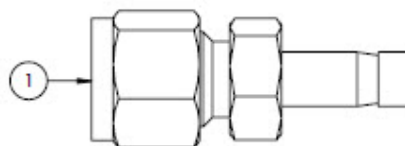

Materials

1. Flow restrictor

NOTICE

- ▶ NACE and MTR reports available upon request.
- ▶ CRN compliant component.

11.6.13 ATEX/IECEx heater, Endress+Hauser material number 70188857

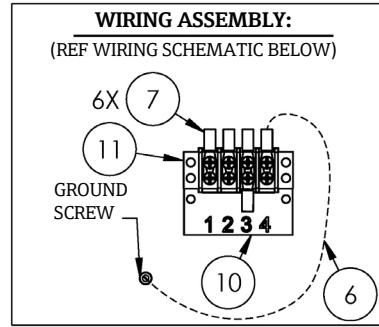
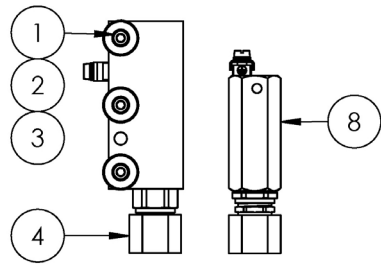

Wiring diagram

Materials

1. Socket head screw, M5-0.8 x 50 (3)
2. Lock washer (3)
3. Flat washer (3)
4. Heater
5. Label, terminal block
6. Ground cable GRN/YEL
7. Locking terminal fork (6)
8. Thermostat
9. Thermal compound grease
10. Label, terminal block
11. Terminal block

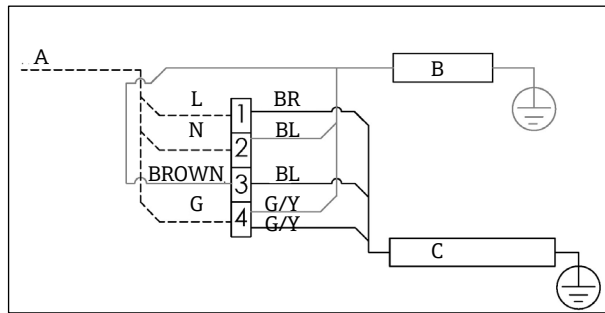

- | | | | |
|----|--|-----|--------------|
| A | 100 to 240 VAC ± 10%, 50/60 HZ, Main power | | |
| B | Heater | G/Y | Green/yellow |
| C | Thermostat | L | Line |
| BR | Brown wire | N | Neutral |
| BL | Blue wire | G | Ground |

NOTICE

- ▶ Torque screws (item 1) to 5.1 Nm (45.1 lbf-in).
- ▶ Crimp terminals per manufacturer specifications with Panduit CT-1550 or equivalent.
- ▶ Apply a thin, even coat of thermal compound (item 9) 0.1 mm thick to the bottom surface of the heater block (item 4) when installing it on the heater plate assembly.
- ▶ Service technicians will be required to install the input power.
- ▶ Refer to the dashed lines in the wiring diagram for field technicians installation requirements and the solid lines for the factory-installed components.
- ▶ Both heater and thermostat ground wires use the same terminal fork.

11.6.14 CSA heater, Endress+Hauser material number 70188858

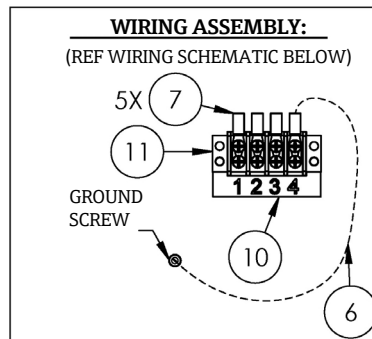
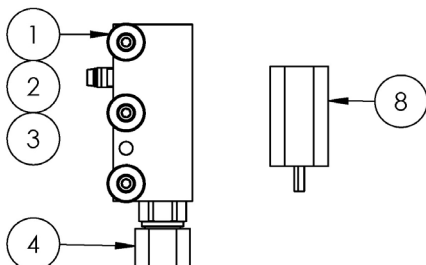

Materials

1. Socket head screw, M5-0.8 x 50 (3)
2. Lock washer (3)
3. Flat washer (3)
4. Heater
5. Terminal block label
6. Ground cable
7. Locking terminal fork (6)
8. Thermostat
9. Thermal compound grease
10. Terminal block label
11. Terminal block

NOTICE

- ▶ Torque screws (item 1) to 5.1 Nm (45.1 lbf-in).
- ▶ Crimp terminals per manufacturer specifications with Panduit CT-1550 or equivalent.
- ▶ Apply a thin, even coat of thermal compound (item 12) 0.1 mm thick to the bottom surface of the heater block (item 4) when installing it on the heater plate assembly.
- ▶ Service technicians are required to install the input power.
- ▶ Refer to the dashed lines in the wiring diagram for field technicians installation requirements. The solid lines are for the factory-installed components.
- ▶ Both heater and thermostat ground wires use the same terminal fork.

Wiring diagram

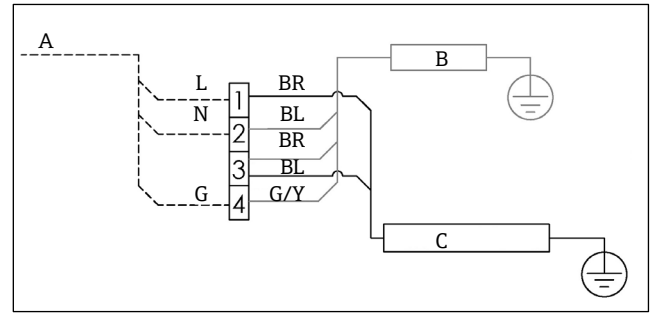

A	100 to 240 VAC ± 10%, 50/60 HZ, Main power
B	Heater
C	Thermostat
BR	Brown wire
BL	Blue wire
G/Y	Green/yellow
L	Line
N	Neutral
G	Ground

11.6.15 King glass flow meter, Endress+Hauser material number 70206735

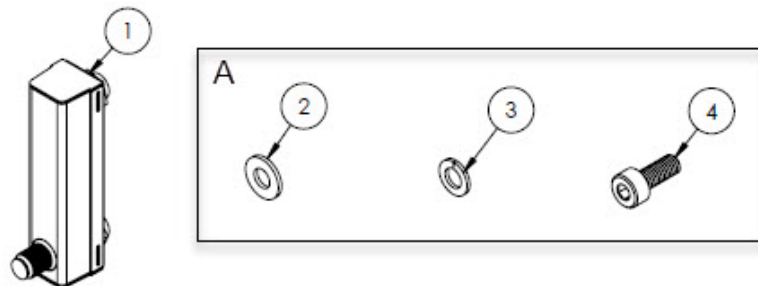

A Hardware is used to mount the flow meter to the bracket and the bracket to the panel.

Materials

1. Flow meter, King, glass
2. Flat washer (4)
3. Lock washer (4)
4. Socket head screw, M4-0.7 x 10 (4)

NOTICE

- ▶ Torque screws (item 4) to 2.6 Nm (23 lbf-in).

11.6.16 Krohne glass flow meter, Endress+Hauser material number 70206736

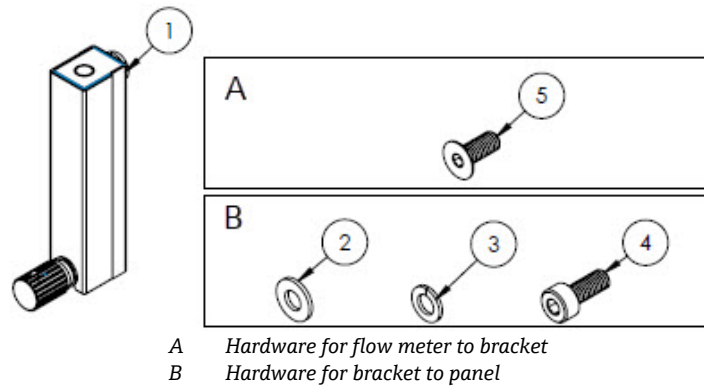

Materials

1. Flow meter, Krohne, glass
2. Flat washer (2)
3. Lock washer (2)
4. Socket head screw, M4-0.7 x 10 (2)
5. Flat head screw, M4-0.7 x 10 (2)

NOTICE

- ▶ Torque screws (item 4) to 2.6 Nm (23 lbf-in).
- ▶ Torque screws (item 5) to 2.6 Nm (23 lbf-in).

11.6.17 King armored flow meter, Endress+Hauser material number 70206772

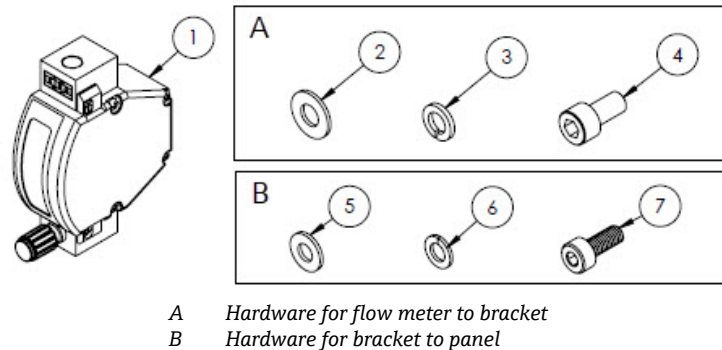

Materials

1. Flow meter, King, armored
2. Flat washer (2)
3. Lock washer (2)
4. Socket head screw #10-32 x 10 (2)
5. Flat washer (2)
6. Lock washer (2)
7. Socket head screw, M4-0.7 x 10 (2)

NOTICE

- ▶ Torque screws (item 4) to 2.6 Nm (23 lbf-in).
- ▶ Torque screws (item 7) to 2.6 Nm (23 lbf-in).
- ▶ CRN compliant component.

11.6.18 Krohne armored flow meter, Endress+Hauser material number 70206774

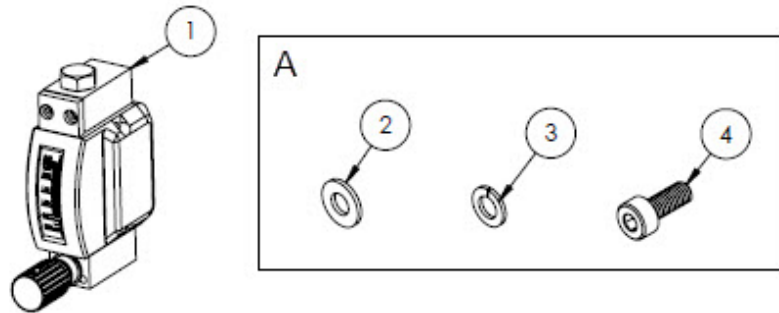

A Hardware for bracket to panel

Materials

1. Flow meter, armored
2. Flat washer (2)
3. Lock washer (2)
4. Socket head screw, M4-0.7 x 10 (2)

NOTICE

- ▶ Torque screws (item 4) to 2.6 Nm (23 lbf-in).
- ▶ CRN compliant component.

11.6.19 ATEX Krohne armored flow meter kit, Endress+Hauser material number 70206775

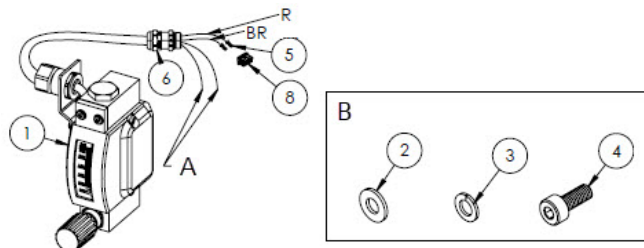

- A Both the blue and white wires will have 2 in of heat-shrink (item 7) installed over the ends.
- B Hardware for bracket to panel.
- BR Brown wire to pin 2 on rectangular connector.
- R Red wire to pin 2 on rectangular connector.

Materials

1. Flow meter, armored, ATEX
2. Flat washer (2)
3. Lock washer (2)
4. Socket head screw, M4-0.7 x 10 (2)
5. Contact connector
6. Cable gland
7. Heat-shrink, olefin
8. Rectangular connector, 4 position

NOTICE

- ▶ Torque screws (item 4) to 2.6 Nm (23 lbf-in).
- ▶ Flowrate range: 0.2-2.000 slpm

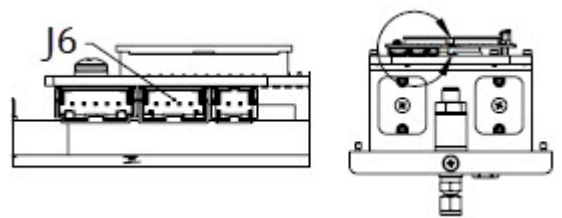

J6 Rectangular connector is inserted to the second connector on the optical head PCB assembly.

11.6.20 CSA Krohne armored flow meter kit, Endress+Hauser material number 70206776

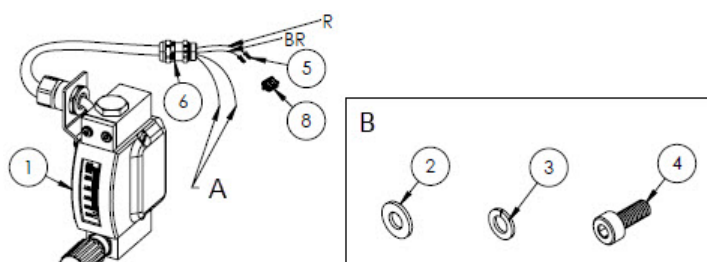

- A Both the blue and white wires will have 2" of heat-shrink (item 7) installed over the ends.
- B Hardware for bracket to panel.
- BR Brown wire to pin 2 on rectangular connector.
- R Red wire to pin 2 on rectangular connector.

Materials

1. Flow meter, armored, CSA
2. Flat washer (2)
3. Lock washer (2)
4. Socket head screw, M4-0.7 x 10 (2)
5. Contact connector
6. Cable gland
7. Heat-shrink, olefin
8. Rectangular connector, 4 position

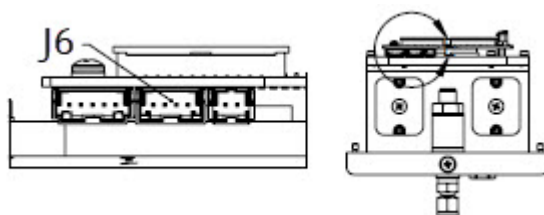

J6 Rectangular connector is inserted to the second connector on the optical head PCB assembly.

NOTICE

- ▶ Torque screws (item 4) to 2.6 Nm (23 lbf-in).
- ▶ Flowrate range: 0.2-2.000 slpm
- ▶ CRN compliant component.

11.6.21 Flow meter gas fittings without bypass, Endress+Hauser material number 70206777

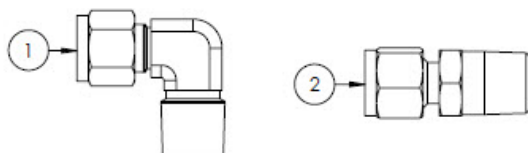

Materials

1. Male elbow
2. Connector fitting
3. Tape, TFE

NOTICE

- ▶ Select this connector kit if the sample conditioning system has one flow meter (without bypass).
- ▶ Apply 2 to 3 wraps of tape (item 3) to both connectors during installation.
- ▶ NACE and MTR reports available upon request.
- ▶ CRN compliant component.

11.6.22 Flow meter gas fittings with bypass, Endress+Hauser material number 70206798

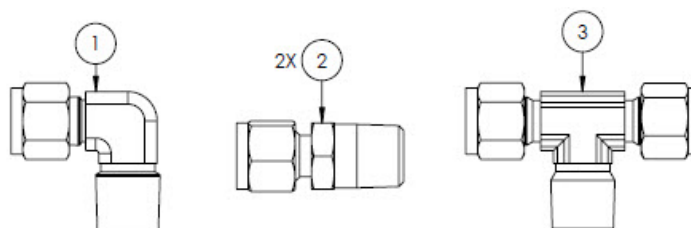

Materials

1. Male elbow
2. Connector fitting
3. Branch tee
4. Tape, TFE

NOTICE

- ▶ Select this connector kit if the sample conditioning system has two flow meters (with bypass).
- ▶ Apply 2 to 3 wraps of tape (item 4) to both connectors during installation.
- ▶ NACE and MTR reports available upon request.
- ▶ CRN compliant component.

11.6.23 King glass flow meter bracket, Endress+Hauser material number 70206799

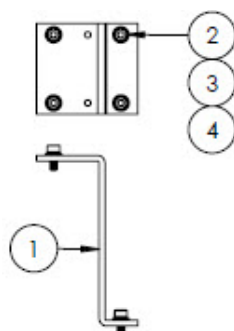

Materials

1. Bracket, flow meter, King model
2. Flat washer (4)
3. Lock washer (4)
4. Socket head screw, M4-0.7 x 10 (4)

NOTICE

- ▶ Torque screws (item 4) to 2.6 Nm (23 lbf-in).

11.6.24 Krohne glass flow meter bracket, Endress+Hauser material number 70206800

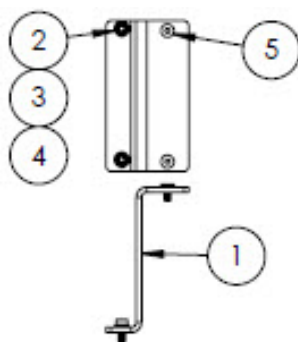

Materials

1. Bracket, flow meter, Krohne model
2. Flat washer (2)
3. Lock washer (2)
4. Socket flat head screw, M4-0.7 x 10 (2)
5. Flat head screw, M4-0.7 x 10 (2)

NOTICE

- ▶ Torque screws (item 4) to 2.6 Nm (23 lbf-in).

11.6.25 Krohne armored flow meter bracket, Endress+Hauser material number 70206801

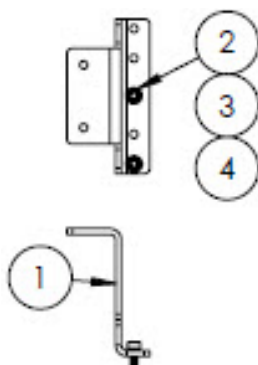

Materials

1. Bracket, flow meter, Krohne armored
2. Flat washer (2)
3. Lock washer (2)
4. Socket head screw, M4-0.7 x 10 (2)

NOTICE

- ▶ Flow meter comes with hardware to mount the bracket.
- ▶ Torque screws (item 4) to 2.6 Nm (23 lbf-in).

11.6.26 King armored flow meter bracket, Endress+Hauser material number 70206802

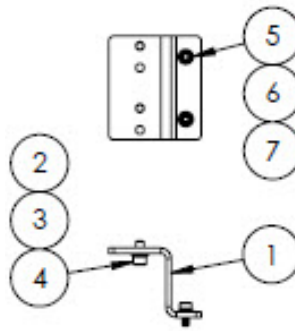

Materials

1. Bracket, flow meter, King armored
2. Socket head screw, #10-32 x 0.375 (2)
3. Lock washer (2)
4. Flat washer, 10-32 (2)
5. Flat washer, M4 (2)
6. Lock washer (2)
7. Socket head screw, M4-0.7 x 10 (2)

NOTICE

- ▶ Torque screws (item 2) to 2.6 Nm (23 lbf-in).
- ▶ Torque screws (item 7) to 2.6 Nm (23 lbf-in).

11.6.27 Micron filter repair kit, Endress+Hauser material number 70206803



Materials

1. 7 μ filter element
2. 7 μ filter gasket.

NOTICE

3. CRN compliant component.

12 Technical data

12.1 Electrical and communications

Item	Description	
Input Voltages	100 to 240 VAC tolerance $\pm 10\%$ 50/60 Hz, 10W ¹ 24 VDC tolerance $\pm 20\%$, 10W $U_M = 250$ VAC Heater 100 to 240 VAC tolerance $\pm 10\%$ 50/60 Hz, 80W	
Output Type	Modbus RS485 or Modbus TCP over Ethernet (IO1)	$U_N = 30$ VDC $U_M = 250$ VAC N = nominal, M = maximum
	Relay Output (IO2 and/or IO3)	$U_N = 30$ VDC $U_M = 250$ VAC $I_N = 100$ mA DC/500 mA AC
	Configurable IO Current 4-20 mA Input/Output (Passive/Active) (IO2 or IO3)	$U_N = 30$ VDC $U_M = 250$ VAC
	Intrinsically Safe Output (Flow Switch)	$U_o = \pm 5.88$ V $I_o = 4.53$ mA $P_o = 6.6$ mW $C_o = 43$ μ F $L_o = 1.74$ H

12.2 Application data

Item	Description
Environmental temperature range	Storage (analyzer and analyzer on panel): -40 °C to 60 °C (-40 °F to 140 °F) Storage (analyzer with enclosed SCS ²): -30 °C to 60 °C (-22 °F to 140 °F) Operation: -20 °C to 60 °C (-4 °F to 140 °F)
Environmental relative humidity	80% to temperatures up to 31 °C decreasing linearly to 50% RH at 40 °C
Environment: pollution degree	Rated Type 4X and IP66 for outdoor use and is considered pollution degree 2 internally
Altitude	Up to 2,000 m
Sample inlet pressure	140 to 310 kPaG (20 to 45 psig)
Measurement ranges	0 to 500 ppmv (0 to 24 lb/mmscf) 0 to 2000 ppmv (0 to 95 lb/mmscf) 0 to 6000 ppmv (0 to 284 lb/mmscf)
Sample cell operating pressure range	Application dependent 800 to 1200 mbar (standard) 800 to 1700 mbar (optional)
Sample cell tested pressure range	-25 to 689 kPa (-7.25 to 100 psig)

¹ Transient over-voltages according to Over Voltage Category II.

² Sample conditioning system

Item	Description
Sample process temperature	-20 °C to 60 °C (-4 °F to 140 °F)
Sample flow rate	0.5 to 1.0 slpm (1 to 2 scfh)
Bypass flow rate	0.5 to 1.0 slpm (1 to 2 scfh)
Process seal	Dual Seal without Annunciation
Primary process seal 1	UV Grade Fuse Silica Glass
Primary process seal 2	Primary Process Seal 2
Secondary process seal	Elastosil RT 622



12.3 Physical specifications

Item	Description
Weight	J22 TDLAS gas analyzer: 16 kg (36 lbs) J22 TDLAS gas analyzer with SCS¹ on Panel: 24 kg (53 lbs) J22 TDLAS gas analyzer with Enclosed SCS¹: 43 kg (95 lbs) J22 TDLAS gas analyzer with Enclosed SCS¹, Heated: 43 kg (95 lbs)
Dimensions	J22 TDLAS gas analyzer CSA: 727 mm H x 236.2 mm D x 224 mm W (28.6" H x 9.3" D x 8.8" W) ATEX: 727 mm H x 236.2 mm D x 192 mm W (28.6" H x 9.3" D x 7.5" W) J22 TDLAS gas analyzer with SCS¹ on Panel 737 mm H x 241 mm D x 376 mm W (29" H x 9.5" D x 14.8" W) J22 TDLAS gas analyzer with Enclosed SCS¹/ J22 TDLAS gas analyzer with Enclosed SCS¹, Heated 838 mm H x 255 mm D x 406 mm W (33" H x 10" D x 16" W)

12.4 Area classification

Item	Description
J22 TDLAS gas analyzer	<p><u>cCSAus</u>: Ex db ia [ia Ga] op is IIC T4 Gb Class I, Zone 1, AEx db ia [ia Ga] op is IIC T4 Gb Class I, Division 1, Groups A, B, C, D, T4 Tambient = -20 °C to 60 °C (-4 to 140 °F)</p> <p><u>ATEX/IECEX/UKEX</u>: Ex II 2G Ex db ia [ia Ga] ib op is IIC T4 Gb Tambient = -20 °C to 60 °C (-4 to 140 °F)</p> <p><u>IECEX (PESO)</u>: Ex db ia [ia Ga] ib op is IIC T4 Gb</p> <p><u>JPN</u>: Ex db ia [ia Ga] ib op is IIC T4 Gb</p> <p><u>KTL</u>: Ex db ia [ia Ga] ib op is IIC T4 Gb</p> <p><u>INMETRO</u>: Ex db ia [ia Ga] ib op is IIC T4 Gb</p> <p><u>CNEx</u>: Ex db ia [ia Ga] ib op is IIC T4 Gb Tambient = -20 °C to 60 °C (-4 to 140 °F)</p>

¹ Sample conditioning system

Item	Description
J22 TDLAS gas analyzer with SCS ¹ on panel	<p><u>cCSAus</u>: Ex db ia op is IIC T4 Gb Class I, Zone 1, AEx db ia op is IIC T4 Gb Class I, Division 1, Groups A, B, C, D, T4 Tambient = -20 °C to 60 °C (-4 to 140 °F)</p> <p><u>ATEX/IECEX/UKEX</u>:  II 2G Ex db ia ib op is h IIC T4 Gb Tambient = -20 °C to 60 °C (-4 to 140 °F)</p> <p><u>IECEX (PESO)</u>: Ex db ia [ia Ga] ib op is IIC T4 Gb (analyzer) SCS supplied with certified components</p> <p><u>JPN</u>: Ex db ia ib op is IIC T4 Gb</p> <p><u>KTL</u>: Ex db ia ib op is h IIC T4 Gb</p> <p><u>INMETRO</u>: Ex db ia [ia Ga] ib op is IIC T4 Gb</p> <p><u>CNEEx</u>: Ex db ia ib op is h IIC T4 Gb Tambient = -20 °C to 60 °C (-4 to 140 °F)</p>
J22 TDLAS gas analyzer with enclosed SCS ¹	<p><u>cCSAus</u>: Ex db ia op is IIC T4 Gb Class I, Zone 1, AEx db ia op is IIC T4 Gb Class I, Division 1, Groups A, B, C, D, T4 Tambient = -20 °C to 60 °C (-4 to 140 °F)</p> <p><u>ATEX/IECEX/UKEX</u>:  II 2G Ex db ia ib op is h IIC T4 Gb Tambient = -20 °C to 60 °C (-4 to 140 °F)</p> <p><u>IECEX (PESO)</u>: Ex db ia [ia Ga] ib op is IIC T4 Gb (analyzer) SCS supplied with certified components</p> <p><u>JPN</u>: Ex db ia ib op is IIC T4 Gb</p> <p><u>KTL</u>: Ex db ia ib op is h IIC T4 Gb</p> <p><u>INMETRO</u>: Ex db ia [ia Ga] ib op is IIC T4 Gb</p> <p><u>CNEEx</u>: Ex db ia ib op is h IIC T3 Gb Tambient = -20 °C to 60 °C (-4 to 140 °F)</p>
J22 TDLAS gas analyzer with enclosed SCS ¹ , with heater	<p><u>cCSAus</u>: Ex db ia op is IIC T3 Gb Class I, Zone 1, AEx db ia op is IIC T3 Gb Class I, Division 1, Groups B, C, D, T3 Tambient = -20 °C to 60 °C (-4 to 140 °F)</p> <p><u>ATEX/IECEX/UKEX</u>:  II 2G Ex db ia ib op is h IIC T3 Gb Tambient = -20 °C to 60 °C (-4 to 140 °F)</p> <p><u>IECEX (PESO)</u>: Ex db ia [ia Ga] ib op is IIC T4 Gb (analyzer) SCS supplied with certified components</p> <p><u>JPN</u>: Ex db ia ib op is IIC T3 Gb</p> <p><u>KTL</u>: Ex db ia ib op is h IIC T3 Gb</p> <p><u>INMETRO</u>: Ex db ia [ia Ga] ib op is IIC T4 Gb</p> <p><u>CNEEx</u>: Ex db ia ib op is h IIC T3 Gb Tambient = -20 °C to 60 °C (-4 to 140 °F)</p>
Ingress protection	Type 4X, IP66

¹ Sample conditioning system

12.5 Supported operating tools

Supported Operating Tool	Operating Unit	Interface
Web browser	Notebook, PC or tablet with web browser	CDI-RJ45 service interface

12.6 Web server

Thanks to the integrated web server, the device can be operated and configured from a web browser and through a service interface (CDI-RJ45). The structure of the operating menu is the same as for the local display. In addition to the measured values, status information on the device is also displayed and allows the user to monitor the status of the device. Furthermore, the measuring device data can be managed and the network parameters can be configured.

Data exchange between the operating unit (such as a notebook for example) and the measuring device supports the following functions:

- Uploading the configuration from the measuring device (XML format, configuration backup)
- Save the configuration to the measuring device (XML format, restore configuration)
- Export event list (.csv file)
- Export parameter settings (.csv file, create documentation of the measuring point configuration)
- Export the Heartbeat verification log (PDF file, only available with the Heartbeat Verification application package)
- Flash firmware version for device firmware upgrade, for instance

12.7 HistoROM data management

The measuring device features HistoROM data management. HistoROM data management comprises both the storage and import/export of key device and process data, making operation and servicing far more reliable, secure and efficient.

NOTICE

- ▶ When the device is delivered, the factory settings of the configuration data are stored as a backup in the device memory. This memory can be overwritten with an updated data record, for example after commissioning.

Additional information on the data storage concept

There are different types of data storage units in which device data are stored and used by the device, as shown in the table below.

Item	Device Memory	T-DAT	S-DAT
Available data	<ul style="list-style-type: none"> ▪ Event history, such as diagnostic events ▪ Parameter data record backup ▪ Device firmware package 	<ul style="list-style-type: none"> ▪ Measured value memory ▪ Current parameter data record (used by firmware at run time) ▪ Maximum indicators (min/max values) 	<ul style="list-style-type: none"> ▪ Sensor data ▪ Serial number ▪ User-specific access code (to use the Maintenance user role) ▪ Calibration data ▪ Device configuration (e.g., SW options, fixed I/O or multi I/O)
Storage location	Fixed on the User interface board in the connection compartment	Can be plugged into the User interface board in the connection compartment	Fixed in the Optical Head enclosure

12.8 Data backup

12.8.1 Automatic

- The most important device data (sensor and controller) are automatically saved in the DAT modules.
- If the controller or measuring device is replaced: once the T-DAT containing the previous device data has been exchanged, the new measuring device is ready for operation again immediately without any errors.

- If the sensor is replaced: once the sensor has been replaced, new sensor data are transferred from the S-DAT in the measuring device, and the measuring device is ready for operation again immediately without any errors.

12.8.2 Manual

Additional parameter data record (complete parameter settings) in the integrated device memory for:

- Data backup function
- Backup and subsequent restoration of a device configuration in the device memory
- Data comparison function
- Comparison of the current device configuration with the device configuration saved in the device memory

12.9 Manual data transfer

Using the export function from the web server, you can transfer a device configuration to another device to duplicate the configuration or to store in an archive (e.g., for backup purposes).

12.10 Automatic event list

Extended HistoROM application package gives a chronological display of up to 100 event messages in the events list along with a time stamp, plain text description, and remedial measures. The events list can be exported and displayed through a variety of interfaces and operating tools (e.g., web server).

12.11 Manual data logging

Extended HistoROM package provides:

- Record up to 1000 measured values from 1 to 4 channels
- User configurable recording interval
- Record up to 250 measured values from each of the 4 memory channels
- Export the measured value log from a variety of interfaces and operating tools e.g., web server
- Use the recorded measured value data in the integrated device simulation function in the *Diagnostics submenu* → .

12.12 Diagnostics functions

Package	Description
Extended HistoROM	<p>Comprises extended functions concerning the event log and the activation of the measured value memory.</p> <p>Event log: Memory volume is extended from 20 message entries (standard version) to up to 100 entries.</p> <p>Data logging (line recorder):</p> <ul style="list-style-type: none"> ▪ Memory capacity for up to 1000 measured values is activated. ▪ 250 measured values can be output from each of the 4 memory channels. The recording interval can be defined and configured by the user. ▪ Measured value logs can be accessed through the local display or operating tool (e.g., web server).

12.13 Heartbeat Technology

Item	Description
Heartbeat Verification +Monitoring	<p>Heartbeat Monitoring</p> <p>Continuously supplies data, which are characteristic of the measuring principle, to an external condition monitoring system for preventive maintenance or process analysis. These data enable the operator to:</p> <ul style="list-style-type: none"> ▪ Draw conclusions - using these data and other information - about the impact process influences have on the measuring performance over time. ▪ Schedule servicing in time. ▪ Monitor the process or product quality

Item	Description
	<p>Heartbeat Verification</p> <p>Meets the requirement for traceable verification to DIN ISO 9001:2008.</p> <ul style="list-style-type: none"> ▪ Functional testing for standard verification testing in the installed state without interrupting the process. ▪ Traceable verification to validation standard gas with results on request, including a report. ▪ Simple testing process through local operation or web server. ▪ Clear analyte measuring point assessment (pass/fail) with high test coverage within the framework of manufacturer specifications.

Device verification and auto-validation

The J22 TDLAS gas analyzer features auto-validation technology for verification of device functionality without process interruption, using Heartbeat Technology. Heartbeat Technology also enables accurate monitoring for process optimization and predictive maintenance.

Auto-validation relies upon calibration gas of a known concentration value. During auto-validation, process gas flow is blocked with use of a 3-way solenoid valve, which allows calibration gas to flow to the analyzer. A basic illustration of a typical setup is provided below. For J22 auto-validation, all external hardware is customer-supplied.

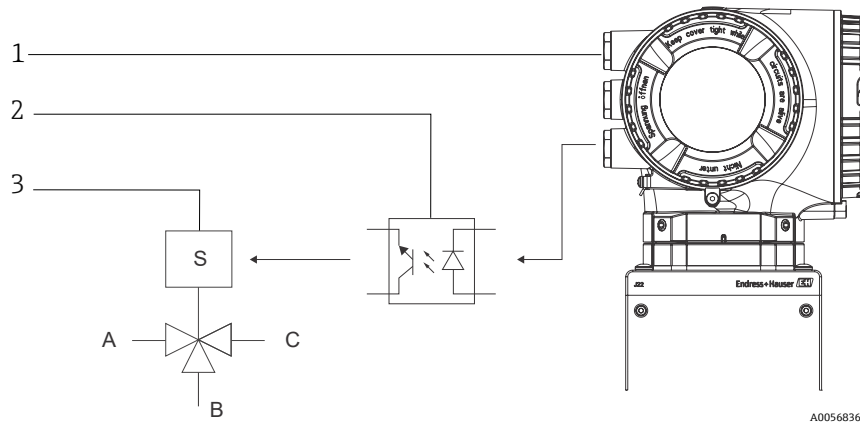

Fig. 87. Simplified diagram of J22 connection IO to 3-way solenoid valve using an external relay

#	Description
1	J22 IO2 or IO3 connected to relay input
2	Relay for powering 3-way solenoid valve*
3	3-way valve for switching process gas to validation gas*

#	Description
A	Process gas inlet
B	Validation gas input
C	Gas outlet to sample conditioning system

* Hardware supplied by others

When using auto-validation, the J22 controls the external solenoid valve automatically through IO2 or IO3. A relay or switch output assigned to either IO2 or IO3 must be configured for this purpose.

The gas concentration value is input into the J22 analyzer through the webserver, Modbus commands, or keypad. The validation measurement is compared with a percent allowance of the gas concentration value to determine a pass or fail. Auto-validation results can be viewed on the webserver, tied to a validation warning alarm, and saved as a Heartbeat Verification report.

For more information on auto-validation, consult your local sales channel. Detailed instructions on Endress+Hauser Heartbeat Technology can be found in the *J22 and JT33 TDLAS gas analyzers Heartbeat Verification + Monitoring application package* (SD02912C). For firmware update information, refer to the *J22 Firmware Upgrade Installation Instructions* (EA01426C).

13 Drawings

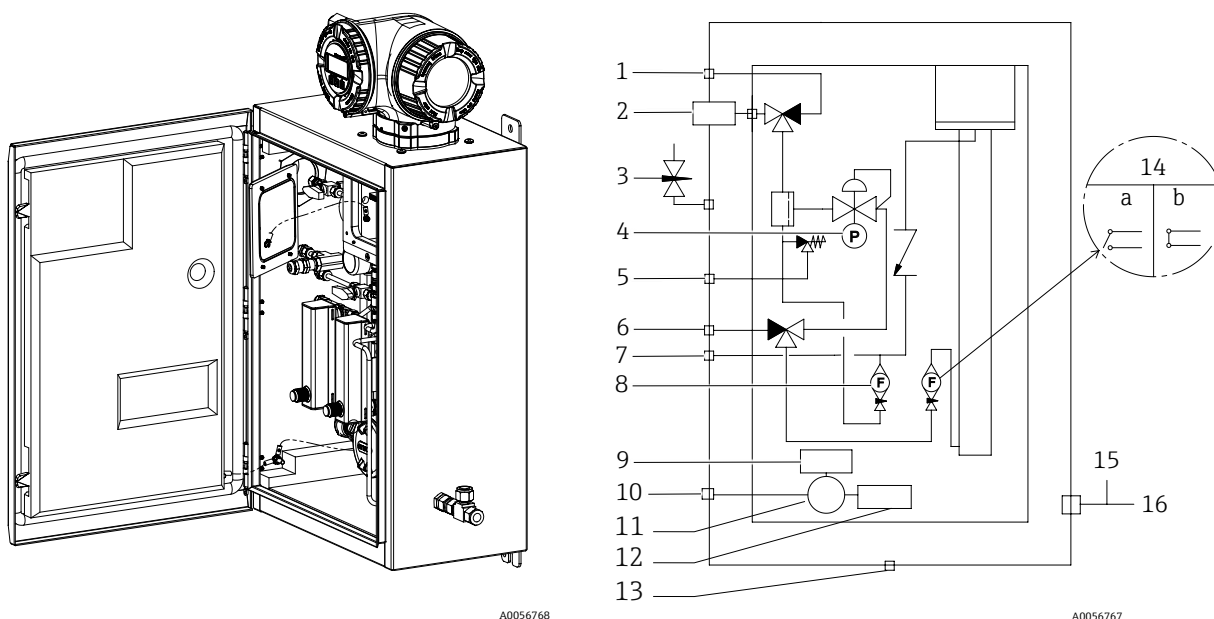

Fig 88. System Connections

#	Description
1	Sample purge, 140 to 310 kPa (20 to 45 psi)
2	Sample supply, 140 to 310 kPa (20 to 45 psi)
3	Enclosure purge
4	Pressure gauge
5	Relief vent (Factory set), 350 kPa
6	Validation inlet, 15-70 kPa (2 to 10 psi)
7	System vent
8	Bypass flow meter

#	Description
9	Heater
10	100 to 240 VAC ± 10 % 50/60 Hz power supply
11	Junction box
12	Thermostat
13	Breather drain
14	Analyzer flow meter with optional flow switch; a) no flow, b) flow
15	Enclosure purge outlet
16	Purge gas measurement port

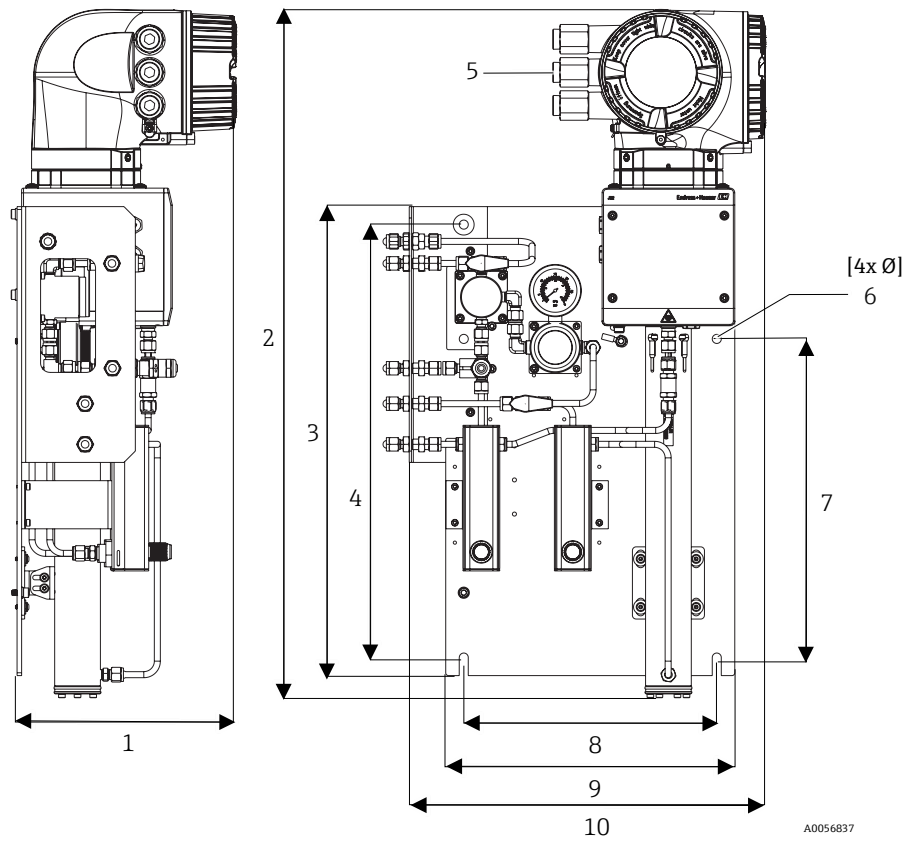

Fig 89. Mounting dimensions, J22 TDLAS gas analyzer with SCS on panel

Dimension	mm	in
1	241	9.5
2	727	28.6
3	495	19.5
4	457	18.0
5 (CSA)	224	8.8
5 (ATEX)	195	7.5
6	10	0.4
7	336	13.2
8	267	10.5
9	330	13.0
10	376	14.8

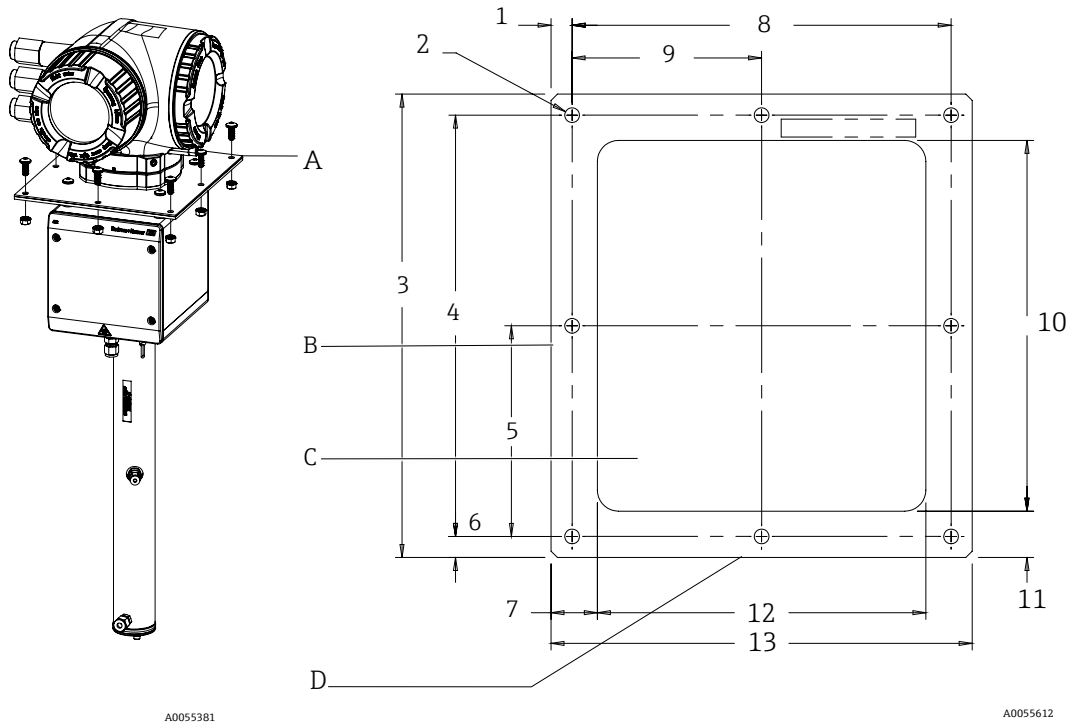

Fig 90. Mounting dimensions, bracket, and hardware for plate-mounted J22 TDLAS gas analyzer

- A Plate mounting bracket and hardware
- B Side
- C Cutout
- D Front

Dimension	mm	in
1	10	0.39
2 (8 holes total)	7	0.28
3	220	8.66
4	200	7.87
5	100	3.94
6	10	0.39
7	22	0.87
8	180	7.09
9	90	3.54
10	176	6.93
11	22	0.87
12	156	6.14
13	200	7.87

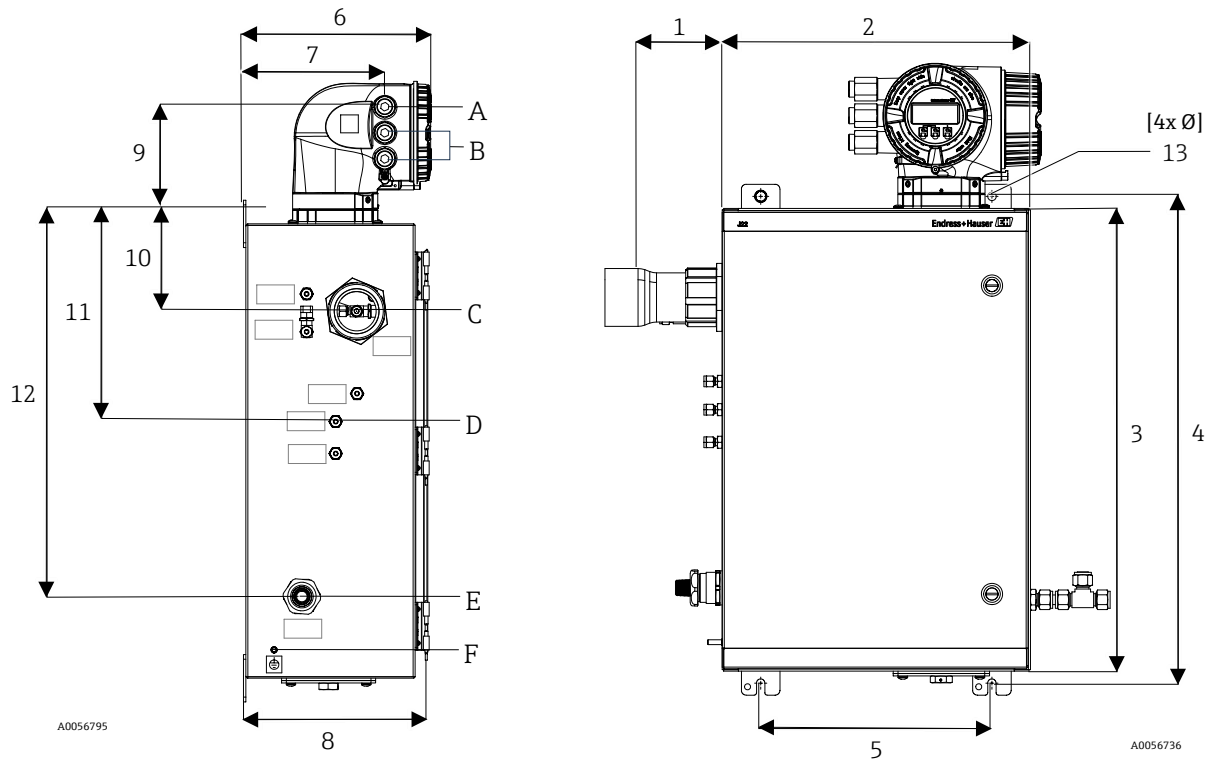

Fig 91. Mounting dimensions, J22 TDLAS gas analyzer with enclosed SCS

A Power in
 B Communication out
 C Gas in

D Gas out
 E Heater power
 F M6 ground stud

Dimension	mm	in
1 *	155	6.1
2	406	16.0
3	610	24.0
4	641	25.3
5	305	12.0
6	282	11.1
7	191	7.5
8	255	10.0
9	141	5.6
10	133	5.2
11	281	11.1
12	516	20.3
13	10	0.4

* Optional

14 Dew point conversion

14.1 Introduction

In the context of TDLAS gas analyzers, water content refers to the concentration of water vapor in the gaseous phase. Water content is typically stated as mole, mass, or volume fraction, which is independent of a reference state, or as mass of water per volume of gas which is dependent on a reference state.

In some instances, it is preferable to express the water content in terms of the water dew point for the gas mixture. The moisture dew point (MDP) is the temperature (in degrees Celsius or Fahrenheit) at which moisture will start to condense into liquid for a given concentration and pressure. Saturation implies that the water vapor is in equilibrium with water in the liquid or solid phase (depending on which is present). When water vapor is in equilibrium with the solid (ice) phase, the dew point is often referred to as the frost point.

TDLAS gas analyzers output their measurements in molar ratio, such as parts per million by volume (ppmv) and parts per billion (ppbv). For moisture measurements, dew point temperature is preferred over concentration to prevent water condensation at process operating temperatures. The MDP is calculated using industry-accepted methods and TDLAS gas analyzers can provide MDP values through the display and through analog and digital communication outputs.

The MDP calculation is always dependent on the moisture concentration (in ppmv) and the pressure at which the MDP is to be calculated (usually the pressure in the process/pipeline). Depending on the calculation method used, the stream composition may also be taken into consideration.

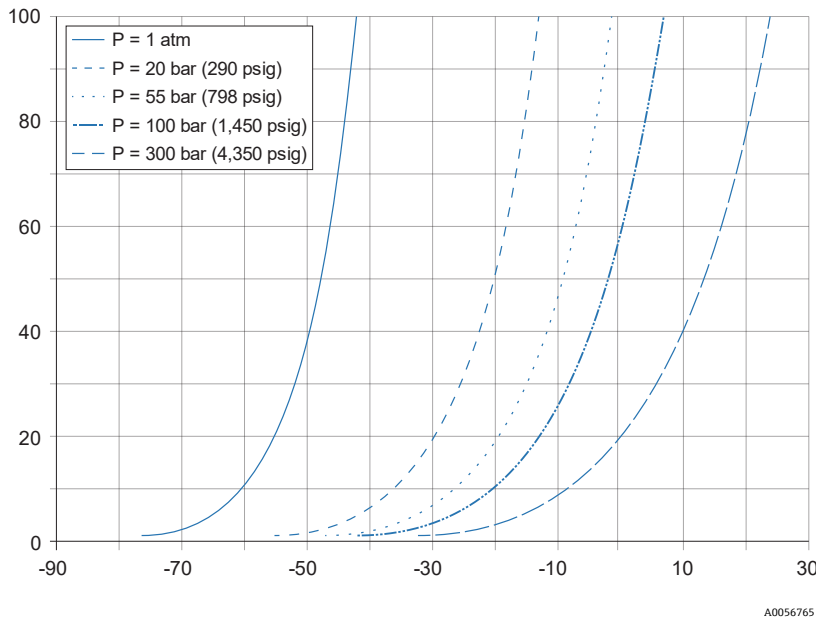

Fig 92. Relationships between the water concentration (ppmv) and MDP (°C) at various pressures

X Dew point (°C)
 Y Water correlation (ppmv) A0056765

NOTICE

► This table is for reference only.

Each line in the graph above represents a different pressure as indicated in the legend. When MDP is required, the pressure must be specified. As gas pressure changes, the MDP for a given concentration will change.

For moisture ranges above about 2 ppmv, the methods are very effective. For lower moisture values, the calculation methods must be extended beyond their stated boundaries which can result in dew point values that are inaccurate, especially at higher pressures and streams with heavy hydrocarbons. For that reason, the molar outputs in ppmv and ppbv will have lower uncertainty.

14.2 MDP calculation

Three methods are described below for calculating moisture dew point that given moisture concentration and process pressure. The methods described are industry-accepted publications that are available from the respective organizations.

14.2.1 Methods for MDP calculation

ASTM D1142

This method has two equations. The equations do not consider stream composition.

- Equation 1 (ASTM1): Range 0 to 100 °F (-18 to 38 °C)
- Equation 2 (ASTM2):
 - Range -40 to 460 °F (-40 to 238 °C)
 - Originally from IGT-8 (1955)

ISO 18453

- Considers stream composition, molar ratios are inputs to the equation.
- Stream composition must be entered into the analyzer.

The ISO 18453 method is applicable to natural gas mixtures with compositions within the limits listed in the table below. Dew point temperatures calculated from water contents were validated to be within ± 2 °C for pressures $0.5 \leq P \leq 10$ MPa and dew point temperatures $258.15 \leq T \leq 278.15$ K [14]. Due to the solid thermodynamic basis on which the method was developed, an extended working range of $0.1 \leq P \leq 30$ MPa and $223.15 \leq T \leq 313.15$ K is also considered valid [10]. Beyond the extended working range, however, the uncertainty in calculated dew point temperature is unknown.

Compound	mol %
Methane (CH ₄)	≥ 40.0
Ethane (C ₂ H ₆)	≤ 20.0
Nitrogen (N ₂)	≤ 55.0
Carbon Dioxide (CO ₂)	≤ 30.0
Propane (C ₃ H ₈)	≤ 4.5
i-Butane (C ₄ H ₁₀)	≤ 1.5
n-Butane (C ₄ H ₁₀)	≤ 1.5
neo-Pentane (C ₅ H ₁₂)	≤ 1.5
i-Pentane (C ₅ H ₁₂)	≤ 1.5
n-Pentane (C ₅ H ₁₂)	≤ 1.5
Hexane/C ₆ + (C ₆ H ₁₄)	≤ 1.5

For moderate to high water contents at low pressures, all three correlations produce acceptable results. Although more difficult to implement, the ISO method is the more accurate method (especially for low water contents and high pressures).

www.addresses.endress.com
