

Description of Device Parameters

Proservo NMS80

Tank Gauging



Table of contents

1	About this document	4
1.1	Document function	4
1.2	Symbols	4
1.3	Documentation	6
2	Overview of the operating menu	7
3	The "Expert" menu	32
3.1	"System" submenu	34
3.2	"Sensor" submenu	59
3.3	"Input/output" submenu	108
3.4	"Communication" submenu	172
3.5	"Application" submenu	215
3.6	"Tank values" submenu	265
3.7	"Diagnostics" submenu	283
Index		314

1 About this document

1.1 Document function

The document is part of the Operating Instructions and serves as a reference for parameters, providing a detailed explanation of each individual parameter of the operating menu.

1.2 Symbols

1.2.1 Safety symbols

DANGER

This symbol alerts you to a dangerous situation. Failure to avoid this situation will result in serious or fatal injury.

WARNING

This symbol alerts you to a dangerous situation. Failure to avoid this situation can result in serious or fatal injury.

CAUTION

This symbol alerts you to a dangerous situation. Failure to avoid this situation can result in minor or medium injury.

NOTICE

This symbol contains information on procedures and other facts which do not result in personal injury.

1.2.2 Electrical symbols



Alternating current



Direct current and alternating current



Direct current



Ground connection

A grounded terminal which, as far as the operator is concerned, is grounded via a grounding system.

Protective earth (PE)

Ground terminals that must be connected to ground prior to establishing any other connections.

The ground terminals are located on the interior and exterior of the device:

- Interior ground terminal: protective earth is connected to the mains supply.
- Exterior ground terminal: device is connected to the plant grounding system.

1.2.3 Tool symbols



Phillips head screwdriver



Flat blade screwdriver



Torx screwdriver



Allen key



Open-ended wrench

1.2.4 Symbols for certain types of information and graphics

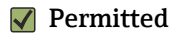

Permitted

Procedures, processes or actions that are permitted



Preferred

Procedures, processes or actions that are preferred



Forbidden

Procedures, processes or actions that are forbidden



Tip

Indicates additional information



Reference to documentation



Reference to graphic



Notice or individual step to be observed

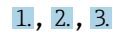

Series of steps



Result of a step



Visual inspection



Operation via operating tool



Write-protected parameter

1, 2, 3, ...

Item numbers

A, B, C, ...

Views



Safety instructions

Observe the safety instructions contained in the associated Operating Instructions



Temperature resistance of the connection cables

Specifies the minimum value of the temperature resistance of the connection cables

1.3 Documentation

The following documentation types are available in the Downloads area of the Endress+Hauser website (www.endress.com/downloads):

 For an overview of the scope of the associated Technical Documentation, refer to the following:

- *Device Viewer* (www.endress.com/deviceviewer): Enter the serial number from the nameplate
- *Endress+Hauser Operations app*: Enter serial number from nameplate or scan matrix code on nameplate.

1.3.1 Technical Information (TI)

Planning aid

The document contains all the technical data on the device and provides an overview of the accessories and other products that can be ordered for the device.

1.3.2 Brief Operating Instructions (KA)

Guide that takes you quickly to the 1st measured value

The Brief Operating Instructions contain all the essential information from incoming acceptance to initial commissioning.

1.3.3 Operating Instructions (BA)

The Operating Instructions contain all the information that is required in various phases of the life cycle of the device: from product identification, incoming acceptance and storage, to mounting, connection, operation and commissioning through to troubleshooting, maintenance and disposal.

It also contains a detailed explanation of each individual parameter in the operating menu (except the **Expert** menu). The description is aimed at those who work with the device over the entire life cycle and perform specific configurations.

1.3.4 Description of Device Parameters (GP)

The Description of Device Parameters provides a detailed explanation of each individual parameter in the 2nd part of the operating menu: the **Expert** menu. It contains all the device parameters and allows direct access to the parameters by entering a specific code. The description is aimed at those who work with the device over the entire life cycle and perform specific configurations.

1.3.5 Safety Instructions (XA)

Depending on the approval, the following Safety Instructions (XA) are supplied with the device. They are an integral part of the Operating Instructions.

 The nameplate indicates the Safety Instructions (XA) that are relevant to the device.



















1.3.6 Installation instructions (EA)

Installation Instruction are used to replace a faulty unit with a functioning unit of the same type.

























2 Overview of the operating menu

- i
 - The following table lists all parameters the **Expert** menu (→  7) may contain. The page number refers to where a description of the parameter can be found.
 - Depending on the device version and parametrization some parameters will not be available in a given situation. For details on the conditions refer to the "Prerequisite" category in the description of the respective parameter.
 - The representation essentially corresponds to the menu seen when using an operating tool (e.g. FieldCare). On the local display there may be minor differences in the menu structure. Details are mentioned in the description of the respective submenu.

Navigation  Expert

 Expert		
Locking status		→  32
Access status display		→  33
User role		→  33
Enter access code		→  33
▶ System		→  34
	▶ Display	→  35
	Language	→  35
	Format display	→  36
	Value 1 to 4 display	→  37
	Decimal places 1 to 4	→  38
	Separator	→  39
	Number format	→  39
	Header	→  39
	Header text	→  40
	Display interval	→  40
	Display damping	→  41
	Backlight	→  41
	Contrast display	→  41

























▶ System units	→ 42
Units preset	→ 42
Distance unit	→ 43
Pressure unit	→ 43
Temperature unit	→ 43
Density unit	→ 44
Decimal places length	→ 44
Decimal places pressure	→ 44
Decimal places temperature	→ 45
Decimal places density	→ 45
▶ Date / time	→ 49
Date/time	→ 50
Set date	→ 50
Year	→ 50
Month	→ 51
Day	→ 51
Hour	→ 51
Minute	→ 52
▶ Administration	→ 55
Define access code	→ 56
Activate SW option	→ 56
Software option overview	→ 56
Device reset	→ 57
▶ Sensor	→ 59
Gauge command (8000)	→ 59

Gauge status (8081)	→  60
Distance (8103)	→  60
► Information	→  61
Gross weight (8080)	→  61
Net weight (8007)	→  61
Gauge status (8081)	→  62
Active gauge command (8073)	→  62
Balance flag (8006)	→  62
Displacer status (8160)	→  62
Motor status (8118)	→  63
One-time command status (8201)	→  63
Sensor temperature (8066)	→  63
Detector temperature (8090)	→  63
► Measured values	→  64
Distance (8103)	→  65
Displacer position (8130)	→  65
Liquid level (8072)	→  66
Upper interface level (8127)	→  66
Upper interface level timestamp (8055)	→  66
Lower interface level (8128)	→  66
Lower interface level timestamp (8061)	→  67
Bottom level (8129)	→  67
Bottom level timestamp (8048)	→  67
► Spot density	→  68
Measured upper density (8164)	→  68

Upper density timestamp (8067)	→ 68
Measured middle density (8165)	→ 68
Middle Density Timestamp (8011)	→ 69
Measured lower density (8166)	→ 69
Lower density timestamp (8122)	→ 69
► Profile density	→ 70
Profile point (8170)	→ 70
Profile average density (8175)	→ 70
Profile density timestamp (8114)	→ 70
► Sensor diag	→ 72
► Start self check	→ 72
Status self check (8192)	→ 72
► Self check	→ 72
► Sensor config	→ 74
Post gauge command (8163)	→ 74
► Displacer	→ 75
Displacer type (8071)	→ 75
Displacer diameter (8014)	→ 75
Displacer weight (8010)	→ 76
Displacer volume (8008)	→ 76
Displacer balance volume (8009)	→ 76
Displacer height (8195)	→ 77
Immersion depth (8070)	→ 77

▶ Wiredrum	→ 78
Drum circumference (8082)	→ 78
Wire weight (8040)	→ 78
▶ Safety settings	→ 79
High stop level (8135)	→ 79
Low stop level (8069)	→ 79
Slow hoist zone (8084)	→ 80
Overtension weight (8097)	→ 80
Undertension weight (8098)	→ 80
Output out of range (8218)	→ 81
Monitoring counter (8078)	
Last monitoring (8104)	
▶ Level settings	→ 82
Upper density (8113)	→ 82
Middle density (8041)	→ 82
Lower density (8042)	→ 83
Process condition (8001)	→ 83
Standby level (8194)	→ 83
Offset standby distance (8107)	→ 84
▶ Balance settings	→ 86
Level measurement mode (8056)	→ 86
Interface measurement mode (8064)	→ 87
Balancing waiting time (8205)	→ 87
Seek delay (8162)	→ 88
Weight tolerance (8213)	→ 88

























▶ Spot density	→ 90
Upper density offset (8176)	→ 90
Middle density offset (8177)	→ 90
Lower density offset (8178)	→ 91
Submersion depth (8169)	→ 91
▶ Profile density	→ 92
Density measurement mode (8186)	→ 92
Manual profile level (8182)	→ 92
Profile density offset distance (8185)	→ 93
Profile density interval (8174)	→ 93
Profile density offset (8173)	→ 93
▶ Calibration	→ 94
▶ Move displacer	→ 95
Move distance	→ 95
Move displacer	→ 96
Motor status (8118)	→ 96
Move displacer	→ 96
Distance (8103)	→ 95
Motor status (8118)	→ 96
▶ Sensor calibration	→ 97
Sensor calibration	→ 97
Offset weight (8095)	→ 97
Span weight (8096)	→ 98
Zero calibration	→ 98
Zero calibration	→ 98

Calibration status (8031)	→  98
Offset calibration	→  99
Offset calibration	→  99
Calibration status (8031)	→  98
Span calibration	→  99
Span calibration	→  99
Calibration status (8031)	→  98
Sensor calibration	→  97
Calibration status (8031)	→  98
► Reference calibration	→  100
Reference calibration	→  100
Reference position (8046)	→  100
Progress	→  100
Progress	→  100
Calibration status (8031)	→  101
Reference calibration	→  100
Calibration status (8031)	→  101
► Drum calibration	→  102
Make sure to have	→  102
Drum calibration	→  102
Calibration time	→  103
Set high weight (8116)	→  103
Make drum table	→  103
Calibration time	→  103
Drum table point	→  103

























Calibration status (8031)	→	📄	104
Make low table	→	📄	104
Set low weight (8115)	→	📄	104
Make drum table	→	📄	103
Calibration time	→	📄	103
Drum table point	→	📄	103
Calibration status (8031)	→	📄	104
Drum calibration	→	📄	102
Calibration status (8031)	→	📄	104
► Calibration parameters	→	📄	105
Set high weight (8116)	→	📄	105
Set low weight (8115)	→	📄	105
Reference position (8046)	→	📄	106
Offset weight (8095)	→	📄	106
Span weight (8096)	→	📄	106
Calibration status (8031)	→	📄	107
► Input/output	→	📄	108
► HART devices	→	📄	109
Number of devices	→	📄	109
► HART Device(s)	→	📄	110
Device name	→	📄	111
Polling address	→	📄	111
Device tag	→	📄	111
Operating mode	→	📄	111
Communication status	→	📄	112

Status signal	→ 📄 112
#blank#(HART PV - description dependent on device)	→ 📄 113
#blank#(HART SV - description dependent on device)	→ 📄 113
#blank#(HART TV - description dependent on device)	→ 📄 113
#blank#(HART QV - description dependent on device)	→ 📄 113
HART device PV mA	→ 📄 114
HART device PV %	→ 📄 114
Output pressure	→ 📄 114
Output density	→ 📄 115
Output temperature	→ 📄 115
Output vapor temperature	→ 📄 115
Output level	→ 📄 116
▶ HART device information	→ 📄 117
▶ Element values	→ 📄 123
▶ Diagnostics	→ 📄 124
▶ Diagnostics	→ 📄 125
▶ NMT device config	→ 📄 127
▶ NMT device config	→ 📄 133
▶ Forget device	→ 📄 138
Forget device	→ 📄 138
▶ #blank#	→ 📄 138
Operating mode	→ 📄 139
Current	→ 📄 139

▶ Analog IP	→ 140
Operating mode	→ 141
RTD type	→ 141
Ohms offset	→ 142
Thermocouple type	→ 142
RTD connection type	→ 143
Process value	→ 143
Process variable	→ 143
0 % value	→ 144
100 % value	→ 144
Input value percent	→ 144
Input value	→ 145
Temperature offset after conversion	→ 145
Minimum probe temperature	→ 145
Maximum probe temperature	→ 146
Probe position	→ 146
Calibration type AIP	→ 147
Active calibration	→ 147
Damping factor	→ 147
Gauge current	→ 148
▶ Analog I/O	→ 149
Operating mode	→ 150
Current span	→ 151
Fixed current	→ 152
Analog input source	→ 152

Failure mode	→  153
Error value	→  154
Output out of range	→  154
Error on event	→  154
Input value	→  155
0 % value	→  155
100 % value	→  155
Input value %	→  156
Output value	→  156
Readback value	→  156
Feedback threshold	→  157
Process variable	→  157
Analog input 0% value	→  157
Analog input 100% value	→  158
Error event type	→  158
Process value	→  158
Input value in mA	→  159
Input value percent	→  159
Damping factor	→  159
Calibration	→  160
Active calibration	→  160
Used for SIL/WHG	→  160
► Digital Xx-x	→  162
Operating mode	→  163
Digital input source	→  163

























Input value	→ 164
Contact type	→ 164
Output simulation	→ 165
Output value	→ 166
Readback value	→ 166
Error on event	→ 166
Damping factor	→ 167
Used for SIL/WHG	→ 167
► Digital input mapping	→ 168
Digital input source 1	→ 168
Digital input source 2	→ 168
Gauge command 0	→ 169
Gauge command 1	→ 170
Gauge command 2	→ 170
Gauge command 3	→ 171
► Communication	→ 172
► "Modbus Xx-x" / "V1 Xx-x" / WM550 submenu	
Communication interface protocol	→ 174
Modbus value 1 to 4	→ 174
Modbus discrete 1 to 4	→ 174
► Configuration	→ 175
Baudrate	→ 175
Parity	→ 176
Modbus address	→ 176

























Float swap mode	→  176
Invalid data	→  177
Word type	→  177
CRC seed	→  178
Old TSM mode	→  178
Bus termination	→  178
Compatibility mode	→  179
► Integer conversion	→  180
Level 0%	→  180
Level 100%	→  181
Temperature 0%	→  181
Temperature 100%	→  181
Pressure 0%	→  182
Pressure 100%	→  182
Density 0%	→  182
Density 100%	→  183
User 0%	→  183
User 100%	→  183
Percent 0%	→  184
Percent 100%	→  184
► User value source	→  185
User value 1 to 8 source	→  185
► GP values	→  186
GP 1 value 0%	→  186
GP 1 value 100%	→  186

GP 2 value 0%	→ 187
GP 2 value 100%	→ 187
GP 3 value 0%	→ 187
GP 3 value 100%	→ 188
GP 4 value 0%	→ 188
GP 4 value 100%	→ 188
► Discrete selector	→ 189
Discrete 1 to 8 selector	→ 189
► Configuration	→ 190
Communication interface protocol variant	→ 190
V1 address(V1 / MDP)	→ 190
V1 address(BBB / MIC+232)	→ 191
Level mapping	→ 191
Line impedance	→ 192
Compatibility mode	→ 192
► V1 input selector	→ 193
User value 1 to 8 source	→ 193
Alarm 1 input source	→ 194
Alarm 2 input source	→ 194
Alarm 3 input source	→ 195
Alarm 4 input source	→ 195
SP 1 value selector	→ 196
SP 2 value selector	→ 196
SP 3 value selector	→ 197

SP 4 value selector	→ 197
Value percent selector	→ 198
► Configuration	→ 198
Baudrate	→ 198
WM550 address	→ 199
Software ID	→ 199
Compatibility mode	→ 199
► WM550 input selector	→ 200
Discrete 1 to 4 selector (13260-1 to 4)	→ 200
► HART output	→ 201
► HART configuration	→ 202
System polling address	→ 202
No. of preambles	→ 203
PV source	→ 203
Assign PV	→ 203
0 % value	→ 204
100 % value	→ 205
PV mA selector	→ 205
Primary variable (PV)	→ 205
Percent of range	→ 206
Assign SV	→ 206
Secondary variable (SV)	→ 207
Assign TV	→ 207
Tertiary variable (TV)	→ 208

























Assign QV	→ 208
Quaternary variable (QV)	→ 209
► Information	→ 210
HART short tag	→ 210
Device tag	→ 211
Device revision	→ 211
Device ID	→ 211
Device type	→ 212
Manufacturer ID	→ 212
HART revision	→ 212
HART descriptor	→ 213
HART message	→ 213
Hardware revision	→ 213
Software revision	→ 214
HART date code	→ 214
► Application	→ 215
► Tank configuration	→ 215
Process condition (8001)	→ 215
► Level	→ 217
Level source (14601)	→ 217
Empty (14602)	→ 218
Tank reference height (14603)	→ 218
Tank level (14655)	→ 218
Set level (14604)	→ 219
Upper interface level (15003)	→ 219

Lower interface level (15004)	→  219
Water level source (14971)	→  219
Water level (14970)	→  220
Manual water level (14959)	→  220
► Temperature	→  221
Liquid temp source	→  221
Manual liquid temperature	→  222
Liquid temperature	→  222
Air temperature source	→  222
Manual air temperature	→  223
Air temperature	→  223
Vapor temp source	→  223
Manual vapor temperature	→  224
Vapor temperature	→  224
► Density	→  225
Observed density source (13454)	→  225
Observed density (13452)	→  226
Air density (14980)	→  226
Vapor density (14981)	→  226
Measured upper density (15001)	→  226
Measured middle density (14997)	→  227
Measured lower density (15002)	→  227
Water density (13757)	→  227
Profile point (8170)	→  227

























Profile average density (8175)	→  228
Profile density timestamp (8114)	→  228
► Pressure	→  229
P1 (bottom) source	→  230
P1 (bottom)	→  230
P1 (bottom) manual pressure	→  230
P1 position	→  231
P1 offset	→  231
P1 absolute / gauge	→  231
P2 (middle) source	→  232
P2 (middle)	→  232
P2 (middle) manual pressure	→  232
P2 offset	→  233
P1-2 distance	→  233
P2 absolute / gauge	→  233
P3 (top) source	→  234
P3 (top)	→  234
P3 (top) manual pressure	→  234
P3 position	→  235
P3 offset	→  235
P3 absolute / gauge	→  235
Ambient pressure	→  236
► GP values	→  237
GP 1 to 4 source (14989-1 to 4)	→  237
GP 1 to 4 name (14963-1 to 4)	→  238





















	GP Value 1 (14966)	→ 238
	GP Value 2 (14967)	→ 238
	GP Value 3 (14968)	→ 238
	GP Value 4 (14969)	→ 239
	▶ Tank calculation	→ 239
	Local gravity	→ 239
	▶ HyTD	→ 242
	HyTD correction value	→ 242
	HyTD mode	→ 242
	Starting level	→ 242
	Deformation factor	→ 243
	▶ CTSh	→ 247
	CTSh correction value	→ 247
	CTSh mode	→ 248
	Covered tank	→ 248
	Stilling well	→ 248
	Calibration temperature	→ 249
	Linear expansion coefficient	→ 249
	▶ HTMS	→ 252
	HTMS mode	→ 252
	Manual density	→ 253
	Density value	→ 253
	Minimum level	→ 253
	Minimum pressure	→ 254
	Safety distance	→ 254

	Hysteresis	→ 254
	Water density	→ 255
▶ Alarm		→ 256
▶ Alarm		→ 256
	Alarm mode	→ 257
	Error value	→ 258
	Alarm value source	→ 259
	Alarm value	→ 260
	HH alarm value	→ 260
	H alarm value	→ 260
	L alarm value	→ 261
	LL alarm value	→ 261
	HH alarm	→ 261
	H alarm	→ 262
	HH+H alarm	→ 262
	L alarm	→ 262
	LL alarm	→ 262
	LL+L alarm	→ 263
	Any error	→ 263
	Clear alarm	→ 263
	Alarm hysteresis	→ 264
	Damping factor	→ 264
▶ Tank values		→ 265
	Net weight (8007)	→ 265
	Gauge status (8081)	→ 265

Balance flag (8006)	→  266
Offset standby distance (8107)	→  267
Standby level (8194)	→  266
One-time command status (8201)	→  268
► Level	→  268
Tank level	→  269
Tank Level %	→  269
Tank ullage	→  270
Tank ullage %	→  270
Upper interface level	→  270
Upper interface level timestamp (8055)	→  270
Lower interface level	→  271
Lower interface level timestamp (8061)	→  271
Bottom level	→  271
Bottom level timestamp (8048)	→  271
Water level	→  272
Measured level	→  272
Distance (8103)	→  272
Displacer position (15019)	→  272
► Temperature	→  273
Liquid temperature	→  273
Vapor temperature	→  273
Air temperature	→  274
► NMT element values	→  274

▶ Element temperature	→ 📄 274
▶ Element position	→ 📄 274
▶ Density	→ 📄 276
Observed density	→ 📄 276
Observed density temperature	→ 📄 277
Vapor density	→ 📄 277
Air density	→ 📄 277
Measured upper density	→ 📄 277
Upper density timestamp (8067)	→ 📄 278
Measured middle density	→ 📄 278
Middle Density Timestamp (8011)	→ 📄 278
Measured lower density	→ 📄 278
Lower density timestamp (8122)	→ 📄 279
▶ Profile density	→ 📄 279
Profile density @instance (8068-1 to 50)	→ 📄 279
Profile density position @instance (8077-1 to 50)	→ 📄 279
▶ Pressure	→ 📄 280
P1 (bottom)	→ 📄 280
P3 (top)	→ 📄 280
▶ GP values	→ 📄 281
GP 1 to 4 name (14963-1 to 4)	→ 📄 281
GP Value 1 (14966)	→ 📄 281
GP Value 2 (14967)	→ 📄 281













GP Value 3 (14968)	→  282
GP Value 4 (14969)	→  282
► Diagnostics	→  283
Actual diagnostics	→  285
Timestamp	→  286
Previous diagnostics	→  286
Timestamp	→  287
Operating time from restart	→  287
Operating time	→  287
Date/time	→  287
► Diagnostic list	→  288
Diagnostics 1 to 5 (0692-1 to 5)	→  288
Timestamp 1 to 5 (0683-1 to 5)	→  288
► Simulation	→  290
Device alarm simulation	→  290
Diagnostic event simulation	→  290
Simulation distance on (8002)	→  291
Simulation distance (8003)	→  291
Current output 1 to 2 simulation	→  291
Simulation value	→  292
► Device information	→  293
Device tag	→  293
Serial number	→  294
Firmware version	→  294
Firmware CRC	→  294

Weight and measures configuration CRC	→  294
Device name	→  295
Order code	→  295
Extended order code 1 to 3 (0023-1 to 3)	→  295
ENP version	→  295
Device type	→  296
Build version	→  296
Module type	→  296
Communication Slot	→  296
Recovery state	→  297
▶ Board info	→  298
Date/time	→  298
System temperature	→  298
W&M lock switch	→  298
▶ Data logging	→  300
Assign channel 1 to 4 (0851-1 to 4)	→  301
Logging interval	→  302
Clear logging data	→  303
▶ Device check	→  305
▶ Commissioning check	→  306
Commissioning check	→  306

Result drum check (8155)	→ 306
Step X / 11 (8143)	→ 306
► Commissioning parameter	→ 307
Step X / 11 (8143)	→ 307
Result drum check (8155)	→ 307
Displacer weight tolerance (8161)	→ 307
Reference calibration incomplete (8157)	→ 308
► LRC	→ 309
► LRC 1 to 2	→ 309
LRC Mode	→ 309
Allowed difference	→ 309
Check fail threshold	→ 310
Reference level source	→ 310
Reference switch source	→ 311
Reference switch mode	→ 311
Reference level	→ 311
Reference switch level	→ 312
Reference switch state	→ 312
Check level	→ 312
Check status	→ 313
Check timestamp	→ 313

3 The "Expert" menu

Navigation  Expert

 Expert	
Locking status	→  32
Access status display	→  33
User role	→  33
Enter access code	→  33
▶ System	→  34
▶ Sensor	→  59
▶ Input/output	→  108
▶ Communication	→  172
▶ Application	→  215
▶ Tank values	→  265
▶ Diagnostics	→  283

Locking status

Navigation   Expert → Locking status (0004)

Description Indicates the type of locking.

"Hardware locked" (HW)
The device is locked by the "WP" switch on the main electronics module. To unlock, set the switch into the OFF position.

"WHG locked" (SW)
Unlock the device by entering the appropriate access code in "Enter access code".

"SIL locked" (SW)
Unlock the device by entering the appropriate access code in "Enter access code".



"Temporarily locked" (SW)
The device is temporarily locked by processes in the device (e.g. data upload/download, reset). The device will automatically be unlocked after completion of these processes.

Additional information

Read access	Operator
Write access	-

Access status display

Navigation

  Expert → Access stat.disp (0091)

Prerequisite



The device has a local display.



Description

Indicates access authorization to parameters via local display.

Additional information

Read access	Operator
Write access	-

 The access authorization can be changed via the **Enter access code** parameter (→  33).

 If an additional write protection is active, this restricts the current access authorization even further. The write protection status can be viewed via the **Locking status** parameter (→  32).

User role

Navigation

 Expert → User role (0005)

Description



Shows the access authorization to the parameters via the operating tool

Additional information

Read access	Operator
Write access	-

Enter access code

Navigation

  Expert → Ent. access code (0003)

Description





Enter access code to disable write protection of parameters.

Additional information

Read access	Operator
Write access	Operator













3.1 "System" submenu

Navigation  Expert → System

▶ System	
▶ Display	→  35
▶ System units	→  42
▶ Date / time	→  49
▶ Administration	→  55

3.1.1 "Display" submenu

Navigation  Expert → System → Display

▶ Display	
Language	→  35
Format display	→  36
Value 1 to 4 display	→  37
Decimal places 1 to 4	→  38
Separator	→  39
Number format	→  39
Header	→  39
Header text	→  40
Display interval	→  40
Display damping	→  41
Backlight	→  41
Contrast display	→  41

Language

Navigation	 Expert → System → Display → Language (0104)
Prerequisite	The device has a local display.
Description	Set display language.
Selection	<ul style="list-style-type: none"> ■ English ■ Deutsch ■ русский язык (Russian) ■ 日本語 (Japanese) ■ Español ■ 中文 (Chinese)
Factory setting	English

Additional information

Read access	Operator
Write access	Operator

Format display

Navigation

Expert → System → Display → Format display (0098)

Prerequisite

The device has a local display.

Description

Select how measured values are shown on the display.

Selection

- 1 value, max. size
- 1 bargraph + 1 value
- 2 values
- 1 value large + 2 values
- 4 values

Factory setting

2 values

Additional information

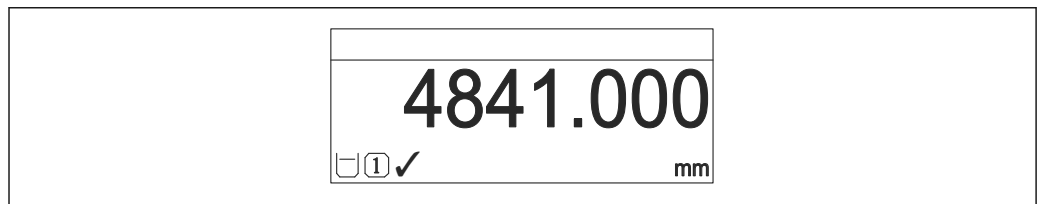

A0019963

1 "Format display" = "1 value, max. size"

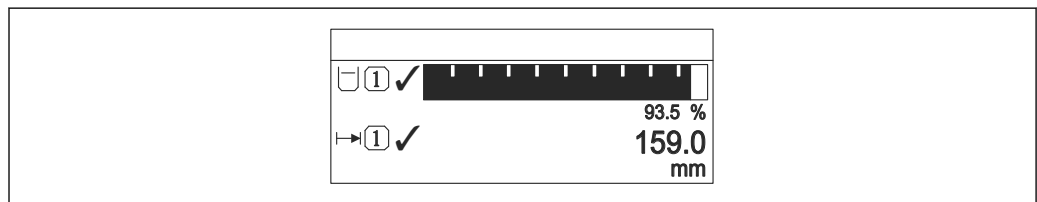

A0019964

2 "Format display" = "1 bargraph + 1 value"

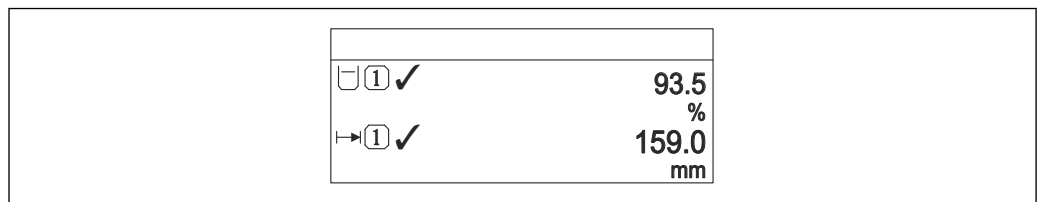

A0019965

3 "Format display" = "2 values"

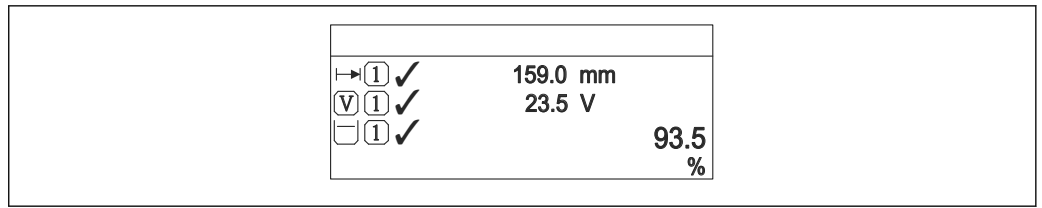

A0019966

4 "Format display" = "1 value large + 2 values"

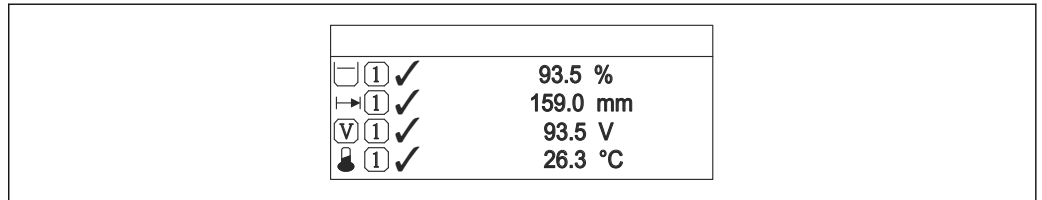

A0019966

5 "Format display" = "4 values"

Read access	Operator
Write access	Operator

- The **Value 1 to 4 display** (→ 37) parameters specify which measured values are shown on the display and in which order.
- If more measured values are specified than the current display mode permits, the values alternate on the device display. The display time until the next change is configured in the **Display interval** parameter (→ 40).

Value 1 to 4 display



Navigation Expert → System → Display → Value 1 display (0107)

Prerequisite The device has a local display.

Description Select the measured value that is shown on the local display.

- Selection**
- None ¹⁾
 - Tank level
 - Measured level
 - Level linearized
 - Tank level %
 - Water level ¹⁾
 - Liquid temperature ¹⁾
 - Vapor temperature ¹⁾
 - Air temperature ¹⁾
 - Tank ullage
 - Tank ullage %
 - Observed density value ¹⁾
 - P1 (bottom) ¹⁾
 - P2 (middle) ¹⁾
 - P3 (top) ¹⁾

1) not available for the **Value 1 display** parameter

- GP 1 value ¹⁾
- GP 2 value ¹⁾
- GP 3 value ¹⁾
- GP 4 value ¹⁾
- Gauge command ¹⁾
- Gauge status ¹⁾
- AIO B1-3 value ¹⁾
- AIO B1-3 value mA ¹⁾
- AIO B1-3 value % ¹⁾
- AIO C1-3 value ¹⁾
- AIO C1-3 value mA ¹⁾
- AIO C1-3 value % ¹⁾
- AIP B4-8 value ¹⁾
- AIP B4-8 value mA ¹⁾
- AIP B4-8 value % ¹⁾
- AIP C4-8 value ¹⁾
- AIP C4-8 value mA ¹⁾
- AIP C4-8 value % ¹⁾

Factory setting

Depending on device version

Additional information

Read access	Operator
Write access	Maintenance

Decimal places 1 to 4



Navigation

Expert → System → Display → Decimal places 1 (0095)

Prerequisite

The device has a local display.

Description

This selection does not affect the measurement and calculation accuracy of the device.

Selection

- x
- x.x
- x.xx
- x.xxx
- x.xxxx

Factory setting

x.x

Additional information

The setting does not affect the measuring or computational accuracy of the device.

Read access	Operator
Write access	Maintenance

Separator



- Navigation** Expert → System → Display → Separator (0101)
- Prerequisite** The device has a local display.
- Description** Select decimal separator for displaying numerical values.
- Selection**
 - .
 - ,
- Factory setting** .

Additional information

Read access	Operator
Write access	Maintenance

Number format



- Navigation** Expert → System → Display → Number format (0099)
- Prerequisite** The device has a local display.
- Description** Choose number format for the display.
- Selection**
 - Decimal
 - ft-in-1/16"
- Factory setting** Decimal

Additional information

Read access	Operator
Write access	Maintenance

The **ft-in-1/16"** option is only valid for distance values.

Header



- Navigation** Expert → System → Display → Header (0097)
- Prerequisite** The device has a local display.
- Description** Select header contents on local display.
- Selection**
 - Device tag
 - Free text
- Factory setting** Device tag

Additional information

Read access	Operator
Write access	Maintenance

Meaning of the options

- **Device tag**

The header contents is defined in the **Device tag** parameter (→  211).

- **Free text**

The header contents is defined in the **Header text** parameter (→  40).

Header text**Navigation**

  Expert → System → Display → Header text (0112)

Prerequisite

Header (→  39) = **Free text**

Description

Enter display header text.

User entry

Character string comprising numbers, letters and special characters (11)

Factory setting

TG-Platform

Additional information

Read access	Operator
Write access	Maintenance

Display interval**Navigation**

  Expert → System → Display → Display interval (0096)

Description

Set time measured values are shown on display if display alternates between values.

User entry

1 to 10 s

Factory setting

5 s

Additional information

 This parameter is only relevant if the number of selected measuring values exceeds the number of values the selected display format can display simultaneously.

Read access	Operator
Write access	Operator

Display damping



- Navigation** Expert → System → Display → Display damping (0094)
- Prerequisite** The device has a local display.
- Description** Set display reaction time to fluctuations in the measured value.
- User entry** 0.0 to 999.9 s
- Factory setting** 0.0 s

Additional information

Read access	Operator
Write access	Maintenance

Backlight

- Navigation** Expert → System → Display → Backlight (0111)
- Prerequisite** The device has a local display.
- Description** Switch the local display backlight on and off.
- Selection**
 - Disable
 - Enable
- Factory setting** Enable

Additional information

Read access	Operator
Write access	Operator

Contrast display

- Navigation** Expert → System → Display → Contrast display (0105)
- Prerequisite** The device has a local display.
- Description** Adjust local display contrast setting to ambient conditions (e.g. lighting or reading angle)
- User entry** 20 to 80 %
- Factory setting** 30 %









Additional information

Read access	Operator
Write access	Operator

3.1.2 "System units" submenu

Navigation  Expert → System → System units

▶ System units

Units preset	→  42
Distance unit	→  43
Pressure unit	→  43
Temperature unit	→  43
Density unit	→  44
Decimal places length	→  44
Decimal places pressure	→  44
Decimal places temperature	→  45
Decimal places density	→  45

Units preset

Navigation

 Expert → System → System units → Units preset (0605)

Description

Defines a set of units for length, pressure and temperature.

Selection

- mm, bar, °C
- m, bar, °C
- mm, PSI, °C
- ft, PSI, °F
- ft-in-16, PSI, °F
- ft-in-8, PSI, °F
- Customer value



Factory setting

mm, bar, °C

Additional information

Read access	Operator
Write access	Maintenance

If the **Customer value** option is selected, the units are defined in the following parameters. In any other case these are read-only parameters used to indicate the respective unit:

- Distance unit (→  43)
- Pressure unit (→  43)
- Temperature unit (→  43)

Distance unit



Navigation Expert → System → System units → Distance unit (0551)

Description Select distance unit.

Selection

<p><i>SI units</i></p> <ul style="list-style-type: none"> ■ m ■ mm ■ cm 	<p><i>US units</i></p> <ul style="list-style-type: none"> ■ ft ■ in ■ ft-in-16 ■ ft-in-8
--	--

Factory setting mm

Additional information

Read access	Operator
Write access	Maintenance (if Units preset (→ 42) = Customer value)

Pressure unit



Navigation Expert → System → System units → Pressure unit (0564)

Selection

<p><i>SI units</i></p> <ul style="list-style-type: none"> ■ bar ■ Pa ■ kPa ■ MPa ■ mbar a 	<p><i>US units</i></p> <p>psi</p>	<p><i>Other units</i></p> <ul style="list-style-type: none"> ■ inH2O ■ inH2O (68°F) ■ ftH2O (68°F) ■ mmH2O ■ mmHg
--	-----------------------------------	--

Factory setting bar

Additional information

Read access	Operator
Write access	Maintenance (if Units preset (→ 42) = Customer value)

Temperature unit



Navigation Expert → System → System units → Temperature unit (0557)

Description Select temperature unit.

Selection

<p><i>SI units</i></p> <ul style="list-style-type: none"> ■ °C ■ K 	<p><i>US units</i></p> <ul style="list-style-type: none"> ■ °F ■ °R
--	---

Factory setting °C

Additional information

Read access	Operator
Write access	Maintenance (if Units preset (→ 42) = Customer value)

Density unit 

Navigation

  Expert → System → System units → Density unit (0555)

Description

Select density unit.

Selection

SI units

- g/cm³
- g/ml
- g/l
- kg/l
- kg/dm³
- kg/m³

US units

- lb/ft³
- lb/gal (us)
- lb/in³
- STon/yd³

Other units

- °API
- SGU

Factory setting

kg/m³

Additional information

Read access	Operator
Write access	Maintenance (if Units preset (→  42) = Customer value)

Decimal places length 

Navigation

  Expert → System → System units → Decimal length (0573)

Description

Number of decimal places for length values.

Selection

- X
- X.X
- X.XX
- X.XXX
- X.XXXX

Factory setting

X.X

Additional information



Read access	Operator
Write access	Maintenance



The setting does not affect the accuracy of the measurement or the calculations.

Decimal places pressure 

Navigation

  Expert → System → System units → Decimal pressure (0608)

Description

Number of decimal places for pressure values.

- Selection**
- X
 - X.X
 - X.XX
 - X.XXX
 - X.XXXX

Factory setting x.xxx



Additional information

Read access	Operator
Write access	Maintenance

 The setting does not affect the accuracy of the measurement or the calculations.

Decimal places temperature



Navigation   Expert → System → System units → Decimal temp. (0614)

Description Number of decimal places for temperature values.

- Selection**
- X
 - X.X
 - X.XX
 - X.XXX
 - X.XXXX

Factory setting x.x



Additional information

Read access	Operator
Write access	Maintenance

 The setting does not affect the accuracy of the measurement or the calculations.

Decimal places density



Navigation   Expert → System → System units → Decimal density (0609)

Description Number of decimal places for density values.

- Selection**
- X
 - X.X
 - X.XX
 - X.XXX
 - X.XXXX

Factory setting x.x

Additional information







Read access	Operator
Write access	Maintenance

 The setting does not affect the accuracy of the measurement or the calculations.

3.1.3 "Date / time" submenu

The **Date / time** submenu is used to set the real-time clock of the device.

Setting the real-time clock via the display and operating module

1. Navigate to Expert → System → Date / time → Set date.
 - ↳ The current value of the real-time clock is displayed.
2. If the displayed value is correct: Press  to terminate the wizard.
3. If the displayed value is not correct: Press  to edit it.
 - ↳ The current value of the **Year** parameter is displayed.
4. If the displayed value is correct: Press  to go to the next value.
5. If the displayed value is incorrect: Press  and enter the correct value. Confirm the new value by pressing .
6. Repeat the last two steps for the following parameters: **Month, Day, Hour, Minute**.
 - ↳ The new value of the real-time clock is displayed.
7. Confirm the new value of the real-time clock by pressing .
8. Quit the wizard by pressing  again.

Setting the real-time clock via an operating tool (e.g. FieldCare)

1. Navigate to: Expert → System → Date / time

2.

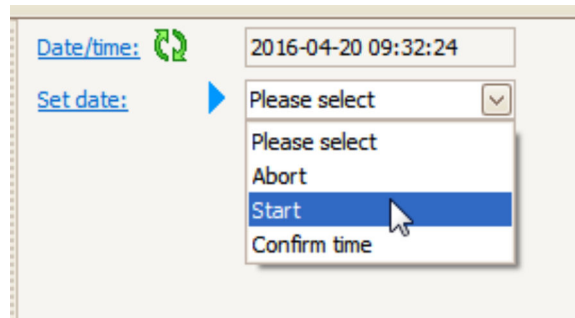

Go to the **Set date** parameter (→ ⓘ 50) and select the **Start** option.

3.

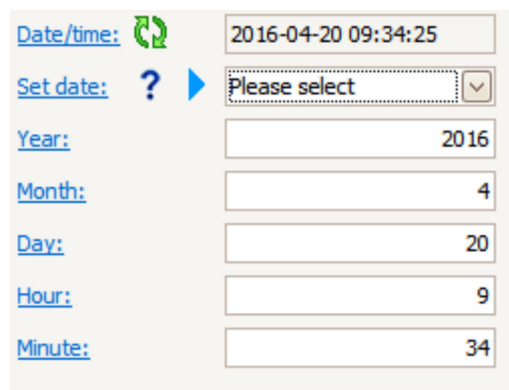

Use the following parameters to set the date and time: **Year, Month, Day, Hour, Minutes**.

4.

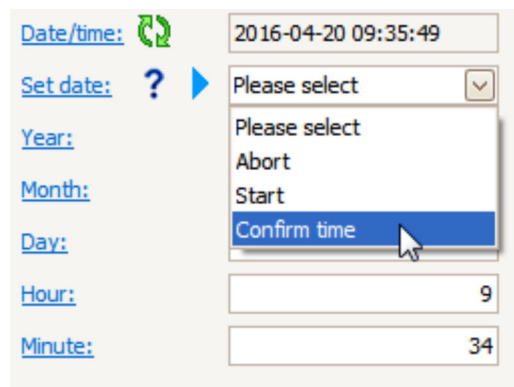









Go to the **Set date** parameter (→ ⓘ 50) and select the **Confirm time** option.

↳ The real-time clock is set to the current date and time.







Structure of the submenu on the display and operating module

Navigation  Expert → System → Date / time

► Date / time	
Date/time	→  50
► Set date	
Date/time	→  53
Year	→  53
Month	→  53
Day	→  53
Hour	→  53
Minute	→  54
Set date	→  54

Structure of the submenu in an operating tool (e.g. FieldCare)

Navigation  Expert → System → Date / time

► Date / time	
Date/time	→  50
Set date	→  50
Year	→  50
Month	→  51
Day	→  51
Hour	→  51
Minute	→  52

Description of parameters

Navigation  Expert → System → Date / time

Date/time

Navigation  Expert → System → Date / time → Date/time (0790)

Description Displays the device internal real time clock.

Additional information

Read access	Operator
Write access	-

Set date

Navigation  Expert → System → Date / time → Set date (0792)

Description Controls the setting of the real-time clock.

Selection

- Please select
- Abort
- Start
- Confirm time

Factory setting Please select

Additional information

Read access	Operator
Write access	Maintenance

Meaning of the options

- **Please select**
Prompts the user to select an action.
- **Abort**
Discards the entered date and time.
- **Start**
Starts the setting of the real time clock.
- **Confirm time**
Sets the real-time clock to the entered date and time.

Year

Navigation  Expert → System → Date / time → Year (0782)

Prerequisite Set date (→  50) = Start

Description Enter the current year.

User entry 2016 to 2079

Factory setting 2016

Additional information

Read access	Operator
Write access	Maintenance

Month



Navigation Expert → System → Date / time → Month (0787)

Prerequisite Set date (→ 50) = Start

Description Enter the current month.

User entry 1 to 12

Factory setting 1

Additional information

Read access	Operator
Write access	Maintenance

Day



Navigation Expert → System → Date / time → Day (0788)

Prerequisite Set date (→ 50) = Start

Description Enter the current day.

User entry 1 to 31

Factory setting 1

Additional information

Read access	Operator
Write access	Maintenance

Hour



Navigation Expert → System → Date / time → Hour (0789)

Prerequisite Set date (→ 50) = Start

Description Enter the current hour.

User entry 0 to 23

Factory setting 0

Additional information

Read access	Operator
Write access	Maintenance

Minute

Navigation  Expert → System → Date / time → Minute (0791)

Prerequisite Set date (→  50) = Start

Description Enter the current minute.

User entry 0 to 59

Factory setting 0

Additional information

Read access	Operator
Write access	Maintenance

"Set date" wizard

Navigation  Expert → System → Date / time → Set date

Date/time

Navigation  Expert → System → Date / time → Set date → Date/time (0790)

Description →  50

Year



Navigation  Expert → System → Date / time → Set date → Year (0782)

Description →  50

Month



Navigation  Expert → System → Date / time → Set date → Month (0787)

Description →  51

Day



Navigation  Expert → System → Date / time → Set date → Day (0788)

Description →  51

Hour



Navigation  Expert → System → Date / time → Set date → Hour (0789)

Description →  51

Minute

**Navigation** Expert → System → Date / time → Set date → Minute (0791)**Description**→  52

Set date

Navigation Expert → System → Date / time → Set date → Set date**Description**Confirm the displayed new value of the real-time clock by pressing .

3.1.4 "Administration" submenu

Structure of the submenu on the display and operating module

Navigation  Expert → System → Administration

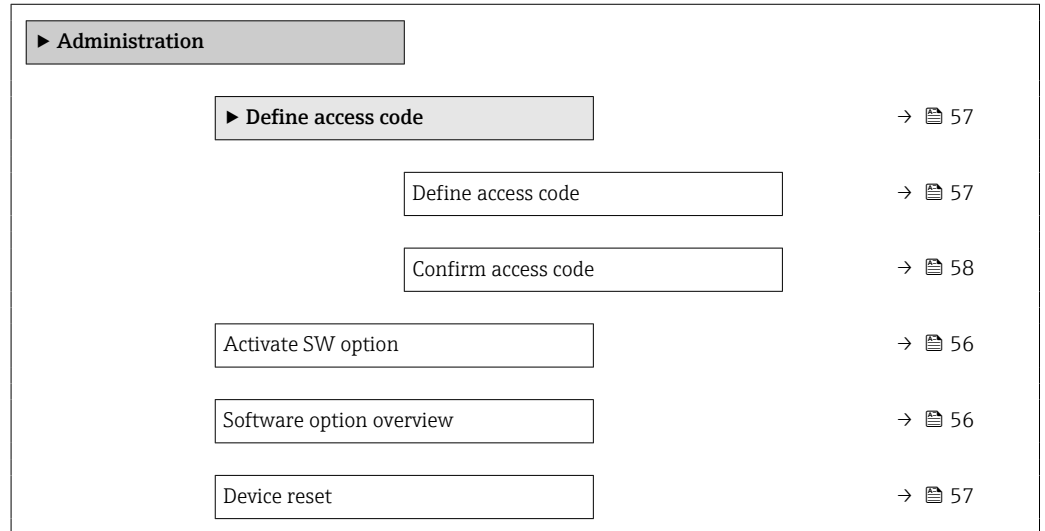

Structure of the submenu in an operating tool (e.g. FieldCare)

Navigation  Expert → System → Administration

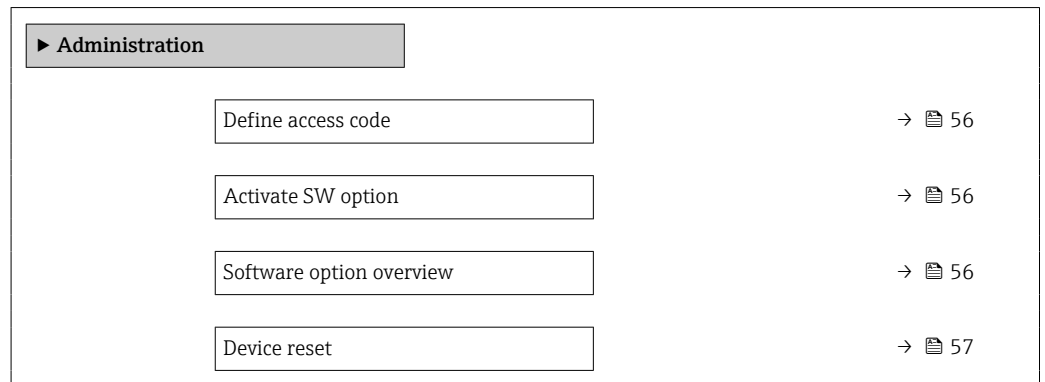

Description of parameters

Navigation  Expert → System → Administration

Define access code

Navigation  Expert → System → Administration → Def. access code (0093)

Description Define release code for write access to parameters.

User entry 0 to 9 999



Factory setting 0

Additional information

Read access	Operator
Write access	Maintenance

 If the factory setting is not changed or 0 is defined as the access code, the parameters are not write-protected and the configuration data of the device can then always be modified. The user is logged on in the *Maintenance* role.

 The write protection affects all parameters marked with the  symbol in this document.

 Once the access code has been defined, write-protected parameters can only be modified if the access code is entered in the **Enter access code** parameter (→  33).

Activate SW option

Navigation  Expert → System → Administration → Activate SW opt. (0029)

Description Enter the application package code or code of another re-ordered functionality to enable it

User entry Positive integer

Factory setting 0

Additional information

Read access	Operator
Write access	Maintenance

Software option overview

Navigation  Expert → System → Administration → SW option overv. (0015)



Description Shows all enabled software options

- User interface**
- Extended HistoROM
 - SIL
 - WHG
 - CLG

Additional information  The option of the CLG is not available for NMS8x.

Read access	Operator
Write access	-

Device reset 

Navigation   Expert → System → Administration → Device reset (0000)

Description Reset the device configuration - either entirely or in part - to a defined state

- Selection**
- Cancel
 - To factory defaults
 - Restart device

Factory setting Cancel

Additional information **Meaning of the options**

- **Cancel**
No action
- **To factory defaults**
All parameters are reset to the order-code specific factory setting.
- **Restart device**
The restart resets every parameter which is stored in the volatile memory (RAM) to the factory setting (e.g. measured value data). The device configuration remains unchanged.

Read access	Operator
Write access	Maintenance

"Define access code" wizard

Navigation  Expert → System → Administration → Def. access code

Define access code 

Navigation  Expert → System → Administration → Def. access code → Def. access code

Description →  56

Confirm access code

**Navigation**

Expert → System → Administration → Def. access code → Confirm code

Description

Confirm the entered access code.

User entry

0 to 9 999

Factory setting









0

Additional information

Read access	Operator
Write access	Maintenance

3.2 "Sensor" submenu

Navigation  Expert → Sensor

▶ Sensor	
Gauge command	→  59
Gauge status	→  60
Distance	→  60
▶ Information	→  61
▶ Measured values	→  64
▶ Sensor diag	→  72
▶ Sensor config	→  74
▶ Calibration	→  94

Gauge command

Navigation  Expert → Sensor → Gauge command (8000)

Description Gauge operation command to choose the measurement mode of the device.

- Selection
- Stop *
 - Level
 - Up *
 - Bottom level *
 - Upper I/F level *
 - Lower I/F level *
 - Upper density *
 - Middle density *
 - Lower density *
 - Repeatability *
 - Water dip *
 - Release overtension *
 - Tank profile *
 - Interface profile *
 - Manual profile *
 - Level standby *
 - Offset standby *

Factory setting Stop

* Visibility depends on order options or device settings

Additional information

Read access	Operator
Write access	Maintenance

Gauge status**Navigation**

 Expert → Sensor → Gauge status (8081)

Description

Indicates the current status of the device gauge command.

Additional information

Read access	Operator
Write access	-

Distance**Navigation**

  Expert → Sensor → Distance (8103)

Description

Shows measured distance from reference position.

Additional information









Read access	Operator
Write access	-

3.2.1 "Information" submenu



The **Information** submenu (→  61) comprises all display parameters which give information about the current state of the measurement.

Description of parameters

Navigation   Expert → Sensor → Information

► Information	
Gross weight	→  61
Net weight	→  61
Gauge status	→  62
Active gauge command	→  62
Balance flag	→  62
Displacer status	→  62
Motor status	→  63
One-time command status	→  63
Sensor temperature	→  63
Detector temperature	→  63

Gross weight



Navigation   Expert → Sensor → Information → Gross weight (8080)

Description Shows non-compensated measured weight from detector.

Additional information

Read access	Operator
Write access	-

Net weight

Navigation   Expert → Sensor → Information → Net weight (8007)

Description Shows the corrected weight data from the detector, as compensated by the drum table, This weight is used for measurement.

Additional information

Read access	Operator
Write access	-

Gauge status**Navigation**
 Expert → Sensor → Information → Gauge status (8081)
Description

Indicates the current status of the device gauge command.

Additional information

Read access	Operator
Write access	-

Active gauge command**Navigation**
 Expert → Sensor → Information → Active gauge cmd (8073)
Description

Indicates the currently executed Gauge Command.

Additional information

Read access	Operator
Write access	-

Balance flag**Navigation**
 Expert → Sensor → Information → Balance flag (8006)
Description

Indicates the validity of the Measurement. If balanced, corresponding Value (Liquid Level, Upper Interface, Lower Interface, Tank Bottom) is updated.

Additional information

Read access	Operator
Write access	-



Displacer status**Navigation**
 Expert → Sensor → Information → Displacer status (8160)
Description

Shows the current moving and balancing status of the displacer.

Additional information

Read access	Operator
Write access	-

Motor status



Navigation   Expert → Sensor → Information → Motor status (8118)

Description Shows the current moving Direction of the Motor.

Additional information

Read access	Operator
Write access	-

One-time command status

Navigation   Expert → Sensor → Information → One-time Cmd (8201)



Description Indicates the status of the last executed one-time gauge command.

Additional information

Read access	Operator
Write access	-

Additional information  One-time command is available for all gauge commands, excepting Level, Stop, Up, and Interface.

Sensor temperature



Navigation   Expert → Sensor → Information → Sensor temp. (8066)

Description Shows the temperature of sensor module electronics.

Additional information

Read access	Operator
Write access	-

Detector temperature

Navigation   Expert → Sensor → Information → Detector temp. (8090)











Description Shows the temperature of the detector unit.

Additional information

Read access	Operator
Write access	-

3.2.2 "Measured values" submenu

Navigation  Expert → Sensor → Measured values

▶ Measured values	
Distance	→  65
Displacer position	→  65
Liquid level	→  66
Upper interface level	→  66
Upper interface level timestamp	→  66
Lower interface level	→  66
Lower interface level timestamp	→  67
Bottom level	→  67
Bottom level timestamp	→  67
▶ Spot density	→  68
▶ Profile density	→  70

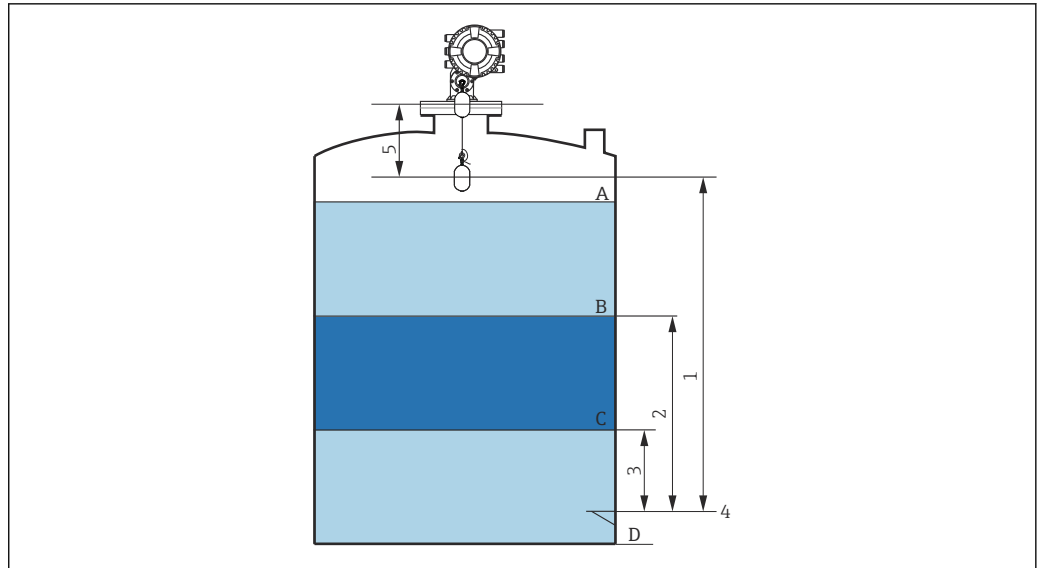

A0038584

6 Terms concerning NMS8x installation (e.g. NMS81)

- A Liquid level
- B Upper interface
- C Lower interface
- 1 Displacer pos
- 2 Upper I/F level
- 3 Lower I/F level
- 4 Datum plate
- 5 Distance

Distance

Navigation

Expert → Sensor → Measured values → Distance (8103)

Description

Shows measured distance from reference position.

Additional information

Read access	Operator
Write access	-

Displacer position

Navigation

Expert → Sensor → Measured values → Displacer pos (8130)

Description

Shows measured displacer position from zero position (tank bottom or datum plate). Value is always updated when displacer moves.

Additional information

Read access	Operator
Write access	-

Liquid level

Navigation
 Expert → Sensor → Measured values → Liquid level (8072)
Description

Shows measured level from zero position (tank bottom or datum plate). Value is updated when device generates a valid level measurement.

Additional information

Read access	Operator
Write access	-

Upper interface level

Navigation
 Expert → Sensor → Measured values → Upper I/F level (8127)
Description

Shows measured interface level from zero position (tank bottom or datum plate). Value is updated when device generates a valid Interface measurement.

Additional information

Read access	Operator
Write access	-

Upper interface level timestamp

Navigation
 Expert → Sensor → Measured values → Up I/F timestamp (8055)
Description

Shows timestamp for the last measured upper interface level.

Additional information

Read access	Operator
Write access	-

Lower interface level

Navigation
 Expert → Sensor → Measured values → Lower I/F level (8128)
Description

Shows measured interface level from zero position (tank bottom or datum plate). Value is updated when device generates a valid interface measurement.

Additional information

Read access	Operator
Write access	-

Lower interface level timestamp

Navigation  Expert → Sensor → Measured values → LowI/F timestamp (8061)

Description Shows timestamp of the last measured lower interface level.

Additional information

Read access	Operator
Write access	-

Bottom level

Navigation  Expert → Sensor → Measured values → Bottom level (8129)

Description Shows measured bottom level. Value is updated after a successful tank bottom gauge command.

Additional information

Read access	Operator
Write access	-

Bottom level timestamp

Navigation  Expert → Sensor → Measured values → BotLev timestamp (8048)







Description Shows the timestamp for measured bottom level.

Additional information

Read access	Operator
Write access	-

"Spot density" submenu

Navigation  Expert → Sensor → Measured values → Spot density

▶ Spot density	
Measured upper density	→  68
Upper density timestamp	→  68
Measured middle density	→  68
Middle Density Timestamp	→  69
Measured lower density	→  69
Lower density timestamp	→  69

Measured upper density

Navigation  Expert → Sensor → Measured values → Spot density → Meas upper dens. (8164)

Description Shows the Measured Upper Density Value.

Additional information

Read access	Operator
Write access	-

Upper density timestamp

Navigation  Expert → Sensor → Measured values → Spot density → UpDens timestamp (8067)

Description Shows timestamp of the last measured upper density.

Additional information

Read access	Operator
Write access	-

Measured middle density

Navigation  Expert → Sensor → Measured values → Spot density → Meas middle dens (8165)

Description Shows the Measured Middle Density Value.

Additional information

Read access	Operator
Write access	-

Middle Density Timestamp

Navigation

 Expert → Sensor → Measured values → Spot density → MidDensTimestamp (8011)

Description

Shows the timestamp of the last measured middle density.

Additional information

Read access	Operator
Write access	-

Measured lower density

Navigation

 Expert → Sensor → Measured values → Spot density → Meas lower dens. (8166)

Description

Shows the Measured Lower Density Value.

Additional information

Read access	Operator
Write access	-

Lower density timestamp

Navigation

 Expert → Sensor → Measured values → Spot density → LowerDensTimestp (8122)

Description



Shows timestamp of last measured lower density.

Additional information

Read access	Operator
Write access	-

"Profile density" submenu

Navigation  Expert → Sensor → Measured values → Profile density

▶ Profile density	
Profile point	→  70
Profile average density	→  70
Profile density timestamp	→  70

Profile point

Navigation  Expert → Sensor → Measured values → Profile density → Profile point (8170)

Description Shows actual number of Density Points measured so far in current operation, and the total Number of Points after Density Profile Operation is complete.

Additional information

Read access	Operator
Write access	-

Profile average density

Navigation  Expert → Sensor → Measured values → Profile density → Profile avg dens (8175)

Description Shows the average density calculated after a profile density measurement is complete.

Additional information

Read access	Operator
Write access	-

Profile density timestamp

Navigation  Expert → Sensor → Measured values → Profile density → Profil dens time (8114)

Description Shows the timestamp when the last average density profile was finished.

Additional information

Read access	Operator
Write access	-

"Density table" submenu

Navigation  Expert → Sensor → Measured values → Profile density → Density table

Density table

Navigation  Expert → Sensor → Measured values → Profile density → Density table

Description Shows measured density table of profile density.

3.2.3 "Sensor diag" submenu

Navigation  Expert → Sensor → Sensor diag

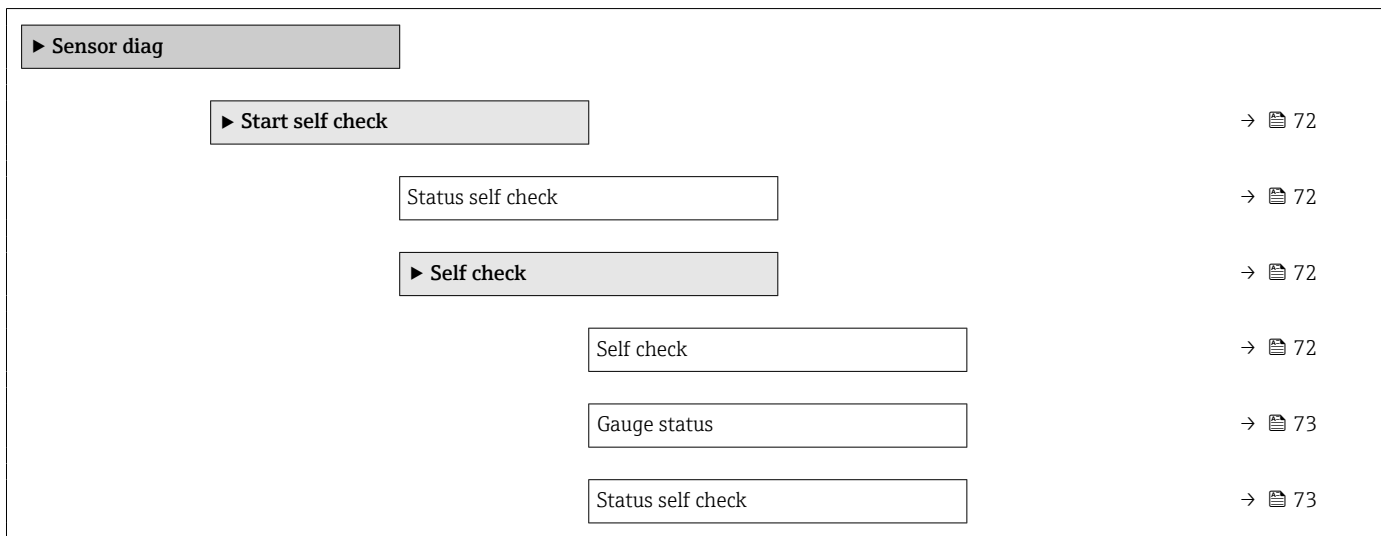

"Start self check" submenu

Navigation  Expert → Sensor → Sensor diag → Start self check

Status self check

Navigation  Expert → Sensor → Sensor diag → Start self check → Status (8192)

Description Shows the status of the self check of the sensor module.

Additional information

Read access	Operator
Write access	-

"Self check" wizard

Navigation  Expert → Sensor → Sensor diag → Start self check → Self check

Self check

Navigation  Expert → Sensor → Sensor diag → Start self check → Self check → Self check

Additional information

Read access	Operator
Write access	-

Gauge status

Navigation

 Expert → Sensor → Sensor diag → Start self check → Self check → Gauge status (8081)

Description

Indicates the current status of the device gauge command.

Additional information

Read access	Operator
Write access	-

Status self check

Navigation

 Expert → Sensor → Sensor diag → Start self check → Self check → Status (8192)



Description









Shows the status of the self check of the sensor module.

Additional information

Read access	Operator
Write access	-



3.2.4 "Sensor config" submenu

Navigation   Expert → Sensor → Sensor config → Post gauge cmd (8163)

▶ Sensor config	
Post gauge command	→  74
▶ Displacer	→  75
▶ Wiredrum	→  78
▶ Safety settings	→  79
▶ Level settings	→  82
▶ Balance settings	→  86
▶ Spot density	→  90
▶ Profile density	→  92

Post gauge command

Navigation

  Expert → Sensor → Sensor config → Post gauge cmd (8163)

Description

Defines the gauge command that will be executed after a one-time gauge command has finished.

Selection

- Stop
- Level
- Up
- Upper I/F level
- Lower I/F level
- None



Factory setting

Level







Additional information

Read access	Operator
Write access	Maintenance

"Displacer" submenu



Navigation   Expert → Sensor → Sensor config → Displacer → Displacer type (8071)

▶ **Displacer**

Displacer type	→  75
Displacer diameter	→  75
Displacer weight	→  76
Displacer volume	→  76
Displacer balance volume	→  76
Displacer height	→  77
Immersion depth	→  77

Displacer type



Navigation   Expert → Sensor → Sensor config → Displacer → Displacer type (8071)

Description Chooses the type of displacer used.

- Selection**
- Custom diameter
 - Diameter 30 mm
 - Diameter 50 mm
 - Diameter 70 mm
 - Diameter 110 mm



Factory setting Dependent on the device version

Additional information

Read access	Operator
Write access	Maintenance

Displacer diameter



Navigation   Expert → Sensor → Sensor config → Displacer → Displacer diamet (8014)

Prerequisite **Displacer type (→  75) = Custom diameter**

Description Sets the diameter of the cylindrical part of displacer.



User entry 0 to 999.9 mm

Factory setting See label on the device.

Additional information

Read access	Operator
Write access	Maintenance

Displacer weight 

Navigation   Expert → Sensor → Sensor config → Displacer → Displacer weight (8010)

Description Set the weight of the displacer in air. Indicated on the displacer in grams.



User entry 10 to 999.9 g

Factory setting See label on the device.

Additional information

Read access	Operator
Write access	Maintenance

Displacer volume 

Navigation   Expert → Sensor → Sensor config → Displacer → Displacer volume (8008)

Description Displacer volume indicated on displacer in milliliter.



User entry 10 to 999.9 ml

Factory setting See label on the device.

Additional information

Read access	Operator
Write access	Maintenance

Displacer balance volume 

Navigation   Expert → Sensor → Sensor config → Displacer → Balance volume (8009)

Description Defines the balance volume of the displacer as the lower part of displacer immersed in liquid. Units in milliliters. Indicated on displacer.

User entry 10 to 999.9 ml

Factory setting See label on the device.

Additional information

Read access	Operator
Write access	Maintenance

Displacer height



Navigation

Expert → Sensor → Sensor config → Displacer → Displacer height (8195)

Description

Sets the displacer height in mm. Used for density measurement as minimum distance between last profile point and liquid level.

User entry

10 to 300 mm

Factory setting

Dependent on the device version

Additional information

Read access	Operator
Write access	Maintenance

Immersion depth



Navigation

Expert → Sensor → Sensor config → Displacer → Immersion depth (8070)

Description

Defines distance (mm) from displacer bottom to balancing line defined by balanced volume. Value is needed for correct bottom level measurement.

User entry

0 to 99.9 mm

Factory setting

Dependent on the device version

Additional information

Read access	Operator
Write access	Maintenance

"Wiredrum" submenu

Navigation  Expert → Sensor → Sensor config → Wiredrum

▶ Wiredrum

Drum circumference

→  78

Wire weight

→  78

Drum circumference 

Navigation  Expert → Sensor → Sensor config → Wiredrum → Drum circumfer (8082)

Description Sets the circumference of the wire drum. Indicated in Label.

User entry 100 to 999.9 mm

Factory setting See label on the device.

Additional information

Read access	Operator
Write access	Maintenance

Wire weight 

Navigation  Expert → Sensor → Sensor config → Wiredrum → Wire weight (8040)

Description Defines the weight of the measuring wire in g/10m. Indicated on Label.

User entry 0 to 999.9 g

Factory setting See label on the device.







Additional information

Read access	Operator
Write access	Maintenance

"Safety settings" submenu



Navigation   Expert → Sensor → Sensor config → Safety settings

▶ Safety settings

High stop level	→  79
Low stop level	→  79
Slow hoist zone	→  80
Overtension weight	→  80
Undertension weight	→  80
Output out of range	→  81

High stop level 

Navigation

  Expert → Sensor → Sensor config → Safety settings → High stop level (8135)

Description

Position of the displacer high stop as measured from defined zero position (tank bottom or datum plate).

User entry

-999 999.9 to 999 999.9 mm

Factory setting



20 000 mm

Additional information

Read access	Operator
Write access	Maintenance

Low stop level 

Navigation

  Expert → Sensor → Sensor config → Safety settings → Low stop level (8069)

Description

Position of the displacer low stop as measured from defined zero position (tank bottom or datum plate).

User entry

-999 999.9 to 999 999.9 mm

Factory setting

0 mm

Additional information

Read access	Operator
Write access	Maintenance

Slow hoist zone

Navigation	Expert → Sensor → Sensor config → Safety settings → Slow hoist zone (8084)				
Description	Defines the interval in millimeters, measured down from the Reference Position, in which the Displacer reduces moving speed.				
User entry	10 to 999 999.9 mm				
Factory setting	70 mm				
Additional information	<table border="1"> <tr> <td>Read access</td> <td>Operator</td> </tr> <tr> <td>Write access</td> <td>Maintenance</td> </tr> </table>	Read access	Operator	Write access	Maintenance
Read access	Operator				
Write access	Maintenance				

Overtension weight

Navigation	Expert → Sensor → Sensor config → Safety settings → Overtension wgt (8097)				
Description	Sets the minimum Weight in grams when Overtension Alarm will be set.				
User entry	100 to 999.9 g				
Factory setting	350 g				
Additional information	<table border="1"> <tr> <td>Read access</td> <td>Operator</td> </tr> <tr> <td>Write access</td> <td>Maintenance</td> </tr> </table>	Read access	Operator	Write access	Maintenance
Read access	Operator				
Write access	Maintenance				

Undertension weight

Navigation	Expert → Sensor → Sensor config → Safety settings → Undertension wgt (8098)				
Description	Defines the undertension error weight. Undertension error will be issued if displacer weight is below this value longer than 7 seconds.				
User entry	0 to 300 g				
Factory setting	10 g				
Additional information	<table border="1"> <tr> <td>Read access</td> <td>Operator</td> </tr> <tr> <td>Write access</td> <td>Maintenance</td> </tr> </table>	Read access	Operator	Write access	Maintenance
Read access	Operator				
Write access	Maintenance				

Output out of range



Navigation Expert → Sensor → Sensor config → Safety settings → Output out range (8218)

Description Selection of behavior between Alarm or Last valid value when displacer reached HighStoplevel, LowStopLevel or ReferencePosition.

- Selection**
- Last valid value
 - Alarm
 - None

Factory setting Last valid value







Additional information

Read access	Operator
Write access	Maintenance

"Level settings" submenu

Navigation  Expert → Sensor → Sensor config → Level settings → Upper density (8113)

▶ **Level settings**

Upper density	→  82
Middle density	→  82
Lower density	→  83
Process condition	→  83
Standby level	→  83
Offset standby distance	→  84

Upper density 

Navigation  Expert → Sensor → Sensor config → Level settings → Upper density (8113)

Description Sets the density of the upper phase of the liquid.

User entry 50 to 2 000 kg/m³

Factory setting 800 kg/m³

Additional information

Read access	Operator
Write access	Maintenance

Middle density 

Navigation  Expert → Sensor → Sensor config → Level settings → Middle density (8041)

Description Sets Density of Middle Phase in the Tank if three Phases are available. Otherwise used for the Lower Phase in the Tank if two Phases are available.

User entry 50 to 2 000 kg/m³

Factory setting 1 000 kg/m³

Additional information

Read access	Operator
Write access	Maintenance

Lower density



Navigation Expert → Sensor → Sensor config → Level settings → Lower density (8042)

Description Sets the density of the lower Phase in the tank if three phases are available.

User entry 50 to 2 000 kg/m³

Factory setting 1 200 kg/m³

Additional information

Read access	Operator
Write access	Maintenance

Process condition



Navigation Expert → Sensor → Sensor config → Level settings → Process cond. (8001)

Description Select the liquid condition of the tank.

- Selection**
- Universal
 - Calm surface
 - Turbulent surface

Factory setting Universal

Additional information For W&M, setting to option **Calm surface** is recommended.

Read access	Operator
Write access	Maintenance

Standby level



Navigation Expert → Sensor → Sensor config → Level settings → Standby level (8194)

Description Defines the position in the tank where the displacer waits for the liquid level to rise during standby level gauge command.

User entry -999 999.9 to 999 999.9 mm

Factory setting 0 mm

Additional information

Read access	Operator
Write access	Maintenance

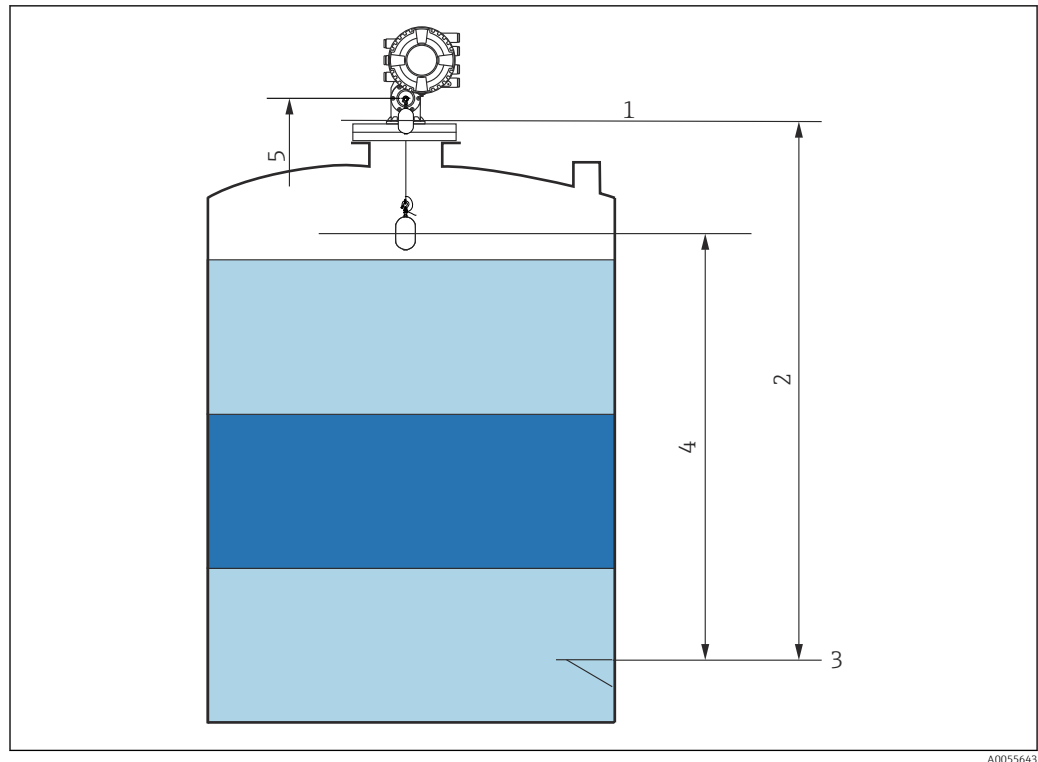



A0055643

 7 *Displacer waiting for the liquid level to rise during standby level gauge command*

- 1 *Gauge reference height*
- 2 *Empty*
- 3 *Datum plate*
- 4 *Standby level (→  83)*
- 5 *Reference position*

Offset standby distance

Navigation

  Expert → Sensor → Sensor config → Level settings → Offset distance (8107)

Description

Defines the distance from the current position where the displacer waits for the liquid level to rise during offset standby gauge command.

User entry

0 to 999 999.9 mm

Factory setting

500 mm

Additional information

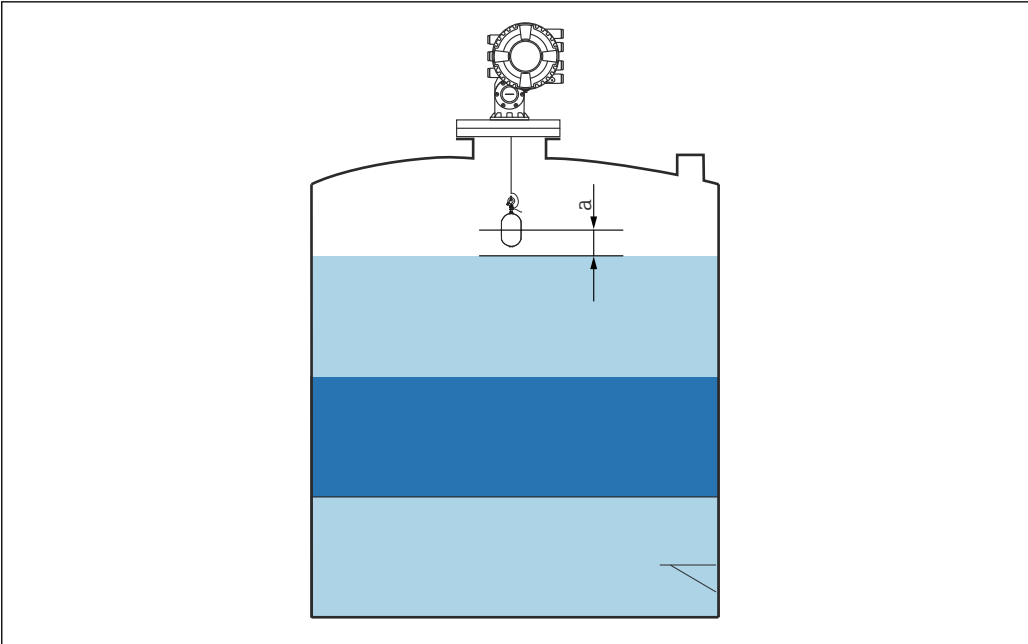





A0051202

8 a: Offset standby distance

"Balance settings" submenu

Navigation  Expert → Sensor → Sensor config → Balance settings

▶ Balance settings

Level measurement mode	→  86
Interface measurement mode	→  87
Balancing waiting time	→  87
Seek delay	→  88
Weight tolerance	→  88

 The parameter "Process condition" does a pre-set of the major balancing parameters. For the most applications its enough to set the correct "Process condition" parameter which affects the balancing parameter settings automatically.

Level measurement mode

Navigation  Expert → Sensor → Sensor config → Balance settings → Level meas mode (8056)

Description Chooses the measurement mode used for level measurement.

- Selection**
- Normal measure mode
 - Compensation mode
 - Non hysteresis mode

Factory setting Non hysteresis mode

Additional information

Read access	Operator
Write access	Maintenance

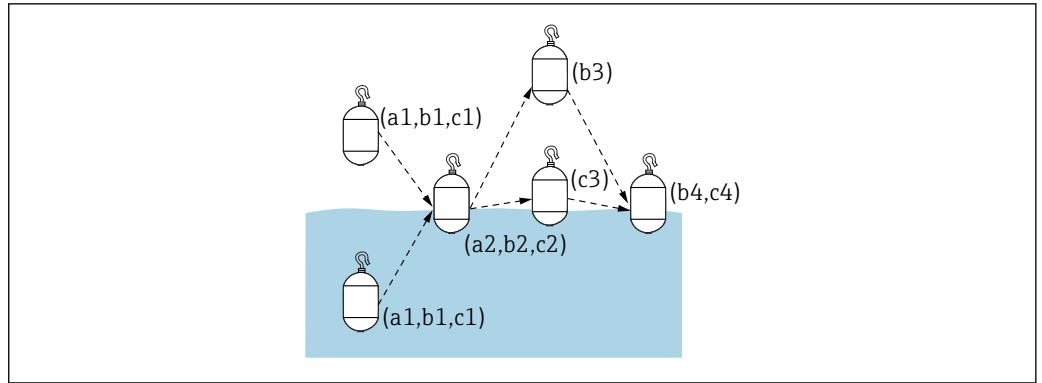

A0038582

9 NMS8x level mode

- a1 Displacer is in liquid or air unbalanced
- a2 Displacer on liquid balanced
- b1 Displacer is in liquid or air unbalanced
- b2 Displacer on liquid balanced
- b3 Displacer is moved out of the liquid, the weight in vapour is measured and used for the new weight calculation
- b4 Displacer on liquid balanced
- c1 Displacer is in liquid or air unbalanced
- c2 Displacer on liquid balanced
- c3 Displacer is lifted up
- c4 Displacer on liquid balanced

Interface measurement mode



- Navigation** Expert → Sensor → Sensor config → Balance settings → Interface mode (8064)
- Description** Chooses the measurement mode used for interface level measurements.
- Selection**
 - Non hysteresis mode
 - Normal measure mode
- Factory setting** Non hysteresis mode

Additional information

Read access	Operator
Write access	Maintenance

Balancing waiting time



- Navigation** Expert → Sensor → Sensor config → Balance settings → Bal waiting time (8205)
- Description** Set the waiting time in seconds, after which the balance flag is turned on if level measurement is balanced (motor has stopped).
- User entry** 0 to 255 s
- Factory setting** 4 s

Additional information

Read access	Operator
Write access	Maintenance

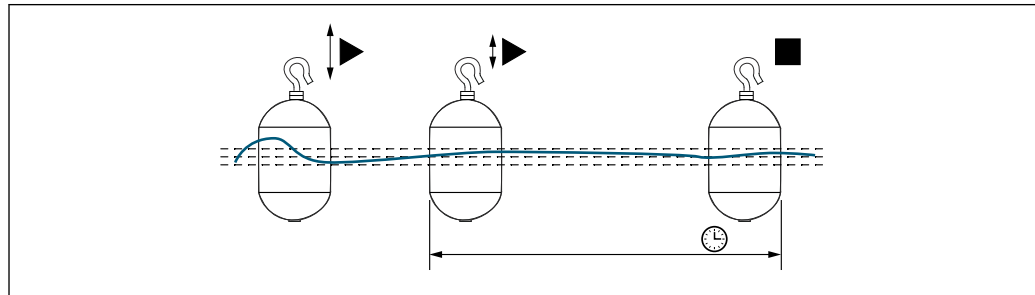

10 Balancing waiting time

A0057248

Seek delay



Navigation

Expert → Sensor → Sensor config → Balance settings → Seek delay (8162)

Description

When displacer is balanced, this parameter sets the Delay Time (seconds) before displacer starts to track Level again.

User entry

1 to 255 s

Factory setting

2 s

Additional information

Read access	Operator
Write access	Maintenance

Weight tolerance



Navigation

Expert → Sensor → Sensor config → Balance settings → Weight tolerance (8213)

Description

Defines balance weight tolerance in grams, in which the displacer is in balance status.

User entry

0.1 to 100 g

Factory setting

1.6 g

Additional information

Read access	Operator
Write access	Maintenance

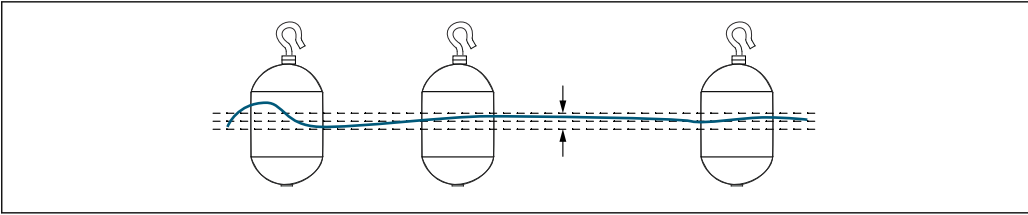





A0038583

11 Weight tolerance

"Spot density" submenu

Navigation  Expert → Sensor → Sensor config → Spot density

▶ Spot density	
Upper density offset	→  90
Middle density offset	→  90
Lower density offset	→  91
Submersion depth	→  91

Upper density offset

Navigation  Expert → Sensor → Sensor config → Spot density → Up dens. offset (8176)

Description Defines an offset value which is added to the measured upper density value.

User entry -999.99 to 999.99 kg/m³

Factory setting 0 kg/m³

Additional information	Read access	Operator
	Write access	Maintenance

Middle density offset

Navigation  Expert → Sensor → Sensor config → Spot density → Mid dens. offset (8177)

Description Defines an Offset Value which is added to the measured Middle Density Value.

User entry -999.99 to 999.99 kg/m³

Factory setting 0 kg/m³

Additional information	Read access	Operator
	Write access	Maintenance

Lower density offset



Navigation Expert → Sensor → Sensor config → Spot density → Low dens. offset (8178)

Description Defines an offset value which is added to the measured lower density value.

User entry -999.99 to 999.99 kg/m³

Factory setting 0 kg/m³

Additional information

Read access	Operator
Write access	Maintenance

Submersion depth



Navigation Expert → Sensor → Sensor config → Spot density → Submersion depth (8169)

Description Sets the displacer submersion depth (mm) for spot density operations.

User entry 50 to 99 999.9 mm





Factory setting 150 mm

Additional information

Read access	Operator
Write access	Maintenance

"Profile density" submenu

Navigation  Expert → Sensor → Sensor config → Profile density

► Profile density	
Density measurement mode	→  92
Manual profile level	→  92
Profile density offset distance	→  93
Profile density interval	→  93
Profile density offset	→  93

Density measurement mode



Navigation  Expert → Sensor → Sensor config → Profile density → Density mode (8186)

Description In normal measure mode, measures at specified positions. In compensation mode measures using next integer value of drum turns to improve accuracy.

Selection

- Normal measure mode
- Compensation mode

Factory setting Normal measure mode

Additional information

Read access	Operator
Write access	Maintenance

 In normal mode, measures spot densities at requested positions. In compensations mode the Proservo measures the spot densities at multiples of the wiredrum circumference (e.g. every ~ 150 mm (5.91 in))

Manual profile level



Navigation  Expert → Sensor → Sensor config → Profile density → Man profile lvl (8182)

Description Sets the level position in the tank where the manual profile density operation starts.

User entry -999 999.9 to 999 999.9 mm

Factory setting 1 000 mm

Additional information

Read access	Operator
Write access	Maintenance

Profile density offset distance



Navigation

Expert → Sensor → Sensor config → Profile density → Dens offset dist (8185)

Description

Profile density offset distance [mm] is the distance between start point and first measurement point.

User entry

0 to 999 999.9 mm

Factory setting

500 mm

Additional information

Read access	Operator
Write access	Maintenance

Profile density interval



Navigation

Expert → Sensor → Sensor config → Profile density → Density interval (8174)

Description

Sets the interval between two measurement points in profile density operation.

User entry

1 to 100 000 mm

Factory setting

1 000 mm

Additional information

Read access	Operator
Write access	Maintenance

Profile density offset



Navigation

Expert → Sensor → Sensor config → Profile density → Prof dens offset (8173)

Description

Defines an offset value which is added to the measured profile density value.

User entry

-999.99 to 999.99 kg/m³

Factory setting





0 kg/m³

Additional information

Read access	Operator
Write access	Maintenance

3.2.5 "Calibration" submenu





Navigation  Expert → Sensor → Calibration

▶ Calibration	
▶ Move displacer	→  95
▶ Sensor calibration	→  97
▶ Reference calibration	→  100
▶ Drum calibration	→  102
▶ Calibration parameters	→  105

"Move displacer" wizard

Navigation  Expert → Sensor → Calibration → Move displacer

▶ Move displacer

Move distance	→  95
Net Distance	→  95
Move displacer	→  96
Motor status	→  96
Move displacer	→  96

Move distance 

Navigation  Expert → Sensor → Calibration → Move displacer → Move distance

Description Up or down movement of displacer in mm.

User entry 0 to 999 999.9 mm

Factory setting 0 mm

Additional information

Read access	Operator
Write access	Maintenance

Distance

Navigation  Expert → Sensor → Calibration → Move displacer → Distance (8103)

Description Shows measured distance from reference position.

Additional information

Read access	Operator
Write access	-

Move displacer**Navigation**

Expert → Sensor → Calibration → Move displacer → Move displacer

Selection

- Stop
- Move down
- Move up

Factory setting

Stop

Additional information

Read access	Operator
Write access	Maintenance

Motor status**Navigation**

Expert → Sensor → Calibration → Move displacer → Motor status (8118)

Description

Shows the current moving Direction of the Motor.

Additional information

Read access	Operator
Write access	-

Move displacer**Navigation**

Expert → Sensor → Calibration → Move displacer → Move displacer

Selection

- No
- Yes

Factory setting

No







Additional information

Read access	Operator
Write access	Maintenance

"Sensor calibration" wizard

Navigation  Expert → Sensor → Calibration → Sensor cal.

▶ **Sensor calibration**

Sensor calibration	→  97
Offset weight	→  97
Span weight	→  98
Zero calibration	→  98
Calibration status	→  98
Offset calibration	→  99
Span calibration	→  99

Sensor calibration



Navigation  Expert → Sensor → Calibration → Sensor cal. → Sensor cal.

Description This sequence calibrates the sensor of the servo.

Additional information

Read access	Operator
Write access	Maintenance

Offset weight



Navigation  Expert → Sensor → Calibration → Sensor cal. → Offset wgt. (8095)

Description Sets the weight that is used for the lower point sensor calibration. Changing the value will delete the calibration data.

User entry 0 to 150 g

Factory setting Dependent on the device version

Additional information

Read access	Operator
Write access	Maintenance

 The recommended offset weight value to improve measurement accuracy varies depending on the liquid density of applications. Use the weight close to the value determined by the following formula.

$$(\text{Recommended offset weight [g]}) = (\text{Displacer weight [g]}) - ((\text{Application density [g/cm}^3\text{]}) \times (\text{Displacer Volume [ml]}))$$

Span weight**Navigation**

 Expert → Sensor → Calibration → Sensor cal. → Span wgt. (8096)

Description

Sets the weight that is used for the middle point sensor calibration. Changing the value will delete the calibration data.

User entry

10 to 999.9 g

Factory setting

Dependent on the device version

Additional information

Read access	Operator
Write access	Maintenance

Zero calibration**Navigation**

 Expert → Sensor → Calibration → Sensor cal. → Zero calibration

Description

In this step the sensor calibration zero weight will be done.

Additional information

Read access	Operator
Write access	Maintenance

Calibration status**Navigation**

 Expert → Sensor → Calibration → Sensor cal. → Status (8031)

Description

Gives feedback on the latest status of the calibration process.

Additional information

Read access	Operator
Write access	-

Offset calibration



Navigation

Expert → Sensor → Calibration → Sensor cal. → Offset cal.

Description

In this step the sensor calibration with offset weight will be done.

Additional information

Read access	Operator
Write access	Maintenance

Span calibration



Navigation

Expert → Sensor → Calibration → Sensor cal. → Span calibration

Description

In this step the sensor calibration with span weight will be done.





Additional information

Read access	Operator
Write access	Maintenance

"Reference calibration" wizard

Navigation  Expert → Sensor → Calibration → Reference cal.

▶ Reference calibration

Reference calibration	→  100
Reference position	→  100
Progress	→  100
Calibration status	→  101

Reference calibration 

Navigation  Expert → Sensor → Calibration → Reference cal. → Reference cal.

Description This sequence will move the displacer to the mechanical stop and set the reference position.

Additional information

Read access	Operator
Write access	Maintenance

Reference position 

Navigation  Expert → Sensor → Calibration → Reference cal. → Ref. position (8046)

Description Defines in mm, during reference calibration, the distance between mechanical stop inside the drum housing and the middle of the wire ring.

User entry 0 to 9999.9 mm

Factory setting Dependent on the device version

Additional information

Read access	Operator
Write access	Maintenance

Progress 

Navigation  Expert → Sensor → Calibration → Reference cal. → Progress

Description Gives feedback on the latest status of the reference calibration process.

Additional information

Read access	Operator
Write access	Maintenance

Calibration status

Navigation

 Expert → Sensor → Calibration → Reference cal. → Status (8031)

Description

Gives feedback on the latest status of the calibration process.









Additional information

Read access	Operator
Write access	-

"Drum calibration" wizard

Navigation  Expert → Sensor → Calibration → Drum cal.

▶ Drum calibration

Make sure to have	→  102
Drum calibration	→  102
Calibration time	→  103
Set high weight	→  103
Make drum table	→  103
Drum table point	→  103
Calibration status	→  104
Make low table	→  104
Set low weight	→  104

Make sure to have

Navigation

 Expert → Sensor → Calibration → Drum cal. → Make sure

Additional information

Read access	Operator
Write access	-

Drum calibration

Navigation

 Expert → Sensor → Calibration → Drum cal. → Drum cal.

Description

This sequence will perform a drum calibration.

Additional information

Read access	Operator
Write access	Maintenance

Calibration time

Navigation  Expert → Sensor → Calibration → Drum cal. → Time

Description Time until drum calibration is finished.

Additional information

Read access	Operator
Write access	-

Set high weight 

Navigation  Expert → Sensor → Calibration → Drum cal. → Set high weight (8116)

Description High weight that is used for a drum calibration (normally it is the displacer weight).

User entry 10 to 999.9 g

Factory setting Dependent on the device version

Additional information

Read access	Operator
Write access	Maintenance

Make drum table 

Navigation  Expert → Sensor → Calibration → Drum cal. → Make drum table

Description This will perform a drum calibration.

Additional information

Read access	Operator
Write access	Maintenance

Drum table point

Navigation  Expert → Sensor → Calibration → Drum cal. → Drum table point

Description Shows the currently measured point of the drum calibration. Maximum number of measured points is 50.

Additional information

Read access	Operator
Write access	-

Calibration status

Navigation  Expert → Sensor → Calibration → Drum cal. → Status (8031)

Description Gives feedback on the latest status of the calibration process.

Additional information

Read access	Operator
Write access	-

Make low table



Navigation  Expert → Sensor → Calibration → Drum cal. → Make low table

Description For additional accuracy it is possible to perform a second drum calibration with low weight. Choose "Yes" or "No" to start/stop calibration.

Selection

- No
- Yes

Factory setting No

Additional information

Read access	Operator
Write access	Maintenance

Set low weight



Navigation  Expert → Sensor → Calibration → Drum cal. → Set low weight (8115)

Description Set weight for additional drum calibration sequence.

User entry 10 to 999.9 g

Factory setting Dependent on the device version







Additional information

Read access	Operator
Write access	Maintenance

"Calibration parameters" submenu

Navigation  Expert → Sensor → Calibration → Calib parameters

▶ Calibration parameters

Set high weight	→  105
Set low weight	→  105
Reference position	→  106
Offset weight	→  106
Span weight	→  106
Calibration status	→  107

Set high weight 

Navigation  Expert → Sensor → Calibration → Calib parameters → Set high weight (8116)

Description High weight that is used for a drum calibration (normally it is the displacer weight).

User entry 10 to 999.9 g

Factory setting Dependent on the device version

Additional information

Read access	Operator
Write access	Maintenance

Set low weight 

Navigation  Expert → Sensor → Calibration → Calib parameters → Set low weight (8115)

Description Set weight for additional drum calibration sequence.



User entry 10 to 999.9 g

Factory setting Dependent on the device version



Additional information

Read access	Operator
Write access	Maintenance

Reference position



Navigation	  Expert → Sensor → Calibration → Calib parameters → Ref. position (8046)				
Description	Defines in mm, during reference calibration, the distance between mechanical stop inside the drum housing and the middle of the wire ring.				
User entry	0 to 9 999.9 mm				
Factory setting	Dependent on the device version				
Additional information	<table border="1"> <tr> <td>Read access</td> <td>Operator</td> </tr> <tr> <td>Write access</td> <td>Maintenance</td> </tr> </table>	Read access	Operator	Write access	Maintenance
Read access	Operator				
Write access	Maintenance				



Offset weight

Navigation	  Expert → Sensor → Calibration → Calib parameters → Offset wgt. (8095)				
Description	Sets the weight that is used for the lower point sensor calibration. Changing the value will delete the calibration data.				
User entry	0 to 150 g				
Factory setting	Dependent on the device version				
Additional information	<table border="1"> <tr> <td>Read access</td> <td>Operator</td> </tr> <tr> <td>Write access</td> <td>Maintenance</td> </tr> </table>	Read access	Operator	Write access	Maintenance
Read access	Operator				
Write access	Maintenance				

 The recommended offset weight value to improve measurement accuracy varies depending on the liquid density of applications. Use the weight close to the value determined by the following formula.

$$(\text{Recommended offset weight [g]}) = (\text{Displacer weight [g]}) - ((\text{Application density [g/cm}^3\text{]}) \times (\text{Displacer Volume [ml]}))$$

Span weight



Navigation	  Expert → Sensor → Calibration → Calib parameters → Span wgt. (8096)
Description	Sets the weight that is used for the middle point sensor calibration. Changing the value will delete the calibration data.
User entry	10 to 999.9 g
Factory setting	Dependent on the device version

Additional information

Read access	Operator
Write access	Maintenance

Calibration status

Navigation

 Expert → Sensor → Calibration → Calib parameters → Status (8031)

Description





Gives feedback on the latest status of the calibration process.

Additional information

Read access	Operator
Write access	-





3.3 "Input/output" submenu

Navigation  Expert → Input/output

▶ Input/output	
▶ HART devices	→  109
▶ Analog IP	→  140
▶ Analog I/O	→  149
▶ Digital Xx-x	→  162
▶ Digital input mapping	→  168

3.3.1 "HART devices" submenu

Navigation  Expert → Input/output → HART devices

▶ HART devices		
Number of devices		→  109
▶ HART Device(s)		→  110
▶ Forget device		→  138
▶ #blank#		→  138

Number of devices

Navigation  Expert → Input/output → HART devices → Number devices (13051)

Description Shows the number of devices on the HART bus.

Additional information



















Read access	Operator
Write access	-

"HART Device(s)" submenu

 There is a **HART Device(s)** submenu for each HART slave device found on the HART loop.

Navigation

 Expert → Input/output → HART devices → HART Device(s)

▶ HART Device(s)	
Device name	→  111
Polling address	→  111
Device tag	→  111
Operating mode	→  111
Communication status	→  112
Status signal	→  112
#blank# (PV - designation dependent on device)	→  113
#blank# (SV - designation dependent on device)	→  113
#blank# (TV - designation dependent on device)	→  113
#blank# (QV - designation dependent on device)	→  113
HART device PV mA	→  114
HART device PV %	→  114
Output pressure	→  114
Output density	→  115
Output temperature	→  115
Output vapor temperature	→  115
Output level	→  116
▶ HART device information	→  117
▶ Element values	→  123

▶ Diagnostics	→ 📄 124
▶ Diagnostics	→ 📄 125
▶ NMT device config	→ 📄 127

Device name

Navigation  Expert → Input/output → HART devices → HART Device(s) → Device name (14722)

Description Shows the name of the transmitter.

Additional information

Read access	Operator
Write access	-

Polling address

Navigation  Expert → Input/output → HART devices → HART Device(s) → Polling address (14712)

Description Shows the polling address of the transmitter.

Additional information

Read access	Operator
Write access	-

Device tag

Navigation  Expert → Input/output → HART devices → HART Device(s) → Device tag (14713)

Description Shows the device tag of the transmitter.

Additional information

Read access	Operator
Write access	-

Operating mode

Navigation  Expert → Input/output → HART devices → HART Device(s) → Operating mode (14745)

Prerequisite Not available if the HART device is a Prothermo NMT.

Description Selection of the operation mode PV only or PV,SV,TV,QV. Devines which values are polled from the connected HART Device.

- Selection**
- PV only
 - PV,SV,TV & QV
 - Level ²⁾
 - Measured level ²⁾

Factory setting PV,SV,TV & QV

Additional information

Read access	Operator
Write access	Maintenance

Communication status

Navigation  Expert → Input/output → HART devices → HART Device(s) → Comm. status (14710)

Description Shows the operating status of the transmitter.

- User interface**
- Operating normally
 - Device offline

Additional information

Read access	Operator
Write access	-

Status signal

Navigation  Expert → Input/output → HART devices → HART Device(s) → Status signal (14760)



Description Indicates the current device status in accordance with VDI/VDE 2650 and NAMUR Recommendation NE 107.

- User interface**
- OK
 - Failure (F)
 - Function check (C)
 - Out of specification (S)
 - Maintenance required (M)
 - ---
 - No effect (N)
 - ---

Factory setting ---

2) only visible if the connected device is a Micropilot

#blank# (HART PV - designation dependent on device)

Navigation   Expert → Input/output → HART devices → HART Device(s) → #blank# (14716)

Description Shows the first HART variable (PV).

Additional information

Read access	Operator
Write access	-

#blank# (HART SV - designation dependent on device)

Navigation   Expert → Input/output → HART devices → HART Device(s) → #blank# (14705)

Prerequisite For HART devices other than NMT: **Operating mode** (→  111) = PV,SV,TV & QV

Description Shows the second HART variable (SV).

Additional information

Read access	Operator
Write access	-

#blank# (HART TV - designation dependent on device)

Navigation   Expert → Input/output → HART devices → HART Device(s) → #blank# (14706)

Prerequisite For HART devices other than NMT: **Operating mode** (→  111) = PV,SV,TV & QV

Description Shows the third HART variable (TV).

Additional information

Read access	Operator
Write access	-

#blank# (HART QV - designation dependent on device)

Navigation   Expert → Input/output → HART devices → HART Device(s) → #blank# (14716)

Prerequisite For HART devices other than NMT: **Operating mode** (→  111) = PV,SV,TV & QV

Description Shows the fourth HART variable (QV).

Additional information

Read access	Operator
Write access	-

HART device PV mA

Navigation	 Expert → Input/output → HART devices → HART Device(s) → HARTDEV PV mA (14708)				
Prerequisite	Not available for Micropilot S FMR5xx and Prothermo 53x.				
Description	Shows the first HART variable (PV) in mA.				
Additional information	<table border="1"> <tr> <td>Read access</td> <td>Operator</td> </tr> <tr> <td>Write access</td> <td>-</td> </tr> </table>	Read access	Operator	Write access	-
Read access	Operator				
Write access	-				

HART device PV %

Navigation	 Expert → Input/output → HART devices → HART Device(s) → HARTDEV PV % (14709)				
Prerequisite	Not available for Micropilot S FMR5xx and Prothermo 53x.				
Description	Shows the first HART variable (PV) in percentage.				
Additional information	<table border="1"> <tr> <td>Read access</td> <td>Operator</td> </tr> <tr> <td>Write access</td> <td>-</td> </tr> </table>	Read access	Operator	Write access	-
Read access	Operator				
Write access	-				

Output pressure



Navigation	 Expert → Input/output → HART devices → HART Device(s) → Output pressure (14719)				
Prerequisite	Not available for Micropilot S FMR5xx, Prothermo NMT53x and Prothermo NMT8x. In these cases the measured variables are allocated automatically.				
Description	Defines which HART variable is the pressure.				
Selection	<ul style="list-style-type: none"> ■ No value ■ Primary variable (PV) ■ Secondary variable (SV) ■ Tertiary variable (TV) ■ Quaternary variable (QV) 				
Factory setting	No value				
Additional information	<table border="1"> <tr> <td>Read access</td> <td>Operator</td> </tr> <tr> <td>Write access</td> <td>Maintenance</td> </tr> </table>	Read access	Operator	Write access	Maintenance
Read access	Operator				
Write access	Maintenance				

Output density



Navigation Expert → Input/output → HART devices → HART Device(s) → Output density (14720)

Prerequisite Not available for Micropilot S FMR5xx, Prothermo NMT53x and Prothermo NMT8x. In these cases the measured variables are allocated automatically.

Description Defines which HART variable is the density.

- Selection**
- No value
 - Primary variable (PV)
 - Secondary variable (SV)
 - Tertiary variable (TV)
 - Quaternary variable (QV)

Factory setting No value

Additional information

Read access	Operator
Write access	Maintenance

Output temperature



Navigation Expert → Input/output → HART devices → HART Device(s) → Output temp. (14721)

Prerequisite Not available for Micropilot S FMR5xx, Prothermo NMT53x and Prothermo NMT8x. In these cases the measured variables are allocated automatically.

Description Defines which HART variable is the temperature.

- Selection**
- No value
 - Primary variable (PV)
 - Secondary variable (SV)
 - Tertiary variable (TV)
 - Quaternary variable (QV)

Factory setting No value

Additional information

Read access	Operator
Write access	Maintenance

Output vapor temperature



Navigation Expert → Input/output → HART devices → HART Device(s) → Output vapor tmp (14726)

Prerequisite Not available for Micropilot S FMR5xx, Prothermo NMT53x and Prothermo NMT8x. In these cases the measured variables are allocated automatically.

Description Defines which HART variable is the vapor temperature.

Selection



- No value
- Primary variable (PV)
- Secondary variable (SV)
- Tertiary variable (TV)
- Quaternary variable (QV)

Factory setting No value

Additional information

Read access	Operator
Write access	Maintenance

Output level

Navigation   Expert → Input/output → HART devices → HART Device(s) → Output level (14718)

Prerequisite Not available for Micropilot S FMR5xx, Prothermo NMT53x and Prothermo NMT8x. In these cases the measured variables are allocated automatically.

Description Defines which HART variable is the level.

Selection



- No value
- Primary variable (PV)
- Secondary variable (SV)
- Tertiary variable (TV)
- Quaternary variable (QV)

















Factory setting No value

Additional information

Read access	Operator
Write access	Maintenance

"HART device information" submenu

Navigation   Expert → Input/output → HART devices → HART Device(s) → HART device info

▶ HART device information	
Pressure	→  117
Density	→  118
Temperature	→  118
Vapor temperature	→  118
Water level	→  119
Level source	→  119
Tank level to NMT	→  119
Manual value	→  120
HART bus	→  120
Device type	→  120
Device ID	→  120
Device date	→  121
Device description	→  121
Device message	→  121
Software version	→  121
Firmware CRC	→  122
Custody transfer	→  122

Pressure

Navigation

  Expert → Input/output → HART devices → HART Device(s) → HART device info → Pressure (14723)

Prerequisite

Output pressure (→  114) ≠ No value

Description Shows the pressure value measured by the connected HART device.

Additional information

Read access	Operator
Write access	-

Density

Navigation

 Expert → Input/output → HART devices → HART Device(s) → HART device info → Density (14724)

Prerequisite

Output density (→  115) ≠ No value

Description

Shows the density value measured by the connected HART device.

Additional information

Read access	Operator
Write access	-

Temperature

Navigation

 Expert → Input/output → HART devices → HART Device(s) → HART device info → Temperature (14725)

Prerequisite

Output temperature (→  115) ≠ No value

Description

Shows the temperature measured by the connected HART device.

Additional information

Read access	Operator
Write access	-

Vapor temperature

Navigation

 Expert → Input/output → HART devices → HART Device(s) → HART device info → Vapor temp. (14727)

Prerequisite

Output vapor temperature (→  115) ≠ No value



Description

Shows the temperature value of the vapor phase measured by the connected HART device.

Additional information

Read access	Operator
Write access	-

Water level

Navigation   Expert → Input/output → HART devices → HART Device(s) → HART device info → Water level (14717)

Prerequisite **Output level (→  116) ≠ No value**



Description Shows the water level value measured by the connected HART device.

Additional information

Read access	Operator
Write access	-

Level source



Navigation   Expert → Input/output → HART devices → HART Device(s) → HART device info → Level source (14749)

Prerequisite Prothermo NMT53x

Description Shows which source should be used for level reference sent to NMT to determine liquid/vapour temperature. Tank level or manual level.

Selection



- Manual value
- Tank level

Factory setting Tank level

Additional information

Read access	Maintenance
Write access	Maintenance

Tank level to NMT

Navigation   Expert → Input/output → HART devices → HART Device(s) → HART device info → Tank lvl to NMT (14750)

Prerequisite Prothermo NMT53x with level measurement

Description Shows the level transferred to NMT.

Additional information

Read access	Maintenance
Write access	-

Manual value



Navigation Expert → Input/output → HART devices → HART Device(s) → HART device info → Manual value (14746)

Prerequisite Prothermo NMT53x with level measurement

Description Shows the manual set level.

User entry Signed floating-point number

Factory setting 0 mm

Additional information

Read access	Maintenance
Write access	Maintenance

HART bus

Navigation Expert → Input/output → HART devices → HART Device(s) → HART device info → HART bus (14711)

Description Information about the used IO-Slot.

Additional information

Read access	Operator
Write access	-

Device type

Navigation Expert → Input/output → HART devices → HART Device(s) → HART device info → Device type (14701)

Description Shows the device type with which the measuring device is registered with the HART Communication Foundation.

Additional information

Read access	Operator
Write access	-

Device ID

Navigation Expert → Input/output → HART devices → HART Device(s) → HART device info → Device ID (14702)

Description Shows the device ID of the connected HART device.

Additional information

Read access	Operator
Write access	-

Device date

Navigation

  Expert → Input/output → HART devices → HART Device(s) → HART device info → Device date (14707)

Description



Shows the date of the connected HART device. (e.g.: the last configuration change).

Additional information

Read access	Operator
Write access	-

Device description

Navigation

  Expert → Input/output → HART devices → HART Device(s) → HART device info → Device descrip. (14704)

Description



Shows a user defined HART descriptor of the connected device.

Additional information

Read access	Operator
Write access	-

Device message

Navigation

  Expert → Input/output → HART devices → HART Device(s) → HART device info → Device message (14703)

Description

Shows a user defined HART message of the connected device.

Additional information

Read access	Operator
Write access	-

Software version

Navigation

  Expert → Input/output → HART devices → HART Device(s) → HART device info → Software version (14747)

Prerequisite

Prothermo NMT53x

Description

Shows the software version of the NMT device.

Additional information

Read access	Maintenance
Write access	-

Firmware CRC**Navigation**

 Expert → Input/output → HART devices → HART Device(s) → HART device info → Firmware CRC (14758)

User interface

Positive integer

Factory setting

0

Additional information

Read access	Maintenance
Write access	-

Custody transfer**Navigation**

 Expert → Input/output → HART devices → HART Device(s) → HART device info → Custody transfer (14748)

Prerequisite

Prothermo NMT53x with temperature measurement

Description

Shows information about hardware lock of NMT device. Off -> NMT parameter can be changed. On -> NMT parameter can not be changed.

Additional information

Read access	Maintenance
Write access	-

"Element values" submenu

 This submenu is only available for Prothermo NMT53x.

Navigation  Expert → Input/output → HART devices → HART Device(s) → Element values

"Element temperature" submenu

Navigation  Expert → Input/output → HART devices → HART Device(s) → Element values → Element temp.

Element temperature 1 to 24

Navigation  Expert → Input/output → HART devices → HART Device(s) → Element values → Element temp. → Element temp 1 to 24 (14984-1 to 24)

Description Shows the temperature of an element in the NMT.

Additional information

Read access	Operator
Write access	-

"Element position" submenu

Navigation  Expert → Input/output → HART devices → HART Device(s) → Element values → Element position

Element position 1 to 24

Navigation  Expert → Input/output → HART devices → HART Device(s) → Element values → Element position → Element pos. 1 to 24 (15014-1 to 24)

Description Shows the position of the selected element in the NMT.

Additional information





Read access	Operator
Write access	-

"Diagnostics" submenu

 This submenu is only available for Prothermo NMT53x.

Navigation  Expert → Input/output → HART devices → HART Device(s) → Diagnostics

▶ Diagnostics

Diagnostic code	→  124
Last diagnostic	→  124
Reference 0	→  124
Reference 17	→  125

Diagnostic code

Navigation  Expert → Input/output → HART devices → HART Device(s) → Diagnostics → Diag. code (14739)

Description Shows the current diagnostic code of NMT. Check NMT manual for details.

Additional information

Read access	Operator
Write access	-

Last diagnostic

Navigation  Expert → Input/output → HART devices → HART Device(s) → Diagnostics → Last Diagnostic (14742)

Description Shows the previous diagnostic code of NMT. Check NMT manual for details.

Additional information

Read access	Operator
Write access	-

Reference 0

Navigation  Expert → Input/output → HART devices → HART Device(s) → Diagnostics → Reference 0 (14740)



Prerequisite Prothermo NMT53x with temperature measurement.

Description Shows the temperature of internal reference element 0.

Additional information

Read access	Operator
Write access	-

Reference 17

Navigation   Expert → Input/output → HART devices → HART Device(s) → Diagnostics → Reference 17 (14741)

Prerequisite Prothermo NMT53x with temperature measurement.

Description Shows the temperature of internal reference element 17.

Additional information





Read access	Operator
Write access	-

"Diagnostics" submenu



 This submenu is only available for Prothermo NMT8x.

Navigation   Expert → Input/output → HART devices → HART Device(s) → Diagnostics

▶ **Diagnostics**

- Active diagnostics →  125
- Previous diagnostics →  126
- Test resistance →  126
- WB frequency ratio →  126

Active diagnostics

Navigation   Expert → Input/output → HART devices → HART Device(s) → Diagnostics → Active diagnos. (14754)

User interface Character string comprising numbers, letters and special characters

Factory setting

Additional information

Read access	Operator
Write access	-

Previous diagnostics**Navigation**

 Expert → Input/output → HART devices → HART Device(s) → Diagnostics → Prev.diagnostics (14755)

User interface

Character string comprising numbers, letters and special characters

Factory setting**Additional information**

Read access	Operator
Write access	-

Test resistance**Navigation**

 Expert → Input/output → HART devices → HART Device(s) → Diagnostics → Test resistance (14752)

User interface

Signed floating-point number

Factory setting

0 Ohm

Additional information

Read access	Operator
Write access	-

WB frequency ratio**Navigation**

 Expert → Input/output → HART devices → HART Device(s) → Diagnostics → WB freq. ratio (14753)

User interface

Signed floating-point number

Factory setting



0

















Additional information

Read access	Operator
Write access	-

"NMT device config" submenu

 This submenu is only present if the connected HART device is a Prothermo NMT5xx.



Navigation   Expert → Input/output → HART devices → HART Device(s) → NMT dev. config

► NMT device config	
Configure device?	→  127
Access code	→  128
Total no. element	→  128
Bottom point	→  129
Temperature element short	→  129
Temperature element open	→  129
Output at error	→  130
Gain adjust	→  130
Kind of interval	→  130
Element interval	→  131
Update water level	→  131
► Element setup	→  132
Select element	→  132
Zero adjust	→  132
Element temperature	→  133
Element position	→  133

Configure device?



Navigation

  Expert → Input/output → HART devices → HART Device(s) → NMT dev. config → Config. device? (14728)

Description

Enable NMT device configuration.

Bottom point



Navigation Expert → Input/output → HART devices → HART Device(s) → NMT dev. config → Bottom point (14729)

Description Shows the bottom clearance from the end of temperature probe or WB probe.

User entry Signed floating-point number

Factory setting 0 mm

Additional information

Read access	Operator
Write access	Maintenance

Temperature element short



Navigation Expert → Input/output → HART devices → HART Device(s) → NMT dev. config → Temp elem. short (14731)

Description Sets the displayed temperature if element is broken (shorten).

User entry Signed floating-point number

Factory setting 0 °C

Additional information

Read access	Operator
Write access	Maintenance

Temperature element open



Navigation Expert → Input/output → HART devices → HART Device(s) → NMT dev. config → Temp. elem. open (14732)

Description Sets the displayed temperature if element is not connected (open).

User entry Signed floating-point number

Factory setting 0 °C

Additional information

Read access	Operator
Write access	Maintenance

Output at error**Navigation**

Expert → Input/output → HART devices → HART Device(s) → NMT dev. config
→ Output at error (14733)

Description

Off -> Defective element will not be used in average calculation. On -> Defective element generate error at output value.

Selection

- Off
- On

Factory setting

Off

Additional information

Read access	Operator
Write access	Maintenance

Gain adjust**Navigation**

Expert → Input/output → HART devices → HART Device(s) → NMT dev. config
→ Gain adjust (14736)

Description

Adjustment of all shown temperature elements. Also reference elements 0 and 17. e.g. 0.8 -> 80% 1.0 -> 100% of factory calibration 1.2 -> 120%.

User entry

Signed floating-point number

Factory setting

0

Additional information

Read access	Operator
Write access	Maintenance

Kind of interval**Navigation**

Expert → Input/output → HART devices → HART Device(s) → NMT dev. config
→ Kind of interval (14744)

Description

Determines how the element positions are defined.

Selection

- Even
- Not even

Factory setting

Even

Additional information

Meaning of the options

- **Even**
First position bottom point + element interval for every next element.
- **Not even**
Position of elements can be set manually.

Read access	Operator
Write access	Maintenance

Element interval



Navigation

Expert → Input/output → HART devices → HART Device(s) → NMT dev. config → Element interval (14743)

Prerequisite

Kind of interval (→ 130) = **Even**

Description

Shows the distance between the temperature elements used if kind of interval parameter is set to even.

User entry

Signed floating-point number

Factory setting

0 mm

Additional information

Read access	Operator
Write access	Maintenance

Update water level



Navigation

Expert → Input/output → HART devices → HART Device(s) → NMT dev. config → Water level upd. (14751)

Description

Select if water level value is transferred to NMT or not.

Selection

- Enabled
- Disabled

Factory setting

Disabled

Additional information

- Enabled: Water level value is transferred
- Disabled: Water level value is **not** transferred

The NMT delivers the average liquid temperature value in a tank by picking up the value of all temperature elements which are covered by liquid and calculating the average value. To select the submerged temperature elements, the NMT receives level information from a tank gauging device. If the water bottom temperature shall be excluded from the measurement, the water level value is used to exclude the temperature elements which are submerged in water.

Read access	Operator
Write access	Maintenance

"Element setup" submenu

Navigation  Expert → Input/output → HART devices → HART Device(s)
→ NMT dev. config → Element setup

Select element 

Navigation  Expert → Input/output → HART devices → HART Device(s) → NMT dev. config
→ Element setup → Select element (14734)

Description Chooses the temperature element to be configured manually.

User entry 1 to 24

Factory setting 1

Additional information

Read access	Operator
Write access	Maintenance

Zero adjust 

Navigation  Expert → Input/output → HART devices → HART Device(s) → NMT dev. config
→ Element setup → Zero adjust (14735)

Description Adjusts the offset of the selected temperature element.

User interface Signed floating-point number

Factory setting 0 None

Additional information

Read access	Operator
Write access	Service

Element temperature

Navigation  Expert → Input/output → HART devices → HART Device(s) → NMT dev. config → Element setup → Element temp. (14737)

Description Shows the temperature of the element.

Additional information

Read access	Operator
Write access	-

Element position



Navigation  Expert → Input/output → HART devices → HART Device(s) → NMT dev. config → Element setup → Element position (14738)

Description Shows the position of the temperature element.

User interface Signed floating-point number

Factory setting 0 mm

Additional information





Read access	Operator
Write access	Service

"NMT device config" submenu

 This submenu is only present if the connected HART device is a Prothermo NMT8x.

Navigation  Expert → Input/output → HART devices → HART Device(s) → NMT dev. config

▶ **NMT device config**

Configure device?	→  134
Total no. element	→  134
Bottom point	→  135
No element in phase	→  135
Water bottom level offset	→  135

Update water level	→ 136
▶ Element setup	→ 136
Select element	→ 136
Zero adjust	→ 137
Element temperature	→ 137
Element position	→ 137

Configure device?



Navigation

Expert → Input/output → HART devices → HART Device(s) → NMT dev. config → Config. device? (14728)

Description

Enable NMT device configuration.

Selection

- No
- Yes

Factory setting

No

Additional information

Meaning of the options

- **No**
Not configurable
- **Yes**
Configurable

Read access	Operator
Write access	Maintenance

Total no. element



Navigation

Expert → Input/output → HART devices → HART Device(s) → NMT dev. config → Total elements (14730)

Description

Shows the total amount of configurable temperature elements.

Additional information

Read access	Operator
Write access	-

Bottom point



Navigation Expert → Input/output → HART devices → HART Device(s) → NMT dev. config → Bottom point (14729)

Description Shows the bottom clearance from the end of temperature probe or WB probe.

User entry Signed floating-point number

Factory setting 0 mm

Additional information

Read access	Operator
Write access	Maintenance

No element in phase

Navigation Expert → Input/output → HART devices → HART Device(s) → NMT dev. config → No elm. in phase (14756)

Selection

- Alarm
- Warning
- Logbook entry only

Factory setting Alarm

Additional information

Read access	Operator
Write access	Operator

Water bottom level offset

Navigation Expert → Input/output → HART devices → HART Device(s) → NMT dev. config → WB level offset (14757)

User entry Signed floating-point number

Factory setting 0 mm

Additional information

Read access	Operator
Write access	Operator

Update water level



Navigation Expert → Input/output → HART devices → HART Device(s) → NMT dev. config → Water level upd. (14751)

Description Select if water level value is transferred to NMT or not.

Selection

- Enabled
- Disabled

Factory setting Disabled

Additional information

- Enabled: Water level value is transferred
- Disabled: Water level value is **not** transferred

The NMT delivers the average liquid temperature value in a tank by picking up the value of all temperature elements which are covered by liquid and calculating the average value. To select the submerged temperature elements, the NMT receives level information from a tank gauging device. If the water bottom temperature shall be excluded from the measurement, the water level value is used to exclude the temperature elements which are submerged in water.

Read access	Operator
Write access	Maintenance

"Element setup" submenu

Navigation Expert → Input/output → HART devices → HART Device(s) → NMT dev. config → Element setup

▶ **Element setup**

Select element	→ 136
Zero adjust	→ 137
Element temperature	→ 137
Element position	→ 137

Select element



Navigation Expert → Input/output → HART devices → HART Device(s) → NMT dev. config → Element setup → Select element (14734)

Description Chooses the temperature element to be configured manually.

User entry 1 to 24

Factory setting 1

Additional information

Read access	Operator
Write access	Maintenance

Zero adjust



Navigation

Expert → Input/output → HART devices → HART Device(s) → NMT dev. config → Element setup → Zero adjust (14759)

User interface Signed floating-point number

Factory setting 0 °C

Additional information

Read access	Operator
Write access	Maintenance

Element temperature

Navigation

Expert → Input/output → HART devices → HART Device(s) → NMT dev. config → Element setup → Element temp. (14737)

Description Shows the temperature of the element.

Additional information

Read access	Operator
Write access	-

Element position



Navigation

Expert → Input/output → HART devices → HART Device(s) → NMT dev. config → Element setup → Element position (14738)

Description Shows the position of the temperature element.

User interface Signed floating-point number

Factory setting 0 mm

Additional information

Read access	Operator
Write access	Service

"Forget device" wizard

 This submenu is only available if there is at least one unlocked device at the bus.

Navigation  Expert → Input/output → HART devices → Forget device

Forget device



Navigation

 Expert → Input/output → HART devices → Forget device → Forget device

Description

With this function an offline device can be deleted from the device list.

Selection

- HART Device 1 *
- HART Device 2 *
- HART Device 3 *
- HART Device 4 *
- HART Device 5 *
- HART Device 6 *
- HART Device 7 *
- HART Device 8 *
- HART Device 9 *
- HART Device 10 *
- HART Device 11 *
- HART Device 12 *
- HART Device 13 *
- HART Device 14 *
- HART Device 15 *
- None

Factory setting

None

Additional information

Read access	Operator
Write access	Maintenance

HART Bus interface

Navigation  Expert → Input/output → HART devices → #blank#

▶ #blank#

Operating mode

→  139

Current

→  139

* Visibility depends on order options or device settings

Operating mode

Navigation  Expert → Input/output → HART devices → #blank# → Operating mode (14453)

Description Shows the operation mode of this HART bus.

- User interface**
- None
 - Disable
 - HART master
 - HART slave +4..20mA output
 - HART tunnel

Factory setting None

Additional information

Read access	Operator
Write access	-

Current

Navigation  Expert → Input/output → HART devices → #blank# → Current (14457)

Description Shows the actual current on this HART bus.



User interface 0 to 100 000 mA

Factory setting 0 mA

Additional information

Read access	Operator
Write access	-

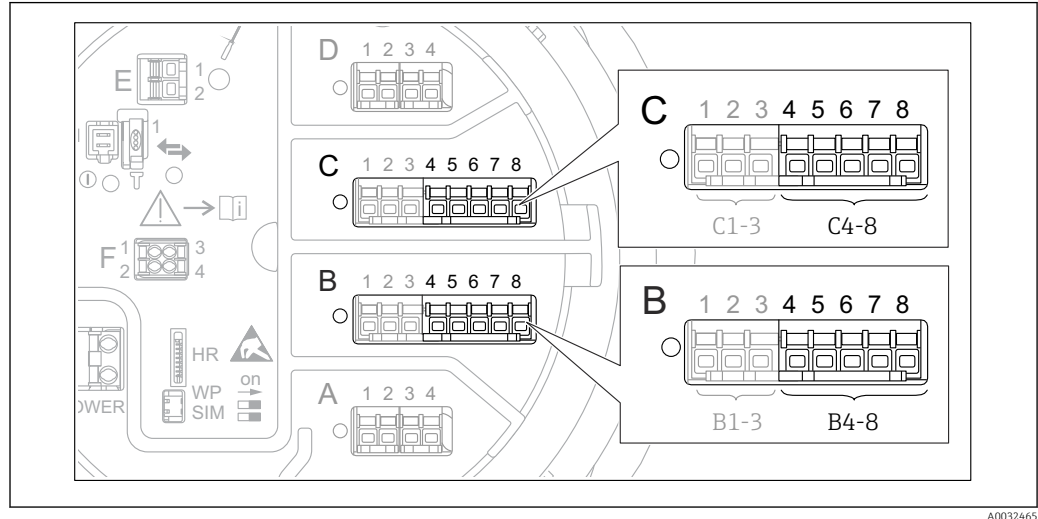

3.3.2 "Analog IP" submenu

i There is an **Analog IP** submenu (→  140) for each Analog I/O module of the device. This submenu refers to terminals 4 to 8 of this module (the analog input). They are primarily used to connect an RTD. For terminals 1 to 3 (analog input or output) refer to →  149.















 12 Terminals for the "Analog IP" submenu (→  140) ("B4-8" or "C4-8", respectively)

Navigation

  Expert → Input/output → Analog IP

▶ Analog IP

Operating mode	→  141
RTD type	→  141
Ohms offset	→  142
Thermocouple type	→  142
RTD connection type	→  143
Process value	→  143
Process variable	→  143
0 % value	→  144
100 % value	→  144
Input value percent	→  144
Input value	→  145
Temperature offset after conversion	→  145

Minimum probe temperature	→ 145
Maximum probe temperature	→ 146
Probe position	→ 146
Calibration type AIP	→ 147
Active calibration	→ 147
Damping factor	→ 147
Gauge current	→ 148

Operating mode



Navigation Expert → Input/output → Analog IP → Operating mode (14014)

Description Defines the operating mode of the analog input.

- Selection**
- Disabled
 - RTD temperature input
 - Gauge power supply

Factory setting Disabled

Additional information

Read access	Operator
Write access	Maintenance

RTD type



Navigation Expert → Input/output → Analog IP → RTD type (14021)

Prerequisite **Operating mode (→ 141) = RTD temperature input**

Description Defines the type of the connected RTD.

- Selection**
- Cu50 (w=1.428, GOST)
 - Cu53 (w=1.426, GOST)
 - Cu90; 0°C (w=1.4274, GOST)
 - Cu100; 25°C (w=1.4274, GOST)
 - Cu100; 0°C(w=1.4274, GOST)
 - Pt46 (w=1.391, GOST)
 - Pt50 (w=1.391, GOST)
 - Pt100(385) (a=0.00385, IEC751)
 - Pt100(389) (a=0.00389, Canadian)
 - Pt100(391) (a=0.003916, JIS1604)

- Pt100 (w=1.391, GOST)
- Pt500(385) (a=0.00385, IEC751)
- Pt1000(385) (a=0.00385, IEC751)
- Ni100(617) (a=0.00617, DIN43760)
- Ni120(672) (a=0.00672, DIN43760)
- Ni1000(617) (a=0.00617, DIN43760)

Factory setting

Pt100(385) (a=0.00385, IEC751)

Additional information

Read access	Operator
Write access	Maintenance

Ohms offset**Navigation**

Expert → Input/output → Analog IP → Ohms offset (14026)

Prerequisite**Operating mode (→ 141) = RTD temperature input****Description**

Defines a offset for the resistance.
This value is added to the measured resistance before the calculation of the temperature.

User entry

-10.0 to 10.0 Ohm

Factory setting

0 Ohm

Additional information

The value entered in this parameter is added to the measured resistance before the calculation of the temperature.

Read access	Operator
Write access	Maintenance

Thermocouple type**Navigation**

Expert → Input/output → Analog IP → Thermocouple typ (14008)

Description



Defines the type of the connected thermocouple.

Selection

- N type
- B type
- C type
- D type
- J type
- K type
- L type
- L GOST type
- R type
- S type
- T type
- U type

Factory setting N type

RTD connection type 

Navigation   Expert → Input/output → Analog IP → RTD connect type (14022)

Prerequisite **Operating mode (→  141) = RTD temperature input**

Description Defines the connection type of the RTD.



- Selection**
- 4 wire RTD connection
 - 2 wire RTD connection
 - 3 wire RTD connection

Factory setting 4 wire RTD connection

Additional information

Read access	Operator
Write access	Maintenance

Process value

Navigation   Expert → Input/output → Analog IP → Process value (14003)



Prerequisite **Operating mode (→  141) ≠ Disabled**

Description Shows the measured value received via the analog input.

Additional information

Read access	Operator
Write access	-

Process variable 

Navigation   Expert → Input/output → Analog IP → Process variable (14016)

Prerequisite **Operating mode (→  141) ≠ RTD temperature input**

Description Determines type of measured value.

- Selection**
- Level linearized
 - Temperature
 - Pressure
 - Density

Factory setting Level linearized

Additional information

Read access	Operator
Write access	Maintenance

0 % value**Navigation**

Expert → Input/output → Analog IP → 0 % value (14001)

Prerequisite

Operating mode (→ 141) = 4..20mA input

Description

Defines the value represented by a current of 4mA.

User entry

Signed floating-point number

Factory setting

0 mm

Additional information

Read access	Operator
Write access	Maintenance

100 % value**Navigation**

Expert → Input/output → Analog IP → 100 % value (14013)

Prerequisite

Operating mode (→ 141) = 4..20mA input

Description

Defines the value represented by a current of 20mA.

User entry

Signed floating-point number

Factory setting

0 mm

Additional information

Read access	Operator
Write access	Maintenance

Input value percent**Navigation**

Expert → Input/output → Analog IP → Input value [%] (14002)

Prerequisite

Operating mode (→ 141) = 4..20mA input

Description

Shows the input value in percent.

0% corresponds to 4 mA.

100% corresponds to 20 mA.

- Additional information**
- 0% corresponds to 4 mA
 - 100% corresponds to 20 mA

Read access	Operator
Write access	-

Input value

Navigation  Expert → Input/output → Analog IP → Input value (14015)

Prerequisite **Operating mode (→  141) ≠ Disabled**

Description Shows the value received via the analog input.

Additional information

Read access	Operator
Write access	-

Temperature offset after conversion



Navigation  Expert → Input/output → Analog IP → Temp. offset (14025)

Prerequisite **Operating mode (→  141) = RTD temperature input**

Description Defines an offset for the measured temperature.
The offset is applied after the resistance of the RTD has been converted to a temperature.

User entry -20 to 20 °C

Factory setting 0 °C

Additional information The offset defined in this parameter is applied after the resistance of the RTD has been converted to a temperature.

Read access	Operator
Write access	Maintenance

Minimum probe temperature



Navigation  Expert → Input/output → Analog IP → Min. probe temp (14010)

Prerequisite **Operating mode (→  141) = RTD temperature input**

Description Minimum approved temperature of the connected probe.
If the temperature falls below this value, the W&M status will be "invalid".

User entry -213 to 927 °C

Factory setting -100 °C

Additional information

Read access	Operator
Write access	Maintenance

Maximum probe temperature



Navigation

Expert → Input/output → Analog IP → Max. probe temp (14011)

Prerequisite

Operating mode (→ 141) = RTD temperature input

Description

Maximum approved temperature of the connected probe.
If the temperature rises above this value, the W&M status will be "invalid".

User entry

-213 to 927 °C

Factory setting

250 °C

Additional information

Read access	Operator
Write access	Maintenance

Probe position



Navigation

Expert → Input/output → Analog IP → Probe position (14009)

Prerequisite

Operating mode (→ 141) = RTD temperature input

Description

Position of the temperature probe, measured from zero position (tank bottom or datum plate). This parameter, in conjunction with the measured level, determines whether the temperature probe is still covered by the product. If this is no longer the case, the status of the temperature value will be "invalid".

User entry

-5 000 to 30 000 mm

Factory setting

5 000 mm

Additional information

Read access	Operator
Write access	Maintenance

Calibration type AIP



Navigation Expert → Input/output → Analog IP → Cal type AIP (14018)

Prerequisite **Operating mode (→ 141) ≠ Disabled**

Description Select calibration state of the analog input or output.

- Selection**
- User calibration
 - Factory calibration

Factory setting Factory calibration

Additional information **Meaning of the options**

- Not calibrated
This is a display option only. It can not be selected. It is shown if the analog input is not in a calibrated state.
- User calibration
Activates a user calibration. The user calibration itself is defined in the **User calibration** wizard.
- Factory calibration
Activates the factory calibration which is permanently stored in the device.

Read access	Operator
Write access	Maintenance

Active calibration

Navigation Expert → Input/output → Analog IP → Act. calibration (14012)

Prerequisite **Operating mode (→ 141) ≠ Disabled**

Description Shows calibration state of the analog input.

Additional information

Read access	Operator
Write access	-

Damping factor



Navigation Expert → Input/output → Analog IP → Damping factor (14004)

Prerequisite **Operating mode (→ 141) ≠ Disabled**

Description Defines the damping constant (in seconds).

User entry 0 to 999.9 s

Factory setting 0 s

Additional information

Read access	Operator
Write access	Maintenance

Gauge current

Navigation

 Expert → Input/output → Analog IP → Gauge current (14027)

Prerequisite

Operating mode (→  141) = Gauge power supply

Description

Shows the current on the power supply line for the connected device.

Additional information

Read access	Operator
Write access	-

3.3.3 "Analog I/O" submenu

i There is a **Analog I/O** submenu (→ 📖 149) for each Analog I/O module of the device. This submenu refers to terminals 1 to 3 of this module (an analog input or output). For terminals 4 to 8 (always an analog input) refer to → 📖 140.

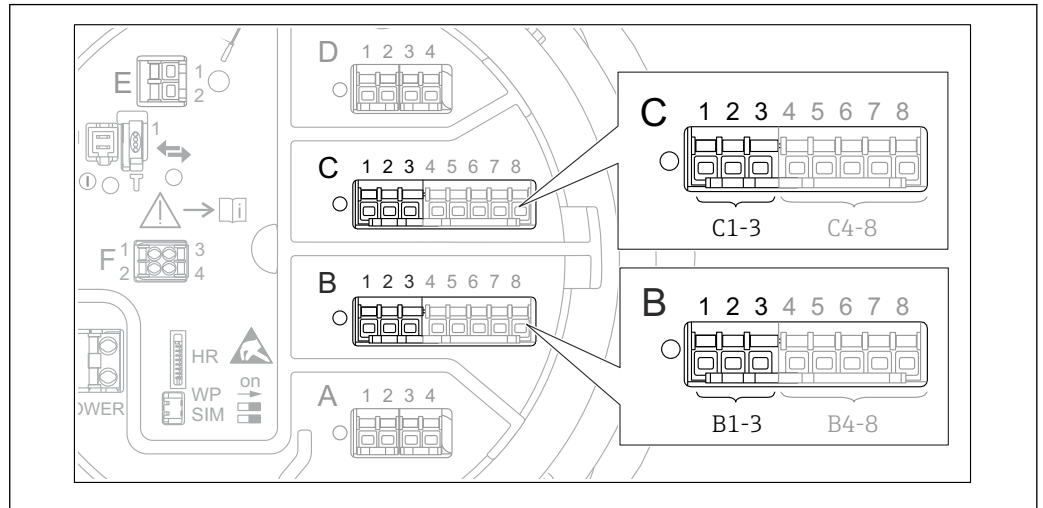















📖 13 Terminals for the "Analog I/O" submenu (→ 📖 149) ("B1-3" or "C1-3", respectively)

Navigation Expert → Input/output → Analog I/O

▶ Analog I/O

Operating mode	→ 📖 150
Current span	→ 📖 151
Fixed current	→ 📖 152
Analog input source	→ 📖 152
Failure mode	→ 📖 153
Error value	→ 📖 154
Output out of range	→ 📖 154
Error on event	→ 📖 154
Input value	→ 📖 155
0 % value	→ 📖 155
100 % value	→ 📖 155
Input value %	→ 📖 156

Output value	→  156
Readback value	→  156
Feedback threshold	→  157
Process variable	→  157
Analog input 0% value	→  157
Analog input 100% value	→  158
Error event type	→  158
Process value	→  158
Input value in mA	→  159
Input value percent	→  159
Damping factor	→  159
Calibration	→  160
Active calibration	→  160
Used for SIL/WHG	→  160

Operating mode



Navigation

  Expert → Input/output → Analog I/O → Operating mode (13958)

Description

Defines the operating mode of the analog I/O module.

Selection

- Disabled
- 4..20mA input
- HART master+4..20mA input
- HART master
- 4..20mA output
- HART slave +4..20mA output

Factory setting

Disabled

Additional information

Read access	Operator
Write access	Maintenance

Meaning of the options



Operating mode (→  150)	Direction of signal	Type of signal
Disabled	-	-
4..20mA input	Input from 1 external device	Analog (4...20mA)
HART master+4..20mA input	Input from 1 external device	<ul style="list-style-type: none"> ■ Analog (4...20mA) ■ HART
HART master	Input from up to 6 external devices	HART
4..20mA output	Output to higher-level unit	Analog (4...20mA)
HART slave +4..20mA output	Output to higher-level unit	<ul style="list-style-type: none"> ■ Analog (4...20mA) ■ HART

Depending on the terminals used, the Analog I/O module is used in the passive or active mode.

Mode	Terminals of the I/O module		
	1	2	3
Passive (power supply from external source)	-	+	not used
Active (power supplied by the device itself)	not used	-	+

-  In the active mode the following conditions must be met:
- Maximum current consumption of the connected HART devices: 24 mA (i.e. 4 mA per device if 6 devices are connected).
 - Output voltage of the Ex-d module: 17.0 V@4 mA to 10.5 V@22 mA
 - Output voltage of the Ex-ia module: 18.5 V@4 mA to 12.5 V@22 mA

Current span 

Navigation	  Expert → Input/output → Analog I/O → Current span (13987)				
Prerequisite	Operating mode parameter (→  150) ≠ Disabled option or HART master option				
Description	Defines the current range for the measured value transmission.				
Selection	<ul style="list-style-type: none"> ■ 4...20 mA NE (3.8...20.5 mA) ■ 4...20 mA US (3.9...20.8 mA) ■ 4...20 mA (4...20.5 mA) ■ Fixed value * 				
Factory setting	4...20 mA NE (3.8...20.5 mA)				
Additional information	<table border="1" style="width: 100%; border-collapse: collapse;"> <tr> <td style="padding: 2px;">Read access</td> <td style="padding: 2px;">Operator</td> </tr> <tr> <td style="padding: 2px;">Write access</td> <td style="padding: 2px;">Maintenance</td> </tr> </table>	Read access	Operator	Write access	Maintenance
Read access	Operator				
Write access	Maintenance				

* Visibility depends on order options or device settings

Meaning of the options

Option	Current range for process variable	Minimum value	Lower alarm signal level	Upper alarm signal level	Maximum value
4...20 mA (4...20.5 mA)	4 to 20.5 mA	3.5 mA	< 3.6 mA	> 21.95 mA	22.6 mA
4...20 mA NE (3.8...20.5 mA)	3.8 to 20.5 mA	3.5 mA	< 3.6 mA	> 21.95 mA	22.6 mA
4...20 mA US (3.9...20.8 mA)	3.9 to 20.8 mA	3.5 mA	< 3.6 mA	> 21.95 mA	22.0 mA
Fixed current	Constant current, defined in the Fixed current parameter (→  152).				

 In the case of an error, the output current assumes the value defined in the **Failure mode** parameter (→  153).

Fixed current **Navigation**

  Expert → Input/output → Analog I/O → Fixed current (13989)

Prerequisite

Current span (→  151) = **Fixed current**

Description

Defines the fixed output current.

User entry

4 to 22.5 mA

Factory setting

4 mA



Additional information

Read access	Operator
Write access	Maintenance

Analog input source **Navigation**

  Expert → Input/output → Analog I/O → Analog source (13974)

Prerequisite

- **Operating mode** (→  150) = **4..20mA output** or **HART slave +4..20mA output**
- **Current span** (→  151) ≠ **Fixed current**

Description

Defines the process variable transmitted via the AIO.

Selection

- None
- Tank level
- Tank level %
- Tank ullage
- Tank ullage %
- Measured level
- Distance
- Displacer position
- Water level

- Upper interface level
- Lower interface level
- Bottom level
- Tank reference height
- Liquid temperature
- Vapor temperature
- Air temperature
- Observed density value
- Average profile density ³⁾
- Upper density
- Middle density
- Lower density
- P1 (bottom)
- P2 (middle)
- P3 (top)
- GP 1 ... 4 value
- AIO B1-3 value ³⁾
- AIO B1-3 value mA ³⁾
- AIO C1-3 value ³⁾
- AIO C1-3 value mA ³⁾
- AIP B4-8 value ³⁾
- AIP C4-8 value ³⁾
- Element temperature 1 ... 24 ³⁾
- HART device 1...15 PV ³⁾
- HART device 1 ... 15 PV mA ³⁾
- HART device 1 ... 15 PV % ³⁾
- HART device 1 ... 15 SV ³⁾
- HART device 1 ... 15 TV ³⁾
- HART device 1 ... 15 QV ³⁾

Factory setting

Tank level

Additional information

Read access	Operator
Write access	Maintenance

Failure mode 

Navigation

  Expert → Input/output → Analog I/O → Failure mode (13988)

Prerequisite

Operating mode (→  150) = 4..20mA output or HART slave +4..20mA output

Description

Defines the output behavior in case of an error.

Selection

- Min.
- Max.
- Last valid value
- Actual value
- Defined value

Factory setting

Max.

3) Visibility depends on order options or device settings

Additional information

Read access	Operator
Write access	Maintenance

Error value**Navigation**

Expert → Input/output → Analog I/O → Error value (13972)

Prerequisite

Failure mode (→ 153) = Defined value

Description

Defines the output value in case of an error.

User entry

3.4 to 22.6 mA

Factory setting

22 mA

Additional information

Read access	Operator
Write access	Maintenance

Output out of range**Navigation**

Expert → Input/output → Analog I/O → Output out range (13971)

Prerequisite

Operating mode (→ 150) = 4..20mA output or HART slave +4..20mA output

Description

Behavior of current output if the value is out of allowed range.

Selection

- Last valid value
- Alarm
- None

Factory setting

Alarm

Additional information

Read access	Operator
Write access	Maintenance

Error on event**Navigation**

Expert → Input/output → Analog I/O → Error on event (13967)

Prerequisite

Operating mode (→ 150) = 4..20mA output or HART slave +4..20mA output

Description

Defines to which type of event (alarm or warning) the output responds.

Selection ■ Output related error
■ Any error
■ Any error or warning

Factory setting Output related error

Additional information

Read access	Operator
Write access	Maintenance

Input value

Navigation 📁📁 Expert → Input/output → Analog I/O → Input value (13979)

Prerequisite ■ Operating mode (→ 📄 150) = 4..20mA output or HART slave +4..20mA output
■ Current span (→ 📄 151) ≠ Fixed current

Description Shows the input value of the analog I/O module.

Additional information

Read access	Operator
Write access	-

0 % value



Navigation 📁📁 Expert → Input/output → Analog I/O → 0 % value (13954)

Prerequisite ■ Operating mode (→ 📄 150) = 4..20mA output or HART slave +4..20mA output
■ Current span (→ 📄 151) ≠ Fixed current

Description Value corresponding to an output current of 0% (4mA).

User entry Signed floating-point number

Factory setting 0 Unitless

Additional information

Read access	Operator
Write access	Maintenance

100 % value



Navigation 📁📁 Expert → Input/output → Analog I/O → 100 % value (13968)

Prerequisite ■ Operating mode (→ 📄 150) = 4..20mA output or HART slave +4..20mA output
■ Current span (→ 📄 151) ≠ Fixed current

Description Value corresponding to an output current of 100% (20mA).



User entry Signed floating-point number

Factory setting 0 Unitless



Additional information

Read access	Operator
Write access	Maintenance

Input value %

Navigation   Expert → Input/output → Analog I/O → Input value % (13955)

Prerequisite



- **Operating mode** (→  150) = **4..20mA output** or **HART slave +4..20mA output**
- **Current span** (→  151) ≠ **Fixed current**

Description Shows the output value as a percentage of the complete 4...20mA range.

Additional information

Read access	Operator
Write access	-

Output value

Navigation   Expert → Input/output → Analog I/O → Output value (13969)



Prerequisite **Operating mode** (→  150) = **4..20mA output** or **HART slave +4..20mA output**

Description Shows the output value in mA.

Additional information

Read access	Operator
Write access	-

Readback value

Navigation   Expert → Input/output → Analog I/O → Readback value (13957)

Prerequisite **Operating mode** (→  150) = **4..20mA output** or **HART slave +4..20mA output**

Description Shows the measured (feedback) current at the output.

User interface 0 to 65 535 μ A

Factory setting 0 μ A

Additional information

Read access	Operator
Write access	-

Feedback threshold

Navigation

Expert → Input/output → Analog I/O → Feedback thresh. (13956)

Prerequisite

Operating mode (→ 150) = **4..20mA output** or **HART slave +4..20mA output**

Description

Shows the feedback threshold.

Additional information

Read access	Operator
Write access	-

Process variable



Navigation

Expert → Input/output → Analog I/O → Process variable (13964)

Prerequisite

Operating mode (→ 150) = **4..20mA input** or **HART master+4..20mA input**

Description

Defines the type of measuring variable.

Selection

- Level linearized
- Temperature
- Pressure
- Density

Factory setting

Level linearized

Additional information

Read access	Operator
Write access	Maintenance

Analog input 0% value



Navigation

Expert → Input/output → Analog I/O → AI 0% value (13977)

Prerequisite

Operating mode (→ 150) = **4..20mA input** or **HART master+4..20mA input**

Description

Value corresponding to an input current of 0% (4mA).

User entry

Signed floating-point number

Factory setting

0 mm

Additional information

Read access	Operator
Write access	Maintenance

Analog input 100% value**Navigation**

Expert → Input/output → Analog I/O → AI 100% value (13965)

Prerequisite

Operating mode (→ 150) = 4..20mA input or HART master+4..20mA input

Description

Value corresponding to an input current of 100% (20mA).

User entry

Signed floating-point number

Factory setting

0 mm

Additional information

Read access	Operator
Write access	Maintenance

Error event type**Navigation**

Expert → Input/output → Analog I/O → Error event type (13953)

Prerequisite

Operating mode (→ 150) ≠ Disabled or HART master

Description

Defines the type of event message (alarm/warning) in case of an error or output out of range in the analog I/O module.

Selection

- None
- Warning
- Alarm

Factory setting

Warning

Additional information

Read access	Operator
Write access	Maintenance

Process value**Navigation**

Expert → Input/output → Analog I/O → Process value (13963)

Prerequisite

Operating mode (→ 150) = 4..20mA input or HART master+4..20mA input

Description

Shows the input value scaled to customer units.

Additional information

Read access	Operator
Write access	-

Input value in mA

Navigation

Expert → Input/output → Analog I/O → Input val. in mA (13970)

Prerequisite

Operating mode (→ 150) = **4..20mA input** or **HART master+4..20mA input**

Description

Shows the input value in mA.

Additional information

Read access	Operator
Write access	-

Input value percent

Navigation

Expert → Input/output → Analog I/O → Input value [%] (13978)

Prerequisite

Operating mode (→ 150) = **4..20mA input** or **HART master+4..20mA input**

Description

Shows the input value as a percentage of the complete 4...20mA current range.

Additional information

Read access	Operator
Write access	-

Damping factor



Navigation

Expert → Input/output → Analog I/O → Damping factor (13951)

Prerequisite

Operating mode (→ 150) ≠ **Disabled** or **HART master**

Description

Defines the damping constant (in seconds).

User entry

0 to 999.9 s

Factory setting

0 s

Additional information

Read access	Operator
Write access	Maintenance

Calibration

Navigation Expert → Input/output → Analog I/O → Calibration (13966)

Prerequisite **Operating mode (→ 150) ≠ Disabled or HART master**

Description Select calibration state of the analog input or output.

Selection

- User calibration
- Factory calibration

Factory setting Factory calibration

Additional information

Read access	Operator
Write access	Maintenance

Active calibration

Navigation Expert → Input/output → Analog I/O → Act. calibration (13981)

Prerequisite **Operating mode (→ 150) ≠ Disabled or HART master**

Description Indicates the calibration status of the Analog I/O module.

Additional information **Meaning of the options**

- **User calibration**
The calibration entered by the user is active.
- **Factory calibration**
The calibration stored permanently in the device is active.

Read access	Operator
Write access	-

Used for SIL/WHG

Navigation Expert → Input/output → Analog I/O → Used for SIL/WHG (13980)

Prerequisite

- **Operating mode (→ 150) = 4..20mA output or HART slave +4..20mA output**
- The device has a SIL approval.

Description Determines whether the discrete I/O module is in SIL/WHG mode.

Selection

- Enabled
- Disabled

Factory setting Disabled

Additional information

Read access	Operator
Write access	Maintenance

Expected SIL/WHG chain

Navigation

 Expert → Input/output → Analog I/O → SIL/WHG chain (13952)

Prerequisite

- **Operating mode (→  150) = 4..20mA output or HART slave +4..20mA output**
- The device has a SIL approval.

Additional information

Read access	Operator
Write access	-

3.3.4 "Digital Xx-x" submenu

- i** In the operating menu, each digital input or output is designated by the respective slot of the terminal compartment and two terminals within this slot. **A1-2**, for example, denotes terminals 1 and 2 of slot **A**. The same is valid for slots **B**, **C** and **D** if they contain a Digital IO module.
- In this document, **Xx-x** designates any of these submenus. The structure of all these submenus is the same.

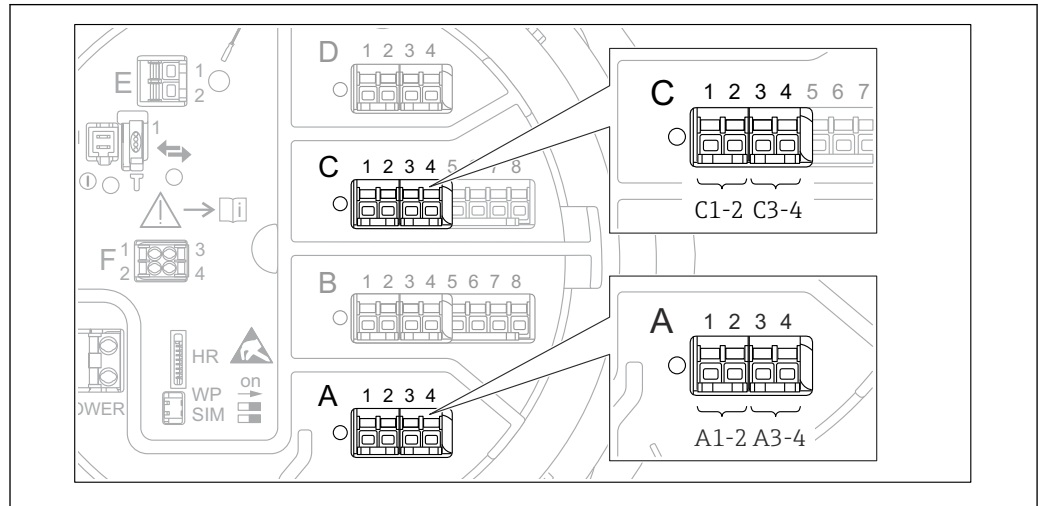

14 Designation of the digital inputs or outputs (examples)

Navigation Expert → Input/output → Digital Xx-x → Operating mode (13911)

► Digital Xx-x	
Operating mode	→ 163
Digital input source	→ 163
Input value	→ 164
Contact type	→ 164
Output simulation	→ 165
Output value	→ 166
Readback value	→ 166
Error on event	→ 166
Damping factor	→ 167
Used for SIL/WHG	→ 167

Operating mode



Navigation Expert → Input/output → Digital Xx-x → Operating mode (13911)

Description Defines the operating mode of the discrete I/O module.

- Selection**
- Disabled
 - Output passive
 - Input passive
 - Input active

Factory setting Disabled

Additional information

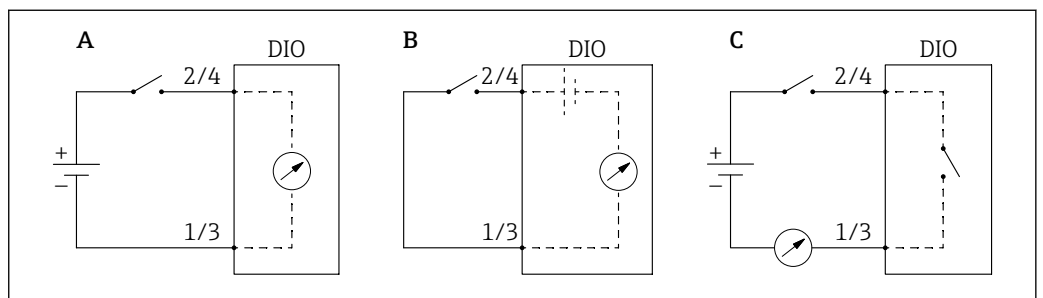

A0033028

15 Operating modes of the Digital I/O module

- A Input passive
- B Input active
- C Output passive

Read access	Operator
Write access	Maintenance

Digital input source



Navigation Expert → Input/output → Digital Xx-x → Digital source (13907)

Prerequisite **Operating mode (→ 163) = Output passive**

Description Defines which device state is indicated by the digital output.

- Selection**
- None
 - Balance flag
 - Alarm x any
 - Alarm x High
 - Alarm x HighHigh
 - Alarm x High or HighHigh
 - Alarm x Low
 - Alarm x LowLow
 - Alarm x Low or LowLow
 - Digital Xx-x
 - Primary Modbus x
 - Secondary Modbus x

Factory setting None

Additional information **Meaning of the options**

- **Alarm x any, Alarm x High, Alarm x HighHigh, Alarm x High or HighHigh, Alarm x Low, Alarm x LowLow, Alarm x Low or LowLow**
The digital output indicates if the selected alarm is currently active. The alarms themselves are defined in the **Alarm 1 to 4** submenus.
- **Digital Xx-x**⁴⁾
The digital signal present at the digital input **Xx-x** is passed through to the digital output.
- **Modbus A1-4 Discrete x**
Modbus B1-4 Discrete x
Modbus C1-4 Discrete x
Modbus D1-4 Discrete x
The digital value written by the Modbus Master device to the **Modbus discrete x** parameter⁵⁾ is passed to the digital output. For details refer to Special Documentation SD02066G.

Read access	Operator
Write access	Maintenance

Input value

Navigation  Expert → Input/output → Digital Xx-x → Input value (13901)

Prerequisite **Operating mode (→  163) = "Input passive" option or "Input active" option**

Description Shows the digital input value.

Additional information

Read access	Operator
Write access	-

Contact type



Navigation  Expert → Input/output → Digital Xx-x → Contact type (13912)

Prerequisite **Operating mode (→  163) ≠ Disabled**

Description Determines the switching behavior of the input or output.

Selection

- Normally open
- Normally closed

Factory setting Normally open

4) Only present if "Operating mode (→  163)" = "Input passive" or "Input active" for the respective Digital I/O module.

5) Expert → Communication → Modbus Xx-x → Modbus discrete x

Additional information

Read access	Operator
Write access	Maintenance

Output simulation



Navigation

Expert → Input/output → Digital Xx-x → Output sim (13909)

Prerequisite

Operating mode (→ 163) = Output passive

Description

Sets the output to a specific simulated value.

Selection

- Disable
- Simulating active
- Simulating inactive
- Fault 1
- Fault 2

Factory setting

Disable

Additional information

Read access	Operator
Write access	Maintenance

The digital output consists of two relays connected in series:

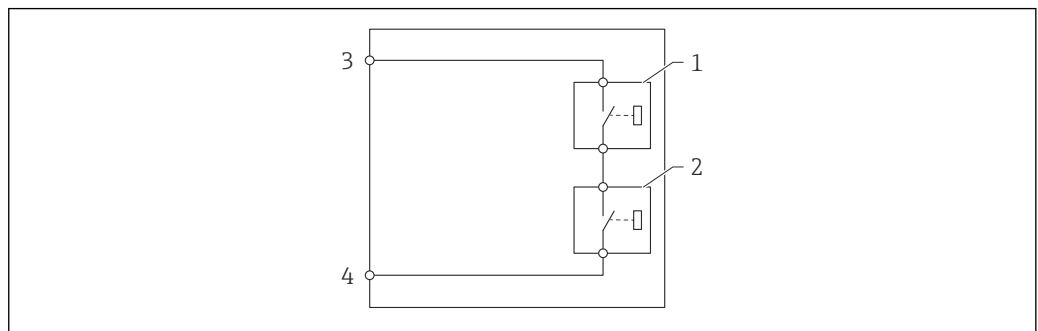

A0028602

16 The two relays of a digital output

1/2 The relays

3/4 The terminals of the digital output

The switching state of these relays is defined by the **Output simulation** parameter as follows:

Output simulation	State of relay 1	State of relay 2	Expected result on the terminals of the I/O module
Simulating active	Closed	Closed	Closed
Simulating inactive	Open	Open	Open

Output simulation	State of relay 1	State of relay 2	Expected result on the terminals of the I/O module
Fault 1	Closed	Open	Open
Fault 2	Open	Closed	Open

 The **Fault 1** and **Fault 2** options can be used to check the correct switching behavior of the two relays.

Output value

Navigation

 Expert → Input/output → Digital Xx-x → Output value (13902)

Prerequisite

Operating mode (→  163) = Output passive

Description

Shows the digital output value.

Additional information

Read access	Operator
Write access	-

Readback value

Navigation

 Expert → Input/output → Digital Xx-x → Readback value (13903)

Prerequisite

Operating mode (→  163) = Output passive

Description

Shows the value read back from the output.

Additional information

Read access	Operator
Write access	-

Error on event

**Navigation**

 Expert → Input/output → Digital Xx-x → Error on event (13916)

Prerequisite

Operating mode (→  163) = Output passive

Description

Defines to which type of events (error or warning) the output responds. Choice: only output related or all.

Selection

- Output related error
- Any error
- Any error or warning

Factory setting

Output related error

Additional information

Read access	Operator
Write access	Maintenance

Damping factor



Navigation

Expert → Input/output → Digital Xx-x → Damping factor (13904)

Prerequisite

Operating mode (→ 163) ≠ Disabled

Description

Defines the damping constant.

User entry

1 to 10 s

Factory setting

5 s

Additional information

Read access	Operator
Write access	Maintenance

Used for SIL/WHG



Navigation

Expert → Input/output → Digital Xx-x → Used for SIL/WHG (13910)

Prerequisite

- **Operating mode (→ 163) = Output passive**
- The device has a SIL certificate.

Description

Determines whether the discrete I/O module is in SIL/WHG mode.

Selection

- Enabled
- Disabled

Factory setting

Disabled







Additional information

Read access	Operator
Write access	Maintenance

3.3.5 "Digital input mapping" submenu

Navigation  Expert → Input/output → DI mapping

▶ Digital input mapping

Digital input source 1	→  168
Digital input source 2	→  168
Gauge command 0	→  169
Gauge command 1	→  170
Gauge command 2	→  170
Gauge command 3	→  171

Digital input source 1

Navigation  Expert → Input/output → DI mapping → Digital source 1 (8147)

Description Selects the source of digital input #1 (for gauge command).

- Selection**
- None
 - Digital A1-2 *
 - Digital A3-4 *
 - Digital B1-2 *
 - Digital B3-4 *
 - Digital C1-2 *
 - Digital C3-4 *
 - Digital D1-2 *
 - Digital D3-4 *

Factory setting None

Additional information

Read access	Operator
Write access	Maintenance

Digital input source 2

Navigation  Expert → Input/output → DI mapping → Digital source 2 (8148)

Description Selects the source of digital input #2 (for gauge command).

* Visibility depends on order options or device settings

- Selection**
- None
 - Digital A1-2 *
 - Digital A3-4 *
 - Digital B1-2 *
 - Digital B3-4 *
 - Digital C1-2 *
 - Digital C3-4 *
 - Digital D1-2 *
 - Digital D3-4 *

Factory setting None

Additional information

Read access	Operator
Write access	Maintenance

Gauge command 0



Navigation Expert → Input/output → DI mapping → Gauge command 0 (8149)

Prerequisite **Digital input source 1 (→ 168) ≠ None**

Description Gauge command assigned to digital input combination 0 (DI2=0, DI1=0).

- Selection**
- Stop *
 - Level
 - Up *
 - Bottom level *
 - Upper I/F level *
 - Lower I/F level *
 - Upper density *
 - Middle density *
 - Lower density *
 - Repeatability *
 - Water dip *
 - Release overtension *
 - Tank profile *
 - Interface profile *
 - Manual profile *
 - Level standby *
 - Offset standby *

Factory setting Level

Additional information

Read access	Operator
Write access	Maintenance

* Visibility depends on order options or device settings

Gauge command 1



Navigation Expert → Input/output → DI mapping → Gauge command 1 (8150)

Prerequisite **Digital input source 1 (→ 168) ≠ None**

Description Gauge command assigned to digital input combination 1 (DI2=0, DI1=1).

Selection

- Stop *
- Level
- Up *
- Bottom level *
- Upper I/F level *
- Lower I/F level *
- Upper density *
- Middle density *
- Lower density *
- Repeatability *
- Water dip *
- Release overtension *
- Tank profile *
- Interface profile *
- Manual profile *
- Level standby *
- Offset standby *

Factory setting Up

Additional information

Read access	Operator
Write access	Maintenance

Gauge command 2



Navigation Expert → Input/output → DI mapping → Gauge command 2 (8151)

Prerequisite

- **Digital input source 1 (→ 168) ≠ None**
- **Digital input source 2 (→ 168) ≠ None**

Description Gauge command assigned to digital Input combination 2 (DI2=1, DI1=0).

Selection

- Stop *
- Level
- Up *
- Bottom level *
- Upper I/F level *
- Lower I/F level *
- Upper density *
- Middle density *
- Lower density *
- Repeatability *

* Visibility depends on order options or device settings

- Water dip *
- Release overtension *
- Tank profile *
- Interface profile *
- Manual profile *
- Level standby *
- Offset standby *

Factory setting

Stop

Additional information

Read access	Operator
Write access	Maintenance

Gauge command 3



Navigation

Expert → Input/output → DI mapping → Gauge command 3 (8152)

Prerequisite

- Digital input source 1 (→ 168) ≠ None
- Digital input source 2 (→ 168) ≠ None

Description

Gauge command assigned to digital input combination 3 (DI2=1, DI1=1).

Selection

- Stop *
- Level
- Up *
- Bottom level *
- Upper I/F level *
- Lower I/F level *
- Upper density *
- Middle density *
- Lower density *
- Repeatability *
- Water dip *
- Release overtension *
- Tank profile *
- Interface profile *
- Manual profile *
- Level standby *
- Offset standby *

Factory setting

Upper I/F level

Additional information

Read access	Operator
Write access	Maintenance

* Visibility depends on order options or device settings

3.4 "Communication" submenu

This menu contains a submenu for each digital communication interface of the device. The communication interfaces are designated by "X1-4" where "X" specifies the slot in the terminal compartment and "1-4" the terminals within this slot.

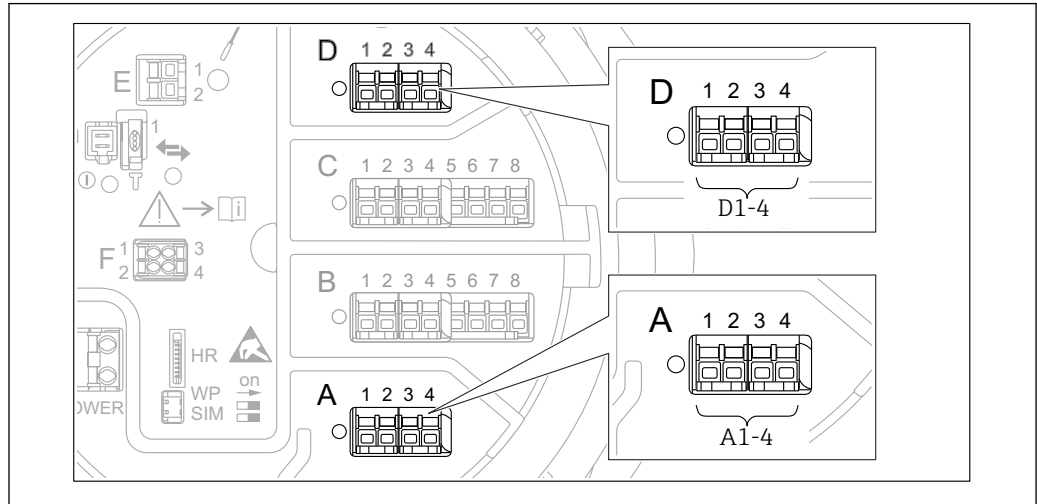

A0031200

- 17 Designation of the "Modbus" or "V1" modules (examples); depending on the device version these modules may also be in slot B or C.









Navigation



Expert → Communication



3.4.1 "Modbus Xx-x", "V1 Xx-x" or "WM550 Xx-x" submenu

This submenu is only present for devices with MODBUS, V1 and/or WM550 communication interface. There is one submenu of this type for each communication interface.

Navigation   Expert → Communication → Modbus Xx-x / V1 Xx-x / WM550 Xx-x

► Modbus Xx-x	
Communication interface protocol	→  174
Modbus value 1 to 4	→  174
Modbus discrete 1 to 4	→  174
► Configuration	→  175
► Integer conversion	→  180
► User value source	→  185
► GP values	→  186
► Discrete selector	→  189

► V1 Xx-x	
Communication interface protocol	→  174
► Configuration	→  190
► V1 input selector	→  193

► WM550 Xx-x	
► Configuration	→  198
► WM550 input selector	→  200

Communication interface protocol

Navigation  Expert → Communication → Modbus X1-4 / V1 X1-4 / WM550 X1-4 → Commu I/F protoc (13201)

Description Shows the type of communication protocol.

Additional information

Read access	Operator
Write access	-

Modbus value 1 to 4

Navigation  Expert → Communication → Modbus Xx-x → Modbus value 1 to 4 (13206-1 to 4)

Prerequisite **Communication interface protocol (→  174) = MODBUS**

Description Shows the respective floating point value written by the host system.

Additional information

Read access	Operator
Write access	-

 The Modbus interface provides four floating point values which can be written to by the Host system. These values can be linked to specific functions (e.g. providing the air temperature value).

Modbus discrete 1 to 4

Navigation  Expert → Communication → Modbus Xx-x → Modbus discr. 1 to 4 (13240-1 to 4)

Prerequisite **Communication interface protocol (→  174) = MODBUS**

Description Shows the integer value written by the host-system.

Additional information

Read access	Operator
Write access	-



 The Modbus interface provides four discrete (integer) registers which can be written to by the Host system. These values can be linked to specific functions (e.g. controlling a discrete output).











In the device these values are converted into the following discrete state values:

- Unknown (integer value 0)
- Inactive (integer value 1)
- Active (integer value 2)
- Invalid (integer value ≥ 3)

"Configuration" submenu (Modbus)

 Only visible for devices with a Modbus I/O module.

Navigation   Expert → Communication → Modbus Xx-x → Configuration

► Configuration	
Baudrate	→  175
Parity	→  176
Modbus address	→  176
Float swap mode	→  176
Invalid data	→  177
Word type	→  177
CRC seed	→  178
Old TSM mode	→  178
Bus termination	→  178
Compatibility mode	→  179

Baudrate



Navigation   Expert → Communication → Modbus X1-4 → Configuration → Baudrate (13203)

Prerequisite **Communication interface protocol (→  174) = MODBUS**

Description Defines the baud rate of the communication.

- Selection**
- 600 BAUD
 - 1200 BAUD
 - 2400 BAUD
 - 4800 BAUD
 - 9600 BAUD *
 - 19200 BAUD *

Factory setting 9600 BAUD

* Visibility depends on order options or device settings

Additional information

Read access	Operator
Write access	Maintenance

Parity**Navigation**

Expert → Communication → Modbus X1-4 → Configuration → Parity (13204)

Prerequisite

Communication interface protocol (→ 174) = MODBUS

Description

Defines the parity of the Modbus communication.

Selection

- Odd
- Even
- None / 1 stop bit
- None / 2 stop bits

Factory setting

None / 1 stop bit

Additional information

Read access	Operator
Write access	Maintenance

Modbus address**Navigation**

Expert → Communication → Modbus X1-4 → Configuration → Modbus address (13205)

Prerequisite

Communication interface protocol (→ 174) = MODBUS

Description

Defines the Modbus address of the device.

User entry

1 to 247

Factory setting

1

Additional information

Read access	Operator
Write access	Maintenance

Float swap mode**Navigation**

Expert → Communication → Modbus X1-4 → Configuration → Float swap mode (13232)

Prerequisite

Communication interface protocol (→ 174) = MODBUS

Description Sets the format of how the floating point value is transferred on Modbus.

- Selection**
- Normal 3-2-1-0
 - Swap 0-1-2-3
 - WW Swap 1-0-3-2
 - WW Swap 2-3-0-1

Factory setting Swap 0-1-2-3

Additional information

Read access	Operator
Write access	Maintenance

Invalid data 

Navigation   Expert → Communication → Modbus Xx-x → Configuration → Invalid data (13243)

Prerequisite **Communication interface protocol (→  174) = MODBUS**

Description Sets what byte is sent in a message that contains invalid data.

- Selection**
- 0x00
 - 0xFF

Factory setting 0x00

Additional information

Read access	Operator
Write access	Maintenance

Word type 

Navigation   Expert → Communication → Modbus Xx-x → Configuration → Word type (13208)

Prerequisite **Communication interface protocol (→  174) = MODBUS**

Description Selects if the integer value has the range 0 to +65535 or -32768 to +32767.

- Selection**
- Unsigned
 - Signed

Factory setting Unsigned

Additional information

Read access	Operator
Write access	Maintenance

CRC seed

Navigation	Expert → Communication → Modbus Xx-x → Configuration → CRC seed (13248)
Prerequisite	Communication interface protocol (→ 174) = MODBUS
Description	CRC seed value selection used for all communication CRC calculations.
Selection	<ul style="list-style-type: none"> ■ 0x0000 ■ 0xFFFF
Factory setting	0xFFFF

Additional information

Read access	Operator
Write access	Maintenance

Old TSM mode

Navigation	Expert → Communication → Modbus Xx-x → Configuration → Old TSM mode (13213)
Prerequisite	Communication interface protocol (→ 174) = MODBUS
Description	Selects the type of value available at the NRF590 SW vers.1 compatible modbus map (Address 3000-3195) addresses.
Selection	<ul style="list-style-type: none"> ■ Float values ■ Integer values
Factory setting	Float values

Additional information

Read access	Operator
Write access	Maintenance

Bus termination

Navigation	Expert → Communication → Modbus X1-4 → Configuration → Bus termination (13249)
Prerequisite	Communication interface protocol (→ 174) = MODBUS
Description	Activates or deactivates the bus termination at the device. Should only be activated on the last device in a loop.
Selection	<ul style="list-style-type: none"> ■ Off ■ On

Factory setting Off

Additional information

Read access	Operator
Write access	Maintenance

Compatibility mode



Navigation Expert → Communication → Modbus Xx-x → Configuration → Comp. mode (13281)

Description Defines the compatibility mode.

- Selection**
- Nxx5xx
 - Nxx8x

Factory setting Nxx8x

Additional information In **NMS5x** mode: Only values which have also existed on NMS5x Gauge status are output on the bus.
 In **NMS8x** mode: All Gauge status are available at this parameter.













Read access	Operator
Write access	Maintenance

"Integer conversion" submenu

 Only visible for devices with a Modbus I/O module.

Navigation  Expert → Communication → Modbus Xx-x → Integer convers

▶ Integer conversion

Level 0%	→  180
Level 100%	→  181
Temperature 0%	→  181
Temperature 100%	→  181
Pressure 0%	→  182
Pressure 100%	→  182
Density 0%	→  182
Density 100%	→  183
User 0%	→  183
User 100%	→  183
Percent 0%	→  184
Percent 100%	→  184

Level 0%



Navigation

 Expert → Communication → Modbus Xx-x → Integer convers → Level 0% (13214)

Description

Defines the level that represents 0% on the integer value scale.

User entry

Signed floating-point number

Factory setting

0.00 mm

Additional information

Read access	Operator
Write access	Maintenance

Level 100%



Navigation	Expert → Communication → Modbus Xx-x → Integer convers → Level 100% (13250)				
Description	Defines the level that represents 100% on the integer value scale.				
User entry	Signed floating-point number				
Factory setting	30.0 mm				
Additional information	<table border="1" style="width: 100%; border-collapse: collapse;"> <tr> <td style="width: 50%;">Read access</td> <td>Operator</td> </tr> <tr> <td>Write access</td> <td>Maintenance</td> </tr> </table>	Read access	Operator	Write access	Maintenance
Read access	Operator				
Write access	Maintenance				

Temperature 0%



Navigation	Expert → Communication → Modbus Xx-x → Integer convers → Temperature 0% (13215)				
Description	Defines the temperature that represents 0% on the integer value scale.				
User entry	Signed floating-point number				
Factory setting	233.15 °C				
Additional information	<table border="1" style="width: 100%; border-collapse: collapse;"> <tr> <td style="width: 50%;">Read access</td> <td>Operator</td> </tr> <tr> <td>Write access</td> <td>Maintenance</td> </tr> </table>	Read access	Operator	Write access	Maintenance
Read access	Operator				
Write access	Maintenance				

Temperature 100%



Navigation	Expert → Communication → Modbus Xx-x → Integer convers → Temperature 100% (13216)				
Description	Defines the temperature that represents 100% on the integer value scale.				
User entry	Signed floating-point number				
Factory setting	373.15 °C				
Additional information	<table border="1" style="width: 100%; border-collapse: collapse;"> <tr> <td style="width: 50%;">Read access</td> <td>Operator</td> </tr> <tr> <td>Write access</td> <td>Maintenance</td> </tr> </table>	Read access	Operator	Write access	Maintenance
Read access	Operator				
Write access	Maintenance				

Pressure 0%

Navigation Expert → Communication → Modbus Xx-x → Integer convers → Pressure 0% (13217)

Description Defines the pressure that represents 0% on the integer value scale.

User entry Signed floating-point number

Factory setting 0 bar

Additional information

Read access	Operator
Write access	Maintenance

Pressure 100%

Navigation Expert → Communication → Modbus Xx-x → Integer convers → Pressure 100% (13251)

Description Defines the pressure that represents 100% on the integer value scale.

User entry Signed floating-point number

Factory setting 25 000 bar

Additional information

Read access	Operator
Write access	Maintenance

Density 0%

Navigation Expert → Communication → Modbus Xx-x → Integer convers → Density 0% (13252)

Description Defines the density that represents 0% on the integer value scale.

User entry Signed floating-point number

Factory setting 0 kg/m³

Additional information

Read access	Operator
Write access	Maintenance

Density 100%



Navigation Expert → Communication → Modbus Xx-x → Integer convers → Density 100% (13218)

Description Defines the density that represents 100% on the integer value scale.

User entry Signed floating-point number

Factory setting 1 000 kg/m³

Additional information

Read access	Operator
Write access	Maintenance

User 0%



Navigation Expert → Communication → Modbus Xx-x → Integer convers → User 0% (13221)

Description Defines the value of the user selected variable that represents 0% on the integer value scale.

User entry Signed floating-point number

Factory setting 0

Additional information

Read access	Operator
Write access	Maintenance

User 100%



Navigation Expert → Communication → Modbus Xx-x → Integer convers → User 100% (13222)

Description Defines the value of the user selected variable that represents 100% on the integer value scale.

User entry Signed floating-point number

Factory setting 0

Additional information

Read access	Operator
Write access	Maintenance

Percent 0%**Navigation**

Expert → Communication → Modbus Xx-x → Integer convers → Percent 0% (13202)

Description

Defines the percentage of the measured value that represents 0% on the integer value scale.

User entry

-200 to +400 %

Factory setting

0.00 %

Additional information

Read access	Operator
Write access	Maintenance

Percent 100%**Navigation**

Expert → Communication → Modbus Xx-x → Integer convers → Percent 100% (13234)

Description

Defines the percentage of the measured value that represents 100% on the integer value scale.

User entry

-200 to +400 %

Factory setting

100 %

Additional information

Read access	Operator
Write access	Maintenance

"User value source" submenu

 Only visible for devices with a Modbus I/O module.

Navigation  Expert → Communication → Modbus Xx-x → UserVal source → UserVal 1 source (13209)

User value 1 to 8 source



Navigation  Expert → Communication → Modbus Xx-x → UserVal source → UserVal 1 to 8 source (13209-1 to 8)

Description Selects which parameter shall be transmitted as User value x.

- Selection**
- None
 - Tank ullage
 - Distance
 - Upper interface level
 - Lower interface level
 - Bottom level
 - Average profile density ⁶⁾
 - Vapor density
 - Manual density
 - P1 position
 - P3 position
 - GP 1...4 value
 - AIO B1-3 value
 - AIO C1-3 value
 - AIP B4-8 value
 - AIP C4-8 value
 - HART device 1...15 PV
 - HART device 1...15 PV mA
 - HART device 1...15 PV %
 - HART device 1...15 SV
 - HART device 1...15 TV
 - HART device 1...15 QV

Factory setting None

Additional information









Read access	Operator
Write access	Maintenance

6) Visibility depends on order options or device settings

"GP values" submenu

Navigation  Expert → Communication → Modbus Xx-x → GP values → GP 1 value 0% (13223)

▶ GP values

GP 1 value 0%	→  186
GP 1 value 100%	→  186
GP 2 value 0%	→  187
GP 2 value 100%	→  187
GP 3 value 0%	→  187
GP 3 value 100%	→  188
GP 4 value 0%	→  188
GP 4 value 100%	→  188

GP 1 value 0% 

Navigation  Expert → Communication → Modbus Xx-x → GP values → GP 1 value 0% (13223)

Description Defines the GP1 value that represents 0% on the integer value scale.

User entry Signed floating-point number

Factory setting 0 Unitless

Additional information

Read access	Operator
Write access	Maintenance

GP 1 value 100% 

Navigation  Expert → Communication → Modbus Xx-x → GP values → GP 1 value 100% (13224)

Description Defines the GP1 value that represents 100% on the integer value scale.

User entry Signed floating-point number

Factory setting 0 Unitless

Additional information

Read access	Operator
Write access	Maintenance

GP 2 value 0%



Navigation

Expert → Communication → Modbus Xx-x → GP values → GP 2 value 0% (13257)

Description

Defines the GP2 value that represents 0% on the integer value scale.

User entry

Signed floating-point number

Factory setting

0 None

Additional information

Read access	Operator
Write access	Maintenance

GP 2 value 100%



Navigation

Expert → Communication → Modbus Xx-x → GP values → GP 2 value 100% (13258)

Description

Defines the GP2 value that represents 100% on the integer value scale.

User entry

Signed floating-point number

Factory setting

0 None

Additional information

Read access	Operator
Write access	Maintenance

GP 3 value 0%



Navigation

Expert → Communication → Modbus Xx-x → GP values → GP 3 value 0% (13259)

Description

Defines the GP3 value that represents 0% on the integer value scale.

User entry

Signed floating-point number

Factory setting

0 Unitless

Additional information

Read access	Operator
Write access	Maintenance

GP 3 value 100%



Navigation	Expert → Communication → Modbus Xx-x → GP values → GP 3 value 100% (13226)				
Description	Defines the GP3 value that represents 100% on the integer value scale.				
User entry	Signed floating-point number				
Factory setting	0 Unitless				
Additional information	<table border="1"> <tr> <td>Read access</td> <td>Operator</td> </tr> <tr> <td>Write access</td> <td>Maintenance</td> </tr> </table>	Read access	Operator	Write access	Maintenance
Read access	Operator				
Write access	Maintenance				

GP 4 value 0%



Navigation	Expert → Communication → Modbus Xx-x → GP values → GP 4 value 0% (13225)				
Description	Defines the GP4 value that represents 0% on the integer value scale.				
User entry	Signed floating-point number				
Factory setting	0 Unitless				
Additional information	<table border="1"> <tr> <td>Read access</td> <td>Operator</td> </tr> <tr> <td>Write access</td> <td>Maintenance</td> </tr> </table>	Read access	Operator	Write access	Maintenance
Read access	Operator				
Write access	Maintenance				

GP 4 value 100%



Navigation	Expert → Communication → Modbus Xx-x → GP values → GP 4 value 100% (13227)				
Description	Defines the GP4 value that represents 100% on the integer value scale.				
User entry	Signed floating-point number				
Factory setting	0 Unitless				
Additional information	<table border="1"> <tr> <td>Read access</td> <td>Operator</td> </tr> <tr> <td>Write access</td> <td>Maintenance</td> </tr> </table>	Read access	Operator	Write access	Maintenance
Read access	Operator				
Write access	Maintenance				

"Discrete selector" submenu

Navigation  Expert → Communication → Modbus Xx-x → Discreteselect

Discrete 1 to 4 selector



Navigation  Expert → Communication → WM550 X1-4 → Discreteselect → Discrete 1 to 4select (13260-1 to 4)

Description Determines the input source which is transferred as Alarm bit [n] value in the corresponding WM550 tasks.

- Selection**
- None
 - **Balance flag** option Visibility depends on order options or device settings
 - Alarm 1...4 any
 - Alarm 1...4 HighHigh
 - Alarm 1...4 High or HighHigh
 - Alarm 1...4 High
 - Alarm 1...4 Low
 - Alarm 1...4 Low or LowLow
 - Alarm 1...4 LowLow
 - Digital Xx-x

Factory setting None

Additional information







Read access	Operator
Write access	Maintenance

"Configuration" submenu (V1)

 Only visible for devices with a V1 I/O module.

Navigation  Expert → Communication → V1 Xx-x → Configuration

▶ Configuration

- Communication interface protocol variant →  190
- V1 addressV1/MDP →  190
- V1 addressBBB/MIC+232 →  191
- Level mapping →  191
- Line impedance →  192
- Compatibility mode →  192

Communication interface protocol variant



Navigation  Expert → Communication → V1 Xx-x → Configuration → Protocol variant (13269)

Description Determines which variant of the V1 protocol is used.

User interface

- None
- V1 *

Factory setting None

Additional information

Read access	Operator
Write access	Maintenance

V1 address



Navigation  Expert → Communication → V1 Xx-x → Configuration → V1 address (13235)

Prerequisite **Communication interface protocol variant** (→  190) = V1

Description Identifier of the device for the V1 communication.

User entry 0 to 99

* Visibility depends on order options or device settings

Factory setting 1

Additional information

Read access	Operator
Write access	Maintenance

V1 address



Navigation

Expert → Communication → V1 Xx-x → Configuration → V1 address (13236)

Prerequisite

Communication interface protocol variant (→ 190)

Description

Identifier of the previous device for V1 communication.

User entry

0 to 255

Factory setting

1

Additional information

Read access	Operator
Write access	Maintenance

Level mapping



Navigation

Expert → Communication → V1 Xx-x → Configuration → Level mapping (13268)

Prerequisite

Communication interface protocol (→ 174) = V1

Description

Determines the transmittable range of levels.

Selection

- +ve
- +ve & -ve

Factory setting

+ve

Additional information

Read access	Operator
Write access	Maintenance

In V1, the level is always represented by a number in the range from 0 to 999 999. This number corresponds to a level as follows:



"Level mapping" = "+ve"

Number	Corresponding level
0	0.0 mm
999 999	99 999.9 mm

"Level mapping" = "+ve & -ve"



Number	Corresponding level
0	0.0 mm
500 000	50 000.0 mm
500 001	-0.1 mm
999 999	-49 999.9 mm

Line impedance

Navigation	  Expert → Communication → V1 Xx-x → Configuration → Line impedance (13266)				
Prerequisite	Communication interface protocol (→  174) = V1				
Description	Adjusts the impedance of the communication line.				
User entry	0 to 15				
Factory setting	15				
Additional information	<table border="1"> <tr> <td>Read access</td> <td>Operator</td> </tr> <tr> <td>Write access</td> <td>Maintenance</td> </tr> </table>	Read access	Operator	Write access	Maintenance
Read access	Operator				
Write access	Maintenance				



 The line impedance affects the voltage difference between a logical 0 and a logical 1 on the message of the device to the bus. The default setting is suitable for most applications.

Compatibility mode











Navigation	  Expert → Communication → V1 Xx-x → Configuration → Comp. mode (13281)				
Description	Defines the compatibility mode.				
Selection	<ul style="list-style-type: none"> ▪ Nxx5xx ▪ Nxx8x 				
Factory setting	Nxx8x				
Additional information	<p>In NMS5x mode: Only values which have also existed on NMS5x Gauge status are output on the bus.</p> <p>In NMS8x mode: All Gauge status are available at this parameter.</p> <table border="1"> <tr> <td>Read access</td> <td>Operator</td> </tr> <tr> <td>Write access</td> <td>Maintenance</td> </tr> </table>	Read access	Operator	Write access	Maintenance
Read access	Operator				
Write access	Maintenance				

"V1 input selector" submenu (V1)

 Only visible for devices with a V1 I/O module.

Navigation   Expert → Communication → V1 Xx-x → V1 input select.



▶ V1 input selector

User value 1 to 8 source	→  193
Alarm 1 input source	→  194
Alarm 2 input source	→  194
Alarm 3 input source	→  195
Alarm 4 input source	→  195
SP 1 value selector	→  196
SP 2 value selector	→  196
SP 3 value selector	→  197
SP 4 value selector	→  197
Value percent selector	→  198

User value 1 to 8 source



Navigation

  Expert → Communication → V1 Xx-x → V1 input select. → UserVal 1 to 8 source (13209-1 to 8)

Description

Selects which parameter shall be transmitted as User value x.

Selection

- None
- Tank ullage
- Distance
- Upper interface level
- Lower interface level
- Bottom level
- Average profile density⁷⁾
- Vapor density
- Manual density
- P1 position
- P3 position
- GP 1...4 value

7) Visibility depends on order options or device settings

- AIO B1-3 value
- AIO C1-3 value
- AIP B4-8 value
- AIP C4-8 value
- HART device 1...15 PV
- HART device 1...15 PV mA
- HART device 1...15 PV %
- HART device 1...15 SV
- HART device 1...15 TV
- HART device 1...15 QV

Factory setting

None

Additional information

Read access	Operator
Write access	Maintenance

Alarm 1 input source**Navigation**

Expert → Communication → V1 Xx-x → V1 input select. → Alarm1 input src (13270)

Description

Determines which discrete value will be transmitted as V1 alarm 1 status.

Selection

- None
- Alarm 1-4 any
- Alarm 1-4 HighHigh
- Alarm 1-4 High or HighHigh
- Alarm 1-4 High
- Alarm 1-4 Low
- Alarm 1-4 Low or LowLow
- Alarm 1-4 LowLow

Factory setting

None

Additional information

Read access	Operator
Write access	Maintenance

Alarm 2 input source**Navigation**

Expert → Communication → V1 Xx-x → V1 input select. → Alarm2 input src (13271)

Description

Determines which discrete value will be transmitted as V1 alarm 2 status.

Selection

- None
- Alarm 1-4 any
- Alarm 1-4 HighHigh
- Alarm 1-4 High or HighHigh
- Alarm 1-4 High

- Alarm 1-4 Low
- Alarm 1-4 Low or LowLow
- Alarm 1-4 LowLow

Factory setting None

Additional information

Read access	Operator
Write access	Maintenance

Alarm 3 input source



Navigation

Expert → Communication → V1 Xx-x → V1 input select. → Alarm3 in-source (13283)

Description

Determines which discrete value will be transmitted as V1 alarm 3 status in Z0 and Z1 message.

Selection

- None
- Alarm 1-4 any
- Alarm 1-4 HighHigh
- Alarm 1-4 High or HighHigh
- Alarm 1-4 High
- Alarm 1-4 Low
- Alarm 1-4 Low or LowLow
- Alarm 1-4 LowLow

Factory setting None

Additional information

Read access	Operator
Write access	Maintenance

Alarm 4 input source



Navigation

Expert → Communication → V1 Xx-x → V1 input select. → Alarm4 in-source (13284)

Description

Determines which discrete value will be transmitted as V1 alarm 4 status in Z0 and Z1 message.

Selection

- None
- Alarm 1-4 any
- Alarm 1-4 HighHigh
- Alarm 1-4 High or HighHigh
- Alarm 1-4 High
- Alarm 1-4 Low
- Alarm 1-4 Low or LowLow
- Alarm 1-4 LowLow

Factory setting None

Additional information

Read access	Operator
Write access	Maintenance

SP 1 value selector**Navigation**

Expert → Communication → V1 → V1 input select. → SP1 value select (13274)

Description

Selects which discrete value will be transmitted as V1 External Status bit 1 in Z0/Z1 message.

Selection

- None
- Digital A1-2 *
- Digital A3-4 *
- Digital B1-2 *
- Digital B3-4 *
- Digital C1-2 *
- Digital C3-4 *
- Digital D1-2 *
- Digital D3-4 *

Factory setting

None

Additional information

Read access	Operator
Write access	Maintenance

SP 2 value selector**Navigation**

Expert → Communication → V1 → V1 input select. → SP2 value select (13275)

Description

Selects which discrete value will be transmitted as V1 external status bit 2 in Z0/Z1 message.

Selection

- None
- Digital A1-2 *
- Digital A3-4 *
- Digital B1-2 *
- Digital B3-4 *
- Digital C1-2 *
- Digital C3-4 *
- Digital D1-2 *
- Digital D3-4 *

Factory setting

None

Additional information

Read access	Operator
Write access	Maintenance

* Visibility depends on order options or device settings

SP 3 value selector



Navigation Expert → Communication → V1 → V1 input select. → SP3 value select (13276)

Description Selects which discrete value will be transmitted as V1 external status bit 3 in Z0/Z1 message.

- Selection**
- None
 - Digital A1-2 *
 - Digital A3-4 *
 - Digital B1-2 *
 - Digital B3-4 *
 - Digital C1-2 *
 - Digital C3-4 *
 - Digital D1-2 *
 - Digital D3-4 *

Factory setting None

Additional information

Read access	Operator
Write access	Maintenance

SP 4 value selector



Navigation Expert → Communication → V1 → V1 input select. → SP4 value select (13277)

Description Selects which discrete value will be transmitted as V1 external status bit 4 in Z0/Z1 message.

- Selection**
- None
 - Digital A1-2 *
 - Digital A3-4 *
 - Digital B1-2 *
 - Digital B3-4 *
 - Digital C1-2 *
 - Digital C3-4 *
 - Digital D1-2 *
 - Digital D3-4 *

Factory setting None

Additional information

Read access	Operator
Write access	Maintenance

* Visibility depends on order options or device settings





Value percent selector 

Navigation	 Expert → Communication → V1 → V1 input select. → Value % select (13282)				
Description	Selects which value shall be transmitted as a 0..100% value in the V1 Z0/Z1 message.				
Selection	<ul style="list-style-type: none"> ■ None ■ Tank level % ■ Tank ullage % ■ AIO B1-3 value % * ■ AIO C1-3 value % * 				
Factory setting	None				
Additional information	<table border="1" style="width: 100%; border-collapse: collapse;"> <tr> <td style="width: 50%;">Read access</td> <td>Operator</td> </tr> <tr> <td>Write access</td> <td>Maintenance</td> </tr> </table>	Read access	Operator	Write access	Maintenance
Read access	Operator				
Write access	Maintenance				



"Configuration" submenu (WM550)

 This submenu is only present for devices with a **WM550** option communication interface.

Navigation  Expert → Communication → WM550 Xx-x → Configuration

► Configuration	
Baudrate	→  198
WM550 address	→  199
Software ID	→  199
Compatibility mode	→  199

Baudrate 

Navigation	 Expert → Communication → WM550 Xx-x → Configuration → Baudrate (13203)
Prerequisite	Communication interface protocol (→  174) = "WM550" option
Description	Defines the baud rate of the WM550 communication.

* Visibility depends on order options or device settings

- Selection**
- 600 BAUD
 - 1200 BAUD
 - 2400 BAUD
 - 4800 BAUD

Factory setting 2400 BAUD

Additional information

Read access	Operator
Write access	Maintenance

WM550 address



Navigation Expert → Communication → WM550 Xx-x → Configuration → WM550 address (13286)

Description Describes the WM550 address of the device.

User entry 0 to 63

Factory setting 1

Software ID



Navigation Expert → Communication → WM550 Xx-x → Configuration → Software ID (13287)

Prerequisite **Communication interface protocol (→ 174) = "WM550" option**

Description Defines content for WM550 Task 32.
Detailed information on content for WM550 Task 32, Special Documentation SD02567G.

User entry 0 to 9999

Factory setting 2000

Compatibility mode



Navigation Expert → Communication → WM550 Xx-x → Configuration → Comp. mode (13281)

Description Defines the compatibility mode.

- Selection**
- Nxx5xx
 - Nxx8x

Factory setting Nxx8x

Additional information In **NMS5x** mode: Only values which have also existed on NMS5x Gauge status are output on the bus.
In **NMS8x** mode: All Gauge status are available at this parameter.

Read access	Operator
Write access	Maintenance

"WM550 input selector" submenu (WM550)

 This submenu is only present for devices with a **WM550** option communication interface.

Navigation  Expert → Communication → WM550 Xx-x → WM550 inp select

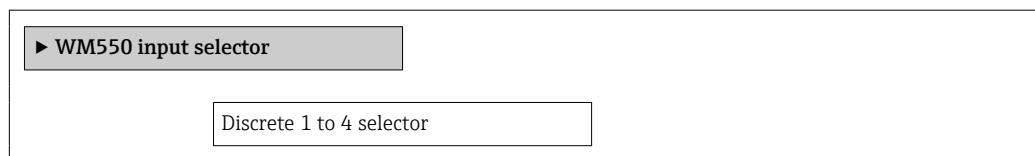

Discrete 1 to 4 selector

Navigation  Expert → Communication → WM550 Xx-x → WM550 inp select → Discrete 1 to 4select (13260-1 to 4)

Description Determines the input source which is transferred as Alarm bit [n] value in the corresponding WM550 tasks.

Selection



- None
- **Balance flag** option Visibility depends on order options or device settings
- Alarm 1...4 any
- Alarm 1...4 HighHigh
- Alarm 1...4 High or HighHigh
- Alarm 1...4 High
- Alarm 1...4 Low
- Alarm 1...4 Low or LowLow
- Alarm 1...4 LowLow
- Digital Xx-x

Factory setting None

Additional information

Read access	Operator
Write access	Maintenance





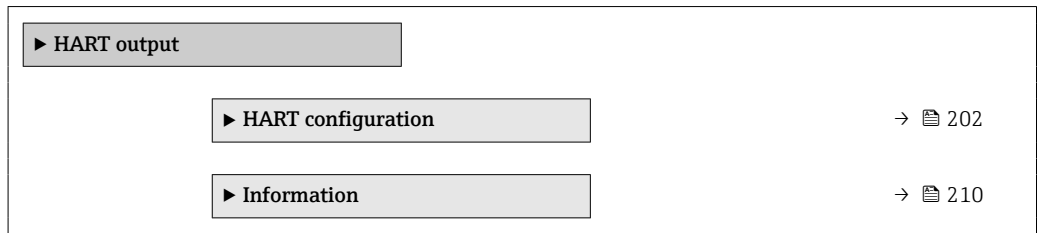









3.4.2 "HART output" submenu

Navigation   Expert → Communication → HART output



"HART configuration" submenu

Navigation  Expert → Communication → HART output → HART config.

▶ HART configuration	
System polling address	→  202
No. of preambles	→  203
PV source	→  203
Assign PV	→  203
0 % value	→  204
100 % value	→  205
PV mA selector	→  205
Primary variable (PV)	→  205
Percent of range	→  206
Assign SV	→  206
Secondary variable (SV)	→  207
Assign TV	→  207
Tertiary variable (TV)	→  208
Assign QV	→  208
Quaternary variable (QV)	→  209

System polling address**Navigation**

 Expert → Communication → HART output → HART config. → Polling address (0219)

Description

Device address for HART communication.

User entry

0 to 63

Factory setting

15

Additional information

Read access	Operator
Write access	Maintenance

No. of preambles



Navigation

Expert → Communication → HART output → HART config. → No. of preambles (0217)

Description

Defines the number of preambles in the HART telegram.

User entry

5 to 20

Factory setting

5

Additional information

Read access	Operator
Write access	Maintenance

PV source



Navigation

Expert → Communication → HART output → HART config. → PV source (11634)

Description

Decides, if the PV configuration is according to an analog output (HART slave) or customized (in case of HART tunneling only).

Selection

- AIO B1-3 *
- AIO C1-3 *
- Custom

Factory setting

Custom

Additional information

Read access	Maintenance
Write access	Maintenance

Assign PV



Navigation

Expert → Communication → HART output → HART config. → Assign PV (0234)

Prerequisite

PV source (→ 203) = Custom

Description

Assign a measured variable to the primary dynamic variable (PV).

Additional information:

The assigned measured variable is also used by the current output.

* Visibility depends on order options or device settings

- Selection**
- None
 - Tank level
 - Tank ullage
 - Measured level
 - Distance
 - Displacer position
 - Water level
 - Upper interface level
 - Lower interface level
 - Bottom level
 - Tank reference height
 - Liquid temperature
 - Vapor temperature
 - Air temperature
 - Observed density value
 - Average profile density
 - Upper density
 - Middle density
 - Lower density
 - P1 (bottom)
 - P2 (middle)
 - P3 (top)
 - GP 1 value
 - GP 2 value
 - GP 3 value
 - GP 4 value

Factory setting Tank level

Additional information

Read access	Operator
Write access	Maintenance

 The **Measured level** option doesn't contain a unit. If a unit is needed, select the **Tank level** option.

0 % value 

Navigation  Expert → Communication → HART output → HART config. → 0 % value (11632)

Prerequisite PV source = Custom

Description 0% value of the primary variable (PV).

User entry Signed floating-point number

Factory setting 0 mm

Additional information

Read access	Operator
Write access	Maintenance

100 % value



Navigation Expert → Communication → HART output → HART config. → 100 % value (11633)

Prerequisite **PV source = Custom**

Description 100% value of the primary variable (PV).

User entry Signed floating-point number

Factory setting 0 mm

Additional information

Read access	Operator
Write access	Maintenance

PV mA selector



Navigation Expert → Communication → HART output → HART config. → PV mA selector (11631)

Prerequisite **PV source = Custom**

Description Assigns a current to the primary HART variable (PV).

- Selection**
- None
 - AIO B1-3 value mA *
 - AIO C1-3 value mA *

Factory setting None

Additional information

Read access	Operator
Write access	Maintenance

Primary variable (PV)

Navigation Expert → Communication → HART output → HART config. → Primary var (PV) (0201)

Description Shows the current measured value of the primary dynamic variable (PV)

Additional information

Read access	Operator
Write access	-

* Visibility depends on order options or device settings

Percent of range

Navigation

 Expert → Communication → HART output → HART config. → Percent of range (0274)

Description

Shows the value of the primary variable (PV) as a percentage of the defined 0% to 100% range.

Additional information

Read access	Operator
Write access	-

Assign SV

**Navigation**

 Expert → Communication → HART output → HART config. → Assign SV (0235)

Description

Assign a measured variable to the second dynamic variable (SV).

Selection

- None
- Tank level
- Tank ullage
- Measured level
- Distance
- Displacer position
- Water level
- Upper interface level
- Lower interface level
- Bottom level
- Tank reference height
- Liquid temperature
- Vapor temperature
- Air temperature
- Observed density value
- Average profile density
- Upper density
- Middle density
- Lower density
- P1 (bottom)
- P2 (middle)
- P3 (top)
- GP 1 value
- GP 2 value
- GP 3 value
- GP 4 value

Factory setting

Liquid temperature

Additional information

Read access	Operator
Write access	Maintenance



The **Measured level** option doesn't contain a unit. If a unit is needed, select the **Tank level** option.

Secondary variable (SV)

Navigation  Expert → Communication → HART output → HART config. → Second.var(SV) (0226)

Prerequisite **Assign SV (→  206) ≠ None**

Description Shows the current measured value of the secondary dynamic variable (SV)

Additional information

Read access	Operator
Write access	-

Assign TV



Navigation  Expert → Communication → HART output → HART config. → Assign TV (0236)

Description Assign a measured variable to the tertiary dynamic variable (TV).

Selection

- None
- Tank level
- Tank ullage
- Measured level
- Distance
- Displacer position
- Water level
- Upper interface level
- Lower interface level
- Bottom level
- Tank reference height
- Liquid temperature
- Vapor temperature
- Air temperature
- Observed density value
- Average profile density
- Upper density
- Middle density
- Lower density
- P1 (bottom)
- P2 (middle)
- P3 (top)
- GP 1 value
- GP 2 value
- GP 3 value
- GP 4 value

Factory setting Water level

Additional information

Read access	Operator
Write access	Maintenance

 The **Measured level** option doesn't contain a unit. If a unit is needed, select the **Tank level** option.

Tertiary variable (TV)

Navigation  Expert → Communication → HART output → HART config. → Tertiary var(TV) (0228)

Prerequisite **Assign TV (→  207) ≠ None**

Description Shows the current measured value of the tertiary (third) dynamic variable (TV)

Additional information

Read access	Operator
Write access	-

Assign QV



Navigation  Expert → Communication → HART output → HART config. → Assign QV (0237)

Description Assign a measured variable to the quaternary dynamic variable (QV).

Selection

- None
- Tank level
- Tank ullage
- Measured level
- Distance
- Displacer position
- Water level
- Upper interface level
- Lower interface level
- Bottom level
- Tank reference height
- Liquid temperature
- Vapor temperature
- Air temperature
- Observed density value
- Average profile density
- Upper density
- Middle density
- Lower density
- P1 (bottom)
- P2 (middle)
- P3 (top)
- GP 1 value
- GP 2 value
- GP 3 value
- GP 4 value

Factory setting Observed density value

Additional information

Read access	Operator
Write access	Maintenance

 The **Measured level** option doesn't contain a unit. If a unit is needed, select the **Tank level** option.

Quaternary variable (QV)

Navigation

 Expert → Communication → HART output → HART config. → Quaterna.var(QV) (0203)

Prerequisite

Assign QV (→  208) ≠ None

Description













Shows the current measured value of the quaternary (fourth) dynamic variable (QV)

Additional information

Read access	Operator
Write access	-

"Information" submenu

Navigation  Expert → Communication → HART output → Information

▶ Information	
HART short tag	→  210
Device tag	→  211
Device revision	→  211
Device ID	→  211
Device type	→  212
Manufacturer ID	→  212
HART revision	→  212
HART descriptor	→  213
HART message	→  213
Hardware revision	→  213
Software revision	→  214
HART date code	→  214

HART short tag



Navigation

 Expert → Communication → HART output → Information → HART short tag (0220)

Description

Defines the short tag for the measuring point.

Maximum length: 8 characters

Allowed characters: A-Z, 0-9, certain special characters

User entry

Character string comprising numbers, letters and special characters (8)

Factory setting

NMS8x

Additional information

Read access	Operator
Write access	Maintenance

Device tag



Navigation Expert → Communication → HART output → Information → Device tag (0215)

Description Enter a unique name for the measuring point to identify the device quickly within the plant.

User entry Character string comprising numbers, letters and special characters (32)

Factory setting NMS8x

Additional information

Read access	Operator
Write access	Maintenance

Device revision

Navigation Expert → Communication → HART output → Information → Device revision (0204)

Description Shows the device revision with which the device is registered with the HART Communication Foundation

User interface 0 to 255

Factory setting 7

Additional information

Read access	Operator
Write access	-

Device ID

Navigation Expert → Communication → HART output → Information → Device ID (0221)

Description Shows the device ID for identifying the device in a HART network

User interface Positive integer

Factory setting 123456

Additional information

Read access	Operator
Write access	-

Device type

Navigation  Expert → Communication → HART output → Information → Device type (0209)

Description Shows the device type with which the measuring device is registered with the HART Communication Foundation

User interface 0 to 65 535

Factory setting 4 397

Additional information

Read access	Operator
Write access	-

Manufacturer ID

Navigation  Expert → Communication → HART output → Information → Manufacturer ID (0259)

Description Shows the device's manufacturer ID registered with the HART Communication Foundation.

User interface 0 to 65 535

Factory setting 17

Additional information

Read access	Operator
Write access	-

HART revision

Navigation  Expert → Communication → HART output → Information → HART revision (0205)

Description HART revision used by the device.

User interface 5 to 7

Factory setting 7

Additional information

Read access	Operator
Write access	-

HART descriptor



Navigation Expert → Communication → HART output → Information → HART descriptor (0212)

Description Enter description for the measuring point

User entry Character string comprising numbers, letters and special characters (16)

Factory setting NMS8x

Additional information

Read access	Operator
Write access	Maintenance

HART message



Navigation Expert → Communication → HART output → Information → HART message (0216)

Description Use this function to define a HART message which is sent via the HART protocol when requested by the master.
 Maximum length: 32 characters
 Allowed characters: A-Z, 0-9, certain special characters

User entry Character string comprising numbers, letters and special characters (32)

Factory setting NMS8x

Additional information

Read access	Operator
Write access	Maintenance

Hardware revision

Navigation Expert → Communication → HART output → Information → Hardware rev. (0206)

Description Hardware revision of the device.

User interface 0 to 30

Factory setting 1

Additional information

Read access	Operator
Write access	-

Software revision

Navigation  Expert → Communication → HART output → Information → Software rev. (0224)

Description Software revision of the device.

User interface 0 to 255

Factory setting 7

Additional information

Read access	Operator
Write access	-

HART date code



Navigation  Expert → Communication → HART output → Information → HART date code (0202)

Description Enter date of the last configuration change. Use this format yyyy-mm-dd

User entry Character string comprising numbers, letters and special characters (10)



Factory setting 2009-07-20

Additional information

Read access	Operator
Write access	Maintenance







3.5 "Application" submenu

Navigation  Expert → Application

▶ Application		
▶ Tank configuration		→  215
▶ Tank calculation		→  239
▶ Alarm		→  256

3.5.1 "Tank configuration" submenu

Navigation  Expert → Application → Tank config

Tank configuration		
Process condition		→  215
▶ Level		→  217
▶ Temperature		→  221
▶ Density		→  225
▶ Pressure		→  229
▶ GP values		→  237

Process condition

Navigation  Expert → Application → Tank config → Process cond. (8001)

Description Select the liquid condition of the tank.

Selection

- Universal
- Calm surface
- Turbulent surface

Factory setting Universal









Additional information  For W&M, setting to option **Calm surface** is recommended.

Read access	Operator
Write access	Maintenance

"Level" submenu

Navigation  Expert → Application → Tank config → Level

▶ Level

Level source	→  217
Empty	→  218
Tank reference height	→  218
Tank level	→  218
Set level	→  219
Upper interface level	→  219
Lower interface level	→  219
Water level source	→  219
Water level	→  220
Manual water level	→  220

Level source



Navigation

 Expert → Application → Tank config → Level → Level source (14601)

Description

Defines the source of the level value.

Selection

- No input value
- HART device 1 ... 15 level
- Level SR *
- Level *
- Displacer position *
- AIO B1-3 value *
- AIO C1-3 value *
- AIP B4-8 value *
- AIP C4-8 value *

Factory setting

Dependent on the device version

Additional information

Read access	Operator
Write access	Maintenance

* Visibility depends on order options or device settings

Empty**Navigation**

Expert → Application → Tank config → Level → Empty (14602)

Description

Distance from reference point to zero position (tank bottom or datum plate).

User entry

0 to 10 000 000 mm

Factory setting

Dependent on the device version

Additional information

Read access	Operator
Write access	Maintenance

The reference point is the reference line of the calibration window.

Tank reference height**Navigation**

Expert → Application → Tank config → Level → Tank ref height (14603)

Description

Defines the distance from the dipping reference point to the zero position (tank bottom or datum plate).

User entry

0 to 10 000 000 mm

Factory setting

Dependent on the device version

Additional information

Read access	Operator
Write access	Maintenance

Tank level**Navigation**

Expert → Application → Tank config → Level → Tank level (14655)

Description

Shows the distance from the zero position (tank bottom or datum plate) to the product surface.

Additional information

Read access	Operator
Write access	-

Set level



Navigation Expert → Application → Tank config → Level → Set level (14604)

Description If the level measured by the device does not match the actual level obtained by a manual dip, enter the correct level into this parameter.

User entry 0 to 10 000 000 mm

Factory setting 0 mm

Additional information

Read access	Operator
Write access	Maintenance

The device adjusts the **Empty** parameter (→ 218) according to the entered value, such that the measured level will match the actual level.

Upper interface level

Navigation Expert → Application → Tank config → Level → Upper I/F level (15003)

Description Shows measured interface level from zero position (tank bottom or datum plate). Value is updated when device generates a valid Interface measurement.

Additional information

Read access	Maintenance
Write access	-

Lower interface level

Navigation Expert → Application → Tank config → Level → Lower I/F level (15004)

Description Shows measured interface level from zero position (tank bottom or datum plate). Value is updated when device generates a valid interface measurement.

Additional information

Read access	Maintenance
Write access	-

Water level source



Navigation Expert → Application → Tank config → Level → Water level src (14971)

Description Defines the source of the bottom water level.

- Selection**
- Manual value
 - Bottom level
 - HART device 1 ... 15 level
 - AIO B1-3 value
 - AIO C1-3 value
 - AIP B4-8 value
 - AIP C4-8 value

Factory setting Manual value

Additional information

Read access	Operator
Write access	Maintenance

Water level

Navigation   Expert → Application → Tank config → Level → Water level (14970)

Description Shows the bottom water level.

Additional information

Read access	Operator
Write access	-

Manual water level



Navigation   Expert → Application → Tank config → Level → Man. water level (14959)

Prerequisite **Water level source (→  219) = Manual value**

Description Defines the manual value of the bottom water level.

User entry -2 000 to 5 000 mm

Factory setting 0 mm









Additional information

Read access	Operator
Write access	Maintenance

"Temperature" submenu

Navigation   Expert → Application → Tank config → Temperature



▶ Temperature

Liquid temp source	→  221
Manual liquid temperature	→  222
Liquid temperature	→  222
Air temperature source	→  222
Manual air temperature	→  223
Air temperature	→  223
Vapor temp source	→  223
Manual vapor temperature	→  224
Vapor temperature	→  224

Liquid temp source



Navigation

  Expert → Application → Tank config → Temperature → Liq temp source (14972)

Description

Defines source from which the liquid temperature is obtained.

Selection

- Manual value
- HART device 1 ... 15 temperature
- AIO B1-3 value
- AIO C1-3 value
- AIP B4-8 value
- AIP C4-8 value

Factory setting

Manual value

Additional information

Read access	Operator
Write access	Maintenance

Manual liquid temperature



Navigation Expert → Application → Tank config → Temperature → Man. liquid temp (15015)

Prerequisite **Liquid temp source (→ 221) = Manual value**

Description Defines the manual value of the liquid temperature.

User entry -50 to 300 °C

Factory setting 25 °C

Additional information

Read access	Operator
Write access	Maintenance

Liquid temperature

Navigation Expert → Application → Tank config → Temperature → Liquid temp. (14978)

Description Shows the average or spot temperature of the measured liquid.

Additional information

Read access	Operator
Write access	-

Air temperature source



Navigation Expert → Application → Tank config → Temperature → Air temp. source (14993)

Description Defines source from which the air temperature is obtained.

Selection

- Manual value
- HART device 1 ... 15 temperature
- AIO B1-3 value
- AIO C1-3 value
- AIP B4-8 value
- AIP C4-8 value

Factory setting Manual value

Additional information

Read access	Operator
Write access	Maintenance

Manual air temperature



Navigation Expert → Application → Tank config → Temperature → Manual air temp. (14961)

Prerequisite **Air temperature source (→ 222) = Manual value**

Description Defines the manual value of the air temperature.

User entry -50 to 300 °C

Factory setting 25 °C

Additional information

Read access	Operator
Write access	Maintenance

Air temperature

Navigation Expert → Application → Tank config → Temperature → Air temp. (14986)

Description Shows the air temperature.

Additional information

Read access	Operator
Write access	-

Vapor temp source



Navigation Expert → Application → Tank config → Temperature → Vapor temp src (14973)

Description Defines the source from which the vapor temperature is obtained.

- Selection**
- Manual value
 - HART device 1 ... 15 vapor temp
 - AIO B1-3 value
 - AIO C1-3 value
 - AIP B4-8 value
 - AIP C4-8 value

Factory setting Manual value

Additional information

Read access	Operator
Write access	Maintenance

Manual vapor temperature



Navigation Expert → Application → Tank config → Temperature → Man. vapor temp. (14960)

Prerequisite **Vapor temp source (→ 223) = Manual value**

Description Defines the manual value of the vapor temperature.

User entry -50 to 300 °C

Factory setting 25 °C

Additional information

Read access	Operator
Write access	Maintenance

Vapor temperature



Navigation Expert → Application → Tank config → Temperature → Vapor temp. (14985)







Description Shows the measured vapor temperature.

Additional information

Read access	Operator
Write access	-



"Density" submenu

Navigation   Expert → Application → Tank config → Density

► Density	
Observed density source	→  225
Observed density	→  226
Air density	→  226
Vapor density	→  226
Measured upper density	→  226
Measured middle density	→  227
Measured lower density	→  227
Water density	→  227
Profile point	→  227
Profile average density	→  228
Profile density timestamp	→  228

Observed density source



Navigation   Expert → Application → Tank config → Density → Density source (13454)

Description Determines how the density is obtained.

- Selection
- HTG *
 - HTMS *
 - Average profile density *
 - Upper density
 - Middle density
 - Lower density

Factory setting Dependent on the device version

Additional information

Read access	Operator
Write access	Maintenance

* Visibility depends on order options or device settings

Observed density

Navigation  Expert → Application → Tank config → Density → Observed density (13452)**Description** Shows the measured or calculated density.**Additional information**

Read access	Operator
Write access	-

Air density

**Navigation**  Expert → Application → Tank config → Density → Air density (14980)**Description** Defines the density of the air surrounding the tank.**User entry** 0.0 to 500.0 kg/m³**Factory setting** 1.2 kg/m³**Additional information**

Read access	Operator
Write access	Maintenance

Vapor density

**Navigation**  Expert → Application → Tank config → Density → Vapor density (14981)**Description** Defines the density of the gas phase in the tank.**User entry** 0.0 to 500.0 kg/m³**Factory setting** 1.2 kg/m³**Additional information**

Read access	Operator
Write access	Maintenance

Measured upper density

Navigation  Expert → Application → Tank config → Density → Meas upper dens. (15001)**Description** Shows the density of the upper phase.

Additional information

Read access	Operator
Write access	-

Measured middle density

Navigation

 Expert → Application → Tank config → Density → Meas middle dens (14997)

Description

Density of the middle phase.

Additional information

Read access	Operator
Write access	-

Measured lower density

Navigation

 Expert → Application → Tank config → Density → Meas lower dens. (15002)

Description

Density of the lower phase.

Additional information

Read access	Maintenance
Write access	-

Water density



Navigation

 Expert → Application → Tank config → Density → Water density (13757)

Description

Density of the water in the tank.

User entry

Signed floating-point number

Factory setting

1 000 kg/m³

Additional information

Read access	Operator
Write access	Maintenance

Profile point

Navigation

 Expert → Application → Tank config → Density → Profile point (8170)

Description

Shows actual number of Density Points measured so far in current operation, and the total Number of Points after Density Profile Operation is complete.

Additional information

Read access	Operator
Write access	-

Profile average density**Navigation**

 Expert → Application → Tank config → Density → Profile avg dens (8175)

Description

Shows the average density calculated after a profile density measurement is complete.

Additional information

Read access	Operator
Write access	-

Profile density timestamp**Navigation**

 Expert → Application → Tank config → Density → Profil dens time (8114)

Description



















Shows the timestamp when the last average density profile was finished.

Additional information

Read access	Operator
Write access	-

"Pressure" submenu

Navigation   Expert → Application → Tank config → Pressure

► Pressure	
P1 (bottom) source	→  230
P1 (bottom)	→  230
P1 (bottom) manual pressure	→  230
P1 position	→  231
P1 offset	→  231
P1 absolute / gauge	→  231
P2 (middle) source	→  232
P2 (middle)	→  232
P2 (middle) manual pressure	→  232
P2 offset	→  233
P1-2 distance	→  233
P2 absolute / gauge	→  233
P3 (top) source	→  234
P3 (top)	→  234
P3 (top) manual pressure	→  234
P3 position	→  235
P3 offset	→  235
P3 absolute / gauge	→  235
Ambient pressure	→  236

P1 (bottom) source **Navigation**   Expert → Application → Tank config → Pressure → P1 (bot) source (14994)**Description** Defines the source of the bottom pressure (P1).**Selection**

- Manual value
- HART device 1 ... 15 pressure
- AIO B1-3 value
- AIO C1-3 value
- AIP B4-8 value
- AIP C4-8 value

Factory setting Manual value**Additional information**

Read access	Operator
Write access	Maintenance

P1 (bottom)**Navigation**   Expert → Application → Tank config → Pressure → P1 (bottom) (14983)**Description** Shows the pressure at the tank bottom.**Additional information**

Read access	Operator
Write access	-

P1 (bottom) manual pressure **Navigation**   Expert → Application → Tank config → Pressure → P1 (bot) manual (14951)**Prerequisite** **P1 (bottom) source** (→  230) = **Manual value****Description** Defines the manual value of the bottom pressure (P1).**User entry** -1.01325 to 25 bar**Factory setting** 0 bar**Additional information**

Read access	Operator
Write access	Maintenance

P1 position



Navigation Expert → Application → Tank config → Pressure → P1 position (14952)

Description Defines the position of the bottom pressure transmitter (P1), measured from zero position (tank bottom or datum plate).

User entry -10 000 to 100 000 mm

Factory setting 5 000 mm

Additional information

Read access	Operator
Write access	Maintenance

P1 offset



Navigation Expert → Application → Tank config → Pressure → P1 offset (14953)

Description Offset for the bottom pressure (P1).
The offset is added to the measured pressure prior to any tank calculation.

User entry -25 to 25 bar

Factory setting 0 bar

Additional information

Read access	Operator
Write access	Maintenance

P1 absolute / gauge



Navigation Expert → Application → Tank config → Pressure → P1 absolut/gauge (14954)

Description Defines whether the connected pressure transmitter measures an absolute or a gauge pressure.

Selection

- Absolute
- Gauge

Factory setting Gauge

Additional information

Read access	Operator
Write access	Maintenance

P2 (middle) source

Navigation Expert → Application → Tank config → Pressure → P2 (mid) source (14995)

Description Defines the source of the middle pressure (P2).

Selection

- Manual value
- HART device 1 ... 15 pressure
- AIO B1-3 value
- AIO C1-3 value
- AIP B4-8 value
- AIP C4-8 value

Factory setting Manual value

Additional information

Read access	Operator
Write access	Maintenance

P2 (middle)

Navigation Expert → Application → Tank config → Pressure → P2 (middle) (14987)

Description Shows the pressure (P2) at the middle transmitter.

Additional information

Read access	Operator
Write access	-

P2 (middle) manual pressure

Navigation Expert → Application → Tank config → Pressure → P2 (mid) manual (14955)

Prerequisite **P2 (middle) source** (→ 232) = **Manual value**

Description Defines the manual value of the middle pressure (P2).

User entry -1.01325 to 25 bar

Factory setting 0 bar

Additional information

Read access	Operator
Write access	Maintenance

P2 offset



Navigation Expert → Application → Tank config → Pressure → P2 offset (14975)

Description Defines the offset for the middle pressure (P2).
The offset is added to the measured pressure prior to any tank calculation.

User entry -25 to 25 bar

Factory setting 0 bar

Additional information

Read access	Operator
Write access	Maintenance

P1-2 distance



Navigation Expert → Application → Tank config → Pressure → P1-2 distance (14974)

Description Defines the distance between the bottom and the middle pressure transmitter.

User entry 0 to 100 000 mm

Factory setting 2 000 mm

Additional information

Read access	Operator
Write access	Maintenance

P2 absolute / gauge



Navigation Expert → Application → Tank config → Pressure → P2 absolut/gauge (14976)

Description Defines whether the connected pressure transmitter measures an absolute or a gauge pressure.

Selection

- Absolute
- Gauge

Factory setting Gauge

Additional information

Read access	Operator
Write access	Maintenance

P3 (top) source

Navigation Expert → Application → Tank config → Pressure → P3 (top) source (14996)

Description Defines the source of the top pressure (P3).

Selection

- Manual value
- HART device 1 ... 15 pressure
- AIO B1-3 value
- AIO C1-3 value
- AIP B4-8 value
- AIP C4-8 value

Factory setting Manual value

Additional information

Read access	Operator
Write access	Maintenance

P3 (top)

Navigation Expert → Application → Tank config → Pressure → P3 (top) (14988)

Description Shows the pressure (P3) at the top transmitter.

Additional information

Read access	Operator
Write access	-

P3 (top) manual pressure

Navigation Expert → Application → Tank config → Pressure → P3 (top) manual (14977)

Prerequisite **P3 (top) source** (→ 234) = **Manual value**

Description Defines the manual value of the top pressure (P3).

User entry -1.01325 to 25 bar

Factory setting 0 bar

Additional information

Read access	Operator
Write access	Maintenance

P3 position



Navigation Expert → Application → Tank config → Pressure → P3 position (14956)

Description Defines the position of the top pressure transmitter (P3), measured from zero position (tank bottom or datum plate).

User entry 0 to 100 000 mm

Factory setting 20 000 mm

Additional information

Read access	Operator
Write access	Maintenance

P3 offset



Navigation Expert → Application → Tank config → Pressure → P3 offset (14957)

Description Offset for the top pressure (P3).
The offset is added to the measured pressure prior to any tank calculation.

User entry -25 to 25 bar

Factory setting 0 bar

Additional information

Read access	Operator
Write access	Maintenance

P3 absolute / gauge



Navigation Expert → Application → Tank config → Pressure → P3 absolut/gauge (14958)

Description Defines whether the connected pressure transmitter measures an absolute or a gauge pressure.

Selection

- Absolute
- Gauge

Factory setting Gauge

Additional information

Read access	Operator
Write access	Maintenance

Ambient pressure

**Navigation**

Expert → Application → Tank config → Pressure → Ambient pressure (14962)

Description

Defines the manual value of the ambient pressure.

User entry

0 to 2.5 bar

Factory setting

1 bar







Additional information

Read access	Operator
Write access	Maintenance

"GP values" submenu

Navigation  Expert → Application → Tank config → GP values

▶ GP values

GP 1 to 4 source	→  237
GP 1 to 4 name	→  238
GP Value 1	→  238
GP Value 2	→  238
GP Value 3	→  238
GP Value 4	→  239

GP 1 to 4 source



Navigation

 Expert → Application → Tank config → GP values → GP 1 to 4 source (14989-1 to 4)

Description

Source of the general purpose value 1 GP1.

Selection

- No input value
- SM S distance
- Average profile density
- Net weight
- AIO B1-3 value
- AIO C1-3 value
- AIP B4-8 value
- AIP C4-8 value
- HART device 1...15 PV
- HART device 1...15 SV
- HART device 1...15 TV
- HART device 1...15 QV
- Modbus A1-4 Value 1...4
- Modbus B1-4 Value 1...4
- Modbus C1-4 Value 1...4
- Modbus D1-4 Value 1...4

Factory setting

No input value

Additional information

Read access	Operator
Write access	Maintenance

GP 1 to 4 name



Navigation Expert → Application → Tank config → GP values → GP 1 name (14963)

Description Defines the label associated with the respective GP value.

User entry Character string comprising numbers, letters and special characters (15)

Factory setting GP Value 1

Additional information

Read access	Operator
Write access	Maintenance

GP Value 1

Navigation Expert → Application → Tank config → GP values → GP Value 1 (14966)

Description Displays the value that will be used as general purpose value.

Additional information

Read access	Operator
Write access	-

GP Value 2

Navigation Expert → Application → Tank config → GP values → GP Value 2 (14967)

Description Displays the value that will be used as general purpose value.

Additional information

Read access	Operator
Write access	-

GP Value 3

Navigation Expert → Application → Tank config → GP values → GP Value 3 (14968)

Description Displays the value that will be used as general purpose value.

Additional information

Read access	Operator
Write access	-

GP Value 4

Navigation  Expert → Application → Tank config → GP values → GP Value 4 (14969)

Description Displays the value that will be used as general purpose value.





Additional information

Read access	Operator
Write access	-

3.5.2 "Tank calculation" submenu

Navigation  Expert → Application → Tank calculation

▶ Tank calculation

- Local gravity →  239
- ▶ HyTD →  242
- ▶ CTSh →  247
- ▶ HTMS →  252

Local gravity

Navigation  Expert → Application → Tank calculation → Local gravity (14979)

Description Shows the manually entered local gravity value.

User entry 9.0 to 10.0 m/s²

Factory setting 9.807 m/s²

"HyTD" submenu*Overview*

Hydrostatic Tank Deformation can be used to compensate the vertical movement of the Gauge Reference Height (GRH) due to bulging of the tank shell caused by the hydrostatic pressure exerted by the liquid stored in the tank. The compensation is based on a linear approximation obtained from manual hand dips at several levels distributed over the full range of the tank.

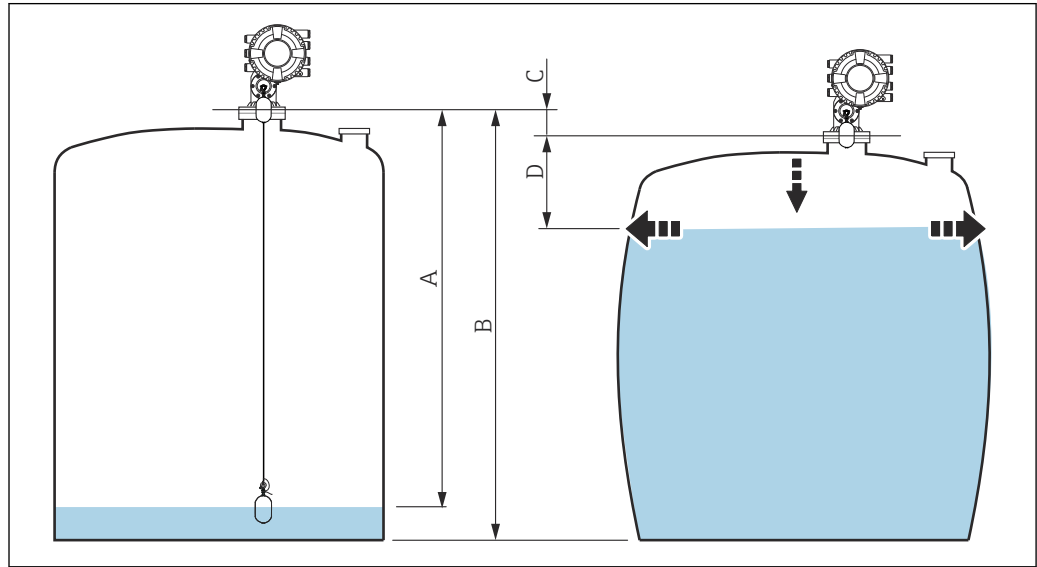

A0030164

18 Correction of the hydrostatic tank deformation (HyTD)

- A "Distance" (level below $L_0 \rightarrow$ "HyTD correction value" = 0)
- B Gauge Reference Height (GRH)
- C HyTD correction value
- D "Distance" (level above $L_0 \rightarrow$ "HyTD correction value" > 0)

Linear approximation of the HyTD correction

The real amount of deformation varies non-linearly with the level due to the construction of the tank. However, as the correction values are typically small compared to the measured level, a simple straight line method can be used with good results.

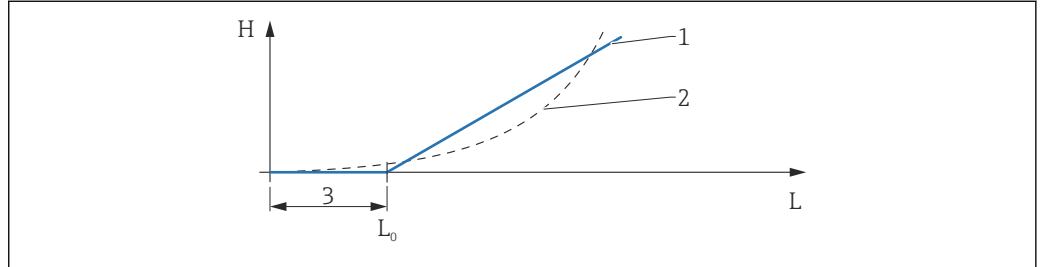

A0028724

19 Calculation of the HyTD correction

- 1 Linear correction according to "Deformation factor (→ 243)"
- 2 Real correction
- 3 Starting level (→ 242)
- L Measured level
- H HyTD correction value (→ 242)

Calculation of the HyTD correction

$$L \leq L_0 \Rightarrow C_{HyTD} = 0$$

$$L > L_0 \Rightarrow C_{HyTD} = - (L - L_0) \times D$$





A0028715

L	Measured level
L₀	Starting level
C_{HyTD}	HyTD correction value
D	Deformation factor

Description of parameters

Navigation  Expert → Application → Tank calculation → HyTD

▶ HyTD

HyTD correction value	→  242
HyTD mode	→  242
Starting level	→  242
Deformation factor	→  243

HyTD correction value

Navigation  Expert → Application → Tank calculation → HyTD → HyTD corr. value (13603)

Description Shows the correction value from the Hydrostatic Tank Deformation.

Additional information

Read access	Operator
Write access	-

HyTD mode



Navigation  Expert → Application → Tank calculation → HyTD → HyTD mode (14652)

Description Activates or deactivates the calculation of the Hydrostatic Tank Deformation.

Selection

- No
- Yes

Factory setting No

Additional information

Read access	Operator
Write access	Maintenance

Starting level



Navigation  Expert → Application → Tank calculation → HyTD → Starting level (13601)

Description Defines the starting level for the Hydrostatic Tank Deformation. Levels below this value are not corrected.

User entry 0 to 5 000 mm

Factory setting 500 mm

Additional information

Read access	Operator
Write access	Maintenance

Deformation factor



Navigation Expert → Application → Tank calculation → HyTD → Deform factor (13602)

Description Defines the deformation factor for the HyTD (change of device position per change of level).

User entry -1.0 to 1.0 %

Factory setting 0.2 %



Additional information

Read access	Operator
Write access	Maintenance

"CTSh" submenu

Overview

CTSh (correction for the thermal expansion of the tank shell) compensates for effects on the Gauge Reference Height (GRH) and on the expansion or contraction of the measuring wire due to temperature effects on the tank shell or stilling well. The temperature effects are separated into two parts, respectively affecting the 'dry' and 'wetted' part of the tank shell or stilling well. The correction function is based on thermal expansion coefficients of steel and insulation factors for both the 'dry' and 'wet' parts of the wire and the tank shell. The temperatures used for the correction can be selected from on manual or measured values.

-  This correction is recommended for the following situations:
 - if the operating temperature deviates considerably from the temperature during calibration ($\Delta T > 10\text{ °C}$ (18 °F))
 - for extremely high tanks
 - for refrigerated, cryogenic or heated applications
-  As the use of this correction will influence the innage level reading, it is recommended to ensure the manual hand dip and level verification procedures are being conducted correctly before enabling this correction method.
-  This mode cannot be used in conjunction with HTG because the level is not measured relative to the gauge reference height with HTG.

CTSh: Calculation of the wall temperature

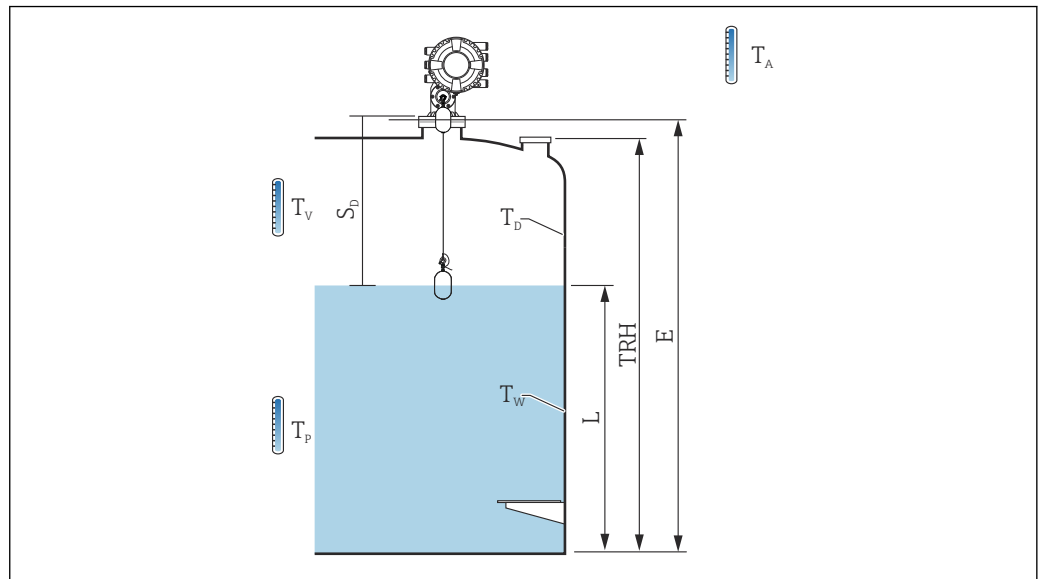

A0028713

20 Parameters for the CTSh calculation

T_W	Temperature of the wetted part of the tank shell
T_D	Temperature of the dry part of the tank shell
T_P	Product temperature
T_V	Vapor temperature (in the tank)
T_A	Ambient temperature (atmosphere surrounding the tank)
S_d	Measured distance (Empty to Level)
TRH	Tank reference height
E	Empty
L	Level









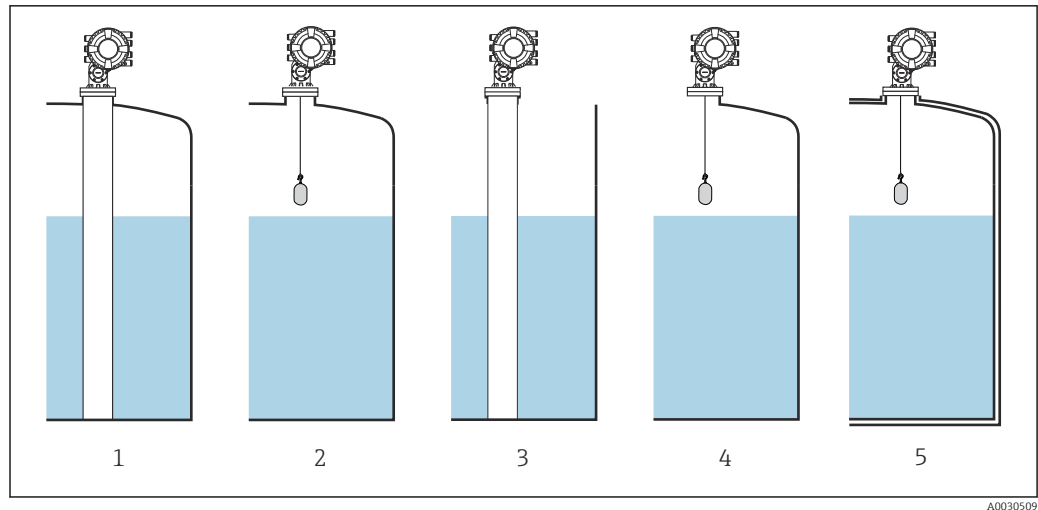

CTSh: Calculation of the wall temperature

Depending on the parameters **Covered tank** (→ 248) and **Stilling well** (→ 248), the temperatures T_W of the wetted and T_D of the dry part of the tank wall are calculated as follows:

Covered tank (→ 248)	Stilling well (→ 248)	T_W	T_D
Covered	Yes ¹⁾	T_P	T_V
	No	$(7/8) T_P + (1/8) T_A$	$(1/2) T_V + (1/2) T_A$
Open top	Yes	T_P	T_A
	No	$(7/8) T_P + (1/8) T_A$	T_A

1) This option is also valid for insulated tanks without a stilling well. This is due to the temperature inside and outside of the tank shell being the same due to the insulation of the tank.



- 1 Covered tank (→  248) = Covered; Stilling well (→  248) = Yes
- 2 Covered tank (→  248) = Covered; Stilling well (→  248) = No
- 3 Covered tank (→  248) = Open top; Stilling well (→  248) = Yes
- 4 Covered tank (→  248) = Open top; Stilling well (→  248) = No
- 5 Insulated tank: Covered tank (→  248) = Open top; Stilling well (→  248) = Yes

CTSh: Calculation of the correction

$$C_{CTSh} = \alpha_{tank} (TRH - L)(T_D - T_{cal}) + \alpha_{tank} L (T_W - T_{cal}) - \alpha_{wire} S_D (T_v - T_{cal})$$







A0030497

TRH	Tank reference height
L	Level
T_D	Temperature of the dry part of the tank shell (calculated from T _P , T _V and T _A)
T_W	Temperature of the wetted part of the tank shell (calculated from T _P , T _V and T _A)
T_{cal}	Temperature at which the measurement has been calibrated
α_{tank}	Linear expansion coefficient of tank
α_{wire}	Linear expansion coefficient of wire
C_{CTSh}	CTSh correction value

Description of parameters



Navigation   Expert → Application → Tank calculation → CTSh

▶ CTSh

CTSh correction value	→  247
CTSh mode	→  248
Covered tank	→  248
Stilling well	→  248
Calibration temperature	→  249
Linear expansion coefficient	→  249
Wire expansion coefficient	→  249

CTSh correction value

Navigation

  Expert → Application → Tank calculation → CTSh → CTSh corr value (13651)



Description

Shows the CTSh correction value.

Additional information

Read access	Operator
Write access	-

CTSh mode

Navigation   Expert → Application → Tank calculation → CTSh → CTSh mode (14651)

Description Activates or deactivates the CTSh.

Selection

- No
- Yes
- With wire *
- Only wire *

Factory setting No

Additional information

Read access	Operator
Write access	Maintenance

Covered tank

Navigation   Expert → Application → Tank calculation → CTSh → Covered tank (13654)

Description Determines whether the tank is covered.

Selection

- Open top
- Covered

Factory setting Open top

Additional information

Read access	Operator
Write access	Maintenance

 The **Covered** option is only valid for fixed tank roofs. For a floating roof select **Open top**.

Stilling well

Navigation   Expert → Application → Tank calculation → CTSh → Stilling well (13653)

Description Determines whether the device is mounted on a stilling well.

Selection

- No
- Yes

Factory setting No

* Visibility depends on order options or device settings

Additional information

Read access	Operator
Write access	Maintenance

Calibration temperature



Navigation

Expert → Application → Tank calculation → CTSh → Calibration temp (13652)

Description

Specify temperature at which the measurement has been calibrated.

User entry

-50 to 250 °C

Factory setting

25 °C

Additional information

Read access	Operator
Write access	Maintenance

Linear expansion coefficient



Navigation

Expert → Application → Tank calculation → CTSh → Linear exp coeff (13655)

Description

Defines the linear expansion coefficient of the tank shell material.

User entry

0 to 100 ppm

Factory setting

15 ppm

Additional information

Read access	Operator
Write access	Maintenance

Wire expansion coefficient



Navigation

Expert → Application → Tank calculation → CTSh → Wire exp coeff (13656)

Description

Defines the expansion coefficient of the wire material of the drum. Value is programmed in factory.

User entry

0 to 100 ppm

Factory setting

15 ppm

"HTMS" submenu

Overview

The Hybrid Tank Measurement System (HTMS) is a method to calculate the density of a product in a tank based on both a (top mounted) level and at least one (bottom mounted) pressure measurement. An additional pressure sensor can be installed at the top of the tank to provide information about the vapor pressure and to make the density calculation more accurate. The calculation method also takes into account a possible level of water at the bottom of the tank to make density calculations as accurate as possible.

HTMS parameters

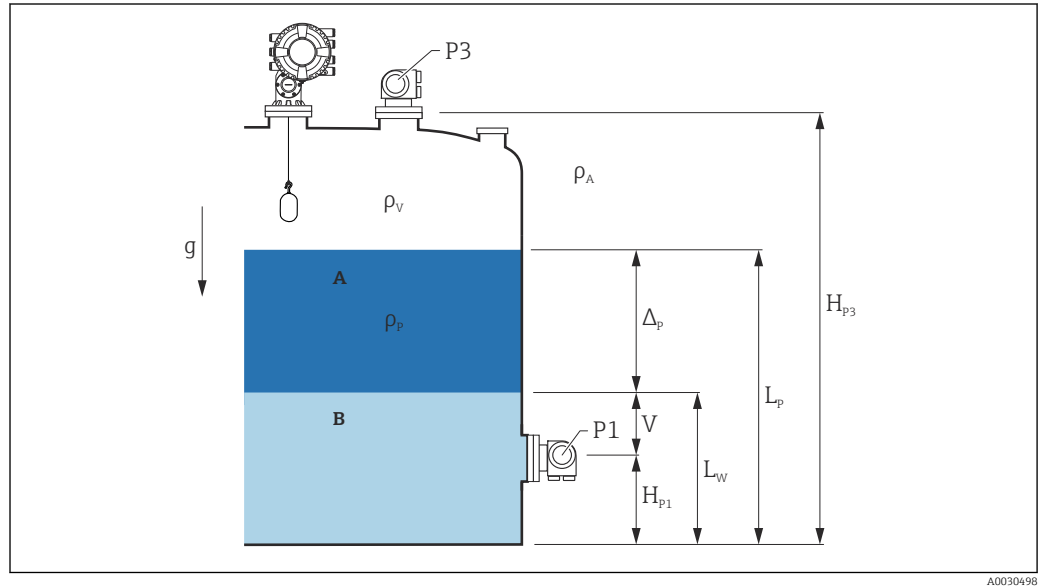

21 HTMS parameters

- A Product
- B Water

Parameter	Navigation path
P1 (Bottom pressure)	Setup → Advanced setup → Tank configuration → Pressure → P1 (bottom)
H_{p1} (Position of P1 transmitter)	Setup → Advanced setup → Tank configuration → Pressure → P1 position
P3 (Top pressure)	Setup → Advanced setup → Tank configuration → Pressure → P3 (top)
H_{p3} (Position of P3 transmitter)	Setup → Advanced setup → Tank configuration → Pressure → P3 position
ρ_p (Density of the product ¹⁾)	<ul style="list-style-type: none"> ■ Measured value: Setup → Advanced setup → Calculation → HTMS → Density value (13753) ■ User-defined value: Setup → Advanced setup → Calculation → HTMS → Manual upper density (14998)
ρ_v (Vapor density)	Expert → Application → Tank configuration → Density → Vapor density
ρ_A (Ambient air temperature)	Setup → Advanced setup → Tank configuration → Density → Air density
g (Local gravity)	Expert → Application → Tank Calculation → Local gravity
L_p (Level of the product)	Operation → Tank level (14655)
L_w (Bottom water level)	Operation → Water level (14970)
$V = L_w - H_{p1}$	
$\Delta_p = L_p - L_w = L_p - V - H_{p1}$	

1) Depending on the situation this parameter is measured or a user-defined value is used.

HTMS modes

Two HTMS modes can be selected in the **HTMS mode** parameter (→ 252). The mode determines whether one or two pressure values are used. Depending on the selected mode a number of additional parameters are required for the calculation of the product density.

i The **HTMS P1+P3** option must be used in pressurized tanks in order to compensate for the pressure of the vapor phase.

HTMS mode (→ 252)	Measured variables	Required additional parameters	Calculated variables
HTMS P1	<ul style="list-style-type: none"> ▪ P₁ ▪ L_p 	<ul style="list-style-type: none"> ▪ g ▪ H_{p1} ▪ L_w (optional) 	ρ _p
HTMS P1+P3	<ul style="list-style-type: none"> ▪ P₁ ▪ P₃ ▪ L_p 	<ul style="list-style-type: none"> ▪ ρ_v ▪ ρ_A ▪ g ▪ H_{p1} ▪ H_{p3} ▪ L_w (optional) 	ρ _p (more precise calculation for pressurized tanks)

Minimum level

The density of the product can only be calculated if the product has a minimum thickness :

$$\Delta_p \geq \Delta_{p, \min}$$

A0028864

This is equivalent to the following condition for the product level:

$$L_p - V \geq \Delta_{p, \min} + H_{p1} = L_{\min}$$

A0028863

L_{min} is defined in the **Minimum level** parameter (→ 253). As can be seen from the formula it always must be bigger than H_{p1}.

If L_p - V falls below this limit, the density is calculated as follows:

- If a previous calculated value is available, this value will be kept as long as no new calculation is possible.
- If no value was previously calculated, the manual value (defined in the **Manual upper density** parameter) will be used.

Hysteresis

The level of the product in a tank is not constant but slightly varies, due for example to filling disturbances. If the level oscillates around the changeover level (**Minimum level** (→ 253)), the algorithm will constantly switch between calculating the value and holding the previous result. To avoid this effect a positional hysteresis is defined around the changeover point.

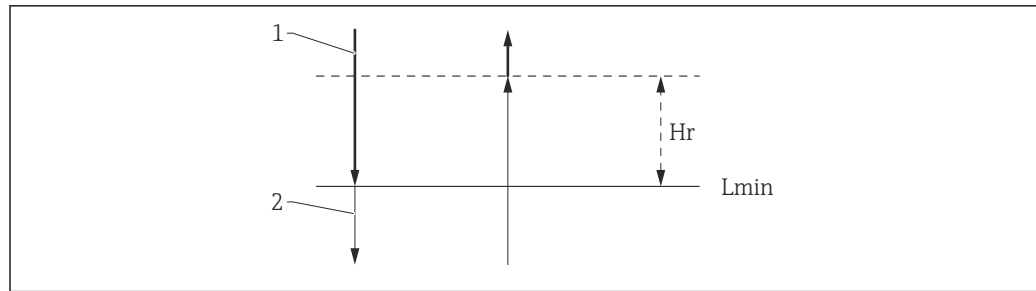

A0029148

22 HTMS hysteresis

- 1 Value calculated
- 2 Value held/manual
- L_{min} Minimum level (→ 253)
- H_r Hysteresis (→ 254)

Description of parameters

Navigation Expert → Application → Tank calculation → HTMS

▶ HTMS

HTMS mode	→ 252
Manual density	→ 253
Density value	→ 253
Minimum level	→ 253
Minimum pressure	→ 254
Safety distance	→ 254
Hysteresis	→ 254
Water density	→ 255

HTMS mode

Navigation

Expert → Application → Tank calculation → HTMS → HTMS mode (13751)

Description

Defines the HTMS mode. Depending on the mode one or two pressure transmitters are used.

Selection

- HTMS P1
- HTMS P1+P3

Factory setting

HTMS P1

Additional information

Read access	Operator
Write access	Maintenance

Meaning of the options

- HTMS P1
Only a bottom pressure transmitter (P1) is used.
- HTMS P1+P3
A bottom (P1) and top (P3) pressure transmitter are used. This option should be selected for pressurized tanks.

Manual density



Navigation

Expert → Application → Tank calculation → HTMS → Manual density (15009)

Description

Defines the manual density.

User entry

0 to 3 000 kg/m³

Factory setting

800 kg/m³

Additional information

Read access	Maintenance
Write access	Maintenance

Density value

Navigation

Expert → Application → Tank calculation → HTMS → Density value (13753)

Description

Shows the calculated product density.

Additional information

Read access	Operator
Write access	-

Minimum level



Navigation

Expert → Application → Tank calculation → HTMS → Min. level (13752)

Description

Defines the minimum product level for a HTMS calculation.

If Lp - V falls below the limit defined in this parameter, the density retains its last value or the manual value is used instead.

User entry

0 to 20 000 mm

Factory setting

7 000 mm

Additional information

Read access	Operator
Write access	Maintenance

Minimum pressure**Navigation**

Expert → Application → Tank calculation → HTMS → Minimum pressure (13754)

Description

Defines the minimum pressure for a HTMS calculation.

If the pressure P1 (or the difference P1 - P3) falls below the limit defined in this parameter, the density retains its last value or the manual value is used instead.

User entry

0 to 100 bar

Factory setting

0.1 bar

Additional information

Read access	Operator
Write access	Maintenance

Safety distance**Navigation**

Expert → Application → Tank calculation → HTMS → Safety distance (13756)

Description

Defines the minimum level which must be present above the bottom pressure sensor before its signal is used for the calculation.

User entry

0 to 10 000 mm

Factory setting

2 000 mm

Additional information

Read access	Operator
Write access	Maintenance

Hysteresis**Navigation**

Expert → Application → Tank calculation → HTMS → Hysteresis (13755)

Description

Defines the hysteresis for the HTMS calculation. Prevents constant switching if the level is near the switch-over point.

User entry

0 to 2 000 mm

Factory setting

50 mm

Additional information

Read access	Operator
Write access	Maintenance

Water density



Navigation

Expert → Application → Tank calculation → HTMS → Water density (13757)

Description

Density of the water in the tank.

User entry

Signed floating-point number

Factory setting

1 000 kg/m³

Additional information



















Read access	Operator
Write access	Maintenance

3.5.3 "Alarm" submenu

Navigation  Expert → Application → Alarm

"Alarm" submenu

Navigation  Expert → Application → Alarm → Alarm

▶ Alarm	
Alarm mode	→  257
Error value	→  258
Alarm value source	→  259
Alarm value	→  260
HH alarm value	→  260
H alarm value	→  260
L alarm value	→  261
LL alarm value	→  261
HH alarm	→  261
H alarm	→  262
HH+H alarm	→  262
L alarm	→  262
LL alarm	→  262
LL+L alarm	→  263
Any error	→  263
Clear alarm	→  263
Alarm hysteresis	→  264
Damping factor	→  264

Alarm mode



Navigation Expert → Application → Alarm → Alarm → Alarm mode (13864)

Description Defines the alarm mode of the selected alarm.

- Selection**
- Off
 - On
 - Latching

Factory setting Off

Additional information

Read access	Operator
Write access	Maintenance

Meaning of the options

- **Off**
No alarms are generated.
- **On**
An alarm disappears if the alarm condition is no longer present (taking into consideration the hysteresis).
- **Latching**
All alarms remain active until the user selects **Clear alarm** (→ 263) = **Yes** or the power is switched off and on.

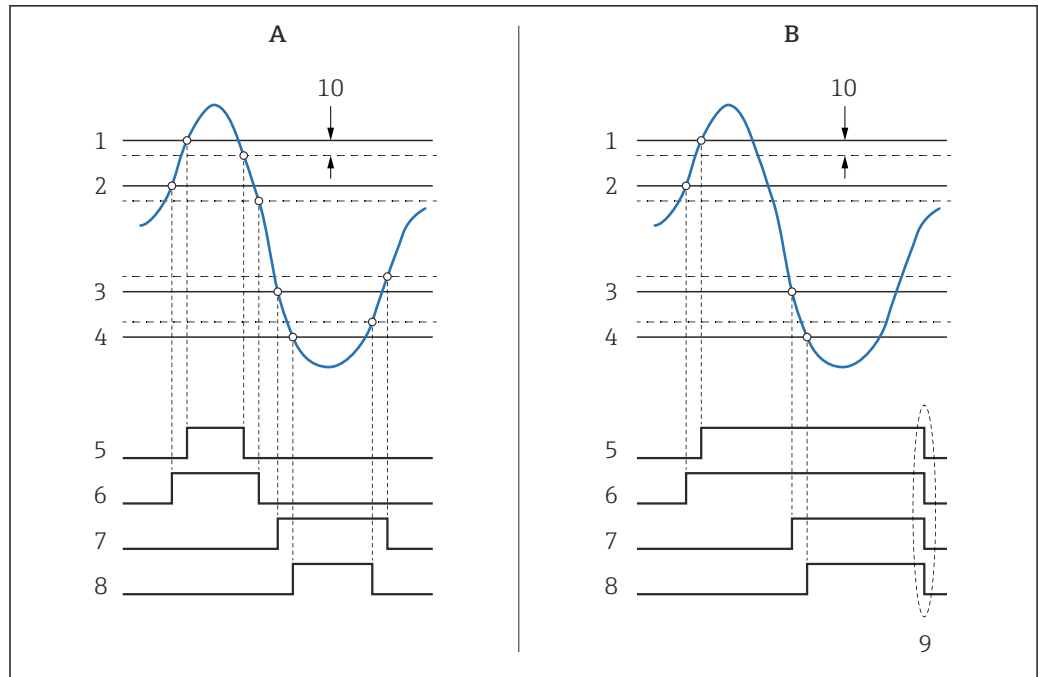

A0029539

23 Principle of the limit evaluation

- A Alarm mode (→ 257) = On
- B Alarm mode (→ 257) = Latching
- 1 HH alarm value (→ 260)
- 2 H alarm value (→ 260)
- 3 L alarm value (→ 261)
- 4 LL alarm value (→ 261)
- 5 HH alarm (→ 261)
- 6 H alarm (→ 262)
- 7 L alarm (→ 262)
- 8 LL alarm (→ 262)
- 9 "Clear alarm (→ 263)" = "Yes" or power off-on
- 10 Hysteresis (→ 264)

Error value



Navigation

Expert → Application → Alarm → Alarm → Error value (13851)

Prerequisite

Alarm mode (→ 257) ≠ Off

Description

Defines the alarm to be issued if the input value is invalid.

Selection

- No alarm
- HH+H alarm
- H alarm
- L alarm
- LL+L alarm
- All alarms

Factory setting

All alarms

Additional information

Read access	Operator
Write access	Maintenance

Alarm value source



Navigation Expert → Application → Alarm → Alarm → Alarm source (13866)

Prerequisite **Alarm mode (→ 257) ≠ Off**

Description Determines the process variable to be monitored.

- Selection**
- Tank level
 - Liquid temperature
 - Vapor temperature
 - Water level
 - P1 (bottom)
 - P2 (middle)
 - P3 (top)
 - Observed density value
 - Volume
 - Flow velocity
 - Volume flow
 - Vapor density
 - Middle density
 - Upper density
 - Correction
 - Tank level %
 - GP 1...4 value
 - Measured level
 - P3 position
 - Tank reference height
 - Local gravity
 - P1 position
 - Manual density
 - Tank ullage
 - Average profile density
 - Lower density
 - Upper interface level
 - Lower interface level
 - Bottom level
 - Displacer position
 - HART device 1...15 PV
 - HART device 1...15 SV
 - HART device 1...15 TV
 - HART device 1...15 QV
 - HART device 1...15 PV mA
 - HART device 1...15 PV %
 - Element temperature 1...24
 - AIO B1-3 value
 - AIO C1-3 value
 - AIP B4-8 value
 - AIP C4-8 value
 - None

Factory setting None

Additional information

Read access	Operator
Write access	Maintenance

Alarm value

Navigation  Expert → Application → Alarm → Alarm → Alarm value (13863)

Prerequisite **Alarm mode (→  257) ≠ Off**

Description Shows the current value of the process variable being monitored.

User interface Signed floating-point number

Factory setting 0 None

Additional information

Read access	Operator
Write access	-

HH alarm value



Navigation  Expert → Application → Alarm → Alarm → HH alarm value (13855)

Prerequisite **Alarm mode (→  257) ≠ Off**

Description Defines the high-high(HH) limit value.

User entry Signed floating-point number

Factory setting 0 None

Additional information

Read access	Operator
Write access	Maintenance

H alarm value



Navigation  Expert → Application → Alarm → Alarm → H alarm value (13854)

Prerequisite **Alarm mode (→  257) ≠ Off**

Description Defines the high(H) limit value.

User entry Signed floating-point number

Factory setting 0 None

Additional information

Read access	Operator
Write access	Maintenance

L alarm value



Navigation Expert → Application → Alarm → Alarm → L alarm value (13853)

Prerequisite **Alarm mode (→ 257) ≠ Off**

Description Defines the low limit value.

User entry Signed floating-point number

Factory setting 0 None

Additional information

Read access	Operator
Write access	Maintenance

LL alarm value



Navigation Expert → Application → Alarm → Alarm → LL alarm value (13852)

Prerequisite **Alarm mode (→ 257) ≠ Off**

Description Defines the low-low(LL) limit value.

User entry Signed floating-point number

Factory setting 0 None

Additional information

Read access	Operator
Write access	Maintenance

HH alarm

Navigation Expert → Application → Alarm → Alarm → HH alarm (13857)

Prerequisite **Alarm mode (→ 257) ≠ Off**

Description Shows whether an HH alarm is currently active.

Additional information

Read access	Operator
Write access	-

H alarm

Navigation  Expert → Application → Alarm → Alarm → H alarm (13856)

Prerequisite **Alarm mode (→  257) ≠ Off**

Description Shows whether an H alarm is currently active.

Additional information

Read access	Operator
Write access	-

HH+H alarm

Navigation  Expert → Application → Alarm → Alarm → HH+H alarm (13858)

Prerequisite **Alarm mode (→  257) ≠ Off**

Description Shows whether an HH or H alarm is currently active.

Additional information

Read access	Operator
Write access	-

L alarm

Navigation  Expert → Application → Alarm → Alarm → L alarm (13859)

Prerequisite **Alarm mode (→  257) ≠ Off**

Description Shows whether an L alarm is currently active.

Additional information

Read access	Operator
Write access	-

LL alarm

Navigation  Expert → Application → Alarm → Alarm → LL alarm (13868)

Prerequisite **Alarm mode (→  257) ≠ Off**

Description Shows whether an LL alarm is currently active.

Additional information

Read access	Operator
Write access	-

LL+L alarm**Navigation**

  Expert → Application → Alarm → Alarm → LL+L alarm (13869)

Prerequisite

Alarm mode (→  257) ≠ Off

Description

Shows whether an LL or L alarm is currently active.

Additional information

Read access	Operator
Write access	-

Any error**Navigation**

  Expert → Application → Alarm → Alarm → Any error (13867)

Prerequisite

Alarm mode (→  257) ≠ Off

Description

Show whether any alarm is currently active.

User interface

- Unknown
- Inactive
- Active
- Error

Factory setting

Unknown

Additional information

Read access	Operator
Write access	-

Clear alarm**Navigation**

  Expert → Application → Alarm → Alarm → Clear alarm (13861)

Prerequisite

Alarm mode (→  257) = Latching

Description

Deletes an alarm which is still active although the alarm condition is no longer present.

Selection

- No
- Yes

Factory setting

No

Additional information

Read access	Operator
Write access	Maintenance

Alarm hysteresis**Navigation**

Expert → Application → Alarm → Alarm → Alarm hysteresis (13862)

Prerequisite

Alarm mode (→ 257) ≠ Off

Description

Defines the hysteresis for the limit values. The hysteresis prevents constant changes of the alarm state if the level is near one of the limit values.

User entry

Signed floating-point number

Factory setting

0.001

Additional information

Read access	Maintenance
Write access	Maintenance

Damping factor**Navigation**

Expert → Application → Alarm → Alarm → Damping factor (13860)

Description

Defines the damping constant (in seconds).

User entry

0 to 999.9 s

Factory setting











0 s

Additional information



Read access	Operator
Write access	Maintenance

3.6 "Tank values" submenu

Navigation   Expert → Tank values

▶ Tank values		
Net weight		→  265
Gauge status		→  265
Balance flag		→  266
Standby level		→  266
Offset standby distance		→  267
One-time command status		→  268
▶ Level		→  268
▶ Temperature		→  273
▶ Density		→  276
▶ Pressure		→  280
▶ GP values		→  281

Net weight

Navigation   Expert → Tank values → Net weight (8007)

Description Shows the corrected weight data from the detector, as compensated by the drum table, This weight is used for measurement.

Additional information

Read access	Operator
Write access	-

Gauge status

Navigation   Expert → Tank values → Gauge status (8081)

Description Indicates the current status of the device gauge command.

Additional information

Read access	Operator
Write access	-

Balance flag**Navigation**
 Expert → Tank values → Balance flag (8006)
Description

Indicates the validity of the Measurement. If balanced, corresponding Value (Liquid Level, Upper Interface, Lower Interface, Tank Bottom) is updated.

Additional information

Read access	Operator
Write access	-

Standby level**Navigation**
 Expert → Tank values → Standby level (8194)
Description

Defines the position in the tank where the displacer waits for the liquid level to rise during standby level gauge command.

User entry

-999 999.9 to 999 999.9 mm

Factory setting

0 mm

Additional information

Read access	Operator
Write access	Maintenance

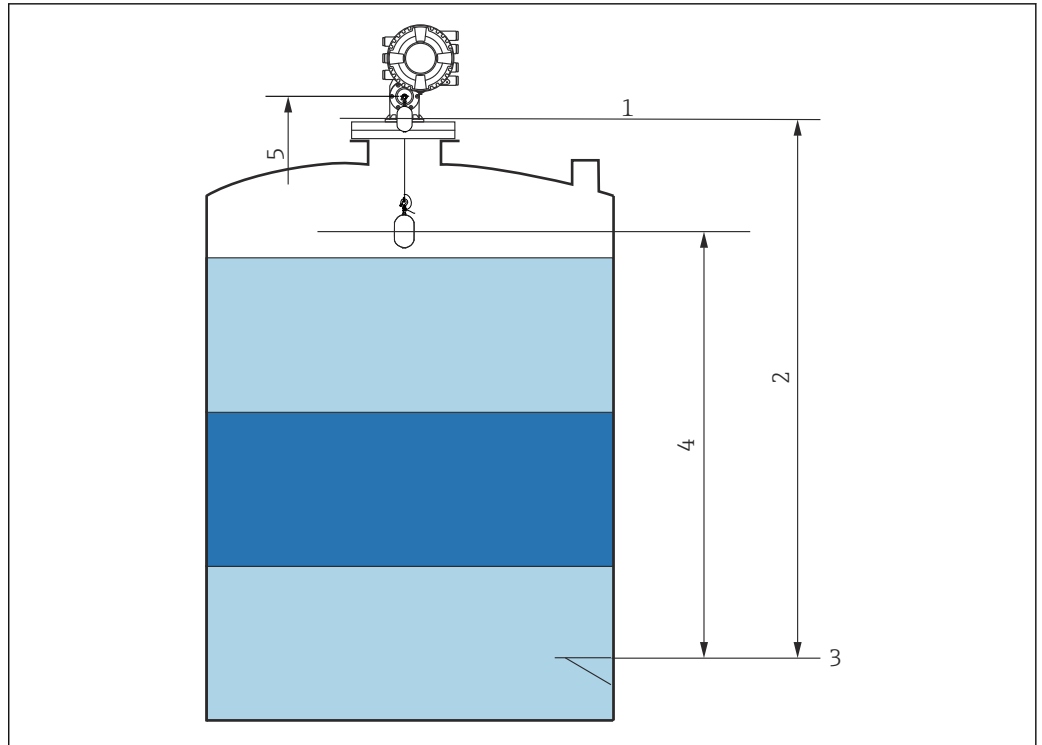

A0055643

24 Displacer waiting for the liquid level to rise during standby level gauge command

- 1 Gauge reference height
- 2 Empty
- 3 Datum plate
- 4 Standby level
- 5 Reference position

Offset standby distance

Navigation

Expert → Tank values → Offset distance (8107)

Description

Defines the distance from the current position where the displacer waits for the liquid level to rise during offset standby gauge command.

User entry

0 to 999 999.9 mm

Factory setting

500 mm

Additional information

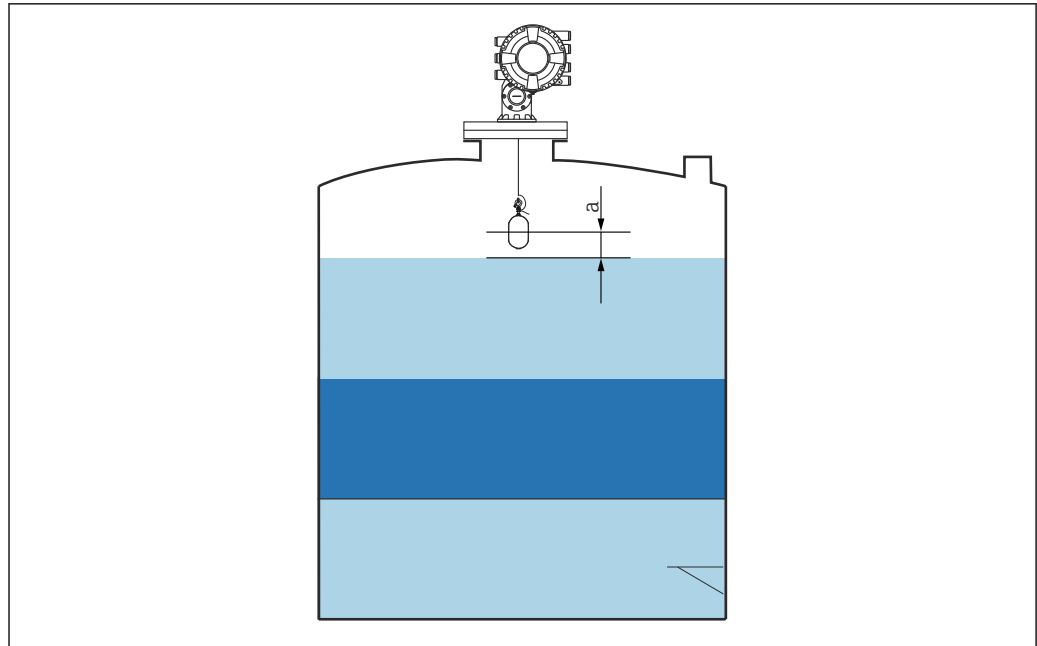

A0051202

25 a: Offset standby distance

One-time command status

Navigation

Expert → Tank values → One-time Cmd (8201)

Description

Indicates the status of the last executed one-time gauge command.

Additional information

Read access	Operator
Write access	-

Additional information











i One-time command is available for all gauge commands, excepting Level, Stop, Up, and Interface.

3.6.1 "Level" submenu



Navigation Expert → Tank values → Level

▶ Level

- Tank level → 269
- Tank Level % → 269
- Tank ullage → 270
- Tank ullage % → 270

Upper interface level	→  270
Upper interface level timestamp	→  270
Lower interface level	→  271
Lower interface level timestamp	→  271
Bottom level	→  271
Bottom level timestamp	→  271
Water level	→  272
Measured level	→  272
Distance	→  272
Displacer position	→  272

Tank level



Navigation   Expert → Tank values → Level → Tank level (14655)

Description Shows the distance from the zero position (tank bottom or datum plate) to the product surface.

Additional information

Read access	Operator
Write access	-

Tank Level %

Navigation   Expert → Tank values → Level → Tank Level % (14654)

Description Shows the level as a percentage of the full measuring range.

Additional information

Read access	Operator
Write access	-

Tank ullage

Navigation  Expert → Tank values → Level → Tank ullage (14657)

Description Shows the remaining empty space in the tank.

Additional information

Read access	Operator
Write access	-

Tank ullage %

Navigation  Expert → Tank values → Level → Tank ullage % (14658)

Description Shows the remaining empty space in percentage related to parameter tank reference height.

Additional information

Read access	Operator
Write access	-

Upper interface level

Navigation  Expert → Tank values → Level → Upper I/F level (15003)

Description Shows measured interface level from zero position (tank bottom or datum plate). Value is updated when device generates a valid Interface measurement.

Additional information

Read access	Maintenance
Write access	-

Upper interface level timestamp



Navigation  Expert → Tank values → Level → Up I/F timestamp (8055)

Description Shows timestamp for the last measured upper interface level.

Additional information

Read access	Operator
Write access	-

Lower interface level



Navigation   Expert → Tank values → Level → Lower I/F level (15004)

Description Shows measured interface level from zero position (tank bottom or datum plate). Value is updated when device generates a valid interface measurement.

Additional information

Read access	Maintenance
Write access	-

Lower interface level timestamp



Navigation   Expert → Tank values → Level → LowI/F timestamp (8061)

Description Shows timestamp of the last measured lower interface level.

Additional information

Read access	Operator
Write access	-

Bottom level



Navigation   Expert → Tank values → Level → Bottom level (15018)

Description Shows the bottom level.

Additional information

Read access	Operator
Write access	-

Bottom level timestamp

Navigation   Expert → Tank values → Level → BotLev timestamp (8048)

Description Shows the timestamp for measured bottom level.

Additional information

Read access	Operator
Write access	-

Water level

Navigation  Expert → Tank values → Level → Water level (14970)

Description Shows the bottom water level.

Additional information

Read access	Operator
Write access	-

Measured level

Navigation  Expert → Tank values → Level → Measured level (14653)

Description Shows the measured level without any correction from the tank calculations.

Additional information

Read access	Operator
Write access	-

Distance

Navigation  Expert → Tank values → Level → Distance (8103)

Description Shows measured distance from reference position.

Additional information

Read access	Operator
Write access	-

Displacer position

Navigation  Expert → Tank values → Level → Displacer pos (15019)









Description Shows the displacer position.

Additional information

Read access	Operator
Write access	-

3.6.2 "Temperature" submenu

Navigation  Expert → Tank values → Temperature

▶ Temperature	
Liquid temperature	→  273
Vapor temperature	→  273
Air temperature	→  274
▶ NMT element values	→  274
▶ Element temperature	→  274
Element temperature 0 to 23	→  274
▶ Element position	→  274
Element position 0 to 23	→  274

Liquid temperature

Navigation  Expert → Tank values → Temperature → Liquid temp. (14978)

Description Shows the average or spot temperature of the measured liquid.

Additional information	Read access	Operator
	Write access	-



Vapor temperature

Navigation  Expert → Tank values → Temperature → Vapor temp. (14985)

Description Shows the measured vapor temperature.

Additional information	Read access	Operator
	Write access	-

Air temperature

Navigation   Expert → Tank values → Temperature → Air temp. (14986)

Description Shows the air temperature.

Additional information

Read access	Operator
Write access	-

"NMT element values" submenu

Navigation  Expert → Tank values → Temperature → NMT elem. values

"Element temperature" submenu

Navigation  Expert → Tank values → Temperature → NMT elem. values
→ Element temp. → Element temp 0 to 23 (14984)

Element temperature 1 to 24

Navigation  Expert → Tank values → Temperature → NMT elem. values → Element temp.
→ Element temp 1 to 24 (14984-1 to 24)

Description Shows the temperature of an element in the NMT.

Additional information

Read access	Operator
Write access	-

"Element position" submenu

Navigation  Expert → Tank values → Temperature → NMT elem. values
→ Element position

Element position 1 to 24

Navigation  Expert → Tank values → Temperature → NMT elem. values → Element position
→ Element pos. 1 to 24 (15014-1 to 24)













Description Shows the position of the selected element in the NMT.

Additional information

Read access	Operator
Write access	-

3.6.3 "Density" submenu

Navigation  Expert → Tank values → Density

► Density		
Observed density		→  276
Observed density temperature		→  277
Vapor density		→  277
Air density		→  277
Measured upper density		→  277
Upper density timestamp		→  278
Measured middle density		→  278
Middle Density Timestamp		→  278
Measured lower density		→  278
Lower density timestamp		→  279
► Profile density		→  279
Profile density 0 to 49		→  279
Profile density position 0 to 49		→  279

Observed density

Navigation  Expert → Tank values → Density → Observed density (13451)



Description Calculated density of the product.

Additional information

Read access	Operator
Write access	-



 This value is calculated from different measured variables depending on the selected calculation method.

Observed density temperature

Navigation	  Expert → Tank values → Density → Obs. dens. temp. (13453)
Description	Corresponding temperature of measured density. Can be used for reference density calculation.
User interface	Signed floating-point number
Factory setting	0 °C



Vapor density





Navigation	  Expert → Tank values → Density → Vapor density (14981)				
Description	Defines the density of the gas phase in the tank.				
User entry	0.0 to 500.0 kg/m ³				
Factory setting	1.2 kg/m ³				
Additional information	<table border="1" style="width: 100%; border-collapse: collapse;"> <tr> <td style="width: 50%; padding: 2px;">Read access</td> <td style="width: 50%; padding: 2px;">Operator</td> </tr> <tr> <td style="padding: 2px;">Write access</td> <td style="padding: 2px;">Maintenance</td> </tr> </table>	Read access	Operator	Write access	Maintenance
Read access	Operator				
Write access	Maintenance				

Air density



Navigation	  Expert → Tank values → Density → Air density (14980)				
Description	Defines the density of the air surrounding the tank.				
User entry	0.0 to 500.0 kg/m ³				
Factory setting	1.2 kg/m ³				
Additional information	<table border="1" style="width: 100%; border-collapse: collapse;"> <tr> <td style="width: 50%; padding: 2px;">Read access</td> <td style="width: 50%; padding: 2px;">Operator</td> </tr> <tr> <td style="padding: 2px;">Write access</td> <td style="padding: 2px;">Maintenance</td> </tr> </table>	Read access	Operator	Write access	Maintenance
Read access	Operator				
Write access	Maintenance				

Measured upper density

Navigation	  Expert → Tank values → Density → Meas upper dens. (15001)
Description	Shows the density of the upper phase.

Additional information

Read access	Operator
Write access	-

Upper density timestamp**Navigation**
 Expert → Tank values → Density → UpDens timestamp (8067)
Description

Shows timestamp of the last measured upper density.

Additional information

Read access	Operator
Write access	-

Measured middle density**Navigation**
 Expert → Tank values → Density → Meas middle dens (14997)
Description

Density of the middle phase.

Additional information

Read access	Operator
Write access	-

Middle Density Timestamp**Navigation**
 Expert → Tank values → Density → MidDensTimestamp (8011)
Description

Shows the timestamp of the last measured middle density.

Additional information

Read access	Operator
Write access	-

Measured lower density**Navigation**
 Expert → Tank values → Density → Meas lower dens. (15002)
Description

Density of the lower phase.

Additional information

Read access	Maintenance
Write access	-

Lower density timestamp

Navigation   Expert → Tank values → Density → LowerDensTimestp (8122)

Description Shows timestamp of last measured lower density.

Additional information

Read access	Operator
Write access	-

"Profile density" submenu

Navigation  Expert → Tank values → Density → Profile density

Profile density 0 to 49

Navigation  Expert → Tank values → Density → Profile density → Profile dens 0 to 49 (8068)

Description Shows the density measurement at the corresponding profile density position.

Additional information

Read access	Operator
Write access	-

Profile density position 0 to 49

Navigation  Expert → Tank values → Density → Profile density → Profile pos 0 to 49 (8077)



Description Shows the position where the corresponding density was measured.

Additional information

Read access	Operator
Write access	-

3.6.4 "Pressure" submenu

Navigation  Expert → Tank values → Pressure

▶ Pressure	
P1 (bottom)	→  280
P3 (top)	→  280

P1 (bottom)

Navigation  Expert → Tank values → Pressure → P1 (bottom) (14983)

Description Shows the pressure at the tank bottom.

Additional information

Read access	Operator
Write access	-

P3 (top)

Navigation  Expert → Tank values → Pressure → P3 (top) (14988)

Description Shows the pressure (P3) at the top transmitter.





Additional information

Read access	Operator
Write access	-

3.6.5 "GP values" submenu

Navigation  Expert → Tank values → GP values

▶ GP values

GP 1 to 4 name	→  281
GP Value 1	→  281
GP Value 2	→  281
GP Value 3	→  282
GP Value 4	→  282

GP 1 to 4 name

Navigation  Expert → Tank values → GP values → GP 1 name (14963)

Description Defines the label associated with the respective GP value.

User entry Character string comprising numbers, letters and special characters (15)

Factory setting GP Value 1

Additional information

Read access	Operator
Write access	Maintenance

GP Value 1

Navigation  Expert → Tank values → GP values → GP Value 1 (14966)

Description Displays the value that will be used as general purpose value.

Additional information

Read access	Operator
Write access	-

GP Value 2

Navigation  Expert → Tank values → GP values → GP Value 2 (14967)

Description Displays the value that will be used as general purpose value.

Additional information

Read access	Operator
Write access	-

GP Value 3

Navigation Expert → Tank values → GP values → GP Value 3 (14968)**Description**

Displays the value that will be used as general purpose value.

Additional information

Read access	Operator
Write access	-

GP Value 4

Navigation Expert → Tank values → GP values → GP Value 4 (14969)**Description**























Displays the value that will be used as general purpose value.

Additional information

Read access	Operator
Write access	-

3.7 "Diagnostics" submenu

Navigation  Expert → Diagnostics

► Diagnostics		
Actual diagnostics		→  285
Timestamp		→  286
Previous diagnostics		→  286
Timestamp		→  287
Operating time from restart		→  287
Operating time		→  287
Date/time		→  287
► Diagnostic list		→  288
Diagnostics 1 to 5		→  288
Timestamp 1 to 5		→  288
► Event logbook		→  289
► Simulation		→  290
Device alarm simulation		→  290
Diagnostic event simulation		→  290
Simulation distance on		→  291
Simulation distance		→  291
Current output 1 to 2 simulation		→  291
Simulation value		→  292
► Device information		→  293
Device tag		→  293
Serial number		→  294
Firmware version		→  294

Firmware CRC	→ 294
Weight and measures configuration CRC	→ 294
Device name	→ 295
Order code	→ 295
Extended order code 1 to 3	→ 295
ENP version	→ 295
Device type	→ 296
Module type	→ 296
Communication Slot	→ 296
▶ Board info	→ 298
Date/time	→ 287
System temperature	→ 298
W&M lock switch	→ 298
▶ Data logging	→ 300
Assign channel 1 to 4	→ 301
Logging interval	→ 302
Clear logging data	→ 303
▶ Device check	→ 305
▶ Commissioning check	→ 306
Commissioning check	→ 306
Result drum check	→ 306
Step X / 11	→ 306
▶ Commissioning parameter	→ 307
Step X / 11	→ 307

Result drum check	→ 307
Displacer weight tolerance	→ 307
Reference calibration incomplete	→ 308

▶ LRC	
▶ LRC 1 to 2	→ 309
LRC Mode	→ 309
Allowed difference	→ 309
Check fail threshold	→ 310
Reference level source	→ 310
Reference switch source	→ 311
Reference switch mode	→ 311
Reference level	→ 311
Reference switch level	→ 312
Reference point level	
Reference switch state	→ 312
Start reference measurement	
Check level	→ 312
Check status	→ 313
Check timestamp	→ 313

Actual diagnostics

Navigation

Expert → Diagnostics → Actual diagnos. (0691)

Description

Displays the currently active diagnostic message.

If there is more than one pending diagnostic event, the message for the diagnostic event with the highest priority is displayed.



Additional information

Read access	Operator
Write access	-

The display consists of:

- Symbol for event behavior
- Code for diagnostic behavior
- Operating time of occurrence
- Event text

 If several messages are active at the same time, the messages with the highest priority is displayed.

 Information on what is causing the message, and remedy measures, can be viewed via the  symbol on the display.

Timestamp**Navigation**

 Expert → Diagnostics → Timestamp (0667)



Description

Displays the timestamp for the currently active diagnostic message.

Additional information

Read access	Operator
Write access	-

Previous diagnostics**Navigation**

  Expert → Diagnostics → Prev.diagnostics (0690)

Description

Displays the diagnostic message for the last diagnostic event that has ended.



Additional information

Read access	Operator
Write access	-

The display consists of:

- Symbol for event behavior
- Code for diagnostic behavior
- Operating time of occurrence
- Event text

 If several messages are active at the same time, the messages with the highest priority is displayed.

 Information on what is causing the message, and remedy measures, can be viewed via the  symbol on the display.

Timestamp

Navigation  Expert → Diagnostics → Timestamp (0672)

Description Displays the timestamp of the diagnostic message generated for the last diagnostic event that has ended.

Additional information

Read access	Operator
Write access	-

Operating time from restart

Navigation   Expert → Diagnostics → Time fr. restart (0653)

Description Indicates how long the device has been in operation since the last time the device was restarted.

Additional information

Read access	Operator
Write access	-

Operating time

Navigation   Expert → Diagnostics → Operating time (0652)

Description Indicates how long the device has been in operation.

Additional information

Read access	Operator
Write access	-

Date/time

Navigation   Expert → Diagnostics → Date/time (0790)



Description Displays the device internal real time clock.

Additional information

Read access	Operator
Write access	-

3.7.1 "Diagnostic list" submenu

Navigation  Expert → Diagnostics → Diagnostic list

▶ Diagnostic list	
Diagnostics 1 to 5	→  288
Timestamp 1 to 5	→  288

Diagnostics 1 to 5

Navigation  Expert → Diagnostics → Diagnostic list → Diagnostics 1 to 5 (0692-1 to 5)

Description Displays the currently active diagnostic message with the highest priority.

Additional information The display consists of:

- Symbol for event behavior
- Code for diagnostic behavior
- Operating time of occurrence
- Event text

Timestamp 1 to 5

Navigation  Expert → Diagnostics → Diagnostic list → Timestamp 1 to 5 (0683-1 to 5)

Description Timestamp of the diagnostic message.

Additional information

Read access	Operator
Write access	-



3.7.2 "Event logbook" submenu

Structure of the submenu on the local display

Navigation  Expert → Diagnostics → Event logbook









Description of parameters

Navigation   Expert → Diagnostics → Event logbook

3.7.3 "Simulation" submenu

Navigation   Expert → Diagnostics → Simulation

▶ Simulation	
Device alarm simulation	→  290
Diagnostic event simulation	→  290
Simulation distance on	→  291
Simulation distance	→  291
Current output 1 to 2 simulation	→  291
Simulation value	→  292

Device alarm simulation

Navigation   Expert → Diagnostics → Simulation → Dev. alarm sim. (0654)

Description Switch the device alarm on and off.

Selection

- Off
- On

Factory setting Off

Additional information

Read access	Operator
Write access	Maintenance

Diagnostic event simulation

Navigation   Expert → Diagnostics → Simulation → Diagnostic event (0737)

Description Select a diagnostic event to simulate this event.

Selection The diagnostic events of the device

Factory setting Off



Additional information

Read access	Operator
Write access	Maintenance

 To terminate the simulation, select **Off**.

Simulation distance on 

Navigation

  Expert → Diagnostics → Simulation → Sim distance on (8002)

Description

Switches the distance simulation on or off.

Selection

- Off
- On

Factory setting

Off

Additional information

Read access	Operator
Write access	Maintenance

Simulation distance 

Navigation

  Expert → Diagnostics → Simulation → Sim distance (8003)

Prerequisite

Simulation distance on (→  291) = On

Description

Defines the distance value to be simulated.

User entry

Signed floating-point number

Factory setting



0 mm

Additional information

Read access	Operator
Write access	Maintenance

Current output N simulation 

Navigation

  Expert → Diagnostics → Simulation → Curr.outp N sim. (13985)

Prerequisite

- The device has an Anlog I/O module.
- **Operating mode (→  150) = 4..20mA output or HART slave +4..20mA output**

Description

Switches the simulation of the current on or off.

Selection ■ Off
 ■ On

Factory setting Off

Additional information

Read access	Operator
Write access	Maintenance

Simulation value



Navigation Expert → Diagnostics → Simulation → Simulation value (13976)

Prerequisite **Current output simulation (→ 291) = On**

Description Defines the current to be simulated.

User entry 3.4 to 23 mA















Factory setting The current at the time the simulation was started.

Additional information

Read access	Operator
Write access	Maintenance



3.7.4 "Device information" submenu

Navigation   Expert → Diagnostics → Device info

► Device information	
Device tag	→  293
Serial number	→  294
Firmware version	→  294
Firmware CRC	→  294
Weight and measures configuration CRC	→  294
Device name	→  295
Order code	→  295
Extended order code 1 to 3	→  295
ENP version	→  295
Device type	→  296
Build version	→  296
Module type	→  296
Communication Slot	→  296
Recovery state	→  297
► Board info	→  298

Device tag

Navigation

  Expert → Diagnostics → Device info → Device tag (0011)

Description

Shows the device tag.

User interface

Character string comprising numbers, letters and special characters

Factory setting

- none -

Additional information

Read access	Operator
Write access	-

Serial number**Navigation**

 Expert → Diagnostics → Device info → Serial number (0009)

Description

The serial number is a unique alphanumeric code identifying the device. It is printed on the nameplate. In combination with the Operations app it allows to access all device related documentation.

Additional information

Read access	Operator
Write access	-

Firmware version**Navigation**

 Expert → Diagnostics → Device info → Firmware version (0010)

Description

Displays the device firmware version installed.

Additional information

Read access	Operator
Write access	-

Firmware CRC**Navigation**

 Expert → Diagnostics → Device info → Firmware CRC (8563)

Description

Result of the cyclic redundancy check of the firmware.

Additional information

Read access	Operator
Write access	-

Weight and measures configuration CRC**Navigation**

 Expert → Diagnostics → Device info → W&M config CRC (8564)

Description

Result of the cyclic redundancy check of the weights and measure relevant parameters.

Additional information

Read access	Operator
Write access	-

Device name

Navigation

  Expert → Diagnostics → Device info → Device name (0013)

Description

Use this function to display the device name. It can also be found on the nameplate.

Additional information

Read access	Operator
Write access	-

Order code



Navigation

  Expert → Diagnostics → Device info → Order code (0008)

Description

Shows the device order code.

Additional information

Read access	Operator
Write access	Service

Extended order code 1 to 3



Navigation

  Expert → Diagnostics → Device info → Ext. order cd. 1 (0023)

Description

Display the three parts of the extended order code.

User interface

Character string comprising numbers, letters and special characters

Additional information

Read access	Operator
Write access	Service

The extended order code indicates the selected option of all ordering features and thus uniquely identifies the device.

ENP version

Navigation

  Expert → Diagnostics → Device info → ENP version (0012)

Description

Shows the version of the electronic nameplate (ENP).

Additional information

Read access	Operator
Write access	-

Device type**Navigation**

  Expert → Diagnostics → Device info → Device type (8561)

Description

Displays the device type.

Additional information

Read access	Operator
Write access	-

Build version**Navigation**

  Expert → Diagnostics → Device info → Build version (0007)

Description

Shows the device firmware build version installed.

Additional information

Read access	Operator
Write access	-

Module type**Navigation**

  Expert → Diagnostics → Device info → Module type (8526)

Description

Shows the type of installed IO module.

Additional information

Read access	Operator
Write access	-

Communication Slot**Navigation**

  Expert → Diagnostics → Device info → Comm. Slot (13285)

Description

Indicates which IOM slot contains the communication protocol interface board.

Additional information



Read access	Operator
Write access	-

Recovery state

Navigation	 Expert → Diagnostics → Device info → Recovery state (8565)
Description	Indicate the state of the backup data process.
User interface	<ul style="list-style-type: none">■ Inactive■ distributing■ restoring■ Distribution done■ Distribution failed■ Operating normally■ Restore done■ Restore failed
Factory setting	Inactive

"Board info" submenu

Navigation  Expert → Diagnostics → Device info → Board info

▶ Board info	
Date/time	→  298
System temperature	→  298
W&M lock switch	→  298

Date/time**Navigation**

 Expert → Diagnostics → Device info → Board info → Date/time (0790)

Description

Displays the device internal real time clock.

Additional information

Read access	Operator
Write access	-

System temperature**Navigation**

 Expert → Diagnostics → Device info → Board info → System temp. (8553)

Description

Shows the electronic temperature of the main board.

User interface

Signed floating-point number

Factory setting

0 °C

Additional information

Read access	Operator
Write access	-

W&M lock switch**Navigation**

 Expert → Diagnostics → Device info → Board info → W&M lock switch (8558)

Description

Shows the position of the weights and measure (WP) switch.

User interface

- Enabled
- Disabled

Factory setting Enabled

Additional information

Read access	Operator
Write access	-

3.7.5 "Data logging" submenu

Structure of the submenu on the local display

Navigation   Expert → Diagnostics → Data logging

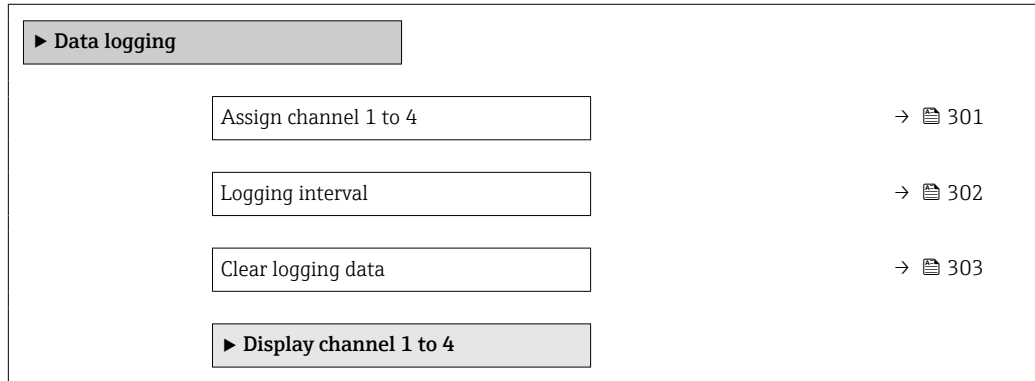

Structure of the submenu in an operating tool

Navigation   Expert → Diagnostics → Data logging

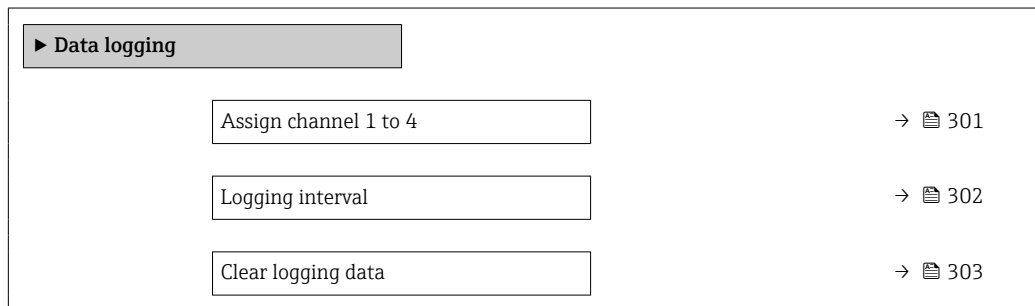

Description of parameters

Navigation  Expert → Diagnostics → Data logging

Assign channel 1 to 4



Navigation  Expert → Diagnostics → Data logging → Assign chan. 1 (0851)

Description Assign a process variable to logging channel.

- Selection**
- Off
 - Tank level
 - Measured level
 - Tank level %
 - Distance
 - Water level
 - Upper interface level
 - Lower interface level
 - Displacer position *
 - Upper density
 - Middle density
 - Lower density
 - Bottom level
 - Average profile density *
 - Liquid temperature
 - Vapor temperature
 - Air temperature
 - Tank ullage
 - Tank ullage %
 - Observed density value
 - P1 (bottom)
 - P2 (middle)
 - P3 (top)
 - GP 1 value
 - GP 2 value
 - GP 3 value
 - GP 4 value
 - AIO B1-3 value *
 - AIO B1-3 value mA *
 - AIO B1-3 value % *
 - AIO C1-3 value *
 - AIO C1-3 value mA *
 - AIO C1-3 value % *
 - AIP B4-8 value *
 - AIP C4-8 value *
 - Absolute echo amplitude *
 - Amplitude eval distance *
 - DiffPhase *

Factory setting Off

* Visibility depends on order options or device settings

Additional information

A total of 1000 measured values can be logged. This means:

- 1000 data points if 1 logging channel is used
- 500 data points if 2 logging channels are used
- 333 data points if 3 logging channels are used
- 250 data points if 4 logging channels are used

If the maximum number of data points is reached, the oldest data points in the data log are cyclically overwritten in such a way that the last 1000, 500, 333 or 250 measured values are always in the log (ring memory principle).



 The logged data are deleted if a new option is selected in this parameter.

Read access	Operator
Write access	Maintenance

Logging interval



Navigation

-  Expert → Diagnostics → Data logging → Logging interval (0856)
-  Expert → Diagnostics → Data logging → Logging interval (0856)

Description

Define the logging interval t_{log} for data logging. This value defines the time interval between the individual data points in the memory.

User entry

1.0 to 3 600.0 s

Factory setting

10.0 s

Additional information

This parameter defines the interval between the individual data points in the data log, and thus the maximum loggable process time T_{log} :

- If 1 logging channel is used: $T_{log} = 1000 \cdot t_{log}$
- If 2 logging channels are used: $T_{log} = 500 \cdot t_{log}$
- If 3 logging channels are used: $T_{log} = 333 \cdot t_{log}$
- If 4 logging channels are used: $T_{log} = 250 \cdot t_{log}$

Once this time elapses, the oldest data points in the data log are cyclically overwritten such that a time of T_{log} always remains in the memory (ring memory principle).

 The logged data are deleted if this parameter is changed.

Example

When using 1 logging channel

- $T_{log} = 1000 \cdot 1 \text{ s} = 1000 \text{ s} \approx 16.5 \text{ min}$
- $T_{log} = 1000 \cdot 10 \text{ s} = 1000 \text{ s} \approx 2.75 \text{ h}$
- $T_{log} = 1000 \cdot 80 \text{ s} = 80\,000 \text{ s} \approx 22 \text{ h}$
- $T_{log} = 1000 \cdot 3\,600 \text{ s} = 3\,600\,000 \text{ s} \approx 41 \text{ d}$

Read access	Operator
Write access	Maintenance

Clear logging data



Navigation

- Expert → Diagnostics → Data logging → Clear logging (0855)
- Expert → Diagnostics → Data logging → Clear logging (0855)

Description

Clear the entire logging data.

Selection

- Cancel
- Clear data

Factory setting

Cancel

Additional information

Read access	Operator
Write access	Maintenance

"Display channel 1 to 4" submenu

i The **Display channel 1 to 4** submenu is only available when operating via the local display. When operating via FieldCare, the diagram can be displayed in the "Event List / HistoROM" function.

The **Display channel 1 to 4** submenu displays the measured value trend of the respective logging channel.

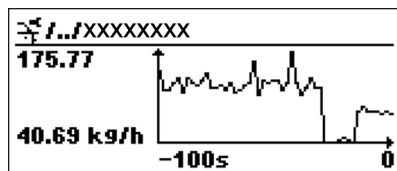

- x-axis: displays 125 to 500 measured values of a process variable (the number of values depending on the number of selected channels).
- y-axis: displays the approximate measured value span and constantly adapts this to the ongoing measurement.

i To quit the diagram and to return to the operating menu, press \oplus and \ominus simultaneously.

Navigation \oplus Expert → Diagnostics → Data logging → Displ.channel 1 to 4

3.7.6 "Device check" submenu



Navigation   Expert → Diagnostics → Device check



"Commissioning check" wizard

Navigation  Expert → Diagnostics → Device check → Commission check

▶ Commissioning check

Commissioning check	→  306
Result drum check	→  306
Step X / 11	→  306

Commissioning check

Navigation

 Expert → Diagnostics → Device check → Commission check → Commission check

Description

This sequence supports checking of the hardware on sensor side and correct installation of the sensor.

Additional information

Read access	Operator
Write access	Maintenance

Result drum check

Navigation

 Expert → Diagnostics → Device check → Commission check → Result drum chk (8155)

Description

Gives feedback on the latest status of the commissioning check.

Additional information

Read access	Operator
Write access	-

Step X / 11

Navigation

 Expert → Diagnostics → Device check → Commission check → Step X / 11 (8143)



Description

Indicates which step of the commissioning check is currently running.





Additional information

Read access	Operator
Write access	-



"Commissioning parameter" submenu

Navigation   Expert → Diagnostics → Device check → Commission para.

► Commissioning parameter

Step X / 11	→  307
Result drum check	→  307
Displacer weight tolerance	→  307
Reference calibration incomplete	→  308

Step X / 11



Navigation   Expert → Diagnostics → Device check → Commission para. → Step X / 11 (8143)

Description Indicates which step of the commissioning check is currently running.

Additional information

Read access	Operator
Write access	-

Result drum check



Navigation   Expert → Diagnostics → Device check → Commission para. → Result drum chk (8155)

Description Gives feedback on the latest status of the commissioning check.

Additional information

Read access	Operator
Write access	-

Displacer weight tolerance 

Navigation   Expert → Diagnostics → Device check → Commission para. → DispWeightToler (8161)

Description Sets the tolerance of the displacer weight verification during commissioning check.

User interface 0 to 99.9 g

Factory setting 5 g

Additional information

Read access	Operator
Write access	Service

Reference calibration incomplete**Navigation**

 Expert → Diagnostics → Device check → Commission para. → Ref cal. incomp (8157)

User interface

0 to 1

Factory setting

0



Additional information



Read access	Operator
Write access	-

3.7.7 "LRC 1 to 2" submenu

 Additional information about the configuration of the level reference check (LRC) function: Operating instructions

Navigation   Diagnostics → LRC → LRC 1 to 2

LRC Mode					
<hr/>					
Navigation	  Diagnostics → LRC → LRC 1 to 2 → LRC Mode (17901-1 to 2)				
Description	Activates or deactivates one of the level reference check (LRC) modes.				
Selection	<ul style="list-style-type: none"> ■ Off ■ Compare with level device ■ Compare with level switch ■ Measure reference point[*] 				
Factory setting	Off				
Additional information	<table border="1" style="width: 100%; border-collapse: collapse;"> <tr> <td style="width: 50%; padding: 2px;">Read access</td> <td style="padding: 2px;">Operator</td> </tr> <tr> <td style="padding: 2px;">Write access</td> <td style="padding: 2px;">Maintenance</td> </tr> </table>	Read access	Operator	Write access	Maintenance
Read access	Operator				
Write access	Maintenance				
Additional information	The option of the Measure reference point is not available for NMS8x.				

Allowed difference					
<hr/>					
Navigation	  Diagnostics → LRC → LRC 1 to 2 → Allowed diff. (17902-1 to 2)				
Description	Defines the allowed difference between the tank level and the reference.				
User entry	1 to 1 000 mm				
Factory setting	10 mm				
Additional information	<table border="1" style="width: 100%; border-collapse: collapse;"> <tr> <td style="width: 50%; padding: 2px;">Read access</td> <td style="padding: 2px;">Operator</td> </tr> <tr> <td style="padding: 2px;">Write access</td> <td style="padding: 2px;">Maintenance</td> </tr> </table>	Read access	Operator	Write access	Maintenance
Read access	Operator				
Write access	Maintenance				

^{*} Visibility depends on order options or device settings

Check fail threshold
**Navigation**

Diagnostics → LRC → LRC 1 to 2 → Fail threshold (17913-1 to 2)

Description

Defines how many minutes the comparison has to fail before the check is failed. Note: Only for mode "Compare with level device".

User entry

1 to 60

Factory setting

3

Additional information

Read access	Operator
Write access	Maintenance

Reference level source
**Navigation**

Diagnostics → LRC → LRC 1 to 2 → Reference source (17903-1 to 2)

Description

Defines the source for the reference level. Note: Only for mode "Compare with level device".

Selection

- No input value
- HART device 1 level *
- HART device 2 level *
- HART device 3 level *
- HART device 4 level *
- HART device 5 level *
- HART device 6 level *
- HART device 7 level *
- HART device 8 level *
- HART device 9 level *
- HART device 10 level *
- HART device 11 level *
- HART device 12 level *
- HART device 13 level *
- HART device 14 level *
- HART device 15 level *

Factory setting

No input value

Additional information

Read access	Operator
Write access	Maintenance

* Visibility depends on order options or device settings

Reference switch source



Navigation	Diagnostics → LRC → LRC 1 to 2 → Reference source (17904-1 to 2)				
Description	Defines the source for the reference switch. Note: Only for mode "Compare with level switch".				
Selection	<ul style="list-style-type: none"> ■ None ■ Digital A1-2 ■ Digital A3-4 ■ Digital B1-2 ■ Digital B3-4 ■ Digital C1-2 ■ Digital C3-4 ■ Digital D1-2 ■ Digital D3-4 				
Factory setting	None				
Additional information	<table border="1" style="width: 100%; border-collapse: collapse;"> <tr> <td style="width: 50%;">Read access</td> <td>Operator</td> </tr> <tr> <td>Write access</td> <td>Maintenance</td> </tr> </table>	Read access	Operator	Write access	Maintenance
Read access	Operator				
Write access	Maintenance				

Reference switch mode



Navigation	Diagnostics → LRC → LRC 1 to 2 → Ref. switch mode (17914-1 to 2)				
Description	Defines the switch direction for which the reference check is executed. Note: Only for mode "Compare with level switch".				
Selection	<ul style="list-style-type: none"> ■ Active -> Inactive ■ Inactive -> Active 				
Factory setting	Active -> Inactive				
Additional information	<table border="1" style="width: 100%; border-collapse: collapse;"> <tr> <td style="width: 50%;">Read access</td> <td>Operator</td> </tr> <tr> <td>Write access</td> <td>Maintenance</td> </tr> </table>	Read access	Operator	Write access	Maintenance
Read access	Operator				
Write access	Maintenance				

Reference level

Navigation	Diagnostics → LRC → LRC 1 to 2 → Reference level (17909-1 to 2)
Description	Shows the current reference level. Note: Only for mode "Compare with level device".
User interface	Signed floating-point number
Factory setting	0 mm

Additional information

Read access	Operator
Write access	-

Reference switch level**Navigation**

Diagnostics → LRC → LRC 1 to 2 → Reference level (17905-1 to 2)

Description

Defines the position of the reference switch as level. Note: Only for mode "Compare with level switch".

User entry

0 to 10 000.00 mm

Factory setting

0 mm

Additional information

Read access	Operator
Write access	Maintenance

Reference switch state**Navigation**

Diagnostics → LRC → LRC 1 to 2 → Ref.switch state (17908-1 to 2)

Description

Shows the current state of the reference switch (e.g. "active"). Note: Only for mode "Compare with level switch".

User interface

- Unknown
- Inactive
- Active
- Error

Factory setting

Unknown

Additional information

Read access	Operator
Write access	-

Check level**Navigation**

Diagnostics → LRC → LRC 1 to 2 → Check level (17910-1 to 2)

Description

Shows the tank level at which the reference check has been executed.

User interface

Signed floating-point number

Factory setting



0 mm

Additional information

Read access	Operator
Write access	Development

Check status

Navigation

  Diagnostics → LRC → LRC 1 to 2 → Check status (17911-1 to 2)

Description

Shows the status of the reference check execution (e.g. "passed").

User interface

- not executed
- Passed
- Failed
- Not possible

Factory setting



not executed

Additional information

Read access	Operator
Write access	Development

Check timestamp

Navigation

  Diagnostics → LRC → LRC 1 to 2 → Check timestamp (17912-1 to 2)

Description

Shows the timestamp at which the reference check has been executed.

User interface

Character string comprising numbers, letters and special characters

Factory setting

not executed

Additional information

Read access	Operator
Write access	-

Index

Symbols

- #blank# (Parameter) 113
- #blank# (Submenu) 138

0 ... 9

- 0 % value (Parameter) 144, 155, 204
- 100 % value (Parameter) 144, 155, 205

A

- Access code (Parameter) 128
- Access status display (Parameter) 33
- Activate SW option (Parameter) 56
- Active calibration (Parameter) 147, 160
- Active diagnostics (Parameter) 125
- Active gauge command (Parameter) 62
- Actual diagnostics (Parameter) 285
- Administration (Submenu) 55, 56
- Air density (Parameter) 226, 277
- Air temperature (Parameter) 223, 274
- Air temperature source (Parameter) 222
- Alarm (Submenu) 256
- Alarm 1 input source (Parameter) 194
- Alarm 2 input source (Parameter) 194
- Alarm 3 input source (Parameter) 195
- Alarm 4 input source (Parameter) 195
- Alarm hysteresis (Parameter) 264
- Alarm mode (Parameter) 257
- Alarm value (Parameter) 260
- Alarm value source (Parameter) 259
- Allowed difference (Parameter) 309
- Ambient pressure (Parameter) 236
- Analog I/O (Submenu) 149
- Analog input 0% value (Parameter) 157
- Analog input 100% value (Parameter) 158
- Analog input source (Parameter) 152
- Analog IP (Submenu) 140
- Any error (Parameter) 263
- Application (Submenu) 215
- Assign channel 1 (Parameter) 301
- Assign PV (Parameter) 203
- Assign QV (Parameter) 208
- Assign SV (Parameter) 206
- Assign TV (Parameter) 207

B

- Backlight (Parameter) 41
- Balance flag (Parameter) 62, 266
- Balance settings (Submenu) 86
- Balancing waiting time (Parameter) 87
- Baudrate (Parameter) 175, 198
- Board info (Submenu) 298
- Bottom level (Parameter) 67, 271
- Bottom level timestamp (Parameter) 67, 271
- Bottom point (Parameter) 129, 135
- Build version (Parameter) 296
- Bus termination (Parameter) 178

C

- Calibration (Parameter) 160
- Calibration (Submenu) 94
- Calibration parameters (Submenu) 105
- Calibration status (Parameter) 98, 101, 104, 107
- Calibration temperature (Parameter) 249
- Calibration time (Parameter) 103
- Calibration type AIP (Parameter) 147
- Check fail threshold (Parameter) 310
- Check level (Parameter) 312
- Check status (Parameter) 313
- Check timestamp (Parameter) 313
- Clear alarm (Parameter) 263
- Clear logging data (Parameter) 303
- Commissioning check (Parameter) 306
- Commissioning check (Wizard) 306
- Commissioning parameter (Submenu) 307
- Communication (Submenu) 172
- Communication interface protocol (Parameter) 174
- Communication interface protocol variant (Parameter) 190
- Communication Slot (Parameter) 296
- Communication status (Parameter) 112
- Compatibility mode (Parameter) 179, 192, 199
- Configuration (Submenu) 175, 190, 198
- Configure device? (Parameter) 127, 134
- Confirm access code (Parameter) 58
- Contact type (Parameter) 164
- Contrast display (Parameter) 41
- Covered tank (Parameter) 248
- CRC seed (Parameter) 178
- CTSh (Submenu) 247
- CTSh correction value (Parameter) 247
- CTSh mode (Parameter) 248
- Current (Parameter) 139
- Current output N simulation (Parameter) 291
- Current span (Parameter) 151
- Custody transfer (Parameter) 122

D

- Damping factor (Parameter) 147, 159, 167, 264
- Data logging (Submenu) 300, 301
- Date / time (Submenu) 49, 50
- Date/time (Parameter) 50, 53, 287, 298
- Day (Parameter) 51, 53
- Decimal places 1 (Parameter) 38
- Decimal places density (Parameter) 45
- Decimal places length (Parameter) 44
- Decimal places pressure (Parameter) 44
- Decimal places temperature (Parameter) 45
- Define access code (Parameter) 56, 57
- Define access code (Wizard) 57
- Deformation factor (Parameter) 243
- Density (Parameter) 118
- Density (Submenu) 225, 276
- Density 0% (Parameter) 182

Density 100% (Parameter)	183	Ambient pressure (14962)	236
Density measurement mode (Parameter)	92	Analog input 0% value (13977)	157
Density table (Submenu)	71	Analog input 100% value (13965)	158
Density unit (Parameter)	44	Analog input source (13974)	152
Density value (Parameter)	253	Any error (13867)	263
Detector temperature (Parameter)	63	Assign channel 1 (0851)	301
Device alarm simulation (Parameter)	290	Assign PV (0234)	203
Device check (Submenu)	305	Assign QV (0237)	208
Device date (Parameter)	121	Assign SV (0235)	206
Device description (Parameter)	121	Assign TV (0236)	207
Device ID (Parameter)	120, 211	Backlight (0111)	41
Device information (Submenu)	293	Balance flag (8006)	62, 266
Device message (Parameter)	121	Balancing waiting time (8205)	87
Device name (Parameter)	111, 295	Baudrate (13203)	175, 198
Device reset (Parameter)	57	Bottom level (8129)	67
Device revision (Parameter)	211	Bottom level (15018)	271
Device tag (Parameter)	111, 211, 293	Bottom level timestamp (8048)	67, 271
Device type (Parameter)	120, 212, 296	Bottom point (14729)	129, 135
Diagnostic code (Parameter)	124	Build version (0007)	296
Diagnostic event simulation (Parameter)	290	Bus termination (13249)	178
Diagnostic list (Submenu)	288	Calibration (13966)	160
Diagnostics (Submenu)	124, 125, 283	Calibration status (8031)	98, 101, 104, 107
Diagnostics 1 to 5 (Parameter)	288	Calibration temperature (13652)	249
Digital input mapping (Submenu)	168	Calibration type AIP (14018)	147
Digital input source (Parameter)	163	Check fail threshold	
Digital input source 1 (Parameter)	168	LRC 1 to 2 (17913-1 to 2)	310
Digital input source 2 (Parameter)	168	Check level	
Digital Xx-x (Submenu)	162	LRC 1 to 2 (17910-1 to 2)	312
Direct access		Check status	
#blank# (14705)	113	LRC 1 to 2 (17911-1 to 2)	313
#blank# (14706)	113	Check timestamp	
#blank# (14716)	113	LRC 1 to 2 (17912-1 to 2)	313
0 % value (11632)	204	Clear alarm (13861)	263
0 % value (13954)	155	Clear logging data (0855)	303
0 % value (14001)	144	Communication interface protocol (13201)	174
100 % value (11633)	205	Communication interface protocol variant	
100 % value (13968)	155	(13269)	190
100 % value (14013)	144	Communication Slot (13285)	296
Access code (14714)	128	Communication status (14710)	112
Access status display (0091)	33	Compatibility mode (13281)	179, 192, 199
Activate SW option (0029)	56	Configure device? (14728)	127, 134
Active calibration (13981)	160	Contact type	
Active calibration (14012)	147	Digital Xx-x (13912)	164
Active diagnostics (14754)	125	Contrast display (0105)	41
Active gauge command (8073)	62	Covered tank (13654)	248
Actual diagnostics (0691)	285	CRC seed (13248)	178
Air density (14980)	226, 277	CTSh correction value (13651)	247
Air temperature (14986)	223, 274	CTSh mode (14651)	248
Air temperature source (14993)	222	Current (14457)	139
Alarm 1 input source (13270)	194	Current output N simulation (13985)	291
Alarm 2 input source (13271)	194	Current span (13987)	151
Alarm 3 input source (13283)	195	Custody transfer (14748)	122
Alarm 4 input source (13284)	195	Damping factor	
Alarm hysteresis (13862)	264	Digital Xx-x (13904)	167
Alarm mode (13864)	257	Damping factor (13860)	264
Alarm value (13863)	260	Damping factor (13951)	159
Alarm value source (13866)	259	Damping factor (14004)	147
Allowed difference		Date/time (0790)	50, 53, 287, 298
LRC 1 to 2 (17902-1 to 2)	309	Day (0788)	51, 53

Decimal places 1 (0095)	38
Decimal places density (0609)	45
Decimal places length (0573)	44
Decimal places pressure (0608)	44
Decimal places temperature (0614)	45
Define access code (0093)	56
Deformation factor (13602)	243
Density (14724)	118
Density 0% (13252)	182
Density 100% (13218)	183
Density measurement mode (8186)	92
Density unit (0555)	44
Density value (13753)	253
Detector temperature (8090)	63
Device alarm simulation (0654)	290
Device date (14707)	121
Device description (14704)	121
Device ID (0221)	211
Device ID (14702)	120
Device message (14703)	121
Device name (0013)	295
Device name (14722)	111
Device reset (0000)	57
Device revision (0204)	211
Device tag (0011)	293
Device tag (0215)	211
Device tag (14713)	111
Device type (0209)	212
Device type (8561)	296
Device type (14701)	120
Diagnostic code (14739)	124
Diagnostic event simulation (0737)	290
Diagnostics 1 to 5 (0692-1 to 5)	288
Digital input source	
Digital Xx-x (13907)	163
Digital input source 1 (8147)	168
Digital input source 2 (8148)	168
Discrete 1 to 4 selector (13260-1 to 4)	189, 200
Displacer balance volume (8009)	76
Displacer diameter (8014)	75
Displacer height (8195)	77
Displacer position (8130)	65
Displacer position (15019)	272
Displacer status (8160)	62
Displacer type (8071)	75
Displacer volume (8008)	76
Displacer weight (8010)	76
Displacer weight tolerance (8161)	307
Display damping (0094)	41
Display interval (0096)	40
Distance (8103)	60, 65, 95, 272
Distance unit (0551)	43
Drum circumference (8082)	78
Element interval (14743)	131
Element position (14738)	133, 137
Element position 1 to 24 (15014-1 to 24) .	123, 274
Element temperature (14737)	133, 137
Element temperature 1 to 24 (14984-1 to 24)	
.	123, 274
Empty (14602)	218
ENP version (0012)	295
Enter access code (0003)	33
Error event type (13953)	158
Error on event	
Digital Xx-x (13916)	166
Error on event (13967)	154
Error value (13851)	258
Error value (13972)	154
Expected SIL/WHG chain (13952)	161
Extended order code 1 (0023)	295
Failure mode (13988)	153
Feedback threshold (13956)	157
Firmware CRC (8563)	294
Firmware CRC (14758)	122
Firmware version (0010)	294
Fixed current (13989)	152
Float swap mode (13232)	176
Format display (0098)	36
Gain adjust (14736)	130
Gauge command (8000)	59
Gauge command 0 (8149)	169
Gauge command 1 (8150)	170
Gauge command 2 (8151)	170
Gauge command 3 (8152)	171
Gauge current (14027)	148
Gauge status (8081)	60, 62, 73, 265
GP 1 name (14963)	238, 281
GP 1 to 4 source (14989-1 to 4)	237
GP 1 value 0% (13223)	186
GP 1 value 100% (13224)	186
GP 2 value 0% (13257)	187
GP 2 value 100% (13258)	187
GP 3 value 0% (13259)	187
GP 3 value 100% (13226)	188
GP 4 value 0% (13225)	188
GP 4 value 100% (13227)	188
GP Value 1 (14966)	238, 281
GP Value 2 (14967)	238, 281
GP Value 3 (14968)	238, 282
GP Value 4 (14969)	239, 282
Gross weight (8080)	61
H alarm (13856)	262
H alarm value (13854)	260
Hardware revision (0206)	213
HART bus (14711)	120
HART date code (0202)	214
HART descriptor (0212)	213
HART device PV % (14709)	114
HART device PV mA (14708)	114
HART message (0216)	213
HART revision (0205)	212
HART short tag (0220)	210
Header (0097)	39
Header text (0112)	40
HH alarm (13857)	261
HH alarm value (13855)	260
HH+H alarm (13858)	262
High stop level (8135)	79

Hour (0789)	51, 53	Measured middle density (8165)	68
HTMS mode (13751)	252	Measured middle density (14997)	227, 278
Hysteresis (13755)	254	Measured upper density (8164)	68
HyTD correction value (13603)	242	Measured upper density (15001)	226, 277
HyTD mode (14652)	242	Middle density (8041)	82
Immersion depth (8070)	77	Middle density offset (8177)	90
Input value		Middle Density Timestamp (8011)	69, 278
Digital Xx-x (13901)	164	Minimum level (13752)	253
Input value (13979)	155	Minimum pressure (13754)	254
Input value (14015)	145	Minimum probe temperature (14010)	145
Input value % (13955)	156	Minute (0791)	52, 54
Input value in mA (13970)	159	Modbus address (13205)	176
Input value percent (13978)	159	Modbus discrete 1 to 4 (13240-1 to 4)	174
Input value percent (14002)	144	Modbus value 1 to 4 (13206-1 to 4)	174
Interface measurement mode (8064)	87	Module type (8526)	296
Invalid data (13243)	177	Month (0787)	51, 53
Kind of interval (14744)	130	Motor status (8118)	63, 96
L alarm (13859)	262	Net weight (8007)	61, 265
L alarm value (13853)	261	No element in phase (14756)	135
Language (0104)	35	No. of preambles (0217)	203
Last diagnostic (14742)	124	Number format (0099)	39
Level 0% (13214)	180	Number of devices (13051)	109
Level 100% (13250)	181	Observed density (13451)	276
Level mapping (13268)	191	Observed density (13452)	226
Level measurement mode (8056)	86	Observed density source (13454)	225
Level source (14601)	217	Observed density temperature (13453)	277
Level source (14749)	119	Offset standby distance (8107)	84, 267
Line impedance (13266)	192	Offset weight (8095)	97, 106
Linear expansion coefficient (13655)	249	Ohms offset (14026)	142
Liquid level (8072)	66	Old TSM mode (13213)	178
Liquid temp source (14972)	221	One-time command status (8201)	63, 268
Liquid temperature (14978)	222, 273	Operating mode	
LL alarm (13868)	262	Digital Xx-x (13911)	163
LL alarm value (13852)	261	Operating mode (13958)	150
LL+L alarm (13869)	263	Operating mode (14014)	141
Local gravity (14979)	239	Operating mode (14453)	139
Locking status (0004)	32	Operating mode (14745)	111
Logging interval (0856)	302	Operating time (0652)	287
Low stop level (8069)	79	Operating time from restart (0653)	287
Lower density (8042)	83	Order code (0008)	295
Lower density offset (8178)	91	Output at error (14733)	130
Lower density timestamp (8122)	69, 279	Output density (14720)	115
Lower interface level (8128)	66	Output level (14718)	116
Lower interface level (15004)	219, 271	Output out of range (8218)	81
Lower interface level timestamp (8061)	67, 271	Output out of range (13971)	154
LRC Mode		Output pressure (14719)	114
LRC 1 to 2 (17901-1 to 2)	309	Output simulation	
Manual air temperature (14961)	223	Digital Xx-x (13909)	165
Manual density (15009)	253	Output temperature (14721)	115
Manual liquid temperature (15015)	222	Output value	
Manual profile level (8182)	92	Digital Xx-x (13902)	166
Manual value (14746)	120	Output value (13969)	156
Manual vapor temperature (14960)	224	Output vapor temperature (14726)	115
Manual water level (14959)	220	Overtension weight (8097)	80
Manufacturer ID (0259)	212	P1 (bottom) (14983)	230, 280
Maximum probe temperature (14011)	146	P1 (bottom) manual pressure (14951)	230
Measured level (14653)	272	P1 (bottom) source (14994)	230
Measured lower density (8166)	69	P1 absolute / gauge (14954)	231
Measured lower density (15002)	227, 278	P1 offset (14953)	231

- P1 position (14952) 231
- P1-2 distance (14974) 233
- P2 (middle) (14987) 232
- P2 (middle) manual pressure (14955) 232
- P2 (middle) source (14995) 232
- P2 absolute / gauge (14976) 233
- P2 offset (14975) 233
- P3 (top) (14988) 234, 280
- P3 (top) manual pressure (14977) 234
- P3 (top) source (14996) 234
- P3 absolute / gauge (14958) 235
- P3 offset (14957) 235
- P3 position (14956) 235
- Parity (13204) 176
- Percent 0% (13202) 184
- Percent 100% (13234) 184
- Percent of range (0274) 206
- Polling address (14712) 111
- Post gauge command (8163) 74
- Pressure (14723) 117
- Pressure 0% (13217) 182
- Pressure 100% (13251) 182
- Pressure unit (0564) 43
- Previous diagnostics (0690) 286
- Previous diagnostics (14755) 126
- Primary variable (PV) (0201) 205
- Probe position (14009) 146
- Process condition (8001) 83, 215
- Process value (13963) 158
- Process value (14003) 143
- Process variable (13964) 157
- Process variable (14016) 143
- Profile average density (8175) 70, 228
- Profile density 0 to 49 (8068) 279
- Profile density interval (8174) 93
- Profile density offset (8173) 93
- Profile density offset distance (8185) 93
- Profile density position 0 to 49 (8077) 279
- Profile density timestamp (8114) 70, 228
- Profile point (8170) 70, 227
- PV mA selector (11631) 205
- PV source (11634) 203
- Quaternary variable (QV) (0203) 209
- Readback value
 - Digital Xx-x (13903) 166
- Readback value (13957) 156
- Recovery state (8565) 297
- Reference 0 (14740) 124
- Reference 17 (14741) 125
- Reference calibration incomplete (8157) 308
- Reference level
 - LRC 1 to 2 (17909-1 to 2) 311
- Reference level source
 - LRC 1 to 2 (17903-1 to 2) 310
- Reference position (8046) 100, 106
- Reference switch level
 - LRC 1 to 2 (17905-1 to 2) 312
- Reference switch mode
 - LRC 1 to 2 (17914-1 to 2) 311
- Reference switch source
 - LRC 1 to 2 (17904-1 to 2) 311
- Reference switch state
 - LRC 1 to 2 (17908-1 to 2) 312
- Result drum check (8155) 306, 307
- RTD connection type (14022) 143
- RTD type (14021) 141
- Safety distance (13756) 254
- Secondary variable (SV) (0226) 207
- Seek delay (8162) 88
- Select element (14734) 132, 136
- Sensor temperature (8066) 63
- Separator (0101) 39
- Serial number (0009) 294
- Set date (0792) 50
- Set high weight (8116) 103, 105
- Set level (14604) 219
- Set low weight (8115) 104, 105
- Simulation distance (8003) 291
- Simulation distance on (8002) 291
- Simulation value (13976) 292
- Slow hoist zone (8084) 80
- Software ID (13287) 199
- Software option overview (0015) 56
- Software revision (0224) 214
- Software version (14747) 121
- SP 1 value selector (13274) 196
- SP 2 value selector (13275) 196
- SP 3 value selector (13276) 197
- SP 4 value selector (13277) 197
- Span weight (8096) 98, 106
- Standby level (8194) 83, 266
- Starting level (13601) 242
- Status self check (8192) 72, 73
- Status signal (14760) 112
- Step X / 11 (8143) 306, 307
- Stilling well (13653) 248
- Submersion depth (8169) 91
- System polling address (0219) 202
- System temperature (8553) 298
- Tank level (14655) 218, 269
- Tank Level % (14654) 269
- Tank level to NMT (14750) 119
- Tank reference height (14603) 218
- Tank ullage (14657) 270
- Tank ullage % (14658) 270
- Temperature (14725) 118
- Temperature 0% (13215) 181
- Temperature 100% (13216) 181
- Temperature element open (14732) 129
- Temperature element short (14731) 129
- Temperature offset after conversion (14025) 145
- Temperature unit (0557) 43
- Tertiary variable (TV) (0228) 208
- Test resistance (14752) 126
- Thermocouple type (14008) 142
- Timestamp (0667) 286
- Timestamp (0672) 287
- Timestamp 1 to 5 (0683-1 to 5) 288

Total no. element (14730) 128, 134
 Undertension weight (8098) 80
 Units preset (0605) 42
 Update water level (14751) 131, 136
 Upper density (8113) 82
 Upper density offset (8176) 90
 Upper density timestamp (8067) 68, 278
 Upper interface level (8127) 66
 Upper interface level (15003) 219, 270
 Upper interface level timestamp (8055) 66, 270
 Used for SIL/WHG
 Digital Xx-x (13910) 167
 Used for SIL/WHG (13980) 160
 User 0% (13221) 183
 User 100% (13222) 183
 User role (0005) 33
 User value 1 to 8 source (13209-1 to 8) . . . 185, 193
 V1 address (13235) 190
 V1 address (13236) 191
 Value 1 display (0107) 37
 Value percent selector (13282) 198
 Vapor density (14981) 226, 277
 Vapor temp source (14973) 223
 Vapor temperature (14727) 118
 Vapor temperature (14985) 224, 273
 W&M lock switch (8558) 298
 Water bottom level offset (14757) 135
 Water density (13757) 227, 255
 Water level (14717) 119
 Water level (14970) 220, 272
 Water level source (14971) 219
 WB frequency ratio (14753) 126
 Weight and measures configuration CRC (8564) 294
 Weight tolerance (8213) 88
 Wire expansion coefficient (13656) 249
 Wire weight (8040) 78
 WM550 address (13286) 199
 Word type (13208) 177
 Year (0782) 50, 53
 Zero adjust (14735) 132
 Zero adjust (14759) 137
 Discrete 1 to 4 selector (Parameter) 189, 200
 Discrete selector (Submenu) 189
 Displacer (Submenu) 75
 Displacer balance volume (Parameter) 76
 Displacer diameter (Parameter) 75
 Displacer height (Parameter) 77
 Displacer position (Parameter) 65, 272
 Displacer status (Parameter) 62
 Displacer type (Parameter) 75
 Displacer volume (Parameter) 76
 Displacer weight (Parameter) 76
 Displacer weight tolerance (Parameter) 307
 Display (Submenu) 35
 Display channel 1 to 4 (Submenu) 304
 Display damping (Parameter) 41
 Display interval (Parameter) 40
 Distance (Parameter) 60, 65, 95, 272
 Distance unit (Parameter) 43

Document
 Function 4
 Document function 4
 Drum calibration (Parameter) 102
 Drum calibration (Wizard) 102
 Drum circumference (Parameter) 78
 Drum table point (Parameter) 103

E

Element interval (Parameter) 131
 Element position (Parameter) 133, 137
 Element position (Submenu) 123, 274
 Element position 1 to 24 (Parameter) 123, 274
 Element setup (Submenu) 132, 136
 Element temperature (Parameter) 133, 137
 Element temperature (Submenu) 123, 274
 Element temperature 1 to 24 (Parameter) 123, 274
 Element values (Submenu) 123
 Empty (Parameter) 218
 ENP version (Parameter) 295
 Enter access code (Parameter) 33
 Error event type (Parameter) 158
 Error on event (Parameter) 154, 166
 Error value (Parameter) 154, 258
 Event logbook (Submenu) 289
 Expected SIL/WHG chain (Parameter) 161
 Expert (Menu) 7, 32
 Extended order code 1 (Parameter) 295

F

Failure mode (Parameter) 153
 Feedback threshold (Parameter) 157
 Firmware CRC (Parameter) 122, 294
 Firmware version (Parameter) 294
 Fixed current (Parameter) 152
 Float swap mode (Parameter) 176
 Forget device (Parameter) 138
 Forget device (Wizard) 138
 Format display (Parameter) 36

G

Gain adjust (Parameter) 130
 Gauge command (Parameter) 59
 Gauge command 0 (Parameter) 169
 Gauge command 1 (Parameter) 170
 Gauge command 2 (Parameter) 170
 Gauge command 3 (Parameter) 171
 Gauge current (Parameter) 148
 Gauge status (Parameter) 60, 62, 73, 265
 GP 1 name (Parameter) 238, 281
 GP 1 to 4 source (Parameter) 237
 GP 1 value 0% (Parameter) 186
 GP 1 value 100% (Parameter) 186
 GP 2 value 0% (Parameter) 187
 GP 2 value 100% (Parameter) 187
 GP 3 value 0% (Parameter) 187
 GP 3 value 100% (Parameter) 188
 GP 4 value 0% (Parameter) 188
 GP 4 value 100% (Parameter) 188

GP Value 1 (Parameter) 238, 281
 GP Value 2 (Parameter) 238, 281
 GP Value 3 (Parameter) 238, 282
 GP Value 4 (Parameter) 239, 282
 GP values (Submenu) 186, 237, 281
 Gross weight (Parameter) 61

H

H alarm (Parameter) 262
 H alarm value (Parameter) 260
 Hardware revision (Parameter) 213
 HART bus (Parameter) 120
 HART configuration (Submenu) 202
 HART date code (Parameter) 214
 HART descriptor (Parameter) 213
 HART device information (Submenu) 117
 HART device PV % (Parameter) 114
 HART device PV mA (Parameter) 114
 HART Device(s) (Submenu) 110
 HART devices (Submenu) 109
 HART message (Parameter) 213
 HART output (Submenu) 201
 HART revision (Parameter) 212
 HART short tag (Parameter) 210
 Header (Parameter) 39
 Header text (Parameter) 40
 HH alarm (Parameter) 261
 HH alarm value (Parameter) 260
 HH+H alarm (Parameter) 262
 High stop level (Parameter) 79
 Hour (Parameter) 51, 53
 HTMS (Submenu) 252
 HTMS mode (Parameter) 252
 Hysteresis (Parameter) 254
 HyTD (Submenu) 242
 HyTD correction value (Parameter) 242
 HyTD mode (Parameter) 242

I

Immersion depth (Parameter) 77
 Information (Submenu) 61, 210
 Input value (Parameter) 145, 155, 164
 Input value % (Parameter) 156
 Input value in mA (Parameter) 159
 Input value percent (Parameter) 144, 159
 Input/output (Submenu) 108
 Integer conversion (Submenu) 180
 Interface measurement mode (Parameter) 87
 Invalid data (Parameter) 177

K

Kind of interval (Parameter) 130

L

L alarm (Parameter) 262
 L alarm value (Parameter) 261
 Language (Parameter) 35
 Last diagnostic (Parameter) 124
 Level (Submenu) 217, 268
 Level 0% (Parameter) 180

Level 100% (Parameter) 181
 Level mapping (Parameter) 191
 Level measurement mode (Parameter) 86
 Level settings (Submenu) 82
 Level source (Parameter) 119, 217
 Line impedance (Parameter) 192
 Linear expansion coefficient (Parameter) 249
 Liquid level (Parameter) 66
 Liquid temp source (Parameter) 221
 Liquid temperature (Parameter) 222, 273
 LL alarm (Parameter) 262
 LL alarm value (Parameter) 261
 LL+L alarm (Parameter) 263
 Local gravity (Parameter) 239
 Locking status (Parameter) 32
 Logging interval (Parameter) 302
 Low stop level (Parameter) 79
 Lower density (Parameter) 83
 Lower density offset (Parameter) 91
 Lower density timestamp (Parameter) 69, 279
 Lower interface level (Parameter) 66, 219, 271
 Lower interface level timestamp (Parameter) 67, 271
 LRC 1 to 2 (Submenu) 309
 LRC Mode (Parameter) 309

M

Make drum table (Parameter) 103
 Make low table (Parameter) 104
 Make sure to have (Parameter) 102
 Manual air temperature (Parameter) 223
 Manual density (Parameter) 253
 Manual liquid temperature (Parameter) 222
 Manual profile level (Parameter) 92
 Manual value (Parameter) 120
 Manual vapor temperature (Parameter) 224
 Manual water level (Parameter) 220
 Manufacturer ID (Parameter) 212
 Maximum probe temperature (Parameter) 146
 Measured level (Parameter) 272
 Measured lower density (Parameter) 69, 227, 278
 Measured middle density (Parameter) 68, 227, 278
 Measured upper density (Parameter) 68, 226, 277
 Measured values (Submenu) 64
 Menu
 Expert 7, 32
 Middle density (Parameter) 82
 Middle density offset (Parameter) 90
 Middle Density Timestamp (Parameter) 69, 278
 Minimum level (Parameter) 253
 Minimum pressure (Parameter) 254
 Minimum probe temperature (Parameter) 145
 Minute (Parameter) 52, 54
 Modbus address (Parameter) 176
 Modbus discrete 1 to 4 (Parameter) 174
 Modbus value 1 to 4 (Parameter) 174
 Module type (Parameter) 296
 Month (Parameter) 51, 53
 Motor status (Parameter) 63, 96
 Move displacer (Parameter) 96

- Move displacer (Wizard) 95
 Move distance (Parameter) 95
- N**
- Net weight (Parameter) 61, 265
 NMT device config (Submenu) 127, 133
 NMT element values (Submenu) 274
 No element in phase (Parameter) 135
 No. of preambles (Parameter) 203
 Number format (Parameter) 39
 Number of devices (Parameter) 109
- O**
- Observed density (Parameter) 226, 276
 Observed density source (Parameter) 225
 Observed density temperature (Parameter) 277
 Offset calibration (Parameter) 99
 Offset standby distance (Parameter) 84, 267
 Offset weight (Parameter) 97, 106
 Ohms offset (Parameter) 142
 Old TSM mode (Parameter) 178
 One-time command status (Parameter) 63, 268
 Operating mode (Parameter) 111, 139, 141, 150, 163
 Operating time (Parameter) 287
 Operating time from restart (Parameter) 287
 Order code (Parameter) 295
 Output at error (Parameter) 130
 Output density (Parameter) 115
 Output level (Parameter) 116
 Output out of range (Parameter) 81, 154
 Output pressure (Parameter) 114
 Output simulation (Parameter) 165
 Output temperature (Parameter) 115
 Output value (Parameter) 156, 166
 Output vapor temperature (Parameter) 115
 Overtension weight (Parameter) 80
- P**
- P1 (bottom) (Parameter) 230, 280
 P1 (bottom) manual pressure (Parameter) 230
 P1 (bottom) source (Parameter) 230
 P1 absolute / gauge (Parameter) 231
 P1 offset (Parameter) 231
 P1 position (Parameter) 231
 P1-2 distance (Parameter) 233
 P2 (middle) (Parameter) 232
 P2 (middle) manual pressure (Parameter) 232
 P2 (middle) source (Parameter) 232
 P2 absolute / gauge (Parameter) 233
 P2 offset (Parameter) 233
 P3 (top) (Parameter) 234, 280
 P3 (top) manual pressure (Parameter) 234
 P3 (top) source (Parameter) 234
 P3 absolute / gauge (Parameter) 235
 P3 offset (Parameter) 235
 P3 position (Parameter) 235
 Parity (Parameter) 176
 Percent 0% (Parameter) 184
 Percent 100% (Parameter) 184
- Percent of range (Parameter) 206
 Polling address (Parameter) 111
 Post gauge command (Parameter) 74
 Pressure (Parameter) 117
 Pressure (Submenu) 229, 280
 Pressure 0% (Parameter) 182
 Pressure 100% (Parameter) 182
 Pressure unit (Parameter) 43
 Previous diagnostics (Parameter) 126, 286
 Primary variable (PV) (Parameter) 205
 Probe position (Parameter) 146
 Process condition (Parameter) 83, 215
 Process value (Parameter) 143, 158
 Process variable (Parameter) 143, 157
 Profile average density (Parameter) 70, 228
 Profile density (Submenu) 70, 92, 279
 Profile density 0 to 49 (Parameter) 279
 Profile density interval (Parameter) 93
 Profile density offset (Parameter) 93
 Profile density offset distance (Parameter) 93
 Profile density position 0 to 49 (Parameter) 279
 Profile density timestamp (Parameter) 70, 228
 Profile point (Parameter) 70, 227
 Progress (Parameter) 100
 PV mA selector (Parameter) 205
 PV source (Parameter) 203
- Q**
- Quaternary variable (QV) (Parameter) 209
- R**
- Readback value (Parameter) 156, 166
 Recovery state (Parameter) 297
 Reference 0 (Parameter) 124
 Reference 17 (Parameter) 125
 Reference calibration (Parameter) 100
 Reference calibration (Wizard) 100
 Reference calibration incomplete (Parameter) 308
 Reference level (Parameter) 311
 Reference level source (Parameter) 310
 Reference position (Parameter) 100, 106
 Reference switch level (Parameter) 312
 Reference switch mode (Parameter) 311
 Reference switch source (Parameter) 311
 Reference switch state (Parameter) 312
 Result drum check (Parameter) 306, 307
 RTD connection type (Parameter) 143
 RTD type (Parameter) 141
- S**
- Safety distance (Parameter) 254
 Safety Instructions (XA) 6
 Safety settings (Submenu) 79
 Secondary variable (SV) (Parameter) 207
 Seek delay (Parameter) 88
 Select element (Parameter) 132, 136
 Self check (Parameter) 72
 Self check (Wizard) 72
 Sensor (Submenu) 59

- Sensor calibration (Parameter) 97
 - Sensor calibration (Wizard) 97
 - Sensor config (Submenu) 74
 - Sensor diag (Submenu) 72
 - Sensor temperature (Parameter) 63
 - Separator (Parameter) 39
 - Serial number (Parameter) 294
 - Set date (Parameter) 50, 54
 - Set date (Wizard) 53
 - Set high weight (Parameter) 103, 105
 - Set level (Parameter) 219
 - Set low weight (Parameter) 104, 105
 - Simulation (Submenu) 290
 - Simulation distance (Parameter) 291
 - Simulation distance on (Parameter) 291
 - Simulation value (Parameter) 292
 - Slow hoist zone (Parameter) 80
 - Software ID (Parameter) 199
 - Software option overview (Parameter) 56
 - Software revision (Parameter) 214
 - Software version (Parameter) 121
 - SP 1 value selector (Parameter) 196
 - SP 2 value selector (Parameter) 196
 - SP 3 value selector (Parameter) 197
 - SP 4 value selector (Parameter) 197
 - Span calibration (Parameter) 99
 - Span weight (Parameter) 98, 106
 - Spot density (Submenu) 68, 90
 - Standby level (Parameter) 83, 266
 - Start self check (Submenu) 72
 - Starting level (Parameter) 242
 - Status self check (Parameter) 72, 73
 - Status signal (Parameter) 112
 - Step X / 11 (Parameter) 306, 307
 - Stilling well (Parameter) 248
 - Submenu
 - #blank# 138
 - Administration 55, 56
 - Alarm 256
 - Analog I/O 149
 - Analog IP 140
 - Application 215
 - Balance settings 86
 - Board info 298
 - Calibration 94
 - Calibration parameters 105
 - Commissioning parameter 307
 - Communication 172
 - Configuration 175, 190, 198
 - CTSh 247
 - Data logging 300, 301
 - Date / time 49, 50
 - Density 225, 276
 - Density table 71
 - Device check 305
 - Device information 293
 - Diagnostic list 288
 - Diagnostics 124, 125, 283
 - Digital input mapping 168
 - Digital Xx-x 162
 - Discrete selector 189
 - Displacer 75
 - Display 35
 - Display channel 1 to 4 304
 - Element position 123, 274
 - Element setup 132, 136
 - Element temperature 123, 274
 - Element values 123
 - Event logbook 289
 - GP values 186, 237, 281
 - HART configuration 202
 - HART device information 117
 - HART Device(s) 110
 - HART devices 109
 - HART output 201
 - HTMS 252
 - HyTD 242
 - Information 61, 210
 - Input/output 108
 - Integer conversion 180
 - Level 217, 268
 - Level settings 82
 - LRC 1 to 2 309
 - Measured values 64
 - NMT device config 127, 133
 - NMT element values 274
 - Pressure 229, 280
 - Profile density 70, 92, 279
 - Safety settings 79
 - Sensor 59
 - Sensor config 74
 - Sensor diag 72
 - Simulation 290
 - Spot density 68, 90
 - Start self check 72
 - System 34
 - System units 42
 - Tank calculation 239
 - Tank configuration 215
 - Tank values 265
 - Temperature 221, 273
 - User value source 185
 - V1 input selector 193
 - Wiredrum 78
 - WM550 input selector 200
 - Submersion depth (Parameter) 91
 - System (Submenu) 34
 - System polling address (Parameter) 202
 - System temperature (Parameter) 298
 - System units (Submenu) 42
- T**
- Tank calculation (Submenu) 239
 - Tank configuration (Submenu) 215
 - Tank level (Parameter) 218, 269
 - Tank Level % (Parameter) 269
 - Tank level to NMT (Parameter) 119
 - Tank reference height (Parameter) 218

Tank ullage (Parameter) 270
 Tank ullage % (Parameter) 270
 Tank values (Submenu) 265
 Temperature (Parameter) 118
 Temperature (Submenu) 221, 273
 Temperature 0% (Parameter) 181
 Temperature 100% (Parameter) 181
 Temperature element open (Parameter) 129
 Temperature element short (Parameter) 129
 Temperature offset after conversion (Parameter) . . . 145
 Temperature unit (Parameter) 43
 Tertiary variable (TV) (Parameter) 208
 Test resistance (Parameter) 126
 Thermocouple type (Parameter) 142
 Timestamp (Parameter) 286, 287
 Timestamp 1 to 5 (Parameter) 288
 Total no. element (Parameter) 128, 134

U

Undertension weight (Parameter) 80
 Units preset (Parameter) 42
 Update water level (Parameter) 131, 136
 Upper density (Parameter) 82
 Upper density offset (Parameter) 90
 Upper density timestamp (Parameter) 68, 278
 Upper interface level (Parameter) 66, 219, 270
 Upper interface level timestamp (Parameter) . . . 66, 270
 Used for SIL/WHG (Parameter) 160, 167
 User 0% (Parameter) 183
 User 100% (Parameter) 183
 User role (Parameter) 33
 User value 1 to 8 source (Parameter) 185, 193
 User value source (Submenu) 185

V

V1 address (Parameter) 190, 191
 V1 input selector (Submenu) 193
 Value 1 display (Parameter) 37
 Value percent selector (Parameter) 198
 Vapor density (Parameter) 226, 277
 Vapor temp source (Parameter) 223
 Vapor temperature (Parameter) 118, 224, 273

W

W&M lock switch (Parameter) 298
 Water bottom level offset (Parameter) 135
 Water density (Parameter) 227, 255
 Water level (Parameter) 119, 220, 272
 Water level source (Parameter) 219
 WB frequency ratio (Parameter) 126
 Weight and measures configuration CRC (Parameter)
 294
 Weight tolerance (Parameter) 88
 Wire expansion coefficient (Parameter) 249
 Wire weight (Parameter) 78
 Wiredrum (Submenu) 78
 Wizard
 Commissioning check 306
 Define access code 57

Drum calibration 102
 Forget device 138
 Move displacer 95
 Reference calibration 100
 Self check 72
 Sensor calibration 97
 Set date 53
 WM550 address (Parameter) 199
 WM550 input selector (Submenu) 200
 Word type (Parameter) 177

Y

Year (Parameter) 50, 53

Z

Zero adjust (Parameter) 132, 137
 Zero calibration (Parameter) 98



71686018

www.addresses.endress.com
