

# Brief Operating Instructions

## Micropilot FMR63B

Free-space radar  
PROFINET over Ethernet-APL



These Brief Operating Instructions are not a substitute for the Operating Instructions pertaining to the device. Detailed information can be found in the Operating Instructions and the additional documentation.

Available for all device versions via:

- Internet: [www.endress.com/deviceviewer](http://www.endress.com/deviceviewer)
- Smartphone/tablet: Endress+Hauser Operations app

# 1

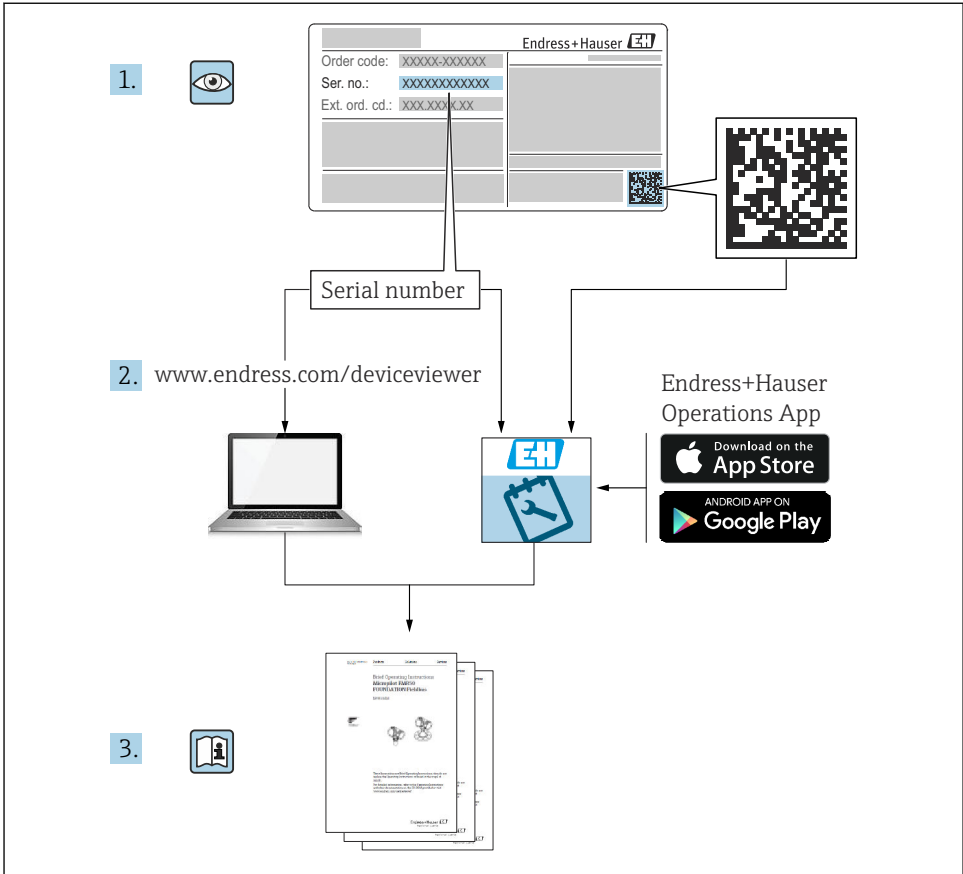

A0023555

## 2 Symbols

### 2.1 Safety symbols

#### **DANGER**

This symbol alerts you to a dangerous situation. Failure to avoid this situation will result in serious or fatal injury.

#### **WARNING**

This symbol alerts you to a dangerous situation. Failure to avoid this situation can result in serious or fatal injury.

#### **CAUTION**

This symbol alerts you to a dangerous situation. Failure to avoid this situation can result in minor or medium injury.

#### **NOTICE**

This symbol contains information on procedures and other facts which do not result in personal injury.

### 2.2 Symbols for certain types of information and graphics

#### **Permitted**

Procedures, processes or actions that are permitted

#### **Preferred**

Procedures, processes or actions that are preferred

#### **Forbidden**

Procedures, processes or actions that are forbidden

#### **Tip**

Indicates additional information



Reference to documentation



Reference to graphic



Notice or individual step to be observed



Series of steps



Result of a step

1, 2, 3, ...

Item numbers

A, B, C, ...

Views

#### **Safety instructions**

Observe the safety instructions contained in the associated Operating Instructions

## 3 Requirements for the personnel

The personnel for installation, commissioning, diagnostics and maintenance must fulfill the following requirements:

- ▶ Trained, qualified specialists must have a relevant qualification for this specific function and task.
- ▶ Are authorized by the plant owner/operator.
- ▶ Are familiar with federal/national regulations.
- ▶ Before starting work, read and understand the instructions in the manual and supplementary documentation as well as the certificates (depending on the application).
- ▶ Follow instructions and comply with basic conditions.

The personnel must fulfill the following requirements for its tasks:

- ▶ Trained, qualified specialists must have a relevant qualification for this specific function and task.
- ▶ Are authorized by the plant owner/operator.
- ▶ Are familiar with federal/national regulations.
- ▶ Before starting work, read and understand the instructions in the manual and supplementary documentation as well as the certificates (depending on the application).
- ▶ Follow instructions and comply with basic conditions.

The operating personnel must fulfill the following requirements:

- ▶ Are instructed and authorized according to the requirements of the task by the facility's owner-operator.
- ▶ Follow the instructions in this manual.

## 4 Intended use

### Application and media

The measuring device described in these Operating Instructions is intended for continuous, non-contact level measurement in liquids, pastes and sludges. The operating frequency is approx. 80 GHz with a maximum emitted peak power of <1.5 mW and an average power output of <70  $\mu$ W. Operation does not pose any danger whatsoever to humans and animals.

If the limit values specified in the "Technical data" and the conditions listed in the instructions and additional documentation are observed, the measuring device may be used only for the following measurements:

- ▶ Measured process variables: level, distance, signal strength
- ▶ Calculable process variables: volume or mass in any shape of vessel

To ensure that the measuring device remains in proper condition for the operation time:

- ▶ Use the measuring device only for media to which the process-wetted materials are sufficiently resistant.
- ▶ Observe the limit values in the "Technical data".

### Incorrect use

The manufacturer is not liable for damage caused by improper or non-intended use.

Avoid mechanical damage:

- ▶ Do not touch or clean device surfaces with pointed or hard objects.

Clarification of borderline cases:

- ▶ For special fluids and fluids for cleaning, Endress+Hauser is glad to provide assistance in verifying the corrosion resistance of fluid-wetted materials, but does not accept any warranty or liability.

### **Residual risks**

Due to heat transfer from the process as well as power loss in the electronics, the temperature of the electronics housing and the assemblies it contains (e.g. display module, main electronics module and I/O electronics module) may rise to 80 °C (176 °F). When in operation, the sensor can reach a temperature close to the medium temperature.

Danger of burns from contact with surfaces!

- ▶ In the event of elevated fluid temperatures, ensure protection against contact to prevent burns.

## **5 Workplace safety**

When working on and with the device:

- ▶ Wear the required personal protective equipment as per national regulations.

## **6 Operational safety**

Damage to the device!

- ▶ Operate the device in proper technical condition and fail-safe condition only.
- ▶ The operator is responsible for the interference-free operation of the device.

### **Modifications to the device**

Unauthorized modifications to the device are not permitted and can lead to unforeseeable dangers!

- ▶ If modifications are nevertheless required, consult with the manufacturer.

### **Repair**

To ensure continued operational safety and reliability:

- ▶ Carry out repairs on the device only if they are expressly permitted.
- ▶ Observe federal/national regulations pertaining to the repair of an electrical device.
- ▶ Use only original spare parts and accessories.

## 7 Product safety

This measuring device is designed in accordance with good engineering practice to meet state-of-the-art safety requirements, has been tested, and left the factory in a condition in which it is safe to operate.

It meets general safety standards and legal requirements. It also complies with the EU directives listed in the device-specific EU Declaration of Conformity. The manufacturer confirms this by affixing the CE mark to the device.

## 8 Incoming acceptance

Check the following during incoming acceptance:

- Is the order code on the delivery note identical to the order code on the product sticker?
- Are the goods undamaged?
- Do the data on the nameplate correspond to the order specifications and the delivery note?
- Is the documentation provided?
- If required (see nameplate), are the Safety Instructions (XA) provided?



If one of these conditions is not met, please contact the manufacturer's sales office.

## 9 Product identification

The following options are available for identification of the device:

- Nameplate specifications
- Extended order code with breakdown of the device features on the delivery note
- ▶ *Device Viewer*([www.endress.com/deviceviewer](http://www.endress.com/deviceviewer)); manually enter the serial number from the nameplate.
  - ↳ All the information about the measuring device is displayed.
- ▶ *Endress+Hauser Operations app*; manually enter the serial number indicated on the nameplate or scan the 2D matrix code on the nameplate.
  - ↳ All the information about the measuring device is displayed.

### 9.1 Nameplate

#### Do you have the correct device?

The nameplate provides you with the following information on the device:

- Manufacturer identification, device designation
- Order code
- Extended order code
- Serial number
- Tag name (TAG) (optional)

- Technical values, e.g. supply voltage, current consumption, ambient temperature, communication-specific data (optional)
  - Degree of protection
  - Approvals with symbols
  - Reference to Safety Instructions (XA) (optional)
- ▶ Compare the information on the nameplate with the order.

## 9.2 Manufacturer address

Endress+Hauser SE+Co. KG  
Hauptstraße 1  
79689 Maulburg, Germany  
Place of manufacture: See nameplate.

# 10 Storage and transport

## 10.1 Storage conditions

- Use the original packaging
- Store the device in clean and dry conditions and protect from damage caused by shocks

### 10.1.1 Storage temperature range

See Technical Information.

## 10.2 Transporting the product to the measuring point

### WARNING

#### **Incorrect transport!**

The housing or sensor can be damaged or pull off. Risk of injury!

- ▶ Transport the device to the measuring point in its original packaging or by the process connection.
- ▶ Always secure lifting equipment (slings, eyes, etc.) at the process connection and never lift the device by the electronic housing or sensor. Pay attention to the center of gravity of the device so that it does not tilt or slip unintentionally.

# 11 Installation

## 11.1 General instructions

### **⚠ WARNING**

**Loss of protection rating if the device is opened in a wet environment.**

► Only open the device in a dry environment!

1. Install the device or turn the housing so that the cable entries do not point upwards.

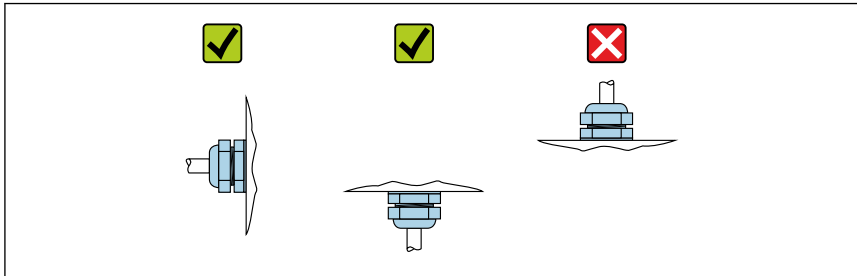

A0029263

2. Always firmly tighten the housing cover and the cable entries.
3. Counter-tighten the cable entries.
4. A drip loop must be provided when laying the cables.



## 11.2 Installation requirements

### 11.2.1 Internal vessel fittings

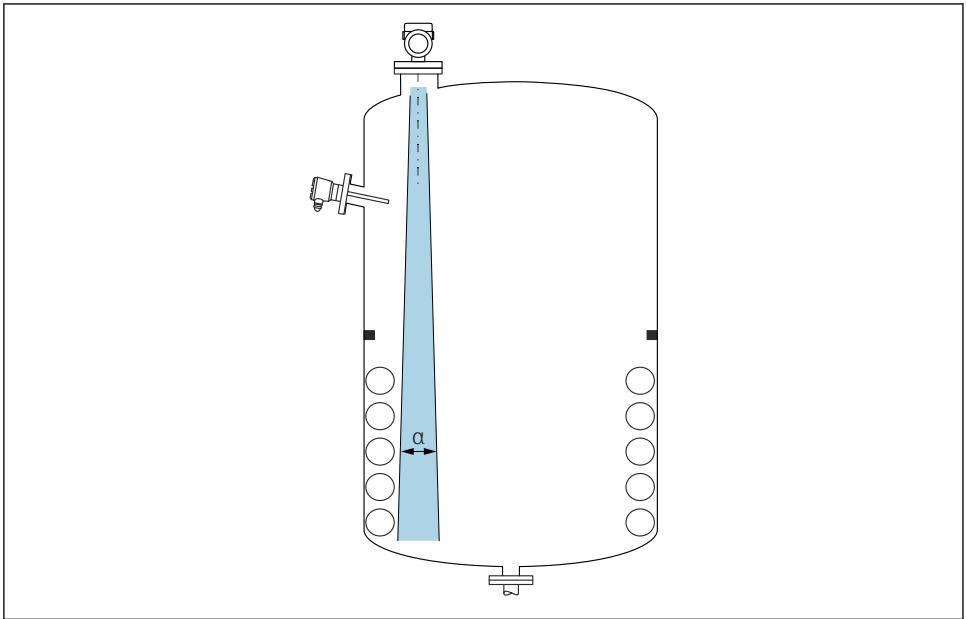

A0031777

Avoid internal fittings (level switches, temperature sensors, struts, vacuum rings, heating coils, baffles etc.) inside the signal beam. Pay attention to the beam angle  $\alpha$ .

### 11.2.2 Vertical alignment of antenna axis

Align the antenna so that it is perpendicular to the product surface.



The maximum reach of the antenna can be reduced, or additional interference signals can occur, if the antenna is not installed perpendicular to the product.

## 11.3 Mounting the device

### 11.3.1 Integrated antenna, PEEK 20 mm (0.75 in)

#### Information concerning threaded connections

- When screwing in, turn by the hex bolt only.
- Tool: open-ended wrench 36 mm
- Maximum permissible torque: 50 Nm (36 lbf ft)

#### Information about the mounting nozzle

The maximum nozzle length  $H_{max}$  depends on the nozzle diameter  $D$ .

### Maximum nozzle length $H_{max}$ as a function of the nozzle diameter $D$

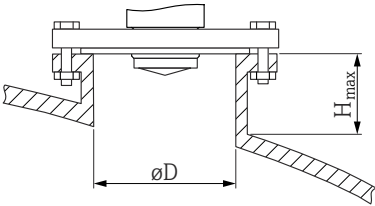
	$\phi D$	$H_{max}$
	40 to 50 mm (1.6 to 2 in)	200 mm (8 in)
	50 to 80 mm (2 to 3.2 in)	300 mm (12 in)
	80 to 100 mm (3.2 to 4 in)	450 mm (18 in)
	100 to 150 mm (4 to 6 in)	550 mm (22 in)
	$\geq 150$ mm (6 in)	850 mm (34 in)

**i** In the case of longer nozzles, reduced measuring performance must be expected.

Please note the following:

- The end of the nozzle must be smooth and free from burrs.
- The edge of the nozzle should be rounded.
- Mapping must be performed.
- Please contact the manufacturer's support department for applications with nozzles that are higher than indicated in the table.

#### 11.3.2 Antenna, PTFE cladded, flush mount 50 mm (2 in)

**i** The cladding on the antenna also acts as a process seal. An additional seal is not required for installation.

#### Information about the mounting nozzle

The maximum nozzle length  $H_{max}$  depends on the nozzle diameter  $D$ .

*The maximum length of the nozzle  $H_{max}$  depends on the nozzle diameter  $D$*

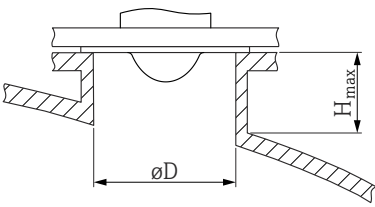
	$\phi D$	$H_{max}$
	50 to 80 mm (2 to 3.2 in)	600 mm (24 in)
	80 to 100 mm (3.2 to 4 in)	1 000 mm (40 in)
	100 to 150 mm (4 to 6 in)	1 250 mm (50 in)
	$\geq 150$ mm (6 in)	1 850 mm (74 in)

**i** In the case of longer nozzles, reduced measuring performance must be expected.

Please note the following:

- The end of the nozzle must be smooth and free from burrs.
- The edge of the nozzle should be rounded.
- Mapping must be performed.
- Please contact the manufacturer's support department for applications with nozzles that are higher than indicated in the table.

### 11.3.3 Antenna, PTFE clad, flush mount 80 mm (3 in)

**i** The cladding on the antenna also acts as a process seal. An additional seal is not required for installation.

#### Information about the mounting nozzle

The maximum nozzle length  $H_{max}$  depends on the nozzle diameter  $D$ .

*The maximum length of the nozzle  $H_{max}$  depends on the nozzle diameter  $D$*

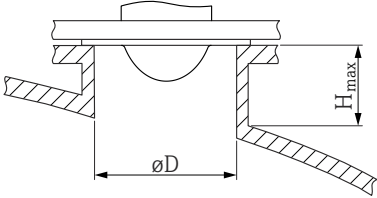
	$\Phi D$	$H_{max}$
	80 to 100 mm (3.2 to 4 in)	1 750 mm (70 in)
	100 to 150 mm (4 to 6 in)	2 200 mm (88 in)
	$\geq 150$ mm (6 in)	3 300 mm (132 in)

**i** In the case of longer nozzles, reduced measuring performance must be expected.

Please note the following:

- The end of the nozzle must be smooth and free from burrs.
- The edge of the nozzle should be rounded.
- Mapping must be performed.
- Please contact the manufacturer's support department for applications with nozzles that are higher than indicated in the table.

### 11.3.4 Turning the housing

The housing can be rotated up to  $380^\circ$  by loosening the locking screw.

#### Your benefits

- Easy installation due to optimum alignment of housing
- Easily accessible device operation
- Optimum readability of the local display (optional)

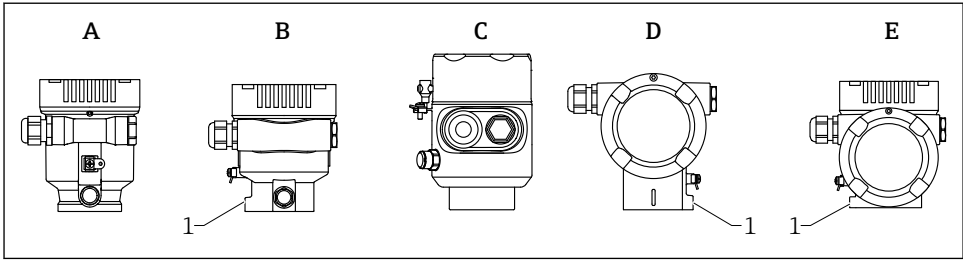

A0046660

- A Plastic single compartment housing (no locking screw)  
 B Aluminum single compartment housing  
 C Single compartment housing, 316L, hygiene (no locking screw)  
 D Dual compartment housing  
 E Dual compartment housing, L-form  
 1 Locking screw

## NOTICE

### The housing cannot be unscrewed fully.

- ▶ Loosen the external locking screw by a maximum of 1.5 turns. If the screw is unscrewed too much or completely (beyond the screw anchor point), small parts (counter disk) can become loose and fall out.
- ▶ Tighten the securing screw (hexagon socket 4 mm (0.16 in)) with maximum 3.5 Nm (2.58 lbf ft)  $\pm$  0.3 Nm (0.22 lbf ft).

### 11.3.5 Turning the display module

#### ⚠ WARNING

#### Supply voltage switched on!

Risk of electric shock and/or explosion!

- ▶ Switch off the supply voltage before opening the measuring device.

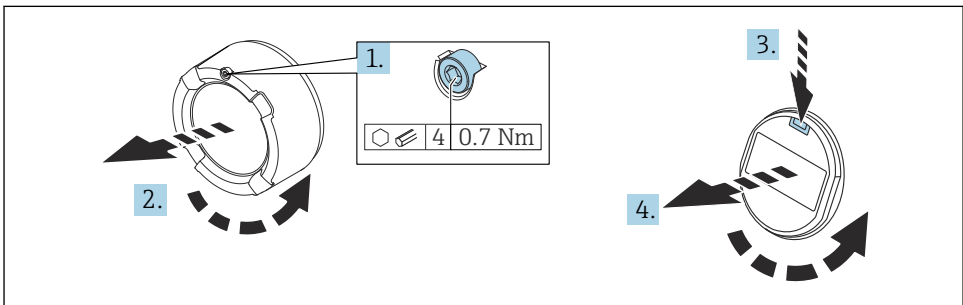

A0038224

1. If fitted: release the screw of the cover lock for the electronics compartment cover using the Allen key.

2. Unscrew the electronics compartment cover from the transmitter housing and check the cover seal.
3. Press the release mechanism and remove the display module.
4. Turn the display module to the desired position: maximum  $4 \times 90^\circ$  in each direction. Fit the display module on the electronics compartment in the desired position until it clicks into place. Screw the electronics compartment cover back onto the transmitter housing. If fitted: tighten the screw of the cover lock using the Allen key 0.7 Nm (0.52 lbf ft)  $\pm 0.2$  Nm (0.15 lbf ft).

### 11.3.6 Closing the housing covers

#### NOTICE

#### Thread and housing damaged from dirt!

- ▶ Remove dirt (e.g. sand) on the cover and housing thread.
- ▶ If you encounter resistance when closing the cover, check the thread for dirt and clean it.



#### Housing thread

The threads of the electronics and connection compartment can be coated with an anti-friction coating.

The following applies for all housing materials:

**Do not lubricate the housing threads.**

### 11.4 Post-mounting check

- Is the device free from damage (visual inspection)?
- Are the measuring point identification and labeling correct (visual inspection)?
- Is the measuring device protected against precipitation and sunlight?
- Are the securing screws and cover lock tightened securely?
- Does the measuring device comply with the measuring point specifications?

For example:

- Process temperature
- Process pressure
- Ambient temperature
- Measuring range

## 12 Electrical connection

### 12.1 Connecting requirements

#### 12.1.1 Cover with securing screw

The cover is locked by a securing screw in devices for use in hazardous areas with certain explosion protection.

**NOTICE**

**If the securing screw is not positioned correctly, the cover cannot provide secure sealing.**

- ▶ Open the cover: slacken the screw of the cover lock with a maximum of 2 turns so that the screw does not fall out. Fit the cover and check the cover seal.
- ▶ Close the cover: screw the cover securely onto the housing, making sure that the securing screw is positioned correctly. There should not be any gap between the cover and housing.

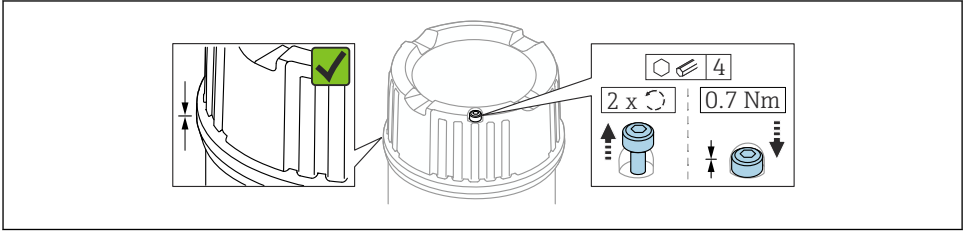

A0039520

1 Cover with securing screw

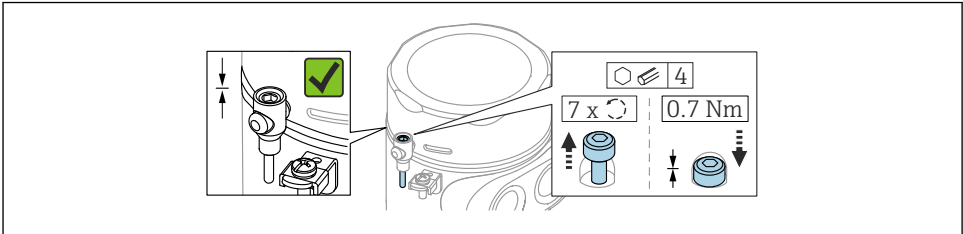

A0050983

2 Cover with securing screw; hygienic housing (only for dust explosion protection)

### 12.1.2 Potential equalization

The protective ground on the device must not be connected. If necessary, the potential matching line can be connected to the outer ground terminal of the housing before the device is connected.

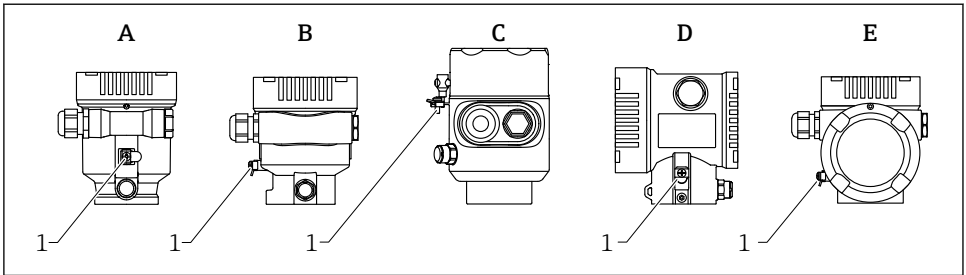

A0046583

- A Single compartment housing, plastic  
 B Single compartment housing, aluminum, coated  
 C Single compartment housing, 316L, hygiene (Ex device)  
 D Dual compartment housing, aluminum, coated  
 E Dual compartment housing, L-shaped, aluminum, coated  
 1 Ground terminal for connecting the potential matching line

**⚠ WARNING**

**Ignitable sparks or impermissible high surface temperatures.**

Explosion hazard!

- ▶ Please refer to the separate documentation on applications in hazardous areas for the safety instructions.



For optimum electromagnetic compatibility:

- Keep potential matching line as short as possible
- Observe minimum cross-section of 2.5 mm<sup>2</sup> (14 AWG)

## 12.2 Connecting the device

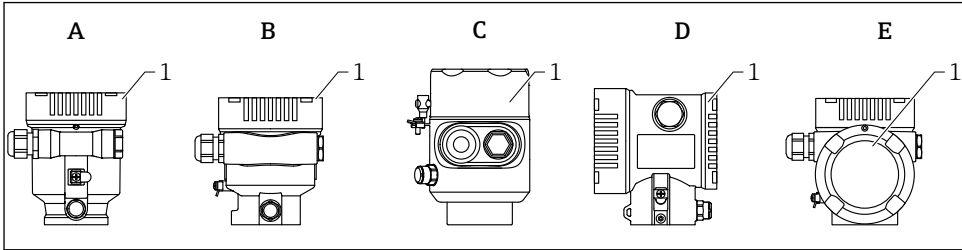

A0046659

- A Single compartment housing, plastic  
 B Single compartment housing, aluminum, coated  
 C Single compartment housing, 316L, hygiene  
 D Dual compartment housing, aluminum, coated  
 E Dual compartment housing, L-shaped, aluminum, coated  
 1 Connection compartment cover

**i** Devices with a single compartment 316L hygiene housing and conduit screw connection must be connected as end-of-line devices; only one “conduit entry” may be used.

**i** **Housing thread**  
 The threads of the electronics and connection compartment can be coated with an anti-friction coating.

The following applies for all housing materials:

**✗ Do not lubricate the housing threads.**

### 12.2.1 Supply voltage

APL performance class A (9.6 to 15 V<sub>DC</sub> 540 mW)

**i** The APL field switch must be tested to ensure it meets safety requirements (e.g., PELV, SELV, Class 2) and must comply with the relevant protocol specifications.

### 12.2.2 Cable specification

#### Rated cross-section

- Supply voltage  
0.5 to 2.5 mm<sup>2</sup> (20 to 13 AWG)
- Protective earth or grounding of the cable shield  
> 1 mm<sup>2</sup> (17 AWG)
- External ground terminal  
0.5 to 4 mm<sup>2</sup> (20 to 12 AWG)



### Cable outer diameter

The cable outer diameter depends on the cable gland used

- Coupling, plastic:  
     $\varnothing$ 5 to 10 mm (0.2 to 0.38 in)
- Coupling, nickel-plated brass:  
     $\varnothing$ 7 to 10.5 mm (0.28 to 0.41 in)
- Coupling, stainless steel:  
     $\varnothing$ 7 to 12 mm (0.28 to 0.47 in)

### 12.2.3 Overvoltage protection

The overvoltage protection can optionally be ordered as a "Mounted accessory" via the product structure.

#### Devices without optional overvoltage protection

The devices satisfy the IEC/DIN EN IEC 61326-1 product standard (Table 2 Industrial environment).

Depending on the type of port (DC power supply, input/output port) different testing levels according to IEC/DIN EN 61326-1 against transient overvoltages are applied (IEC/DIN EN 61000-4-5 Surge):

Test level on DC power ports and input/output ports is 1 000 V line to earth

#### Devices with optional overvoltage protection

- Spark-over voltage: min. 400 V<sub>DC</sub>
- Tested according to IEC/DIN EN 60079-14 sub chapter 12.3 (IEC/DIN EN 60060-1 chapter 7)
- Nominal discharge current: 10 kA

#### NOTICE

**The device can be destroyed by excessively high electrical voltages.**

- ▶ Always ground the device with integrated overvoltage protection.

#### Overvoltage category

Overvoltage category II

## 12.2.4 Wiring

### WARNING

#### Supply voltage might be connected!

Risk of electric shock and/or explosion!

- ▶ If the device is used in hazardous areas, make sure to comply with national standards and the specifications in the Safety Instructions (XAs). The specified cable gland must be used.
- ▶ The supply voltage must match the specifications on the nameplate.
- ▶ Switch off the supply voltage before connecting the device.
- ▶ If necessary, the potential matching line can be connected to the outer ground terminal of the device before the power supply lines are connected.
- ▶ A suitable circuit breaker should be provided for the device in accordance with IEC/EN 61010.
- ▶ The cables must be adequately insulated, with due consideration given to the supply voltage and the overvoltage category.
- ▶ The connecting cables must offer adequate temperature stability, with due consideration given to the ambient temperature.
- ▶ Only operate the measuring device with the covers closed.

Connect the device in the following order:

1. Release the cover lock (if provided).
2. Unscrew the cover.
3. Guide the cables into the cable glands or cable entries.
4. Connect the cables.
5. Tighten the cable glands or cable entries so that they are leak-tight. Counter-tighten the housing entry.
6. Screw the cover securely back onto the connection compartment.
7. If provided: tighten the screw of the cover lock using the Allen key 0.7 Nm (0.52 lbf ft)  $\pm 0.2$  Nm (0.15 lbf ft).

## 12.2.5 Terminal assignment

### Single compartment housing

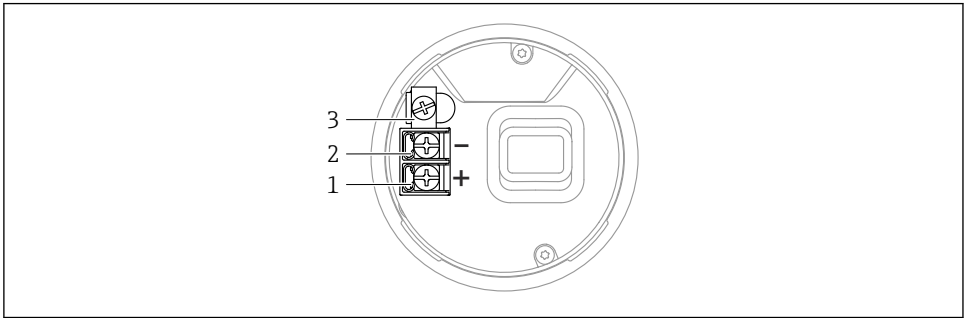

A0042594

- 3 Connection terminals and ground terminal in the connection compartment, single compartment housing
- 1 Positive terminal
- 2 Negative terminal
- 3 Internal ground terminal

### Dual compartment housing

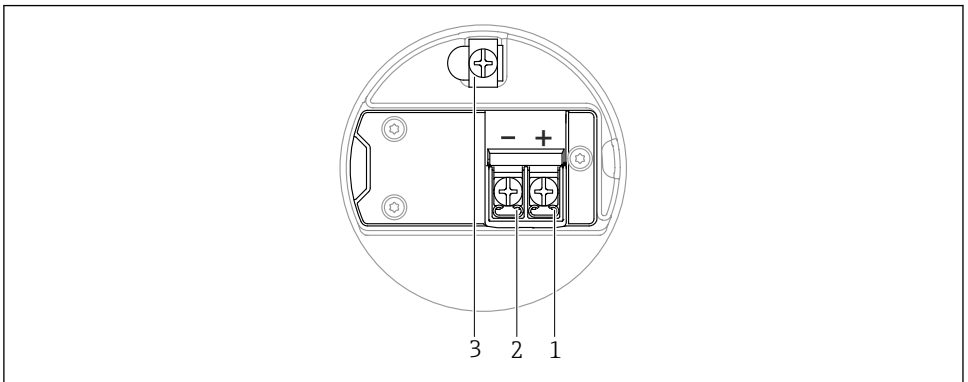

A0042803

- 4 Connection terminals and ground terminal in the connection compartment
- 1 Plus terminal
- 2 Minus terminal
- 3 Internal ground terminal

## Dual compartment housing, L-shaped

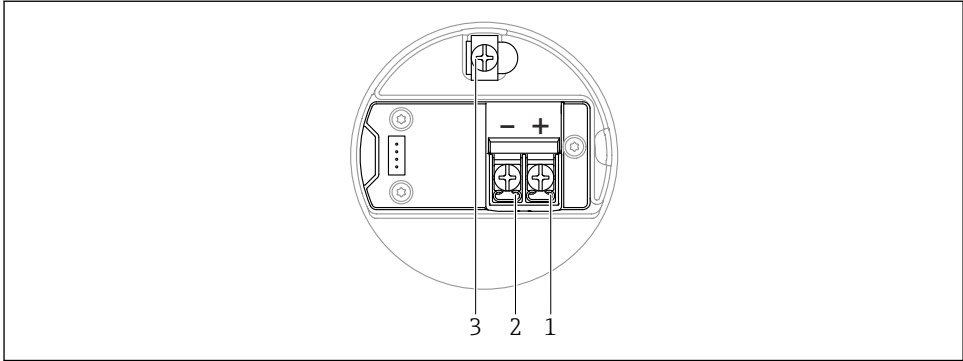

A0045842

### 5 Connection terminals and ground terminal in the connection compartment

- 1 Plus terminal
- 2 Minus terminal
- 3 Internal ground terminal

## 12.2.6 Cable entries

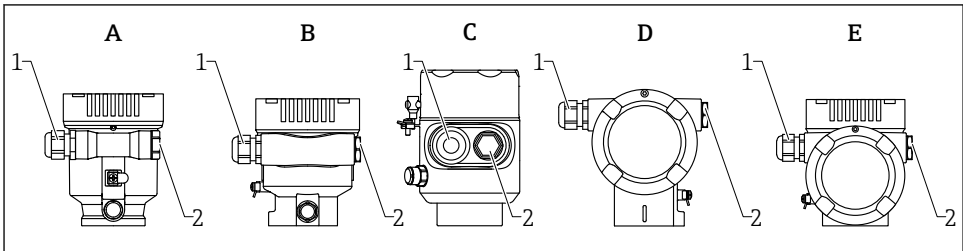

A0045842

- A Single compartment housing, plastic
- B Single compartment housing, aluminum, coated
- C Single compartment housing, 316L, hygiene
- D Dual compartment housing, aluminum, coated
- E Dual compartment housing, L-shaped, aluminum, coated
- 1 Cable entry
- 2 Dummy plug

The number and type of cable entries depend on the device version ordered.

**i** Always route connecting cables downwards so that moisture cannot penetrate the connection compartment.

If necessary, create a drip loop or use a weather protection cover.

## 12.2.7 Available device plug connectors



In the case of devices with a plug, it is not necessary to open the housing for connection purposes.

Use the enclosed seals to prevent the penetration of moisture into the device.

## 12.3 Ensuring the degree of protection

### 12.3.1 Cable entries

- M20 coupling, plastic, IP66/68 NEMA TYPE 4X/6P
  - M20 coupling, nickel-plated brass, IP66/68 NEMA TYPE 4X/6P
  - M20 coupling, 316L, IP66/68 NEMA TYPE 4X/6P
  - M20 thread, IP66/68 NEMA Type 4X/6P
  - G1/2 thread, IP66/68 NEMA Type 4X/6P
- If the G1/2 thread is selected, the device is delivered with an M20 thread as standard and a G1/2 adapter is included with the delivery, along with the corresponding documentation
- NPT 1/2 thread, IP66/68 NEMA Type 4X/6P
  - Dummy plug transport protection: IP22, NEMA TYPE 2
  - M12 plug
    - When housing is closed and connecting cable is plugged in: IP66/67, NEMA Type 4X
    - When housing is open or connecting cable is not plugged in: IP20, NEMA Type 1

### NOTICE

#### **M12 plug: Loss of IP protection class due to incorrect installation!**

- ▶ The degree of protection only applies if the connecting cable used is plugged in and screwed tight.
- ▶ The degree of protection only applies if the connecting cable used is specified according to IP67, NEMA Type 4X.
- ▶ The IP protection classes are only maintained if the dummy cap is used or the cable is connected.

## 12.4 Post-connection check

- Are the device or cables undamaged (visual inspection)?
- Do the cables used comply with the requirements?
- Do the mounted cables have strain relief?
- Cable glands mounted, securely tightened and leak-tight?
- Does the supply voltage correspond to the specifications on the nameplate?
- No reverse polarity, terminal assignment correct?
- Cover screwed down correctly?
- Cover lock tightened correctly?

## 13 Operation options

### 13.1 Overview of operation options

- Operation via operating keys and DIP switches on the electronic insert
- Operation via optical operating keys on the device display (optional)
- Operation via Bluetooth® wireless technology (with optional device display with Bluetooth) with SmartBlue app or FieldXpert, DeviceCare
- Operation via Web server
- Operation via operating tool (Endress+Hauser FieldCare/DeviceCare) or FDI Hosts (e.g., PDM)

### 13.2 Operating keys and DIP switches on the electronic insert

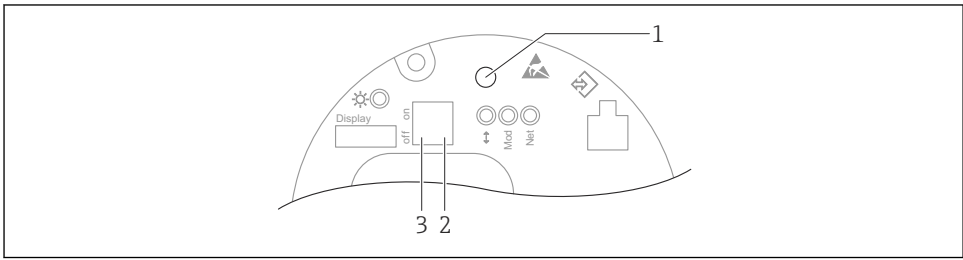

A0046061

#### 6 Operating keys and DIP switches on the Ethernet-APL electronic insert

- 1 Operating key for Reset password and Reset device
- 2 DIP switch for setting the service IP address
- 3 DIP switch for locking and unlocking the device

 The setting of the DIP switches on the electronic insert has priority over the settings made via other operation methods (e.g. FieldCare/DeviceCare).

### 13.3 Structure and function of the operating menu

The differences between the structure of the operating menus of the local display and the Endress+Hauser FieldCare or DeviceCare operating tools can be summarized as follows:

The local display is suitable for configuring simple applications.

The operating tools (FieldCare, DeviceCare, SmartBlue, AMS, PDM, etc.) can be used to configure the parameters of wide-ranging applications.

More elaborate applications can be configured with the Web server.

Wizards help the user to commission the various applications. The user is guided through the individual configuration steps.

### 13.3.1 User roles and related access authorization

The two user roles **Operator** and **Maintenance** (as-delivered state) have different write access to the parameters if a device-specific access code has been defined. This access code protects the device configuration from unauthorized access.

If an incorrect access code is entered, the user obtains the access rights of the **Operator** role.

## 13.4 Access to operating menu via local display

### 13.4.1 Device display (optional)

Possible to operate the optical operating keys through the cover. No need to open the device.

Functions:

- Display of measured values and fault and notice messages
- Background lighting, which switches from green to red in the event of an error
- The device display can be removed for easier operation



Backlighting is switched on or off depending on the supply voltage and the current consumption.





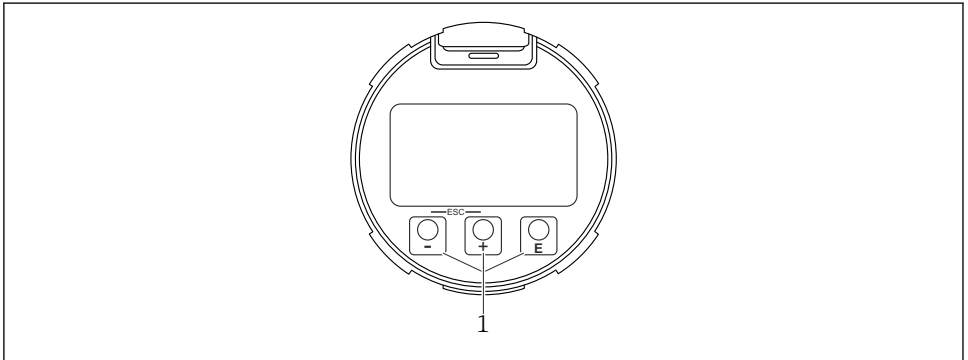



The device display is also optionally available with Bluetooth® wireless technology.



A0039284

 7 *Graphic display with optical operating keys (1)*

- Key 
  - Navigate downwards in the picklist
  - Edit the numerical values or characters within a function
- Key 
  - Navigate upwards in the picklist
  - Edit the numerical values or characters within a function
- Key 
  - Change from main display to main menu
  - Confirm entry
  - Jump to the next item
  - Select a menu item and activate the edit mode
  - Unlock/lock the display operation
  - Press and hold the  key to display a short description of the selected parameter (if available)
-  key and  key (ESC function)
  - Exit edit mode for a parameter without saving the changed value
  - Menu at a selection level: pressing the keys simultaneously takes the user back up a level in the menu
  - Press and hold the keys simultaneously to return to the upper level

### 13.4.2 Operation via Bluetooth® wireless technology (optional)

#### Prerequisite

- Device with device display including Bluetooth
- Smartphone or tablet with Endress+Hauser SmartBlue app or PC with DeviceCare from version 1.07.05 or FieldXpert SMT70

The connection has a range of up to 25 m (82 ft). The range can vary depending on environmental conditions such as attachments, walls or ceilings.



The operating keys on the display are locked as soon as the device is connected via Bluetooth.

A flashing Bluetooth symbol indicates that a Bluetooth connection is available.



#### Please note the following

If the Bluetooth display is removed from one device and installed in another device:

- All the log-in data are only saved in the Bluetooth display and not in the device
- The password changed by the user is also saved in the Bluetooth display

### Operation via SmartBlue app

The device can be operated and configured with the SmartBlue app.

- The SmartBlue app must be downloaded onto a mobile device for this purpose.
- For information on the compatibility of the SmartBlue app with mobile devices, see **Apple App Store (iOS devices)** or **Google Play Store (Android devices)**.
- Incorrect operation by unauthorized persons is prevented by means of encrypted communication and password encryption.
- The Bluetooth® function can be deactivated after initial device setup.





A0033202

## 8 QR code for free Endress+Hauser SmartBlue app

Download and installation:

1. Scan the QR code or enter **SmartBlue** in the search field of the Apple App Store (iOS) or Google Play Store (Android).
2. Install and start the SmartBlue app.
3. For Android devices: enable location tracking (GPS) (not required for iOS devices).
4. Select a device that is ready to receive from the device list displayed.

Login:

1. Enter the user name: admin
2. Enter the initial password: serial number of the device
3. Change the password after logging in for the first time.



### Notes on the password and reset code

- If the user-defined password is lost, access can be restored via a reset code. The reset code is the device serial number in reverse. Once the reset code has been entered, the Initial password is valid again.
- Like the password, the reset code can also be changed.
- If the user-defined reset code is lost, the password can no longer be reset via the SmartBlue app. In this case, contact Endress+Hauser Service.

## 13.5 Access to operating menu via web browser

### 13.5.1 Function scope

Thanks to the integrated Web server the device can be operated and configured via a Web browser. The structure of the operating menu is the same as for the local display. In addition to the measured values, device status information is also displayed and allows users to monitor the status of the device. Furthermore the device data can be managed and the network parameters can be configured.

## 13.5.2 Prerequisites

### Computer software

#### *Recommended operating systems*

- Microsoft Windows 7 or higher.
- Mobile operating systems:
  - iOS
  - Android



Microsoft Windows XP is supported.

#### *Web browsers supported*

- Microsoft Internet Explorer 8 or higher
- Microsoft Edge
- Mozilla Firefox
- Google Chrome
- Safari

### Computer settings

#### *User rights*

Corresponding user rights (e.g., administrator rights) for TCP/IP and proxy server settings are required (for changing the IP address, subnet mask etc.).

#### *Proxy server settings of the web browser*

The web browser *Use proxy server for LAN* setting must be **disabled**.

#### *JavaScript*

JavaScript must be enabled.



When installing a new firmware version: To enable correct data display, clear the temporary memory (cache) of the web browser under **Internet options**.

## 13.5.3 Establishing a connection

### Starting the Web browser and logging in

1. Start the Web browser on the computer.
2. Enter the IP address of the device in the address line of the Web browser
  - ↳ The login page appears.

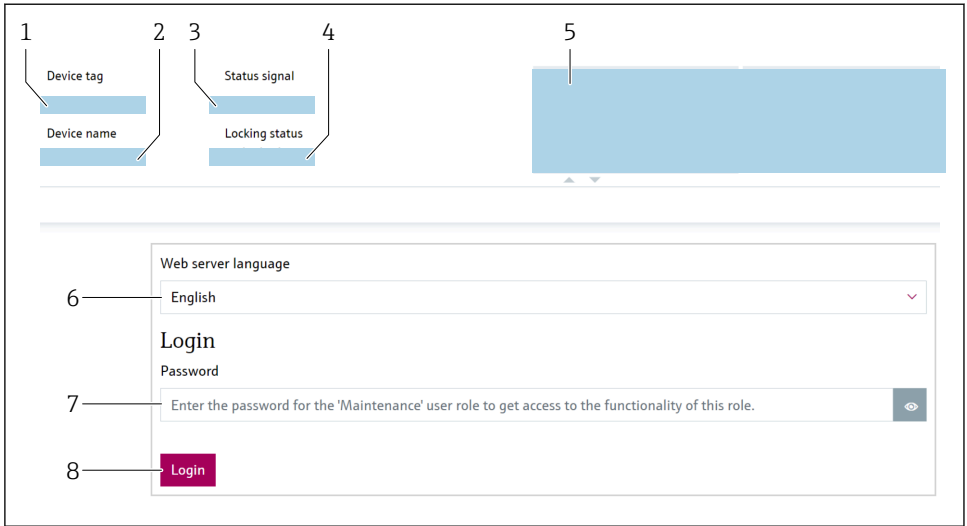

A0046626

### 9 Web browser login

- 1 Device tag
- 2 Device name
- 3 Status signal
- 4 Locking status
- 5 Current measured values
- 6 Select the language
- 7 Enter the "Password" parameter
- 8 Login

1. Select the preferred **Language** parameter for the Web browser.
2. Enter the **Password** parameter (factory setting 0000).
3. Confirm entry with Login .

### 13.5.4 User interface

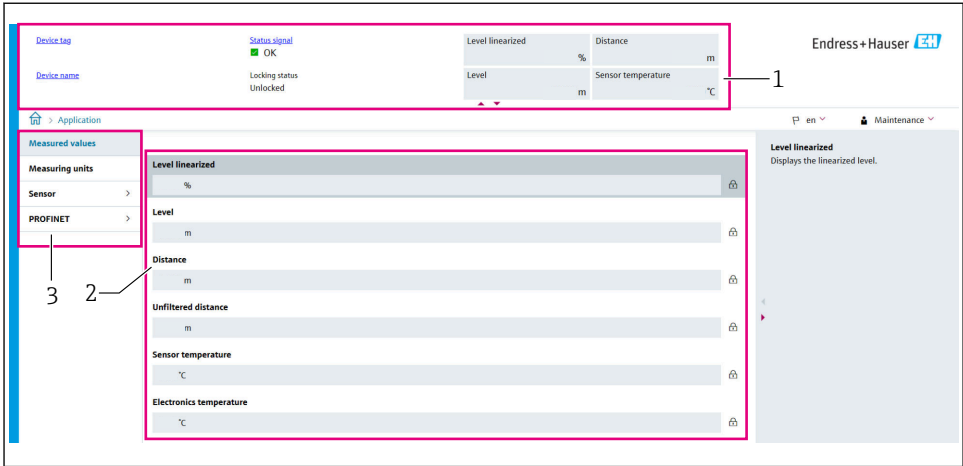

A0052432

10 User interface with sample contents

- 1 Header
- 2 Working area
- 3 Navigation area

#### Header

The following information appears in the header:

- Device tag
- Device name
- Status signal
- Locking status
- Current measured values

#### Navigation area

If a function is selected in the function bar, the submenus of the function open in the navigation area. The user can now navigate within the menu structure.

#### Working area

Depending on the selected function and the related submenus, various actions can be performed in this area:

- Configure parameters
- Read measured values
- Call up help text

## Adopting a value

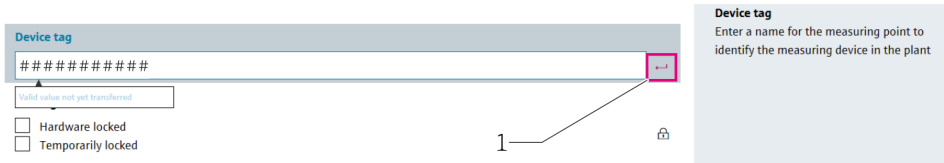

11 Example of Enter button

1 Enter button in the operating tool

The value entered is only adopted by pressing the Enter key or clicking on the Enter button (1).

### 13.5.5 Disabling the Web server

The Web server of the measuring device can be switched on and off as required using the **Web server functionality** parameter.

#### Navigation

"System" menu → Connectivity → Interfaces

#### Parameter overview with brief description

Parameter	Description	Selection
Web server functionality	Switch web server on and off, switch off HTML.	<ul style="list-style-type: none"> <li>■ Disable</li> <li>■ Enable</li> </ul>

#### Range of functions of "Web server functionality" parameter

Option	Description
Disable	<ul style="list-style-type: none"> <li>■ The Web server is completely disabled.</li> <li>■ Port 80 is locked.</li> </ul>
Enable	<ul style="list-style-type: none"> <li>■ The complete functionality of the Web server is available.</li> <li>■ JavaScript is used.</li> <li>■ The password is transferred in an encrypted state.</li> <li>■ Any change to the password is also transferred in an encrypted state.</li> </ul>

#### Enabling the Web server

If the Web server is disabled, it can only be re-enabled with the **Web server functionality** parameter via the following operating options:

- Via local display
- Via the "FieldCare" operating tool
- Via the "DeviceCare" operating tool
- Via the PROFINET startup record

### 13.5.6 Logging out

1. Select the **Logout** entry in the function bar.
  - ↳ The home page with the Login box appears.
2. Close the Web browser.

**i** Once communication with the Web server is established via the standard IP address 192.168.1.212, the DIP switch must be reset (from **ON** → **OFF**). Following a reboot, the configured IP address of the device is once again active for network communication.

## 13.6 Access to the operating menu via the operating tool

The structure of the operating menu in the operating tools is the same as for operation via the local display. The range of functions is different however.

### 13.6.1 Connecting the operating tool

#### Service interface

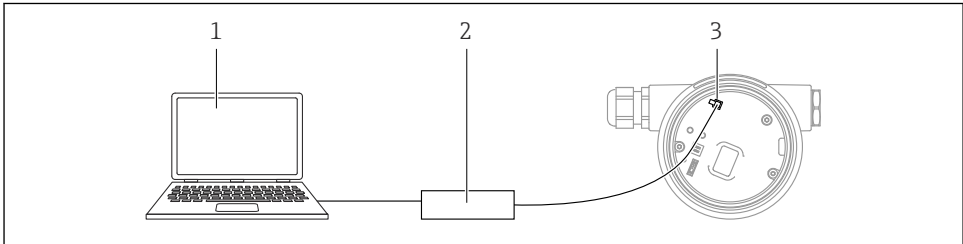

A0039148

- 1 Computer with FieldCare/DeviceCare operating tool
- 2 Commubox FXA291
- 3 Service interface (CDI) of the device (= Endress+Hauser Common Data Interface)

**i** To update (flash) the device firmware, the device must be powered via the power supply terminals.

## 13.7 FieldCare

### 13.7.1 Function range

FDT-based plant asset management tool from Endress+Hauser. FieldCare can configure all smart field devices in a system and helps you manage them. By using the status information, FieldCare is also a simple but effective way of checking their status and condition.

Access is via:

- CDI service interface
- HART communication

Typical functions:

- Configuration of transmitter parameters
- Loading and saving of device data (upload/download)
- Documentation of the measuring point
- Visualization of the measured value memory (line recorder) and event logbook



For additional information about FieldCare, see Operating Instructions BA00027S and BA00059S

## 13.8 DeviceCare

### 13.8.1 Function scope

Tool for connecting and configuring Endress+Hauser field devices.

The fastest way to configure Endress+Hauser field devices is with the dedicated "DeviceCare" tool. Together with the device type managers (DTMs), DeviceCare presents a convenient, comprehensive solution.



For details, see Innovation Brochure IN01047S

## 14 Commissioning



All configuration tools provide a commissioning assistant that supports the user when setting the most important configuration parameters (**Guidance** menu **Commissioning** wizard).

### 14.1 Preliminaries

The measuring range and the unit in which the measured value is transmitted correspond to the data on the nameplate.

### 14.2 Installation and function check

Before commissioning the measuring point, check whether the post-installation and post-connection checks have been performed.

Post-mounting check

Post-connection check

## 14.3 Connecting via FieldCare and DeviceCare

### 14.3.1 Via PROFINET protocol

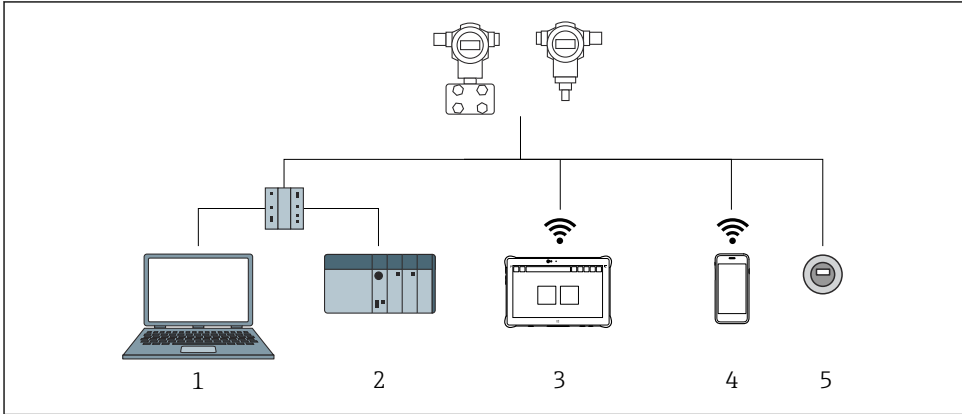

A0046623

▣ 12 Options for remote operation via PROFINET protocol

- 1 Computer with web browser or with operating tool (e.g., DeviceCare)
- 2 Automation system
- 3 Field Xpert SMT70
- 4 Mobile handheld terminal
- 5 Local operation via display module

### 14.3.2 Via service interface (CDI)

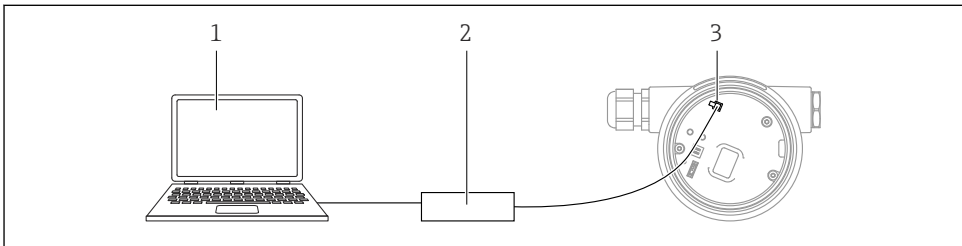

A0039146

- 1 Computer with FieldCare/DeviceCare operating tool
- 2 Commubox
- 3 Service interface (CDI) of the device (= Endress+Hauser Common Data Interface)



## 14.4 Configuring the operating language

### 14.4.1 Local display

#### Setting the operating language



To set the operating language, the display first needs to be unlocked:

1. Press the key for at least 2 s.
  - ↳ A dialog box appears.
2. Unlock the display operation.
3. Select the **Language** parameter in the main menu.
4. Press the key.
5. Select the desired language with the or key.
6. Press the key.



Display operation locks automatically (except in the **Safety mode** wizard):

- after 1 min on the main page if no key has been pressed
- after 10 min within the operating menu if no key has been pressed

### 14.4.2 Operating tool

Set display language

System → Display → Language

Selection in **Language** parameter; Visibility depends on order options or device settings

### 14.4.3 Web server

The screenshot displays the 'Measured values' section of the web server interface. The top navigation bar includes the 'Endress+Hauser' logo and a 'Maintenance' dropdown menu. The main content area shows a table of measured values with columns for 'Measuring Units', 'Sensor', and 'PROFINET'. The 'Pressure' sensor is highlighted, showing a value of 987.77 mbar and a scaled variable of 49.39 mm. The 'Sensor temperature' is also visible, showing 23.5 °C. A 'Language' dropdown menu is open, showing 'en' selected.

Measuring Units	Sensor	PROFINET
32.3 °C	Pressure	
987.77 mbar	987.77 mbar	
49.39 mm	Scaled variable	
23.5 °C	Sensor temperature	

A0046882

#### 1 Language setting

## 14.5 Configuring the device

### 14.5.1 Level measurement in liquids

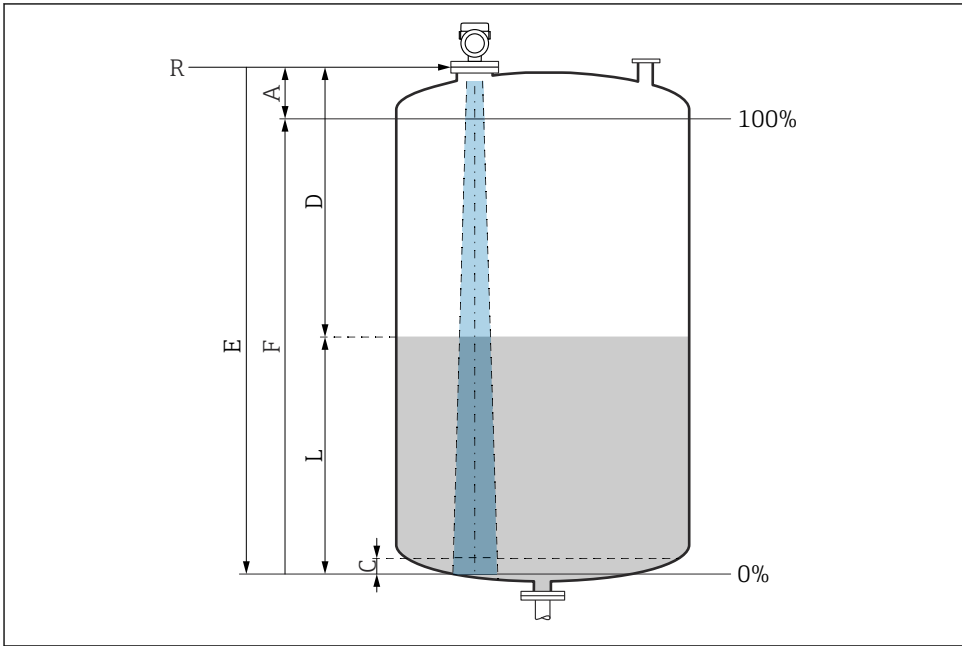

A0016933

#### 13 Configuration parameters for level measurement in liquids

- R Reference point of measurement
- A Length of antenna + 10 mm (0.4 in)
- C 50 to 80 mm (1.97 to 3.15 in); medium  $\epsilon_r < 2$
- D Distance
- L Level
- E "Empty calibration" parameter (= 0 %)
- F "Full calibration" parameter (= 100 %)

In the case of media with a low dielectric constant,  $\epsilon_r < 2$ , the tank floor may be visible through the medium at very low levels (lower than level C). Reduced accuracy must be expected in this range. If this is not acceptable, the zero point should be positioned at a distance C above the tank floor in these applications →  Configuration parameters for level measurement in liquids.

### 14.5.2 Commissioning with the Commissioning wizard

In FieldCare, DeviceCare, SmartBlue and on the display, the **Commissioning** wizard is available to guide the user through the initial commissioning steps.

Complete this wizard to commission the device.

For each parameter, enter the appropriate value or select the appropriate option.

#### NOTE

If you exit the wizard before completing all required parameters, the changes you have made will be saved. For this reason, the device may then be in an undefined state!

In this case, a reset to the default settings is recommended.



71687757

[www.addresses.endress.com](http://www.addresses.endress.com)

---