

Operating Instructions

Micropilot FMR63B

PROFIBUS PA

Free-space radar





A0023555

- Make sure the document is stored in a safe place such that it is always available when working on or with the device
- Avoid danger to individuals or the facility: read the "Basic safety instructions" section carefully, as well as all other safety instructions in the document that are specific to working procedures

The manufacturer reserves the right to modify technical data without prior notice. The Endress+Hauser sales organization will supply you with current information and updates to these instructions.

Table of contents

1	About this document	5		
1.1	Purpose of this document	5		
1.2	Symbols	5		
1.2.1	Safety symbols	5		
1.2.2	Symbols for certain types of information and graphics	5		
1.3	List of abbreviations	6		
1.4	Documentation	6		
1.5	Registered trademarks	6		
2	Basic safety instructions	8		
2.1	Requirements for the personnel	8		
2.2	Intended use	8		
2.3	Workplace safety	9		
2.4	Operational safety	9		
2.5	Product safety	9		
2.6	IT security	9		
2.7	Device-specific IT security	9		
3	Product description	10		
3.1	Product design	10		
4	Incoming acceptance and product identification	11		
4.1	Incoming acceptance	11		
4.2	Product identification	11		
4.2.1	Nameplate	11		
4.2.2	Manufacturer address	12		
4.3	Storage and transport	12		
4.3.1	Storage conditions	12		
4.3.2	Transporting the product to the measuring point	12		
5	Installation	13		
5.1	General instructions	13		
5.2	Installation requirements	13		
5.2.1	Internal vessel fittings	13		
5.2.2	Avoiding interference echoes	14		
5.2.3	Vertical alignment of antenna axis	14		
5.2.4	Radial alignment of the antenna	14		
5.2.5	Optimization options	14		
5.3	Mounting the device	14		
5.3.1	Integrated antenna, PEEK 20 mm (0.75 in)	14		
5.3.2	Antenna, PTFE clad, flush mount 50 mm (2 in)	15		
5.3.3	Antenna, PTFE clad, flush mount 80 mm (3 in)	15		
5.3.4	Antenna, PEEK-clad, 20 mm (0.75 in) flush mount with NEUMO Bio Control D25	16		
5.3.5	Antenna, PEEK-clad, 40 mm (1.5 in) flush mount with NEUMO Bio Control D50	16		
5.3.6	Antenna, PEEK-clad, 40 mm (1.5 in) flush mount with Varivent N tube	17		
5.3.7	Turning the housing	17		
5.3.8	Turning the display module	18		
5.3.9	Changing the installation position of the display module	18		
5.3.10	Closing the housing covers	20		
5.4	Post-mounting check	20		
6	Electrical connection	21		
6.1	Connecting requirements	21		
6.1.1	Cover with securing screw	21		
6.1.2	Potential equalization	21		
6.2	Connecting the device	22		
6.2.1	Supply voltage	22		
6.2.2	Cable specification	23		
6.2.3	Overvoltage protection	23		
6.2.4	Wiring	24		
6.2.5	Terminal assignment	25		
6.2.6	Cable entries	26		
6.2.7	Available device plugs	26		
6.3	Ensuring the degree of protection	26		
6.3.1	Cable entries	26		
6.4	Post-connection check	27		
7	Operation options	28		
7.1	Overview of operation options	28		
7.2	Operating keys and DIP switches on the PROFIBUS PA electronic insert	28		
7.2.1	Hardware addressing	28		
7.2.2	Software addressing	29		
7.3	Structure and function of the operating menu	29		
7.3.1	User roles and related access authorization	29		
7.4	Access to operating menu via local display	29		
7.4.1	Device display (optional)	29		
7.4.2	Operation via Bluetooth® wireless technology (optional)	30		
7.5	Access to the operating menu via the operating tool	31		
7.6	DeviceCare	31		
7.6.1	Function scope	31		
7.7	FieldCare	32		
7.7.1	Function range	32		
8	System integration	33		
8.1	Protocol-specific data	33		
8.1.1	PROFIBUS PA	33		

8.2	Device master file (GSD)	34	11.9	Device information	53
8.2.1	Manufacturer-specific GSD	34	11.10	Firmware history	53
8.2.2	Profile GSD	34			
8.2.3	Compatibility with other devices	35	12	Maintenance	53
8.3	Cyclic data transmission	35	12.1	Cleaning	54
8.3.1	Block model	35	12.1.1	Cleaning of surfaces not in contact with the medium	54
8.3.2	Description of the modules	36	12.1.2	Cleaning of surfaces in contact with the medium	54
9	Commissioning	39	12.2	Seals	54
9.1	Preliminaries	39	13	Repair	55
9.2	Installation and function check	39	13.1	General information	55
9.3	Connecting via FieldCare and DeviceCare	39	13.1.1	Repair concept	55
9.3.1	Via PROFIBUS PA protocol	39	13.1.2	Repairs to Ex-approved devices	55
9.3.2	Via service interface (CDI)	40	13.2	Spare parts	55
9.4	Setting the operating language	40	13.3	Replacement	55
9.4.1	Local display	40	13.3.1	HistoROM	55
9.4.2	Operating tool	40	13.4	Return	56
9.5	Configuring the device	41	13.5	Disposal	56
9.5.1	Level measurement in liquids	41	14	Accessories	57
9.5.2	Commissioning with the Commissioning wizard	41	14.1	Weather protection cover: 316L, XW112	57
9.6	Recording the Echo curve	41	14.2	Weather protection cover, plastic, XW111	57
9.7	"Simulation" submenu	42	14.3	Remote display FHX50B	58
10	Operation	43	14.4	Gas-tight feedthrough	59
10.1	Reading off the device locking status	43	14.5	M24 process adapter	59
10.2	Reading off measured values	43	14.6	Field Xpert SMT70	59
10.3	Adapting the device to process conditions	43	14.7	DeviceCare SFE100	59
10.4	Heartbeat Technology (optional)	43	14.8	FieldCare SFE500	60
10.4.1	Heartbeat Verification	43	14.9	RID14	60
10.4.2	Heartbeat Verification/Monitoring	43	14.10	RID16	60
11	Diagnostics and troubleshooting	44	14.11	Fieldgate SFG500	61
11.1	General troubleshooting	44	15	Technical data	63
11.1.1	General errors	44	15.1	Input	63
11.2	Error - SmartBlue operation	44	15.2	Output	70
11.3	Diagnostic message	45	15.3	Environment	72
11.3.1	Diagnostic information on local display	46	15.4	Process	84
11.3.2	Diagnostic information in the operating tool	46	Index	87	
11.3.3	Status signal	46			
11.3.4	Diagnostic event and event text	47			
11.4	Remedy information Calling up	47			
11.4.1	Graphic display with keys	47			
11.4.2	Operating menu	48			
11.5	Adapting the diagnostic information	48			
11.6	List of diagnostic events	48			
11.7	Event logbook	50			
11.7.1	Event history	50			
11.7.2	Filtering the event logbook	51			
11.7.3	Overview of information events	51			
11.8	Resetting the device	52			
11.8.1	Reset password via operating tool	52			
11.8.2	Reset device via operating tool	52			
11.8.3	Resetting the device via keys on the electronic insert	52			

1 About this document

1.1 Purpose of this document

These Operating Instructions contain all the information that is required in the various phases of the life cycle of the device: from product identification, incoming acceptance and storage, to mounting, connection, operation and commissioning through to troubleshooting, maintenance and disposal.

1.2 Symbols

1.2.1 Safety symbols

DANGER

This symbol alerts you to a dangerous situation. Failure to avoid this situation will result in serious or fatal injury.

WARNING

This symbol alerts you to a dangerous situation. Failure to avoid this situation can result in serious or fatal injury.

CAUTION

This symbol alerts you to a dangerous situation. Failure to avoid this situation can result in minor or medium injury.

NOTICE

This symbol contains information on procedures and other facts which do not result in personal injury.

1.2.2 Symbols for certain types of information and graphics

Permitted

Procedures, processes or actions that are permitted

Forbidden

Procedures, processes or actions that are forbidden

Tip

Indicates additional information



Reference to documentation



Reference to page



Reference to graphic



Notice or individual step to be observed

1, 2, 3

Series of steps



Result of a step

1, 2, 3, ...

Item numbers

A, B, C, ...

Views

1.3 List of abbreviations

MWP

Maximum working pressure

The MWP is indicated on the nameplate.

ϵ_r (Dk value)

Relative dielectric constant

PLC

Programmable logic controller (PLC)

CDI

Common Data Interface

1.4 Documentation

 For an overview of the scope of the associated Technical Documentation, refer to the following:

- *Device Viewer* (www.endress.com/deviceviewer): Enter the serial number from the nameplate
- *Endress+Hauser Operations app*: Enter serial number from nameplate or scan matrix code on nameplate.

The following document types are available in the Downloads area of the Endress+Hauser website (www.endress.com/downloads), depending on the device version:

Document type	Purpose and content of the document
Technical Information (TI)	Planning aid for your device The document contains all the technical data on the device and provides an overview of the accessories and other products that can be ordered for the device.
Brief Operating Instructions (KA)	Guide that takes you quickly to the 1st measured value The Brief Operating Instructions contain all the essential information from incoming acceptance to initial commissioning.
Operating Instructions (BA)	Your reference document The Operating Instructions contain all the information that is required in various phases of the life cycle of the device: from product identification, incoming acceptance and storage, to mounting, connection, operation and commissioning through to troubleshooting, maintenance and disposal.
Description of Device Parameters (GP)	Reference for your parameters The document provides a detailed explanation of each individual parameter. The description is aimed at those who work with the device over the entire life cycle and perform specific configurations.
Safety instructions (XA)	Depending on the approval, safety instructions for electrical equipment in hazardous areas are also supplied with the device. These are an integral part of the Operating Instructions.  The nameplate indicates which Safety Instructions (XA) apply to the device.
Supplementary device-dependent documentation (SD/FY)	Always comply strictly with the instructions in the relevant supplementary documentation. The supplementary documentation is a constituent part of the device documentation.

1.5 Registered trademarks

PROFIBUS®

PROFIBUS and the associated trademarks (The Association Trademark, the Technology Trademarks, the Certification Trademark and the Certified by PI Trademark) are registered

trademarks of the PROFIBUS User Organization e.V. (Profibus User Organization), Karlsruhe - Germany

Bluetooth®

The *Bluetooth*® word mark and logos are registered trademarks owned by the Bluetooth SIG, Inc. and any use of such marks by Endress+Hauser is under license. Other trademarks and trade names are those of their respective owners.

Apple®

Apple, the Apple logo, iPhone, and iPod touch are trademarks of Apple Inc., registered in the U.S. and other countries. App Store is a service mark of Apple Inc.

Android®

Android, Google Play and the Google Play logo are trademarks of Google Inc.

KALREZ®, VITON®

Registered trademarks of DuPont Performance Elastomers L.L.C., Wilmington, DE USA

TRI-CLAMP®

Registered trademark of Ladish & Co., Inc., Kenosha, USA

2 Basic safety instructions

2.1 Requirements for the personnel

The personnel for installation, commissioning, diagnostics and maintenance must fulfill the following requirements:

- ▶ Trained, qualified specialists must have a relevant qualification for this specific function and task.
- ▶ Are authorized by the plant owner/operator.
- ▶ Are familiar with federal/national regulations.
- ▶ Before starting work, read and understand the instructions in the manual and supplementary documentation as well as the certificates (depending on the application).
- ▶ Follow instructions and comply with basic conditions.

The operating personnel must fulfill the following requirements:

- ▶ Are instructed and authorized according to the requirements of the task by the facility's owner-operator.
- ▶ Follow the instructions in this manual.

2.2 Intended use

Application and media

The measuring device described in these Operating Instructions is intended for continuous, non-contact level measurement in liquids, pastes and sludges. The operating frequency is approx. 80 GHz with a maximum emitted peak power of <1.5 mW and an average power output of <70 μ W. Operation does not pose any danger whatsoever to humans and animals.

If the limit values specified in the "Technical data" and the conditions listed in the instructions and additional documentation are observed, the measuring device may be used only for the following measurements:

- ▶ Measured process variables: level, distance, signal strength
- ▶ Calculable process variables: volume or mass in any shape of vessel

To ensure that the measuring device remains in proper condition for the operation time:

- ▶ Use the measuring device only for media to which the process-wetted materials are sufficiently resistant.
- ▶ Observe the limit values in the "Technical data".

Incorrect use

The manufacturer is not liable for damage caused by improper or non-intended use.

Avoid mechanical damage:

- ▶ Do not touch or clean device surfaces with pointed or hard objects.

Clarification of borderline cases:

- ▶ For special fluids and fluids for cleaning, Endress+Hauser is glad to provide assistance in verifying the corrosion resistance of fluid-wetted materials, but does not accept any warranty or liability.

Residual risks

Due to heat transfer from the process as well as power loss in the electronics, the temperature of the electronics housing and the assemblies it contains (e.g. display module, main electronics module and I/O electronics module) may rise to 80 °C (176 °F). When in operation, the sensor can reach a temperature close to the medium temperature.

Danger of burns from contact with surfaces!

- ▶ In the event of elevated fluid temperatures, ensure protection against contact to prevent burns.

2.3 Workplace safety

When working on and with the device:

- ▶ Wear the required personal protective equipment according to federal/national regulations.
- ▶ Switch off the supply voltage before connecting the device.

2.4 Operational safety

Damage to the device!

- ▶ Operate the device in proper technical condition and fail-safe condition only.
- ▶ The operator is responsible for the interference-free operation of the device.

Modifications to the device

Unauthorized modifications to the device are not permitted and can lead to unforeseeable dangers!

- ▶ If modifications are nevertheless required, consult with the manufacturer.

Repair

To ensure continued operational safety and reliability:

- ▶ Carry out repairs on the device only if they are expressly permitted.
- ▶ Observe federal/national regulations pertaining to the repair of an electrical device.
- ▶ Use only original spare parts and accessories.

2.5 Product safety

This measuring device is designed in accordance with good engineering practice to meet state-of-the-art safety requirements, has been tested, and left the factory in a condition in which it is safe to operate.

It meets general safety standards and legal requirements. It also complies with the EU directives listed in the device-specific EU Declaration of Conformity. The manufacturer confirms this by affixing the CE mark to the device.

2.6 IT security

The manufacturer warranty is valid only if the product is installed and used as described in the Operating Instructions. The product is equipped with security mechanisms to protect it against any inadvertent changes to the settings.

IT security measures, which provide additional protection for the product and associated data transfer, must be implemented by the operators themselves in line with their security standards.

2.7 Device-specific IT security

The device offers specific functions to support protective measures by the operator. These functions can be configured by the user and guarantee greater in-operation safety if used correctly. An overview of the most important functions is provided in the following section:

- Write protection via hardware write protection switch
- Access code (applies for operation via display, Bluetooth or FieldCare, DeviceCare, PDM)

3 Product description

3.1 Product design

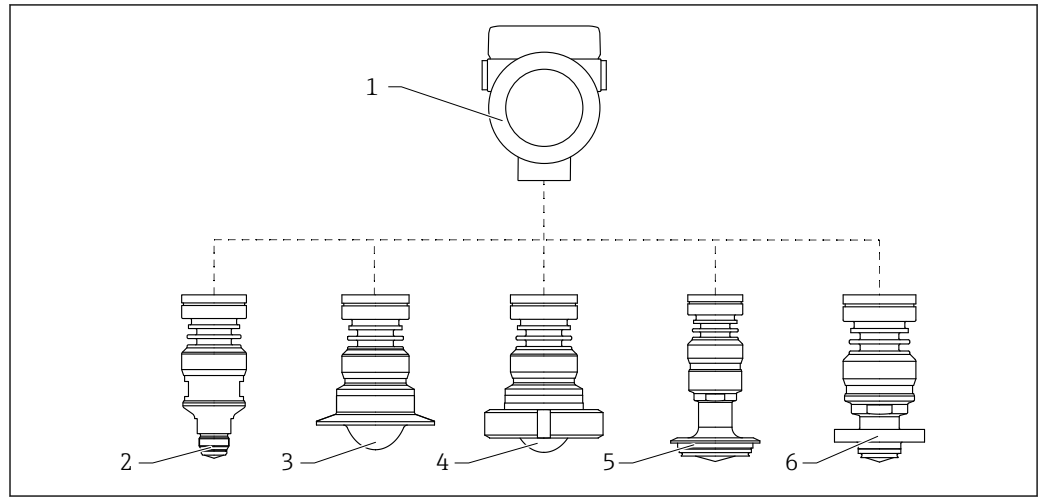

A0046663

1 Design of the Micropilot FMR63B

- 1 Electronics housing
- 2 Integrated antenna, PEEK, M24 process connection thread
- 3 Antenna, cladded flush mount, PTFE, Tri-Clamp ISO2852
- 4 Antenna, cladded flush mount, PTFE, slotted nut DIN11851
- 5 Antenna cladded flush mount, PEEK, Varivent N tube DN65-162
- 6 Antenna cladded flush mount, PEEK, NEUMO BioControl

4 Incoming acceptance and product identification

4.1 Incoming acceptance

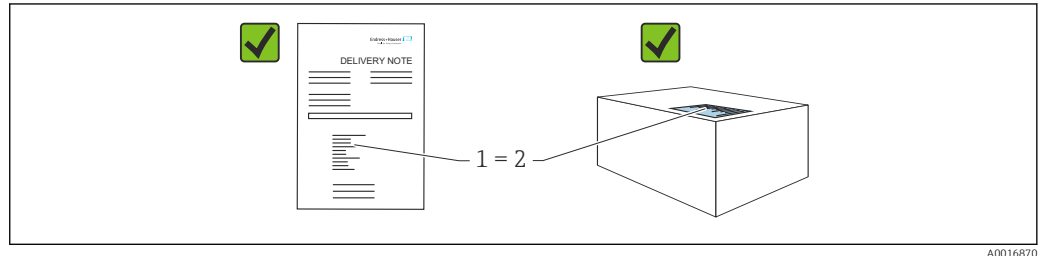

Check the following during incoming acceptance:

- Is the order code on the delivery note (1) identical to the order code on the product sticker (2)?
- Are the goods undamaged?
- Do the data on the nameplate correspond to the order specifications and the delivery note?
- Is the documentation provided?
- If required (see nameplate): are the Safety Instructions (XA) provided?



If one of these conditions is not met, please contact the manufacturer's sales office.

4.2 Product identification

The following options are available for identification of the device:

- Nameplate specifications
- Extended order code with breakdown of the device features on the delivery note
- ▶ *Device Viewer* (www.endress.com/deviceviewer); manually enter the serial number from the nameplate.
 - ↳ All the information about the measuring device is displayed.
- ▶ *Endress+Hauser Operations app*; manually enter the serial number indicated on the nameplate or scan the 2D matrix code on the nameplate.
 - ↳ All the information about the measuring device is displayed.

4.2.1 Nameplate

Do you have the correct device?

The nameplate provides you with the following information on the device:

- Manufacturer identification, device designation
- Order code
- Extended order code
- Serial number
- Tag name (TAG) (optional)
- Technical values, e.g. supply voltage, current consumption, ambient temperature, communication-specific data (optional)
- Degree of protection
- Approvals with symbols
- Reference to Safety Instructions (XA) (optional)
- ▶ Compare the information on the nameplate with the order.

4.2.2 Manufacturer address

Endress+Hauser SE+Co. KG
Hauptstraße 1
79689 Maulburg, Germany
Place of manufacture: See nameplate.

4.3 Storage and transport

4.3.1 Storage conditions

- Use the original packaging
- Store the device in clean and dry conditions and protect from damage caused by shocks

Storage temperature range

See Technical Information.

4.3.2 Transporting the product to the measuring point

WARNING

Incorrect transport!

The housing or sensor can be damaged or pull off. Risk of injury!

- ▶ Transport the device to the measuring point in its original packaging or by the process connection.
- ▶ Always secure lifting equipment (slings, eyes, etc.) at the process connection and never lift the device by the electronic housing or sensor. Pay attention to the center of gravity of the device so that it does not tilt or slip unintentionally.

5 Installation

5.1 General instructions

⚠ WARNING

Loss of protection rating if the device is opened in a wet environment.

- ▶ Only open the device in a dry environment!

1. Install the device or turn the housing so that the cable entries do not point upwards.

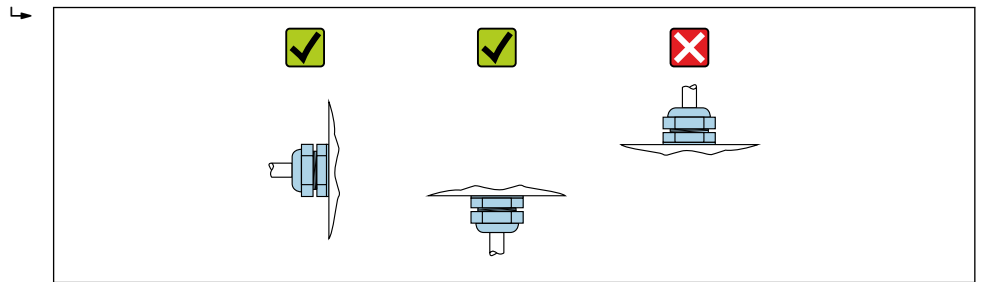

A0029263

2. Always firmly tighten the housing cover and the cable entries.
3. Counter-tighten the cable entries.
4. A drip loop must be provided when laying the cables.

5.2 Installation requirements

5.2.1 Internal vessel fittings

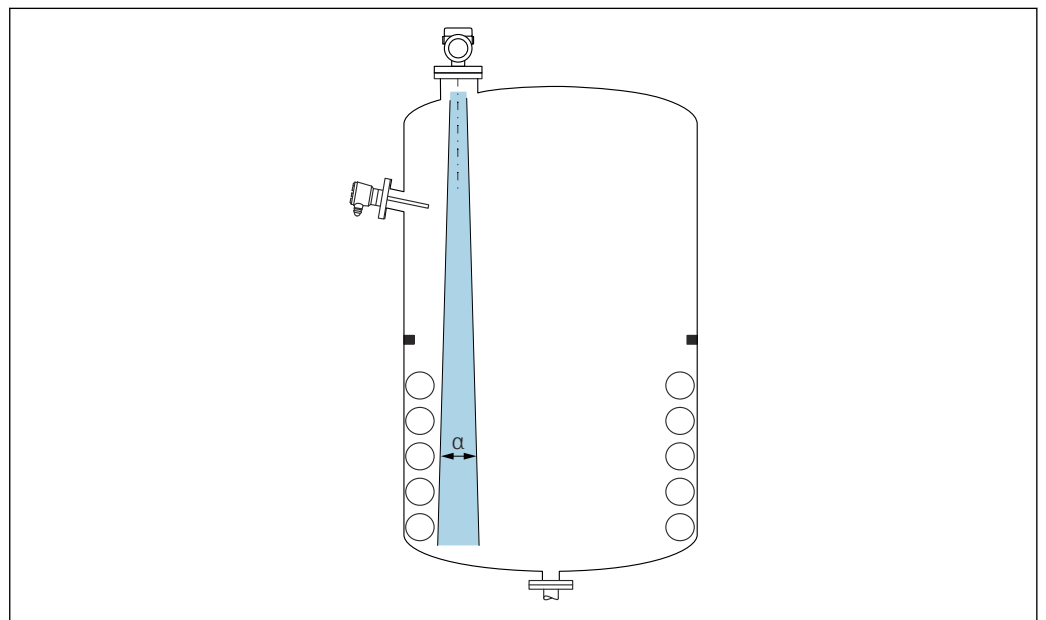

A0031777

Avoid internal fittings (level switches, temperature sensors, struts, vacuum rings, heating coils, baffles etc.) inside the signal beam. Pay attention to the beam angle α .

5.2.2 Avoiding interference echoes

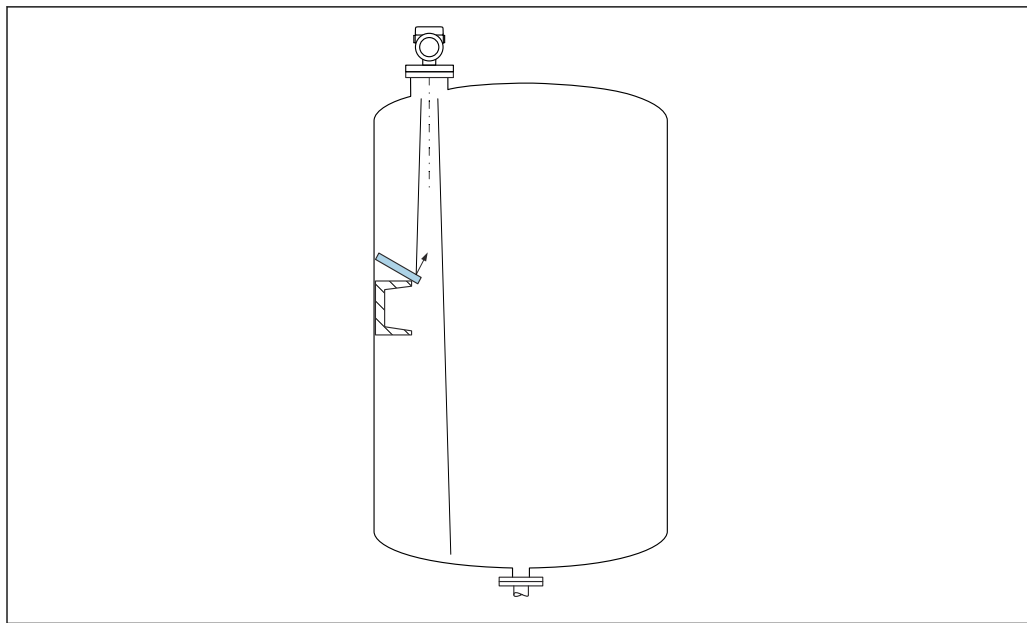

Metal deflector plates, installed at an angle to scatter the radar signals, help prevent interference echoes.

5.2.3 Vertical alignment of antenna axis

Align the antenna so that it is perpendicular to the product surface.

i The maximum reach of the antenna can be reduced, or additional interference signals can occur, if the antenna is not installed perpendicular to the product.

5.2.4 Radial alignment of the antenna

Based on the directional characteristic, radial alignment of the antenna is not necessary.

5.2.5 Optimization options

Mapping

Measurement can be optimized by electronically suppressing interference echoes. See the **Confirm distance** parameter.

5.3 Mounting the device

5.3.1 Integrated antenna, PEEK 20 mm (0.75 in)

Information concerning threaded connections

- When screwing in, turn by the hex bolt only.
- Tool: open-ended wrench 36 mm
- Maximum permissible torque: 50 Nm (36 lbf ft)

Information about the mounting nozzle

The maximum nozzle length H_{max} depends on the nozzle diameter D .

Maximum nozzle length H_{max} as a function of the nozzle diameter D

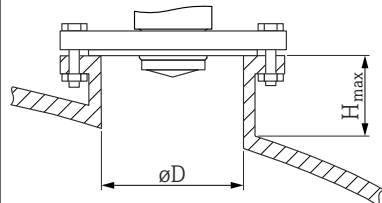
	ϕD	H_{max}
	40 to 50 mm (1.6 to 2 in)	200 mm (8 in)
	50 to 80 mm (2 to 3.2 in)	300 mm (12 in)
	80 to 100 mm (3.2 to 4 in)	450 mm (18 in)
	100 to 150 mm (4 to 6 in)	550 mm (22 in)
	≥ 150 mm (6 in)	850 mm (34 in)

- i** In the case of longer nozzles, reduced measuring performance must be expected. Please note the following:
- The end of the nozzle must be smooth and free from burrs.
 - The edge of the nozzle should be rounded.
 - Mapping must be performed.
 - Please contact the manufacturer's support department for applications with nozzles that are higher than indicated in the table.

5.3.2 Antenna, PTFE clad, flush mount 50 mm (2 in)

- i** The cladding on the antenna also acts as a process seal. An additional seal is not required for installation.

Information about the mounting nozzle

The maximum nozzle length H_{max} depends on the nozzle diameter D .

The maximum length of the nozzle H_{max} depends on the nozzle diameter D

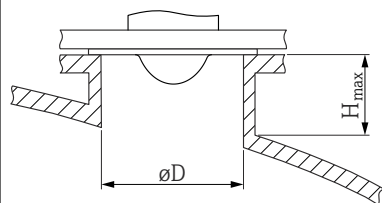
	ϕD	H_{max}
	50 to 80 mm (2 to 3.2 in)	600 mm (24 in)
	80 to 100 mm (3.2 to 4 in)	1 000 mm (40 in)
	100 to 150 mm (4 to 6 in)	1 250 mm (50 in)
	≥ 150 mm (6 in)	1 850 mm (74 in)

- i** In the case of longer nozzles, reduced measuring performance must be expected. Please note the following:
- The end of the nozzle must be smooth and free from burrs.
 - The edge of the nozzle should be rounded.
 - Mapping must be performed.
 - Please contact the manufacturer's support department for applications with nozzles that are higher than indicated in the table.

5.3.3 Antenna, PTFE clad, flush mount 80 mm (3 in)

- i** The cladding on the antenna also acts as a process seal. An additional seal is not required for installation.

Information about the mounting nozzle

The maximum nozzle length H_{max} depends on the nozzle diameter D .

The maximum length of the nozzle H_{max} depends on the nozzle diameter D

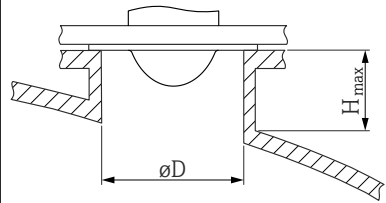
	ϕD	H_{max}
	80 to 100 mm (3.2 to 4 in)	1 750 mm (70 in)
	100 to 150 mm (4 to 6 in)	2 200 mm (88 in)
	≥ 150 mm (6 in)	3 300 mm (132 in)

i In the case of longer nozzles, reduced measuring performance must be expected.

Please note the following:

- The end of the nozzle must be smooth and free from burrs.
- The edge of the nozzle should be rounded.
- Mapping must be performed.
- Please contact the manufacturer's support department for applications with nozzles that are higher than indicated in the table.

5.3.4 Antenna, PEEK-cladded, 20 mm (0.75 in) flush mount with NEUMO Bio Control D25

Information about the mounting nozzle

The maximum nozzle length H_{max} depends on the nozzle diameter D .

Maximum nozzle length H_{max} depending on the nozzle diameter D

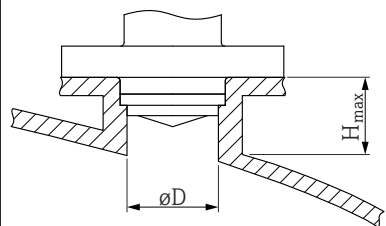
	ϕD	H_{max}
	40 to 50 mm (1.6 to 2 in)	200 mm (8 in)
	50 to 80 mm (2 to 3.2 in)	300 mm (12 in)
	80 to 100 mm (3.2 to 4 in)	450 mm (18 in)
	100 to 150 mm (4 to 6 in)	550 mm (22 in)
	≥ 150 mm (6 in)	850 mm (34 in)

i In the case of longer nozzles, reduced measuring performance must be expected.

Please note the following:

- The end of the nozzle must be smooth and free from burrs.
- The edge of the nozzle should be rounded.
- Mapping must be performed.
- Please contact the manufacturer's support department for applications with nozzles that are higher than indicated in the table.

5.3.5 Antenna, PEEK-cladded, 40 mm (1.5 in) flush mount with NEUMO Bio Control D50

Information about the mounting nozzle

The maximum nozzle length H_{max} depends on the nozzle diameter D .

Maximum nozzle length H_{max} depending on the nozzle diameter D

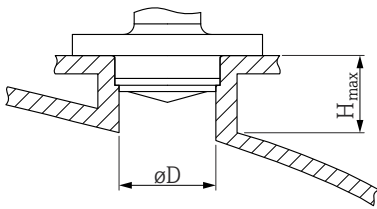
	$\varnothing D$	H_{max}
	40 to 50 mm (1.6 to 2 in)	400 mm (16 in)
	50 to 80 mm (2 to 3.2 in)	550 mm (22 in)
	80 to 100 mm (3.2 to 4 in)	850 mm (34 in)
	100 to 150 mm (4 to 6 in)	1050 mm (42 in)
	≥ 150 mm (6 in)	1600 mm (64 in)

- i** In the case of longer nozzles, reduced measuring performance must be expected. Please note the following:
- The end of the nozzle must be smooth and free from burrs.
 - The edge of the nozzle should be rounded.
 - Mapping must be performed.
 - Please contact the manufacturer's support department for applications with nozzles that are higher than indicated in the table.

5.3.6 Antenna, PEEK-cladded, 40 mm (1.5 in) flush mount with Varivent N tube

Information about the mounting nozzle

The maximum nozzle length H_{max} depends on the nozzle diameter D .

Maximum nozzle length H_{max} depending on the nozzle diameter D

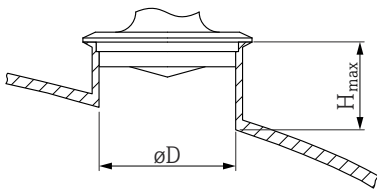
	$\varnothing D$	H_{max}
	40 to 50 mm (1.6 to 2 in)	400 mm (16 in)
	50 to 80 mm (2 to 3.2 in)	550 mm (22 in)
	80 to 100 mm (3.2 to 4 in)	850 mm (34 in)
	100 to 150 mm (4 to 6 in)	1050 mm (42 in)
	≥ 150 mm (6 in)	1600 mm (64 in)

- i** In the case of longer nozzles, reduced measuring performance must be expected. Please note the following:
- The end of the nozzle must be smooth and free from burrs.
 - The edge of the nozzle should be rounded.
 - Mapping must be performed.
 - Please contact the manufacturer's support department for applications with nozzles that are higher than indicated in the table.

5.3.7 Turning the housing

The housing can be rotated up to 380° by loosening the locking screw.

Your benefits

- Easy installation due to optimum alignment of housing
- Easily accessible device operation
- Optimum readability of the local display (optional)

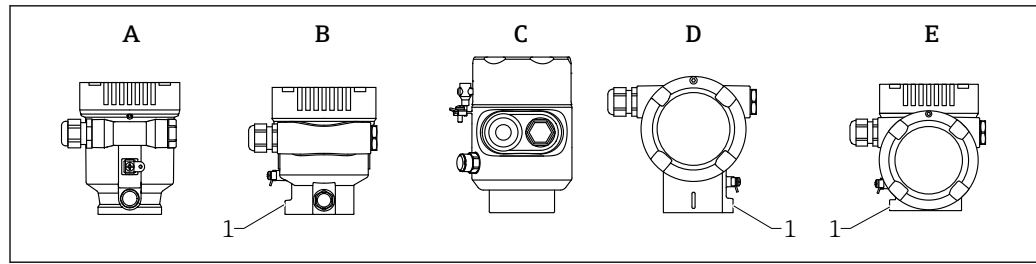

A0046660

- A Plastic single compartment housing (no locking screw)
 B Aluminum single compartment housing
 C Single compartment housing, 316L, hygiene (no locking screw)
 D Dual compartment housing
 E Dual compartment housing, L-form
 1 Locking screw

NOTICE

The housing cannot be unscrewed fully.

- ▶ Loosen the external locking screw by a maximum of 1.5 turns. If the screw is unscrewed too much or completely (beyond the screw anchor point), small parts (counter disk) can become loose and fall out.
- ▶ Tighten the securing screw (hexagon socket 4 mm (0.16 in)) with maximum 3.5 Nm (2.58 lbf ft) \pm 0.3 Nm (0.22 lbf ft).

5.3.8 Turning the display module

⚠ WARNING

Supply voltage switched on!

Risk of electric shock and/or explosion!

- ▶ Switch off the supply voltage before opening the measuring device.

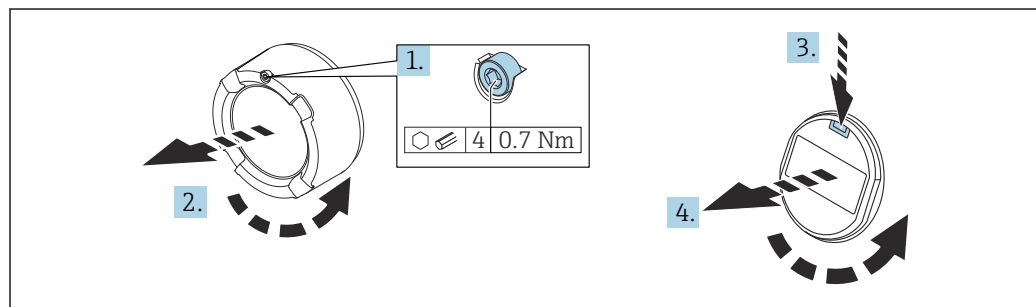

A0038224

1. If fitted: release the screw of the cover lock for the electronics compartment cover using the Allen key.
2. Unscrew the electronics compartment cover from the transmitter housing and check the cover seal.
3. Press the release mechanism and remove the display module.
4. Turn the display module to the desired position: maximum $4 \times 90^\circ$ in each direction. Fit the display module on the electronics compartment in the desired position until it clicks into place. Screw the electronics compartment cover back onto the transmitter housing. If fitted: tighten the screw of the cover lock using the Allen key 0.7 Nm (0.52 lbf ft) \pm 0.2 Nm (0.15 lbf ft).

5.3.9 Changing the installation position of the display module

The installation position of the display can be changed in the case of the dual compartment housing, L-form.

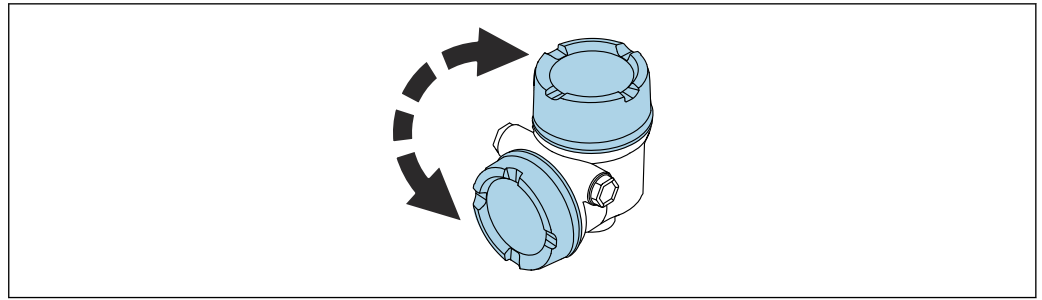

A0046401

⚠ WARNING

Supply voltage switched on!

Risk of electric shock and/or explosion!

- ▶ Switch off the supply voltage before opening the measuring instrument.

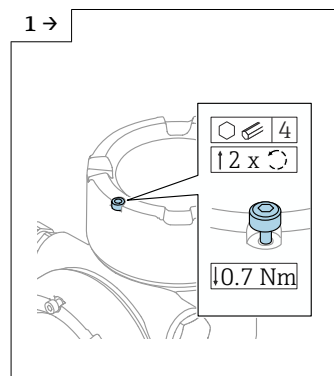

A0046831

- ▶ If fitted: release the screw of the cover lock for the display cover using the Allen key.

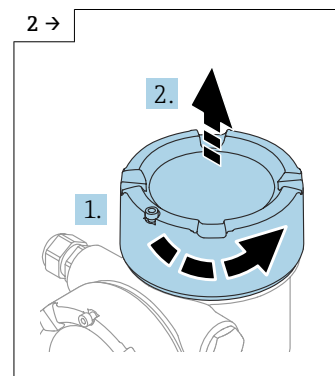

A0046832

- ▶ Unscrew the display cover and check the cover seal.

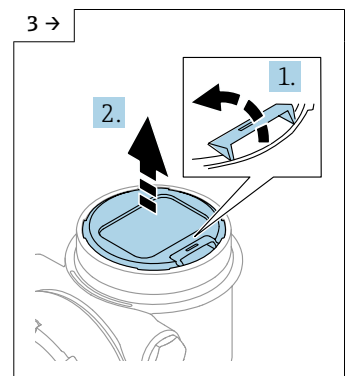

A0046833

- ▶ Press the release mechanism, remove the display module.

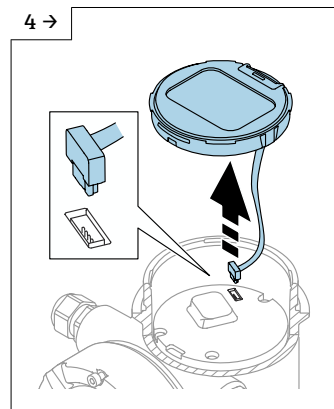

A0046834

- ▶ Release the plug connection.

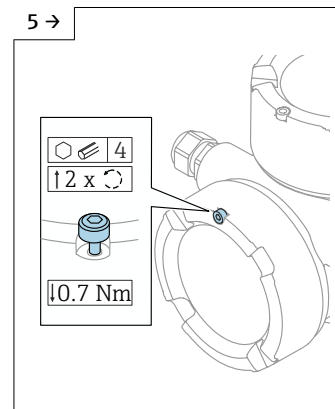

A0046923

- ▶ If fitted: release the screw of the cover lock for the connection compartment cover using the Allen key.

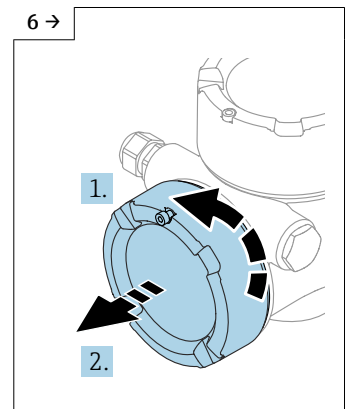

A0046924

- ▶ Unscrew the connection compartment cover, check the cover seal. Screw this cover onto the electronics compartment instead of the display cover. If fitted: tighten the screw of the cover lock using the Allen key

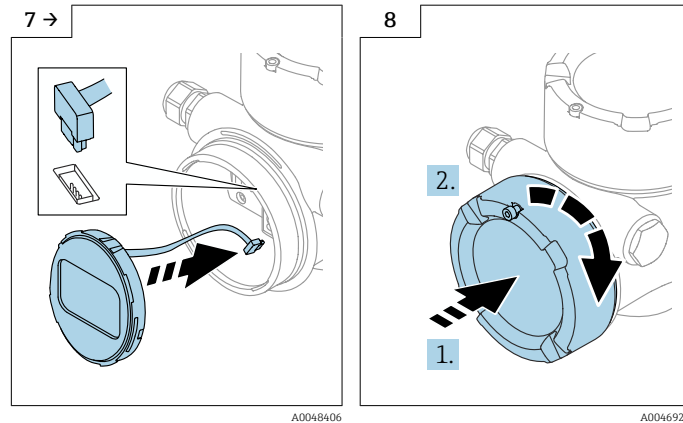

- ▶ Plug in the connection for the display module in the connection compartment.
- ▶ Fit the display module in the desired position until it clicks into place.
- ▶ Screw the display cover firmly back onto the housing. If fitted: tighten the screw of the cover lock using the Allen key 0.7 Nm (0.52 lbf ft).

5.3.10 Closing the housing covers

NOTICE

Thread and housing damaged from dirt!

- ▶ Remove dirt (e.g. sand) on the cover and housing thread.
- ▶ If you encounter resistance when closing the cover, check the thread for dirt and clean it.

i Housing thread

The threads of the electronics and connection compartment can be coated with an anti-friction coating.

The following applies for all housing materials:

- ✘ **Do not lubricate the housing threads.**

5.4 Post-mounting check

- Is the device free from damage (visual inspection)?
- Are the measuring point identification and labeling correct (visual inspection)?
- Is the measuring device protected against precipitation and sunlight?
- Are the securing screws and cover lock tightened securely?
- Does the measuring device comply with the measuring point specifications?

For example:

- Process temperature
- Process pressure
- Ambient temperature
- Measuring range

6 Electrical connection

6.1 Connecting requirements

6.1.1 Cover with securing screw

The cover is locked by a securing screw in devices for use in hazardous areas with certain explosion protection.

NOTICE

If the securing screw is not positioned correctly, the cover cannot provide secure sealing.

- ▶ Open the cover: slacken the screw of the cover lock with a maximum of 2 turns so that the screw does not fall out. Fit the cover and check the cover seal.
- ▶ Close the cover: screw the cover securely onto the housing, making sure that the securing screw is positioned correctly. There should not be any gap between the cover and housing.

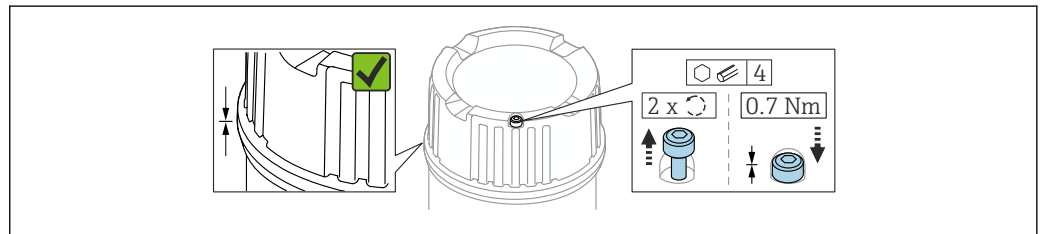

A0039520

2 Cover with securing screw

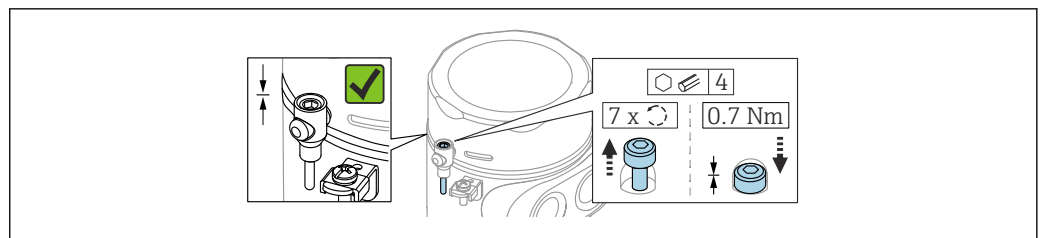

A0050983

3 Cover with securing screw; hygienic housing (only for dust explosion protection)

6.1.2 Potential equalization

The protective ground on the device must not be connected. If necessary, the potential matching line can be connected to the outer ground terminal of the housing before the device is connected.

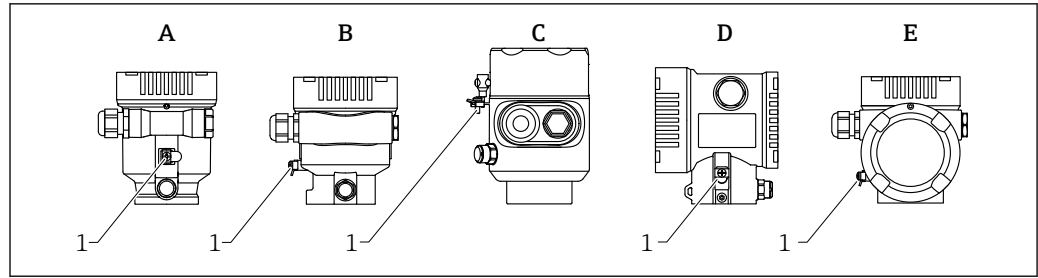

A0046583

- A Single compartment housing, plastic
 B Single compartment housing, aluminum, coated
 C Single compartment housing, 316L, hygiene (Ex device)
 D Dual compartment housing, aluminum, coated
 E Dual compartment housing, L-shaped, aluminum, coated
 1 Ground terminal for connecting the potential matching line

⚠ WARNING

Ignitable sparks or impermissible high surface temperatures.

Explosion hazard!

- ▶ Please refer to the separate documentation on applications in hazardous areas for the safety instructions.

- i** For optimum electromagnetic compatibility:
- Keep potential matching line as short as possible
 - Observe minimum cross-section of 2.5 mm² (14 AWG)

6.2 Connecting the device

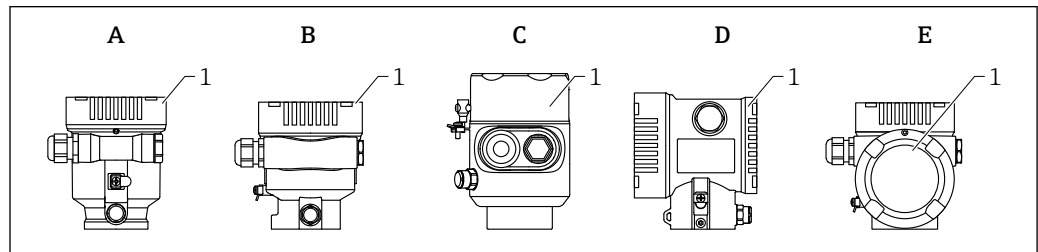

A0046659

- A Single compartment housing, plastic
 B Single compartment housing, aluminum, coated
 C Single compartment housing, 316L, hygiene
 D Dual compartment housing, aluminum, coated
 E Dual compartment housing, L-shaped, aluminum, coated
 1 Connection compartment cover

- i** Devices with a single compartment 316L hygiene housing and conduit screw connection must be connected as end-of-line devices; only one “conduit entry” may be used.

i Housing thread

The threads of the electronics and connection compartment can be coated with an anti-friction coating.

The following applies for all housing materials:

- ⊗ Do not lubricate the housing threads.**

6.2.1 Supply voltage

The supply voltage depends on the selected type of device approval

Non-hazardous, Ex d, Ex e	9 to 32 V _{DC}
Ex i	9 to 30 V _{DC}
Nominal current	14 mA
Error current FDE (Fault Disconnection Electronic)	0 mA

-  Use only suitable and certified Profibus PA components (e.g. DP/PA segment coupler) for the power supply
 - FISCO/FNICO-compliant according to IEC 60079-27
 - The supply is not polarity-dependent

Device display and Bluetooth

The display and the Bluetooth function (order option) are dependent on the supply voltage at the moment the device is switched on.

Supply voltage

- <12 V_{DC}: the background lighting is switched off
- <10 V_{DC}: the Bluetooth function is also switched off

6.2.2 Cable specification

Rated cross-section

- Supply voltage
0.5 to 2.5 mm² (20 to 13 AWG)
- Protective earth or grounding of the cable shield
> 1 mm² (17 AWG)
- External ground terminal
0.5 to 4 mm² (20 to 12 AWG)



Cable outer diameter

The cable outer diameter depends on the cable gland used

- Coupling, plastic:
Ø5 to 10 mm (0.2 to 0.38 in)
- Coupling, nickel-plated brass:
Ø7 to 10.5 mm (0.28 to 0.41 in)
- Coupling, stainless steel:
Ø7 to 12 mm (0.28 to 0.47 in)

-  Use a twisted, shielded twin-core cable, preferably cable type A.

For further information on the cable specification:

-  Operating Instructions BA00034S "PROFIBUS DP/PA: Guidelines for planning and commissioning"
-  PROFIBUS Assembling Guideline 8.022
-  IEC 61158-2 (MBP).

6.2.3 Overvoltage protection

The overvoltage protection can optionally be ordered as a "Mounted accessory" via the product structure.

Devices without optional overvoltage protection

The devices satisfy the IEC/DIN EN IEC 61326-1 product standard (Table 2 Industrial environment).

Depending on the type of port (DC power supply, input/output port) different testing levels according to IEC/DIN EN 61326-1 against transient overvoltages are applied (IEC/DIN EN 61000-4-5 Surge):

Test level on DC power ports and input/output ports is 1 000 V line to earth

Devices with optional overvoltage protection

- Spark-over voltage: min. 400 V_{DC}
- Tested according to IEC/DIN EN 60079-14 sub chapter 12.3 (IEC/DIN EN 60060-1 chapter 7)
- Nominal discharge current: 10 kA

NOTICE

The device can be destroyed by excessively high electrical voltages.

- ▶ Always ground the device with integrated overvoltage protection.

Overvoltage category

Overvoltage category II

6.2.4 Wiring

WARNING

Supply voltage might be connected!

Risk of electric shock and/or explosion!

- ▶ If the device is used in hazardous areas, make sure to comply with national standards and the specifications in the Safety Instructions (XAs). The specified cable gland must be used.
- ▶ The supply voltage must match the specifications on the nameplate.
- ▶ Switch off the supply voltage before connecting the device.
- ▶ If necessary, the potential matching line can be connected to the outer ground terminal of the device before the power supply lines are connected.
- ▶ FISCO/FNICO compliant according to IEC 60079-27.
- ▶ The supply does not depend on the polarity.
- ▶ The cables must be adequately insulated, with due consideration given to the supply voltage and the overvoltage category.
- ▶ The connecting cables must offer adequate temperature stability, with due consideration given to the ambient temperature.
- ▶ Only operate the measuring device with the covers closed.

Connect the device in the following order:

1. Release the cover lock (if provided).
2. Unscrew the cover.
3. Guide the cables into the cable glands or cable entries.
4. Connect the cable.
5. Tighten the cable glands or cable entries so that they are leak-tight. Counter-tighten the housing entry.
6. Screw the cover securely back onto the connection compartment.
7. If provided: tighten the screw of the cover lock using the Allen key 0.7 Nm (0.52 lbf ft) ±0.2 Nm (0.15 lbf ft).

6.2.5 Terminal assignment

Single compartment housing

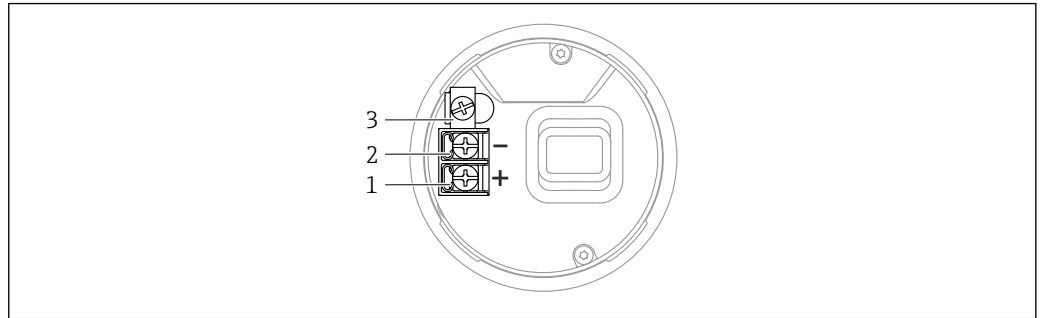

A0042594

4 Connection terminals and ground terminal in the connection compartment, single compartment housing

- 1 Positive terminal
- 2 Negative terminal
- 3 Internal ground terminal

Dual compartment housing

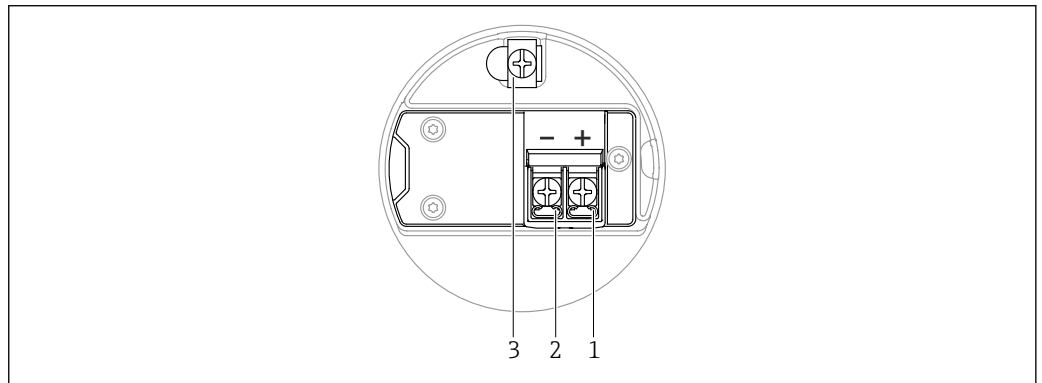

A0042803

5 Connection terminals and ground terminal in the connection compartment

- 1 Plus terminal
- 2 Minus terminal
- 3 Internal ground terminal

Dual compartment housing, L-shaped

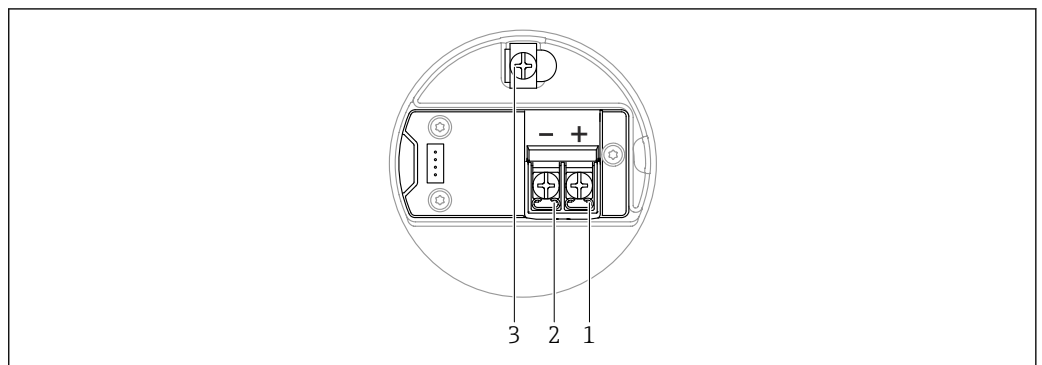

A0045842

6 Connection terminals and ground terminal in the connection compartment

- 1 Plus terminal
- 2 Minus terminal
- 3 Internal ground terminal

6.2.6 Cable entries

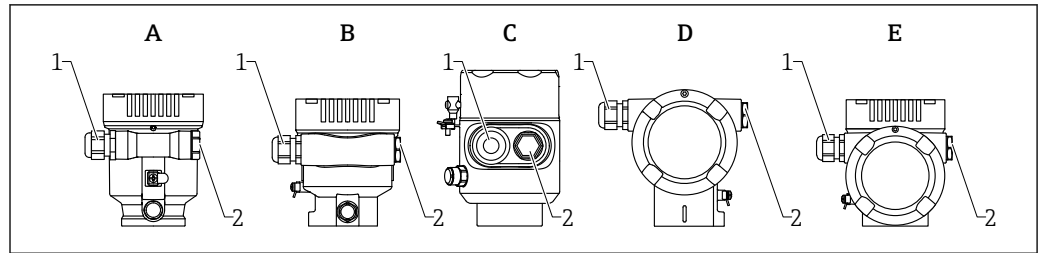

A0046584

- A Single compartment housing, plastic
 B Single compartment housing, aluminum, coated
 C Single compartment housing, 316L, hygiene
 D Dual compartment housing, aluminum, coated
 E Dual compartment housing, L-shaped, aluminum, coated
 1 Cable entry
 2 Dummy plug

The number and type of cable entries depend on the device version ordered.

i Always route connecting cables downwards so that moisture cannot penetrate the connection compartment.

If necessary, create a drip loop or use a weather protection cover.

6.2.7 Available device plugs

i In the case of devices with a plug, it is not necessary to open the housing for connection purposes.

Use the enclosed seals to prevent the penetration of moisture into the device.

Devices with M12 plug

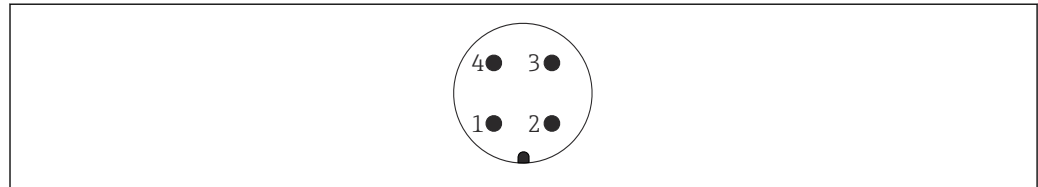

A0011175

7 View of the plug-in connection on the device

- 1 Signal +
 2 Not used
 3 Signal -
 4 Ground

Various M12 plug sockets are available as accessories for devices with M12 plugs.

6.3 Ensuring the degree of protection

6.3.1 Cable entries

- M20 coupling, plastic, IP66/68 NEMA TYPE 4X/6P
- M20 coupling, nickel-plated brass, IP66/68 NEMA TYPE 4X/6P
- M20 coupling, 316L, IP66/68 NEMA TYPE 4X/6P
- M20 thread, IP66/68 NEMA Type 4X/6P

- G1/2 thread, IP66/68 NEMA Type 4X/6P
If the G1/2 thread is selected, the device is delivered with an M20 thread as standard and a G1/2 adapter is included with the delivery, along with the corresponding documentation
- NPT 1/2 thread, IP66/68 NEMA Type 4X/6P
- Dummy plug transport protection: IP22, NEMA TYPE 2
- M12 plug
 - When housing is closed and connecting cable is plugged in: IP66/67, NEMA Type 4X
 - When housing is open or connecting cable is not plugged in: IP20, NEMA Type 1

NOTICE**M12 plug: Loss of IP protection class due to incorrect installation!**

- ▶ The degree of protection only applies if the connecting cable used is plugged in and screwed tight.
- ▶ The degree of protection only applies if the connecting cable used is specified according to IP67, NEMA Type 4X.
- ▶ The IP protection classes are only maintained if the dummy cap is used or the cable is connected.

6.4 Post-connection check

- Are the device or cables undamaged (visual inspection)?
- Do the cables used comply with the requirements?
- Do the mounted cables have strain relief?
- Cable glands mounted, securely tightened and leak-tight?
- Does the supply voltage correspond to the specifications on the nameplate?
- Cover screwed down correctly?
- Cover lock tightened correctly?

7 Operation options

7.1 Overview of operation options

- Operation via operating keys and DIP switches on the electronic insert
- Operation via optical operating keys on the device display (optional)
- Operation via Bluetooth® wireless technology (with optional device display with Bluetooth) with SmartBlue app or FieldXpert, DeviceCare
- Operation via operating tool (Endress+Hauser FieldCare/DeviceCare, PDM etc.)

7.2 Operating keys and DIP switches on the PROFIBUS PA electronic insert

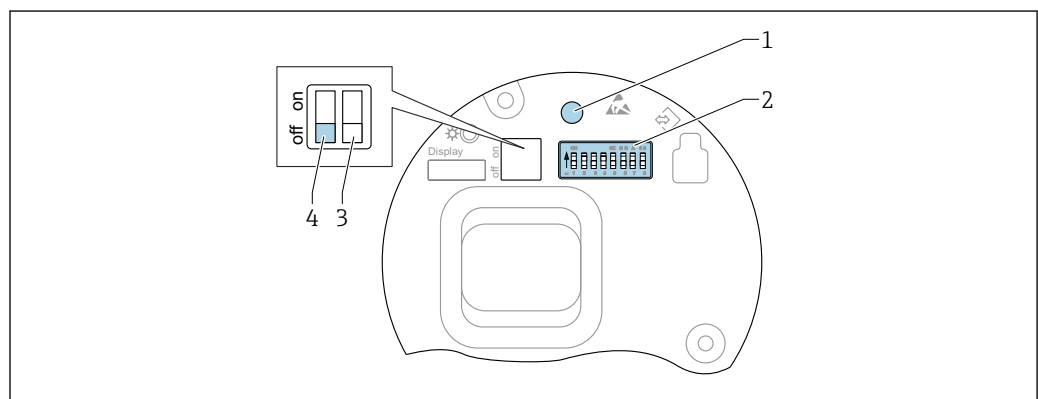

A0050986

8 Operating keys and DIP switches on the PROFIBUS PA electronic insert

- 1 Operating key for reset password (for Bluetooth login and Maintenance user role)
- 2 DIP switch for address configuration
- 3 DIP switch with no function
- 4 DIP switch for locking and unlocking the device

i The setting of the DIP switches on the electronic insert has priority over the settings made via other operation methods (e.g. FieldCare/DeviceCare).

7.2.1 Hardware addressing

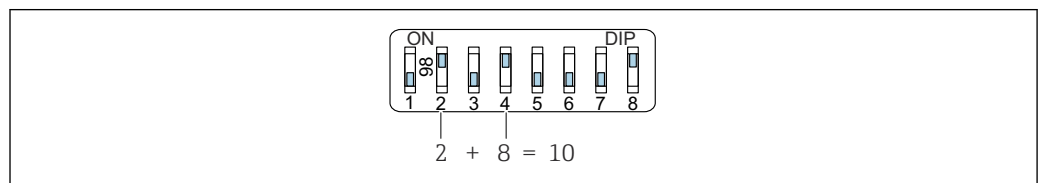

A0053770

9 Example of hardware addressing; switch 8 is set to the "ON" position; switches 1 to 7 define the address.

1. Set switch 8 to the "ON" position.
2. Using switches 1 to 7, set the address as indicated in the table below.

The change of address takes effect after 10 seconds. The device is restarted.

Assignment of switch values

Switch	1	2	3	4	5	6	7
Value in "ON" position	1	2	4	8	16	32	64
Value in "OFF" position	0	0	0	0	0	0	0

7.2.2 Software addressing

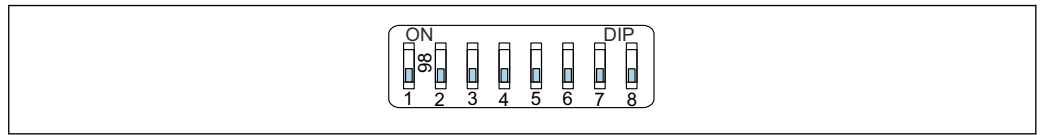

A0053771

 10 Example of software addressing; switch 8 is set to the "OFF" position; the address is defined in the operating menu

1. Set switch 8 to "OFF".
2. The device restarts automatically and reports the PROFIBUS address stored in the device. The factory setting is PROFIBUS address 126 or the PROFIBUS address ordered with order code "Marking", "Bus address" option.
3. Configure the address via the operating menu: Application → Profibus → Configuration → Device address

7.3 Structure and function of the operating menu

The differences between the structure of the operating menus of the local display and the Endress+Hauser FieldCare or DeviceCare operating tools can be summarized as follows:

The local display is suitable for configuring simple applications.

The operating tools (FieldCare, DeviceCare, SmartBlue, PDM etc.) can be used to configure the parameters of wide-ranging applications.

Wizards help the user to commission the various applications. The user is guided through the individual configuration steps.

7.3.1 User roles and related access authorization

The two user roles **Operator** and **Maintenance** (as-delivered state) have different write access to the parameters if a device-specific access code has been defined. This access code protects the device configuration from unauthorized access.

If an incorrect access code is entered, the user obtains the access rights of the **Operator** role.

7.4 Access to operating menu via local display

7.4.1 Device display (optional)

Possible to operate the optical operating keys through the cover. No need to open the device.

Functions:

- Display measured values, also fault and notice messages
- Background lighting, which switches from green to red in the event of an error
- The device display can be removed for easier operation

 The device display is also optionally available with Bluetooth® wireless technology.

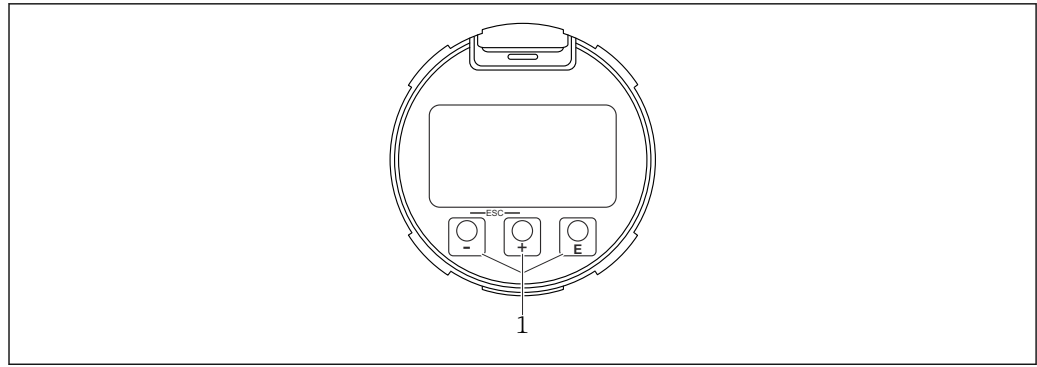

11 Graphic display with optical operating keys (1)

A0039284

- **+** key
 - Navigate down in the picklist
 - Edit the numerical values or characters within a function
- **-** key
 - Navigate up in the picklist
 - Edit the numerical values or characters within a function
- **E** key
 - Change from main display to main menu
 - Confirm entry
 - Jump to the next item
 - Select a menu item and activate edit mode
 - Unlock/lock the display operation
 - Press and hold the **E** key to display a short description of the selected parameter (if available)
- **+** key and **-** key (ESC function)
 - Exit edit mode for a parameter without saving the changed value
 - Menu at a selection level: pressing the keys simultaneously takes the user back up a level in the menu
 - Press and hold the keys simultaneously to return to the upper level

7.4.2 Operation via Bluetooth® wireless technology (optional)

Prerequisite

- Device with device display including Bluetooth
- Smartphone or tablet with Endress+Hauser SmartBlue app or PC with DeviceCare from version 1.07.05 or FieldXpert SMT70

The connection has a range of up to 25 m (82 ft). The range can vary depending on environmental conditions such as attachments, walls or ceilings.

i The operating keys on the display are locked as soon as the device is connected via Bluetooth.

A flashing Bluetooth symbol indicates that a Bluetooth connection is available.

i Please note the following

- If the Bluetooth display is removed from one device and installed in another device:
- All the log-in data are only saved in the Bluetooth display and not in the device
 - The password changed by the user is also saved in the Bluetooth display

Operation via SmartBlue app

The device can be operated and configured with the SmartBlue app.

- The SmartBlue app must be downloaded onto a mobile device for this purpose.
- For information on the compatibility of the SmartBlue app with mobile devices, see **Apple App Store (iOS devices)** or **Google Play Store (Android devices)**.
- Incorrect operation by unauthorized persons is prevented by means of encrypted communication and password encryption.
- The Bluetooth® function can be deactivated after initial device setup.



A0033202

12 QR code for free Endress+Hauser SmartBlue app

Download and installation:

1. Scan the QR code or enter **SmartBlue** in the search field of the Apple App Store (iOS) or Google Play Store (Android).
2. Install and start the SmartBlue app.
3. For Android devices: enable location tracking (GPS) (not required for iOS devices).
4. Select a device that is ready to receive from the device list displayed.

Login:

1. Enter the user name: admin
2. Enter the initial password: serial number of the device
3. Change the password after logging in for the first time.



Notes on the password and reset code

- If the user-defined password is lost, access can be restored via a reset code. The reset code is the device serial number in reverse. Once the reset code has been entered, the Initial password is valid again.
- Like the password, the reset code can also be changed.
- If the user-defined reset code is lost, the password can no longer be reset via the SmartBlue app. In this case, contact Endress+Hauser Service.

7.5 Access to the operating menu via the operating tool

Access via the operating tool is possible:

- Via Profibus PA communication
- Via Endress+Hauser Commubox FXA291
With the Commubox FXA291, a CDI connection can be established with the device interface and a Windows PC/notebook with a USB port

7.6 DeviceCare

7.6.1 Function scope

Tool for connecting and configuring Endress+Hauser field devices.

The fastest way to configure Endress+Hauser field devices is with the dedicated "DeviceCare" tool. Together with the device type managers (DTMs), DeviceCare presents a convenient, comprehensive solution.



For details, see Innovation Brochure IN01047S

7.7 FieldCare

7.7.1 Function range

FDT-based plant asset management tool from Endress+Hauser. FieldCare can configure all smart field devices in a system and helps you manage them. By using the status information, FieldCare is also a simple but effective way of checking their status and condition.

Access is via:

- PROFIBUS PA protocol
- CDI service interface

Typical functions:

- Parameter configuration of transmitters
- Loading and saving of device data (upload/download)
- Documentation of the measuring point
- Visualization of the measured value memory (line recorder) and event logbook



For additional information about FieldCare, see Operating Instructions BA00027S and BA00059S

8 System integration

According to EN 50170 Volume 2, IEC 61158-2 (MBP) type 1 PROFIBUS PA Profile Version 3.02

8.1 Protocol-specific data

8.1.1 PROFIBUS PA

Manufacturer ID:

17 (0x11)

Ident number:

0x1568 or 0x9700

Profile version:

3.02

GSD file and version

Information and files available at:

- www.endress.com

On the product page for the device: Documents/Software → Device drivers

- www.profibus.com

Output values

Analog Input:

- Level linearized
- Distance
- Volume
- Terminal voltage
- Electronics temperature
- Sensor temperature
- Absolute echo amplitude
- Relative echo amplitude
- Area of incoupling
- Buildup index, optional (Guidance → Heartbeat Technology → Buildup detection → Buildup index)
- Foam index, optional (Diagnostics → Heartbeat Technology → Foam detection → Foam index)

Digital Input:

 Is only available if the "Heartbeat Verification + Monitoring" application package was selected.

- 168 Build-up detected, optional (Guidance → Heartbeat Technology → Buildup detection → 168 Build-up detected)
- 952 Foam detected, optional (Guidance → Heartbeat Technology → Foam detection → 952 Foam detected)

Input values

Analog Output:

Analog value from PLC to be indicated on the display

Supported functions

- Identification & maintenance
Straightforward device identification on the part of the control system and nameplate
- Automatic Ident Number adoption
GSD compatibility mode for generic profile 0x9700 "Transmitter with 1 Analog Input"
- Physical layer diagnostics
Installation check of the PROFIBUS segment and device using terminal voltage and message monitoring
- PROFIBUS upload/download
Reading and writing parameters is up to ten times faster with PROFIBUS upload/download
- Condensed status
Straightforward and self-explanatory diagnostic information by categorizing diagnostic messages that occur

8.2 Device master file (GSD)

In order to integrate the field devices into the bus system, the PROFIBUS system needs a description of the device parameters, such as output data, input data, data format, data volume and supported transmission rate. These data are available in the general station description (GSD) which is provided to the PROFIBUS Master when the communication system is commissioned.

In addition, device bit maps, which appear as icons in the network structure, can also be integrated.

With the Profile 3.0 device master file (GSD) it is possible to exchange field devices made by different manufacturers without having to reconfigure.

Generally speaking, two different GSD versions are possible with Profile 3.0 and higher.

-  ▪ Before configuring, the user must decide which GSD should be used to operate the system.
- The setting can be changed via a Class 2 master.

8.2.1 Manufacturer-specific GSD

This GSD guarantees the unrestricted functionality of the measuring device. Device-specific process parameters, functions and all device diagnostics are therefore available.

Manufacturer-specific GSD	ID number	File name
PROFIBUS PA	0x1568	EH3x1568.gsd

If the manufacturer-specific GSD should be used, this is specified in the **Ident number selector** parameter by selecting the **FMR6xB 0x1568** option.

-  Where to acquire the manufacturer-specific GSD:
www.endress.com → Download

8.2.2 Profile GSD

Differs in terms of the number of Analog Input blocks (AI) and the measured values. If a system is configured with a Profile GSD, it is possible to exchange devices made by different manufacturers. However, it is essential to ensure that the order of the cyclic process values is correct.

ID number	Supported blocks
0x9700	1 Analog Input

The Profile GSD that is to be used is specified in the **Ident number selector** parameter by selecting the **0x9700 (1AI)** option or **FMR6xB 0x1568** option.

8.2.3 Compatibility with other devices

This device ensures compatibility in cyclic data exchange with the automation system (Class 1 master) for the following devices:

Generic Transmitter 1 AI PROFIBUS PA (Profile version 3.02, ident number 0x9700)

It is possible to replace these devices without the need to reconfigure the PROFIBUS network in the automation unit although the name and identification number of the devices are different.

Once replaced, the device is either identified automatically (factory setting) or device identification can be set manually.

Automatic identification (factory setting)

The device automatically recognizes the generic profile configured in the automation system and makes the same input data and measured value status information available for cyclic data exchange. Automatic identification is set in the **Ident number selector** parameter using the **Automatic mode** option (factory setting).

Manual setting

The manual setting is made in the **Ident number selector** parameter via the **FMR6xB 0x1568** option (manufacturer) or **0x9700 (1AI)** option (generic).

Afterwards, the device makes the same input and output data and measured status information available for cyclic data exchange.

-  If the device is acyclically configured via an operating program (Class 2 master), access is directly via the block structure or the parameters of the device.
 - If parameters were changed in the device to be replaced (parameter setting no longer corresponds to the original factory setting), these parameters have to be adapted accordingly in the new device used via an operating program (Class 2 master) to guarantee identical behavior
 - The cyclic data exchange of the Micropilot FMR6xB is not downward compatible with the Micropilot FMR5x or Micropilot FMR4x

8.3 Cyclic data transmission

Cyclic data transmission when using the device master file (GSD).

8.3.1 Block model

The block model shows which input and output data the measuring device makes available for cyclic data exchange. The cyclic data exchange is performed with a PROFIBUS master (Class 1), e.g. a control system.

Transducer Block

- Analog Input Block 1 to 6; AI output values →
- Digital Input Block 1 to 2; DI output values →
- Analog Output Block 1; AO input value ←

Defined order of modules

The device works as a modular PROFIBUS slave. In contrast to a compact slave, a modular slave has a variable design and consists of several individual modules. The device master

file (GSD) contains a description of the individual modules (input and output data) along with their individual properties.

The modules are permanently assigned to the slots, i.e. when configuring the modules, the order and the arrangement of the modules must be respected.

Slot	Module	Function block
01 ... 06	AI	Analog Input block 1 to 6
07 ... 08	DI	Digital Input Block 1 to 2
09	DO	Digital Output Block 1

To optimize the data throughput rate of the PROFIBUS network, it is advisable to only configure modules that are processed in the PROFIBUS master system. If this results in gaps between the configured modules, these gaps must be assigned to the `EMPTY_MODULE`.

8.3.2 Description of the modules

The data structure is described from the perspective of the PROFIBUS master:

- Input data: Are sent from the measuring device to the PROFIBUS master.
- Output data: Are sent to the measuring device by the PROFIBUS master.

AI module (Analog Input)

Transmit an input variable from the measuring device to the PROFIBUS master (Class 1).

The selected input variable, including the status, is cyclically transmitted to the PROFIBUS master (Class 1) via the AI module. The input variable is depicted in the first four bytes in the form of a floating point number as per the IEEE 754 standard. The fifth byte contains standardized status information pertaining to the input variable.

Six Analog Input blocks are available (slot 1 to 6); **Analog input 1 to 6** submenu

Input variable:

The input variable can be determined using the **Channel** parameter.

Application → Profibus → Analog input → Analog input 1 to 6 → Channel

Options:

- Level linearized
- Volume
- Distance
- Terminal voltage
- Electronics temperature
- Sensor temperature
- Absolute echo amplitude
- Relative echo amplitude
- Area of incoupling
- **Buildup index** option Visibility depends on order options or device settingsGuidance
→ Heartbeat Technology → Buildup detection → Configuration → Buildup index
- **Foam index** option Visibility depends on order options or device settingsGuidance
→ Heartbeat Technology → Foam detection → Configuration → Foam index

Factory setting: **Level linearized** option

Data structure

Byte 1	Byte 2	Byte 3	Byte 4	Byte 5
Measured value: Floating point number (IEEE 754)				Status

AO module (Analog Output)

Transmit display information from the PROFIBUS master (Class 1) to the measuring device.

An analog output value, along with the status, can be transmitted cyclically from the PROFIBUS master (Class 1) to the measuring device via the AO module and output on the local display. The value is displayed in the first four bytes in the form of a floating point number as per the IEEE 754 standard. The fifth byte contains standardized status information pertaining to the output value.

One Analog Output block is available (slot 9).

 Application → Profibus → Analog output → Analog output 1 → Out value **Out value** parameter; Shows an analog output value (AO) that is output from the controller to the device and can be shown on the local display. To show the AO on the local display, it must be assigned to a display output parameter as a value. This assignment is made in the menu under "System-Display".

Data structure

Byte 1	Byte 2	Byte 3	Byte 4	Byte 5
Measured value: Floating point number (IEEE 754)				Status

DI module (digital input)

Transmit discrete input values from the measuring device to the PROFIBUS master (Class 1). Discrete input values are used by the measuring device to transmit the state of device functions to the PROFIBUS master (Class 1).

The DI module cyclically transmits the discrete input value, along with the status, to the PROFIBUS master (Class 1). The discrete input value is depicted in the first byte. The second byte contains standardized status information pertaining to the input value.

Two discrete input blocks are available (slot 7 to 8).

 The digital input blocks are available only if the Heartbeat option is available and one or both of the Heartbeat Monitoring functions **Foam detected** option and **Buildup detected** option have been configured.

Device function:

The device function can be defined via the **Channel** parameter.

Application → Profibus → Digital input → Digital input 1 to 2 → Channel

Options:

- **Buildup index** option Visibility depends on order options or device settingsGuidance → Heartbeat Technology → Buildup detection → Configuration → Buildup index
- **Foam index** option Visibility depends on order options or device settingsGuidance → Heartbeat Technology → Foam detection → Configuration → Foam index

Factory setting: **None** option

Data structure

Byte 1	Byte 2
Digital	Status

EMPTY_MODULE module

This module is used to assign empty spaces arising from modules not being used in the slots.

The device works as a modular PROFIBUS slave. In contrast to a compact slave, a modular PROFIBUS slave has a variable design and consists of several individual modules. The GSD file contains a description of the individual modules along with their individual properties.

The modules are permanently assigned to the slots. When configuring the modules, it is absolutely essential to observe the sequence/arrangement of the modules. Any gaps between the configured modules must be filled with the `EMPTY_MODULE`.

9 Commissioning

i All configuration tools provide a commissioning assistant that supports the user when setting the most important configuration parameters (**Guidance** menu **Commissioning** wizard).

9.1 Preliminaries

The measuring range and the unit in which the measured value is transmitted correspond to the data on the nameplate.

9.2 Installation and function check

Before commissioning the measuring point, check whether the post-installation and post-connection checks have been performed.

 Post-mounting check

 Post-connection check

9.3 Connecting via FieldCare and DeviceCare

9.3.1 Via PROFIBUS PA protocol

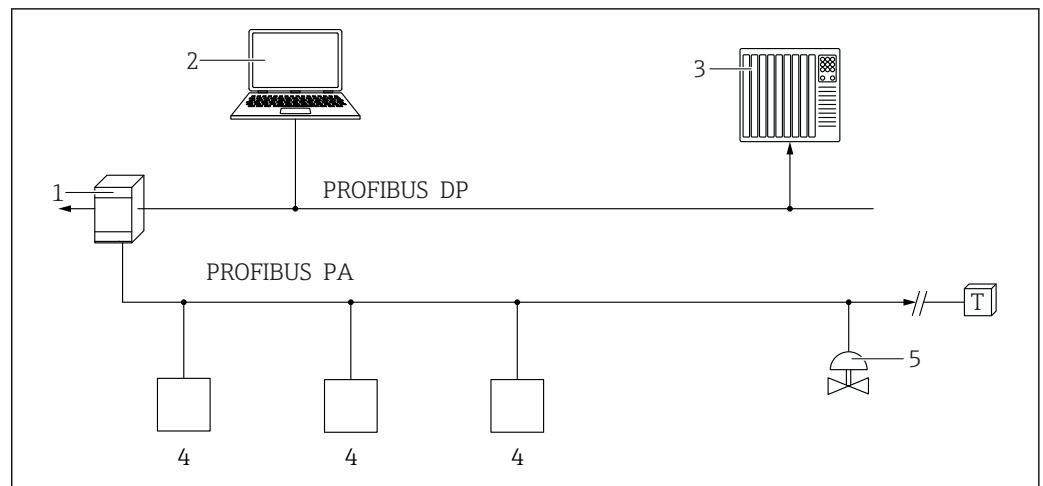

- 1 Segment coupler
- 2 Computer with PROFibus and operating tool (e.g. DeviceCare/FieldCare)
- 3 PLC (programmable logic controller)
- 4 Transmitter
- 5 Additional functions (valves etc.)

A0050944

9.3.2 Via service interface (CDI)

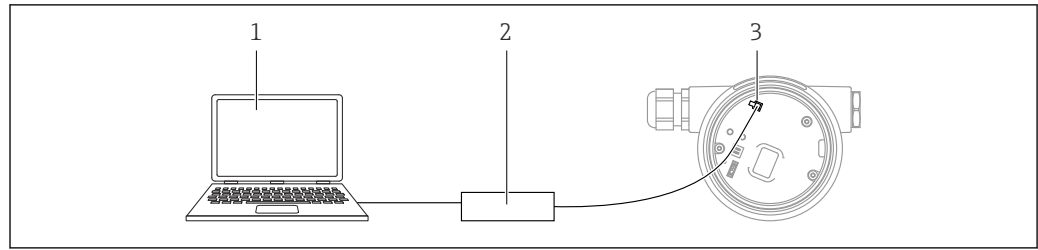

A0039148

- 1 Computer with FieldCare/DeviceCare operating tool
- 2 Commubox
- 3 Service interface (CDI) of the device (= Endress+Hauser Common Data Interface)

9.4 Setting the operating language

9.4.1 Local display

Setting the operating language

i To set the operating language, the display first needs to be unlocked:

1. Press the **ESC** key for at least 2 s.
↳ A dialog box appears.
2. Unlock the display operation.
3. Select the **Language** parameter in the main menu.
4. Press the **ESC** key.
5. Select the desired language with the **+** or **-** key.
6. Press the **ESC** key.

i Display operation locks automatically (except in the **Safety mode** wizard):

- after 1 min on the main page if no key has been pressed
- after 10 min within the operating menu if no key has been pressed

9.4.2 Operating tool

Set display language

System → Display → Language

Selection in the **Language** parameter; Visibility depends on order options or device settings

9.5 Configuring the device

9.5.1 Level measurement in liquids

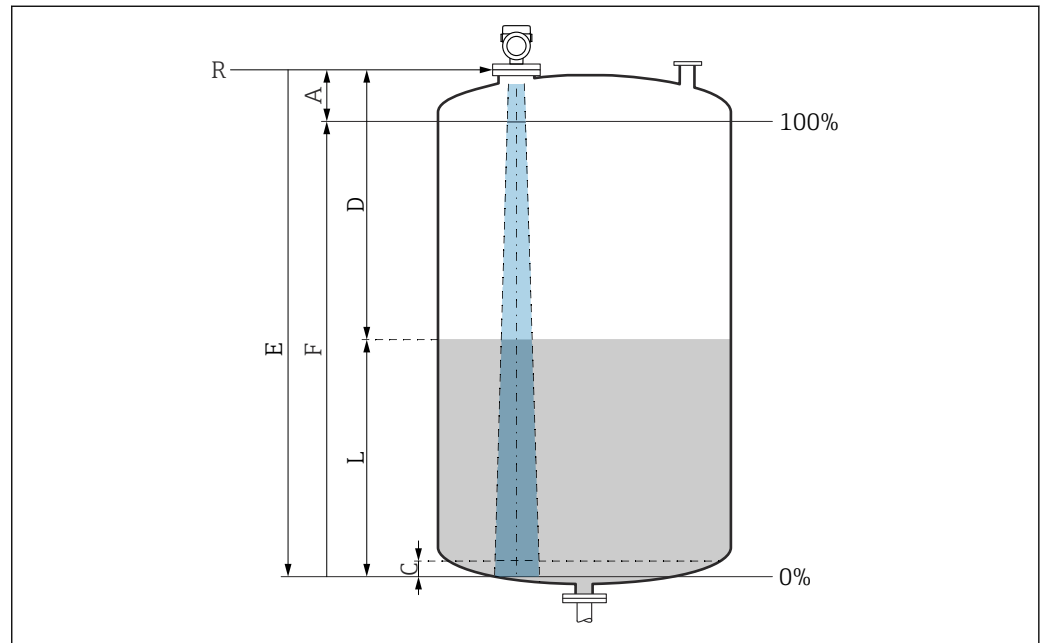

A0016933

13 Configuration parameters for level measurement in liquids

- R Reference point of measurement
- A Length of antenna + 10 mm (0.4 in)
- C 50 to 80 mm (1.97 to 3.15 in); medium $\epsilon_r < 2$
- D Distance
- L Level
- E "Empty calibration" parameter (= 0 %)
- F "Full calibration" parameter (= 100 %)

In the case of media with a low dielectric constant, $\epsilon_r < 2$, the tank floor may be visible through the medium at very low levels (lower than level C). Reduced accuracy must be expected in this range. If this is not acceptable, the zero point should be positioned at a distance C above the tank floor in these applications → Configuration parameters for level measurement in liquids.

9.5.2 Commissioning with the Commissioning wizard

In FieldCare, DeviceCare, SmartBlue and on the display, the **Commissioning** wizard is available to guide the user through the initial commissioning steps.

Complete this wizard to commission the device.

For each parameter, enter the appropriate value or select the appropriate option.

NOTE

If you exit the wizard before completing all required parameters, the changes you have made will be saved. For this reason, the device may then be in an undefined state! In this case, a reset to the default settings is recommended.

9.6 Recording the Echo curve

The Echo curve is only saved in the relevant operating tool.

Record the current Echo curve as a reference echo curve for subsequent diagnostic purposes.

After the measurement has been configured, it is recommended to record the current Echo curve as a reference echo curve.

The **Save reference curve** parameter in the **Echo curve** submenus used to record the Echo curve.

Diagnostics → Echo curve → Save reference curve

- ▶ Under the **Save reference curve** parameter, activate the **Customer reference curve** option



9.7 "Simulation" submenu

Simulation of a process variable, a pulse output or a diagnostic event.

10 Operation

10.1 Reading off the device locking status

Displaying active write protection in the **Locking status** parameter

- Local display :
 - The  symbol appears on the main page
- Operating tool (FieldCare/DeviceCare) :
 - Navigation: System → Device management → Locking status

10.2 Reading off measured values

All the measured values can be read off using the **Measured values** submenu.

Navigation: **Application** menu → **Measured values** submenu

10.3 Adapting the device to process conditions

The following menus are available for this purpose:

- Basic settings in the **Guidance** menu
- Advanced settings in:
 - **Diagnostics** menu
 - **Application** menu
 - **System** menu

10.4 Heartbeat Technology (optional)

10.4.1 Heartbeat Verification

"Heartbeat Verification" wizard

This wizard is used to start an automatic verification of the device functionality. The results can be documented as a verification report.

- The wizard can be used via the operating tools and the display
 - The wizard can be started on the display but only shows the **Passed** option or **Failed** option result.
- The wizard guides the user through the entire process for creating the verification report

10.4.2 Heartbeat Verification/Monitoring

 The **Heartbeat** submenu is only available if operating via FieldCare, DeviceCare or the SmartBlue app. It contains the wizards that are available with the application packages Heartbeat Verification and Heartbeat Monitoring.

 Documentation on the Heartbeat Technology: Endress+Hauser website: www.endress.com → Downloads.

11 Diagnostics and troubleshooting

11.1 General troubleshooting

11.1.1 General errors

Device is not responding

- Possible cause: Supply voltage does not match the specification on the nameplate
Remedial action: Apply the correct voltage
- Possible cause: The connecting cables are not in contact with the terminals
Remedial action: Check the electrical contact between cables and correct if necessary

Values not visible on the display

- Possible cause: Display setting is too bright or too dark
Remedy:
Use the **Contrast display** parameter to increase or reduce contrast
Navigation path: System → Display → Contrast display
- Possible cause: The plug of the display cable is not connected correctly
Remedial action: Connect the plug correctly
- Possible cause: Display is defective
Remedial action: Replace the display

"Communication error" is indicated on the display when the device is started or the display is connected

- Possible cause: Electromagnetic interference influence
Remedial action: Check grounding of the device
- Possible cause: Defective cable connection or display plug
Remedial action: Replace the display

Communication via CDI interface not working

Possible cause: Wrong setting of the COM port on the computer

Remedial action: Check the setting of the COM port on the computer and correct it if necessary

Device measuring incorrectly

Possible cause: Parameter configuration error

Remedial action: Check and correct the parameter configuration

11.2 Error - SmartBlue operation

Operation via SmartBlue is only possible on devices that have a display with Bluetooth (optionally available).

Device is not visible in the live list

- Possible cause: No Bluetooth connection available
Remedial action: Enable Bluetooth in the field device via display or software tool and/or in the smartphone/tablet
- Possible cause: Bluetooth signal outside range
Remedial action: Reduce distance between field device and smartphone/tablet
The connection has a range of up to 25 m (82 ft).
Operating radius with intervisibility 10 m (33 ft)
- Possible cause: Geopositioning is not enabled on Android devices or is not permitted for the SmartBlue app
Remedial action: Enable/disable geolocation service on Android device for the SmartBlue app
- Display does not have Bluetooth
- Historom is not connected

Device appears in the live list but a connection cannot be established

- Possible cause: The device is already connected with another smartphone/tablet via Bluetooth
Only one point-to-point connection is permitted
Remedial action: Disconnect the smartphone/tablet from the device
- Possible cause: Incorrect user name and password
Remedial action: The standard user name is "admin" and the password is the device serial number indicated on the device nameplate (only if the password was not changed by the user beforehand)
If the password has been forgotten, contact Endress+Hauser Service (www.addresses.endress.com)

Connection via SmartBlue not possible

- Possible cause: Incorrect password entered
Remedial action: Enter the correct password, paying attention to lower/upper case
- Possible cause: Forgotten password
Remedial action: Contact Endress+Hauser Service (www.addresses.endress.com)

Login via SmartBlue not possible

- Possible cause: Device is being put into operation for the first time
Remedial action: Enter the user name "admin" and the password (device serial number), paying attention to lower/upper case
- Possible cause: The electric current and voltage are not correct.
Remedial action: Increase the supply voltage.

Device cannot be operated via SmartBlue

- Possible cause: Incorrect password entered
Remedial action: Enter the correct password, paying attention to lower/upper case
- Possible cause: Forgotten password
Remedial action: Contact Endress+Hauser Service (www.addresses.endress.com)
- Possible cause: **Operator** option has no authorization
Remedial action: System → User management → User role Change to **Maintenance** option

11.3 Diagnostic message

Faults detected by the self-monitoring system of the device are displayed as a diagnostic message in alternation with the measured value.

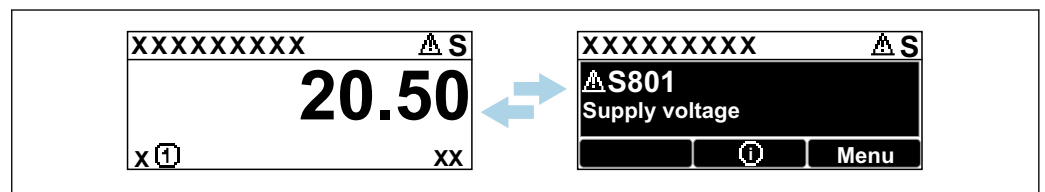

A0051136

14 Diagnostic message displayed in alternating sequence with the measured value

If two or more diagnostic events occur simultaneously, only the diagnostic message with the highest priority is shown.

11.3.1 Diagnostic information on local display

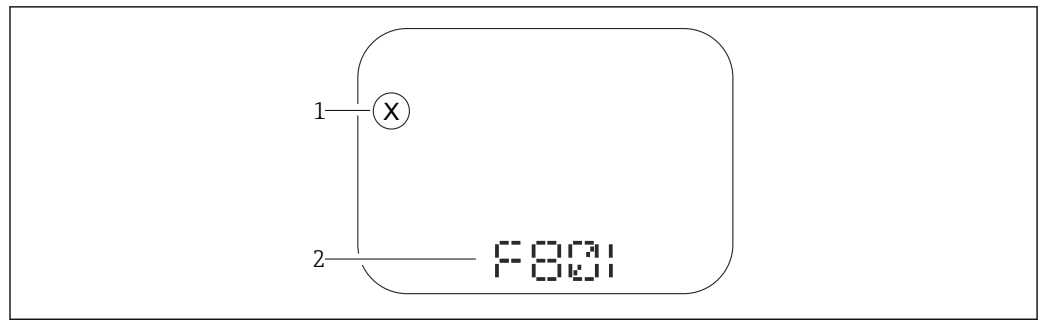

A0043759

15 Segment display without keys

- 1 Status symbol for event level
- 2 Status signal with diagnostic event

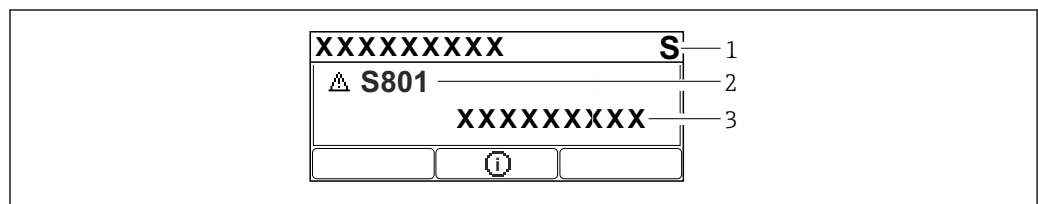

A0043103

16 Graphic display with keys

- 1 Status signal
- 2 Status symbol with diagnostic event and preceding symbol for event level
- 3 Event text

11.3.2 Diagnostic information in the operating tool

If a diagnostic event has occurred in the device, the status signal appears in the top left status area of the operating tool together with the corresponding symbol for the event level according to NAMUR NE 107.

Click the status signal to see the detailed status signal.

Pending diagnostic messages can also be displayed in the **Active diagnostics** parameter.

The diagnostic events and remedial measures can be printed out in the **Diagnostic list** submenu.

11.3.3 Status signal

F

Failure (F)

A device error has occurred. The measured value is no longer valid.

C

Function check (C)

The device is in the service mode (e.g. during a simulation).

S

Out of specification (S)

Device operation:

- Outside of the technical specifications (e.g. during startup or a cleaning)
- Outside of the configuration performed by the user (e.g. sensor frequency outside the configured span)

M

Maintenance required (M)

Maintenance required. The measured value is still valid.

11.3.4 Diagnostic event and event text

The fault can be identified by means of the diagnostic event. The event text helps you by providing information about the fault. In addition, the associated status symbol is displayed in front of the diagnostic event.

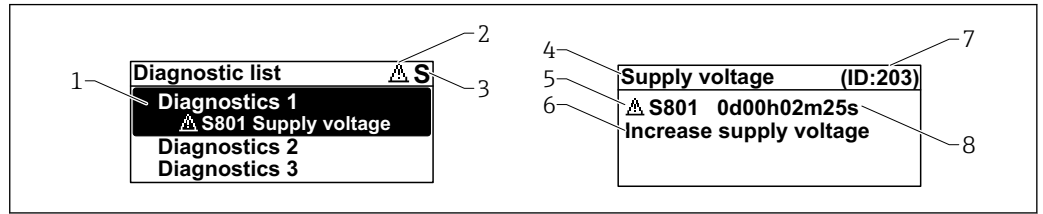

A0051137

- 1 Diagnostic message
- 2 Symbol for event level
- 3 Status signal
- 4 Short text
- 5 Symbol for event level, status signal, diagnostic number
- 6 Remedial measure
- 7 Service ID
- 8 Operating time of occurrence

Symbol for event level

⊗ "Alarm" status

Measurement is interrupted. The signal outputs adopt the defined alarm state. A diagnostic message is generated.

⚠ "Warning" status

The device continues to measure. A diagnostic message is generated.

11.4 Remedy information Calling up

11.4.1 Graphic display with keys

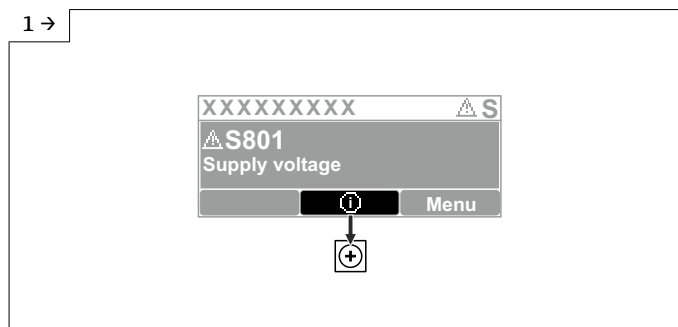

A0051131

- Open the **Diagnostic list** submenu

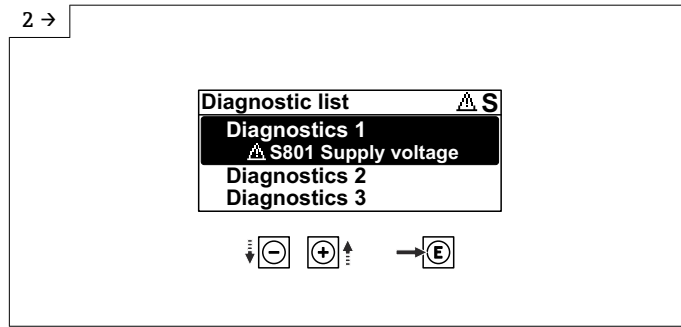

A0051132

► Select the diagnostic event and confirm

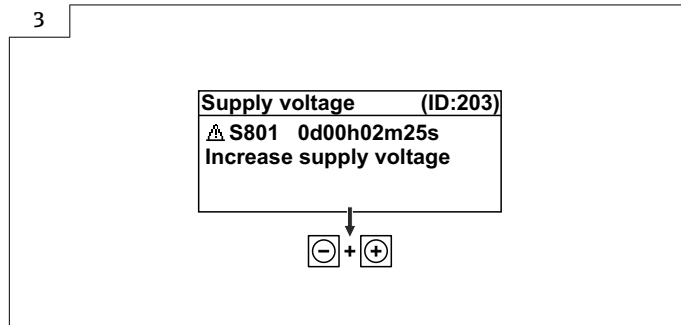

A0051133

► Remedy informationClosing

11.4.2 Operating menu

In the **Diagnostic list** submenu, up to 5 currently pending diagnostic messages can be displayed. If more than 5 messages are pending, the messages with the highest priority are shown on the display.

Navigation path

Diagnostics → Diagnostic list

Queued diagnostic messages are also displayed in the **Active diagnostics** parameter.

Navigation: Diagnostics → Active diagnostics

11.5 Adapting the diagnostic information

The event level can be configured:

Navigation: Diagnostics → Diagnostic settings → Configuration

11.6 List of diagnostic events

 If Remedy information **Contact the Service Department** is displayed (www.addresses.endress.com), be ready with the **service ID** shown.

Diagnostic number	Short text	Remedy instructions	Status signal [from the factory]	Diagnostic behavior [from the factory]
Diagnostic of sensor				
062	Sensor connection faulty	Check sensor connection	F	Alarm
151	Sensor electronic failure	1. Restart device 2. Contact service	F	Alarm

Diagnostic number	Short text	Remedy instructions	Status signal [from the factory]	Diagnostic behavior [from the factory]
168	Buildup detected	Check process conditions	M	Warning ¹⁾
Diagnostic of electronic				
242	Firmware incompatible	1. Check software 2. Flash or change main electronic module	F	Alarm
252	Module incompatible	1. Check if correct electronic module is plugged 2. Replace electronic module	F	Alarm
270	Main electronics defective	Replace main electronics or device.	F	Alarm
272	Main electronics faulty	1. Restart device 2. Contact service	F	Alarm
273	Main electronics defective	Replace main electronics or device.	F	Alarm
282	Data storage inconsistent	Restart device	F	Alarm
283	Memory content inconsistent	1. Restart device 2. Contact service	F	Alarm
287	Memory content inconsistent	1. Restart device 2. Contact service	M	Warning
388	Electronics and HistoROM defective	1. Restart device 2. Replace electronics and HistoROM 3. Contact service	F	Alarm
Diagnostic of configuration				
410	Data transfer failed	1. Retry data transfer 2. Check connection	F	Alarm
412	Processing download	Download active, please wait	C	Warning
435	Linearization faulty	Check linearization table	F	Alarm
437	Configuration incompatible	1. Update firmware 2. Execute factory reset	F	Alarm
438	Dataset different	1. Check dataset file 2. Check device parameterization 3. Download new device parameterization	M	Warning
482	Block in OOS	Set Block in AUTO mode	F	Alarm
484	Failure mode simulation active	Deactivate simulation	C	Alarm
485	Process variable simulation active	Deactivate simulation	C	Warning
495	Diagnostic event simulation active	Deactivate simulation	S	Warning
497	Block output simulation active	Deactivate simulation	C	Warning
538	Configuration Sensor Unit invalid	1. Check sensor configuration 2. Check device configuration	F	Alarm
585	Simulation distance	Deactivate simulation	C	Warning
586	Record map	Recording of mapping please wait	C	Warning

Diagnostic number	Short text	Remedy instructions	Status signal [from the factory]	Diagnostic behavior [from the factory]
Diagnostic of process				
801	Supply voltage too low	Increase supply voltage	F	Alarm
802	Supply voltage too high	Decrease supply voltage	S	Warning
825	Electronics temperature out of range	1. Check ambient temperature 2. Check process temperature	S	Warning
826	Sensor temperature out of range	1. Check ambient temperature 2. Check process temperature	S	Warning
941	Echo lost	Check parameter "DC value"	S	Warning ¹⁾
942	In safety distance	1. Check level 2. Check safety distance 3. Reset self holding	S	Warning ¹⁾
952	Foam detected	Check process conditions	S	Warning ¹⁾
968	Level limited	1. Check level 2. Check limit parameters	S	Warning

1) Diagnostic behavior can be changed.

11.7 Event logbook

11.7.1 Event history

A chronological overview of the event messages that have occurred is provided in the **Event logbook** submenu. This submenu only exists if operating via the local display with keys. In the case of operation via FieldCare, the event list can be displayed with the "Event List / HistoROM" functionality of FieldCare.

Navigation:

Diagnostics → Event logbook → Event list

A maximum of 100 event messages can be displayed in chronological order.



The event history includes entries for:

- Diagnostic events
- Information events

In addition to the operating time when the event occurred, each event is also assigned a symbol that indicates whether the event has occurred or is finished:

- Diagnostic event
 - ☺: Occurrence of the event
 - ☹: End of the event
- Information event
 - ☺: Occurrence of the event

Calling up and closing the remedial measures

1. Press .
 - ↳ The message for the remedial measures for the selected diagnostic event opens.
2. Press  +  simultaneously.
 - ↳ The message about the remedial measures closes.

11.7.2 Filtering the event logbook

Filters can be used to determine which category of event messages is displayed in the **Event list** submenu.

Navigation: Diagnostics → Event logbook

Filter categories

- All
- Failure (F)
- Function check (C)
- Out of specification (S)
- Maintenance required (M)
- Information

11.7.3 Overview of information events

Info number	Info name
I1000	----- (Device ok)
I1079	Sensor changed
I1089	Power on
I1090	Configuration reset
I1091	Configuration changed
I11074	Device verification active
I1110	Write protection switch changed
I1151	History reset
I1154	Reset terminal voltage min/max
I1155	Reset electronics temperature
I1157	Memory error event list
I1256	Display: access status changed
I1335	Firmware changed
I1397	Fieldbus: access status changed
I1398	CDI: access status changed
I1440	Main electronic module changed
I1444	Device verification passed
I1445	Device verification failed
I1461	Sensor verification failed
I1512	Download started
I1513	Download finished
I1514	Upload started
I1515	Upload finished
I1551	Assignment error fixed
I1552	Failed: Main electronic verification
I1556	Safety mode off
I1956	Reset

11.8 Resetting the device

11.8.1 Reset password via operating tool

Enter a code to reset the current "Maintenance" password.
The code is delivered by your local support.

Navigation: System → User management → Reset password → Reset password

 For detailed information on the **Reset password** parameter: Description of device parameters.

11.8.2 Reset device via operating tool

Reset the device configuration - either entirely or in part - to a defined state

Navigation: System → Device management → Reset device

 For detailed information on the **Reset device** parameter: Description of device parameters.

11.8.3 Resetting the device via keys on the electronic insert

Resetting the password

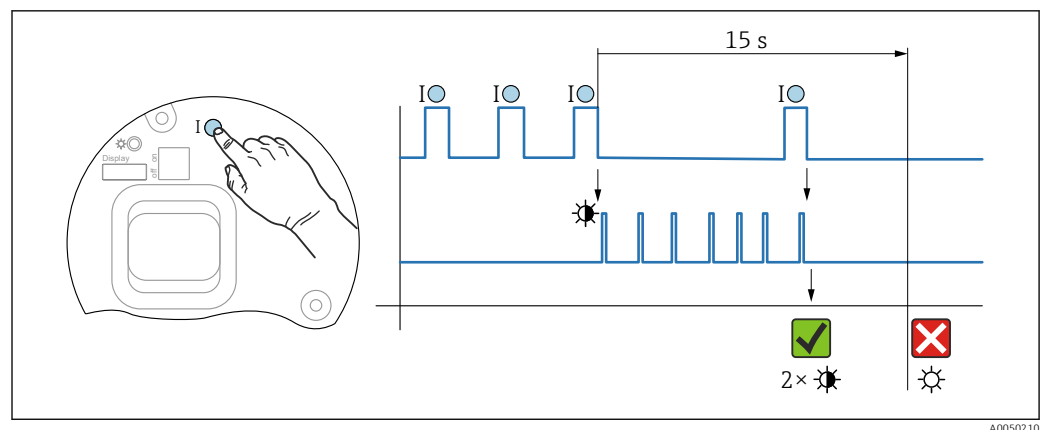

 17 Sequence for resetting the password

Delete/reset the password

1. Press operating key **I** three times.
 - ↳ The reset password function is started, the LED flashes.
2. Press operating key **I** once within 15 s.
 - ↳ The password is reset, the LED flashes briefly.

If operating key **I** is not pressed within 15 s, the action is canceled and the LED is no longer lit.

Resetting the device to the factory setting

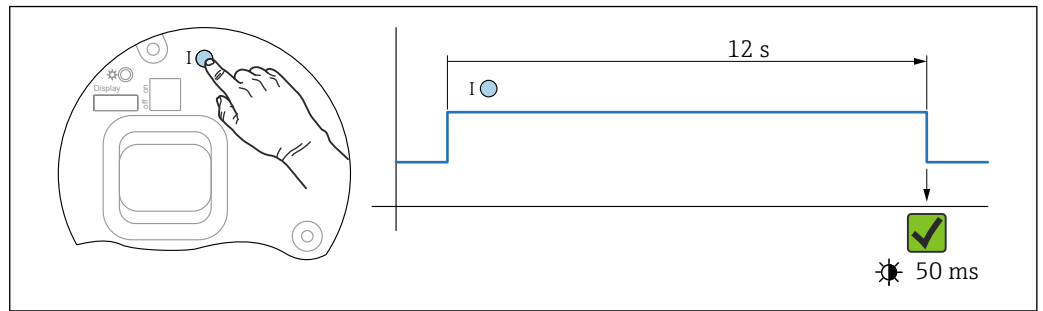

18 Sequence - Factory setting

A0050015

Reset the device to the factory setting

- ▶ Press operating key **I** for at least 12 s.
 - ↳ Device data are reset to the factory setting, the LED flashes briefly.

11.9 Device information

All device information is contained in the **Information** submenu.

Navigation: System → Information

For detailed information on the **Information** submenu: Description of device parameters.

11.10 Firmware history

The firmware version can explicitly be ordered via the product structure. This makes it possible to ensure the compatibility of the firmware version with an existing or planned system integration.

Version

01.00.00

- Initial software
- Valid from: 11.01.2023

12 Maintenance

No special maintenance work is required.

12.1 Cleaning

12.1.1 Cleaning of surfaces not in contact with the medium

- Recommendation: Use a lint-free cloth that is either dry or slightly dampened using water.
- Do not use any sharp objects or aggressive cleaning agents that corrode the surfaces (displays, housing, for example) and seals.
- Do not use high-pressure steam.
- Observe the degree of protection of the device.

 The cleaning agent used must be compatible with the materials of the device configuration. Do not use cleaning agents with concentrated mineral acids, bases or organic solvents.

12.1.2 Cleaning of surfaces in contact with the medium

Note the following for cleaning and sterilization in place (CIP/SIP):

- Use only cleaning agents to which the materials in contact with the medium are sufficiently resistant.
- Observe the permitted maximum medium temperature.

12.2 Seals

 The process seals, located on the process connection of the device, should be replaced periodically. The interval between changes depends on the frequency of the cleaning cycles, the cleaning temperature and the medium temperature.

13 Repair

13.1 General information

13.1.1 Repair concept

Endress+Hauser repair concept

- The devices have a modular design
- Repairs can be carried out by Endress+Hauser Service or by appropriately trained customers
- Spare parts are grouped into logical kits with the associated replacement instructions

 For more information on service and spare parts, please contact your Endress+Hauser sales representative.

13.1.2 Repairs to Ex-approved devices

WARNING

Incorrect repair can compromise electrical safety!

Explosion hazard!

- ▶ Only specialist personnel or the manufacturer's service team may carry out repairs on Ex-certified devices in accordance with national regulations.
- ▶ Relevant standards and national regulations on hazardous areas, safety instructions and certificates must be observed.
- ▶ Only use original spare parts from the manufacturer.
- ▶ Please note the device designation on the nameplate. Only identical parts may be used as replacements.
- ▶ Carry out repairs according to the instructions.
- ▶ Only the manufacturer's service team is permitted to modify a certified device and convert it to another certified version.

13.2 Spare parts



For spare parts currently available for the product, see online at:
<https://www.endress.com/deviceviewer> (→ Enter serial number)

13.3 Replacement

After an entire device or an electronics module has been replaced, the parameters can be downloaded to the device again via the communication interface. For this, the data must have been uploaded to the PC beforehand using the FieldCare/DeviceCare software.

13.3.1 HistoROM

It is not necessary to perform a new device calibration after replacing the display or transmitter electronics.

 The spare part is supplied without HistoROM.

After removing the transmitter electronics, remove HistoRom and insert it into the new spare part.

13.4 Return

The requirements for safe device return can vary depending on the device type and national legislation.

1. Refer to the web page for information:
<https://www.endress.com/support/return-material>
↳ Select the region.
2. If returning the device, pack the device in such a way that it is reliably protected against impact and external influences. The original packaging offers the best protection.

13.5 Disposal

-  If required by the Directive 2012/19/EU on waste electrical and electronic equipment (WEEE), the product is marked with the depicted symbol in order to minimize the disposal of WEEE as unsorted municipal waste. Do not dispose of products bearing this marking as unsorted municipal waste. Instead, return them to the manufacturer for disposal under the applicable conditions.

14 Accessories

14.1 Weather protection cover: 316L, XW112

The weather protection cover can be ordered together with the device via the "Accessory enclosed" product structure.

It is used to protect against direct sunlight, precipitation and ice.

Weather protection cover 316L is suitable for the dual compartment housing made of aluminum or 316L. The delivery includes the holder for direct mounting on the housing.

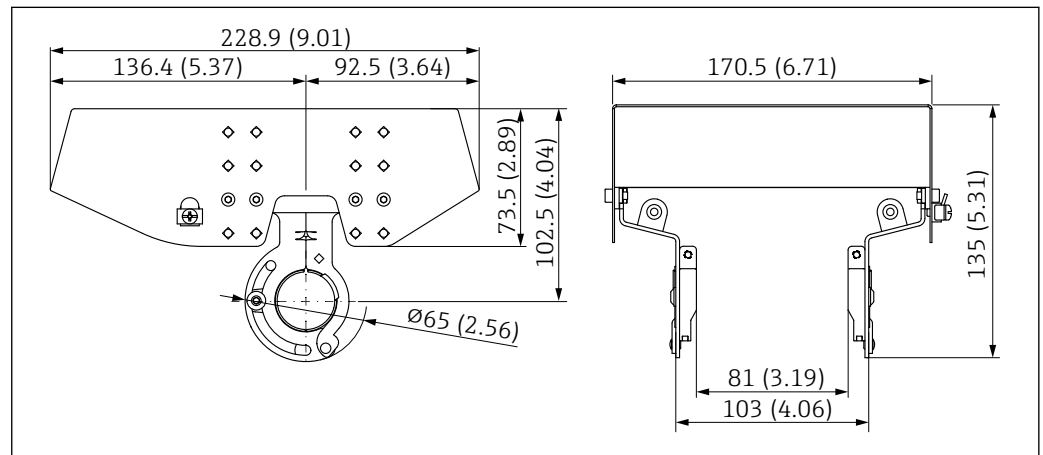

19 Dimensions of weather protection cover, 316 L, XW112. Unit of measurement mm (in)

Material

- Weather protection cover: 316L
- Clamping screw: A4
- Holder: 316L

Accessory order code:

71438303

 Special documentation SD02424F

14.2 Weather protection cover, plastic, XW111

The weather protection cover can be ordered together with the device via the "Accessory enclosed" product structure.

It is used to protect against direct sunlight, precipitation and ice.

The plastic weather protection cover is suitable for the single compartment housing made of aluminum. The delivery includes the holder for direct mounting on the housing.

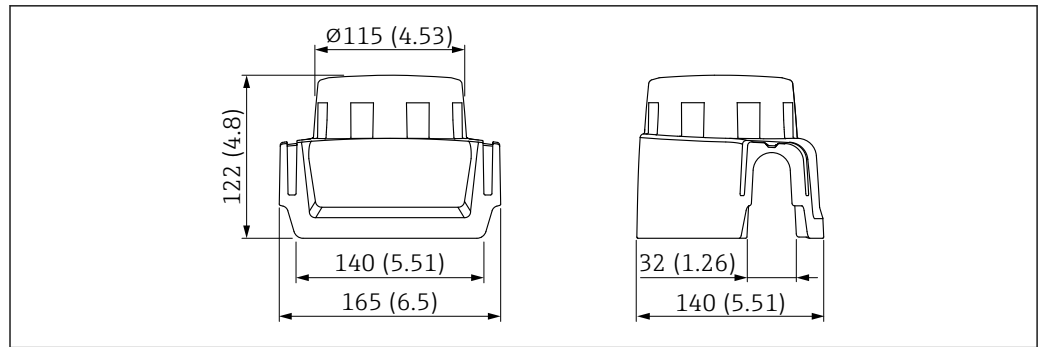

A0038280

20 Dimensions of weather protection cover, plastic, XW111. Unit of measurement mm (in)

Material

Plastic

Accessory order code:

71438291

 Special documentation SD02423F

14.3 Remote display FHX50B

The remote display is ordered via the Product Configurator.

If the remote display is to be used, the device version **Prepared for display FHX50B** must be ordered.

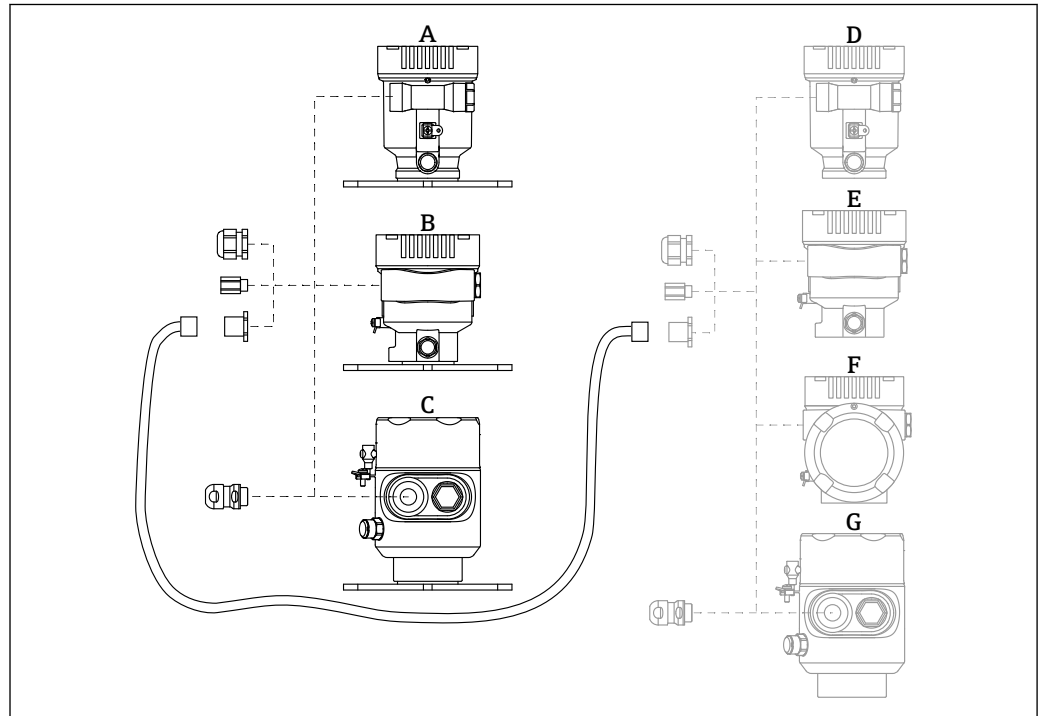

A0046692

- A Single compartment housing, plastic, remote display
- B Single compartment housing, aluminum, remote display
- C Single-compartment housing, 316L hygiene, remote display
- D Device side, single compartment housing, plastic, prepared for FHX50B display
- E Device side, single compartment housing, aluminum, prepared for FHX50B display
- F Device side, dual compartment housing, L-shaped, prepared for FHX50B display
- G Device side, single compartment housing, 316 L hygiene, prepared for FHX50B display

Single compartment housing material, remote display

- Aluminum
- Plastic

Degree of protection:

- IP68 / NEMA 6P
- IP66 / NEMA 4x

Connecting cable:

- Connecting cable (option) up to 30 m (98 ft)
- Standard cable supplied by customer up to 60 m (197 ft)
Recommendation: EtherLine®-P CAT.5e from LAPP.

Specification of customer-supplied connecting cable

Push-in CAGE CLAMP® connection technology, push actuation

- Conductor cross-section:
 - Solid conductor 0.2 to 0.75 mm² (24 to 18 AWG)
 - Fine-stranded conductor 0.2 to 0.75 mm² (24 to 18 AWG)
 - Fine-stranded conductor; with insulated ferrule 0.25 to 0.34 mm²
 - Fine-stranded conductor; without insulated ferrule 0.25 to 0.34 mm²
- Stripping length 7 to 9 mm (0.28 to 0.35 in)
- Outer diameter: 6 to 10 mm (0.24 to 0.4 in)
- Maximum cable length: 60 m (197 ft)

Ambient temperature:

- -40 to +80 °C (-40 to +176 °F)
- Option: -50 to +80 °C (-58 to +176 °F)

 Special documentation SD02991F

14.4 Gas-tight feedthrough

Chemically inert glass feedthrough, which prevents gases from entering the electronics housing.

Can optionally be ordered as "Accessory mounted" via the product structure.

14.5 M24 process adapter

 For details, refer to TI00426F/00/EN "Weld-in adapters, process adapters and flanges".

14.6 Field Xpert SMT70

Universal, high-performance tablet PC for device configuration in Ex Zone 2 and non-Ex areas

 Technical Information TI01342S

14.7 DeviceCare SFE100

Configuration tool for HART, PROFIBUS and FOUNDATION Fieldbus field devices

 Technical Information TI01134S

14.8 FieldCare SFE500

FDT-based plant asset management tool

It can configure all smart field units in your system and helps you manage them. By using the status information, it is also a simple but effective way of checking their status and condition.



Technical Information TI00028S

14.9 RID14

8-channel field indicator for fieldbus systems

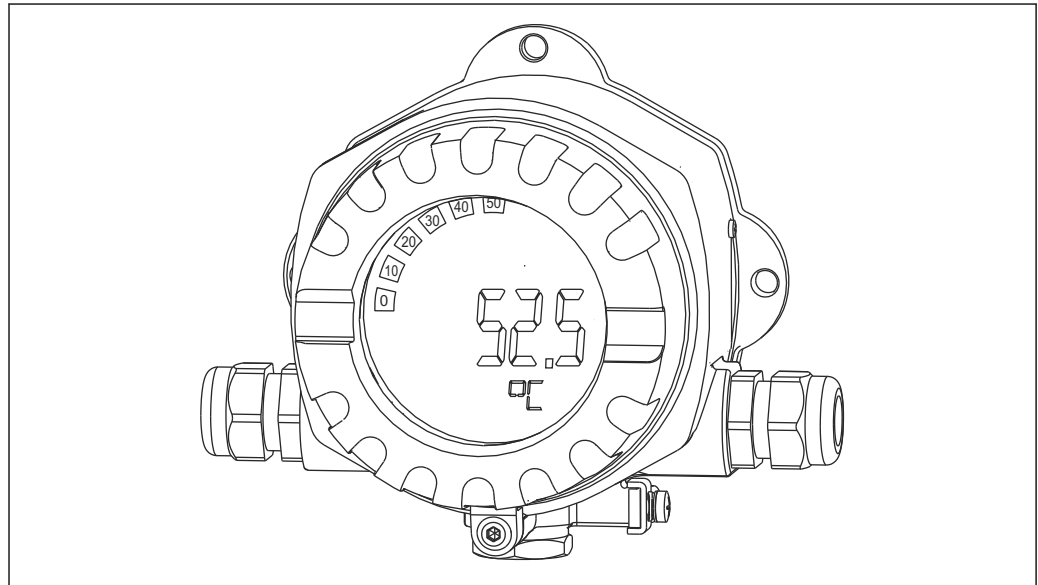

A0011631

Displays 8 process- or calculated values for FOUNDATION Fieldbus™ or PROFIBUS® PA protocol



Technical Information TI00145R and Operating Instructions BA01267K

14.10 RID16

8-channel field indicator for fieldbus systems

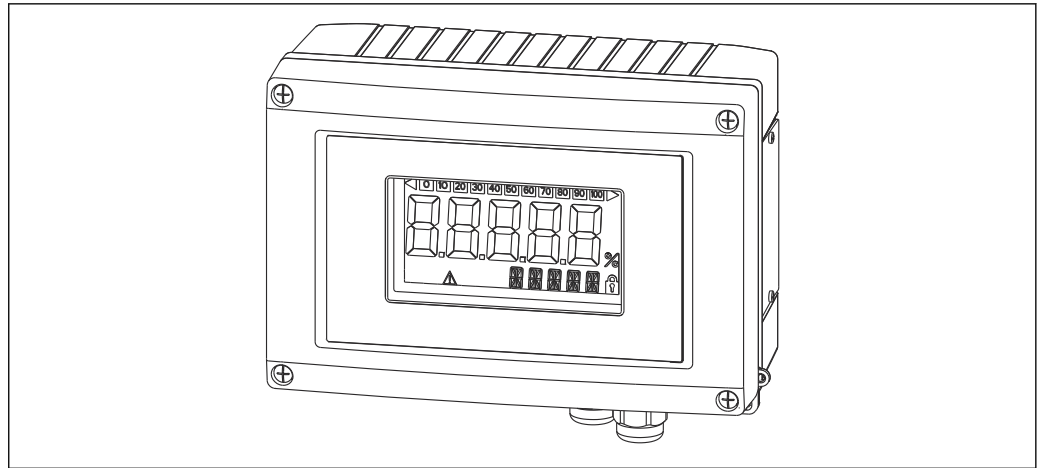

A0011634

Displays 8 process- or calculated values for FOUNDATION Fieldbus™ or PROFIBUS® PA protocol

 Technical Information TI00146R and Operating Instructions BA00284R

14.11 Fieldgate SFG500

Smart Ethernet/PROFIBUS gateway

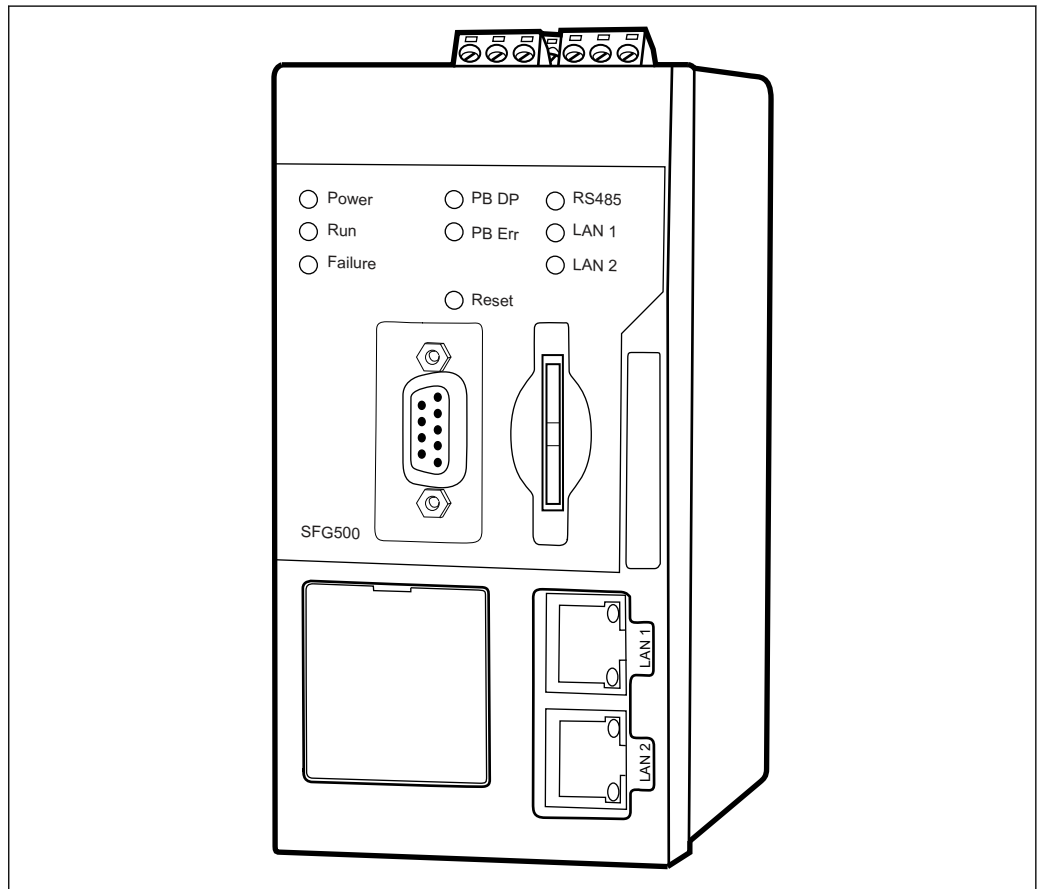

A0028262

Parallel access to PROFIBUS networks, PROFIBUS and HART device status monitoring

Ethernet gateway basic mode with integrated web server and adaptive PROFIBUS master, Class 2 for communication with PROFIBUS devices.

Order number for accessories:

71116672



Operating Instructions BA01579S

15 Technical data

15.1 Input

Measured variable The measured variable is the distance between the reference point and the product surface. The level is calculated based on "E", the empty distance entered.

Measuring range The measuring range starts at the point where the beam hits the tank floor. Levels below this point cannot be measured, particularly in the case of spherical bases or conical outlets.

Maximum measuring range

The maximum measuring range depends on the antenna size and design.

Antenna	Maximum measuring range
Integrated, PEEK, 20 mm (0.75 in)	10 m (32.8 ft)
PTFE-cladded, flush mount 50 mm (2 in)	50 m (164 ft)
PTFE-cladded, flush mount 80 mm (3 in)	80 m (262 ft)
PEEK-cladded, flush mount 20 mm (0.75 in)	10 m (32.8 ft)
PEEK-cladded, flush mount 40 mm (1.5 in)	22 m (72 ft)

Usable measuring range

The usable measuring range depends on the antenna size, the medium's reflective properties, the installation position and any possible interference reflections.

In principle, measurement is possible up to the tip of the antenna.

To avoid any material damage from corrosive or aggressive media or deposit buildup on the antenna, the end of the measuring range should be selected 10 mm (0.4 in) before the tip of the antenna.

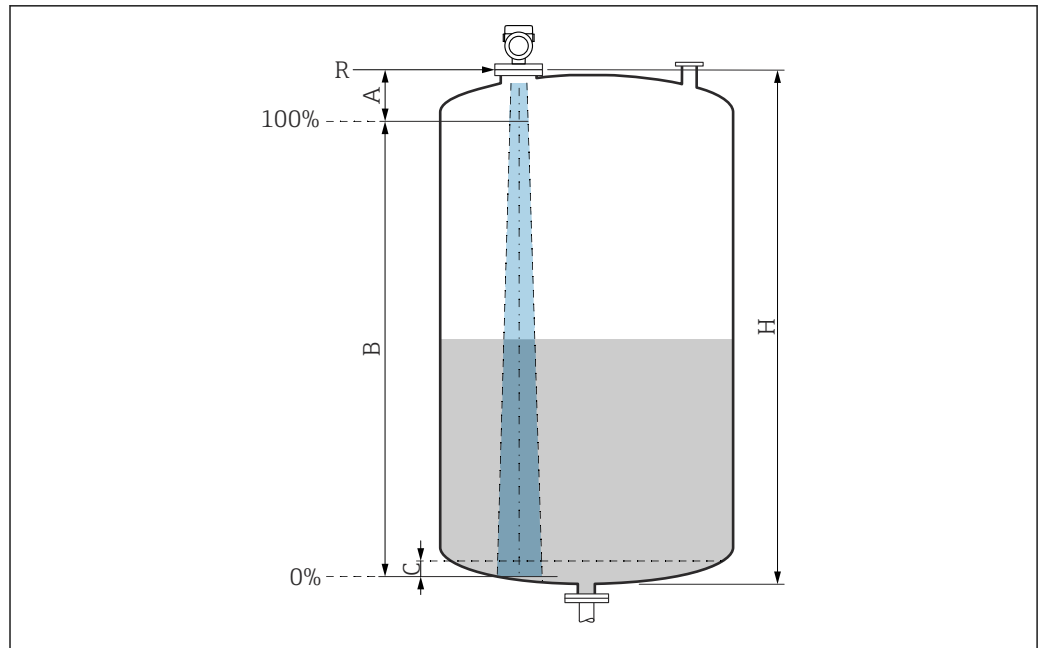

A0051658

21 Usable measuring range

A Length of antenna + 10 mm (0.4 in)

B Usable measuring range

C 50 to 80 mm (1.97 to 3.15 in); medium $\epsilon_r < 2$

H Vessel height

R Reference point of measurement, varies depending on the antenna system

For further information on the reference point, see → Mechanical construction.

In the case of media with a low dielectric constant, $\epsilon_r < 2$, the tank floor may be visible through the medium at very low levels (lower than level C). Reduced accuracy must be expected in this range. If this is not acceptable, the zero point should be positioned at a distance C above the tank floor in these applications → Usable measuring range.

The media groups and the possible measuring range are described as a function of the application and media group in the following section. If the dielectric constant of the medium is not known, to ensure a reliable measurement assume the medium belongs to group B.

Media groups

- **A0** (ϵ_r 1.2 to 1.4)
e.g. n-butane, liquid nitrogen, liquid hydrogen
- **A** (ϵ_r 1.4 to 1.9)
Non-conductive liquids, e.g. liquefied gas
- **B** (ϵ_r 1.9 to 4)
Non-conductive liquids, e.g. gasoline, oil, toluene, etc.
- **C** (ϵ_r 4 to 10)
e.g. concentrated acid, organic solvents, ester, aniline, etc.
- **D** ($\epsilon_r >10$)
Conductive liquids, aqueous solutions, diluted acids, bases and alcohol

i Measurement of the following media with absorbing gas phase

For example:

- Ammonia
- Acetone
- Methylene chloride
- Methyl ethyl ketone
- Propylene oxide
- VCM (vinyl chloride monomer)

To measure absorbing gases, either use a guided radar, measuring devices with another measuring frequency or another measuring principle.

If measurements must be performed in one of these media, please contact Endress+Hauser.

i For the relative permittivity values (ϵ_r values) of many media commonly used in industry, please refer to:

- Relative permittivity (ϵ_r value), Compendium CP01076F
- The Endress+Hauser "DC Values app" (available for Android and iOS)

Measurement in storage container

Storage vessel - measuring conditions

Calm medium surface (e.g. bottom filling, filling via immersion tube or rare filling from above)

Integrated antenna, PEEK, 20 mm (0.75 in) in storage vessel

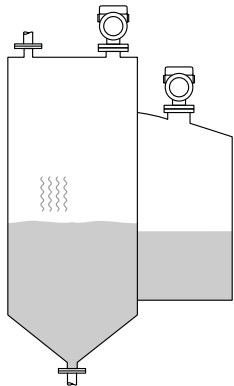
	Media group	Measuring range
	A0 (ϵ_r 1.2 to 1.4)	1.5 m (5 ft)
	A (ϵ_r 1.4 to 1.9)	2.5 m (8 ft)
	B (ϵ_r 1.9 to 4)	5 m (16 ft)
	C (ϵ_r 4 to 10)	8 m (26 ft)
	D ($\epsilon_r >10$)	10 m (33 ft)

Antenna, PTFE cladded flush mount, 50 mm (2 in) in storage vessel

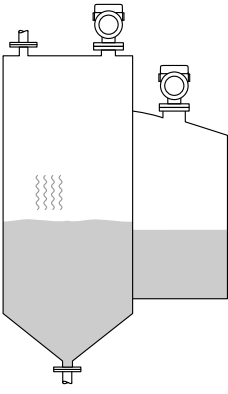
	Media group	Measuring range
	A0 (ϵ_r 1.2 to 1.4)	7 m (23 ft)
	A (ϵ_r 1.4 to 1.9)	12 m (39 ft)
	B (ϵ_r 1.9 to 4)	23 m (75 ft)
	C (ϵ_r 4 to 10)	40 m (131 ft)
	D ($\epsilon_r >10$)	50 m (164 ft)

Antenna, PTFE cladded flush mount, 80 mm (3 in) in storage vessel

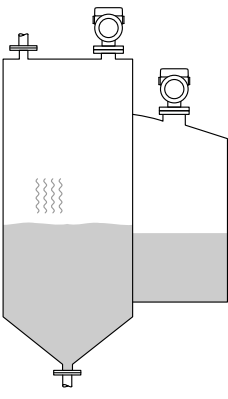
	Media group	Measuring range
	A0 (ϵ_r 1.2 to 1.4)	22 m (72 ft)
	A (ϵ_r 1.4 to 1.9)	40 m (131 ft)
	B (ϵ_r 1.9 to 4)	50 m (164 ft)
	C (ϵ_r 4 to 10)	65 m (231 ft)
	D ($\epsilon_r >10$)	80 m (262 ft)

Antenna, PTFE-cladded, flush mount, 20 mm (0.75 in) in the storage container

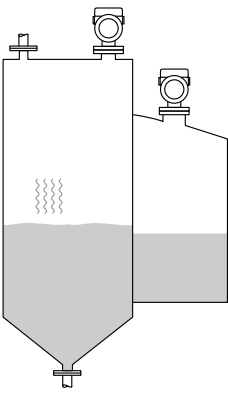
	Media group	Measuring range
	A0 (ϵ_r 1.2 to 1.4)	1.5 m (5 ft)
	A (ϵ_r 1.4 to 1.9)	2.5 m (8 ft)
	B (ϵ_r 1.9 to 4)	5 m (16 ft)
	C (ϵ_r 4 to 10)	8 m (26 ft)
	D ($\epsilon_r >10$)	10 m (33 ft)

Antenna, PTFE-cladded, flush mount, 40 mm (1.5 in) in the storage container

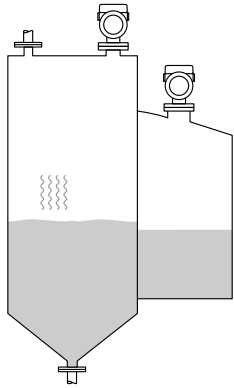
	Media group	Measuring range
	A0 (ϵ_r 1.2 to 1.4)	3 m (10 ft)
	A (ϵ_r 1.4 to 1.9)	6 m (20 ft)
	B (ϵ_r 1.9 to 4)	11 m (36 ft)
	C (ϵ_r 4 to 10)	15 m (49 ft)
	D (ϵ_r >10)	22 m (72 ft)

Measurement in the buffer vessel

Buffer vessel - measuring conditions

Moving medium surface (e.g. permanent free filling from above, mixing jets)

Integrated antenna, PEEK, 20 mm (0.75 in) in buffer vessel

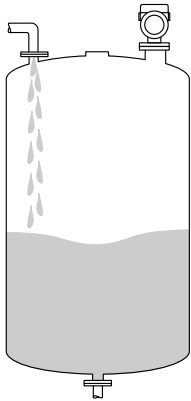
	Media group	Measuring range
	A0 (ϵ_r 1.2 to 1.4)	1 m (3.3 ft)
	A (ϵ_r 1.4 to 1.9)	1.5 m (5 ft)
	B (ϵ_r 1.9 to 4)	3 m (10 ft)
	C (ϵ_r 4 to 10)	6 m (20 ft)
	D (ϵ_r >10)	8 m (26 ft)

Antenna, PTFE cladded flush mount, 50 mm (2 in) in buffer vessel

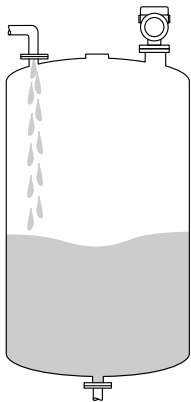
	Media group	Measuring range
	A0 (ϵ_r 1.2 to 1.4)	4 m (13 ft)
	A (ϵ_r 1.4 to 1.9)	7 m (23 ft)
	B (ϵ_r 1.9 to 4)	13 m (43 ft)
	C (ϵ_r 4 to 10)	28 m (92 ft)
	D (ϵ_r >10)	44 m (144 ft)

Antenna, PTFE cladded flush mount, 80 mm (3 in) in buffer vessel

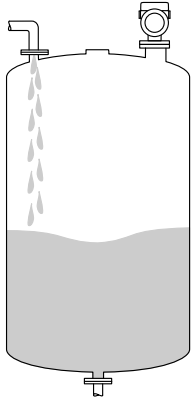
	Media group	Measuring range
	A0 (ϵ_r 1.2 to 1.4)	12 m (39 ft)
	A (ϵ_r 1.4 to 1.9)	23 m (75 ft)
	B (ϵ_r 1.9 to 4)	45 m (148 ft)
	C (ϵ_r 4 to 10)	60 m (197 ft)
	D (ϵ_r >10)	70 m (230 ft)

Antenna, PTFE-cladded, flush mount, 20 mm (0.75 in) in the buffer vessel

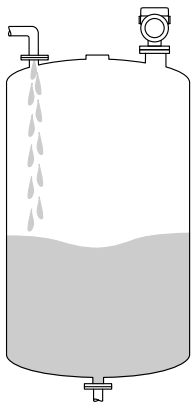
	Media group	Measuring range
	A0 (ϵ_r 1.2 to 1.4)	1 m (3.3 ft)
	A (ϵ_r 1.4 to 1.9)	1.5 m (5 ft)
	B (ϵ_r 1.9 to 4)	3 m (10 ft)
	C (ϵ_r 4 to 10)	6 m (20 ft)
	D (ϵ_r >10)	8 m (26 ft)

Antenna, PTFE-cladded, flush mount, 40 mm (1.5 in) in the buffer vessel

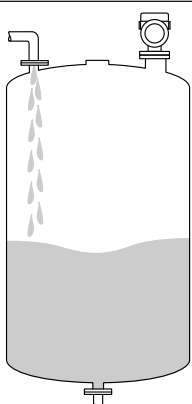
	Media group	Measuring range
	A0 (ϵ_r 1.2 to 1.4)	1.5 m (5 ft)
	A (ϵ_r 1.4 to 1.9)	3 m (10 ft)
	B (ϵ_r 1.9 to 4)	6 m (20 ft)
	C (ϵ_r 4 to 10)	13 m (43 ft)
	D (ϵ_r >10)	20 m (66 ft)

Measurement in the vessel with agitator

Vessel with agitator - measuring conditions

Turbulent medium surface (e.g. from filling from above, stirrers and baffles)

Integrated antenna, PEEK, 20 mm (0.75 in) in vessel with agitator

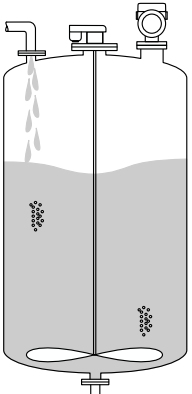
	Media group	Measuring range
	A (ϵ_r 1.4 to 1.9)	1 m (3.3 ft)
	B (ϵ_r 1.9 to 4)	1.5 m (5 ft)
	C (ϵ_r 4 to 10)	3 m (10 ft)
	D (ϵ_r >10)	5 m (16 ft)

Antenna, PTFE clad flush mount, 50 mm (2 in) in vessel with agitator

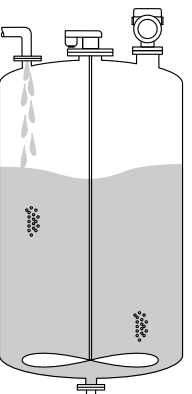
	Media group	Measuring range
	A0 (ϵ_r 1.2 to 1.4)	2 m (7 ft)
	A (ϵ_r 1.4 to 1.9)	4 m (13 ft)
	B (ϵ_r 1.9 to 4)	7 m (23 ft)
	C (ϵ_r 4 to 10)	15 m (49 ft)
	D (ϵ_r >10)	25 m (82 ft)

Antenna, PTFE clad flush mount, 80 mm (3 in) in vessel with agitator

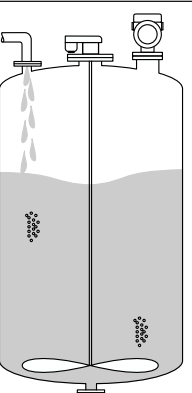
	Media group	Measuring range
	A0 (ϵ_r 1.2 to 1.4)	7 m (23 ft)
	A (ϵ_r 1.4 to 1.9)	13 m (43 ft)
	B (ϵ_r 1.9 to 4)	25 m (82 ft)
	C (ϵ_r 4 to 10)	50 m (164 ft)
	D (ϵ_r >10)	60 m (197 ft)

Antenna, PTFE-cladded, flush mount, 20 mm (0.75 in) in the container with agitator

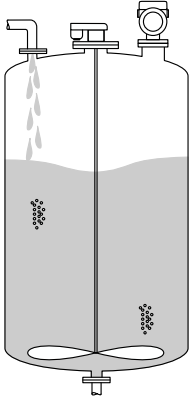
	Media group	Measuring range
	A (ϵ_r 1.4 to 1.9)	1 m (3.3 ft)
	B (ϵ_r 1.9 to 4)	1.5 m (5 ft)
	C (ϵ_r 4 to 10)	3 m (10 ft)
	D ($\epsilon_r >10$)	5 m (16 ft)

Antenna, PTFE-cladded, flush mount, 40 mm (1.5 in) in the container with agitator

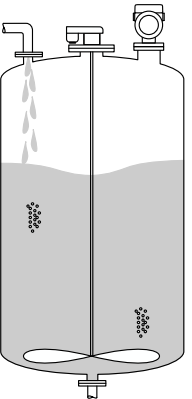
	Media group	Measuring range
	A0 (ϵ_r 1.2 to 1.4)	1 m (3.3 ft)
	A (ϵ_r 1.4 to 1.9)	1.5 m (5 ft)
	B (ϵ_r 1.9 to 4)	3 m (10 ft)
	C (ϵ_r 4 to 10)	7 m (23 ft)
	D ($\epsilon_r >10$)	11 m (36 ft)

Operating frequency Approx. 80 GHz
 Up to 8 devices can be installed in a tank without the devices mutually influencing one another.

Transmission power ■ Peak power: <1.5 mW
 ■ Average output power: <70 μ W

15.2 Output

PROFIBUS PA According to EN 50170 Volume 2, IEC 61158-2

Signal coding:
 Manchester Bus Powered (MBP) type 1

Data transmission rate:
 31.25 kBit/s, voltage mode

Galvanic isolation:
 Yes

Signal on alarm Diagnostics in accordance with PROFIBUS PA Profile 3.02

Local display

Status signal (in accordance with NAMUR Recommendation NE 107):
Plain text display

Operating tool via service interface (CDI)

Status signal (in accordance with NAMUR Recommendation NE 107):
Plain text display

Operating tool via PROFIBUS PA communication

Status signal (in accordance with NAMUR Recommendation NE 107):
Plain text display

Linearization

The linearization function of the device allows the conversion of the measured value into any unit of length, weight, flow or volume.

Pre-programmed linearization curves

Linearization tables for calculating the volume in the following vessels are preprogrammed into the device:

- Pyramid bottom
- Conical bottom
- Angled bottom
- Horizontal cylinder
- Sphere

Other linearization tables of up to 32 value pairs can be entered manually.

Protocol-specific data

PROFIBUS PA**Manufacturer ID:**

17 (0x11)

Ident number:

0x1568 or 0x9700

Profile version:

3.02

GSD file and version

Information and files available at:

- www.endress.com
On the product page for the device: Documents/Software → Device drivers
- www.profibus.com

*Output values***Analog Input:**

- Level linearized
- Distance
- Volume
- Terminal voltage
- Electronics temperature
- Sensor temperature
- Absolute echo amplitude
- Relative echo amplitude
- Area of incoupling
- Buildup index, optional (Guidance → Heartbeat Technology → Buildup detection → Buildup index)
- Foam index, optional (Diagnostics → Heartbeat Technology → Foam detection → Foam index)

Digital Input:

 Is only available if the "Heartbeat Verification + Monitoring" application package was selected.

- 168 Build-up detected, optional (Guidance → Heartbeat Technology → Buildup detection → 168 Build-up detected)
- 952 Foam detected, optional (Guidance → Heartbeat Technology → Foam detection → 952 Foam detected)

Input values

Analog Output:

Analog value from PLC to be indicated on the display

Supported functions

- Identification & maintenance
Straightforward device identification on the part of the control system and nameplate
- Automatic Ident Number adoption
GSD compatibility mode for generic profile 0x9700 "Transmitter with 1 Analog Input"
- Physical layer diagnostics
Installation check of the PROFIBUS segment and device using terminal voltage and message monitoring
- PROFIBUS upload/download
Reading and writing parameters is up to ten times faster with PROFIBUS upload/download
- Condensed status
Straightforward and self-explanatory diagnostic information by categorizing diagnostic messages that occur

15.3 Environment

Ambient temperature range

The following values apply up to a process temperature of +85 °C (+185 °F). At higher process temperatures, the permitted ambient temperature is reduced.

- Without LCD display:
Standard: -40 to +85 °C (-40 to +185 °F)
- With LCD display: -40 to +85 °C (-40 to +185 °F) with limitations in optical properties such as display speed and contrast for example. Can be used without limitations up to -20 to +60 °C (-4 to +140 °F)

 If operating outdoors in strong sunlight:

- Mount the device in the shade.
- Avoid direct sunlight, particularly in warm climatic regions.
- Use a weather protection cover (see accessories).

Ambient temperature limits

The permitted ambient temperature (T_a) depends on the selected housing material (Product Configurator → Housing; Material →) and the selected process temperature range (Product Configurator → Application →).

In the event of temperature (T_p) at the process connection, the permitted ambient temperature (T_a) is reduced.

 The following information only takes functional aspects into consideration. Additional restrictions may apply for certified device versions.

Plastic housing

Plastic housing; process temperature -10 to $+150$ °C ($+14$ to $+302$ °F)

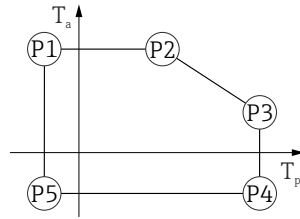

A0032024

▣ 22 Plastic housing; process temperature -10 to $+150$ °C ($+14$ to $+302$ °F)

P1 = $T_p: -10$ °C ($+14$ °F) | $T_a: +76$ °C ($+169$ °F)

P2 = $T_p: +76$ °C ($+169$ °F) | $T_a: +76$ °C ($+169$ °F)

P3 = $T_p: +150$ °C ($+302$ °F) | $T_a: +25$ °C ($+77$ °F)

P4 = $T_p: +150$ °C ($+302$ °F) | $T_a: -10$ °C ($+14$ °F)

P5 = $T_p: -10$ °C ($+14$ °F) | $T_a: -10$ °C ($+14$ °F)

i The selected process temperature range is restricted from -10 to $+150$ °C ($+14$ to $+302$ °F) to 0 to $+150$ °C ($+32$ to $+302$ °F) in devices with a plastic housing and CSA C/US approval.

Process temperature restricted to 0 to $+150$ °C ($+32$ to $+302$ °F) for CSA C/US approval and plastic housing

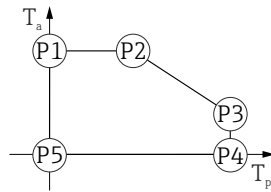

A0048826

▣ 23 Plastic housing; process temperature 0 to $+150$ °C ($+32$ to $+302$ °F) for CSA C/US approval

P1 = $T_p: 0$ °C ($+32$ °F) | $T_a: +76$ °C ($+169$ °F)

P2 = $T_p: +76$ °C ($+169$ °F) | $T_a: +76$ °C ($+169$ °F)

P3 = $T_p: +150$ °C ($+302$ °F) | $T_a: +25$ °C ($+77$ °F)

P4 = $T_p: +150$ °C ($+302$ °F) | $T_a: 0$ °C ($+32$ °F)

P5 = $T_p: 0$ °C ($+32$ °F) | $T_a: 0$ °C ($+32$ °F)

Plastic housing; process temperature -10 to $+200$ °C ($+14$ to $+392$ °F)

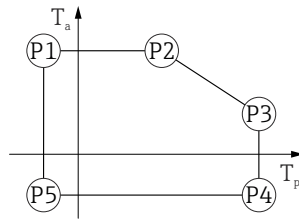

A0032024

24 Plastic housing; process temperature -10 to $+200$ °C ($+14$ to $+392$ °F)

- P1 = T_p : -10 °C ($+14$ °F) | T_a : $+76$ °C ($+169$ °F)
- P2 = T_p : $+76$ °C ($+169$ °F) | T_a : $+76$ °C ($+169$ °F)
- P3 = T_p : $+200$ °C ($+392$ °F) | T_a : $+27$ °C ($+81$ °F)
- P4 = T_p : $+200$ °C ($+392$ °F) | T_a : -10 °C ($+14$ °F)
- P5 = T_p : -10 °C ($+14$ °F) | T_a : -10 °C ($+14$ °F)

i The selected process temperature range is restricted from -10 to $+200$ °C ($+14$ to $+392$ °F) to 0 to $+200$ °C ($+32$ to $+392$ °F) in devices with a plastic housing and CSA C/US approval.

Process temperature restricted to 0 to $+200$ °C ($+32$ to $+392$ °F) for CSA C/US approval and plastic housing

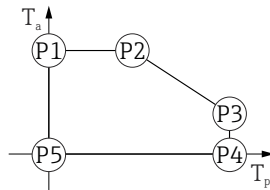

A0048826

25 Plastic housing; process temperature 0 to $+200$ °C ($+32$ to $+392$ °F) for CSA C/US approval

- P1 = T_p : 0 °C ($+32$ °F) | T_a : $+76$ °C ($+169$ °F)
- P2 = T_p : $+76$ °C ($+169$ °F) | T_a : $+76$ °C ($+169$ °F)
- P3 = T_p : $+200$ °C ($+392$ °F) | T_a : $+27$ °C ($+81$ °F)
- P4 = T_p : $+200$ °C ($+392$ °F) | T_a : 0 °C ($+32$ °F)
- P5 = T_p : 0 °C ($+32$ °F) | T_a : 0 °C ($+32$ °F)

Plastic housing; process temperature -20 to $+150$ °C (-4 to $+302$ °F)

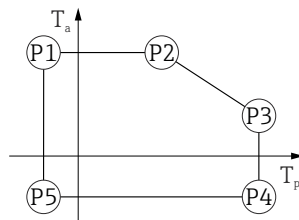

A0032024

26 Plastic housing; process temperature -20 to $+150$ °C (-4 to $+302$ °F)

- P1 = T_p : -20 °C (-4 °F) | T_a : $+76$ °C ($+169$ °F)
- P2 = T_p : $+76$ °C ($+169$ °F) | T_a : $+76$ °C ($+169$ °F)
- P3 = T_p : $+150$ °C ($+302$ °F) | T_a : $+25$ °C ($+77$ °F)
- P4 = T_p : $+150$ °C ($+302$ °F) | T_a : -20 °C (-4 °F)
- P5 = T_p : -20 °C (-4 °F) | T_a : -20 °C (-4 °F)

i In the case of devices with a plastic housing and CSA C/US approval, the selected process temperature of -20 to $+150$ °C (-4 to $+302$ °F) is limited to 0 to $+150$ °C ($+32$ to $+302$ °F).

Restriction to a process temperature of 0 to +150 °C (+32 to +302 °F) with CSA C/US approval and plastic housing

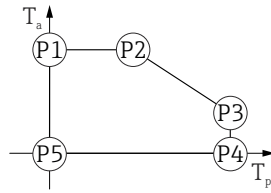

A0048826

27 Plastic housing; process temperature 0 to +150 °C (+32 to +302 °F) with CSA C/US approval

- P1 = T_p : 0 °C (+32 °F) | T_a : +76 °C (+169 °F)
- P2 = T_p : +76 °C (+169 °F) | T_a : +76 °C (+169 °F)
- P3 = T_p : +150 °C (+302 °F) | T_a : +25 °C (+77 °F)
- P4 = T_p : +150 °C (+302 °F) | T_a : 0 °C (+32 °F)
- P5 = T_p : 0 °C (+32 °F) | T_a : 0 °C (+32 °F)

Plastic housing; process temperature -20 to +200 °C (-4 to +392 °F)

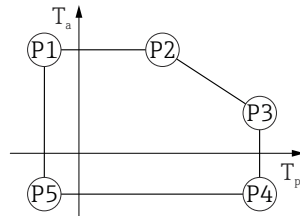

A0032024

28 Plastic housing; process temperature -20 to +200 °C (-4 to +392 °F)

- P1 = T_p : -20 °C (-4 °F) | T_a : +76 °C (+169 °F)
- P2 = T_p : +76 °C (+169 °F) | T_a : +76 °C (+169 °F)
- P3 = T_p : +200 °C (+392 °F) | T_a : +27 °C (+81 °F)
- P4 = T_p : +200 °C (+392 °F) | T_a : -20 °C (-4 °F)
- P5 = T_p : -20 °C (-4 °F) | T_a : -20 °C (-4 °F)

i In the case of devices with a plastic housing and CSA C/US approval, the selected process temperature of -20 to +200 °C (-4 to +392 °F) is limited to 0 to +200 °C (+32 to +392 °F).

Restriction to a process temperature of 0 to +200 °C (+32 to +392 °F) with CSA C/US approval and plastic housing

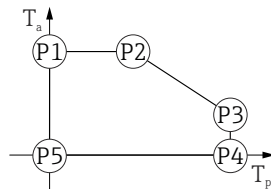

A0048826

29 Plastic housing; process temperature 0 to +200 °C (+32 to +392 °F) with CSA C/US approval

- P1 = T_p : 0 °C (+32 °F) | T_a : +76 °C (+169 °F)
- P2 = T_p : +76 °C (+169 °F) | T_a : +76 °C (+169 °F)
- P3 = T_p : +200 °C (+392 °F) | T_a : +27 °C (+81 °F)
- P4 = T_p : +200 °C (+392 °F) | T_a : 0 °C (+32 °F)
- P5 = T_p : 0 °C (+32 °F) | T_a : 0 °C (+32 °F)

Plastic housing; process temperature -40 to $+150$ °C (-40 to $+302$ °F)

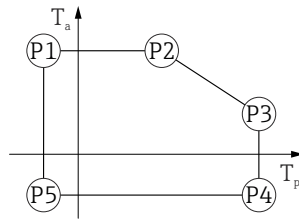

A0032024

30 Plastic housing; process temperature -40 to $+150$ °C (-40 to $+302$ °F)

- P1 = T_p : -40 °C (-40 °F) | T_a : $+76$ °C ($+169$ °F)
- P2 = T_p : $+76$ °C ($+169$ °F) | T_a : $+76$ °C ($+169$ °F)
- P3 = T_p : $+150$ °C ($+302$ °F) | T_a : $+25$ °C ($+77$ °F)
- P4 = T_p : $+150$ °C ($+302$ °F) | T_a : -40 °C (-40 °F)
- P5 = T_p : -40 °C (-40 °F) | T_a : -40 °C (-40 °F)

i In the case of devices with a plastic housing and CSA C/US approval, the selected process temperature of -40 to $+150$ °C (-40 to $+302$ °F) is limited to 0 to $+150$ °C ($+32$ to $+302$ °F).

Restriction to a process temperature of 0 to $+150$ °C ($+32$ to $+302$ °F) with CSA C/US approval and plastic housing

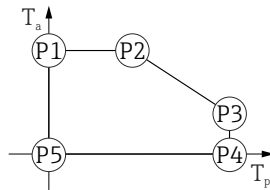

A0048826

31 Plastic housing; process temperature 0 to $+150$ °C ($+32$ to $+302$ °F) with CSA C/US approval

- P1 = T_p : 0 °C ($+32$ °F) | T_a : $+76$ °C ($+169$ °F)
- P2 = T_p : $+76$ °C ($+169$ °F) | T_a : $+76$ °C ($+169$ °F)
- P3 = T_p : $+150$ °C ($+302$ °F) | T_a : $+25$ °C ($+77$ °F)
- P4 = T_p : $+150$ °C ($+302$ °F) | T_a : 0 °C ($+32$ °F)
- P5 = T_p : 0 °C ($+32$ °F) | T_a : 0 °C ($+32$ °F)

Plastic housing; process temperature -40 to $+200$ °C (-40 to $+392$ °F)

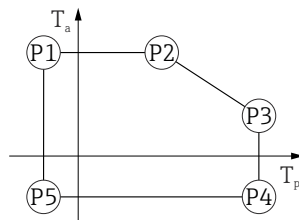

A0032024

32 Plastic housing; process temperature -40 to $+200$ °C (-40 to $+392$ °F)

- P1 = T_p : -40 °C (-40 °F) | T_a : $+76$ °C ($+169$ °F)
- P2 = T_p : $+76$ °C ($+169$ °F) | T_a : $+76$ °C ($+169$ °F)
- P3 = T_p : $+200$ °C ($+392$ °F) | T_a : $+27$ °C ($+81$ °F)
- P4 = T_p : $+200$ °C ($+392$ °F) | T_a : -40 °C (-40 °F)
- P5 = T_p : -40 °C (-40 °F) | T_a : -40 °C (-40 °F)

i In the case of devices with a plastic housing and CSA C/US approval, the selected process temperature of -40 to $+200$ °C (-40 to $+392$ °F) is limited to 0 to $+200$ °C ($+32$ to $+392$ °F).

Restriction to a process temperature of 0 to +200 °C (+32 to +392 °F) with CSA C/US approval and plastic housing

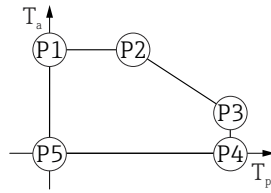

A0048826

33 Plastic housing; process temperature 0 to +200 °C (+32 to +392 °F) with CSA C/US approval

- P1 = T_p : 0 °C (+32 °F) | T_a : +76 °C (+169 °F)
- P2 = T_p : +76 °C (+169 °F) | T_a : +76 °C (+169 °F)
- P3 = T_p : +200 °C (+392 °F) | T_a : +27 °C (+81 °F)
- P4 = T_p : +200 °C (+392 °F) | T_a : 0 °C (+32 °F)
- P5 = T_p : 0 °C (+32 °F) | T_a : 0 °C (+32 °F)

Aluminum housing, coated

Aluminum housing; process temperature -10 to +150 °C (+14 to +302 °F)

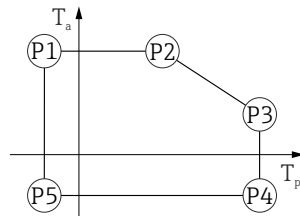

A0032024

34 Aluminum housing, coated; process temperature -10 to +150 °C (+14 to +302 °F)

- P1 = T_p : -10 °C (+14 °F) | T_a : +79 °C (+174 °F)
- P2 = T_p : +79 °C (+174 °F) | T_a : +79 °C (+174 °F)
- P3 = T_p : +150 °C (+302 °F) | T_a : +53 °C (+127 °F)
- P4 = T_p : +150 °C (+302 °F) | T_a : -10 °C (+14 °F)
- P5 = T_p : -10 °C (+14 °F) | T_a : -10 °C (+14 °F)

Aluminum housing; process temperature -10 to +200 °C (+14 to +392 °F)

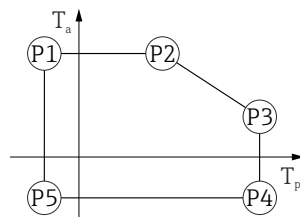

A0032024

35 Aluminum housing, coated; process temperature -10 to +200 °C (+14 to +392 °F)

- P1 = T_p : -10 °C (+14 °F) | T_a : +79 °C (+174 °F)
- P2 = T_p : +79 °C (+174 °F) | T_a : +79 °C (+174 °F)
- P3 = T_p : +200 °C (+392 °F) | T_a : +47 °C (+117 °F)
- P4 = T_p : +200 °C (+392 °F) | T_a : -10 °C (+14 °F)
- P5 = T_p : -10 °C (+14 °F) | T_a : -10 °C (+14 °F)

Aluminum housing; process temperature -20 to $+150$ °C (-4 to $+302$ °F)



A0032024

36 Aluminum housing, coated; process temperature -20 to $+150$ °C (-4 to $+302$ °F)

- P1 = T_p : -20 °C (-4 °F) | T_a : $+79$ °C ($+174$ °F)
- P2 = T_p : $+79$ °C ($+174$ °F) | T_a : $+79$ °C ($+174$ °F)
- P3 = T_p : $+150$ °C ($+302$ °F) | T_a : $+53$ °C ($+127$ °F)
- P4 = T_p : $+150$ °C ($+302$ °F) | T_a : -20 °C (-4 °F)
- P5 = T_p : -20 °C (-4 °F) | T_a : -20 °C (-4 °F)

Aluminum housing; process temperature -20 to $+200$ °C (-4 to $+392$ °F)

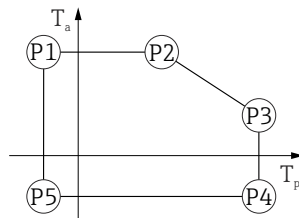

A0032024

37 Aluminum housing, coated; process temperature -20 to $+200$ °C (-4 to $+392$ °F)

- P1 = T_p : -20 °C (-4 °F) | T_a : $+79$ °C ($+174$ °F)
- P2 = T_p : $+79$ °C ($+174$ °F) | T_a : $+79$ °C ($+174$ °F)
- P3 = T_p : $+200$ °C ($+392$ °F) | T_a : $+47$ °C ($+117$ °F)
- P4 = T_p : $+200$ °C ($+392$ °F) | T_a : -20 °C (-4 °F)
- P5 = T_p : -20 °C (-4 °F) | T_a : -20 °C (-4 °F)

Aluminum housing; process temperature -40 to $+150$ °C (-40 to $+302$ °F)

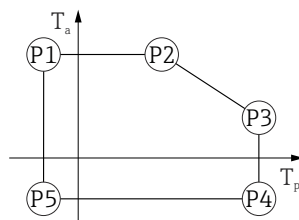

A0032024

38 Aluminum housing, coated; process temperature -40 to $+150$ °C (-40 to $+302$ °F)

- P1 = T_p : -40 °C (-40 °F) | T_a : $+79$ °C ($+174$ °F)
- P2 = T_p : $+79$ °C ($+174$ °F) | T_a : $+79$ °C ($+174$ °F)
- P3 = T_p : $+150$ °C ($+302$ °F) | T_a : $+53$ °C ($+127$ °F)
- P4 = T_p : $+150$ °C ($+302$ °F) | T_a : -40 °C (-40 °F)
- P5 = T_p : -40 °C (-40 °F) | T_a : -40 °C (-40 °F)

Aluminum housing; process temperature -40 to $+200$ °C (-40 to $+392$ °F)

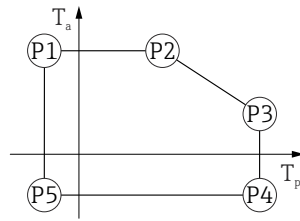

A0032024

▣ 39 Aluminum housing, coated; process temperature -40 to $+200$ °C (-40 to $+392$ °F)

- P1 = T_p : -40 °C (-40 °F) | T_a : $+79$ °C ($+174$ °F)
- P2 = T_p : $+79$ °C ($+174$ °F) | T_a : $+79$ °C ($+174$ °F)
- P3 = T_p : $+200$ °C ($+392$ °F) | T_a : $+47$ °C ($+117$ °F)
- P4 = T_p : $+200$ °C ($+392$ °F) | T_a : -40 °C (-40 °F)
- P5 = T_p : -40 °C (-40 °F) | T_a : -40 °C (-40 °F)

316L housing

316L housing; process temperature -10 to $+150$ °C ($+14$ to $+302$ °F)

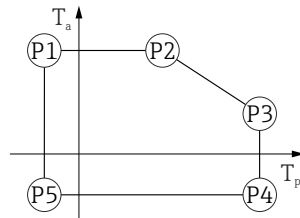

A0032024

▣ 40 316L housing; process temperature -10 to $+150$ °C ($+14$ to $+302$ °F)

- P1 = T_p : -10 °C ($+14$ °F) | T_a : $+77$ °C ($+171$ °F)
- P2 = T_p : $+77$ °C ($+171$ °F) | T_a : $+77$ °C ($+171$ °F)
- P3 = T_p : $+150$ °C ($+302$ °F) | T_a : $+43$ °C ($+109$ °F)
- P4 = T_p : $+150$ °C ($+302$ °F) | T_a : -10 °C ($+14$ °F)
- P5 = T_p : -10 °C ($+14$ °F) | T_a : -10 °C ($+14$ °F)

316L housing; process temperature -10 to $+200$ °C ($+14$ to $+392$ °F)

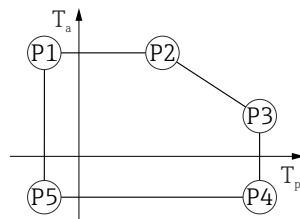

A0032024

▣ 41 316L housing; process temperature -10 to $+200$ °C ($+14$ to $+392$ °F)

- P1 = T_p : -10 °C ($+14$ °F) | T_a : $+77$ °C ($+171$ °F)
- P2 = T_p : $+77$ °C ($+171$ °F) | T_a : $+77$ °C ($+171$ °F)
- P3 = T_p : $+200$ °C ($+392$ °F) | T_a : $+38$ °C ($+100$ °F)
- P4 = T_p : $+200$ °C ($+392$ °F) | T_a : -10 °C ($+14$ °F)
- P5 = T_p : -10 °C ($+14$ °F) | T_a : -10 °C ($+14$ °F)

316L housing; process temperature -20 to $+150$ °C (-4 to $+302$ °F)

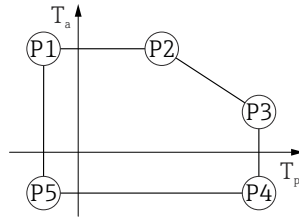

A0032024

▣ 42 316L housing; process temperature -20 to $+150$ °C (-4 to $+302$ °F)

- P1 = T_p : -20 °C (-4 °F) | T_a : $+77$ °C ($+171$ °F)
- P2 = T_p : $+77$ °C ($+171$ °F) | T_a : $+77$ °C ($+171$ °F)
- P3 = T_p : $+150$ °C ($+302$ °F) | T_a : $+43$ °C ($+109$ °F)
- P4 = T_p : $+150$ °C ($+302$ °F) | T_a : -20 °C (-4 °F)
- P5 = T_p : -20 °C (-4 °F) | T_a : -20 °C (-4 °F)

316L housing; process temperature -20 to $+200$ °C (-4 to $+392$ °F)

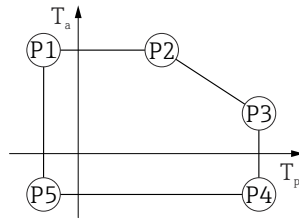

A0032024

▣ 43 316L housing; process temperature -20 to $+200$ °C (-4 to $+392$ °F)

- P1 = T_p : -20 °C (-4 °F) | T_a : $+77$ °C ($+171$ °F)
- P2 = T_p : $+77$ °C ($+171$ °F) | T_a : $+77$ °C ($+171$ °F)
- P3 = T_p : $+200$ °C ($+392$ °F) | T_a : $+38$ °C ($+100$ °F)
- P4 = T_p : $+200$ °C ($+392$ °F) | T_a : -20 °C (-4 °F)
- P5 = T_p : -20 °C (-4 °F) | T_a : -20 °C (-4 °F)

316L housing; process temperature -40 to $+150$ °C (-40 to $+302$ °F)

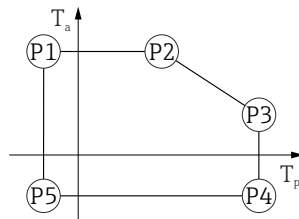

A0032024

▣ 44 316L housing; process temperature range: -40 to $+150$ °C (-40 to $+302$ °F)

- P1 = T_p : -40 °C (-40 °F) | T_a : $+77$ °C ($+171$ °F)
- P2 = T_p : $+77$ °C ($+171$ °F) | T_a : $+77$ °C ($+171$ °F)
- P3 = T_p : $+150$ °C ($+302$ °F) | T_a : $+43$ °C ($+109$ °F)
- P4 = T_p : $+150$ °C ($+302$ °F) | T_a : -40 °C (-40 °F)
- P5 = T_p : -40 °C (-40 °F) | T_a : -40 °C (-40 °F)

316L housing; process temperature -40 to +200 °C (-40 to +392 °F)

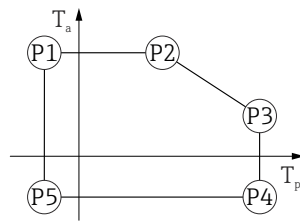

45 316L housing; process temperature -40 to +200 °C (-40 to +392 °F)

- P1 = T_p : -40 °C (-40 °F) | T_a : +77 °C (+171 °F)
- P2 = T_p : +77 °C (+171 °F) | T_a : +77 °C (+171 °F)
- P3 = T_p : +200 °C (+392 °F) | T_a : +38 °C (+100 °F)
- P4 = T_p : +200 °C (+392 °F) | T_a : -40 °C (-40 °F)
- P5 = T_p : -40 °C (-40 °F) | T_a : -40 °C (-40 °F)

A0032024

316L housing, hygiene

316L housing, hygiene; process temperature -10 to +150 °C (+14 to +302 °F)

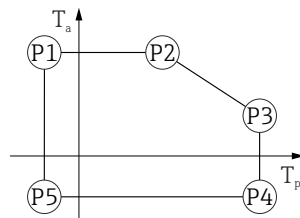

46 316L housing, hygiene; process temperature -10 to +150 °C (+14 to +302 °F)

- P1 = T_p : -10 °C (+14 °F) | T_a : +76 °C (+169 °F)
- P2 = T_p : +76 °C (+169 °F) | T_a : +76 °C (+169 °F)
- P3 = T_p : +150 °C (+302 °F) | T_a : +41 °C (+106 °F)
- P4 = T_p : +150 °C (+302 °F) | T_a : -10 °C (+14 °F)
- P5 = T_p : -10 °C (+14 °F) | T_a : -10 °C (+14 °F)

A0032024

316L housing, hygiene; process temperature -10 to +200 °C (+14 to +392 °F)

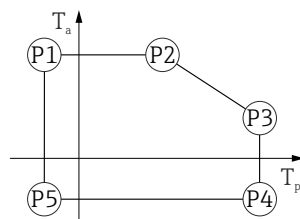

47 316L housing, hygiene; process temperature -10 to +200 °C (+14 to +392 °F)

- P1 = T_p : -10 °C (+14 °F) | T_a : +76 °C (+169 °F)
- P2 = T_p : +76 °C (+169 °F) | T_a : +76 °C (+169 °F)
- P3 = T_p : +200 °C (+392 °F) | T_a : +32 °C (+90 °F)
- P4 = T_p : +200 °C (+392 °F) | T_a : -10 °C (+14 °F)
- P5 = T_p : -10 °C (+14 °F) | T_a : -10 °C (+14 °F)

A0032024

316L housing, hygiene; process temperature -20 to $+150$ °C (-4 to $+302$ °F)



A0032024

▣ 48 316L housing, hygiene; process temperature -20 to $+150$ °C (-4 to $+302$ °F)

- P1 = T_p : -20 °C (-4 °F) | T_a : $+76$ °C ($+169$ °F)
- P2 = T_p : $+76$ °C ($+169$ °F) | T_a : $+76$ °C ($+169$ °F)
- P3 = T_p : $+150$ °C ($+302$ °F) | T_a : $+41$ °C ($+106$ °F)
- P4 = T_p : $+150$ °C ($+302$ °F) | T_a : -20 °C (-4 °F)
- P5 = T_p : -20 °C (-4 °F) | T_a : -20 °C (-4 °F)

316L housing, hygiene; process temperature -20 to $+200$ °C (-4 to $+392$ °F)

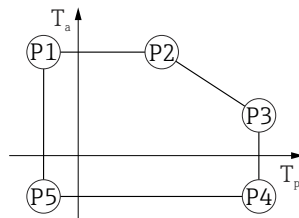

A0032024

▣ 49 316L housing, hygiene; process temperature -20 to $+200$ °C (-4 to $+392$ °F)

- P1 = T_p : -20 °C (-4 °F) | T_a : $+76$ °C ($+169$ °F)
- P2 = T_p : $+76$ °C ($+169$ °F) | T_a : $+76$ °C ($+169$ °F)
- P3 = T_p : $+200$ °C ($+392$ °F) | T_a : $+32$ °C ($+90$ °F)
- P4 = T_p : $+200$ °C ($+392$ °F) | T_a : -20 °C (-4 °F)
- P5 = T_p : -20 °C (-4 °F) | T_a : -20 °C (-4 °F)

316L housing, hygiene; process temperature -40 to $+150$ °C (-40 to $+302$ °F)

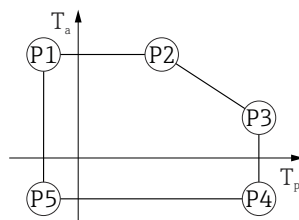

A0032024

▣ 50 316L housing, hygiene; process temperature range: -40 to $+150$ °C (-40 to $+302$ °F)

- P1 = T_p : -40 °C (-40 °F) | T_a : $+76$ °C ($+169$ °F)
- P2 = T_p : $+76$ °C ($+169$ °F) | T_a : $+76$ °C ($+169$ °F)
- P3 = T_p : $+150$ °C ($+302$ °F) | T_a : $+41$ °C ($+106$ °F)
- P4 = T_p : $+150$ °C ($+302$ °F) | T_a : -40 °C (-40 °F)
- P5 = T_p : -40 °C (-40 °F) | T_a : -40 °C (-40 °F)

316L housing, hygiene; process temperature -40 to $+200$ °C (-40 to $+392$ °F)

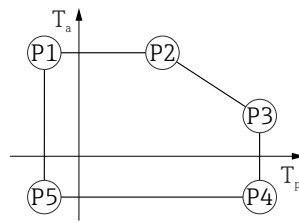

A0032024

■ 51 316L housing, hygiene; process temperature -40 to $+200$ °C (-40 to $+392$ °F)

P1 = T_p : -40 °C (-40 °F) | T_a : $+76$ °C ($+169$ °F)

P2 = T_p : $+76$ °C ($+169$ °F) | T_a : $+76$ °C ($+169$ °F)

P3 = T_p : $+200$ °C ($+392$ °F) | T_a : $+32$ °C ($+90$ °F)

P4 = T_p : $+200$ °C ($+392$ °F) | T_a : -40 °C (-40 °F)

P5 = T_p : -40 °C (-40 °F) | T_a : -40 °C (-40 °F)

Storage temperature

- Without LCD display: -40 to $+90$ °C (-40 to $+194$ °F)
- With LCD display: -40 to $+85$ °C (-40 to $+185$ °F)

Climate class DIN EN 60068-2-38 (test Z/AD)

Installation height as per IEC61010-1 Ed.3 Generally up to 5 000 m (16 404 ft) above sea level

Degree of protection Testing in accordance with IEC 60529 and NEMA 250

Housing

IP66/68, NEMA TYPE 4X/6P

IP68 test condition: 1.83 m Under water for 24 hours.

Cable entries

- M20 coupling, plastic, IP66/68 NEMA type 4X/6P
- M20 coupling, nickel-plated brass, IP66/68 NEMA type 4X/6P
- M20 coupling, 316L, IP66/68 NEMA type 4X/6P
- M20 coupling, hygiene, IP66/68/69 NEMA type 4X/6P
- M20 thread, IP66/68 NEMA type 4X/6P
- G ½ thread, IP66/68 NEMA TYPE 4X/6P

If the G ½ thread is selected, the device is provided with an M20 thread as standard and an M20 adapter to G M20 ½ is included, along with the associated documentation

- NPT ½ thread, IP66/68 NEMA TYPE 4X/6P
- M12 plug
 - If the housing is closed and the connecting cable is plugged in: IP66/67 NEMA type 4X
 - If the housing is open or the connecting cable is not plugged in: IP20, NEMA type 1

NOTICE

M12 plug: Loss of IP protection class due to incorrect installation!

- ▶ The degree of protection only applies if the connecting cable used is plugged in and screwed tight.
- ▶ The degree of protection only applies if the connecting cable used is specified according to IP67 NEMA 4X.
- ▶ The protection classes are only fulfilled if the dummy cap is used or the cable is connected.

Vibration resistance DIN EN 60068-2-64 / IEC 60068-2-64 for 5 to 2 000 Hz: 1.25 (m/s²)²/Hz

Electromagnetic compatibility (EMC)

- Electromagnetic compatibility as per EN 61326 series and NAMUR recommendation EMC (NE21)
- Maximum measured error during EMC testing: < 0.5 % of the current digital measured value

For more details refer to the EU Declaration of Conformity.

15.4 Process

Process pressure range



The maximum pressure for the device depends on the lowest-rated component with regard to pressure (components are: process connection, optional mounted parts or accessories).

- ▶ Only operate the device within the specified limits for the components!
- ▶ MWP (Maximum Working Pressure): The MWP is specified on the nameplate. This value refers to a reference temperature of +20 °C (+68 °F) and may be applied to the device for an unlimited time. Note temperature dependence of MWP. For flanges, refer to the following standards for the permitted pressure values at higher temperatures: EN 1092-1 (with regard to their stability/temperature property, the materials 1.4435 and 1.4404 are grouped together under EN 1092-1; the chemical composition of the two materials can be identical), ASME B16.5, JIS B2220 (the latest version of the standard applies in each case). MWP data that deviate from this are provided in the relevant sections of the Technical Information.
- ▶ The Pressure Equipment Directive (2014/68/EU) uses the abbreviation **PS**. This corresponds to the maximum working pressure (MWP) of the device.

The following tables show the dependencies between the seal material, process temperature (T_p) and process pressure range for each process connection that can be selected for the antenna used.

Integrated antenna, PEEK, 20 mm (0.75 in)

M24 process connection thread

	Seal	T _p	Process pressure range
<p>A0048027</p>	FKM Viton	-10 to +150 °C (+14 to +302 °F)	-1 to 20 bar (-14.5 to 290 psi)
	FKM Viton	-10 to +200 °C (+14 to +392 °F)	-1 to 20 bar (-14.5 to 290 psi)
	EPDM	-40 to +150 °C (-40 to +302 °F)	-1 to 20 bar (-14.5 to 290 psi)
	FFKM Kalrez	-20 to +150 °C (-4 to +302 °F)	-1 to 20 bar (-14.5 to 290 psi)
	FFKM Kalrez	-20 to +200 °C (-4 to +392 °F)	-1 to 20 bar (-14.5 to 290 psi)

The pressure range may be further restricted in the event of a CRN approval.

Antenna cladded flush mount, PTFE, 50 mm (2 in)

Process connection, Tri-Clamp DN51 (2") ISO2852

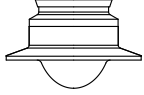
	Seal	T _p	Process pressure range
 <small>A0047838</small>	PTFE-cladded	-40 to +150 °C (-40 to +302 °F)	-1 to 16 bar (-14.5 to 232 psi)
	PTFE-cladded	-40 to +200 °C (-40 to +392 °F)	-1 to 16 bar (-14.5 to 232 psi)

Process connection, Tri-Clamp DN70-76.1 (3") ISO2852

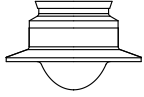
	Seal	T _p	Process pressure range
 <small>A0047838</small>	PTFE-cladded	-40 to +150 °C (-40 to +302 °F)	-1 to 14 bar (-14.5 to 203 psi)
	PTFE-cladded	-40 to +200 °C (-40 to +392 °F)	-1 to 14 bar (-14.5 to 203 psi)

Process connection, slotted nut, DIN11851 DN50 PN25

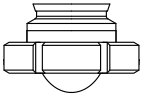
	Seal	T _p	Process pressure range
 <small>A0050063</small>	PTFE-cladded	-40 to +150 °C (-40 to +302 °F)	-1 to 25 bar (-14.5 to 362.6 psi)
	PTFE-cladded	-40 to +200 °C (-40 to +392 °F)	-1 to 25 bar (-14.5 to 362.6 psi)

 The pressure range may be further restricted in the event of a CRN approval.

Antenna cladded flush mount, PTFE, 80 mm (3 in)

Process connection, Tri-Clamp DN101.6 (4") ISO2852

	Seal	T _p	Process pressure range
 <small>A0047826</small>	PTFE-cladded	-40 to +150 °C (-40 to +302 °F)	-1 to 14 bar (-14.5 to 203 psi)
	PTFE-cladded	-40 to +200 °C (-40 to +392 °F)	-1 to 14 bar (-14.5 to 203 psi)

Process connection, slotted nut, DIN11851 DN80 PN25

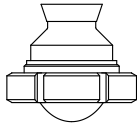
	Seal	T _p	Process pressure range
 <small>A0047825</small>	PTFE-cladded	-40 to +150 °C (-40 to +302 °F)	-1 to 25 bar (-14.5 to 362.6 psi)
	PTFE-cladded	-40 to +200 °C (-40 to +392 °F)	-1 to 25 bar (-14.5 to 362.6 psi)

 The pressure range may be further restricted in the event of a CRN approval.

Antenna cladded flush mount, PEEK, 20 mm (0.75 in)

Process connection, NEUMO BioControl D25 PN16

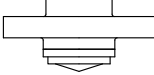
	Seal	T _p	Process pressure range
 <small>A0054988</small>	PEEK-cladded	-20 to +150 °C (-4 to +302 °F)	-1 to 16 bar (-14.5 to 232 psi)
	PEEK-cladded	-20 to +200 °C (-4 to +392 °F)	-1 to 16 bar (-14.5 to 232 psi)

 The pressure range may be further restricted in the event of a CRN approval.

Antenna cladded flush mount, PEEK, 40 mm (1.5 in)

Process connection, NEUMO BioControl D50 PN16

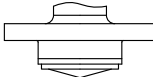
	Seal	T _p	Process pressure range
 <small>A0054992</small>	PEEK-cladded	-20 to +150 °C (-4 to +302 °F)	-1 to 16 bar (-14.5 to 232 psi)
	PEEK-cladded	-20 to +200 °C (-4 to +392 °F)	-1 to 16 bar (-14.5 to 232 psi)

Process connection, Varivent N tube DN65-162 PN20

	Seal	T _p	Process pressure range
 <small>A0054984</small>	PEEK-cladded	-20 to +150 °C (-4 to +302 °F)	-1 to 20 bar (-14.5 to 290 psi)
	PEEK-cladded	-20 to +200 °C (-4 to +392 °F)	-1 to 20 bar (-14.5 to 290 psi)

 The pressure range may be further restricted in the event of a CRN approval.

Dielectric constant

For liquids

$\epsilon_r \geq 1.2$

Contact Endress+Hauser for applications with lower dielectric constants than indicated.

Index

A

Access authorization to parameters	
Read access	29
Write access	29
Access code	29
Incorrect input	29
Application	8

B

Bluetooth® wireless technology	30
Bus address	29

C

CE mark	9
Climate class	83

D

Declaration of Conformity	9
Device locking, status	43
Device master file	34
DeviceCare	31
Diagnostic event	47
DIP switches	28
Display values	
For locking status	43
Disposal	56
Document	
Purpose	5

E

EMPTY_MODULE	37
Event history	50
Event list	50
Event text	47

F

Field of application	
Residual risks	8
FieldCare	32
Function	32
Filtering the event logbook	51

G

GSD	34
---------------	----

H

Hardware addressing	28
-------------------------------	----

I

Intended use	8
------------------------	---

M

Media	8
-----------------	---

O

Operating keys	28
Operation	43

Operational safety	9
Output values	33, 71

P

Product safety	9
Purpose of this document	5

R

Read access	29
Reading off measured values	43
Registered trademarks	6
Repair concept	55
Requirements for personnel	8
Return	56

S

Safety instructions	
Basic	8
Securing screw	21
Service interface (CDI)	40
Settings	
Adapting the measuring device to the process	
conditions	43
Software addressing	29
Spare parts	55
Status signal	46
Submenu	
Event list	50

T

Troubleshooting	44
Turning the display module	18

U

Use of measuring instrument	
see Intended use	
Use of the measuring devices	
Borderline cases	8
Incorrect use	8

W

Workplace safety	9
Write access	29



71686131

www.addresses.endress.com
