

Operating Instructions

Micropilot FMR67B

PROFINET over Ethernet-APL

Free-space radar





A0023555

- Make sure the document is stored in a safe place such that it is always available when working on or with the device
- Avoid danger to individuals or the facility: read the "Basic safety instructions" section carefully, as well as all other safety instructions in the document that are specific to working procedures

The manufacturer reserves the right to modify technical data without prior notice. The Endress+Hauser sales organization will supply you with current information and updates to these instructions.

Table of contents

1	About this document	5		
1.1	Purpose of this document	5		
1.2	Symbols	5		
1.2.1	Safety symbols	5		
1.2.2	Symbols for certain types of information and graphics	5		
1.3	List of abbreviations	6		
1.4	Documentation	6		
1.5	Registered trademarks	6		
2	Basic safety instructions	8		
2.1	Requirements for the personnel	8		
2.2	Intended use	8		
2.3	Workplace safety	9		
2.4	Operational safety	9		
2.5	Product safety	9		
2.6	IT security	9		
2.7	Device-specific IT security	9		
2.7.1	Protecting access via a password	10		
2.7.2	Access via Web server	10		
3	Product description	11		
3.1	Product design	11		
4	Incoming acceptance and product identification	12		
4.1	Incoming acceptance	12		
4.2	Product identification	12		
4.2.1	Nameplate	12		
4.2.2	Manufacturer address	13		
4.3	Storage and transport	13		
4.3.1	Storage conditions	13		
4.3.2	Transporting the product to the measuring point	13		
5	Installation	14		
5.1	General instructions	14		
5.2	Installation requirements	14		
5.2.1	Internal vessel fittings	14		
5.2.2	Avoiding interference echoes	15		
5.2.3	Vertical alignment of antenna axis	15		
5.2.4	Radial alignment of the antenna	15		
5.2.5	Optimization options	15		
5.3	Mounting the device	15		
5.3.1	Horn antenna 65 mm (2.56 in)	15		
5.3.2	Horn antenna 65 mm (2.56 in) with alignment unit	16		
5.3.3	PTFE drip-off antenna 50 mm (2 in)	17		
5.3.4	Antenna, flush mount 80 mm (3 in)	18		
5.3.5	Antenna flush mount 80 mm (3 in) with alignment unit	18		
5.3.6	Purge air connection	19		
5.3.7	Turning the housing	19		
5.3.8	Turning the display module	20		
5.3.9	Changing the installation position of the display module	21		
5.3.10	Closing the housing covers	22		
5.4	Post-mounting check	22		
6	Electrical connection	23		
6.1	Connecting requirements	23		
6.1.1	Cover with securing screw	23		
6.1.2	Potential equalization	23		
6.2	Connecting the device	24		
6.2.1	Supply voltage	25		
6.2.2	Cable specification	25		
6.2.3	Overvoltage protection	25		
6.2.4	Wiring	26		
6.2.5	Terminal assignment	27		
6.2.6	Cable entries	28		
6.2.7	Available device plugs	28		
6.3	Ensuring the degree of protection	28		
6.3.1	Cable entries	28		
6.4	Post-connection check	29		
7	Operation options	30		
7.1	Overview of operation options	30		
7.2	Operating keys and DIP switches on the electronic insert	30		
7.3	Structure and function of the operating menu	30		
7.3.1	User roles and related access authorization	30		
7.4	Access to operating menu via local display	31		
7.4.1	Device display (optional)	31		
7.4.2	Operation via Bluetooth® wireless technology (optional)	31		
7.5	Access to operating menu via web browser	33		
7.5.1	Function scope	33		
7.5.2	Prerequisites	33		
7.5.3	Establishing a connection	34		
7.5.4	User interface	35		
7.5.5	Disabling the Web server	36		
7.5.6	Logging out	37		
7.6	Access to the operating menu via the operating tool	37		
7.6.1	Connecting the operating tool	38		
7.7	FieldCare	39		
7.7.1	Function range	39		
7.8	DeviceCare	39		
7.8.1	Function scope	39		
8	System integration	40		
8.1	Overview of device description files	40		
8.1.1	Current version data for the device	40		
8.1.2	Operating tools	40		

8.2	Device master file (GSD)	40			
8.2.1	File name of the device master file (GSD)	41			
8.3	Cyclic data transmission	42			
8.3.1	Overview of the modules	42			
8.3.2	Description of the modules	42			
8.3.3	Status coding	43			
8.3.4	Startup configuration	44			
8.4	System redundancy S2	44			
9	Commissioning	45			
9.1	Preliminaries	45			
9.2	Installation and function check	45			
9.3	Connecting via FieldCare and DeviceCare	45			
9.3.1	Via PROFINET protocol	45			
9.3.2	Via service interface (CDI)	46			
9.3.3	Hardware settings	46			
9.3.4	Configuring the communication parameters via the software	46			
9.4	Configuring the operating language	47			
9.4.1	Local display	47			
9.4.2	Operating tool	47			
9.4.3	Web server	47			
9.5	Configuring the device	48			
9.5.1	Level measurement in bulk solids	48			
9.5.2	Commissioning with the Commissioning wizard	48			
9.6	Recording the Echo curve	48			
9.7	"Simulation" submenu	49			
10	Operation	50			
10.1	Reading off the device locking status	50			
10.2	Reading off measured values	50			
10.3	Adapting the device to process conditions	50			
11	Diagnosis and troubleshooting	51			
11.1	General troubleshooting	51			
11.1.1	General errors	51			
11.2	Error - SmartBlue operation	51			
11.3	Diagnostic message	52			
11.3.1	Diagnostic information on local display	53			
11.3.2	Diagnostic information in the operating tool	53			
11.3.3	Status signal	53			
11.3.4	Diagnostic event and event text	54			
11.4	Remedy information Calling up	54			
11.4.1	Graphic display with keys	54			
11.4.2	Operating menu	55			
11.5	Adapting the diagnostic information	55			
11.6	List of diagnostic events	55			
11.7	Event logbook	57			
11.7.1	Event history	57			
11.7.2	Filtering the event logbook	58			
11.7.3	Overview of information events	58			
11.8	Resetting the device	59			
11.8.1	Reset password via operating tool	59			
11.8.2	Reset device via operating tool	59			
11.8.3	Resetting the device via keys on the electronic insert	59			
11.9	Device information	60			
11.10	Firmware history	60			
12	Maintenance	60			
12.1	Cleaning	61			
12.1.1	Cleaning of surfaces not in contact with the medium	61			
12.1.2	Cleaning of surfaces in contact with the medium	61			
12.2	Seals	61			
13	Repair	62			
13.1	General information	62			
13.1.1	Repair concept	62			
13.1.2	Repairs to Ex-approved devices	62			
13.2	Spare parts	62			
13.3	Replacement	62			
13.3.1	HistoROM	63			
13.4	Return	63			
13.5	Disposal	63			
14	Accessories	64			
14.1	Weather protection cover: 316L, XW112	64			
14.2	Weather protection cover, plastic, XW111	64			
14.3	Adjustable flange seal	65			
14.3.1	Seal, adjustable, DN80	65			
14.3.2	Seal, adjustable, DN100	65			
14.3.3	Seal, adjustable, DN150	66			
14.3.4	Seal, adjustable, ASME 3"/ JIS 80A	66			
14.3.5	Seal, adjustable, ASME 4"	67			
14.3.6	Seal, adjustable, ASME 6"/ JIS 150A	67			
14.4	M12 plug-in jack	68			
14.4.1	M12 socket, cable side	68			
14.4.2	M12 socket, 90deg, cable side	69			
14.4.3	M12 socket, 100deg, 5 m (16 ft) cable	69			
14.5	Remote display FHX50B	69			
14.6	Gas-tight feedthrough	71			
14.7	Field Xpert SMT70	71			
14.8	DeviceCare SFE100	71			
14.9	FieldCare SFE500	71			
15	Technical data	72			
15.1	Input	72			
15.2	Output	73			
15.3	Environment	74			
15.4	Process	84			
	Index	86			

1 About this document

1.1 Purpose of this document

These Operating Instructions contain all the information that is required in the various phases of the life cycle of the device: from product identification, incoming acceptance and storage, to mounting, connection, operation and commissioning through to troubleshooting, maintenance and disposal.

1.2 Symbols

1.2.1 Safety symbols

DANGER

This symbol alerts you to a dangerous situation. Failure to avoid this situation will result in serious or fatal injury.

WARNING

This symbol alerts you to a dangerous situation. Failure to avoid this situation can result in serious or fatal injury.

CAUTION

This symbol alerts you to a dangerous situation. Failure to avoid this situation can result in minor or medium injury.

NOTICE

This symbol contains information on procedures and other facts which do not result in personal injury.

1.2.2 Symbols for certain types of information and graphics

Permitted

Procedures, processes or actions that are permitted

Forbidden

Procedures, processes or actions that are forbidden

Tip

Indicates additional information



Reference to documentation



Reference to page



Reference to graphic



Notice or individual step to be observed

1, 2, 3

Series of steps



Result of a step

1, 2, 3, ...

Item numbers

A, B, C, ...

Views

1.3 List of abbreviations

MWP

Maximum working pressure

The MWP is indicated on the nameplate.

ϵ_r (Dk value)

Relative dielectric constant

PLC

Programmable logic controller (PLC)

CDI

Common Data Interface

1.4 Documentation

 For an overview of the scope of the associated Technical Documentation, refer to the following:

- *Device Viewer* (www.endress.com/deviceviewer): Enter the serial number from the nameplate
- *Endress+Hauser Operations app*: Enter serial number from nameplate or scan matrix code on nameplate.

The following document types are available in the Downloads area of the Endress+Hauser website (www.endress.com/downloads), depending on the device version:

Document type	Purpose and content of the document
Technical Information (TI)	Planning aid for your device The document contains all the technical data on the device and provides an overview of the accessories and other products that can be ordered for the device.
Brief Operating Instructions (KA)	Guide that takes you quickly to the 1st measured value The Brief Operating Instructions contain all the essential information from incoming acceptance to initial commissioning.
Operating Instructions (BA)	Your reference document The Operating Instructions contain all the information that is required in various phases of the life cycle of the device: from product identification, incoming acceptance and storage, to mounting, connection, operation and commissioning through to troubleshooting, maintenance and disposal.
Description of Device Parameters (GP)	Reference for your parameters The document provides a detailed explanation of each individual parameter. The description is aimed at those who work with the device over the entire life cycle and perform specific configurations.
Safety instructions (XA)	Depending on the approval, safety instructions for electrical equipment in hazardous areas are also supplied with the device. These are an integral part of the Operating Instructions.  The nameplate indicates which Safety Instructions (XA) apply to the device.
Supplementary device-dependent documentation (SD/FY)	Always comply strictly with the instructions in the relevant supplementary documentation. The supplementary documentation is a constituent part of the device documentation.

1.5 Registered trademarks

PROFINET®

Registered trademark of the PROFIBUS User Organization, Karlsruhe, Germany

Bluetooth®

The *Bluetooth*® word mark and logos are registered trademarks owned by the Bluetooth SIG, Inc. and any use of such marks by Endress+Hauser is under license. Other trademarks and trade names are those of their respective owners.

Apple®

Apple, the Apple logo, iPhone, and iPod touch are trademarks of Apple Inc., registered in the U.S. and other countries. App Store is a service mark of Apple Inc.

Android®

Android, Google Play and the Google Play logo are trademarks of Google Inc.

KALREZ®, VITON®

Registered trademarks of DuPont Performance Elastomers L.L.C., Wilmington, DE USA

2 Basic safety instructions

2.1 Requirements for the personnel

The personnel for installation, commissioning, diagnostics and maintenance must fulfill the following requirements:

- ▶ Trained, qualified specialists must have a relevant qualification for this specific function and task.
- ▶ Are authorized by the plant owner/operator.
- ▶ Are familiar with federal/national regulations.
- ▶ Before starting work, read and understand the instructions in the manual and supplementary documentation as well as the certificates (depending on the application).
- ▶ Follow instructions and comply with basic conditions.

The operating personnel must fulfill the following requirements:

- ▶ Are instructed and authorized according to the requirements of the task by the facility's owner-operator.
- ▶ Follow the instructions in this manual.

2.2 Intended use

Application and media

The measuring device described in these Operating Instructions is intended for continuous, non-contact level measurement primarily in bulk solids. Due to its operating frequency of approx. 80 GHz, a maximum radiated peak power of <1.5 mW and an average power output of <70 μ W, unrestricted use outside of closed, metallic vessels is also permitted (for example over heaps). Operation does not pose any danger whatsoever to humans and animals.

If the limit values specified in the "Technical data" and the conditions listed in the instructions and additional documentation are observed, the measuring device may be used only for the following measurements:

- ▶ Measured process variables: level, distance, signal strength
- ▶ Calculable process variables: volume or mass in any shape of vessel

To ensure that the measuring device remains in proper condition for the operation time:

- ▶ Use the measuring device only for media to which the process-wetted materials are sufficiently resistant.
- ▶ Observe the limit values in the "Technical data".

Incorrect use

The manufacturer is not liable for damage caused by improper or non-intended use.

Avoid mechanical damage:

- ▶ Do not touch or clean device surfaces with pointed or hard objects.

Clarification of borderline cases:

- ▶ For special fluids and fluids for cleaning, Endress+Hauser is glad to provide assistance in verifying the corrosion resistance of fluid-wetted materials, but does not accept any warranty or liability.

Residual risks

Due to heat transfer from the process as well as power loss in the electronics, the temperature of the electronics housing and the assemblies it contains (e.g. display module, main electronics module and I/O electronics module) may rise to 80 °C (176 °F). When in operation, the sensor can reach a temperature close to the medium temperature.

Danger of burns from contact with surfaces!

- ▶ In the event of elevated fluid temperatures, ensure protection against contact to prevent burns.

2.3 Workplace safety

When working on and with the device:

- ▶ Wear the required personal protective equipment according to federal/national regulations.
- ▶ Switch off the supply voltage before connecting the device.

2.4 Operational safety

Damage to the device!

- ▶ Operate the device in proper technical condition and fail-safe condition only.
- ▶ The operator is responsible for the interference-free operation of the device.

Modifications to the device

Unauthorized modifications to the device are not permitted and can lead to unforeseeable dangers!

- ▶ If modifications are nevertheless required, consult with the manufacturer.

Repair

To ensure continued operational safety and reliability:

- ▶ Carry out repairs on the device only if they are expressly permitted.
- ▶ Observe federal/national regulations pertaining to the repair of an electrical device.
- ▶ Use only original spare parts and accessories.

2.5 Product safety

This measuring device is designed in accordance with good engineering practice to meet state-of-the-art safety requirements, has been tested, and left the factory in a condition in which it is safe to operate.

It meets general safety standards and legal requirements. It also complies with the EU directives listed in the device-specific EU Declaration of Conformity. The manufacturer confirms this by affixing the CE mark to the device.

2.6 IT security

The manufacturer warranty is valid only if the product is installed and used as described in the Operating Instructions. The product is equipped with security mechanisms to protect it against any inadvertent changes to the settings.

IT security measures, which provide additional protection for the product and associated data transfer, must be implemented by the operators themselves in line with their security standards.

2.7 Device-specific IT security

The device offers specific functions to support protective measures by the operator. These functions can be configured by the user and guarantee greater in-operation safety if used correctly. An overview of the most important functions is provided in the following section:

- Write protection via hardware write protection switch
- Access code to change user role (applies to operation via display, Bluetooth or FieldCare, DeviceCare, asset management tools (e.g., AMS, PDM and Web server)

Function/interface	Factory setting	Recommendation
Access code (also applies to Web server login or FieldCare connection)	Not enabled (0000)	Assign a customized access code during commissioning
Web server	Enabled	On an individual basis following risk assessment
Service interface (CDI)	Enabled	On an individual basis following risk assessment
Write protection via hardware write protection switch	Not enabled	On an individual basis following risk assessment

2.7.1 Protecting access via a password

Different passwords are available to protect write access to the parameters of the device.

Protect write access to the parameters of the device via the local display, Web browser or operating tool (e.g. FieldCare, DeviceCare). Access authorization is clearly regulated through the use of a user-specific access code.



User-specific access code

Write access to the parameters of the device via the local display, Web browser or operating tool (e.g. FieldCare, DeviceCare) can be protected using the editable, user-specific access code.

When delivered, the device does not have an access code and this code corresponds to 0000 (open).

General notes on the use of passwords

- During commissioning, change the access code used when the device was delivered
- When defining and managing the access code, comply with the general rules for the generation of a secure password
- The user is responsible for managing the access code and for using the code with due care

 For further information, see →  Resetting the device

2.7.2 Access via Web server

Thanks to the integrated Web server, the device can be operated and configured using a Web browser and via PROFINET with Ethernet-APL. In addition to the measured values, status information on the device is displayed and can be used to monitor device health. Furthermore the device data can be managed and the network parameters can be configured.

Access to the network is required for the PROFINET with Ethernet-APL connection.

Supported functions

Data exchange between the operating unit (such as a notebook, for example,) and measuring device:

- Export parameter settings (PDF file, create documentation of the measuring point configuration)
- Export the Heartbeat Technology verification report (PDF file, only available with the "Heartbeat Verification" application package)
- Download driver (GSDML) for system integration

The Web server is enabled when the device is delivered. The Web server can be disabled via the **Web server functionality** parameter if necessary (e.g., after commissioning).

The device and status information can be hidden on the login page. This prevents unauthorized access to the information.

 Description of device parameters.

3 Product description

3.1 Product design

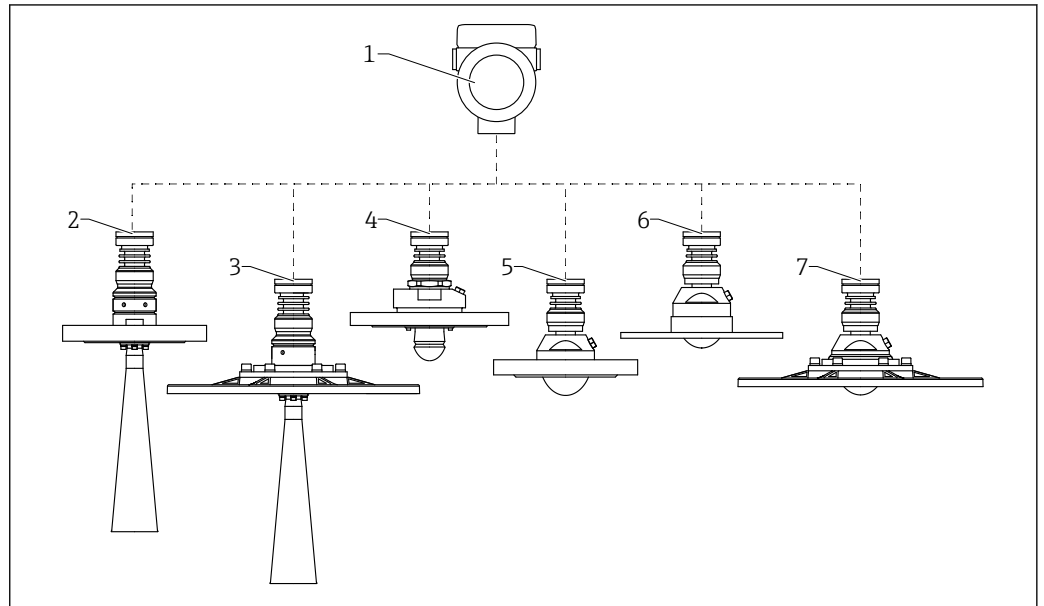

A0046665

1 Design of the Micropilot FMR67B

- 1 Electronics housing
- 2 DN65 horn antenna, with flange
- 3 DN65 horn antenna, with UNI flange and alignment unit
- 4 Drip-off antenna 50 mm (2 in), with flange; optional purge air connection
- 5 Antenna flush mount, 80 mm (3 in), with flange; optional purge air connection
- 5 Antenna flush mount, 80 mm (3 in), with UNI flange; optional purge air connection
- 7 Antenna flush mount, 80 mm (3 in), with UNI flange and alignment unit; optional purge air connection

4 Incoming acceptance and product identification

4.1 Incoming acceptance

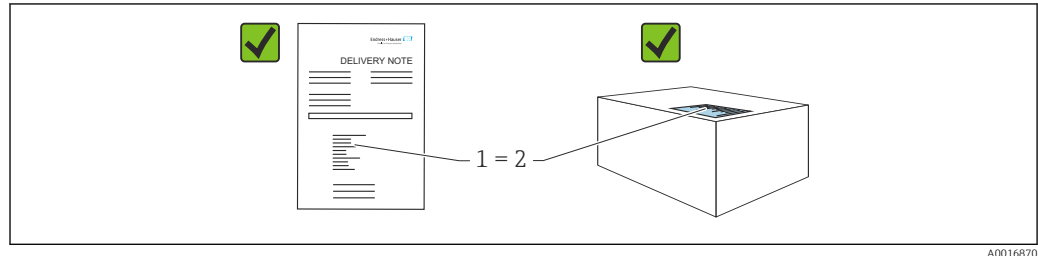

Check the following during incoming acceptance:

- Is the order code on the delivery note (1) identical to the order code on the product sticker (2)?
- Are the goods undamaged?
- Do the data on the nameplate correspond to the order specifications and the delivery note?
- Is the documentation provided?
- If required (see nameplate): are the Safety Instructions (XA) provided?



If one of these conditions is not met, please contact the manufacturer's sales office.

4.2 Product identification

The following options are available for identification of the device:

- Nameplate specifications
- Extended order code with breakdown of the device features on the delivery note
- ▶ *Device Viewer* (www.endress.com/deviceviewer); manually enter the serial number from the nameplate.
 - ↳ All the information about the measuring device is displayed.
- ▶ *Endress+Hauser Operations app*; manually enter the serial number indicated on the nameplate or scan the 2D matrix code on the nameplate.
 - ↳ All the information about the measuring device is displayed.

4.2.1 Nameplate

Do you have the correct device?

The nameplate provides you with the following information on the device:

- Manufacturer identification, device designation
- Order code
- Extended order code
- Serial number
- Tag name (TAG) (optional)
- Technical values, e.g. supply voltage, current consumption, ambient temperature, communication-specific data (optional)
- Degree of protection
- Approvals with symbols
- Reference to Safety Instructions (XA) (optional)
- ▶ Compare the information on the nameplate with the order.

4.2.2 Manufacturer address

Endress+Hauser SE+Co. KG
Hauptstraße 1
79689 Maulburg, Germany
Place of manufacture: See nameplate.

4.3 Storage and transport

4.3.1 Storage conditions

- Use the original packaging
- Store the device in clean and dry conditions and protect from damage caused by shocks

Storage temperature range

See Technical Information.

4.3.2 Transporting the product to the measuring point

WARNING

Incorrect transport!

The housing or sensor can be damaged or pull off. Risk of injury!

- ▶ Transport the device to the measuring point in its original packaging or by the process connection.
- ▶ Always secure lifting equipment (slings, eyes, etc.) at the process connection and never lift the device by the electronic housing or sensor. Pay attention to the center of gravity of the device so that it does not tilt or slip unintentionally.

5 Installation

5.1 General instructions

⚠ WARNING

Loss of protection rating if the device is opened in a wet environment.

► Only open the device in a dry environment!

1. Install the device or turn the housing so that the cable entries do not point upwards.

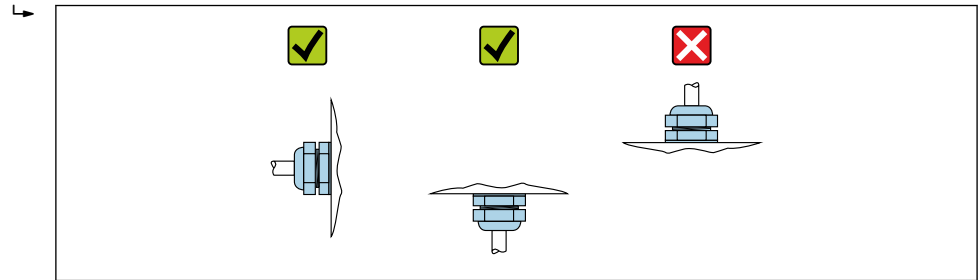

A0029263

2. Always firmly tighten the housing cover and the cable entries.
3. Counter-tighten the cable entries.
4. A drip loop must be provided when laying the cables.

5.2 Installation requirements

5.2.1 Internal vessel fittings

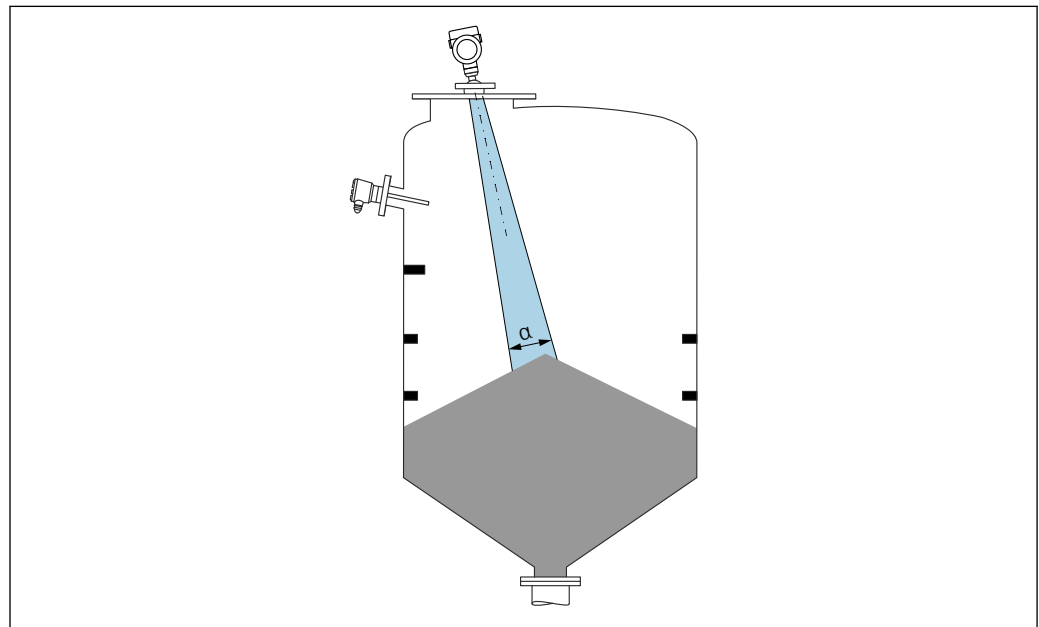

A0031814

Avoid internal fittings (level switches, temperature sensors, struts, vacuum rings, heating coils, baffles etc.) inside the signal beam. Pay attention to the beam angle α .

5.2.2 Avoiding interference echoes

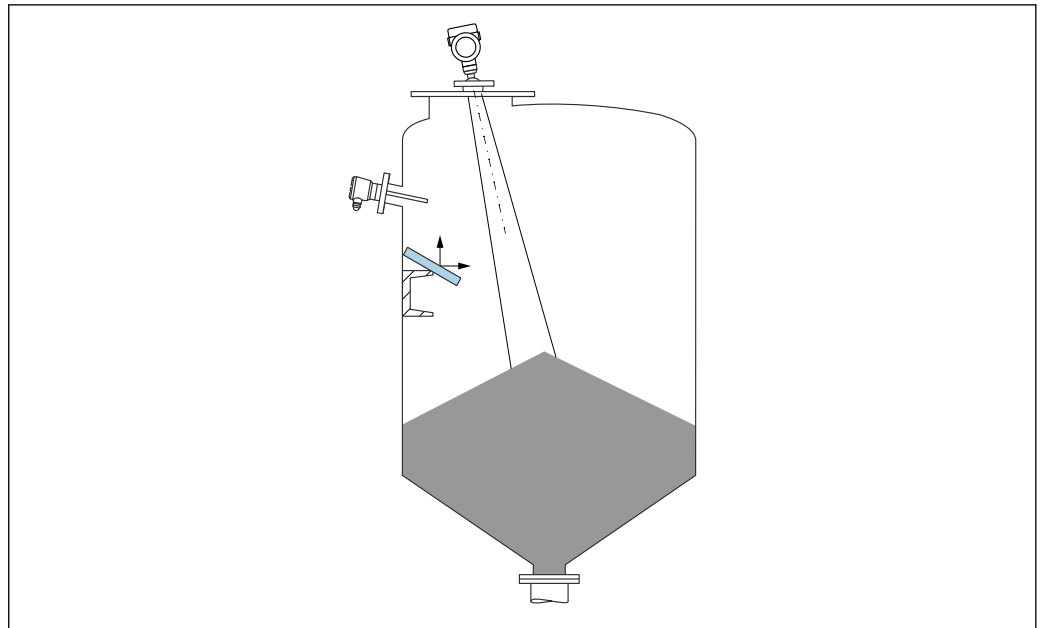

A0031817

Metal deflector plates, installed at an angle to scatter the radar signals, help prevent interference echoes.

5.2.3 Vertical alignment of antenna axis

Align the antenna so that it is perpendicular to the product surface.

i The maximum reach of the antenna can be reduced, or additional interference signals can occur, if the antenna is not installed perpendicular to the product.

5.2.4 Radial alignment of the antenna

Based on the directional characteristic, radial alignment of the antenna is not necessary.

5.2.5 Optimization options

Mapping

Measurement can be optimized by electronically suppressing interference echoes. See the **Confirm distance** parameter.

5.3 Mounting the device

5.3.1 Horn antenna 65 mm (2.56 in)

Information about the mounting nozzle

The maximum nozzle length H_{max} depends on the nozzle diameter D .

Maximum nozzle length H_{max} as a function of the nozzle diameter D

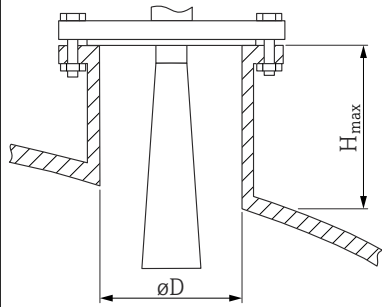
	ϕD	H_{max}
	80 to 100 mm (3.2 to 4 in)	1 700 mm (67 in)
	100 to 150 mm (4 to 6 in)	2 100 mm (83 in)
	≥ 150 mm (6 in)	3 200 mm (126 in)

i In the case of longer nozzles, reduced measuring performance must be expected.

Please note the following:

- The end of the nozzle must be smooth and free from burrs.
- The edge of the nozzle should be rounded.
- Mapping must be performed.
- Please contact the manufacturer's support department for applications with nozzles that are higher than indicated in the table.

5.3.2 Horn antenna 65 mm (2.56 in) with alignment unit

UNI flanges with an integrated alignment unit are available for the horn antenna 65 mm (2.56 in). An angle of inclination of up to 15° in all directions can be set for the antenna axis using the alignment unit. The alignment unit is used to optimally align the measuring signal to the bulk solids.

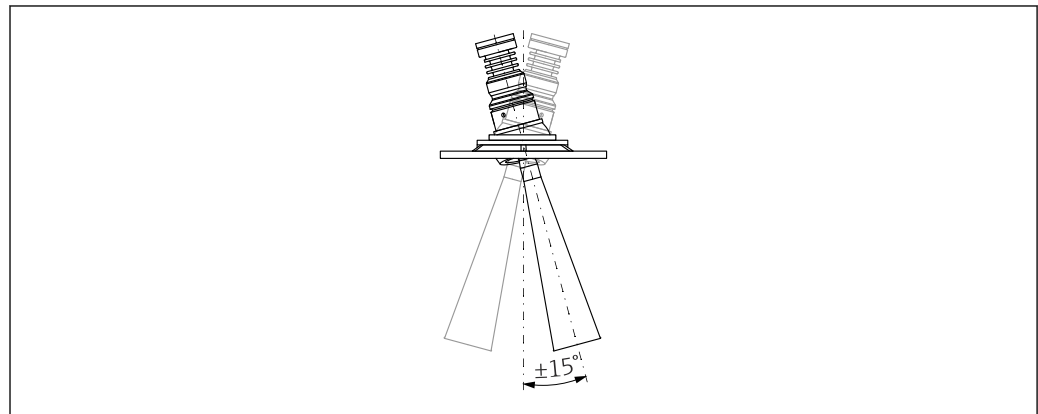

A0048891

2 Horn antenna with alignment unit

Information about the mounting nozzle

The maximum nozzle length H_{max} depends on the nozzle diameter D .

The maximum nozzle length H_{max} depends on the nozzle diameter D

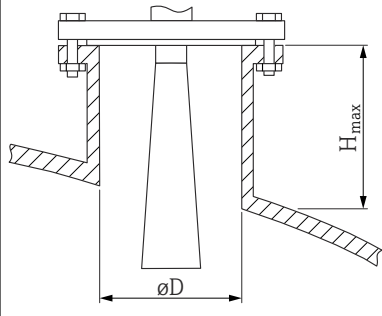
	ϕD	H_{max}
	80 to 100 mm (3.2 to 4 in)	1700 mm (67 in)
	100 to 150 mm (4 to 6 in)	2100 mm (83 in)
	≥ 150 mm (6 in)	3200 mm (126 in)

i In the case of longer nozzles, reduced measuring performance must be expected.

Please note the following:

- The end of the nozzle must be smooth and free from burrs.
- The edge of the nozzle should be rounded.
- Mapping must be performed.
- Please contact the manufacturer's support department for applications with nozzles that are higher than indicated in the table.

5.3.3 PTFE drip-off antenna 50 mm (2 in)

Information concerning threaded connections

- When screwing in, turn by the hex bolt only.
- Tool: open-ended wrench 55 mm
- Maximum permissible torque: 50 Nm (36 lbf ft)

Information about the mounting nozzle

The maximum nozzle length H_{max} depends on the nozzle diameter D .

The maximum length of the nozzle H_{max} depends on the nozzle diameter D

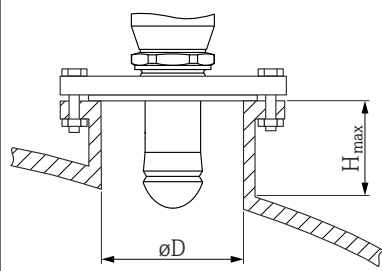
	ϕD	H_{max}
	50 to 80 mm (2 to 3.2 in)	750 mm (30 in)
	80 to 100 mm (3.2 to 4 in)	1150 mm (46 in)
	100 to 150 mm (4 to 6 in)	1450 mm (58 in)
	≥ 150 mm (6 in)	2200 mm (88 in)

i In the case of longer nozzles, reduced measuring performance must be expected.

Please note the following:

- The end of the nozzle must be smooth and free from burrs.
- The edge of the nozzle should be rounded.
- Mapping must be performed.
- Please contact the manufacturer's support department for applications with nozzles that are higher than indicated in the table.

5.3.4 Antenna, flush mount 80 mm (3 in)

Information about the mounting nozzle

The maximum nozzle length H_{max} depends on the nozzle diameter D .

Antenna nozzle mounting, flush mount 80 mm (3 in)

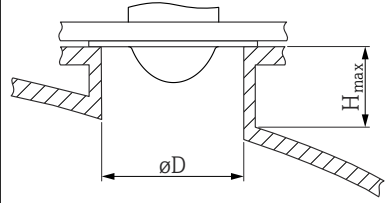
	$\varnothing D$	H_{max}
	80 to 100 mm (3.2 to 4 in)	1 750 mm (70 in)
	100 to 150 mm (4 to 6 in)	2 200 mm (88 in)
	≥ 150 mm (6 in)	3 300 mm (132 in)

i In the case of longer nozzles, reduced measuring performance must be expected.

Please note the following:

- The end of the nozzle must be smooth and free from burrs.
- The edge of the nozzle should be rounded.
- Mapping must be performed.
- Please contact the manufacturer's support department for applications with nozzles that are higher than indicated in the table.

5.3.5 Antenna flush mount 80 mm (3 in) with alignment unit

UNI flanges with an integrated alignment unit are available for the antenna flush mount 80 mm (3 in). An inclination of the antenna axis of up to 15° in all directions can be set with the help of the alignment unit. The alignment unit is used to optimally align the measuring signal to the bulk solids.

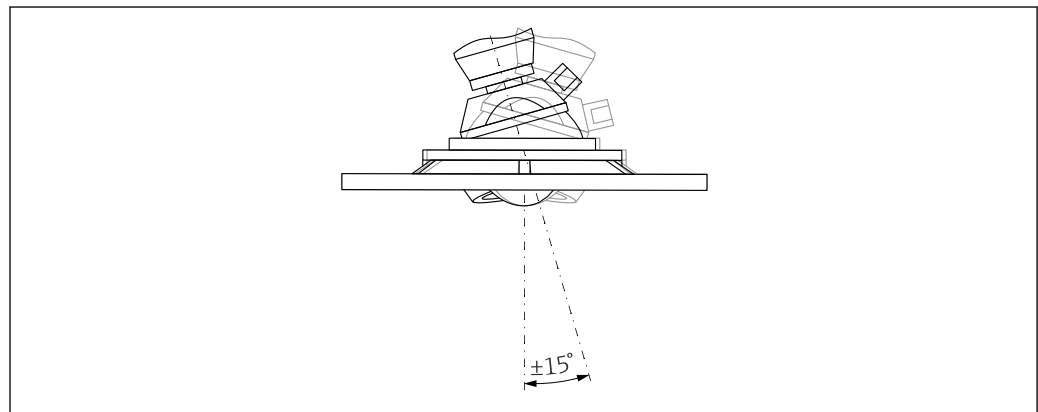

A0046592

3 *Antenna flush mount with alignment unit*

Information about the mounting nozzle

The maximum nozzle length H_{max} depends on the nozzle diameter D .

The maximum length of the nozzle H_{max} depends on the nozzle diameter D

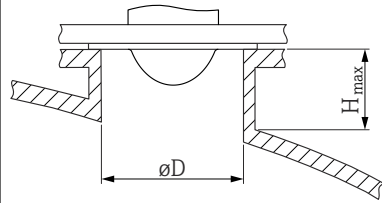
	ϕD	H_{max}
	min. 80 to 100 mm (3 to 4 in)	1 450 mm (57 in)
	100 to 150 mm (4 to 6 in)	1 800 mm (71 in)
	≥ 150 mm (6 in)	2 700 mm (106 in)

i In the case of longer nozzles, reduced measuring performance must be expected.

Please note the following:

- The end of the nozzle must be smooth and free from burrs.
- The edge of the nozzle should be rounded.
- Mapping must be performed.
- Please contact the manufacturer's support department for applications with nozzles that are higher than indicated in the table.

5.3.6 Purge air connection

In applications with strong dust emissions, the integrated purge air connection can prevent the antenna from becoming clogged. Pulse operation is recommended.

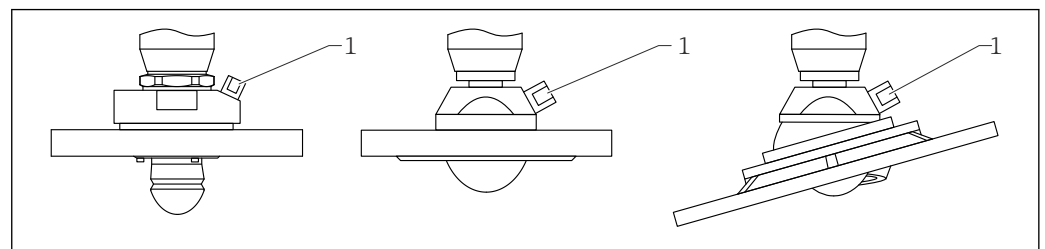

A0046593

4 Antenna with purge air adapter

1 Purge air connection NPT 1/4" or G 1/4"

Purge air pressure range

- **Pulse operation :**
Max. 6 bar (87 psi)
- **Continuous operation:**
200 to 500 mbar (3 to 7.25 psi)

Purge air connection

- Tool:
 - Open-ended wrench 13 mm (G 1/4")
 - Open-ended wrench 14 mm (NPT)
 - Open-ended wrench 17 mm (NPT "adapter")
- Min. torque: 6 Nm (4.4 lbf ft)
- Max. torque: 7 Nm

- i**
 - Always use dry purge air
 - In general, purging should only be performed to the extent necessary as excess purging can cause mechanical damage (abrasion)

5.3.7 Turning the housing

The housing can be rotated up to 380° by loosening the locking screw.

Your benefits

- Easy installation due to optimum alignment of housing
- Easily accessible device operation
- Optimum readability of the local display (optional)

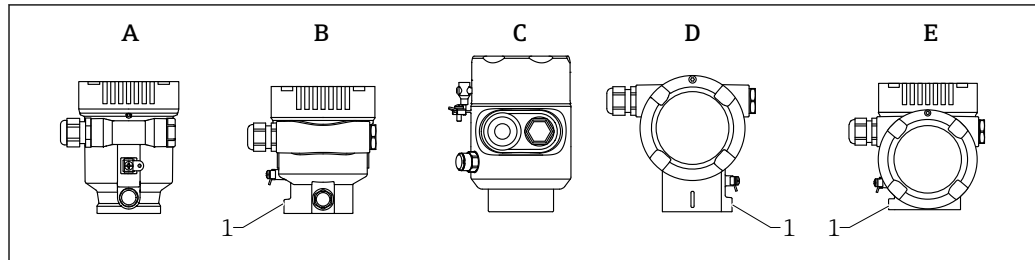

A0046660

- A Plastic single compartment housing (no locking screw)
 B Aluminum single compartment housing
 C Single compartment housing, 316L, hygiene (no locking screw)
 D Dual compartment housing
 E Dual compartment housing, L-form
 1 Locking screw

NOTICE**The housing cannot be unscrewed fully.**

- ▶ Loosen the external locking screw by a maximum of 1.5 turns. If the screw is unscrewed too much or completely (beyond the screw anchor point), small parts (counter disk) can become loose and fall out.
- ▶ Tighten the securing screw (hexagon socket 4 mm (0.16 in)) with maximum 3.5 Nm (2.58 lbf ft) \pm 0.3 Nm (0.22 lbf ft).

5.3.8 Turning the display module**⚠ WARNING****Supply voltage switched on!**

Risk of electric shock and/or explosion!

- ▶ Switch off the supply voltage before opening the measuring device.

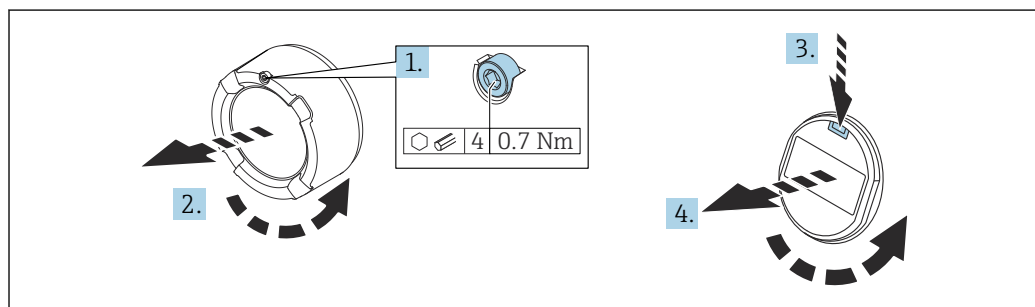

A0038224

1. If fitted: release the screw of the cover lock for the electronics compartment cover using the Allen key.
2. Unscrew the electronics compartment cover from the transmitter housing and check the cover seal.
3. Press the release mechanism and remove the display module.
4. Turn the display module to the desired position: maximum $4 \times 90^\circ$ in each direction. Fit the display module on the electronics compartment in the desired position until it clicks into place. Screw the electronics compartment cover back onto the transmitter housing. If fitted: tighten the screw of the cover lock using the Allen key 0.7 Nm (0.52 lbf ft) \pm 0.2 Nm (0.15 lbf ft).

5.3.9 Changing the installation position of the display module

The installation position of the display can be changed in the case of the dual compartment housing, L-form.

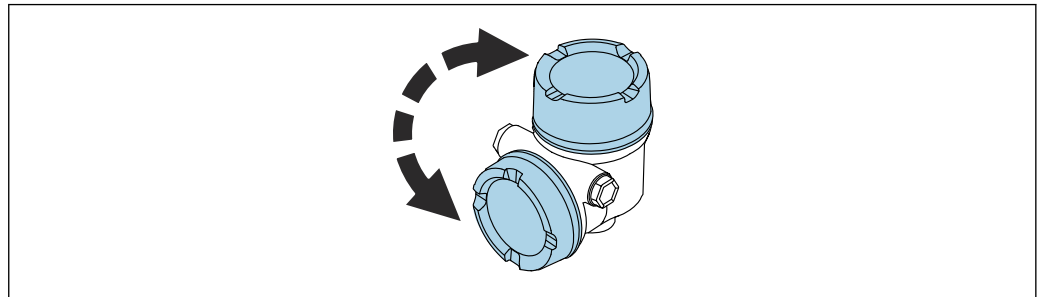

A0048401

⚠ WARNING

Supply voltage switched on!

Risk of electric shock and/or explosion!

- ▶ Switch off the supply voltage before opening the measuring instrument.

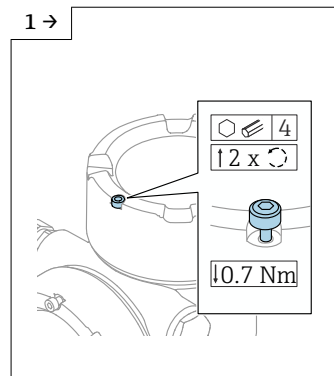

A0046831

- ▶ If fitted: release the screw of the cover lock for the display cover using the Allen key.

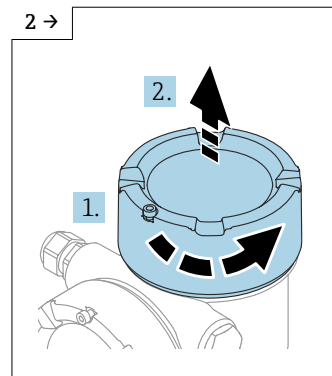

A0046832

- ▶ Unscrew the display cover and check the cover seal.

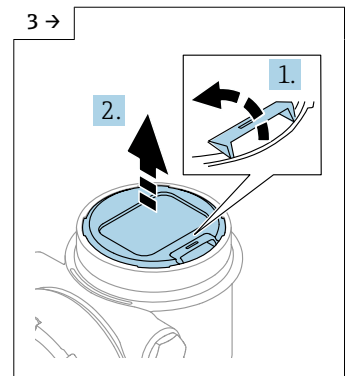

A0046833

- ▶ Press the release mechanism, remove the display module.

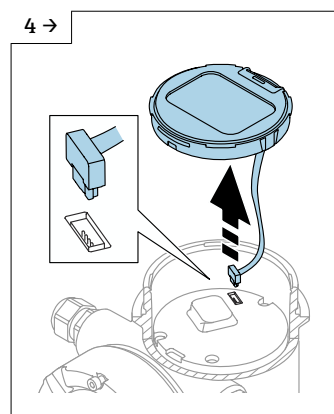

A0046834

- ▶ Release the plug connection.

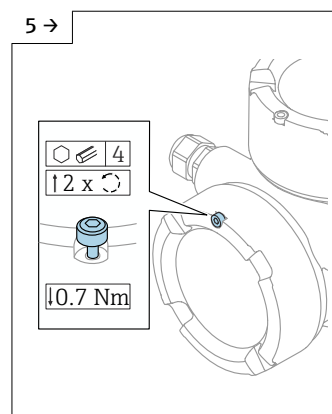

A0046923

- ▶ If fitted: release the screw of the cover lock for the connection compartment cover using the Allen key.

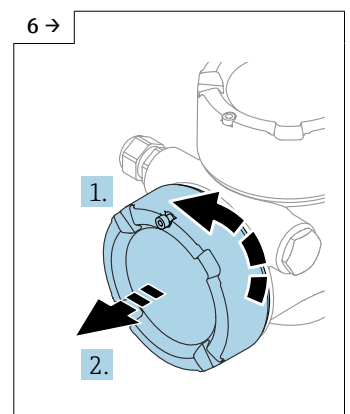

A0046924

- ▶ Unscrew the connection compartment cover, check the cover seal. Screw this cover onto the electronics compartment instead of the display cover. If fitted: tighten the screw of the cover lock using the Allen key

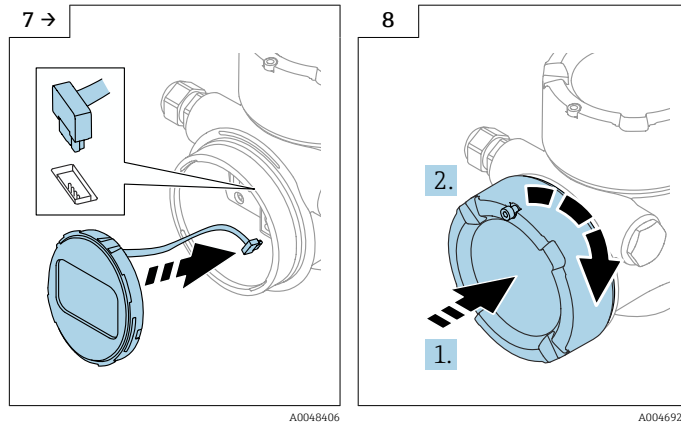

- ▶ Plug in the connection for the display module in the connection compartment.
- ▶ Fit the display module in the desired position until it clicks into place.
- ▶ Screw the display cover firmly back onto the housing. If fitted: tighten the screw of the cover lock using the Allen key 0.7 Nm (0.52 lbf ft).

5.3.10 Closing the housing covers

NOTICE

Thread and housing damaged from dirt!

- ▶ Remove dirt (e.g. sand) on the cover and housing thread.
- ▶ If you encounter resistance when closing the cover, check the thread for dirt and clean it.

i Housing thread

The threads of the electronics and connection compartment can be coated with an anti-friction coating.

The following applies for all housing materials:

- ✘ **Do not lubricate the housing threads.**

5.4 Post-mounting check

- Is the device free from damage (visual inspection)?
- Are the measuring point identification and labeling correct (visual inspection)?
- Is the measuring device protected against precipitation and sunlight?
- Are the securing screws and cover lock tightened securely?
- Does the measuring device comply with the measuring point specifications?

For example:

- Process temperature
- Process pressure
- Ambient temperature
- Measuring range

6 Electrical connection

6.1 Connecting requirements

6.1.1 Cover with securing screw

The cover is locked by a securing screw in devices for use in hazardous areas with certain explosion protection.

NOTICE

If the securing screw is not positioned correctly, the cover cannot provide secure sealing.

- ▶ Open the cover: slacken the screw of the cover lock with a maximum of 2 turns so that the screw does not fall out. Fit the cover and check the cover seal.
- ▶ Close the cover: screw the cover securely onto the housing, making sure that the securing screw is positioned correctly. There should not be any gap between the cover and housing.

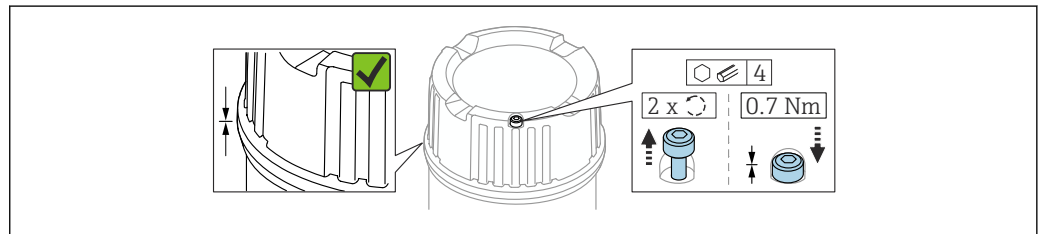

A0039520

5 Cover with securing screw

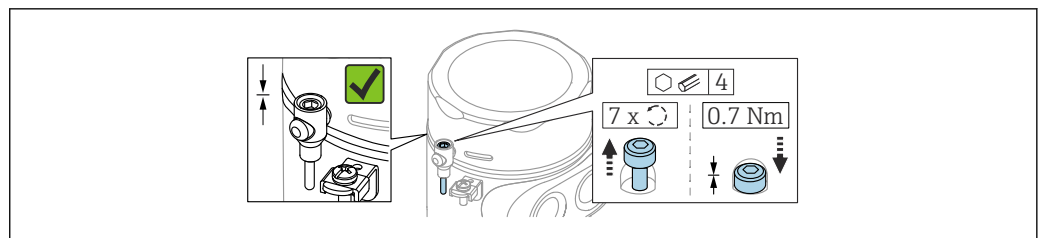

A0050983

6 Cover with securing screw; hygienic housing (only for dust explosion protection)

6.1.2 Potential equalization

The protective ground on the device must not be connected. If necessary, the potential matching line can be connected to the outer ground terminal of the housing before the device is connected.

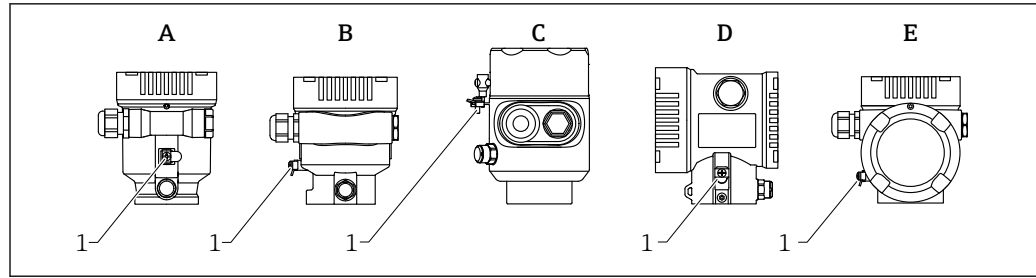

A0046583

- A Single compartment housing, plastic
 B Single compartment housing, aluminum, coated
 C Single compartment housing, 316L, hygiene (Ex device)
 D Dual compartment housing, aluminum, coated
 E Dual compartment housing, L-shaped, aluminum, coated
 1 Ground terminal for connecting the potential matching line

⚠ WARNING

Ignitable sparks or impermissible high surface temperatures.

Explosion hazard!

- ▶ Please refer to the separate documentation on applications in hazardous areas for the safety instructions.



For optimum electromagnetic compatibility:

- Keep potential matching line as short as possible
- Observe minimum cross-section of 2.5 mm² (14 AWG)

6.2 Connecting the device

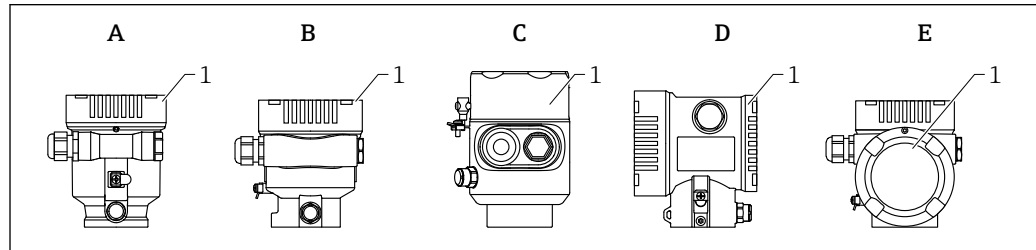

A0046659

- A Single compartment housing, plastic
 B Single compartment housing, aluminum, coated
 C Single compartment housing, 316L, hygiene
 D Dual compartment housing, aluminum, coated
 E Dual compartment housing, L-shaped, aluminum, coated
 1 Connection compartment cover



Devices with a single compartment 316L hygiene housing and conduit screw connection must be connected as end-of-line devices; only one “conduit entry” may be used.



Housing thread

The threads of the electronics and connection compartment can be coated with an anti-friction coating.

The following applies for all housing materials:

- ❌ **Do not lubricate the housing threads.**

6.2.1 Supply voltage

APL performance class A (9.6 to 15 V_{DC} 540 mW)

 The APL field switch must be tested to ensure it meets safety requirements (e.g., PELV, SELV, Class 2) and must comply with the relevant protocol specifications.

6.2.2 Cable specification

Rated cross-section

- Supply voltage
0.5 to 2.5 mm² (20 to 13 AWG)
- Protective earth or grounding of the cable shield
> 1 mm² (17 AWG)
- External ground terminal
0.5 to 4 mm² (20 to 12 AWG)

Cable outer diameter

The cable outer diameter depends on the cable gland used

- Coupling, plastic:
ø5 to 10 mm (0.2 to 0.38 in)
- Coupling, nickel-plated brass:
ø7 to 10.5 mm (0.28 to 0.41 in)
- Coupling, stainless steel:
ø7 to 12 mm (0.28 to 0.47 in)

PROFINET with Ethernet-APL

The reference cable type for APL segments is fieldbus cable type A, MAU type 1 and 3 (specified in IEC 61158-2). This cable meets the requirements for intrinsically safe applications according to IEC TS 60079-47 and can also be used in non-intrinsically safe applications.

Cable type	A
Cable capacitance	45 to 200 nF/km
Loop resistance	15 to 150 Ω/km
Cable inductance	0.4 to 1 mH/km

Further details are provided in the Ethernet-APL Engineering Guideline (<https://www.ethernet-apl.org>).

6.2.3 Overvoltage protection

The overvoltage protection can optionally be ordered as a "Mounted accessory" via the product structure.

Devices without optional overvoltage protection

The devices satisfy the IEC/DIN EN IEC 61326-1 product standard (Table 2 Industrial environment).

Depending on the type of port (DC power supply, input/output port) different testing levels according to IEC/DIN EN 61326-1 against transient overvoltages are applied (IEC/DIN EN 61000-4-5 Surge):

Test level on DC power ports and input/output ports is 1 000 V line to earth

Devices with optional overvoltage protection

- Spark-over voltage: min. 400 V_{DC}
- Tested according to IEC/DIN EN 60079-14 sub chapter 12.3 (IEC/DIN EN 60060-1 chapter 7)
- Nominal discharge current: 10 kA

NOTICE

The device can be destroyed by excessively high electrical voltages.

- ▶ Always ground the device with integrated overvoltage protection.

Overvoltage category

Overvoltage category II

6.2.4 Wiring**⚠ WARNING****Supply voltage might be connected!**

Risk of electric shock and/or explosion!

- ▶ If the device is used in hazardous areas, make sure to comply with national standards and the specifications in the Safety Instructions (XAs). The specified cable gland must be used.
- ▶ The supply voltage must match the specifications on the nameplate.
- ▶ Switch off the supply voltage before connecting the device.
- ▶ If necessary, the potential matching line can be connected to the outer ground terminal of the device before the power supply lines are connected.
- ▶ A suitable circuit breaker should be provided for the device in accordance with IEC/EN 61010.
- ▶ The cables must be adequately insulated, with due consideration given to the supply voltage and the overvoltage category.
- ▶ The connecting cables must offer adequate temperature stability, with due consideration given to the ambient temperature.
- ▶ Only operate the measuring device with the covers closed.

Connect the device in the following order:

1. Release the cover lock (if provided).
2. Unscrew the cover.
3. Guide the cables into the cable glands or cable entries.
4. Connect the cables.
5. Tighten the cable glands or cable entries so that they are leak-tight. Counter-tighten the housing entry.
6. Screw the cover securely back onto the connection compartment.
7. If provided: tighten the screw of the cover lock using the Allen key 0.7 Nm (0.52 lbf ft) ±0.2 Nm (0.15 lbf ft).

6.2.5 Terminal assignment

Single compartment housing

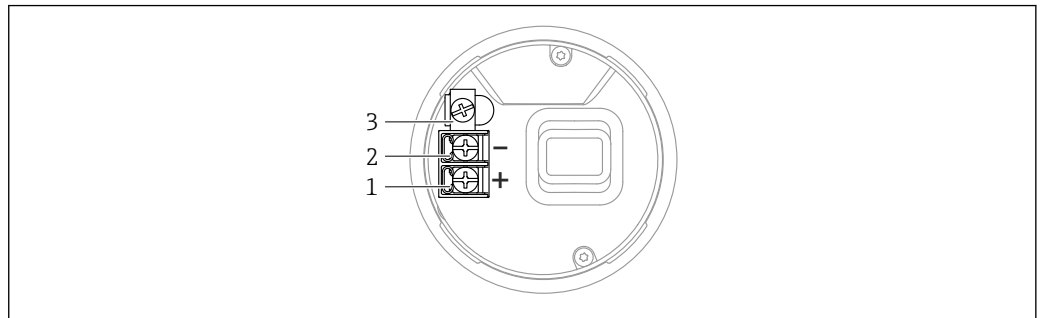

A0042594

7 Connection terminals and ground terminal in the connection compartment, single compartment housing

- 1 Positive terminal
- 2 Negative terminal
- 3 Internal ground terminal

Dual compartment housing

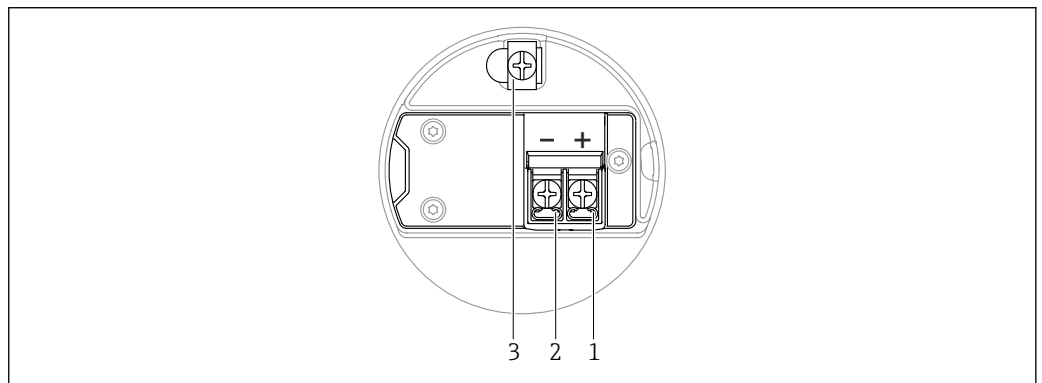

A0042803

8 Connection terminals and ground terminal in the connection compartment

- 1 Plus terminal
- 2 Minus terminal
- 3 Internal ground terminal

Dual compartment housing, L-shaped

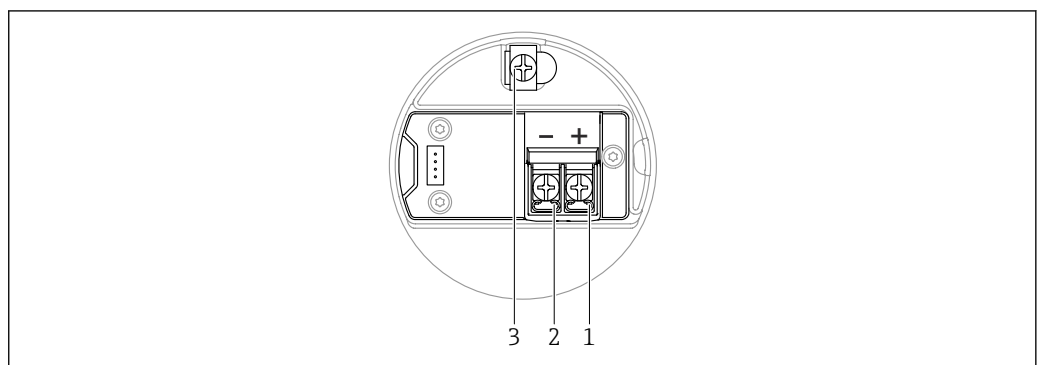

A0045842

9 Connection terminals and ground terminal in the connection compartment

- 1 Plus terminal
- 2 Minus terminal
- 3 Internal ground terminal

6.2.6 Cable entries

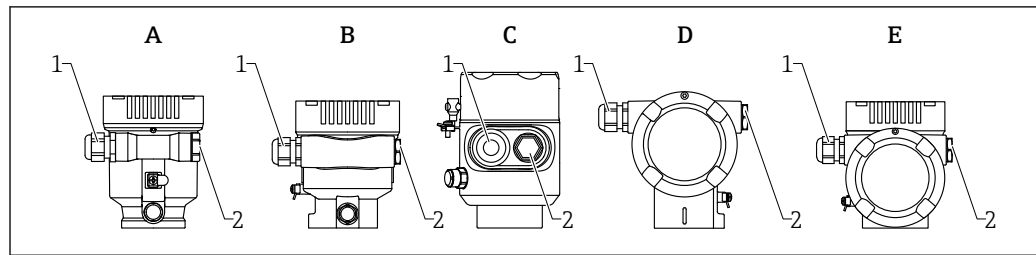

A0046584

- A Single compartment housing, plastic
 B Single compartment housing, aluminum, coated
 C Single compartment housing, 316L, hygiene
 D Dual compartment housing, aluminum, coated
 E Dual compartment housing, L-shaped, aluminum, coated
 1 Cable entry
 2 Dummy plug

The number and type of cable entries depend on the device version ordered.

i Always route connecting cables downwards so that moisture cannot penetrate the connection compartment.

If necessary, create a drip loop or use a weather protection cover.

6.2.7 Available device plugs

i In the case of devices with a plug, it is not necessary to open the housing for connection purposes.

Use the enclosed seals to prevent the penetration of moisture into the device.

Devices with M12 plug

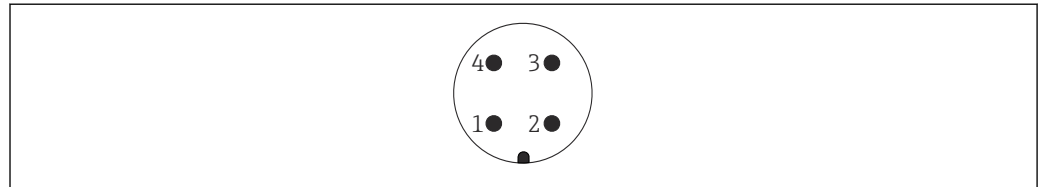

A0011175

10 View of the plug-in connection on the device

- 1 APL signal -
 2 APL signal +
 3 Shielding
 4 Not assigned

Various M12 sockets are available as accessories for devices with M12 plugs.

6.3 Ensuring the degree of protection

6.3.1 Cable entries

- M20 coupling, plastic, IP66/68 NEMA TYPE 4X/6P
- M20 coupling, nickel-plated brass, IP66/68 NEMA TYPE 4X/6P
- M20 coupling, 316L, IP66/68 NEMA TYPE 4X/6P
- M20 thread, IP66/68 NEMA Type 4X/6P

- G1/2 thread, IP66/68 NEMA Type 4X/6P
If the G1/2 thread is selected, the device is delivered with an M20 thread as standard and a G1/2 adapter is included with the delivery, along with the corresponding documentation
- NPT 1/2 thread, IP66/68 NEMA Type 4X/6P
- Dummy plug transport protection: IP22, NEMA TYPE 2
- M12 plug
 - When housing is closed and connecting cable is plugged in: IP66/67, NEMA Type 4X
 - When housing is open or connecting cable is not plugged in: IP20, NEMA Type 1

NOTICE**M12 plug: Loss of IP protection class due to incorrect installation!**

- ▶ The degree of protection only applies if the connecting cable used is plugged in and screwed tight.
- ▶ The degree of protection only applies if the connecting cable used is specified according to IP67, NEMA Type 4X.
- ▶ The IP protection classes are only maintained if the dummy cap is used or the cable is connected.

6.4 Post-connection check

- Are the device or cables undamaged (visual inspection)?
- Do the cables used comply with the requirements?
- Do the mounted cables have strain relief?
- Cable glands mounted, securely tightened and leak-tight?
- Does the supply voltage correspond to the specifications on the nameplate?
- No reverse polarity, terminal assignment correct?
- Cover screwed down correctly?
- Cover lock tightened correctly?

7 Operation options

7.1 Overview of operation options

- Operation via operating keys and DIP switches on the electronic insert
- Operation via optical operating keys on the device display (optional)
- Operation via Bluetooth® wireless technology (with optional device display with Bluetooth) with SmartBlue app or FieldXpert, DeviceCare
- Operation via Web server
- Operation via operating tool (Endress+Hauser FieldCare/DeviceCare) or FDI Hosts (e.g., PDM)

7.2 Operating keys and DIP switches on the electronic insert

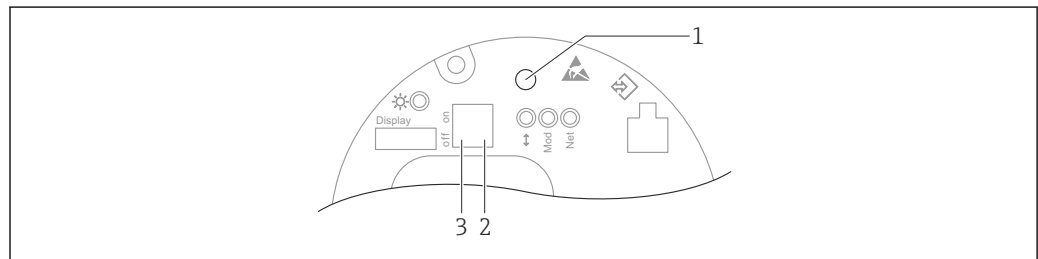

A0046061

 11 Operating keys and DIP switches on the Ethernet-APL electronic insert

- 1 Operating key for Reset password and Reset device
- 2 DIP switch for setting the service IP address
- 3 DIP switch for locking and unlocking the device

 The setting of the DIP switches on the electronic insert has priority over the settings made via other operation methods (e.g. FieldCare/DeviceCare).

7.3 Structure and function of the operating menu

The differences between the structure of the operating menus of the local display and the Endress+Hauser FieldCare or DeviceCare operating tools can be summarized as follows:

The local display is suitable for configuring simple applications.

The operating tools (FieldCare, DeviceCare, SmartBlue, AMS, PDM, etc.) can be used to configure the parameters of wide-ranging applications.

More elaborate applications can be configured with the Web server.

Wizards help the user to commission the various applications. The user is guided through the individual configuration steps.

7.3.1 User roles and related access authorization

The two user roles **Operator** and **Maintenance** (as-delivered state) have different write access to the parameters if a device-specific access code has been defined. This access code protects the device configuration from unauthorized access.



If an incorrect access code is entered, the user obtains the access rights of the **Operator** role.

7.4 Access to operating menu via local display

7.4.1 Device display (optional)

Possible to operate the optical operating keys through the cover. No need to open the device.





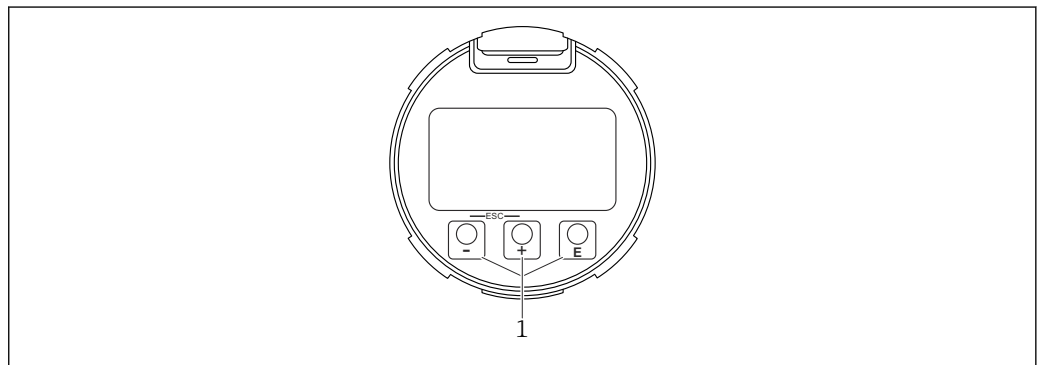

Functions:

- Display of measured values and fault and notice messages
 - Background lighting, which switches from green to red in the event of an error
 - The device display can be removed for easier operation
-  Backlighting is switched on or off depending on the supply voltage and the current consumption.
-  The device display is also optionally available with Bluetooth® wireless technology.



 12 Graphic display with optical operating keys (1)

A0039284

- Key 
 - Navigate downwards in the picklist
 - Edit the numerical values or characters within a function
- Key 
 - Navigate upwards in the picklist
 - Edit the numerical values or characters within a function
- Key 
 - Change from main display to main menu
 - Confirm entry
 - Jump to the next item
 - Select a menu item and activate the edit mode
 - Unlock/lock the display operation
 - Press and hold the  key to display a short description of the selected parameter (if available)
-  key and  key (ESC function)
 - Exit edit mode for a parameter without saving the changed value
 - Menu at a selection level: pressing the keys simultaneously takes the user back up a level in the menu
 - Press and hold the keys simultaneously to return to the upper level

7.4.2 Operation via Bluetooth® wireless technology (optional)

Prerequisite

- Device with device display including Bluetooth
- Smartphone or tablet with Endress+Hauser SmartBlue app or PC with DeviceCare from version 1.07.05 or FieldXpert SMT70

The connection has a range of up to 25 m (82 ft). The range can vary depending on environmental conditions such as attachments, walls or ceilings.

i The operating keys on the display are locked as soon as the device is connected via Bluetooth.

A flashing Bluetooth symbol indicates that a Bluetooth connection is available.

i Please note the following

If the Bluetooth display is removed from one device and installed in another device:

- All the log-in data are only saved in the Bluetooth display and not in the device
- The password changed by the user is also saved in the Bluetooth display

Operation via SmartBlue app

The device can be operated and configured with the SmartBlue app.

- The SmartBlue app must be downloaded onto a mobile device for this purpose.
- For information on the compatibility of the SmartBlue app with mobile devices, see **Apple App Store (iOS devices)** or **Google Play Store (Android devices)**.
- Incorrect operation by unauthorized persons is prevented by means of encrypted communication and password encryption.
- The Bluetooth® function can be deactivated after initial device setup.

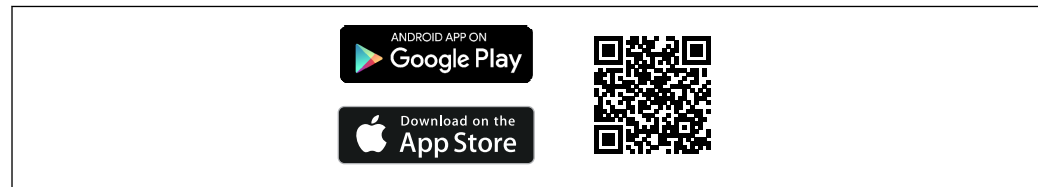

A0033202

13 QR code for free Endress+Hauser SmartBlue app

Download and installation:

1. Scan the QR code or enter **SmartBlue** in the search field of the Apple App Store (iOS) or Google Play Store (Android).
2. Install and start the SmartBlue app.
3. For Android devices: enable location tracking (GPS) (not required for iOS devices).
4. Select a device that is ready to receive from the device list displayed.

Login:

1. Enter the user name: admin
2. Enter the initial password: serial number of the device
3. Change the password after logging in for the first time.

i Notes on the password and reset code

- If the user-defined password is lost, access can be restored via a reset code. The reset code is the device serial number in reverse. Once the reset code has been entered, the Initial password is valid again.
- Like the password, the reset code can also be changed.
- If the user-defined reset code is lost, the password can no longer be reset via the SmartBlue app. In this case, contact Endress+Hauser Service.

7.5 Access to operating menu via web browser

7.5.1 Function scope

Thanks to the integrated Web server the device can be operated and configured via a Web browser. The structure of the operating menu is the same as for the local display. In addition to the measured values, device status information is also displayed and allows users to monitor the status of the device. Furthermore the device data can be managed and the network parameters can be configured.

7.5.2 Prerequisites

Computer software

Recommended operating systems

- Microsoft Windows 7 or higher.
- Mobile operating systems:
 - iOS
 - Android

 Microsoft Windows XP is supported.

Web browsers supported

- Microsoft Internet Explorer 8 or higher
- Microsoft Edge
- Mozilla Firefox
- Google Chrome
- Safari

Computer settings

User rights

Corresponding user rights (e.g., administrator rights) for TCP/IP and proxy server settings are required (for changing the IP address, subnet mask etc.).

Proxy server settings of the web browser

The web browser *Use proxy server for LAN* setting must be **disabled**.

JavaScript

JavaScript must be enabled.

 When installing a new firmware version: To enable correct data display, clear the temporary memory (cache) of the web browser under **Internet options**.

7.5.3 Establishing a connection

Via PROFINET with Ethernet-APL network

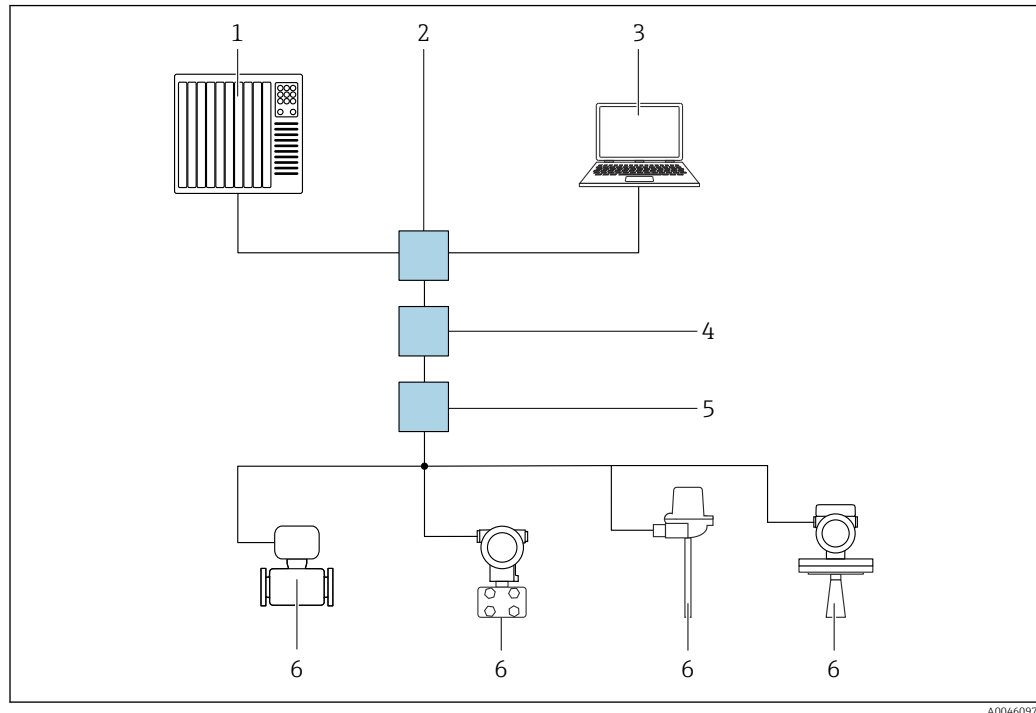

A0046097

14 Options for remote operation via PROFINET with Ethernet-APL network: star topology

- 1 Automation system, e.g. Simatic S7 (Siemens)
- 2 Ethernet switch
- 3 Computer with Web browser (e.g., Microsoft Edge) for accessing the integrated device Web server or computer with operating tool (e.g., FieldCare, DeviceCare, SIMATIC PDM) with iDTM Profinet Communication
- 4 APL power switch (optional)
- 5 APL field switch
- 6 APL field device

Call up the website via the computer in the network. The IP address of the device must be known.

The IP address can be assigned to the device in a variety of ways:

- Dynamic Configuration Protocol (DCP), factory setting
The automation system (e.g. Siemens S7) automatically assigns the IP address to the device
 - Software addressing
The IP address is entered via the IP address parameter
 - DIP switch for service
The device then has the fixed IP address 192.168.1.212
- i** The IP address is only adopted following a restart.
The IP address can now be used to establish the connection to the network

The default setting is that the device uses the Dynamic Configuration Protocol (DCP). The automation system (e.g. Siemens S7) automatically assigns the IP of the device.

Starting the Web browser and logging in

1. Start the Web browser on the computer.
2. Enter the IP address of the device in the address line of the Web browser
 - ↳ The login page appears.

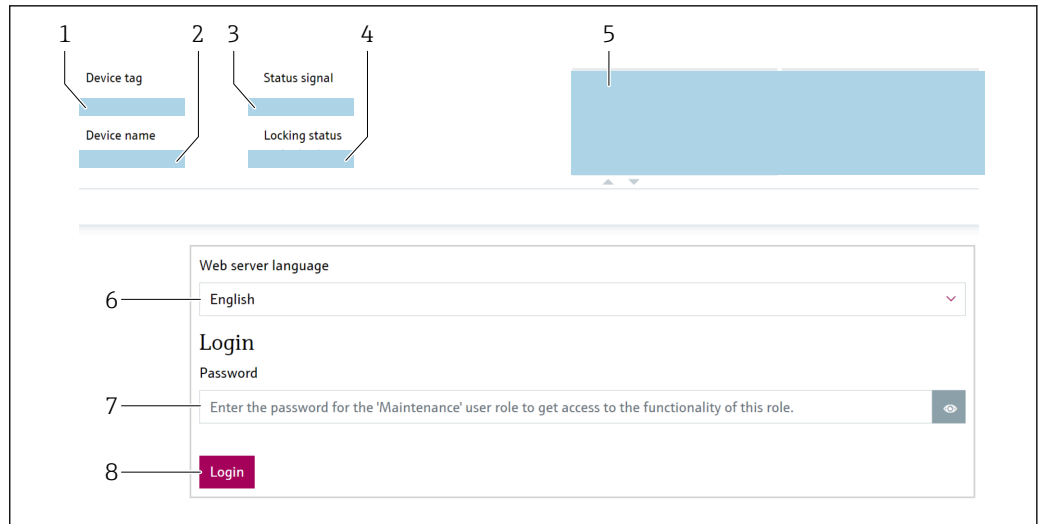

A0046626

15 Web browser login

- 1 Device tag
- 2 Device name
- 3 Status signal
- 4 Locking status
- 5 Current measured values
- 6 Select the language
- 7 Enter the "Password" parameter
- 8 Login

1. Select the preferred **Language** parameter for the Web browser.
2. Enter the **Password** parameter (factory setting 0000).
3. Confirm entry with Login .

7.5.4 User interface

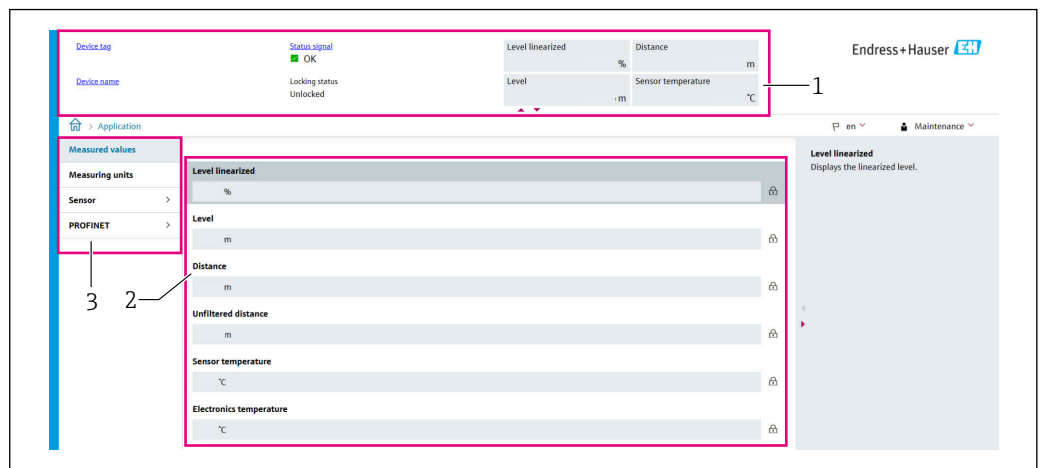

A0052432

16 User interface with sample contents

- 1 Header
- 2 Working area
- 3 Navigation area

Header

The following information appears in the header:

- Device tag
- Device name
- Status signal
- Locking status
- Current measured values

Navigation area

If a function is selected in the function bar, the submenus of the function open in the navigation area. The user can now navigate within the menu structure.

Working area

Depending on the selected function and the related submenus, various actions can be performed in this area:

- Configure parameters
- Read measured values
- Call up help text

Adopting a value

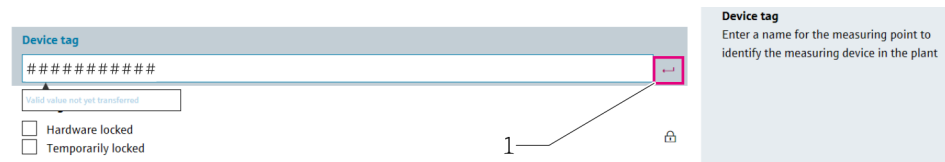

17 Example of Enter button

1 Enter button in the operating tool

The value entered is only adopted by pressing the Enter key or clicking on the Enter button (1).

7.5.5 Disabling the Web server

The Web server of the measuring device can be switched on and off as required using the **Web server functionality** parameter.

Navigation

"System" menu → Connectivity → Interfaces

Parameter overview with brief description

Parameter	Description	Selection
Web server functionality	Switch web server on and off, switch off HTML.	<ul style="list-style-type: none"> ■ Disable ■ Enable

Range of functions of "Web server functionality" parameter

Option	Description
Disable	<ul style="list-style-type: none"> ▪ The Web server is completely disabled. ▪ Port 80 is locked.
Enable	<ul style="list-style-type: none"> ▪ The complete functionality of the Web server is available. ▪ JavaScript is used. ▪ The password is transferred in an encrypted state. ▪ Any change to the password is also transferred in an encrypted state.

Enabling the Web server

If the Web server is disabled, it can only be re-enabled with the **Web server functionality** parameter via the following operating options:

- Via local display
- Via the "FieldCare" operating tool
- Via the "DeviceCare" operating tool
- Via the PROFINET startup record

7.5.6 Logging out

1. Select the **Logout** entry in the function bar.
 - ↳ The home page with the Login box appears.
2. Close the Web browser.

 Once communication with the Web server is established via the standard IP address 192.168.1.212, the DIP switch must be reset (from **ON** → **OFF**). Following a reboot, the configured IP address of the device is once again active for network communication.

7.6 Access to the operating menu via the operating tool

The structure of the operating menu in the operating tools is the same as for operation via the local display. The range of functions is different however.

7.6.1 Connecting the operating tool

Via PROFINET with Ethernet-APL network

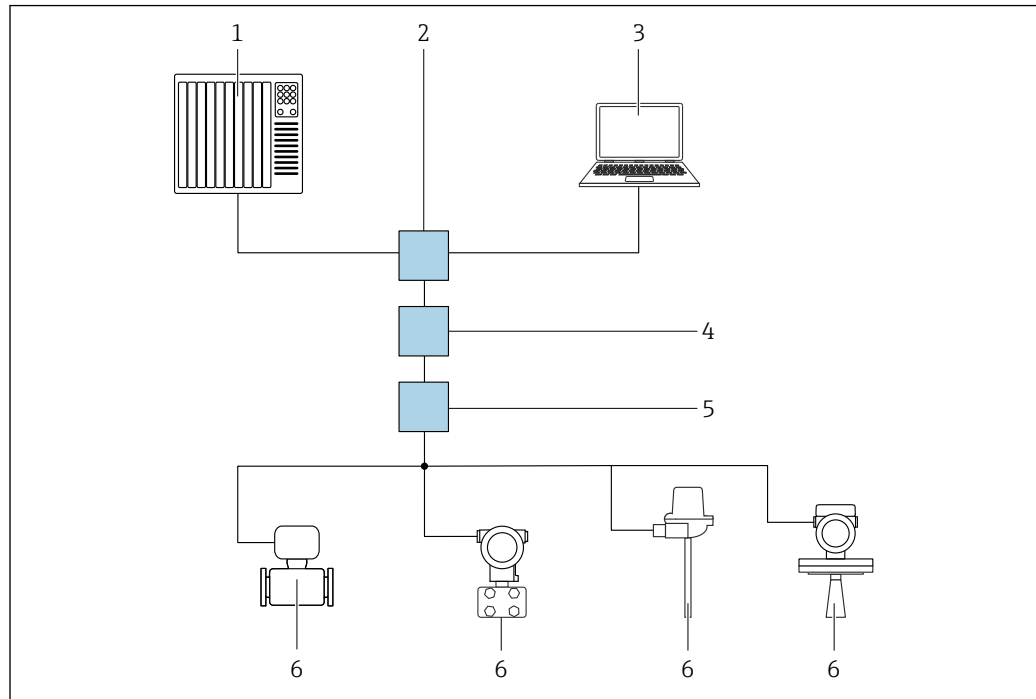

A0046097

18 Options for remote operation via PROFINET with Ethernet-APL network: star topology

- 1 Automation system, e.g. Simatic S7 (Siemens)
- 2 Ethernet switch
- 3 Computer with Web browser (e.g., Microsoft Edge) for accessing the integrated device Web server or computer with operating tool (e.g., FieldCare, DeviceCare, SIMATIC PDM) with iDTM Profinet Communication
- 4 APL power switch (optional)
- 5 APL field switch
- 6 APL field device

Call up the website via the computer in the network. The IP address of the device must be known.

The IP address can be assigned to the device in a variety of ways:

- Dynamic Configuration Protocol (DCP), factory setting
The automation system (e.g. Siemens S7) automatically assigns the IP address to the device
 - Software addressing
The IP address is entered via the IP address parameter
 - DIP switch for service
The device then has the fixed IP address 192.168.1.212
-  The IP address is only adopted following a restart.
The IP address can now be used to establish the connection to the network

The default setting is that the device uses the Dynamic Configuration Protocol (DCP). The automation system (e.g. Siemens S7) automatically assigns the IP of the device.

Service interface

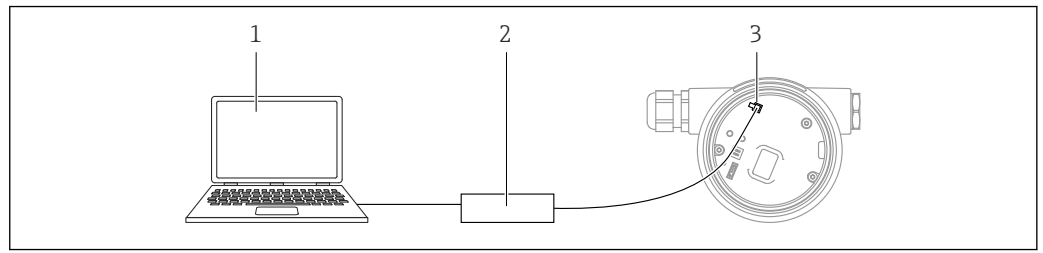

- 1 Computer with FieldCare/DeviceCare operating tool
 2 Commubox FXA291
 3 Service interface (CDI) of the device (= Endress+Hauser Common Data Interface)

 To update (flash) the device firmware, the device must be powered via the power supply terminals.

7.7 FieldCare

7.7.1 Function range

FDT-based plant asset management tool from Endress+Hauser. FieldCare can configure all smart field devices in a system and helps you manage them. By using the status information, FieldCare is also a simple but effective way of checking their status and condition.

Access is via:

- CDI service interface
- PROFINET interface

Typical functions:

- Configuration of transmitter parameters
- Loading and saving of device data (upload/download)
- Documentation of the measuring point
- Visualization of the measured value memory (line recorder) and event logbook

 For additional information about FieldCare, see Operating Instructions BA00027S and BA00059S

7.8 DeviceCare

7.8.1 Function scope

Tool for connecting and configuring Endress+Hauser field devices.

The fastest way to configure Endress+Hauser field devices is with the dedicated "DeviceCare" tool. Together with the device type managers (DTMs), DeviceCare presents a convenient, comprehensive solution.

 For details, see Innovation Brochure IN01047S

8 System integration

8.1 Overview of device description files

8.1.1 Current version data for the device

Firmware version	01.00.zz	<ul style="list-style-type: none"> ▪ On the title page of the Operating Instructions ▪ On the transmitter nameplate ▪ System → Information → Firmware version
Firmware version parameter release date	04.2023	–
Manufacturer ID	ID: 0x11	Guidance → Commissioning → Device identification → Manufacturer ID
Device ID	ID: A1C1	Guidance → Commissioning → Device identification → Device ID On the transmitter nameplate
Profile 4 device ID	B321	On the transmitter nameplate
Device revision	1	On the transmitter nameplate
PROFINET version	2.4x	–
PA profile version	4.0x	Application → PROFINET → Information → PA profile version

8.1.2 Operating tools

The suitable device description file for the individual operating tools is listed in the table below, along with information on where the file can be acquired.

Operating tool via Service interface (CDI)	Sources for obtaining device descriptions
FieldCare	<ul style="list-style-type: none"> ▪ www.endress.com → Downloads section ▪ CD-ROM (contact Endress+Hauser) ▪ DVD (contact Endress+Hauser)
DeviceCare	<ul style="list-style-type: none"> ▪ www.endress.com → Downloads section ▪ CD-ROM (contact Endress+Hauser) ▪ DVD (contact Endress+Hauser)
SMT70	Use update function of handheld terminal
AMS Device Manager (Emerson Process Management)	www.endress.com → Downloads section
SIMATIC PDM (Siemens)	www.endress.com → Downloads section

8.2 Device master file (GSD)

In order to integrate field devices into a bus system, the PROFINET with Ethernet-APL system needs a description of the device parameters, such as output data, input data, data format and data volume.

These data are available in the device master file (GSD) which is provided to the automation system when the communication system is commissioned. In addition device bit maps, which appear as icons in the network structure, can also be integrated.

The device master file (GSD) is in XML format, and the file is created in the GSDML description markup language.

Downloading the device master file (GSD)

- Via Web server: Menu path System → Device drivers
- Via www.endress.com/download

8.2.1 File name of the device master file (GSD)

Example of the name of a device master file:

GSDML-V2.43-EH-Micropilot-202304dd.xml (dd corresponds to the release day)

GSDML	Description language
V2.43	Version of the PROFINET specification
EH	Endress+Hauser
Micropilot	Instrument family
20230422	Date of issue (year, month, day)
.xml	File name extension (XML file)

8.3 Cyclic data transmission

8.3.1 Overview of the modules

The following graphic shows which modules are available to the device for cyclic data exchange. Cyclic data exchange is performed with an automation system.

Application → PROFINET → Analog input → Analog input 1 to 11 → Assign process variable

Device		Direction Data flow	Control system
Module	Slot		
Analog input Level	1	→	PROFINET
Analog input Distance	2	→	
Analog input Volume	3	→	
Analog input Sensor temperature	20	→	
Analog input Electronics temperature	21	→	
Analog input Absolute echo amplitude	22	→	
Analog input Relative echo amplitude	23	→	
Analog input Percent of range	24	→	
Analog input (Area of incoupling)	25	→	
Analog input Buildup index	26	→	
Analog input Foam index	27	→	
Binary input Heartbeat Technology	80	→	
Binary input (Build up/Foam)	81	→	
Binary output Heartbeat Technology	210	←	

8.3.2 Description of the modules



The data structure is described from the perspective of the automation system:

- Input data: are sent from the device to the automation system
- Output data: are sent from the automation system to the device

Module: Analog input

Transmission of input variables from the device to the automation system:

Analog input modules cyclically transmit the selected input variables, including the status, from the device to the automation system. The input variable is depicted in the first four bytes in the form of a floating point number as per the IEEE 754 standard. The fifth byte contains status information pertaining to the input variable. The Analog input module Level in slot 1 is contained in the Level PA PROFILE GSD, the other Analog input modules can only be used with the manufacturer's GSD.

Module: Binary output

The Binary output module can cyclically receive discrete output values from the automation system. The device implements an 8-bit type as described in PA PROFILE 4.0x. Of this, 1 bit is used to signal to the device that Heartbeat Verification should be started.

Bit	Function	Description
0	Start verification	Start the verification
1-7	-	-

Module: Binary input

The Binary input module can cyclically send discrete values from the device to the automation system. The status of the Heartbeat Verification is transmitted for the device:

Module: Binary input Heartbeat Technology slot 80

Bit	Function	Description
0	Status parameter Not done option	Verification not carried out
1	Status parameter Failed option	The device has not passed the verification. At least one test group was outside the specifications.
2	Status parameter Busy option	Verification in progress
3	Status parameter Done option	Verification carried out
4	Verification result parameter Failed option	The device has not passed the verification. At least one test group is outside the specifications.
5	Verification result parameter Passed option	The device has passed the verification. All of the verified test groups corresponded to the specifications.
6	The verification result is also "Passed" if the result for an individual test group is "Failed" and the result for all other test groups is "Passed".	
7	Verification result parameter Not done option	Verification not carried out

Module: Binary input Sensor diagnostics slot 81

Bit	Function	Description
0	Buildup on the sensor	Buildup detected on the sensor
1	Foam generation	Foam generation detected
2-7	-	

8.3.3 Status coding

Status	Coding (hex)	Meaning
BAD - Maintenance alarm	0x24	No measured value available, as a device error has occurred.
BAD - Process related	0x28	No measured value available, as the process conditions are not within the device's technical specification limits.
BAD - Function check	0x3C	A function check is active (e.g. cleaning or calibration)
UNCERTAIN - Initial value	0x4F	A predefined value is output until a correct measured value is available again or corrective measures have been performed that change this status.
UNCERTAIN - Maintenance demanded	0x68	Wear and tear has been detected. Maintenance is needed shortly to ensure the device remains operational. The measured value might be invalid. The use of the measured value depends on the application.
UNCERTAIN - Process related	0x78	The process conditions are not within the device's technical specification limits. This could have a negative impact on the quality and accuracy of the measured value. The use of the measured value depends on the application.
GOOD - OK	0x80	No error has been diagnosed.
GOOD - Maintenance demanded	0xA8	The measured value is valid. It is highly advisable to service the device in the near future.
GOOD - Function check	0xBC	The measured value is valid. The device performs an internal function check. The function check does not have any noticeable effect on the process.

8.3.4 Startup configuration

Startup configuration (NSU)	<p>The automation system adopts the configuration of the most important parameters of the device.</p> <ul style="list-style-type: none"> ▪ Interfaces: <ul style="list-style-type: none"> ▪ Display operation ▪ Web server functionality ▪ Bluetooth activation ▪ Service (UART-CDI) ▪ System units: <ul style="list-style-type: none"> ▪ Level unit ▪ Volume unit ▪ Temperature unit ▪ Application: <ul style="list-style-type: none"> ▪ Maximum value ▪ Intermediate height ▪ Medium type ▪ Full calibration ▪ Empty calibration ▪ Diameter ▪ Diagnostic settings: <ul style="list-style-type: none"> Diagnostic behavior for diverse diagnostic information ▪ Analog inputs: <ul style="list-style-type: none"> Damping
-----------------------------	---

8.4 System redundancy S2

A redundant layout with two automation systems is necessary for processes that are in continuous operation. If one system fails the second system guarantees continued, uninterrupted operation. The device supports S2 system redundancy and can communicate simultaneously with both automation systems.

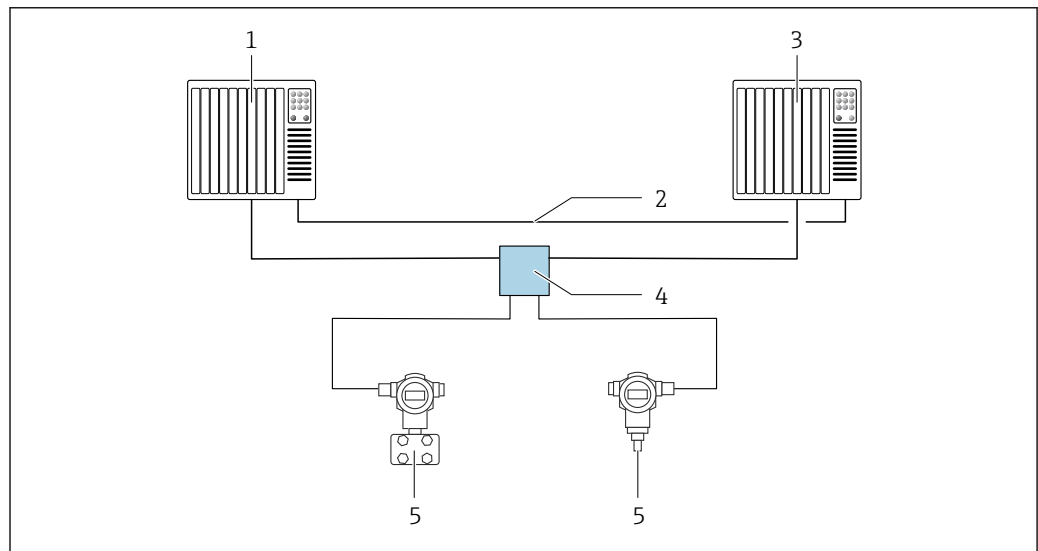

 19 Example of the layout of a redundant system (S2): star topology

- 1 Automation system 1
- 2 Synchronization of automation systems
- 3 Automation system 2
- 4 Ethernet-APL Field Switch
- 5 Device



All the devices in the network must support S2 system redundancy.

9 Commissioning

i All configuration tools provide a commissioning assistant that supports the user when setting the most important configuration parameters (**Guidance** menu **Commissioning** wizard).

9.1 Preliminaries

The measuring range and the unit in which the measured value is transmitted correspond to the data on the nameplate.

9.2 Installation and function check

Before commissioning the measuring point, check whether the post-installation and post-connection checks have been performed.

 Post-mounting check

 Post-connection check

9.3 Connecting via FieldCare and DeviceCare

9.3.1 Via PROFINET protocol

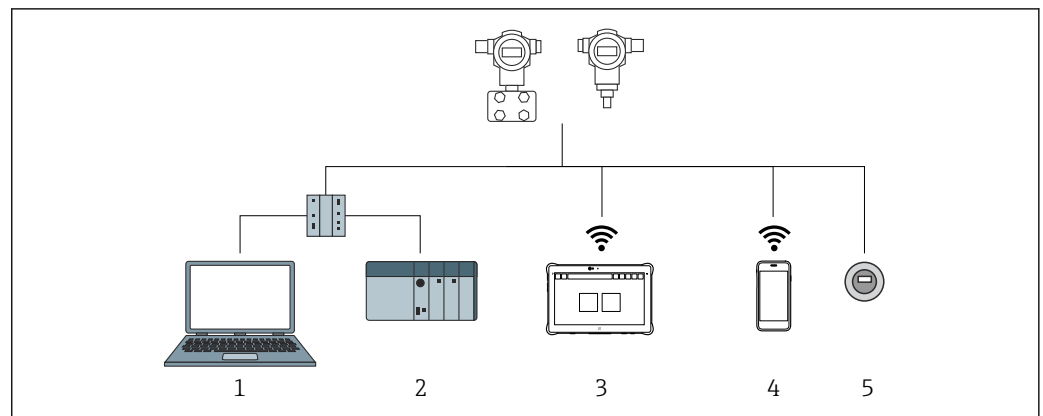

 20 Options for remote operation via PROFINET protocol

- 1 Computer with web browser or with operating tool (e.g., DeviceCare)
- 2 Automation system
- 3 Field Xpert SMT70
- 4 Mobile handheld terminal
- 5 Local operation via display module

A0046623

9.3.2 Via service interface (CDI)

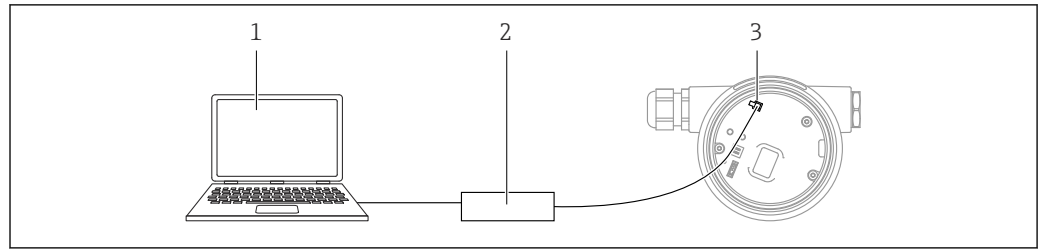

A0039148

- 1 Computer with FieldCare/DeviceCare operating tool
- 2 Commubox
- 3 Service interface (CDI) of the device (= Endress+Hauser Common Data Interface)

9.3.3 Hardware settings

Setting the device name

A measuring point can be quickly identified within a plant on the basis of the **Device tag** parameter and **PROFINET device name** parameter. The **Device tag** parameter, which is specified ex works or defined when ordering, can be changed in the operating menu.

Configuring the "Device tag" parameter via the operating menu

The **Device tag** parameter can be adapted via the operating menu or automation system.

System → Device management

Configuring the "PROFINET device name" parameter via the operating menu

Application → PROFINET → Configuration

Configuring the "PROFINET device name" parameter via the automation system

The **PROFINET device name** parameter can be adapted individually via the automation system.

- i** When assigning the **PROFINET device name** parameter via the automation system:
assign the device name in lower case letters.

Activating the default IP address

Activating the default IP address via the DIP switch

The device can be set to the default IP address 192.168.1.212 via DIP switches.

1. Set DIP switch 2 on the electronic insert from **OFF** → **ON**.
2. Reconnect the device to the power supply.
 - ↳ The default IP address is used once the device is restarted.

9.3.4 Configuring the communication parameters via the software

- IP address
- Subnet mask
- Default gateway





Menu path: System → Connectivity → Ethernet

9.4 Configuring the operating language

9.4.1 Local display

Setting the operating language

 To set the operating language, the display first needs to be unlocked:

1. Press the  key for at least 2 s.
↳ A dialog box appears.
2. Unlock the display operation.
3. Select the **Language** parameter in the main menu.
4. Press the  key.
5. Select the desired language with the  or  key.
6. Press the  key.

 Display operation locks automatically (except in the **Safety mode** wizard):

- after 1 min on the main page if no key has been pressed
- after 10 min within the operating menu if no key has been pressed

9.4.2 Operating tool

Set display language

System → Display → Language

Selection in **Language** parameter; Visibility depends on order options or device settings

9.4.3 Web server

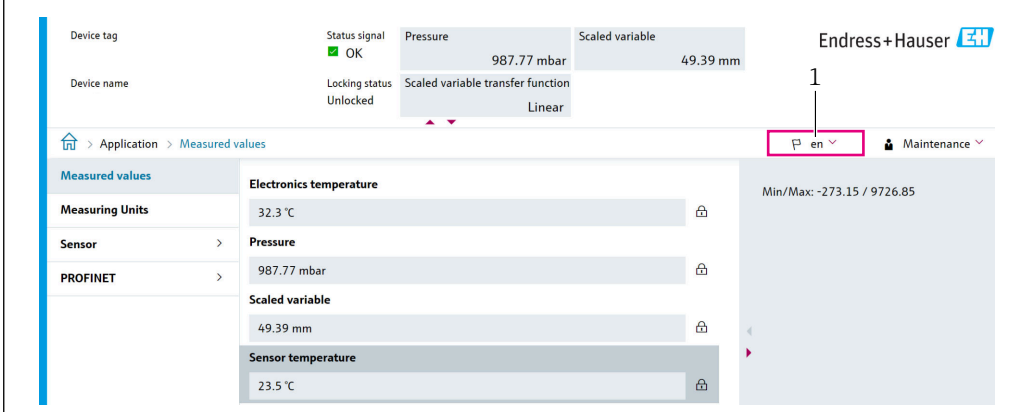

The screenshot shows the 'Measured values' page on the web server. At the top, there is a status bar with 'Status signal' (OK), 'Pressure' (987.77 mbar), and 'Scaled variable' (49.39 mm). Below this, the 'Locking status' is 'Unlocked' and the 'Scaled variable transfer function' is 'Linear'. The main content area is titled 'Measured values' and contains a table of sensor readings:

Measuring Units	Value
Electronics temperature	32.3 °C
Pressure	987.77 mbar
Scaled variable	49.39 mm
Sensor temperature	23.5 °C

On the right side, there is a 'Maintenance' section with a 'Min/Max: -273.15 / 9726.85' value. The language is set to 'en' and the user is 'Endress+Hauser'.

1 Language setting

A0048882

9.5 Configuring the device

9.5.1 Level measurement in bulk solids

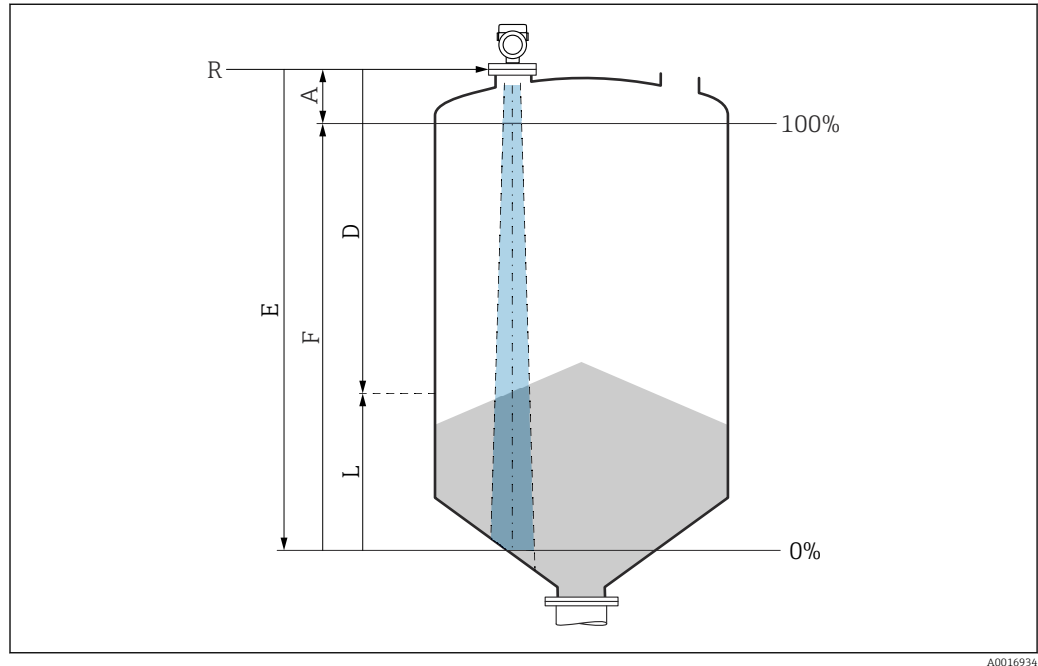

21 Configuration parameters for level measurement in bulk solids

- R Reference point of measurement
- A Length of antenna + 10 mm (0.4 in)
- D Distance
- L Level
- E "Empty calibration" parameter (= 0 %)
- F "Full calibration" parameter (= 100 %)

9.5.2 Commissioning with the Commissioning wizard

In FieldCare, DeviceCare, SmartBlue and on the display, the **Commissioning** wizard is available to guide the user through the initial commissioning steps.

Complete this wizard to commission the device.

For each parameter, enter the appropriate value or select the appropriate option.

NOTE

If you exit the wizard before completing all required parameters, the changes you have made will be saved. For this reason, the device may then be in an undefined state! In this case, a reset to the default settings is recommended.

9.6 Recording the Echo curve

i The Echo curve is only saved in the relevant operating tool.

Record the current Echo curve as a reference echo curve for subsequent diagnostic purposes.

After the measurement has been configured, it is recommended to record the current Echo curve as a reference echo curve.

The **Save reference curve** parameter in the **Echo curve** submenus used to record the Echo curve.

Diagnostics → Echo curve → Save reference curve

- ▶ Under the **Save reference curve** parameter, activate the **Customer reference curve** option

9.7 "Simulation" submenu

Simulation of a process variable, a pulse output or a diagnostic event.

10 Operation

10.1 Reading off the device locking status

Displaying active write protection:

- In the **Locking status** parameter
 - Menu path of local display: at the top operating level
 - Menu path of operating tool: System → Device management
- In the operating tool in the header

10.2 Reading off measured values

Many measured values can be read off in the header of the Web server.

All the measured values can be read off using the **Measured values** submenu.

Navigation

"Application" menu → Measured values

10.3 Adapting the device to process conditions

The following menus are available for this purpose:

- Basic settings in the **Guidance** menu
- Advanced settings in:
 - **Diagnostics** menu
 - **Application** menu
 - **System** menu

11 Diagnosis and troubleshooting

11.1 General troubleshooting

11.1.1 General errors

Device is not responding

- Possible cause: Supply voltage does not match the specification on the nameplate
Remedial action: Apply the correct voltage
- Possible cause: The connecting cables are not in contact with the terminals
Remedial action: Check the electrical contact between cables and correct if necessary

Values not visible on the display

- Possible cause: Display setting is too bright or too dark
Remedy:
Use the **Contrast display** parameter to increase or reduce contrast
Navigation path: System → Display → Contrast display
- Possible cause: The plug of the display cable is not connected correctly
Remedial action: Connect the plug correctly
- Possible cause: Display is defective
Remedial action: Replace the display

"Communication error" is indicated on the display when the device is started or the display is connected

- Possible cause: Electromagnetic interference influence
Remedial action: Check grounding of the device
- Possible cause: Defective cable connection or display plug
Remedial action: Replace the display

Communication via CDI interface not working

Possible cause: Wrong setting of the COM port on the computer

Remedial action: Check the setting of the COM port on the computer and correct it if necessary

Device measuring incorrectly

Possible cause: Parameter configuration error

Remedial action: Check and correct the parameter configuration

11.2 Error - SmartBlue operation

Operation via SmartBlue is only possible on devices that have a display with Bluetooth (optionally available).

Device is not visible in the live list

- Possible cause: No Bluetooth connection available
Remedial action: Enable Bluetooth in the field device via display or software tool and/or in the smartphone/tablet
- Possible cause: Bluetooth signal outside range
Remedial action: Reduce distance between field device and smartphone/tablet
The connection has a range of up to 25 m (82 ft).
Operating radius with intervisibility 10 m (33 ft)
- Possible cause: Geopositioning is not enabled on Android devices or is not permitted for the SmartBlue app
Remedial action: Enable/disable geolocation service on Android device for the SmartBlue app
- Display does not have Bluetooth
- Historom is not connected

Device appears in the live list but a connection cannot be established

- Possible cause: The device is already connected with another smartphone/tablet via Bluetooth
 Only one point-to-point connection is permitted
 Remedial action: Disconnect the smartphone/tablet from the device
- Possible cause: Incorrect user name and password
 Remedial action: The standard user name is "admin" and the password is the device serial number indicated on the device nameplate (only if the password was not changed by the user beforehand)
 If the password has been forgotten, contact Endress+Hauser Service (www.addresses.endress.com)

Connection via SmartBlue not possible

- Possible cause: Incorrect password entered
 Remedial action: Enter the correct password, paying attention to lower/upper case
- Possible cause: Forgotten password
 Remedial action: Contact Endress+Hauser Service (www.addresses.endress.com)

Login via SmartBlue not possible

- Possible cause: Device is being put into operation for the first time
 Remedial action: Enter the user name "admin" and the password (device serial number), paying attention to lower/upper case
- Possible cause: The electric current and voltage are not correct.
 Remedial action: Increase the supply voltage.

Device cannot be operated via SmartBlue

- Possible cause: Incorrect password entered
 Remedial action: Enter the correct password, paying attention to lower/upper case
- Possible cause: Forgotten password
 Remedial action: Contact Endress+Hauser Service (www.addresses.endress.com)
- Possible cause: **Operator** option has no authorization
 Remedial action: System → User management → User role Change to **Maintenance** option

11.3 Diagnostic message

Faults detected by the self-monitoring system of the device are displayed as a diagnostic message in alternation with the measured value.

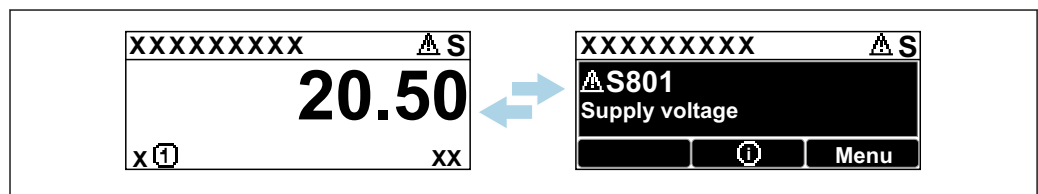

A0051136

22 Diagnostic message displayed in alternating sequence with the measured value

If two or more diagnostic events occur simultaneously, only the diagnostic message with the highest priority is shown.

11.3.1 Diagnostic information on local display

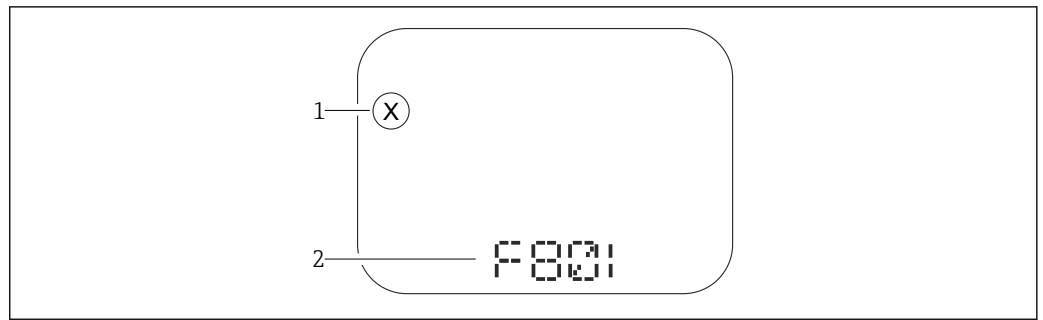

A0043759

23 Segment display without keys

- 1 Status symbol for event level
- 2 Status signal with diagnostic event

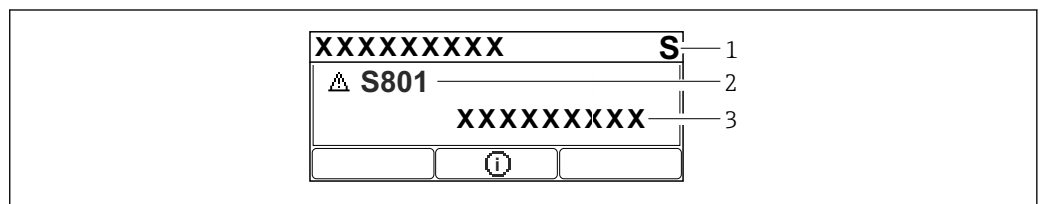

A0043103

24 Graphic display with keys

- 1 Status signal
- 2 Status symbol with diagnostic event and preceding symbol for event level
- 3 Event text

11.3.2 Diagnostic information in the operating tool

If a diagnostic event has occurred in the device, the status signal appears in the top left status area of the operating tool together with the corresponding symbol for the event level according to NAMUR NE 107.

Click the status signal to see the detailed status signal.

Pending diagnostic messages can also be displayed in the **Active diagnostics** parameter.

The diagnostic events and remedial measures can be printed out in the **Diagnostic list** submenu.

11.3.3 Status signal

F

Failure (F)

A device error has occurred. The measured value is no longer valid.

C

Function check (C)

The device is in the service mode (e.g. during a simulation).

S

Out of specification (S)

Device operation:

- Outside of the technical specifications (e.g. during startup or a cleaning)
- Outside of the configuration performed by the user (e.g. sensor frequency outside the configured span)

M

Maintenance required (M)

Maintenance required. The measured value is still valid.

11.3.4 Diagnostic event and event text

The fault can be identified by means of the diagnostic event. The event text helps you by providing information about the fault. In addition, the associated status symbol is displayed in front of the diagnostic event.

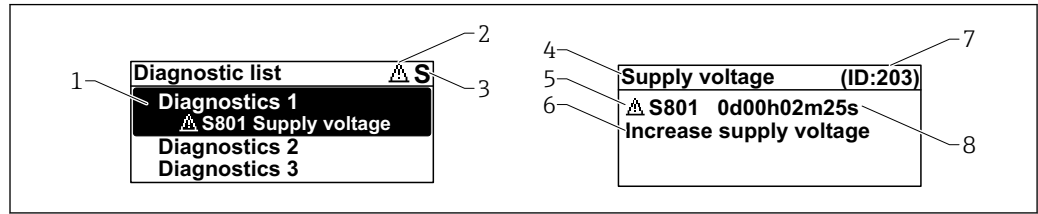

A0051137

- 1 Diagnostic message
- 2 Symbol for event level
- 3 Status signal
- 4 Short text
- 5 Symbol for event level, status signal, diagnostic number
- 6 Remedial measure
- 7 Service ID
- 8 Operating time of occurrence

Symbol for event level

⊗ "Alarm" status

Measurement is interrupted. The signal outputs adopt the defined alarm state. A diagnostic message is generated.

⚠ "Warning" status

The device continues to measure. A diagnostic message is generated.

11.4 Remedy information Calling up

11.4.1 Graphic display with keys

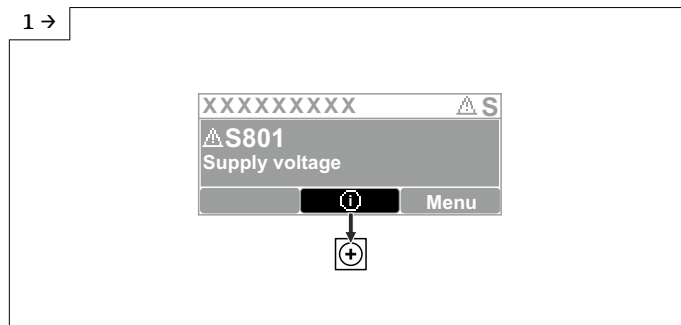

A0051131

- ▶ Open the **Diagnostic list** submenu

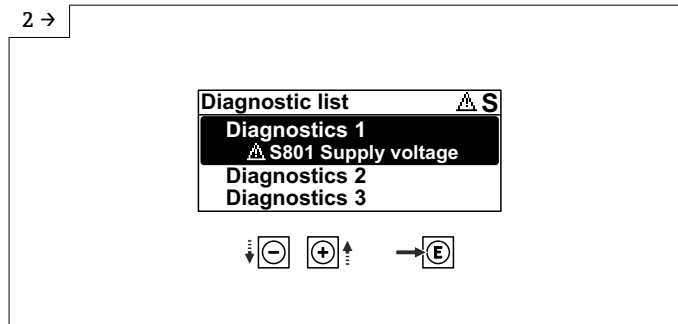

A0051132

- ▶ Select the diagnostic event and confirm

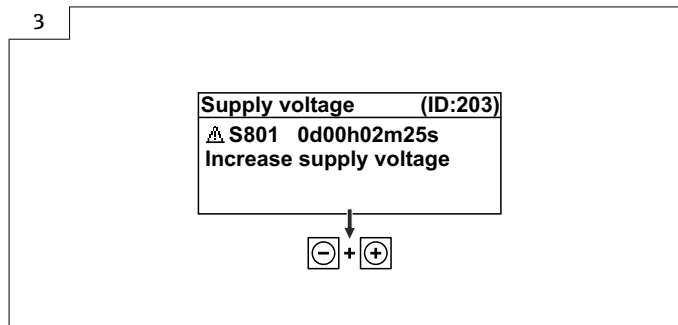

A0051133

- ▶ Remedy informationClosing

11.4.2 Operating menu

In the **Diagnostic list** submenu, up to 5 currently pending diagnostic messages can be displayed. If more than 5 messages are pending, the messages with the highest priority are shown on the display.

Navigation path

Diagnostics → Diagnostic list

Queued diagnostic messages are also displayed in the **Active diagnostics** parameter.

Navigation: Diagnostics → Active diagnostics

11.5 Adapting the diagnostic information

The event level can be configured:

Navigation: Diagnostics → Diagnostic settings → Configuration

11.6 List of diagnostic events

i If Remedy information **Contact the Service Department** is displayed (www.addresses.endress.com), be ready with the **service ID** shown.

Diagnostic number	Short text	Remedy instructions	Status signal [from the factory]	Diagnostic behavior [from the factory]
Diagnostic of sensor				
062	Sensor connection faulty	Check sensor connection	F	Alarm
151	Sensor electronic failure	1. Restart device 2. Contact service	F	Alarm

Diagnostic number	Short text	Remedy instructions	Status signal [from the factory]	Diagnostic behavior [from the factory]
168	Buildup detected	Check process conditions	M	Warning ¹⁾
Diagnostic of electronic				
232	Real time clock defective	Replace main electronics	M	Warning
242	Firmware incompatible	1. Check software 2. Flash or change main electronic module	F	Alarm
252	Module incompatible	1. Check if correct electronic module is plugged 2. Replace electronic module	F	Alarm
270	Main electronics defective	Replace main electronics	F	Alarm
272	Main electronics faulty	1. Restart device 2. Contact service	F	Alarm
273	Main electronics defective	Replace main electronics	F	Alarm
282	Data storage inconsistent	Restart device	F	Alarm
283	Memory content inconsistent	1. Restart device 2. Contact service	F	Alarm
287	Memory content inconsistent	1. Restart device 2. Contact service	M	Warning
331	Firmware update failed	1. Update firmware of device 2. Restart device	M	Warning
388	Electronics and HistoROM defective	1. Restart device 2. Replace electronics and HistoROM 3. Contact service	F	Alarm
Diagnostic of configuration				
410	Data transfer failed	1. Retry data transfer 2. Check connection	F	Alarm
412	Processing download	Download active, please wait	S	Warning
435	Linearization faulty	Check linearization table	F	Alarm
436	Date/time incorrect	Check date and time settings.	M	Warning ¹⁾
437	Configuration incompatible	1. Update firmware 2. Execute factory reset	F	Alarm
438	Dataset different	1. Check dataset file 2. Check device parameterization 3. Download new device parameterization	M	Warning
484	Failure mode simulation active	Deactivate simulation	C	Alarm
485	Process variable simulation active	Deactivate simulation	C	Warning
495	Diagnostic event simulation active	Deactivate simulation	S	Warning
538	Configuration Sensor Unit invalid	1. Check sensor configuration 2. Check device configuration	F	Alarm
585	Simulation distance	Deactivate simulation	C	Warning

Diagnostic number	Short text	Remedy instructions	Status signal [from the factory]	Diagnostic behavior [from the factory]
586	Record map	Recording of mapping please wait	C	Warning
Diagnostic of process				
801	Supply voltage too low	Increase supply voltage	S	Warning
802	Supply voltage too high	Decrease supply voltage	S	Warning
825	Electronics temperature	1. Check ambient temperature 2. Check process temperature	S	Warning
826	Sensor temperature out of range	1. Check ambient temperature 2. Check process temperature	S	Warning
941	Echo lost	Check parameter "DC value"	S	Warning ¹⁾
942	In safety distance	1. Check level 2. Check safety distance 3. Reset self holding	S	Warning ¹⁾
952	Foam detected	Check process conditions	S	Warning ¹⁾
968	Level limited	1. Check level 2. Check limit parameters	S	Warning

1) Diagnostic behavior can be changed.

11.7 Event logbook

11.7.1 Event history

A chronological overview of the event messages that have occurred is provided in the **Event logbook** submenu. This submenu only exists if operating via the local display with keys. In the case of operation via FieldCare, the event list can be displayed with the "Event List / HistoROM" functionality of FieldCare.

Navigation:

Diagnostics → Event logbook → Event list

A maximum of 100 event messages can be displayed in chronological order.



The event history includes entries for:

- Diagnostic events
- Information events

In addition to the operating time when the event occurred, each event is also assigned a symbol that indicates whether the event has occurred or is finished:

- Diagnostic event
 - ☺: Occurrence of the event
 - ☹: End of the event
- Information event
 - ☺: Occurrence of the event

Calling up and closing the remedial measures

1. Press .
 - ↳ The message for the remedial measures for the selected diagnostic event opens.
2. Press  +  simultaneously.
 - ↳ The message about the remedial measures closes.

11.7.2 Filtering the event logbook

Filters can be used to determine which category of event messages is displayed in the **Event list** submenu.

Navigation: Diagnostics → Event logbook

Filter categories

- All
- Failure (F)
- Function check (C)
- Out of specification (S)
- Maintenance required (M)
- Information

11.7.3 Overview of information events

Info number	Info name
I1000	----- (Device ok)
I1079	Sensor changed
I1089	Power on
I1090	Configuration reset
I1091	Configuration changed
I11036	Date/time set successfully
I11074	Device verification active
I1110	Write protection switch changed
I1151	History reset
I1154	Reset terminal voltage min/max
I1155	Reset electronics temperature
I1157	Memory error event list
I1256	Display: access status changed
I1264	Safety sequence aborted
I1335	Firmware changed
I1397	Fieldbus: access status changed
I1398	CDI: access status changed
I1440	Main electronic module changed
I1444	Device verification passed
I1445	Device verification failed
I1461	Sensor verification failed
I1512	Download started
I1513	Download finished
I1514	Upload started
I1515	Upload finished
I1551	Assignment error fixed
I1552	Failed: Main electronic verification
I1554	Safety sequence started
I1555	Safety sequence confirmed
I1556	Safety mode off
I1663	Power off

Info number	Info name
I1666	Clock synchronized
I1712	New flash file received
I1956	Reset

11.8 Resetting the device

11.8.1 Reset password via operating tool

Enter a code to reset the current "Maintenance" password.
The code is delivered by your local support.

Navigation: System → User management → Reset password → Reset password

 For detailed information on the **Reset password** parameter: Description of device parameters.

11.8.2 Reset device via operating tool

Reset the device configuration - either entirely or in part - to a defined state

Navigation: System → Device management → Reset device

 For detailed information on the **Reset device** parameter: Description of device parameters.

11.8.3 Resetting the device via keys on the electronic insert

Resetting the password

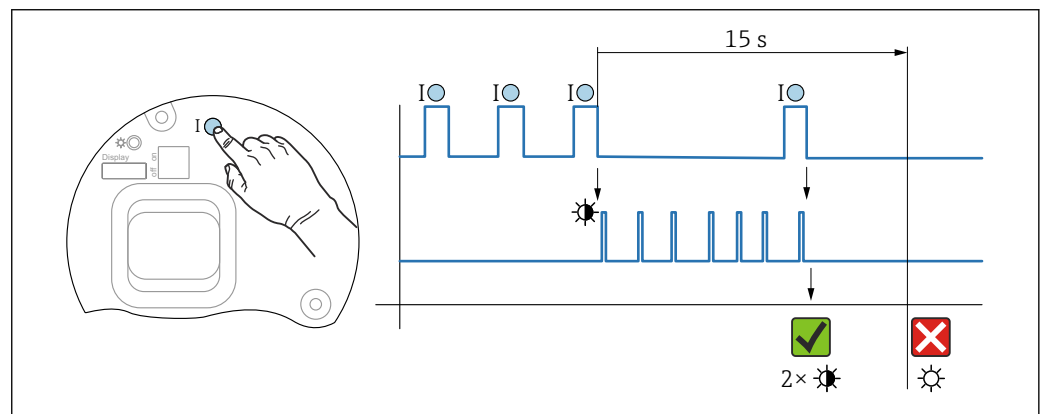

 25 Sequence for resetting the password

Delete/reset the password

1. Press operating key **I** three times.
 - ↳ The reset password function is started, the LED flashes.
2. Press operating key **I** once within 15 s.
 - ↳ The password is reset, the LED flashes briefly.

If operating key **I** is not pressed within 15 s, the action is canceled and the LED is no longer lit.

Resetting the device to the factory setting

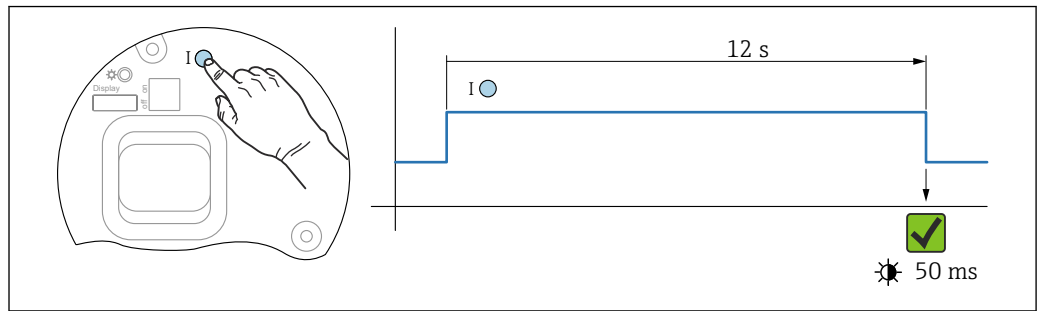

26 Sequence - Factory setting

A0050015

Reset the device to the factory setting

- ▶ Press operating key **I** for at least 12 s.
 - ↳ Device data are reset to the factory setting, the LED flashes briefly.

11.9 Device information

All device information is contained in the **Information** submenu.

Navigation: System → Information

For detailed information on the **Information** submenu: Description of device parameters.

11.10 Firmware history

The firmware version can explicitly be ordered via the product structure. This makes it possible to ensure the compatibility of the firmware version with an existing or planned system integration.

Version

01.00.00

- Initial software
- Valid from: 01.05.2023

12 Maintenance

No special maintenance work is required.

12.1 Cleaning

12.1.1 Cleaning of surfaces not in contact with the medium

- Recommendation: Use a lint-free cloth that is either dry or slightly dampened using water.
- Do not use any sharp objects or aggressive cleaning agents that corrode the surfaces (displays, housing, for example) and seals.
- Do not use high-pressure steam.
- Observe the degree of protection of the device.

 The cleaning agent used must be compatible with the materials of the device configuration. Do not use cleaning agents with concentrated mineral acids, bases or organic solvents.

12.1.2 Cleaning of surfaces in contact with the medium

Note the following for cleaning and sterilization in place (CIP/SIP):

- Use only cleaning agents to which the materials in contact with the medium are sufficiently resistant.
- Observe the permitted maximum medium temperature.

12.2 Seals

 The process seals, located on the process connection of the device, should be replaced periodically. The interval between changes depends on the frequency of the cleaning cycles, the cleaning temperature and the medium temperature.

13 Repair

13.1 General information

13.1.1 Repair concept

Endress+Hauser repair concept

- The devices have a modular design
- Repairs can be carried out by Endress+Hauser Service or by appropriately trained customers
- Spare parts are grouped into logical kits with the associated replacement instructions

 For more information on service and spare parts, please contact your Endress+Hauser sales representative.

13.1.2 Repairs to Ex-approved devices

WARNING

Incorrect repair can compromise electrical safety!

Explosion hazard!

- ▶ Only specialist personnel or the manufacturer's service team may carry out repairs on Ex-certified devices in accordance with national regulations.
- ▶ Relevant standards and national regulations on hazardous areas, safety instructions and certificates must be observed.
- ▶ Only use original spare parts from the manufacturer.
- ▶ Please note the device designation on the nameplate. Only identical parts may be used as replacements.
- ▶ Carry out repairs according to the instructions.
- ▶ Only the manufacturer's service team is permitted to modify a certified device and convert it to another certified version.

13.2 Spare parts



For spare parts currently available for the product, see online at:
<https://www.endress.com/deviceviewer> (→ Enter serial number)

13.3 Replacement

CAUTION

Data upload/download is not permitted if the device is used for safety-related applications.

- ▶ After an entire device or an electronics module has been replaced, the parameters can be downloaded to the device again via the communication interface. For this, the data must have been uploaded to the PC beforehand using the "FieldCare/DeviceCare" software.

13.3.1 HistoROM

It is not necessary to perform a new device calibration after replacing the display or transmitter electronics.



The spare part is supplied without HistoROM.

After removing the transmitter electronics, remove HistoRom and insert it into the new spare part.

13.4 Return

The requirements for safe device return can vary depending on the device type and national legislation.

1. Refer to the web page for information:
<https://www.endress.com/support/return-material>
↳ Select the region.
2. If returning the device, pack the device in such a way that it is reliably protected against impact and external influences. The original packaging offers the best protection.

13.5 Disposal



If required by the Directive 2012/19/EU on waste electrical and electronic equipment (WEEE), the product is marked with the depicted symbol in order to minimize the disposal of WEEE as unsorted municipal waste. Do not dispose of products bearing this marking as unsorted municipal waste. Instead, return them to the manufacturer for disposal under the applicable conditions.

14 Accessories

14.1 Weather protection cover: 316L, XW112

The weather protection cover can be ordered together with the device via the "Accessory enclosed" product structure.

It is used to protect against direct sunlight, precipitation and ice.

Weather protection cover 316L is suitable for the dual compartment housing made of aluminum or 316L. The delivery includes the holder for direct mounting on the housing.

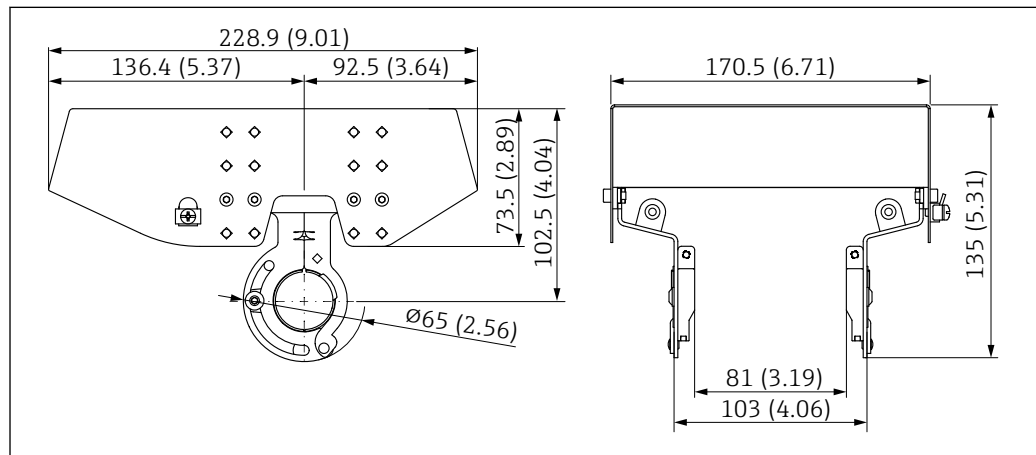

27 Dimensions of weather protection cover, 316 L, XW112. Unit of measurement mm (in)

Material

- Weather protection cover: 316L
- Clamping screw: A4
- Holder: 316L

Accessory order code:

71438303

 Special documentation SD02424F

14.2 Weather protection cover, plastic, XW111

The weather protection cover can be ordered together with the device via the "Accessory enclosed" product structure.

It is used to protect against direct sunlight, precipitation and ice.

The plastic weather protection cover is suitable for the single compartment housing made of aluminum. The delivery includes the holder for direct mounting on the housing.

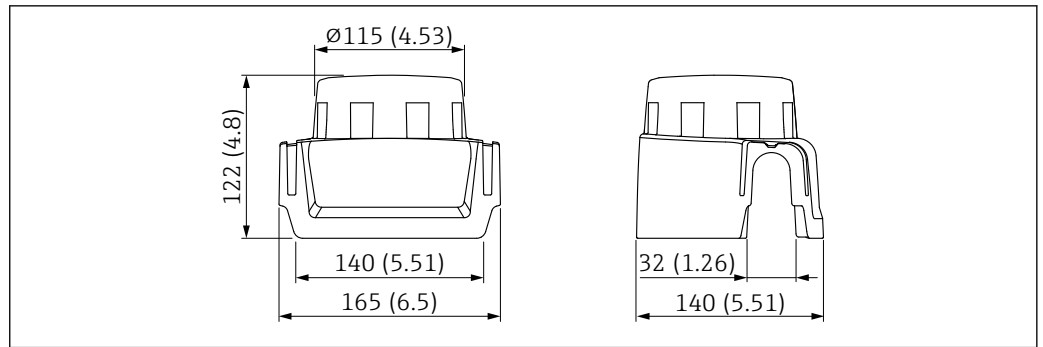

28 Dimensions of weather protection cover, plastic, XW111. Unit of measurement mm (in)

Material

Plastic

Accessory order code:

71438291

 Special documentation SD02423F

14.3 Adjustable flange seal

The adjustable flange seal is used to align the sensor to the surface of the product. It can be ordered directly with the device via the product structure "Accessory enclosed" or individually via the specific order number.

14.3.1 Seal, adjustable, DN80

The seal, adjustable, DN80 is compatible with flanges EN DN80 PN10/PN40

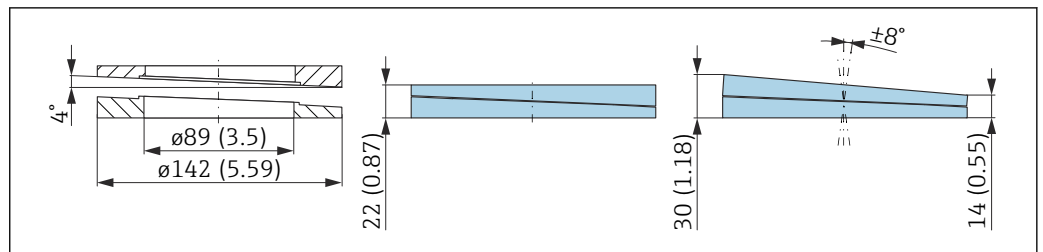

Technical data

- Material: EPDM
- Recommended screw size: M14
- Recommended screw length: 100 mm (3.9 in)
- Process pressure: -0.1 to 0.1 bar (-1.45 to 1.45 psi)
- Process temperature: -40 to +80 °C (-40 to +176 °F)

Ordering information

- The flange seal can be ordered together with the device via the "Accessory enclosed" product structure.
- Order number: 71074263

14.3.2 Seal, adjustable, DN100

The seal, adjustable, DN100 is compatible with flanges EN DN100 PN10/PN16

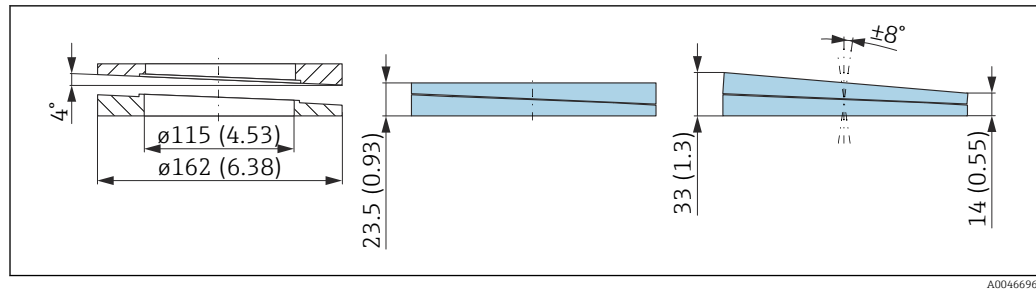

A0046696

Technical data

- Material: EPDM
- Recommended screw size: M14
- Recommended screw length: 100 mm (3.9 in)
- Process pressure: -0.1 to 0.1 bar (-1.45 to 1.45 psi)
- Process temperature: -40 to +80 °C (-40 to +176 °F)

Ordering information

- The flange seal can be ordered together with the device via the "Accessory enclosed" product structure.
- Order number: 71074264

14.3.3 Seal, adjustable, DN150

The seal, adjustable, DN150 is compatible with flanges EN DN150 PN10/PN19

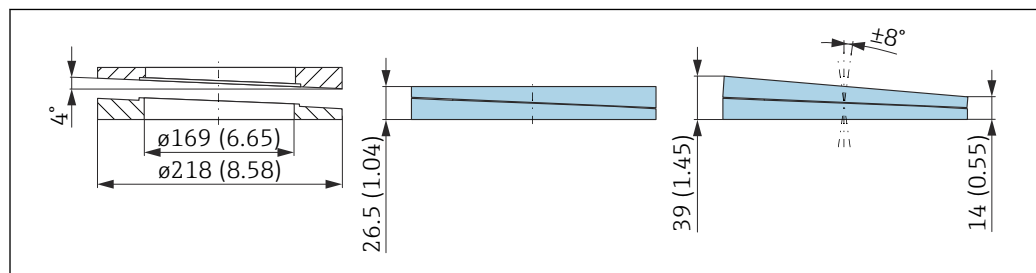

A0046697

Technical data

- Material: EPDM
- Recommended screw size: M18
- Recommended screw length: 110 mm (4.3 in)
- Process pressure: -0.1 to 0.1 bar (-1.45 to 1.45 psi)
- Process temperature: -40 to +80 °C (-40 to +176 °F)

Ordering information

- The flange seal can be ordered together with the device via the "Accessory enclosed" product structure.
- Order number: 71074265

14.3.4 Seal, adjustable, ASME 3"/ JIS 80A

The seal, adjustable, ASME 3"/ JIS 80A is compatible with flanges ASME 3" 150 lbs and JIS 80A 10K

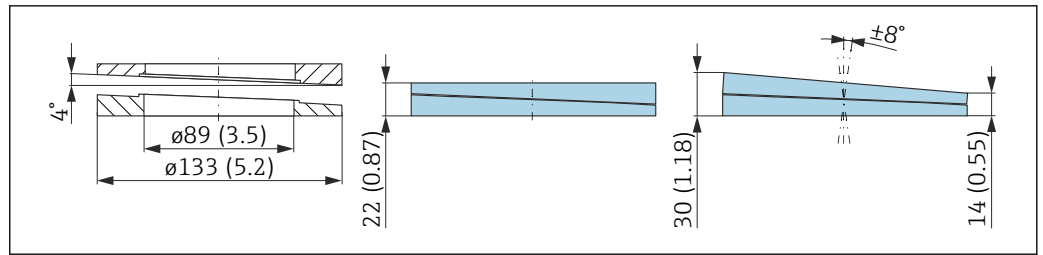

A0046698

Technical data

- Material: EPDM
- Recommended screw size: M14
- Recommended screw length: 100 mm (3.9 in)
- Process pressure: -0.1 to 0.1 bar (-1.45 to 1.45 psi)
- Process temperature: -40 to +80 °C (-40 to +176 °F)

Ordering information

- The flange seal can be ordered together with the device via the "Accessory enclosed" product structure.
- Order number: 71249070

14.3.5 Seal, adjustable, ASME 4"

The seal, adjustable, ASME 4" is compatible with flanges ASME 4" 150 lbs

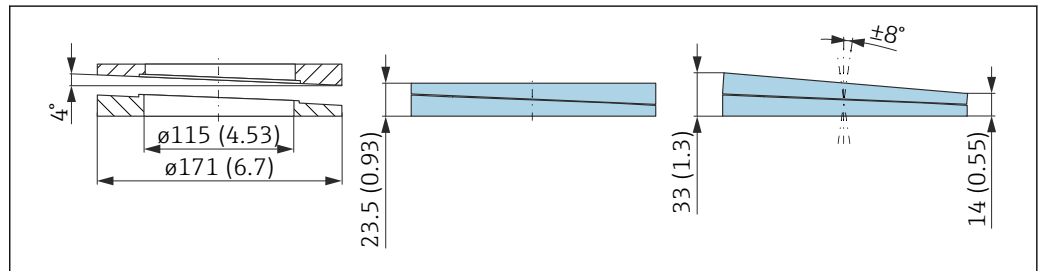

A0046699

Technical data

- Material: EPDM
- Recommended screw size: M14
- Recommended screw length: 100 mm (3.9 in)
- Process pressure: -0.1 to 0.1 bar (-1.45 to 1.45 psi)
- Process temperature: -40 to +80 °C (-40 to +176 °F)

Ordering information

- The flange seal can be ordered together with the device via the "Accessory enclosed" product structure.
- Order number: 71249072

14.3.6 Seal, adjustable, ASME 6"/ JIS 150A

The seal, adjustable, ASME 6"/ JIS 150A is compatible with flanges ASME 6" 150 lbs and JIS 150A 10K

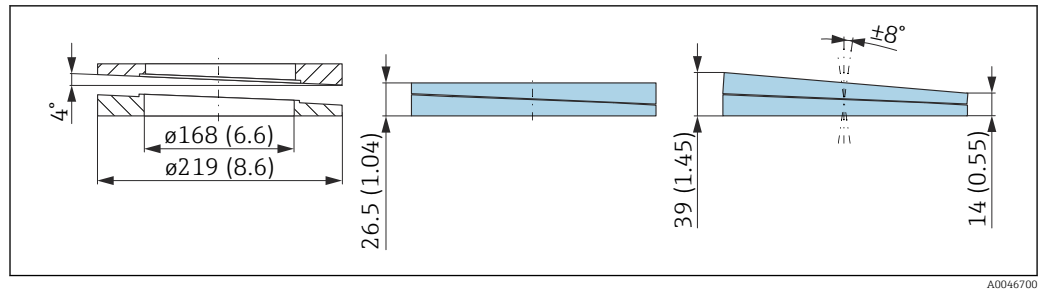

A0046700

Technical data

- Material: EPDM
- Recommended screw size: M18
- Recommended screw length: 100 mm (3.9 in)
- Process pressure: -0.1 to 0.1 bar (-1.45 to 1.45 psi)
- Process temperature: -40 to +80 °C (-40 to +176 °F)

Ordering information

- The flange seal can be ordered together with the device via the "Accessory enclosed" product structure.
- Order number: 71249073

14.4 M12 plug-in jack

14.4.1 M12 socket, cable side

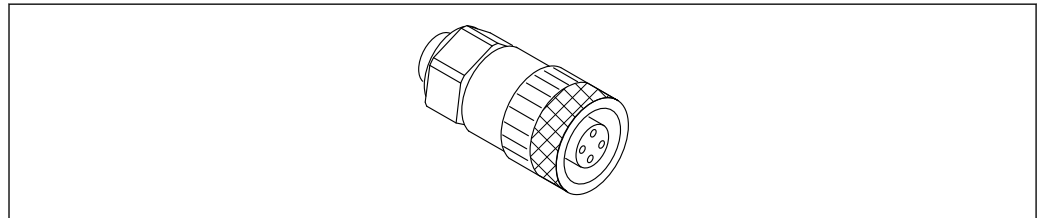

A0051231

29 M12 socket, cable side

- Material:
 - Body: PBT
 - Union nut: nickel-plated die-cast zinc
 - Seal: NBR
- Degree of protection (fully locked): IP67
- Pg coupling: Pg7
- Order code: 52006263



Special documentation SD02586F

14.4.2 M12 socket, 90deg, cable side

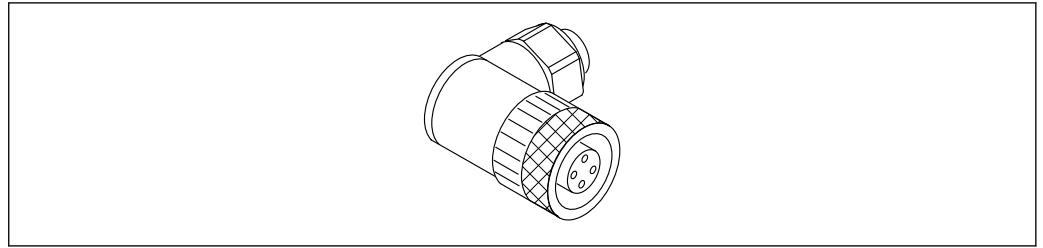

A0051232

 30 M12 socket, angled

- Material:
 - Body: PBT
 - Union nut: nickel-plated die-cast zinc
 - Seal: NBR
- Degree of protection (fully locked): IP67
- Pg coupling: Pg7
- Order code: 71114212

 Special documentation SD02586F

14.4.3 M12 socket, 100deg, 5 m (16 ft) cable

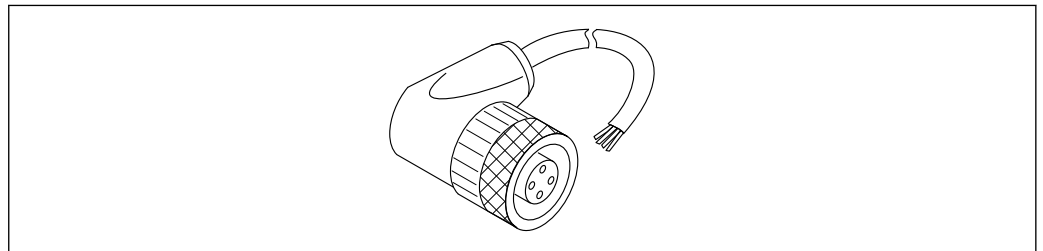

A0051233

 31 M12 socket, 100deg, 5 m (16 ft) cable

- M12 socket material:
 - Body: TPU
 - Union nut: nickel-plated die-cast zinc
- Cable material:
 - PVC
- Cable Li Y YM 4×0.34 mm² (20 AWG)
- Cable colors
 - 1 = BN = brown
 - 2 = WH = white
 - 3 = BU = blue
 - 4 = BK = black
- Order code: 52010285

 Special documentation SD02586F

14.5 Remote display FHX50B

The remote display is ordered via the Product Configurator.

If the remote display is to be used, the device version **Prepared for display FHX50B** must be ordered.

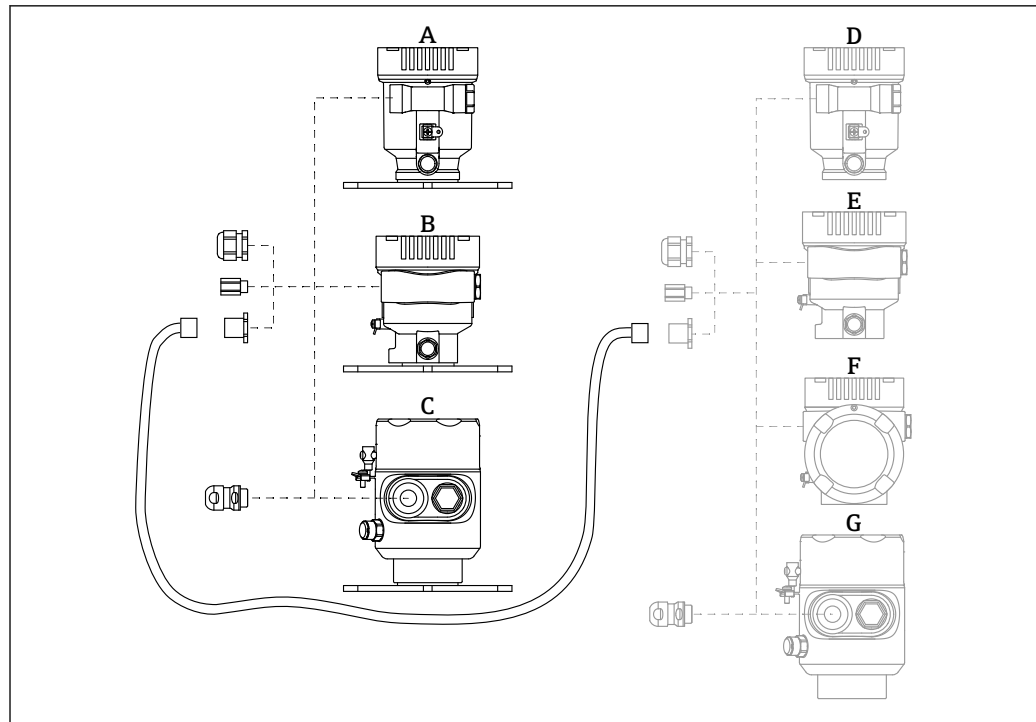

A0046692

- A Single compartment housing, plastic, remote display
 B Single compartment housing, aluminum, remote display
 C Single-compartment housing, 316L hygiene, remote display
 D Device side, single compartment housing, plastic, prepared for FHX50B display
 E Device side, single compartment housing, aluminum, prepared for FHX50B display
 F Device side, dual compartment housing, L-shaped, prepared for FHX50B display
 G Device side, single compartment housing, 316 L hygiene, prepared for FHX50B display

Single compartment housing material, remote display

- Aluminum
- Plastic

Degree of protection:

- IP68 / NEMA 6P
- IP66 / NEMA 4x

Connecting cable:

- Connecting cable (option) up to 30 m (98 ft)
- Standard cable supplied by customer up to 60 m (197 ft)
 Recommendation: EtherLine®-P CAT.5e from LAPP.

Specification of customer-supplied connecting cable

Push-in CAGE CLAMP® connection technology, push actuation

- Conductor cross-section:
 - Solid conductor 0.2 to 0.75 mm² (24 to 18 AWG)
 - Fine-stranded conductor 0.2 to 0.75 mm² (24 to 18 AWG)
 - Fine-stranded conductor; with insulated ferrule 0.25 to 0.34 mm²
 - Fine-stranded conductor; without insulated ferrule 0.25 to 0.34 mm²
- Stripping length 7 to 9 mm (0.28 to 0.35 in)
- Outer diameter: 6 to 10 mm (0.24 to 0.4 in)
- Maximum cable length: 60 m (197 ft)

Ambient temperature:

- -40 to +80 °C (-40 to +176 °F)
- Option: -50 to +80 °C (-58 to +176 °F)



Special documentation SD02991F

14.6 Gas-tight feedthrough

Chemically inert glass feedthrough, which prevents gases from entering the electronics housing.

Can optionally be ordered as "Accessory mounted" via the product structure.

14.7 Field Xpert SMT70

Universal, high-performance tablet PC for device configuration in Ex Zone 2 and non-Ex areas



Technical Information TI01342S

14.8 DeviceCare SFE100

Configuration tool for HART, PROFIBUS and FOUNDATION Fieldbus field devices



Technical Information TI01134S

14.9 FieldCare SFE500

FDT-based plant asset management tool

It can configure all smart field units in your system and helps you manage them. By using the status information, it is also a simple but effective way of checking their status and condition.



Technical Information TI00028S

15 Technical data

15.1 Input

Measured variable The measured variable is the distance between the reference point and the product surface. The level is calculated based on "E", the empty distance entered.

Measuring range The start of the measuring range is the point where the beam hits the floor. Levels below this point cannot be measured, particularly in the case of conical outlets. An alignment unit can be used to increase the maximum measuring range in such applications.

Maximum measuring range

The maximum measuring range depends on the antenna size and design.

Antenna	Maximum measuring range
Horn, 316L, 65 mm (2.6 in)	125 m (410 ft)
Drip-off, PTFE, 50 mm (2 in)	50 m (164 ft)
Flush mount, PTFE, 80 mm (3 in)	125 m (410 ft)

Usable measuring range

The usable measuring range depends on the antenna size, the medium's reflective properties, the installation position and any possible interference reflections.

In principle, measurement is possible up to the tip of the antenna.

Depending on the position of the product (angle of repose) and to avoid any material damage from abrasive media and deposit buildup on the antenna, the end of the measuring range should be selected 10 mm (0.4 in) before the tip of the antenna.

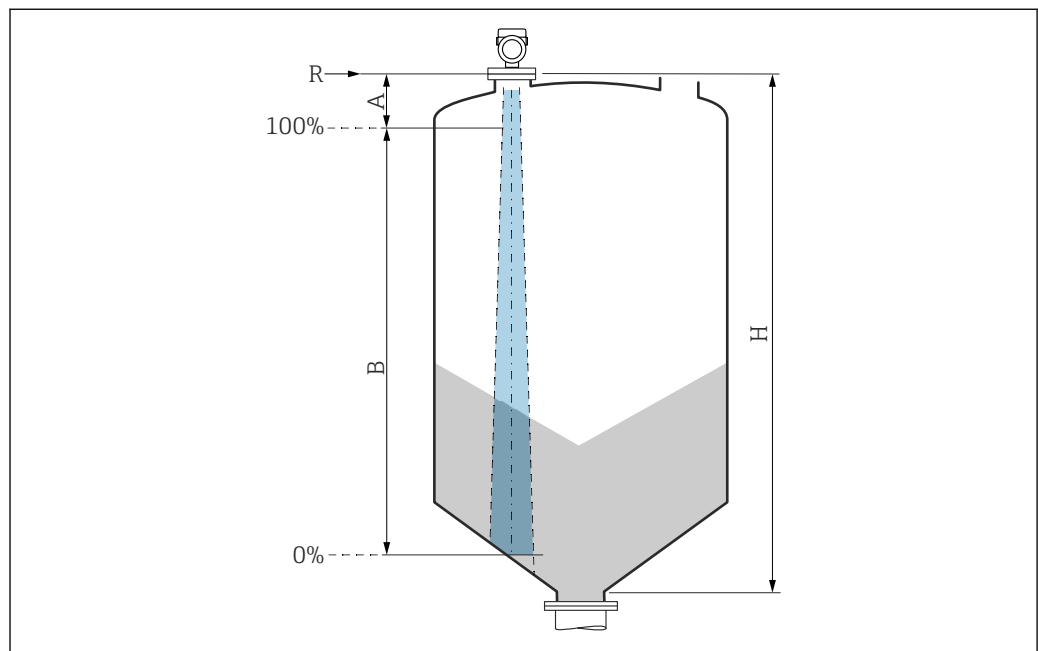

A0051659

- A Length of antenna + 10 mm (0.4 in)
- B Usable measuring range
- H Silo height
- R Reference point of measurement, varies depending on the antenna system

 For further information on the reference point, see →  Mechanical construction.

 For the relative permittivity values (ϵ_r values) of many media commonly used in industry, please refer to:

- Relative permittivity (ϵ_r value), Compendium CP01076F
- The Endress+Hauser "DC Values app" (available for Android and iOS)

Operating frequency Approx. 80 GHz
Up to 8 devices can be installed in a tank without the devices mutually influencing one another.

Transmission power

- Peak power: <1.5 mW
- Average output power: <70 μ W

15.2 Output

PROFINET-APL **PROFINET with Ethernet-APL**
10BASE-T1L, 2-wire 10 Mbit/s

Signal on alarm **Local display**
Status signal (in accordance with NAMUR Recommendation NE 107):
Plain text display

Operating tool via service interface (CDI)
Status signal (in accordance with NAMUR Recommendation NE 107):
Plain text display

Operating tool via PROFINET with Ethernet-APL

- According to "Application layer protocol for decentralized periphery", Version 2.4
- Diagnostics according to PROFINET PA Profile 4.02

Linearization The linearization function of the device allows the conversion of the measured value into any unit of length, weight, flow or volume.

Pre-programmed linearization curves
Linearization tables for calculating the volume in the following vessels are preprogrammed into the device:

- Pyramid bottom
- Conical bottom
- Angled bottom
- Horizontal cylinder
- Sphere

Other linearization tables of up to 32 value pairs can be entered manually.

PROFINET with Ethernet-APL	Protocol	Application layer protocol for decentral device periphery and distributed automation, Version 2.4
	Communication type	Ethernet Advanced Physical Layer 10BASE-T1L
	Conformance Class	Conformance Class B
	Netload Class	Netload Class II
	Baud rates	Automatic 10 Mbit/s with full-duplex detection
	Cycle times	From 32 ms
	Polarity	Auto-polarity for automatic correction of crossed TxD and RxD pairs

Media Redundancy Protocol (MRP)	Yes
System redundancy support	System redundancy S2 (2 AR with 1 NAP)
Device profile	Application interface identifier 0xB321 Generic device
Manufacturer ID	0x11
Device type ID	0xA1C1
Device description files (GSD, FDI, DTM, DD)	Information and files available at: <ul style="list-style-type: none"> ▪ www.endress.com On the product page for the device: Documents/Software → Device drivers ▪ www.profibus.org
Supported connections	<ul style="list-style-type: none"> ▪ 2 x AR (IO Controller AR) ▪ 1 x AR (IO-Supervisor Device AR connection allowed) ▪ 1 x Input CR (Communication Relation) ▪ 1 x Output CR (Communication Relation) ▪ 1 x Alarm CR (Communication Relation)
Configuration options for device	<ul style="list-style-type: none"> ▪ Manufacturer-specific software (FieldCare, DeviceCare) ▪ Web browser ▪ Device master file (GSD), can be read out via the integrated Web server of the device ▪ DIP switch for setting the service IP address
Configuration of the device name	<ul style="list-style-type: none"> ▪ DCP protocol ▪ Process Device Manager (PDM) ▪ Integrated Web server
Supported functions	<ul style="list-style-type: none"> ▪ Identification & maintenance Simple device identification via: <ul style="list-style-type: none"> ▪ Control system ▪ Nameplate ▪ Measured value status The process variables are communicated with a measured value status ▪ Blinking feature via the local display for simple device identification and assignment ▪ Device operation via operating tools (e.g., FieldCare, DeviceCare, SIMATIC PDM)
System integration	For information on system integration, see  Operating Instructions <ul style="list-style-type: none"> ▪ Cyclic data transmission ▪ Overview and description of the modules ▪ Status coding ▪ Startup configuration ▪ Factory setting

15.3 Environment

Ambient temperature range

The following values apply up to a process temperature of +85 °C (+185 °F). At higher process temperatures, the permitted ambient temperature is reduced.

- Without LCD display:
Standard: -40 to +85 °C (-40 to +185 °F)
- With LCD display: -40 to +85 °C (-40 to +185 °F) with limitations in optical properties such as display speed and contrast for example. Can be used without limitations up to -20 to +60 °C (-4 to +140 °F)

-  If operating outdoors in strong sunlight:
- Mount the device in the shade.
 - Avoid direct sunlight, particularly in warm climatic regions.
 - Use a weather protection cover (see accessories).

Ambient temperature limits The permitted ambient temperature (T_a) depends on the selected housing material (Product Configurator → Housing; Material →) and the selected process temperature range (Product Configurator → Application →).

In the event of temperature (T_p) at the process connection, the permitted ambient temperature (T_a) is reduced.

i The following information only takes functional aspects into consideration. Additional restrictions may apply for certified device versions.

Plastic housing

Plastic housing; process temperature -40 to +80 °C (-40 to +176 °F)

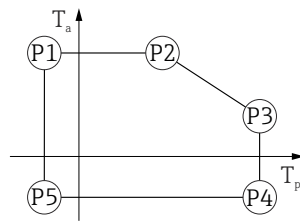

A0032024

32 Plastic housing; process temperature -40 to +80 °C (-40 to +176 °F)

- P1 = T_p : -40 °C (-40 °F) | T_a : +76 °C (+169 °F)
- P2 = T_p : +76 °C (+169 °F) | T_a : +76 °C (+169 °F)
- P3 = T_p : +80 °C (+176 °F) | T_a : +75 °C (+167 °F)
- P4 = T_p : +80 °C (+176 °F) | T_a : -40 °C (-40 °F)
- P5 = T_p : -40 °C (-40 °F) | T_a : -40 °C (-40 °F)

i In the case of devices with a plastic housing and CSA C/US approval, the selected process temperature of

-40 to +80 °C (-40 to +176 °F) is limited to 0 to +80 °C (+32 to +176 °F).

Restriction to a process temperature of 0 to +80 °C (+32 to +176 °F) with CSA C/US approval and plastic housing

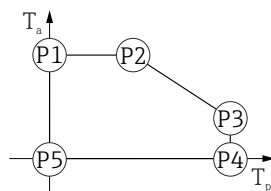

A0048826

33 Plastic housing; process temperature 0 to +80 °C (+32 to +176 °F) with CSA C/US approval

- P1 = T_p : 0 °C (+32 °F) | T_a : +76 °C (+169 °F)
- P2 = T_p : +76 °C (+169 °F) | T_a : +76 °C (+169 °F)
- P3 = T_p : +80 °C (+176 °F) | T_a : +75 °C (+167 °F)
- P4 = T_p : +80 °C (+176 °F) | T_a : 0 °C (+32 °F)
- P5 = T_p : 0 °C (+32 °F) | T_a : 0 °C (+32 °F)

Plastic housing; process temperature -40 to $+150$ °C (-40 to $+302$ °F)

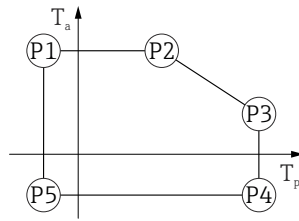

A0032024

34 Plastic housing; process temperature -40 to $+150$ °C (-40 to $+302$ °F)

- P1 = T_p : -40 °C (-40 °F) | T_a : $+76$ °C ($+169$ °F)
- P2 = T_p : $+76$ °C ($+169$ °F) | T_a : $+76$ °C ($+169$ °F)
- P3 = T_p : $+150$ °C ($+302$ °F) | T_a : $+25$ °C ($+77$ °F)
- P4 = T_p : $+150$ °C ($+302$ °F) | T_a : -40 °C (-40 °F)
- P5 = T_p : -40 °C (-40 °F) | T_a : -40 °C (-40 °F)

i In the case of devices with a plastic housing and CSA C/US approval, the selected process temperature of -40 to $+150$ °C (-40 to $+302$ °F) is limited to 0 to $+150$ °C ($+32$ to $+302$ °F).

Restriction to a process temperature of 0 to $+150$ °C ($+32$ to $+302$ °F) with CSA C/US approval and plastic housing

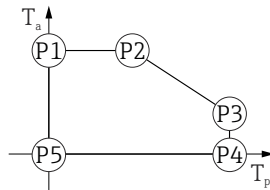

A0048826

35 Plastic housing; process temperature 0 to $+150$ °C ($+32$ to $+302$ °F) with CSA C/US approval

- P1 = T_p : 0 °C ($+32$ °F) | T_a : $+76$ °C ($+169$ °F)
- P2 = T_p : $+76$ °C ($+169$ °F) | T_a : $+76$ °C ($+169$ °F)
- P3 = T_p : $+150$ °C ($+302$ °F) | T_a : $+25$ °C ($+77$ °F)
- P4 = T_p : $+150$ °C ($+302$ °F) | T_a : 0 °C ($+32$ °F)
- P5 = T_p : 0 °C ($+32$ °F) | T_a : 0 °C ($+32$ °F)

Plastic housing; process temperature -40 to $+200$ °C (-40 to $+392$ °F)

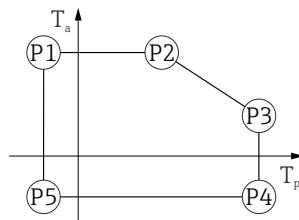

A0032024

36 Plastic housing; process temperature -40 to $+200$ °C (-40 to $+392$ °F)

- P1 = T_p : -40 °C (-40 °F) | T_a : $+76$ °C ($+169$ °F)
- P2 = T_p : $+76$ °C ($+169$ °F) | T_a : $+76$ °C ($+169$ °F)
- P3 = T_p : $+200$ °C ($+392$ °F) | T_a : $+27$ °C ($+81$ °F)
- P4 = T_p : $+200$ °C ($+392$ °F) | T_a : -40 °C (-40 °F)
- P5 = T_p : -40 °C (-40 °F) | T_a : -40 °C (-40 °F)

i In the case of devices with a plastic housing and CSA C/US approval, the selected process temperature of -40 to $+200$ °C (-40 to $+392$ °F) is limited to 0 to $+200$ °C ($+32$ to $+392$ °F).

Restriction to a process temperature of 0 to +200 °C (+32 to +392 °F) with CSA C/US approval and plastic housing

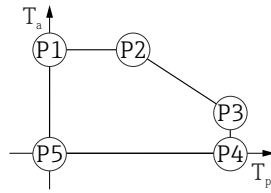

A0048826

37 Plastic housing; process temperature 0 to +200 °C (+32 to +392 °F) with CSA C/US approval

- P1 = $T_p: 0\text{ °C (+32 °F)}$ | $T_a: +76\text{ °C (+169 °F)}$
- P2 = $T_p: +76\text{ °C (+169 °F)}$ | $T_a: +76\text{ °C (+169 °F)}$
- P3 = $T_p: +200\text{ °C (+392 °F)}$ | $T_a: +27\text{ °C (+81 °F)}$
- P4 = $T_p: +200\text{ °C (+392 °F)}$ | $T_a: 0\text{ °C (+32 °F)}$
- P5 = $T_p: 0\text{ °C (+32 °F)}$ | $T_a: 0\text{ °C (+32 °F)}$

Plastic housing; process temperature -40 to +280 °C (-40 to +536 °F)

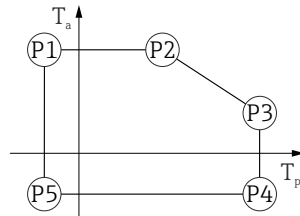

A0032024

38 Plastic housing; process temperature -40 to +280 °C (-40 to +536 °F)

- P1 = $T_p: -40\text{ °C (-40 °F)}$ | $T_a: +76\text{ °C (+169 °F)}$
- P2 = $T_p: +76\text{ °C (+169 °F)}$ | $T_a: +76\text{ °C (+169 °F)}$
- P3 = $T_p: +280\text{ °C (+536 °F)}$ | $T_a: +48\text{ °C (+118 °F)}$
- P4 = $T_p: +280\text{ °C (+536 °F)}$ | $T_a: -40\text{ °C (-40 °F)}$
- P5 = $T_p: -40\text{ °C (-40 °F)}$ | $T_a: -40\text{ °C (-40 °F)}$

i In the case of devices with a plastic housing and CSA C/US approval, the selected process temperature of -40 to +280 °C (-40 to +536 °F) is limited to 0 to +280 °C (+32 to +536 °F).

Restriction to a process temperature of 0 to +280 °C (+32 to +536 °F) with CSA C/US approval and plastic housing

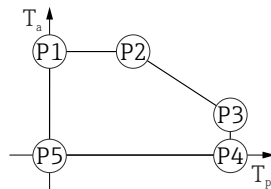

A0048826

39 Plastic housing; process temperature 0 to +280 °C (+32 to +536 °F) with CSA C/US approval

- P1 = $T_p: 0\text{ °C (+32 °F)}$ | $T_a: +76\text{ °C (+169 °F)}$
- P2 = $T_p: +76\text{ °C (+169 °F)}$ | $T_a: +76\text{ °C (+169 °F)}$
- P3 = $T_p: +280\text{ °C (+536 °F)}$ | $T_a: +48\text{ °C (+118 °F)}$
- P4 = $T_p: +280\text{ °C (+536 °F)}$ | $T_a: 0\text{ °C (+32 °F)}$
- P5 = $T_p: 0\text{ °C (+32 °F)}$ | $T_a: 0\text{ °C (+32 °F)}$

Plastic housing; process temperature -40 to $+450$ °C (-40 to $+842$ °F)

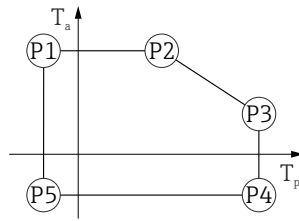

A0032024

40 Plastic housing; process temperature -40 to $+450$ °C (-40 to $+842$ °F)

- P1 = T_p : -40 °C (-40 °F) | T_a : $+76$ °C ($+169$ °F)
- P2 = T_p : $+76$ °C ($+169$ °F) | T_a : $+76$ °C ($+169$ °F)
- P3 = T_p : $+450$ °C ($+842$ °F) | T_a : $+20$ °C ($+68$ °F)
- P4 = T_p : $+450$ °C ($+842$ °F) | T_a : -40 °C (-40 °F)
- P5 = T_p : -40 °C (-40 °F) | T_a : -40 °C (-40 °F)

i In the case of devices with a plastic housing and CSA C/US approval, the selected process temperature of -40 to $+450$ °C (-40 to $+842$ °F) is limited to 0 to $+450$ °C ($+32$ to $+842$ °F).

Restriction to a process temperature of 0 to $+450$ °C ($+32$ to $+842$ °F) with CSA C/US approval and plastic housing

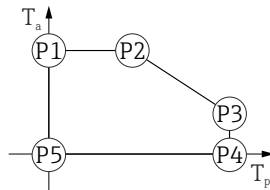

A0048826

41 Plastic housing; process temperature 0 to $+450$ °C ($+32$ to $+842$ °F) with CSA C/US approval

- P1 = T_p : 0 °C ($+32$ °F) | T_a : $+76$ °C ($+169$ °F)
- P2 = T_p : $+76$ °C ($+169$ °F) | T_a : $+76$ °C ($+169$ °F)
- P3 = T_p : $+450$ °C ($+842$ °F) | T_a : $+20$ °C ($+68$ °F)
- P4 = T_p : $+450$ °C ($+842$ °F) | T_a : 0 °C ($+32$ °F)
- P5 = T_p : 0 °C ($+32$ °F) | T_a : 0 °C ($+32$ °F)

Aluminum housing, coated

Aluminum housing; process temperature -40 to $+80$ °C (-40 to $+176$ °F)

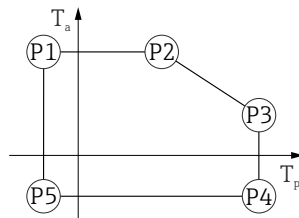

A0032024

42 Aluminum housing, coated; process temperature -40 to $+80$ °C (-40 to $+176$ °F)

- P1 = T_p : -40 °C (-40 °F) | T_a : $+79$ °C ($+174$ °F)
- P2 = T_p : $+79$ °C ($+174$ °F) | T_a : $+79$ °C ($+174$ °F)
- P3 = T_p : $+80$ °C ($+176$ °F) | T_a : $+79$ °C ($+174$ °F)
- P4 = T_p : $+80$ °C ($+176$ °F) | T_a : -40 °C (-40 °F)
- P5 = T_p : -40 °C (-40 °F) | T_a : -40 °C (-40 °F)

Aluminum housing; process temperature -40 to $+150$ °C (-40 to $+302$ °F)

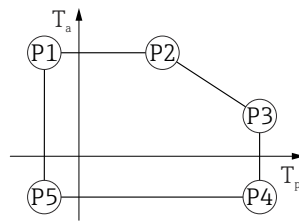

▣ 43 Aluminum housing, coated; process temperature -40 to $+150$ °C (-40 to $+302$ °F)

P1	=	T_p :	-40 °C (-40 °F)		T_a :	$+79$ °C ($+174$ °F)
P2	=	T_p :	$+79$ °C ($+174$ °F)		T_a :	$+79$ °C ($+174$ °F)
P3	=	T_p :	$+150$ °C ($+302$ °F)		T_a :	$+53$ °C ($+127$ °F)
P4	=	T_p :	$+150$ °C ($+302$ °F)		T_a :	-40 °C (-40 °F)
P5	=	T_p :	-40 °C (-40 °F)		T_a :	-40 °C (-40 °F)

A0032024

Aluminum housing; process temperature -40 to $+200$ °C (-40 to $+392$ °F)

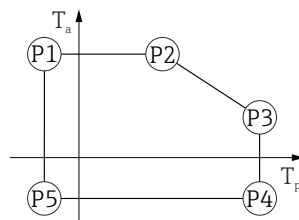

▣ 44 Aluminum housing, coated; process temperature -40 to $+200$ °C (-40 to $+392$ °F)

P1	=	T_p :	-40 °C (-40 °F)		T_a :	$+79$ °C ($+174$ °F)
P2	=	T_p :	$+79$ °C ($+174$ °F)		T_a :	$+79$ °C ($+174$ °F)
P3	=	T_p :	$+200$ °C ($+392$ °F)		T_a :	$+47$ °C ($+117$ °F)
P4	=	T_p :	$+200$ °C ($+392$ °F)		T_a :	-40 °C (-40 °F)
P5	=	T_p :	-40 °C (-40 °F)		T_a :	-40 °C (-40 °F)

A0032024

Aluminum housing; process temperature -40 to $+280$ °C (-40 to $+536$ °F)

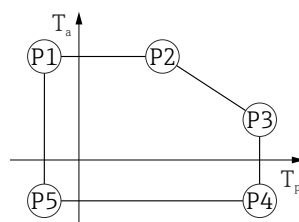

▣ 45 Aluminum housing, coated; process temperature -40 to $+280$ °C (-40 to $+536$ °F)

P1	=	T_p :	-40 °C (-40 °F)		T_a :	$+79$ °C ($+174$ °F)
P2	=	T_p :	$+79$ °C ($+174$ °F)		T_a :	$+79$ °C ($+174$ °F)
P3	=	T_p :	$+280$ °C ($+536$ °F)		T_a :	$+59$ °C ($+138$ °F)
P4	=	T_p :	$+280$ °C ($+536$ °F)		T_a :	-40 °C (-40 °F)
P5	=	T_p :	-40 °C (-40 °F)		T_a :	-40 °C (-40 °F)

A0032024

Aluminum housing; process temperature -40 to $+450$ °C (-40 to $+842$ °F)

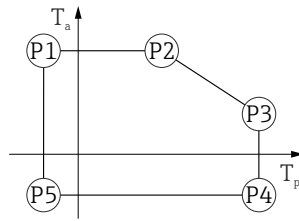

A0032024

▣ 46 Aluminum housing, coated; process temperature -40 to $+450$ °C (-40 to $+842$ °F)

- P1 = T_p : -40 °C (-40 °F) | T_a : $+79$ °C ($+174$ °F)
- P2 = T_p : $+79$ °C ($+174$ °F) | T_a : $+79$ °C ($+174$ °F)
- P3 = T_p : $+450$ °C ($+842$ °F) | T_a : $+39$ °C ($+102$ °F)
- P4 = T_p : $+450$ °C ($+842$ °F) | T_a : -40 °C (-40 °F)
- P5 = T_p : -40 °C (-40 °F) | T_a : -40 °C (-40 °F)

316L housing

316L housing; process temperature -40 to $+80$ °C (-40 to $+176$ °F)

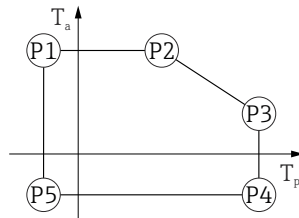

A0032024

▣ 47 316L housing; process temperature -40 to $+80$ °C (-40 to $+176$ °F)

- P1 = T_p : -40 °C (-40 °F) | T_a : $+77$ °C ($+171$ °F)
- P2 = T_p : $+77$ °C ($+171$ °F) | T_a : $+77$ °C ($+171$ °F)
- P3 = T_p : $+80$ °C ($+176$ °F) | T_a : $+77$ °C ($+171$ °F)
- P4 = T_p : $+80$ °C ($+176$ °F) | T_a : -40 °C (-40 °F)
- P5 = T_p : -40 °C (-40 °F) | T_a : -40 °C (-40 °F)

316L housing; process temperature -40 to $+150$ °C (-40 to $+302$ °F)

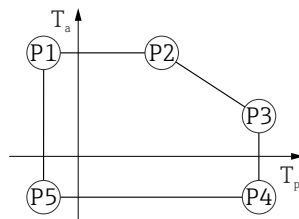

A0032024

▣ 48 316L housing; process temperature range: -40 to $+150$ °C (-40 to $+302$ °F)

- P1 = T_p : -40 °C (-40 °F) | T_a : $+77$ °C ($+171$ °F)
- P2 = T_p : $+77$ °C ($+171$ °F) | T_a : $+77$ °C ($+171$ °F)
- P3 = T_p : $+150$ °C ($+302$ °F) | T_a : $+43$ °C ($+109$ °F)
- P4 = T_p : $+150$ °C ($+302$ °F) | T_a : -40 °C (-40 °F)
- P5 = T_p : -40 °C (-40 °F) | T_a : -40 °C (-40 °F)

316L housing; process temperature -40 to $+200$ °C (-40 to $+392$ °F)

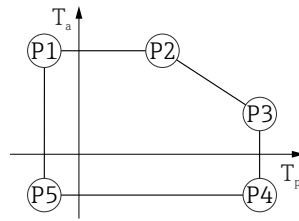

A0032024

49 316L housing; process temperature -40 to $+200$ °C (-40 to $+392$ °F)

- P1 = T_p : -40 °C (-40 °F) | T_a : $+77$ °C ($+171$ °F)
- P2 = T_p : $+77$ °C ($+171$ °F) | T_a : $+77$ °C ($+171$ °F)
- P3 = T_p : $+200$ °C ($+392$ °F) | T_a : $+38$ °C ($+100$ °F)
- P4 = T_p : $+200$ °C ($+392$ °F) | T_a : -40 °C (-40 °F)
- P5 = T_p : -40 °C (-40 °F) | T_a : -40 °C (-40 °F)

316L housing; process temperature -40 to $+280$ °C (-40 to $+536$ °F)

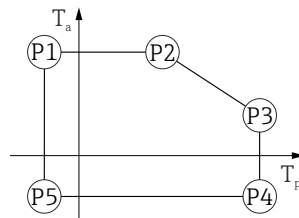

A0032024

50 316L housing; process temperature -40 to $+280$ °C (-40 to $+536$ °F)

- P1 = T_p : -40 °C (-40 °F) | T_a : $+77$ °C ($+171$ °F)
- P2 = T_p : $+77$ °C ($+171$ °F) | T_a : $+77$ °C ($+171$ °F)
- P3 = T_p : $+280$ °C ($+536$ °F) | T_a : $+54$ °C ($+129$ °F)
- P4 = T_p : $+280$ °C ($+536$ °F) | T_a : -40 °C (-40 °F)
- P5 = T_p : -40 °C (-40 °F) | T_a : -40 °C (-40 °F)

316L housing; process temperature -40 to $+450$ °C (-40 to $+842$ °F)

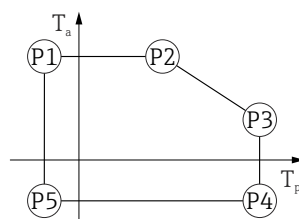

A0032024

51 316L housing; process temperature -40 to $+450$ °C (-40 to $+842$ °F)

- P1 = T_p : -40 °C (-40 °F) | T_a : $+77$ °C ($+171$ °F)
- P2 = T_p : $+77$ °C ($+171$ °F) | T_a : $+77$ °C ($+171$ °F)
- P3 = T_p : $+450$ °C ($+842$ °F) | T_a : $+31$ °C ($+88$ °F)
- P4 = T_p : $+450$ °C ($+842$ °F) | T_a : -40 °C (-40 °F)
- P5 = T_p : -40 °C (-40 °F) | T_a : -40 °C (-40 °F)

316L housing, hygiene

316L housing, hygiene; process temperature -40 to $+80$ °C (-40 to $+176$ °F)

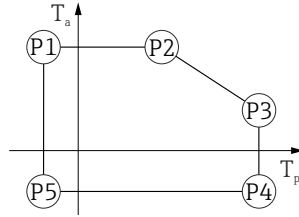

A0032024

▣ 52 316L housing, hygiene; process temperature -40 to $+80$ °C (-40 to $+176$ °F)

- P1 = T_p : -40 °C (-40 °F) | T_a : $+76$ °C ($+169$ °F)
- P2 = T_p : $+76$ °C ($+169$ °F) | T_a : $+76$ °C ($+169$ °F)
- P3 = T_p : $+80$ °C ($+176$ °F) | T_a : $+75$ °C ($+167$ °F)
- P4 = T_p : $+80$ °C ($+176$ °F) | T_a : -40 °C (-40 °F)
- P5 = T_p : -40 °C (-40 °F) | T_a : -40 °C (-40 °F)

316L housing, hygiene; process temperature -40 to $+150$ °C (-40 to $+302$ °F)

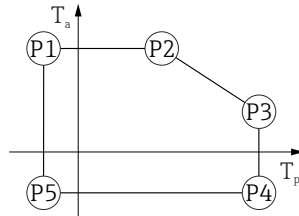

A0032024

▣ 53 316L housing, hygiene; process temperature range: -40 to $+150$ °C (-40 to $+302$ °F)

- P1 = T_p : -40 °C (-40 °F) | T_a : $+76$ °C ($+169$ °F)
- P2 = T_p : $+76$ °C ($+169$ °F) | T_a : $+76$ °C ($+169$ °F)
- P3 = T_p : $+150$ °C ($+302$ °F) | T_a : $+41$ °C ($+106$ °F)
- P4 = T_p : $+150$ °C ($+302$ °F) | T_a : -40 °C (-40 °F)
- P5 = T_p : -40 °C (-40 °F) | T_a : -40 °C (-40 °F)

316L housing, hygiene; process temperature -40 to $+200$ °C (-40 to $+392$ °F)

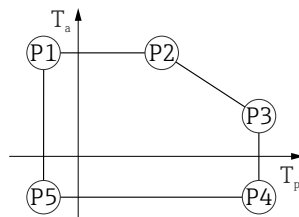

A0032024

▣ 54 316L housing, hygiene; process temperature -40 to $+200$ °C (-40 to $+392$ °F)

- P1 = T_p : -40 °C (-40 °F) | T_a : $+76$ °C ($+169$ °F)
- P2 = T_p : $+76$ °C ($+169$ °F) | T_a : $+76$ °C ($+169$ °F)
- P3 = T_p : $+200$ °C ($+392$ °F) | T_a : $+32$ °C ($+90$ °F)
- P4 = T_p : $+200$ °C ($+392$ °F) | T_a : -40 °C (-40 °F)
- P5 = T_p : -40 °C (-40 °F) | T_a : -40 °C (-40 °F)

Storage temperature

- Without LCD display: -40 to $+90$ °C (-40 to $+194$ °F)
- With LCD display: -40 to $+85$ °C (-40 to $+185$ °F)

Climate class

DIN EN 60068-2-38 (test Z/AD)

Installation height as per IEC61010-1 Ed.3 Generally up to 5 000 m (16 404 ft) above sea level

Degree of protection Testing in accordance with IEC 60529 and NEMA 250

Housing

IP66/68, NEMA TYPE 4X/6P

IP68 test condition: 1.83 m Under water for 24 hours.

Cable entries

- M20 coupling, plastic, IP66/68 NEMA type 4X/6P
- M20 coupling, nickel-plated brass, IP66/68 NEMA type 4X/6P
- M20 coupling, 316L, IP66/68 NEMA type 4X/6P
- M20 coupling, hygiene, IP66/68/69 NEMA type 4X/6P
- M20 thread, IP66/68 NEMA type 4X/6P
- G ½ thread, IP66/68 NEMA TYPE 4X/6P

If the G ½ thread is selected, the device is provided with an M20 thread as standard and an M20 adapter to G M20 ½ is included, along with the associated documentation

- NPT ½ thread, IP66/68 NEMA TYPE 4X/6P
- M12 plug
 - If the housing is closed and the connecting cable is plugged in: IP66/67 NEMA type 4X
 - If the housing is open or the connecting cable is not plugged in: IP20, NEMA type 1

NOTICE

M12 plug: Loss of IP protection class due to incorrect installation!

- ▶ The degree of protection only applies if the connecting cable used is plugged in and screwed tight.
- ▶ The degree of protection only applies if the connecting cable used is specified according to IP67 NEMA 4X.
- ▶ The protection classes are only fulfilled if the dummy cap is used or the cable is connected.

Vibration resistance DIN EN 60068-2-64 / IEC 60068-2-64 for 5 to 2 000 Hz: 1.25 (m/s²)²/Hz

Electromagnetic compatibility (EMC)

- Electromagnetic compatibility as per EN 61326 series and NAMUR recommendation EMC (NE21)
- Maximum measured error during EMC testing: < 0.5 % of the current digital measured value

For more details refer to the EU Declaration of Conformity.

15.4 Process

Process pressure range



The maximum pressure for the device depends on the lowest-rated component with regard to pressure (components are: process connection, optional mounted parts or accessories).

- ▶ Only operate the device within the specified limits for the components!
- ▶ MWP (Maximum Working Pressure): The MWP is specified on the nameplate. This value refers to a reference temperature of +20 °C (+68 °F) and may be applied to the device for an unlimited time. Note temperature dependence of MWP. For flanges, refer to the following standards for the permitted pressure values at higher temperatures: EN 1092-1 (with regard to their stability/temperature property, the materials 1.4435 and 1.4404 are grouped together under EN 1092-1; the chemical composition of the two materials can be identical), ASME B16.5, JIS B2220 (the latest version of the standard applies in each case). MWP data that deviate from this are provided in the relevant sections of the Technical Information.
- ▶ The Pressure Equipment Directive (2014/68/EU) uses the abbreviation **PS**. This corresponds to the maximum working pressure (MWP) of the device.

The following tables show the dependencies between the seal material, process temperature (T_p) and process pressure range for each process connection that can be selected for the antenna used.

Drip-off antenna 50 mm (2 in)

Process connection UNI flange

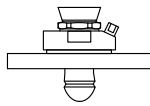
	Seal	T_p	Process pressure range
 <small>A0047827</small>	FKM Viton GLT	-40 to +80 °C (-40 to +176 °F)	-1 to 3 bar (-14.5 to 43.5 psi)

 The pressure range may be further restricted in the event of a CRN approval.

Horn antenna 65 mm (2.6 in)

Process connection standard flange

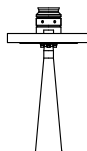
	Seal	T_p	Process pressure range
 <small>A0047836</small>	Graphite	-40 to +280 °C (-40 to +536 °F)	-1 to 160 bar (-14.5 to 2 320.6 psi)
	Graphite	-40 to +450 °C (-40 to +842 °F)	-1 to 160 bar (-14.5 to 2 320.6 psi)

Process connection UNI flange, aluminum adjustable

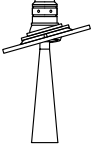
	Seal	T _p	Process pressure range
 <small>A0048812</small>	Graphite	-40 to +280 °C (-40 to +536 °F)	-1 to 1 bar (-14.5 to 14.5 psi)

 The pressure range may be further restricted in the event of a CRN approval.

Antenna, flush mount, PTFE, 80 mm (3 in)

Process connection standard flange with purge air connection

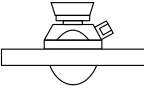
	Seal	T _p	Process pressure range
 <small>A0047828</small>	FKM Viton GLT	-40 to +150 °C (-40 to +302 °F)	-1 to 16 bar (-14.5 to 232 psi)
	FKM Viton GLT	-40 to +200 °C (-40 to +392 °F)	-1 to 16 bar (-14.5 to 232 psi)

Process connection UNI flange, 316L with purge air connection

	Seal	T _p	Process pressure range
 <small>A0047829</small>	FKM Viton GLT	-40 to +150 °C (-40 to +302 °F)	p _{gauge} = -1 to 1 bar (-14.5 to 14.5 psi)
	FKM Viton GLT	-40 to +200 °C (-40 to +392 °F)	p _{gauge} = -1 to 1 bar (-14.5 to 14.5 psi)

Process connection UNI flange, aluminum adjustable with purge air connection

	Seal	T _p	Process pressure range
 <small>A0047830</small>	FKM Viton GLT	-40 to +150 °C (-40 to +302 °F)	-1 to 1 bar (-14.5 to 14.5 psi)
	FKM Viton GLT	-40 to +200 °C (-40 to +392 °F)	-1 to 1 bar (-14.5 to 14.5 psi)

 The pressure range may be further restricted in the event of a CRN approval.

Dielectric constant

For bulk solids

$\epsilon_r \geq 1.6$

Contact Endress+Hauser for applications with lower dielectric constants than indicated.

Index

Symbols

"Device ID" parameter	40
"Device revision" parameter	40
"Firmware version" parameter	40
"Manufacturer ID" parameter	40

A

Access authorization to parameters	
Read access	30
Write access	30
Access code	30
Incorrect input	30
Application	8

B

Bluetooth® wireless technology	31
--	----

C

CE mark	9
Climate class	82
Cyclic data transmission	42

D

Declaration of Conformity	9
Device description files	40
Device locking, status	50
Device master file	
GSD	40
DeviceCare	39
Device description file	40
Diagnostic event	54
Display values	
For locking status	50
Disposal	63
Document	
Purpose	5

E

Event history	57
Event list	57
Event text	54

F

Field of application	
Residual risks	8
FieldCare	39
Device description file	40
Function	39
Filtering the event logbook	58
Firmware	
Release date	40

I

Intended use	8
------------------------	---

M

Media	8
-----------------	---

O

Operation	50
Operational safety	9

P

Product safety	9
PROFINET protocol	45
Purpose of this document	5

R

Read access	30
Reading off measured values	50
Registered trademarks	6
Repair concept	62
Requirements for personnel	8
Return	63

S

Safety instructions	
Basic	8
Securing screw	23
Service interface (CDI)	39, 46
Settings	
Adapting the measuring device to the process	
conditions	50
Software release	40
Spare parts	62
Status signal	53
Submenu	
Event list	57
Interfaces	36
Measured values	50
System redundancy S2	44

T

Troubleshooting	51
Turning the display module	20

U

Use of measuring instrument	
see Intended use	
Use of the measuring devices	
Borderline cases	8
Incorrect use	8

V

Version data for the device	40
---------------------------------------	----

W

Workplace safety	9
Write access	30



www.addresses.endress.com
