

Brief Operating Instructions

Rxn-40 Raman spectroscopic probe



These instructions are Brief Operating Instructions. They are not a substitute for the Operating Instructions pertaining to the device.

Table of Contents

1	About this document.....	5
1.1	Disclaimer	5
1.2	Warnings	5
1.3	Symbols	6
1.4	U.S. export compliance.....	6
2	Basic safety instructions	7
2.1	Requirements for personnel.....	7
2.2	Designated use	7
2.3	Workplace safety.....	7
2.4	Operational safety.....	8
2.5	Laser safety.....	8
2.6	Pressure safety	9
2.7	Service safety.....	9
2.8	Important safeguards.....	9
2.9	Product safety.....	10
3	Product description	12
3.1	Rxn-40 probe.....	12
3.2	Standard hardware.....	15
3.3	Data collection zone: short vs. long	15
4	Incoming product acceptance and product identification	16
4.1	Incoming acceptance.....	16
4.2	Product identification	16
4.3	Scope of delivery.....	17
5	Probe and fiber optic connection	18
5.1	EO fiber cable.....	18
5.2	FC cable assembly	19
6	Installation	20
6.1	Rxn-40 probe with integrated stainless steel fiber connection shell.....	20
6.2	Rxn-40 probe with right-angle fiber connector (EO style)	21
6.3	Rxn-40 probe with flange for process connection.....	21
6.4	Hazardous area installation	22
6.5	Process and probe compatibility	23
7	Commissioning.....	24
7.1	Receipt of probe.....	24
7.2	Probe calibration and verification.....	24



8	Operation	25
9	Diagnostics and troubleshooting	26

1 About this document







1.1 Disclaimer

These instructions are Brief Operating Instructions. They do not replace the Operating Instructions included in the scope of supply.

1.2 Warnings

Structure of Information	Meaning
<p> WARNING</p> <p>Causes (/consequences) Consequences of noncompliance (if applicable) ▶ Corrective action</p>	<p>This symbol alerts you to a dangerous situation. Failure to avoid the dangerous situation can result in a fatal or serious injury.</p>
<p> CAUTION</p> <p>Causes (/consequences) Consequences of noncompliance (if applicable) ▶ Corrective action</p>	<p>This symbol alerts you to a dangerous situation. Failure to avoid this situation can result in minor or more serious injuries.</p>
<p>NOTICE</p> <p>Cause/situation Consequences of noncompliance (if applicable) ▶ Action/note</p>	<p>This symbol alerts you to situations which may result in damage to property.</p>

1.3 Symbols

Symbol	Description
	The Laser Radiation symbol is used to alert the user to the danger of exposure to hazardous visible laser radiation when using the Raman Rxn system.
	The High Voltage symbol that alerts people to the presence of electric potential large enough to cause injury or damage. In certain industries, high voltage refers to voltage above a certain threshold. Equipment and conductors that carry high voltage warrant special safety requirements and procedures.
	The CSA Certification Mark indicates that the product was tested against and met the applicable North American standards requirements.
	The WEEE symbol indicates that the product should not be discarded as unsorted waste but must be sent to separate collection facilities for recovery and recycling.
	The CE Marking indicates conformity with health, safety, and environmental protection standards for products sold within the European Economic Area (EEA).
	The ATEX Marking indicates the product has been certified to the ATEX directive for use in Europe, as well as in other countries accepting ATEX-certified equipment.

1.4 U.S. export compliance

The policy of Endress+Hauser is in strict compliance with U.S. export control laws as detailed in the website of the [Bureau of Industry and Security](#) at the U.S. Department of Commerce. The Export Control Classification number for the Rxn-40 is EAR99.

2 Basic safety instructions

2.1 Requirements for personnel

- Installation, commissioning, operation, and maintenance of the measuring system may be carried out only by specially trained technical personnel.
- Technical personnel must be authorized by the plant operator to carry out the specified activities.
- Technical personnel must have read and understood these Operating Instructions and must follow the instructions contained herein.
- Faults at the measuring point may only be rectified by properly authorized and trained personnel. Repairs not described in this document must be carried out only at the manufacturer's site or by the service organization.

For more assistance with taking appropriate precautions and setting the proper controls when dealing with lasers and their hazards, refer to the most current version of ANSI Z136.1 or IEC 60825-14.

2.2 Designated use

The Rxn-40 Raman spectroscopic probe is intended for liquid immersion sample analysis in a laboratory or process plant setting.

Recommended applications include:

- **Chemical:** reaction monitoring, blending, catalyst monitoring, feed and final product monitoring
- **Polymer:** polymerization reaction monitoring, extrusion monitoring, polymer blending
- **Pharmaceutical:** active pharmaceutical ingredient (API) reaction monitoring, crystallization, polymorph, blending
- **Oil and gas:** any hydrocarbon analysis

Use of the device for any purpose other than that described poses a threat to the safety of people and of the entire measuring system, and invalidates any warranty.

2.3 Workplace safety

As the user, you are responsible for complying with the following safety conditions:

- Installation guidelines
- Local standards and regulations for electromagnetic compatibility

The product has been tested for electromagnetic compatibility in accordance with the applicable international standards for industrial applications. The electromagnetic compatibility indicated applies only to a product that has been properly connected to the analyzer.

2.4 Operational safety

Before commissioning the entire measuring point:

- Verify that all connections are correct.
- Ensure that electro-optical cables are undamaged.
- Ensure fluid level is sufficient for probe immersion (if applicable).
- Do not operate damaged products, and protect them against unintentional operation.
- Label damaged products as defective.

During operation:

- If faults cannot be rectified, products must be taken out of service and protected against unintentional operation.
- When working with laser devices, always follow all local laser safety protocols which may include the use of personal protective equipment and limiting device access to authorized users.

2.5 Laser safety

Raman Rxn analyzers use Class 3B lasers as defined in the following:

- [American National Standards Institute](#) (ANSI) Z136.1, American National Standard for Safe Use of Lasers
- [International Electrotechnical Commission](#) (IEC) 60825-1, Safety of Laser Products – Part 1

WARNING

Laser radiation

- ▶ Avoid exposure to beam
- ▶ Class 3B laser product

CAUTION

Laser beams can cause ignition of certain substances such as volatile organic compounds.

The two possible mechanisms for ignition are direct heating of the sample to a point causing ignition and the heating of a contaminant (such as dusts) to a critical point leading to ignition of the sample.

The laser configuration presents further safety concerns because the radiation is nearly invisible. Always be aware of the initial direction and possible scattering paths of the laser.

For 532 nm and 785 nm excitation wavelengths, use laser safety glasses with OD3 or greater.

For 993 nm excitation wavelength, use laser safety glasses with OD4 or greater.

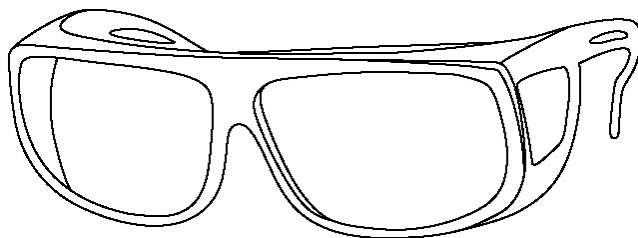

A004B421

Figure 1. Laser safety glasses

For more assistance with taking appropriate precautions and setting the proper controls when dealing with lasers and their hazards, refer to the most current version of ANSI Z136.1 or IEC 60825-14.

2.6 Pressure safety

Pressure ratings are based on the referenced standards for the probe. Fittings and flanges may or may not be included in the rating depending upon the probe configuration. Furthermore, product ratings may be affected by the bolting and sealing materials and procedures.

When planning for installation of an Endress+Hauser probe into the user's piping or sampling system, it is the user's responsibility to understand the limitations of the ratings and select appropriate fittings, bolts, seals, and procedures for alignment and assembly of sealed joints.

Use of these ratings for sealed joints, not conforming to the limitations, or not following accepted good practices for bolting and sealing are the responsibility of the user.

2.7 Service safety

Follow your company's safety instructions when removing a process probe from the process interface for service. Always wear proper protective equipment when servicing the equipment.

2.8 Important safeguards

- Do not use the Rxn-40 probe for anything other than its intended use.
- Do not look directly into the laser beam.
- Do not point the laser at a mirrored or shiny surface, or a surface that may cause diffuse reflections. The reflected beam is as harmful as the direct beam.
- Do not leave attached and unused probes uncapped or unblocked.
- Always use a laser beam block to avoid inadvertent scatter of laser radiation.

2.9 Product safety

This product is designed to meet all current safety requirements, has been tested, and shipped from the factory in a safe operating condition. The relevant regulations and international standards have been observed. Devices connected to an analyzer must also comply with the applicable analyzer safety standards.

Endress+Hauser Raman spectroscopy systems incorporate the following safety features to conform to the United States Government requirements found in Title 21 of the [Code of Federal Regulations \(21 CFR\)](#) Chapter I, Subchapter J as administered by the [Center for Devices and Radiological Health \(CDRH\)](#) and IEC 60825-1 as administered by the [International Electrotechnical Commission](#).

2.9.1 CDRH and IEC compliance

Endress+Hauser Raman analyzers are certified by Endress+Hauser to meet CDRH and IEC 60825-1 design and manufacturing requirements.

Endress+Hauser Raman analyzers have been registered with the CDRH. Any unauthorized modifications to an existing Raman Rxn analyzer or accessory may result in hazardous radiation exposure. Such modifications may result in the system being no longer in conformance with federal requirements as certified by Endress+Hauser.

2.9.2 Laser emission interlock

- ▶ The Rxn-40 probe, as installed, forms part of the interlock circuit. If the fiber cable is severed, the laser will turn off within milliseconds of the breakage.

NOTICE

Permanent damage may result if cables are not routed appropriately.

- ▶ Handle probes and cables with care, ensuring they are not kinked.
- ▶ Install fiber cables with a minimum bend radius according to the *Raman fiber-optic cable Technical Information (TI01641C)*.

The interlock circuit is a low-current electrical loop. If the Rxn-40 probe is used in a hazardous classified area, the interlock circuit must pass through an intrinsically safe (IS) barrier.

The location of the LED laser indicator depends on the assembly type:

- Integrated stainless steel fiber connection shell option: The indicator is located on the fiber connection shell. When there is potential for the laser to be energized, the indicator light is illuminated.
- Non-removable, right-angle fiber connector assembly (EO style): The indicator is located on the assembly. When there is potential for the laser to be energized, the indicator light is illuminated.

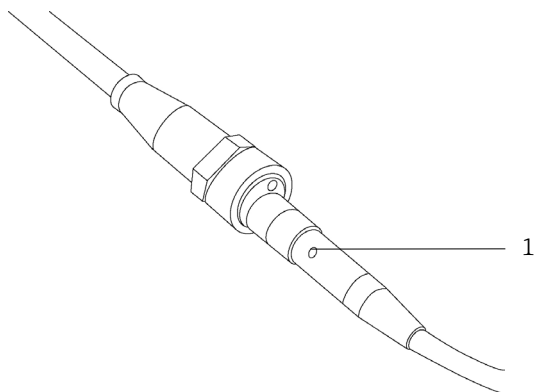

A0049116

Figure 2. laser emission indicator (1) on integrated stainless steel fiber connection shell

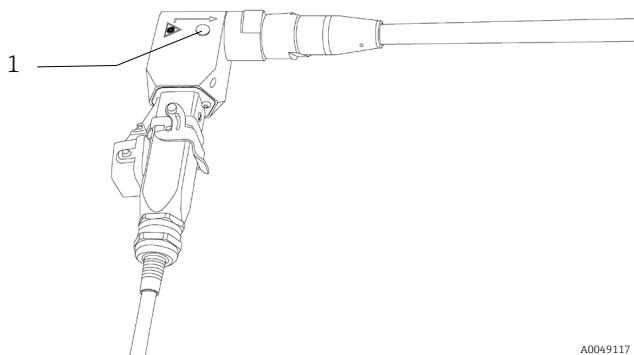

A0049117

Figure 3. laser emission indicator (1) on right-angle fiber connector (EO style) assembly

3 Product description

3.1 Rxn-40 probe

The Rxn-40 Raman spectroscopic probe, powered by Kaiser Raman technology, is intended for liquid immersion sample analysis in a laboratory or process plant setting. The probe allows in-line, realtime chemical measurements and is designed to be compatible with Endress+Hauser Raman Rxn analyzers operating at 532 nm, 785 nm, or 993 nm.

The Rxn-40 probe is extremely compact and offers several mounting options. The process connection for the Rxn-40 probe can be swaged, compression-mounted, flange-mounted, installed in a flow cell, and is NeSSI compatible. The probe is available in the following configurations to aid customization to the process and offer greater sampling flexibility:

- Rxn-40 probe, non-flanged or flanged configuration
- Rxn-40 probe, mini configuration

3.1.1 Rxn-40 probe, non-flanged configuration

The non-flanged configuration of the Rxn-40 probe has a standard immersible range of 152, 305, or 457 mm (6, 12, or 18 in).

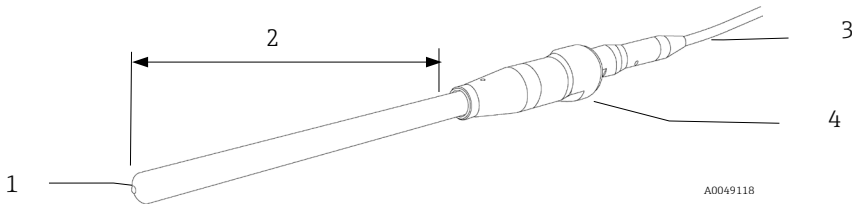
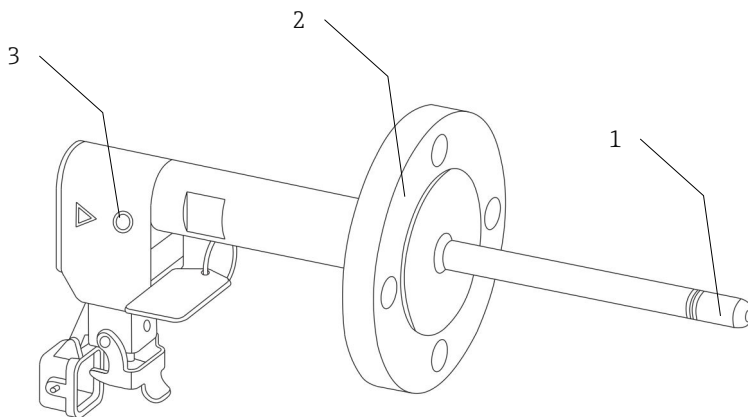

Figure 4. Non-flanged configuration of the Rxn-40 probe

#	Description
1	tip
2	immersible section
3	fiber cable
4	optic body

3.1.2 Rxn-40 probe, flanged configuration

ASME B16.5 and DIN EN1092 Type B flanges are available upon request for the Rxn-40 probe with the flanged configuration.



A0049119

Figure 5. Flanged configuration of the Rxn-40 probe

#	Name	Description
1	Tip	316L stainless steel, C276 alloy or Grade 2 titanium Immersible length of 36 mm (1.42 in)
2	Flange	Flange for process connection (e.g. 316L, C276, Grade 2 titanium)
3	LED laser indicator	Illuminated when the laser is energized

3.1.3 Rxn-40 probe, mini configuration

The mini configuration of the Rxn-40 probe has an immersible length of 36.07 mm (1.42 in).

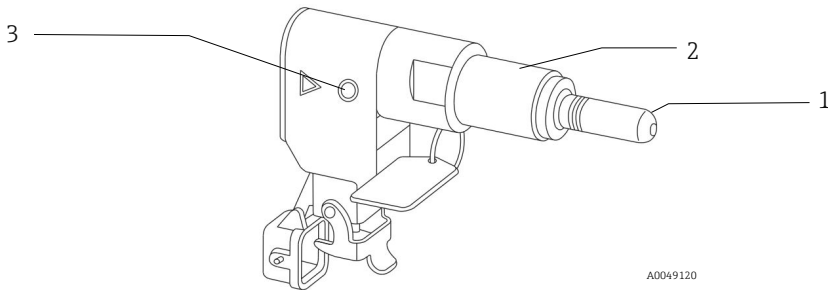

Figure 6. Mini configuration of the Rxn-40 probe

#	Name	Description
1	Tip	316L stainless steel, C276 alloy or Grade 2 titanium Immersible length of 36.07 mm (1.42 in)
2	Optic body	Materials matched to probe tip, but not wetted by process fluids
3	LED laser indicator	Illuminated when the laser is energized

3.2 Standard hardware

Standard hardware includes the Rxn-40 probe without a fiber cable. Fiber cable is sold separately.

For all new installations, one of the following accessories is required. Select the connector appropriate for the analyzer in use:

- Non-removable, right-angle fiber connector assembly (EO style): The assembly contains excitation or collection laser safety interlock connectors, and interlock indicator LED.
- Integrated, stainless steel fiber connection shell: The shell contains excitation or collection optic fibers, laser safety interlock connectors, and interlock indicator LED.

3.3 Data collection zone: short vs. long

The Rxn-40 probe is equipped with either a short (S) or a long (L) data collection zone depending on the version selected:

- A short data collection zone is generally used for opaque samples such as gels, slurries, and paint.
- A long data collection zone is better for transparent samples, such as hydrocarbons and solvents.

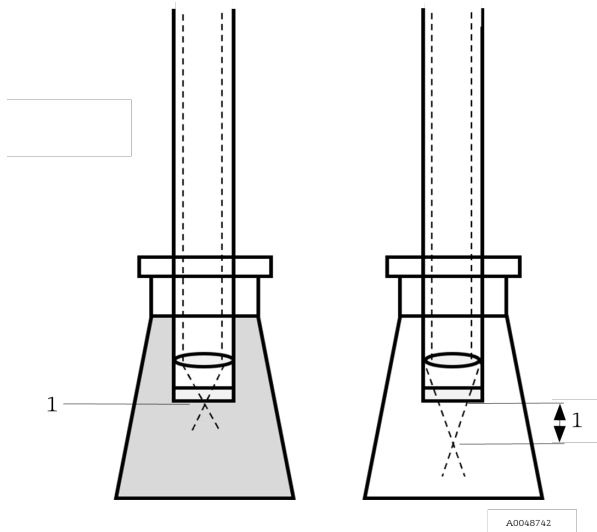

Figure 7. Short (left) vs. long (right) data collection zone (1)

4 Incoming product acceptance and product identification

4.1 Incoming acceptance

1. Verify that the packaging is undamaged. Notify the supplier of any damage to the packaging. Keep the damaged packaging until the issue has been resolved.
2. Verify that the contents are undamaged. Notify the supplier of any damage to the delivery contents. Keep the damaged goods until the issue has been resolved.
3. Check that the delivery is complete and nothing is missing. Compare the shipping documents with your order.
4. Pack the product for storage and transportation in such a way that it is protected against impact and moisture. The original packaging offers the best protection. Make sure to comply with the permitted ambient conditions.

If you have any questions, contact your supplier or your sales center.

NOTICE

- ▶ **Probe may be damaged during transport if packaged inadequately.**

4.2 Product identification

4.2.1 Label

The probe is labeled with the following information:

- Endress+Hauser branding
- Product identification (e.g., Rxn-40)
- Serial number

Tags are permanently affixed and also include:

- Extended order code
- Manufacturer information
- Key functional aspects of the probe (e.g., material, wavelength, focal depth)
- Safety warnings and certification information, as applicable

Compare the information on the probe and tag with the order.

4.2.2 Manufacturer address

Endress+Hauser
371 Parkland Plaza
Ann Arbor, MI 48103 USA

4.3 Scope of delivery

The scope of delivery comprises:

- Rxn-40 probe in the configuration ordered
- *Rxn-40 Raman spectroscopic probe Operating Instructions* manual
- Rxn-40 probe Certificate of Product Performance
- Local declarations of conformity, if applicable
- Certificates for hazardous zone use, if applicable
- Material certificates, if applicable
- Rxn-40 probe optional accessories, if applicable

If you have any questions contact your supplier or local sales center.

5 Probe and fiber optic connection

The Rxn-40 probe connects to the Raman Rxn analyzer via one of the following:

- Fiber channel (FC) cable assembly: available in 5 m (16.4 ft) increments up to 50 m (164.0 ft) with the length limited by the application
- Electro-optical (EO) fiber cable: available in 5 m (16.4 ft) increments up to 200 m (656.2 ft) with the length limited by the application

An optional EO male to EO female extension fiber cable is also available in 5 m (16.4 ft) increments up to 200 m (656.2 ft) with the length limited by the application.

Refer to the applicable Raman Rxn analyzer Operating Instructions for analyzer connection details.

NOTICE

Connection of the probe to the FC cable assembly or the EO fiber cable must be conducted by a qualified Endress+Hauser engineer or specially-trained technical personnel.

Unless trained by qualified personnel, customer attempts to connect the probe to the fiber-optic cable can result in damage and may void the warranty.

- ▶ Contact your local Endress+Hauser service representative for additional support regarding the probe and fiber cable connection.

5.1 EO fiber cable

The EO fiber cable connects the Rxn-40 probe to the analyzer with a single, robust connector that contains the excitation and collection fiber-optics as well as an electrical laser interlock.

An EO extension cable is available for longer cable runs or installation in conduit.

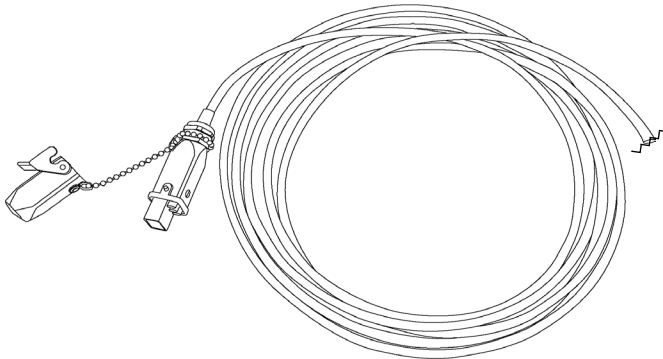

A0048938

Figure 8. EO fiber cable showing connector for analyzer

5.2 FC cable assembly

The FC cable assembly connects the Rxn-40 probe to the analyzer through the following:

- Electrical interlock connector
- Yellow (YE) excitation fiber for laser output
- Red (RD) collection fiber for spectrograph input

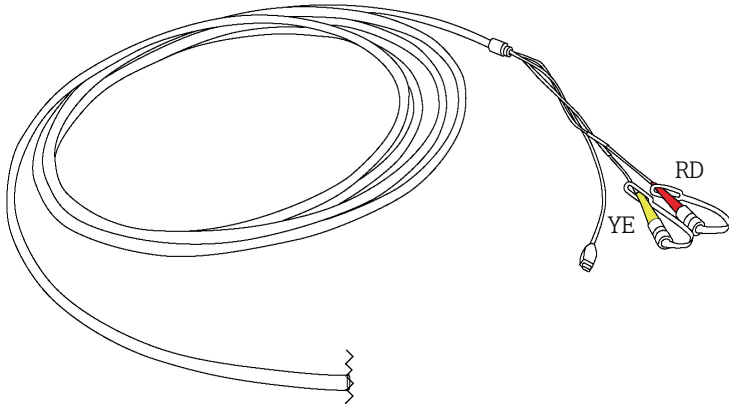

A0048939

Figure 9. FC cable assembly showing connector for analyzer

6 Installation

Prior to installation in the process, the maximum amount of laser power output should be verified to ensure it is no more than the amount specified in the Hazardous Area Equipment Assessment (4002266) or equivalent. Contact your service representative as needed for assistance.

Standard eye and skin safety precautions for Class 3B laser products (as per EN 60825/IEC 60825-14 or ANSI Z136.1) should be observed. Additionally, observe the following:

<p>⚠ WARNING</p>	<p>Probes are designed with specific sealing boundaries.</p> <ul style="list-style-type: none"> ▶ The probe pressure specifications are only valid if sealing is accomplished on the intended sealing feature (shaft, flange, etc.). ▶ Service ratings may include limitations for fittings, flanges, bolts, and seals. The installer must understand these limitations and use appropriate hardware and assembly procedures for a pressure-tight and safe joint. <p>Standard precautions for laser products should be observed.</p> <ul style="list-style-type: none"> ▶ Probes should always be capped or pointed away from people, toward a diffuse target, if not installed in a sample chamber.
<p>⚠ CAUTION</p>	<p>If stray light enters an unused probe, it will interfere with data collected from a probe in-use and may cause calibration failure or measurement errors.</p> <ul style="list-style-type: none"> ▶ Unused probes should ALWAYS be capped to prevent stray light from entering the probe.
<p>NOTICE</p>	<p>Excessive twisting of the cable within the connector may break a fiber connection, rendering the Rxn-40 probe inoperable.</p> <ul style="list-style-type: none"> ▶ Take care to install the probe such that it measures the flowing sample or sample region of interest.

6.1 Rxn-40 probe with integrated stainless steel fiber connection shell

When installing an Rxn40 probe equipped with the integrated stainless steel fiber connection shell into the sample interface, it is important to avoid excessive twisting of the cable, which may break a fiber connection and render the Rxn-40 probe inoperable. Some common options for installing the probe are described below.

6.1.1 Probe and interface combined

When installing an NPT (threaded) interface on site for the Rxn-40 probe and integrated fiber connection shell, keep the probe body and fiber cable fixed and then rotate the

interface onto the probe. Once secure, integrate the interface and attached probe into the sample area.

6.1.2 Probe into pre-installed interface

If the NPT interface for the probe is already installed, then rotate the probe into the interface before connecting the stainless steel shell of the fiber cable to the probe. Once secure, attach the fiber cable housing to the probe.

6.1.3 Probe and compression nut interface

If the probe is being installed using an optional compression fitting (e.g., swage nut), the fiber cable can be attached to the probe body before installing the probe into the interface. The compression fitting alleviates the need to rotate the probe during installation.

6.2 Rxn-40 probe with right-angle fiber connector (EO style)

When installing an Rxn-40 probe equipped with the non-removable, right-angle fiber connector (EO style) assembly, it is recommended that the fiber-optic cable assembly be disconnected from the probe during installation.

6.3 Rxn-40 probe with flange for process connection

The Rxn-40 probe may be configured with a range of standard flanges for connection to process piping. When installing, good practices should be followed and care should be taken to select bolts and seals that are appropriate for the installation and service rating.

6.4 Hazardous area installation

The probe has been designed to be installed directly into slip-streams, drain-valves, reactors, circulation loops, blend headers, and inlet or outlet pipework. The probe must be installed according to the Hazardous Area Installation Drawing (4002396).

NOTICE

When installing the probe head *in situ*, the user must ensure that there is strain relief at the installation location which complies with fiber bend radius specifications.

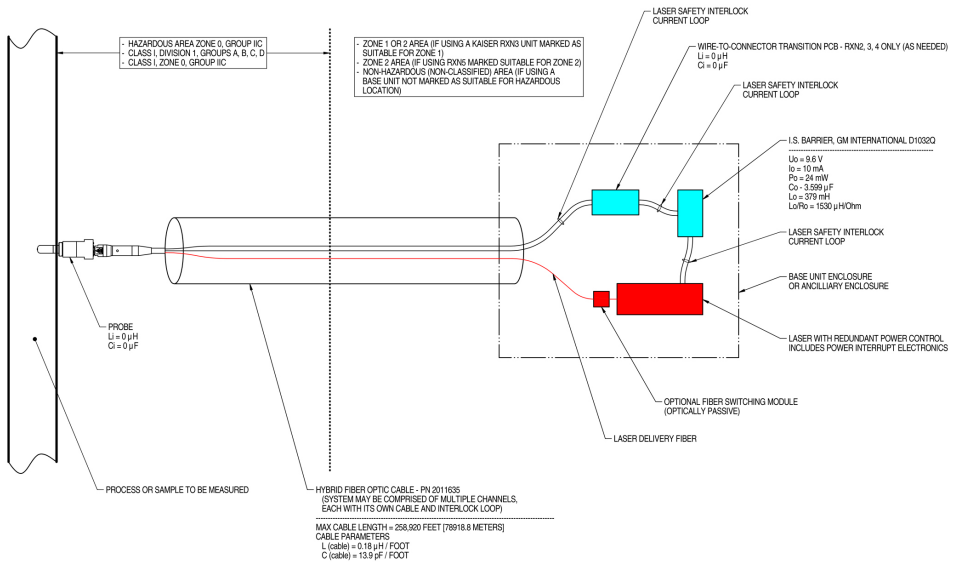

NOTES:

- CONTROL EQUIPMENT CONNECTED TO THE ASSOCIATED APPARATUS MUST NOT USE OR GENERATE MORE THAN 250 VRMS OR VDC.
- INSTALLATION IN THE U.S. SHOULD BE IN ACCORDANCE WITH ANSI/ISA RP12.6 "INSTALLATION OF INTRINSICALLY SAFE SYSTEMS FOR HAZARDOUS (CLASSIFIED) LOCATIONS" AND THE NATIONAL ELECTRICAL CODE® (ANSI/NFPA 70) SECTIONS 504 AND 505.
- INSTALLATION IN CANADA SHOULD BE IN ACCORDANCE WITH THE CANADIAN ELECTRICAL CODE, CSA C22.1, PART 18, APPENDIX J18.
- ASSOCIATED APPARATUS MANUFACTURER'S INSTALLATION DRAWING MUST BE FOLLOWED WHEN INSTALLING THIS EQUIPMENT.
- FOR U.S. INSTALLATIONS, THE PROBE MODELS RXN-30 (AIRHEAD), RXN-40 (WETHEAD) AND RXN-41 (PILOT) ARE APPROVED FOR CLASS I, ZONE 0 APPLICATIONS.
- NO REVISION TO DRAWING WITHOUT PRIOR CSA APPROVAL.
- WARNING: SUBSTITUTION OF COMPONENTS MAY IMPAIR INTRINSIC SAFETY.

A0049010

Figure 10. Hazardous Area Installation Drawing (4002396 version X6)

6.5 Process and probe compatibility

Prior to installation, the user must verify that the probe pressure and temperature ratings, as well as the materials from which the probe is made, are compatible with the process into which it is being inserted.

The probes should be installed using sealing techniques (e.g., flanges, compression fittings) appropriate and typical for the vessel or piping and in accordance with any local construction codes.

 **WARNING**

If the probe will be installed in a high temperature or pressure process, additional safety precautions must be taken to avoid equipment damage or safety hazards.

A blow-out protection device is highly recommended in accordance with local safety standards.

- ▶ It is the responsibility of the user to determine if any blow-out protection devices are required and ensure they are attached to the probes during installation.

 **WARNING**

If the probe being installed is constructed of titanium, the user should be aware that impacts or excessive process friction could cause a spark or otherwise cause ignition.

- ▶ The user must ensure that precautions are taken when installing and using a titanium probe to avoid such an occurrence.

7 Commissioning

The Rxn-40 probe is delivered ready to connect to the Raman Rxn analyzer. No additional alignment or adjustment to the probe itself is required. Follow the instructions below to commission the probe for use.

NOTICE

The probe installation and usage parameters may have specific requirements governed by the associated application.

- ▶ Please refer to the appropriate certificate for ATEX, CSA, IECEx, JPEX, or UKCA for those specific requirements.

7.1 Receipt of probe

Perform the steps for incoming product acceptance described in *Incoming acceptance* → .

Additionally, upon receipt remove the shipping container cover and inspect the sapphire window for any damage prior to installing into the process. If the window shows any visible cracks, contact the supplier.

7.2 Probe calibration and verification

The probe and the analyzer must be calibrated before use. Refer to the applicable Raman Rxn2 or Rxn4 analyzer operating instructions for further information on internal instrument calibration.

An intensity calibration must be performed before collecting measurements and after changing optics. Use the Calibration accessory (HCA) with an appropriate optic adapter to perform the probe calibration. All accessory information and calibration instructions can be found in the *Calibration accessory operating instructions (BA02173C)*.

The Raman Runtime software will not allow spectra to be collected without passing internal system calibrations.

Verification of the calibration results with a Raman shift standard is highly recommended to verify the calibration results but is not required. Instructions on verification with Raman shift standards can also be found in the Calibration accessory operating instructions.

The recommended calibration and qualification sequence follows this order:

1. Internal analyzer calibration for spectrograph and laser wavelength.
2. System intensity calibration using appropriate calibration accessory.
3. System function verification using appropriate standard material.

Contact your sales associate for specific questions related to your probe, optic, and sampling system.

8 Operation

The Endress+Hauser Raman Rxn-40 probe is a compact, sealed immersion probe for *in situ* Raman spectroscopy of liquid-phase samples in a laboratory or process plant setting. The Rxn-40 line of probes is designed to be compatible with Endress+Hauser Raman Rxn analyzers equipped with a laser operating at 532 nm, 785 nm, or 993 nm.

Refer to the applicable Raman Rxn analyzer Operating Instructions for additional instructions for use.

Raman Rxn analyzer Operating Instructions are available by searching the Downloads area of the Endress+Hauser website: <https://endress.com/downloads>.

9 Diagnostics and troubleshooting

Refer to the table below when troubleshooting issues with the Rxn-40 probe. If the probe is damaged, isolate the probe from the process stream and turn off the laser prior to evaluation. Contact your service representative as needed for assistance.

Symptom	Possible cause	Action
1 Substantial reduction in signal or signal-to-noise ratio	Window fouling	<ol style="list-style-type: none"> Carefully remove probe from the process, decontaminate, and inspect optical window at tip of probe. If necessary, clean the window before returning it to service. <p><i>*See Maintenance in the Rxn-40 Operating Instructions (BA02181C)</i></p>
	Cracked but intact fiber	Verify condition of fiber and contact your service representative for replacement.
2 Complete loss of signal while laser is powered and LED laser indicator is lit	Broken fiber without interlock wire breakage	Ensure all fiber connections are secure.
	Process material sticking on probe window	Remove the probe and clean the window.
3 LED laser indicator on probe is not lit	Damaged fiber assembly or damaged Rxn-41 probe interlock	<ol style="list-style-type: none"> Look for signs of breakage in fiber. Ensure probe is properly connected to the fiber. Contact your service representative for replacement.
	Fiber cable EO connector not secured/latched	Ensure EO connector is properly connected and latched at the probe (if applicable) and at the analyzer.
	Remote interlock connector disconnected	Ensure the twist-lock remote interlock connector at the rear of analyzer (next to fiber EO connector) is connected.
4 Unstable signal and contamination visible behind window	Window seal failure	<ol style="list-style-type: none"> Disconnect the probe and examine the area inside the window for moisture or condensation. Examine the area inside the window for moisture or condensation. Look for any sign of spectral deviation. <p>If any of the above are noted, contact your service representative to return the probe to the manufacturer.</p>

Symptom		Possible cause	Action
5	Decreased laser power or collection efficiency	Contaminated fiber connection (dirt particles, dust particles, or otherwise) between fiber cable and probe	Carefully clean the fiber ends at the probe. Refer to the applicable Raman Rxn analyzer Operating Instructions for cleaning instructions and steps for starting up a new probe.
6	Laser interlock on analyzer causes laser to shut down	Laser interlock activated	Check for fiber breakage on all connected fiber-optic cable channels and ensure remote interlock connectors are in place on each channel.
7	Unrecognized bands or patterns in the spectra	Cracked but intact fiber	Verify possible causes and contact your service representative to return the damaged product.
		Contaminated probe tip	
		Contaminated internal optics of probe due to leakage	
8	Other unexplained negative performance of the probe	Physical damage to probe	Contact your service representative to return the damaged product.

www.addresses.endress.com

Endress+Hauser 
People for Process Automation