

Brief Operating Instructions

Proline 100

EtherNet/IP

Transmitter with
Coriolis sensor

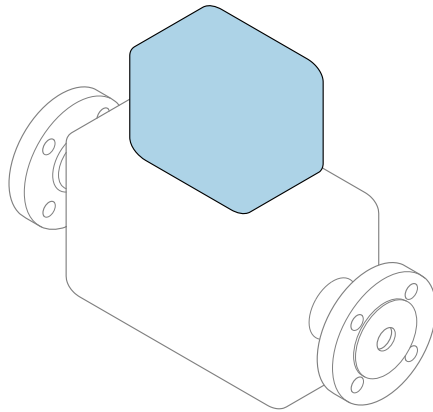

These instructions are Brief Operating Instructions; they are **not** a substitute for the Operating Instructions pertaining to the device.

Transmitter Brief Operating Instructions

Contain information about the transmitter.

Sensor Brief Operating Instructions →  3



A0023555

Brief Operating Instructions for the device

The device consists of a transmitter and a sensor.

The process of commissioning these two components is described in two separate manuals:

- Sensor Brief Operating Instructions
- Transmitter Brief Operating Instructions

Please refer to both Brief Operating Instructions when commissioning the device as the contents of the manuals complement one another:

Sensor Brief Operating Instructions

The Sensor Brief Operating Instructions are aimed at specialists with responsibility for installing the measuring device.

- Incoming acceptance and product identification
- Storage and transport
- Installation

Transmitter Brief Operating Instructions

The Transmitter Brief Operating Instructions are aimed at specialists with responsibility for commissioning, configuring and parameterizing the measuring device (until the first measured value).

- Product description
- Installation
- Electrical connection
- Operation options
- System integration
- Commissioning
- Diagnostic information

Additional device documentation



These Brief Operating Instructions are the **Transmitter Brief Operating Instructions**.

The "Sensor Brief Operating Instructions" are available via:

- Internet: www.endress.com/deviceviewer
- Smart phone/tablet: *Endress+Hauser Operations App*

Detailed information about the device can be found in the Operating Instructions and the other documentation:

- Internet: www.endress.com/deviceviewer
- Smart phone/tablet: *Endress+Hauser Operations App*





Table of contents

1	Document information	5
1.1	Symbols used	5
2	Basic safety instructions	7
2.1	Requirements for the personnel	7
2.2	Designated use	7
2.3	Workplace safety	8
2.4	Operational safety	8
2.5	Product safety	8
2.6	IT security	9
3	Product description	9
4	Installation	9
4.1	Mounting the measuring device	9
5	Electrical connection	11
5.1	Electrical safety	11
5.2	Connecting requirements	11
5.3	Connecting the device	14
5.4	Special connection instructions	17
5.5	Hardware settings	17
5.6	Ensuring the degree of protection	18
5.7	Post-connection check	19
6	Operation options	20
6.1	Overview of operating options	20
6.2	Structure and function of the operating menu	21
6.3	Access to the operating menu via the web browser	21
6.4	Access to the operating menu via the operating tool	27
7	System integration	27
8	Commissioning	28
8.1	Function check	28
8.2	Setting the operating language	28
8.3	Configuring the measuring device	28
8.4	Protecting settings from unauthorized access	28
9	Diagnostic information	29











1 Document information

1.1 Symbols used





1.1.1 Safety symbols

Symbol	Meaning
	DANGER! This symbol alerts you to a dangerous situation. Failure to avoid this situation will result in serious or fatal injury.
	WARNING! This symbol alerts you to a dangerous situation. Failure to avoid this situation can result in serious or fatal injury.
	CAUTION! This symbol alerts you to a dangerous situation. Failure to avoid this situation can result in minor or medium injury.
	NOTE! This symbol contains information on procedures and other facts which do not result in personal injury.

1.1.2 Symbols for certain types of information





Symbol	Meaning	Symbol	Meaning
	Permitted Procedures, processes or actions that are permitted.		Preferred Procedures, processes or actions that are preferred.
	Forbidden Procedures, processes or actions that are forbidden.		Tip Indicates additional information.
	Reference to documentation		Reference to page
	Reference to graphic		Series of steps
	Result of a step		Visual inspection

1.1.3 Electrical symbols





Symbol	Meaning	Symbol	Meaning
	Direct current		Alternating current
	Direct current and alternating current		Ground connection A grounded terminal which, as far as the operator is concerned, is grounded via a grounding system.

Symbol	Meaning
	<p>Protective Earth (PE) A terminal which must be connected to ground prior to establishing any other connections.</p> <p>The ground terminals are situated inside and outside the device:</p> <ul style="list-style-type: none"> ■ Inner ground terminal: Connects the protective earth to the mains supply. ■ Outer ground terminal: Connects the device to the plant grounding system.

1.1.4 Tool symbols

Symbol	Meaning	Symbol	Meaning
	Torx screwdriver		Flat blade screwdriver
	Cross-head screwdriver		Allen key
	Open-ended wrench		

1.1.5 Symbols in graphics

Symbol	Meaning	Symbol	Meaning
1, 2, 3,...	Item numbers		Series of steps
A, B, C, ...	Views	A-A, B-B, C-C, ...	Sections
	Hazardous area		Safe area (non-hazardous area)
	Flow direction		

2 Basic safety instructions

2.1 Requirements for the personnel

The personnel must fulfill the following requirements for its tasks:

- ▶ Trained, qualified specialists must have a relevant qualification for this specific function and task.
- ▶ Are authorized by the plant owner/operator.
- ▶ Are familiar with federal/national regulations.
- ▶ Before starting work, read and understand the instructions in the manual and supplementary documentation as well as the certificates (depending on the application).
- ▶ Follow instructions and comply with basic conditions.

2.2 Designated use

Application and media

- The measuring device described in these Brief Operating Instructions is intended only for flow measurement of liquids and gases.
- The measuring device described in these Brief Operating Instructions is intended only for flow measurement of liquids.

Depending on the version ordered, the measuring device can also measure potentially explosive, flammable, poisonous and oxidizing media.

Measuring devices for use in hazardous areas, in hygienic applications or where there is an increased risk due to process pressure, are labeled accordingly on the nameplate.

To ensure that the measuring device remains in proper condition for the operation time:

- ▶ Keep within the specified pressure and temperature range.
- ▶ Only use the measuring device in full compliance with the data on the nameplate and the general conditions listed in the Operating Instructions and supplementary documentation.
- ▶ Based on the nameplate, check whether the ordered device is permitted for the intended use in the hazardous area (e.g. explosion protection, pressure vessel safety).
- ▶ Use the measuring device only for media to which the process-wetted materials are sufficiently resistant.
- ▶ If the measuring device is not operated at atmospheric temperature, compliance with the relevant basic conditions specified in the associated device documentation is absolutely essential: "Documentation" section.
- ▶ Protect the measuring device permanently against corrosion from environmental influences.

Incorrect use

Non-designated use can compromise safety. The manufacturer is not liable for damage caused by improper or non-designated use.

WARNING

Danger of breakage due to corrosive or abrasive fluids!

- ▶ Verify the compatibility of the process fluid with the sensor material.
- ▶ Ensure the resistance of all fluid-wetted materials in the process.
- ▶ Keep within the specified pressure and temperature range.

NOTICE**Verification for borderline cases:**

- ▶ For special fluids and fluids for cleaning, Endress+Hauser is glad to provide assistance in verifying the corrosion resistance of fluid-wetted materials, but does not accept any warranty or liability as minute changes in the temperature, concentration or level of contamination in the process can alter the corrosion resistance properties.

Residual risks**⚠ WARNING****The electronics and the medium may cause the surfaces to heat up. This presents a burn hazard!**

- ▶ For elevated fluid temperatures, ensure protection against contact to prevent burns.

Only applies for Proline Promass E, F, O, X and Cubemass C

⚠ WARNING**Danger of housing breaking due to measuring tube breakage!**

- ▶ In the event of a measuring tube breakage for a device version without rupture disk it is possible for the pressure loading capacity of the sensor housing to be exceeded. This can lead to rupture or failure of the sensor housing.

2.3 Workplace safety

For work on and with the device:

- ▶ Wear the required personal protective equipment according to federal/national regulations.

For welding work on the piping:

- ▶ Do not ground the welding unit via the measuring device.

If working on and with the device with wet hands:

- ▶ Due to the increased risk of electric shock, gloves must be worn.

2.4 Operational safety

Risk of injury.

- ▶ Operate the device in proper technical condition and fail-safe condition only.
- ▶ The operator is responsible for interference-free operation of the device.

2.5 Product safety

This measuring device is designed in accordance with good engineering practice to meet state-of-the-art safety requirements, has been tested, and left the factory in a condition in which it is safe to operate.

It meets general safety standards and legal requirements. It also complies with the EU directives listed in the device-specific EU Declaration of Conformity. Endress+Hauser confirms this by affixing the CE mark to the device.

2.6 IT security

We only provide a warranty if the device is installed and used as described in the Operating Instructions. The device is equipped with security mechanisms to protect it against any inadvertent changes to the device settings.

IT security measures in line with operators' security standards and designed to provide additional protection for the device and device data transfer must be implemented by the operators themselves.

3 Product description

The device consists of a transmitter and a sensor.

The device is available as a compact version:

The transmitter and sensor form a mechanical unit.



For detailed information on the product description, see the Operating Instructions for the device

4 Installation



For detailed information about mounting the sensor, see the Sensor Brief Operating Instructions →  3

4.1 Mounting the measuring device

4.1.1 Turning the display module

The local display is only available with the following device version:

Order code for "Display; operation", option **B**: 4-line; illuminated, via communication

The display module can be turned to optimize display readability.

Aluminum housing version

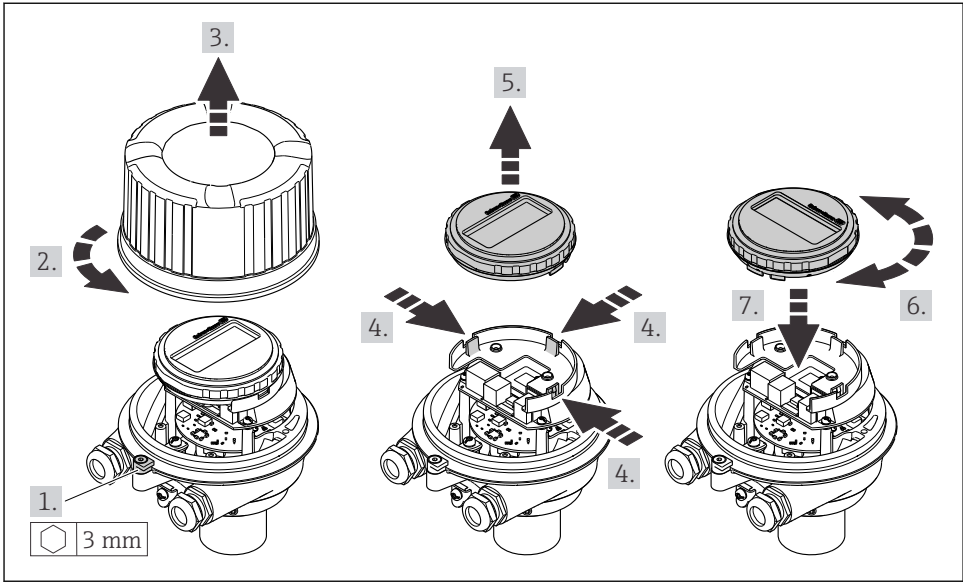

Compact and ultra-compact housing versions

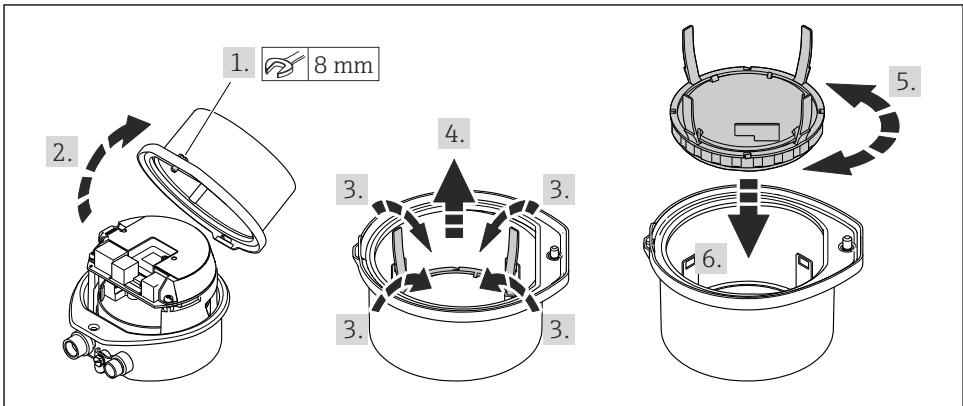

5 Electrical connection

WARNING

Live parts! Incorrect work performed on the electrical connections can result in an electric shock.

- ▶ Set up a disconnecting device (switch or power-circuit breaker) to easily disconnect the device from the supply voltage.
- ▶ In addition to the device fuse, include an overcurrent protection unit with max. 16 A in the plant installation.

5.1 Electrical safety

In accordance with applicable national regulations.

5.2 Connecting requirements

5.2.1 Required tools

- For cable entries: Use corresponding tools
- For securing clamp (on aluminum housing): Allen screw 3 mm
- For securing screw (for stainless steel housing): open-ended wrench 8 mm
- Wire stripper
- When using stranded cables: crimper for wire end ferrule

5.2.2 Requirements for connection cable

The connecting cables provided by the customer must fulfill the following requirements.

Permitted temperature range

- The installation guidelines that apply in the country of installation must be observed.
- The cables must be suitable for the minimum and maximum temperatures to be expected.

Power supply cable (incl. conductor for the inner ground terminal)

Standard installation cable is sufficient.

Signal cable

-  For custody transfer, all signal lines must be shielded cables (tinned copper braiding, optical coverage $\geq 85\%$). The cable shield must be connected on both sides.

Pulse/frequency/switch output

Standard installation cable is sufficient.

EtherNet/IP

Twisted-pair Ethernet CAT 5 or better.

-  See <https://www.odva.org>"EtherNet/IP Media Planning & Installation Manual".



Cable diameter

- Cable glands supplied:
 - M20 × 1.5 with cable \varnothing 6 to 12 mm (0.24 to 0.47 in)
- Spring terminals:
 - Wire cross-sections 0.5 to 2.5 mm² (20 to 14 AWG)

5.2.3 Terminal assignment

The terminal assignment for the electrical connection of the device can be found on the connection nameplate of the electronics module.

In addition, the device version with Modbus RS485 is supplied with the Safety Barrier Promass 100 whose nameplate also bears information on the terminals.

 For detailed information on the terminal assignment, see the Operating Instructions for the device →  3

Transmitter

Device version with EtherNet/IP communication protocol

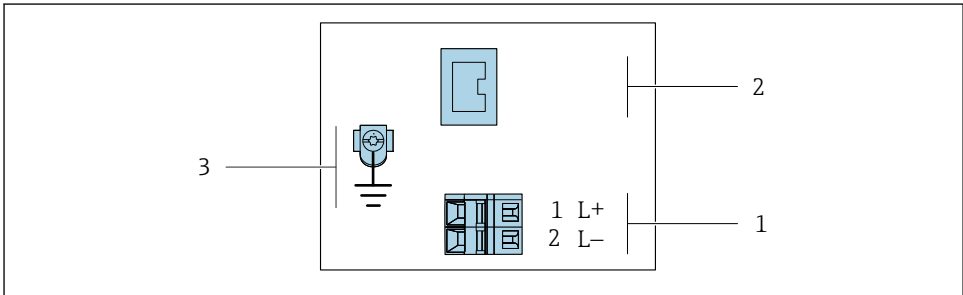

A0017054

1 EtherNet/IP terminal assignment

1 Power supply: DC 24 V

2 Output: EtherNet/IP

3 Connection for cable shield (IO signals) if present and/or protective ground from the supply voltage if present. Not for option C "Ultra-compact, hygienic, stainless".

Safety Barrier Promass 100

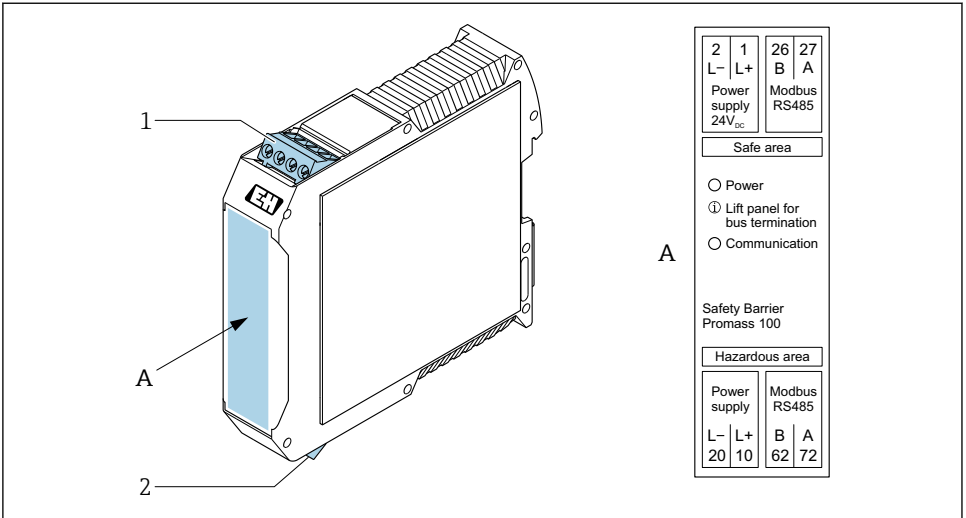

A0016922

2 Safety Barrier Promass 100 with terminals

- 1 Non-hazardous area and Zone 2/Div. 2
- 2 Intrinsically safe area

5.2.4 Pin assignment, device plug

Supply voltage

<p>A0029042</p>	Pin	Assignment	
	1	L+	DC 24 V
	2		Not used
	3		Not used
	4	L-	DC 24 V
	5		Grounding/shielding ¹⁾
Coding	Plug/socket		
A	Plug		

1) Connection for protective ground and/or shielding from the supply voltage if present. Not for option C "Ultra-compact, hygienic, stainless". Note: There is a metallic connection between the union nut of the M12 cable and the transmitter housing.

Device plug for signal transmission (device side)

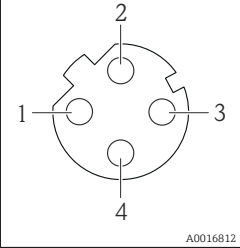
 <p>A0016812</p>	Pin		Assignment	
	1	+		Tx
	2	+		Rx
	3	-		Tx
	4	-		Rx
Coding		Plug/socket		
D		Socket		

5.2.5 Preparing the measuring device

NOTICE

Insufficient sealing of the housing!

Operational reliability of the measuring device could be compromised.

- ▶ Use suitable cable glands corresponding to the degree of protection.

1. Remove dummy plug if present.
2. If the measuring device is supplied without cable glands:
Provide suitable cable gland for corresponding connecting cable.
3. If the measuring device is supplied with cable glands:
Observe requirements for connecting cables → 11.

5.3 Connecting the device

NOTICE

An incorrect connection compromises electrical safety!

- ▶ Only properly trained specialist staff may perform electrical connection work.
- ▶ Observe applicable federal/national installation codes and regulations.
- ▶ Comply with local workplace safety regulations.
- ▶ Always connect the protective ground cable ⊕ before connecting additional cables.
- ▶ When using in potentially explosive atmospheres, observe the information in the device-specific Ex documentation.

5.3.1 Connecting the transmitter

The connection of the transmitter depends on the following order codes:

- Housing version: compact or ultra-compact
- Connection version: device plug or terminals

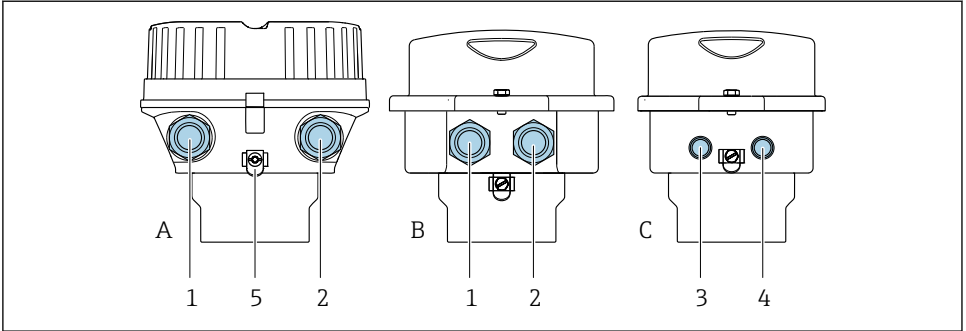

A0016924

3 Housing versions and connection versions

- A Housing version: compact, coated, aluminum
- B Housing version: compact, hygienic, stainless
- C Housing version: ultra-compact, hygienic, stainless
- 1 Cable entry or device plug for signal transmission
- 2 Cable entry or device plug for supply voltage
- 3 Device plug for signal transmission
- 4 Device plug for supply voltage
- 5 Ground terminal. Cable lugs, pipe clips or ground disks are recommended for optimization of the grounding/shielding.

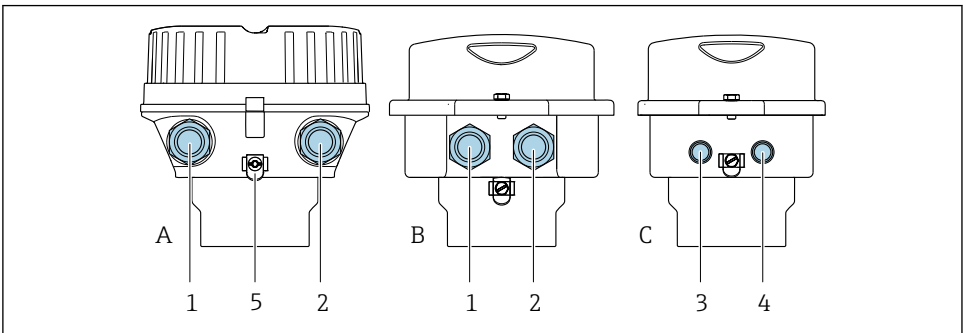

A0016924

4 Housing versions and connection versions

- A Housing version: compact, coated, aluminum
- B Housing version: compact, stainless
- C Housing version: ultra-compact, stainless
- 1 Cable entry or device plug for signal transmission
- 2 Cable entry or device plug for supply voltage
- 3 Device plug for signal transmission
- 4 Device plug for supply voltage
- 5 Ground terminal. Cable lugs, pipe clips or ground disks are recommended for optimization of the grounding/shielding.

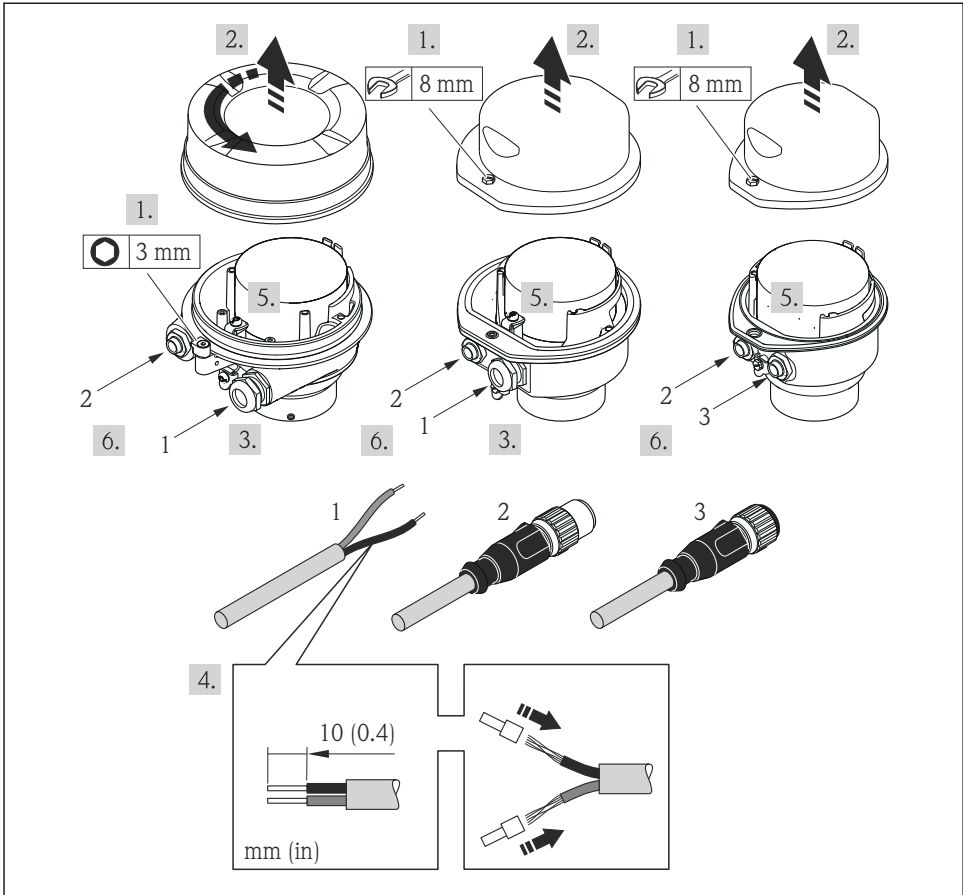

A0017844

5 Device versions with connection examples

- 1 Cable
- 2 Device plug for signal transmission
- 3 Device plug for supply voltage

i Depending on the housing version, disconnect the local display from the main electronics module: Operating Instructions for the device .

- ▶ Connect the cable in accordance with the terminal assignment → **12** or the device plug pin assignment .

5.4 Special connection instructions

5.4.1 Connection examples

EtherNet/IP

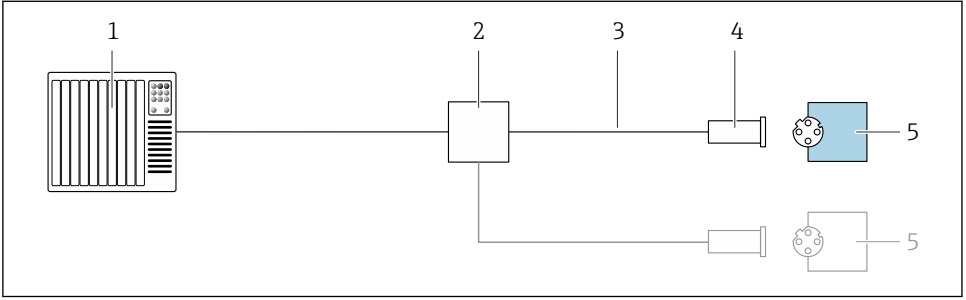

A0028767

6 Connection example for EtherNet/IP

- 1 Control system (e.g. PLC)
- 2 Ethernet switch
- 3 Observe cable specifications
- 4 Device plug
- 5 Transmitter

5.5 Hardware settings

5.5.1 Setting the device address

EtherNet/IP

The IP address of the measuring device can be configured for the network via DIP switches.

Addressing data

IP address and configuration options			
1st octet	2nd octet	3rd octet	4th octet
192.	168.	1.	XXX
	↓		↓
	Can only be configured via software addressing		Can be configured via software addressing and hardware addressing

IP address range	1 to 254 (4th octet)
IP address broadcast	255

Addressing mode ex works	Software addressing; all DIP switches for hardware addressing are set to OFF.
IP address ex works	DHCP server active

 For device addressing via software

Setting the address

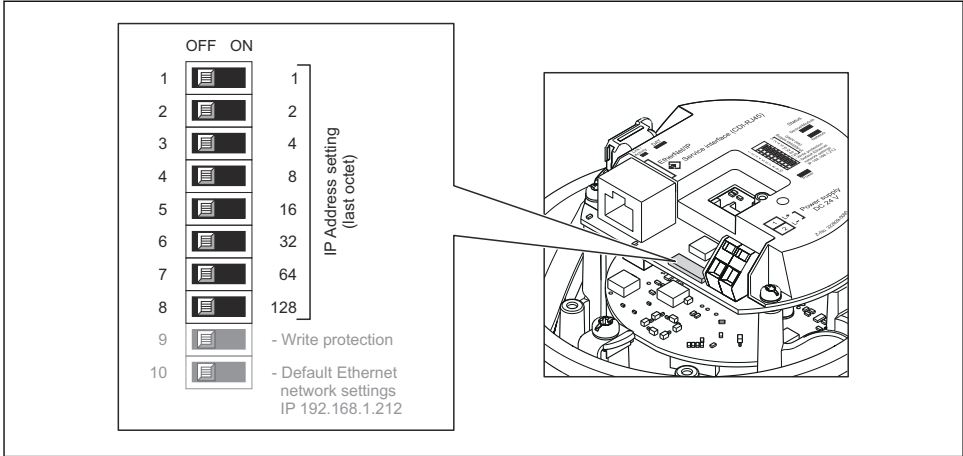

A0017913

- ▶ Set the desired IP address using the corresponding DIP switches on the I/O electronics module.
 - ↳ Hardware addressing with the configured IP address is enabled after 10 s.

5.6 Ensuring the degree of protection

The measuring device fulfills all the requirements for the IP66/67 degree of protection, Type 4X enclosure.

To guarantee IP66/67 degree of protection, Type 4X enclosure, carry out the following steps after the electrical connection:

1. Check that the housing seals are clean and fitted correctly.
2. Dry, clean or replace the seals if necessary.
3. Tighten all housing screws and screw covers.
4. Firmly tighten the cable glands.

- 5. To ensure that moisture does not enter the cable entry:
Route the cable so that it loops down before the cable entry ("water trap").

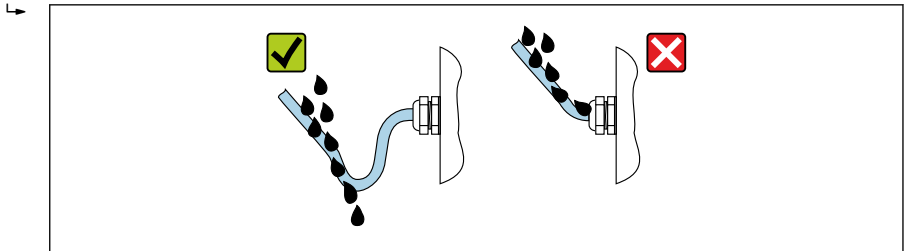

A0029278

- 6. Insert dummy plugs into unused cable entries.

5.7 Post-connection check

Are cables or the device undamaged (visual inspection)?	<input type="checkbox"/>
Do the cables used meet the requirements → 11?	<input type="checkbox"/>
Do the cables have adequate strain relief?	<input type="checkbox"/>
Are all the cable glands installed, firmly tightened and leak-tight? Cable run with "water trap" → 18?	<input type="checkbox"/>
Depending on the device version: are all the device plugs firmly tightened → 14?	<input type="checkbox"/>
Does the supply voltage match the specifications on the transmitter nameplate?	<input type="checkbox"/>
Is the terminal assignment or pin assignment of the connector → 13 correct?	<input type="checkbox"/>
If supply voltage is present, is the power LED on the electronics module of the transmitter lit green?	<input type="checkbox"/>
Depending on the device version, is the securing clamp or fixing screw firmly tightened?	<input type="checkbox"/>

6 Operation options

6.1 Overview of operating options

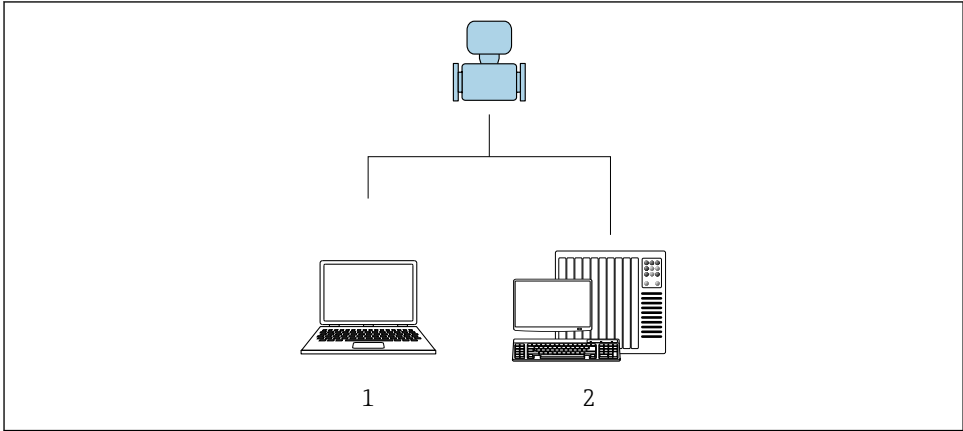

A0017760

- 1 Computer with Web browser (e.g. Internet Explorer) or with "FieldCare" operating tool
- 2 Automation system, e.g. "RSLogix" (Rockwell Automation) and work station for measuring device operation with Add-on Profile Level 3 for "RSLogix 5000" software (Rockwell Automation)

6.2 Structure and function of the operating menu

6.2.1 Structure of the operating menu

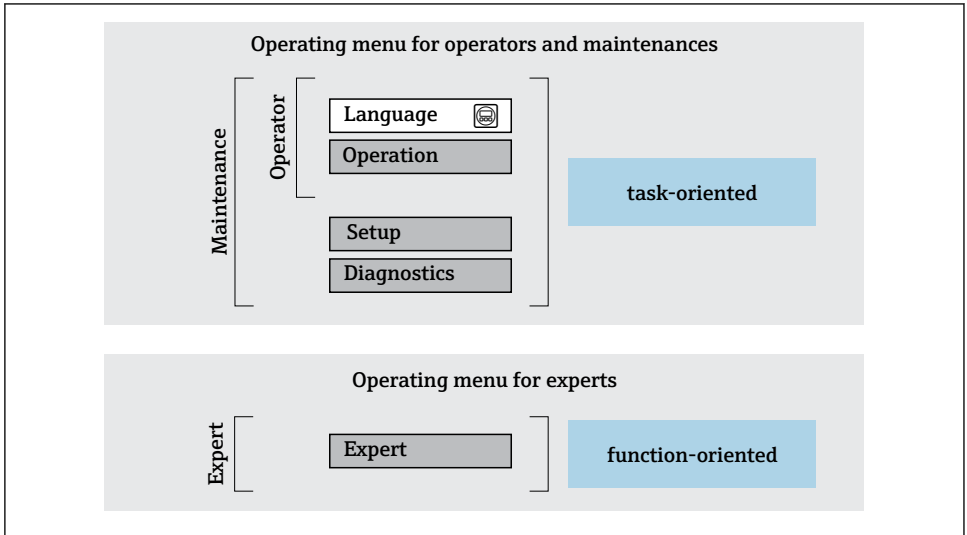

A0014058-EN

 7 Schematic structure of the operating menu

6.2.2 Operating philosophy

The individual parts of the operating menu are assigned to certain user roles (operator, maintenance etc.). Each user role contains typical tasks within the device lifecycle.



For detailed information on the operating philosophy, see the Operating Instructions for the device.

6.3 Access to the operating menu via the web browser

6.3.1 Function range

Thanks to the integrated Web server, the device can be operated and configured via a Web browser and via a service interface (CDI-RJ45). In addition to the measured values, status information on the device is also displayed and allows the user to monitor the status of the device. Furthermore the device data can be managed and the network parameters can be configured.



For additional information on the Web server, refer to the Special Documentation for the device

6.3.2 Prerequisites

Computer hardware

Interface	The computer must have an RJ45 interface.
Connection	Standard Ethernet cable with RJ45 connector.
Screen	Recommended size: $\geq 12"$ (depends on the screen resolution)

Computer software

Recommended operating systems	<p>Microsoft Windows 7 or higher.</p> <p> Microsoft Windows XP is supported.</p>
Web browsers supported	<ul style="list-style-type: none"> ▪ Microsoft Internet Explorer 8 or higher ▪ Microsoft Edge ▪ Mozilla Firefox ▪ Google Chrome ▪ Safari



Computer settings

User rights	Appropriate user rights (e.g. administrator rights) for TCP/IP and proxy server settings are necessary (for adjusting the IP address, subnet mask etc.).
Proxy server settings of the Web browser	The Web browser setting <i>Use a Proxy Server for Your LAN</i> must be deselected .
JavaScript	<p>JavaScript must be enabled.</p> <p> If JavaScript cannot be enabled: enter <code>http://XXX.XXX.X.XXX/basic.html</code> in the address line of the Web browser, e.g. <code>http://192.168.1.212/basic.html</code>. A fully functional but simplified version of the operating menu structure starts in the Web browser.</p>
Network connections	<p>Only the active network connections to the measuring device should be used.</p> <p>Switch off all other network connections such as WLAN.</p>

 In the event of connection problems:

Measuring device: Via CDI-RJ45 service interface

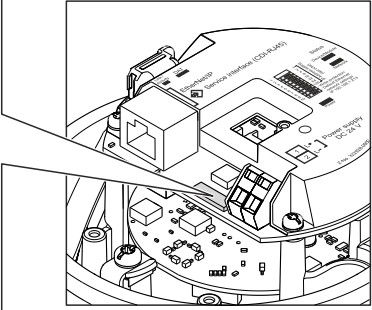
Device	CDI-RJ45 service interface
Measuring device	The measuring device has an RJ45 interface.
Web server	Web server must be enabled; factory setting: ON

Device	CDI-RJ45 service interface																						
IP address	<p>If the IP address of the device is not known, communication with the Web server can be established via the default IP address 192.168.1.212.</p> <p>The DHCP function is enabled in the device at the factory, i.e. the device expects an IP address to be assigned by the network. This function can be disabled and the device can be set to the default IP address 192.168.1.212: set DIP switch No. 10 from OFF → ON.</p> <div data-bbox="427 347 696 753" style="border: 1px solid black; padding: 5px;"> <table style="width: 100%; border-collapse: collapse;"> <thead> <tr> <th style="width: 50%; text-align: left;">OFF</th> <th style="width: 50%; text-align: right;">ON</th> </tr> </thead> <tbody> <tr> <td style="text-align: center;">1</td> <td style="text-align: center;">1</td> </tr> <tr> <td style="text-align: center;">2</td> <td style="text-align: center;">2</td> </tr> <tr> <td style="text-align: center;">3</td> <td style="text-align: center;">4</td> </tr> <tr> <td style="text-align: center;">4</td> <td style="text-align: center;">8</td> </tr> <tr> <td style="text-align: center;">5</td> <td style="text-align: center;">16</td> </tr> <tr> <td style="text-align: center;">6</td> <td style="text-align: center;">32</td> </tr> <tr> <td style="text-align: center;">7</td> <td style="text-align: center;">64</td> </tr> <tr> <td style="text-align: center;">8</td> <td style="text-align: center;">128</td> </tr> <tr> <td style="text-align: center;">9</td> <td style="text-align: center;">- Write protection</td> </tr> <tr> <td style="text-align: center;">10</td> <td style="text-align: center;">- Default Ethernet network settings IP 192.168.1.212</td> </tr> </tbody> </table> <p style="text-align: right; margin-top: 10px;">IP Address setting (last octet)</p> </div> <div data-bbox="696 395 1066 705" style="border: 1px solid black; padding: 5px;">  </div> <div data-bbox="1016 769 1066 785" style="text-align: right; font-size: small;">A0017965</div> <p style="margin-top: 20px;">  <ul style="list-style-type: none"> ▪ Once the DIP switch has been activated, the device must be restarted before the device uses the default IP address. ▪ If the default IP address is used (DIP switch No. 10 = ON), there is no connection to the EtherNet/IP network. </p>	OFF	ON	1	1	2	2	3	4	4	8	5	16	6	32	7	64	8	128	9	- Write protection	10	- Default Ethernet network settings IP 192.168.1.212
OFF	ON																						
1	1																						
2	2																						
3	4																						
4	8																						
5	16																						
6	32																						
7	64																						
8	128																						
9	- Write protection																						
10	- Default Ethernet network settings IP 192.168.1.212																						

6.3.3 Establishing a connection

Via service interface (CDI-RJ45)

Preparing the measuring device

Configuring the Internet protocol of the computer

The IP address can be assigned to the measuring device in a variety of ways:

- **Dynamic Host Configuration Protocol (DHCP), factory setting:**
The IP address is automatically assigned to the measuring device by the automation system (DHCP server).
- **Hardware addressing:**
The IP address is set via DIP switches .
- **Software addressing:**
The IP address is entered via the **IP address** parameter .
- **DIP switch for "Default IP address":**
To establish the network connection via the service interface (CDI-RJ45); the fixed IP address 192.168.1.212 is used .

The measuring device works with the Dynamic Host Configuration Protocol (DHCP), on leaving the factory, i.e. the IP address of the measuring device is automatically assigned by the automation system (DHCP server).

To establish a network connection via the service interface (CDI-RJ45): the "Default IP address" DIP switch must be set to **ON**. The measuring device then has the fixed IP address: 192.168.1.212. This address can now be used to establish the network connection.

1. Via DIP switch 2, activate the default IP address 192.168.1.212: .
2. Switch on the measuring device.
3. Connect to the computer using a cable .
4. If a 2nd network card is not used, close all the applications on the notebook.
 - ↳ Applications requiring Internet or a network, such as e-mail, SAP applications, Internet or Windows Explorer.
5. Close any open Internet browsers.
6. Configure the properties of the Internet protocol (TCP/IP) as defined in the table:

IP address	192.168.1.XXX; for XXX all numerical sequences except: 0, 212 and 255 → e.g. 192.168.1.213
Subnet mask	255.255.255.0
Default gateway	192.168.1.212 or leave cells empty

Starting the Web browser

1. Start the Web browser on the computer.
2. Enter the IP address of the Web server in the address line of the Web browser: 192.168.1.212
 - ↳ The login page appears.



If a login page does not appear, or if the page is incomplete, see the Special Documentation for the Web server

6.3.4 Logging on

Access code	0000 (factory setting); can be changed by customer
--------------------	--

6.3.5 User interface

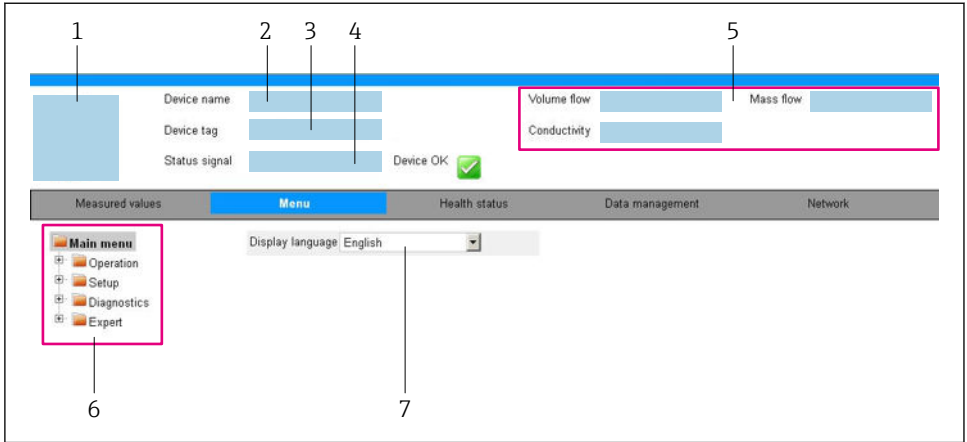

A0032879

- 1 *Picture of device*
- 2 *Device name*
- 3 *Device tag*
- 4 *Status signal*
- 5 *Current measured values*
- 6 *Navigation area*
- 7 *Local display language*

Header

The following information appears in the header:

- Device tag
- Device status with status signal
- Current measured values

Function row

Functions	Meaning
Measured values	Displays the measured values of the measuring device
Menu	<ul style="list-style-type: none"> ■ Access to the operating menu from the measuring device ■ The structure of the operating menu is the same as for the operating tools  For detailed information on the structure of the operating menu, see the Operating Instructions for the measuring device
Device status	Displays the diagnostic messages currently pending, listed in order of priority

Functions	Meaning
Data management	Data exchange between PC and measuring device: <ul style="list-style-type: none"> ■ Device configuration: <ul style="list-style-type: none"> ■ Load settings from the device (XML format, save configuration) ■ Save settings to the device (XML format, restore configuration) ■ Logbook - Export Event logbook (.csv file) ■ Documents - Export documents: <ul style="list-style-type: none"> ■ Export backup data record (.csv file, create documentation of the measuring point configuration) ■ Verification report (PDF file, only available with the "Heartbeat Verification" application package) ■ File for system integration - If using fieldbuses, upload device drivers for system integration from the measuring device: EtherNet/IP: EDS file
Network configuration	Configuration and checking of all the parameters required for establishing the connection to the measuring device: <ul style="list-style-type: none"> ■ Network settings (e.g. IP address, MAC address) ■ Device information (e.g. serial number, firmware version)
Logout	End the operation and call up the login page

Navigation area

If a function is selected in the function bar, the submenus of the function open in the navigation area. The user can now navigate through the menu structure.

Working area

Depending on the selected function and the related submenus, various actions can be performed in this area:

- Configuring parameters
- Reading measured values
- Calling up help text
- Starting an upload/download

6.3.6 Disabling the Web server

The Web server of the measuring device can be switched on and off as required using the **Web server functionality** parameter.

Navigation

"Expert" menu → Communication → Web server

Parameter overview with brief description

Parameter	Description	Selection
Web server functionality	Switch the Web server on and off.	<ul style="list-style-type: none"> ■ Off ■ HTML Off ■ On

Function scope of the "Web server functionality" parameter

Option	Description
Off	<ul style="list-style-type: none"> ▪ The web server is completely disabled. ▪ Port 80 is locked.
On	<ul style="list-style-type: none"> ▪ The complete functionality of the web server is available. ▪ JavaScript is used. ▪ The password is transferred in an encrypted state. ▪ Any change to the password is also transferred in an encrypted state.

Enabling the Web server

If the Web server is disabled it can only be re-enabled with the **Web server functionality** parameter via the following operating options:

- Via Bedientool "FieldCare"
- Via "DeviceCare" operating tool

6.3.7 Logging out



Before logging out, perform a data backup via the **Data management** function (upload configuration from device) if necessary.

1. Select the **Logout** entry in the function row.
 - ↳ The home page with the Login box appears.

2. Close the Web browser.

3. If no longer needed:

Reset modified properties of the Internet protocol (TCP/IP) → 23.



If communication with the Web server was established via the default IP address 192.168.1.212, DIP switch No. 10 must be reset (from **ON** → **OFF**). Afterwards, the IP address of the device is active again for network communication.

6.4 Access to the operating menu via the operating tool



The operating menu can also be accessed via the FieldCare and DeviceCare operating tools. See the Operating Instructions for the device.

7 System integration



A detailed description of how to integrate the device into an automation system (e.g. from Rockwell Automation) is available as a separate document: www.endress.com → Select country → Automation → Digital communication → Fieldbus device integration → EtherNet/IP

8 Commissioning

8.1 Function check

Before commissioning the measuring device:

- ▶ Make sure that the post-installation and post-connection checks have been performed.
 - "Post-installation check" checklist
 - "Post-connection check" checklist →  19

8.2 Setting the operating language

Factory setting: English or ordered local language

The operating language can be set in FieldCare, DeviceCare or via the Web server: Operation
→ Display language

8.3 Configuring the measuring device

The **Setup** menu with its submenus enable fast commissioning of the measuring device. The submenus contain all the parameters required for configuration, such as parameters for measurement or communication.



The submenus available in the particular device can vary on account of the device version (e.g. sensor).

Submenu	Meaning
Medium selection	Define the medium
Output conditioning	Define the output conditioning
System units	Configure the units for all measured values
Communication	Configure the digital communication interface
Display	Configure the measured value display
Low flow cut off	Set the low flow cut off
Partially filled pipe detection	Configure partial and empty pipe detection

8.4 Protecting settings from unauthorized access

The following write protection options exist in order to protect the configuration of the measuring device from unintentional modification:

- Protect access to parameters via access code
- Protect access to local operation via key locking
- Protect access to measuring device via write protection switch



For detailed information on protecting the settings against unauthorized access, see the Operating Instructions for the device.

9 Diagnostic information

Any faults detected by the measuring device are displayed as a diagnostic message in the operating tool once the connection has been established and on the home page of the web browser once the user has logged on.

Remedial measures are provided for each diagnostic message to ensure that problems can be rectified quickly.

- In the Web browser: Remedial measures are displayed in red on the home page next to the diagnostic message → 25.
- In FieldCare: Remedial measures are displayed on the home page in a separate field below the diagnostic message: see the Operating Instructions for the device

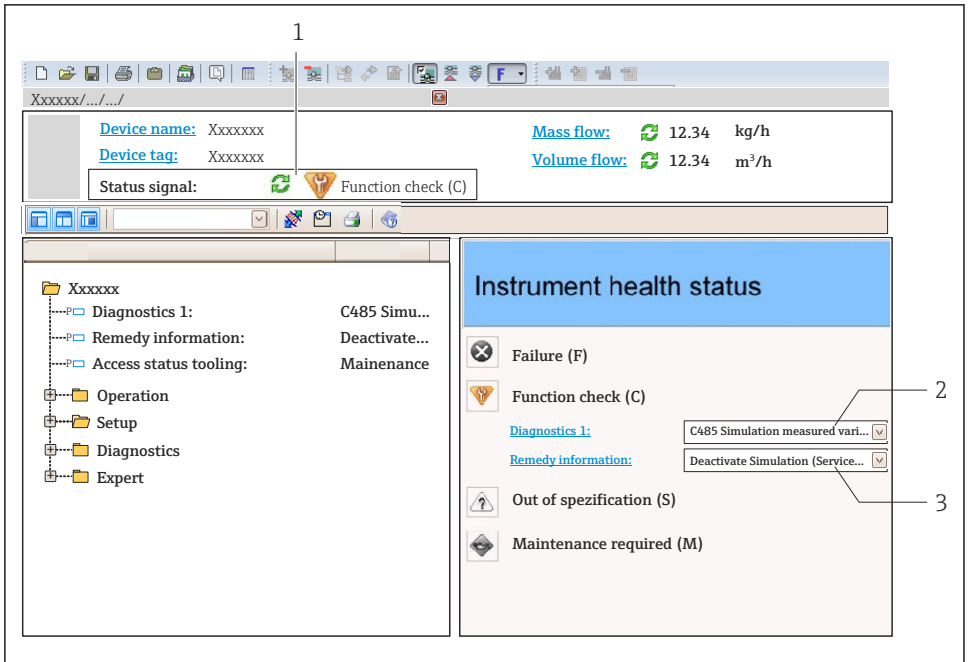

A.0021799-EN

- 1 Status area with status signal
- 2 Diagnostic information
- 3 Remedy information with Service ID

► Perform the remedial measure displayed.



71689987

www.addresses.endress.com
