

# Brief Operating Instructions

## Rxn-46 Raman spectroscopic probe



These instructions are Brief Operating Instructions. They are not a substitute for the Operating Instructions pertaining to the device.



# Table of Contents

<b>1</b>	<b>About this document .....</b>	<b>5</b>
1.1	Disclaimer .....	5
1.2	Warnings.....	5
1.3	Symbols.....	6
1.4	U.S. export compliance .....	6
<b>2</b>	<b>Basic safety instructions .....</b>	<b>7</b>
2.1	Requirements for personnel .....	7
2.2	Designated use .....	7
2.3	Workplace safety .....	7
2.4	Operational safety .....	8
2.5	Laser safety.....	8
2.6	Service safety.....	9
2.7	Important safeguards .....	9
2.8	Product safety.....	9
<b>3</b>	<b>Product description.....</b>	<b>11</b>
3.1	Rxn-46 probe.....	11
3.2	Hardware and accessories.....	11
<b>4</b>	<b>Incoming product acceptance and product identification.....</b>	<b>13</b>
4.1	Incoming acceptance.....	13
4.2	Product identification .....	13
4.3	Scope of delivery .....	14
<b>5</b>	<b>Probe and fiber optic connection.....</b>	<b>15</b>
5.1	Electro-optical fiber cable .....	15
5.2	Fiber cable assembly .....	15
5.3	Fiber optic cable handling.....	16
<b>6</b>	<b>Installation .....</b>	<b>18</b>
6.1	Analyzer compatibility.....	18
6.2	Connection to the Ambr® analysis module .....	18
6.3	Connection to Biostat STR® single-use bioreactors .....	19
6.4	Connection to the Biostat STR® single-use port .....	19
<b>7</b>	<b>Commissioning.....</b>	<b>20</b>
7.1	Receipt of probe .....	20
7.2	Probe calibration and verification .....	20
<b>8</b>	<b>Operation.....</b>	<b>21</b>
8.1	Rxn-46 probe.....	21

---



8.2	Integration into Ambr® software .....	21
8.3	Compatibility with Biostat STR® .....	21
<b>9</b>	<b>Diagnostics and troubleshooting .....</b>	<b>22</b>

# 1 About this document





## 1.1 Disclaimer

These instructions are Brief Operating Instructions; they do not replace the Operating Instructions included in the scope of supply.

## 1.2 Warnings

Structure of Information	Meaning
<p> <b>WARNING</b></p> <p><b>Causes (/consequences)</b> Consequences of non-compliance (if applicable) ▶ Corrective action</p>	<p>This symbol alerts you to a dangerous situation. Failure to avoid the dangerous situation can result in a fatal or serious injury.</p>
<p> <b>CAUTION</b></p> <p><b>Causes (/consequences)</b> Consequences of non-compliance (if applicable) ▶ Corrective action</p>	<p>This symbol alerts you to a dangerous situation. Failure to avoid this situation can result in minor or more serious injuries.</p>
<p><b>NOTICE</b></p> <p><b>Cause/situation</b> Consequences of non-compliance (if applicable) ▶ Action/note</p>	<p>This symbol alerts you to situations which may result in damage to property.</p>

## 1.3 Symbols

Symbol	Description
	The Laser Radiation symbol is used to alert the user to the danger of exposure to hazardous visible laser radiation when using the system.
	The High Voltage symbol that alerts people to the presence of electric potential large enough to cause injury or damage. In certain industries, high voltage refers to voltage above a certain threshold. Equipment and conductors that carry high voltage warrant special safety requirements and procedures.
	The WEEE symbol indicates that the product should not be discarded as unsorted waste but must be sent to separate collection facilities for recovery and recycling.
	The CE Marking indicates conformity with health, safety, and environmental protection standards for products sold within the European Economic Area (EEA).

## 1.4 U.S. export compliance

The policy of Endress+Hauser is strict compliance with U.S. export control laws as detailed in the website of the [Bureau of Industry and Security](#) at the U.S. Department of Commerce.

## 2 Basic safety instructions

### 2.1 Requirements for personnel

- Installation, commissioning, operation, and maintenance of the measuring system may be carried out only by specially trained technical personnel.
- The technical personnel must be authorized by the plant operator to carry out the specified activities.
- The technical personnel must have read and understood these Operating Instructions and must follow the instructions contained herein.
- The facility must designate a laser safety officer who ensures staff are trained on all Class 3B laser operating and safety procedures.
- Faults at the measuring point may only be rectified by properly authorized and trained personnel. Repairs not described in this document must be carried out only directly at the manufacturer's site or by the service organization.

### 2.2 Designated use

The Rxn-46 Raman spectroscopic probe is designed for laboratory and process analysis of liquids.

Recommended cell culture applications include: glucose, lactate, amino acids, cell density, titer, and more.

Use of the device for any purpose other than that described poses a threat to the safety of people and of the entire measuring system and invalidates any warranty.

### 2.3 Workplace safety

As the user, you are responsible for complying with the following safety conditions:

- Installation guidelines
- Local standards and regulations for electromagnetic compatibility

The product has been tested for electromagnetic compatibility in accordance with the applicable international standards for industrial applications.

The electromagnetic compatibility indicated applies only to a product that has been properly connected to the analyzer.

## 2.4 Operational safety

Before commissioning the entire measuring point:

1. Verify that all connections are correct.
2. Ensure that electro-optical cables are undamaged.
3. Ensure fluid level is sufficient for probe or optics immersion (if applicable).
4. Do not operate damaged products, and protect them against unintentional operation.
5. Label damaged products as defective.

During operation:

1. If faults cannot be rectified, products must be taken out of service and protected against unintentional operation.
2. When working with laser devices, always follow all local laser safety protocols which may include the use of personal protective equipment and limiting device access to authorized users.

## 2.5 Laser safety

The Raman Rxn analyzers use Class 3B lasers as defined in the following:

- [American National Standards Institute](#) (ANSI) Z136.1, American National Standard for Safe Use of Lasers
- [International Electrotechnical Commission](#) (IEC) 60825-1, Safety of Laser Products – Part 1



### Laser radiation

- ▶ Avoid exposure to beam
- ▶ Class 3B laser product



### Laser beams can cause ignition of certain substances such as volatile organic compounds.

The two possible mechanisms for ignition are direct heating of the sample to a point causing ignition and the heating of a contaminant (such as dusts) to a critical point leading to ignition of the sample.

The laser configuration presents further safety concerns because the radiation is nearly invisible. Always be aware of the initial direction and possible scattering paths of the laser. The use of laser safety glasses with OD3 or greater is highly recommended for 532 nm and 785 nm excitation wavelengths and OD4 or greater for a 993 nm excitation wavelength.



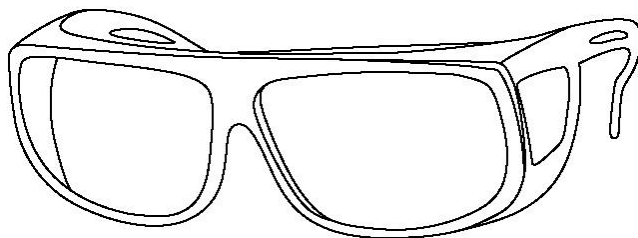

A0048421

*Figure 1. Laser safety glasses*

For more assistance with taking appropriate precautions and setting the proper controls when dealing with lasers and their hazards, refer to the most current version of ANSI Z136.1 or IEC 60825-14.

## **2.6 Service safety**

Follow your company's safety instructions when removing a process probe from the process interface for service. Always wear proper protective equipment when servicing the equipment.

## **2.7 Important safeguards**

- Do not use the Rxn-46 probe for anything other than its intended use.
- Do not look directly into the laser beam.
- Do not point the laser at a mirrored or shiny surface, or a surface that may cause diffuse reflections. The reflected beam is as harmful as the direct beam.
- Do not leave attached and unused probes uncapped or unblocked.
- Always use a laser beam block to avoid inadvertent scatter of laser radiation.

## **2.8 Product safety**

This product is designed to meet all current safety requirements, has been tested and shipped from the factory in a safe operating condition. The relevant regulations and international standards have been observed. Devices connected to an analyzer must also comply with the applicable analyzer safety standards.

Endress+Hauser Raman spectroscopy systems incorporate the following safety features to conform to the United States Government requirements [21 Code of Federal Regulations \(CFR\) Chapter 1, Subchapter J](#) as administered by the [Center for Devices and Radiological Health \(CDRH\)](#) and IEC 60825-1 as administered by the [International Electrotechnical Commission](#).

## 2.8.1 CDRH and IEC compliance

Endress+Hauser Raman analyzers are certified by Endress+Hauser to meet CDRH requirements, as well as IEC 60825-1 safety standards for international use.

Endress+Hauser Raman analyzers have been registered with the CDRH. Any unauthorized modifications to an existing Raman Rxn analyzer or accessory may result in hazardous radiation exposure. Such modifications may result in the system being no longer in conformance with federal requirements as certified by Endress+Hauser.

## 2.8.2 Laser safety interlock

The Rxn-46 probe, as installed, forms part of the interlock circuit. The interlock circuit is a low-current electrical loop. If the fiber cable is severed, the laser will turn off within milliseconds of the breakage.

### NOTICE

**Permanent damage may result if cables are not routed appropriately.**

- ▶ Handle probes and cables with care, ensuring they are not kinked.
- ▶ Install fiber cables with a minimum bend radius according to the *Raman fiber-optic cable Technical Information (TI01641C)*.

The interlock connector in the fiber cable must be plugged into the interlock socket on a Raman Rxn analyzer, and is automatically connected when the fiber optic cable process connector is plugged into the Rxn-46 probe. When there is potential for the laser to be energized, the laser interlock indicator light on the probe body is illuminated.

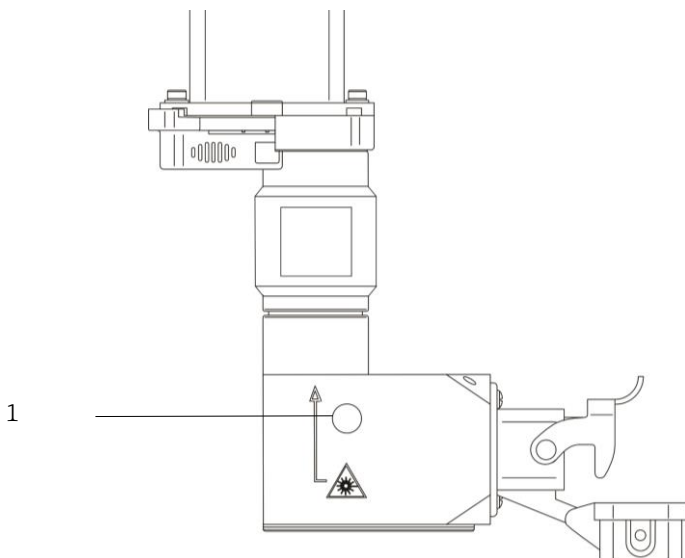

A0049104

Figure 2. Location of laser interlock indicator light (1)

## 3 Product description

### 3.1 Rxn-46 probe

The Rxn-46 Raman spectroscopic probe, powered by Kaiser Raman technology, is an adaptation of the standard Endress+Hauser Rxn-45 bioprocess probe. It has been optimized to fit the BioPAT® Spectro platform by Sartorius. This union of platforms offers an ideal interface to high throughput development through single-use commercial manufacturing. Integrating Endress+Hauser Raman spectroscopy into Ambr® multi-parallel bioreactors enables quality by design (QbD) methods that are scalable to all sizes of Biostat STR® single-use bioreactors.

The same Rxn-46 probe design is used for Ambr® 15, Ambr® 250, and Biostat STR® bioreactors. This collaboration enables non-contact Raman collection, so no cleaning, sterilization, or frequent probe maintenance is required. By providing fast, reliable, and accurate measurement of key process variables from lab-to-process, the Rxn-46 probe empowers bioprocessing companies to easily scale-up and scale-out from development to cGMP while complying with strict quality standards.

The Rxn-46 probe is compatible with the following Endress+Hauser Raman Rxn analyzers operating at 785 nm:

- Ambr®: Raman Rxn2 single-channel analyzer
- Biostat STR®: Raman Rxn2 or Rxn4 single or four-channel analyzers

### 3.2 Hardware and accessories

#### 3.2.1 Standard hardware and accessories

- Standard Rxn-46 probe hardware and accessories include the following:
- Rxn-46 probe
- Rxn-46 probe calibration and verification kit

The Rxn-46 probe connects to the Raman Rxn analyzer via a fiber optic cable that is sold separately. For additional information about fiber optic cable options, see Probe and fiber optic connection → .

#### 3.2.2 Additional requirements for Ambr® 15 or Ambr® 250

For Rxn-46 probe installation with Ambr® 15 or Ambr® 250, the following additional parts and compatible analyzers are required:

- Light shield for use with the Ambr® platform (sold by Endress+Hauser)
- Benchtop Raman Rxn2 single channel analyzer with Raman RunTime 6.2.2+ embedded software
- Touch screen starter kit for benchtop analyzers

### 3.2.3 Additional requirements for Biostat STR®

For Rxn-46 probe installation with Biostat STR®, the following additional parts and compatible analyzers are required:

- Biostat STR® flange support, bag connector and rail holder (sold by Sartorius)
- Raman Rxn2 or Raman Rxn4 single or four-channel analyzers with Raman RunTime 6.2.2+ embedded software
- Suitable SIMCA-QPp predictor license for the number of capable analyzer channels
- Touch screen starter kit

Non-embedded Raman Rxn analyzers may require additional hardware and software updates to be compatible with the Rxn-46 probe.

## 4 Incoming product acceptance and product identification

### 4.1 Incoming acceptance

1. Verify that the packaging is undamaged. Notify the supplier of any damage to the packaging. Keep the damaged packaging until the issue has been resolved.
2. Verify that the contents are undamaged. Notify the supplier of any damage to the delivery contents. Keep the damaged goods until the issue has been resolved.
3. Check that the delivery is complete and nothing is missing. Compare the shipping documents with your order.
4. Pack the product for storage and transportation in such a way that it is protected against impact and moisture. The original packaging offers the best protection. Make sure to comply with the permitted ambient conditions.

If you have any questions, contact your supplier or your local sales center.

#### NOTICE

Probe may be damaged during transport if packaged inadequately.

### 4.2 Product identification

#### 4.2.1 Label

At a minimum, the probe/tag is labeled with the following information:

- Endress+Hauser branding
- Product identification (e.g., Rxn-46)
- Serial number

Where size allows, the following information is also included:

- Extended order code
- Manufacturer information
- Key functional aspects of the probe (e.g., material, wavelength, focal depth)
- Safety warnings and certification information, as applicable

Compare the information on the label/tag with the order.

#### 4.2.2 Manufacturer address

Endress+Hauser  
371 Parkland Plaza  
Ann Arbor, MI 48103 USA

### 4.3 Scope of delivery

The scope of delivery comprises:

- Rxn-46 probe
- *Rxn-46 Raman spectroscopic probe Operating Instructions* manual
- Rxn-46 Certificate of Product Performance
- Local declarations of conformity, if applicable
- Rxn-46 probe accessories, if applicable
- Material certificates, if applicable
- Rxn-46 Calibration and Verification Kit

If you have any queries, please contact your supplier or local sales center.

## 5 Probe and fiber optic connection

The Rxn-46 probe connects to the Raman Rxn analyzer via one of the following:

- **Ambr®**: electro-optical (EO) to EO fiber cable
- **Biostat STR®**: EO to EO fiber cable or fiber channel (FC) to EO fiber converter(s) for non-embedded systems

Fiber cable is sold separately and is available in 5 m (16.4 ft) increments up to 200 m (656.2 ft), with the length limited by the application.

Refer to the applicable Raman Rxn analyzer operating instructions for analyzer connection details.

### 5.1 Electro-optical fiber cable

The EO-to-EO fiber cable connects the Rxn-46 probe to the embedded analyzer with a single, robust connector that contains the excitation and collection fiber optics as well as an electrical laser interlock.

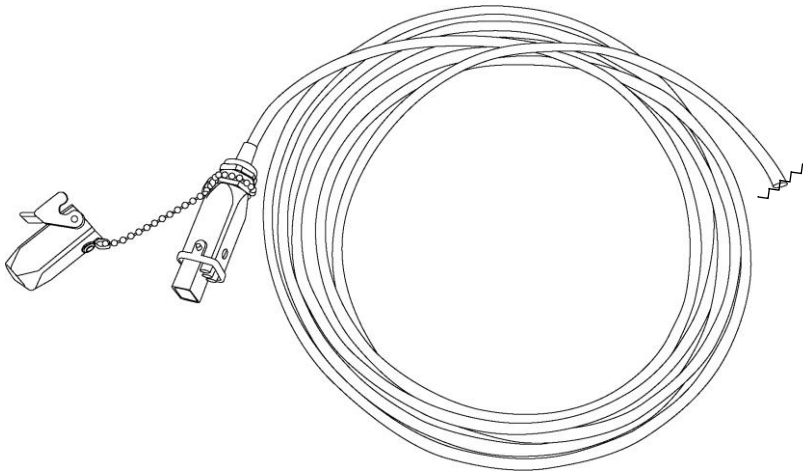

A0048938

Figure 3. EO fiber cable showing connector for analyzer

### 5.2 Fiber cable assembly

The FC cable assembly connects the Rxn-46 probe to the non-embedded through the following connections:

- Electrical interlock connector
- Yellow (YE) excitation fiber for laser output
- Red (RD) collection fiber for spectrograph input

An FC to EO fiber converter connects the FC cable to the Rxn-46 probe.

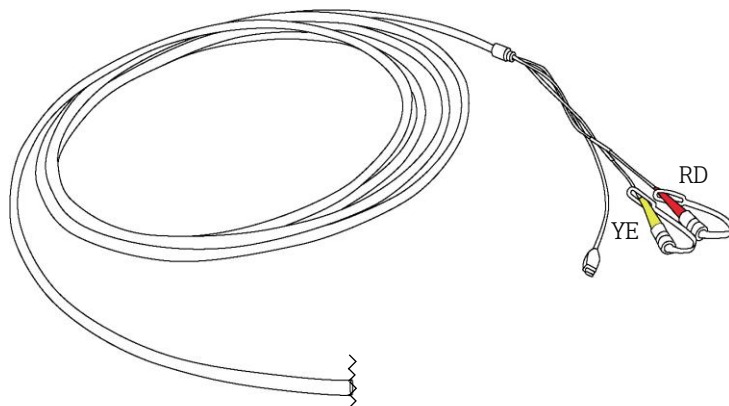

A0048939

Figure 4. FC cable assembly showing connector for analyzer

### 5.3 Fiber optic cable handling

If it is necessary to disconnect and re-connect the fiber optic cable from the probe, follow the steps below.

#### NOTICE

**For Rxn-46 probe connections to Ambr<sup>®</sup>, fiber optic cables should NOT be disconnected once installed and verified by Sartorius service.**

1. If the Rxn-46 probe is currently attached to a Raman Rxn analyzer, turn the laser OFF or power OFF the analyzer before probe installation.
2. Disconnect the fiber optic cable from the Rxn-46 probe.
  - Unlatch the connector clip.
  - Grasp the gray part of the EO process connector and, with your other hand, pull straight down to disconnect the fiber optic cable.
3. Re-connect the fiber optic cable to the Rxn-46 probe.
  - Open the spring-loaded fiber connector cap at the base of the Rxn-46 probe.
  - Insert the process connector into the base of the probe and push up until secure.
  - Re-latch the connector clip.
4. When ready to use the analyzer and probe, power ON the laser and analyzer.
5. After a minute, verify that the laser interlock indicator is illuminated.



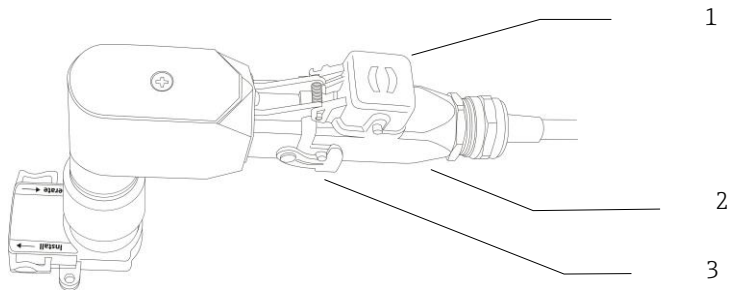

A0049105



*Figure 5. Fiber optic cable connection*

#	Description
1	Spring-loaded fiber connector cap
2	Process connector
3	Connector clip

## 6 Installation

The Rxn-46 probe only interfaces to Sartorius's BioPAT® Spectro compatible parts.

During installation, standard eye and skin safety precautions for Class 3B laser products (as per EN 60825/IEC 60825-14) should be observed. Additionally, observe the following:

 <b>WARNING</b>	<p><b>Standard precautions for laser products should be observed.</b></p> <ul style="list-style-type: none"> <li>▶ When not installed in a sample chamber, probes should always be capped, pointed away from people, and pointed toward a diffuse target.</li> </ul>
 <b>CAUTION</b>	<p><b>If stray light is allowed to enter an unused probe, it will interfere with data collected from a used probe and may cause calibration failure or measurement errors.</b></p> <ul style="list-style-type: none"> <li>▶ Unused probes should ALWAYS be capped to prevent stray light from entering the probe.</li> </ul>
<b>NOTICE</b>	<p><b>When installing the probe <i>in situ</i>, the user must ensure that there is strain relief at the installation location which complies with fiber bend radius specifications.</b></p>

### 6.1 Analyzer compatibility

The Rxn-46 probe is compatible with the Endress+Hauser Raman Rxn analyzers below operating at 785 nm.

- Ambr® 15 and Ambr® 250: Raman Rxn2 analyzer, single-channel; benchtop
- Biostat STR®: Raman Rxn2 or Rxn4 analyzers, up to four channels, benchtop or mobile wheeled cart (Raman Rxn2), rack mounted or NEMA 4x enclosure (Raman Rxn4)

### 6.2 Connection to the Ambr® analysis module

Sartorius is responsible for Rxn-46 probe installation with Ambr®, including all hardware and software connections. Endress+Hauser cannot provide support regarding initial installation, disconnection or reconnection of Rxn-46 probes to Ambr®. This connection is intended to be permanent. Consult Sartorius for all installation and service needs for Ambr® instances of BioPAT Spectro®.

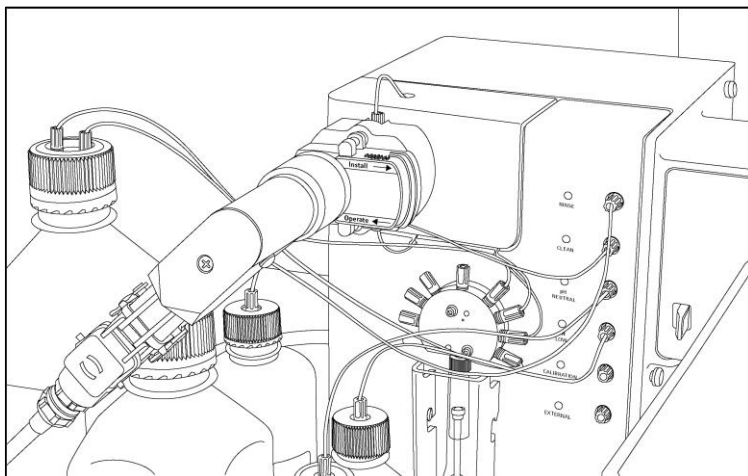

A0049106

Figure 6. The Rxn-46 probe interface to Ambr® 15 and Ambr® 250

### 6.3 Connection to Biostat STR® single-use bioreactors

For connection to Biostat STR® single-use bioreactors, Endress+Hauser may provide consultation about probe use and maintenance. However, Sartorius should be the first point of contact for initial Rxn-46 probe installation with Biostat STR® for BioPAT® Spectro and technical service matters thereafter.

### 6.4 Connection to the Biostat STR® single-use port

Connection to Biostat STR® single-use bags may be performed by users but should be under the direction of Sartorius for the first installation. Refer to Sartorius BioPAT® Spectro Installation Instructions, document No. 1000104283.

## 7 Commissioning

The Rxn-46 probe is delivered ready to connect to the Raman Rxn analyzer. No additional alignment or adjustment to the probe is required. Follow the instructions below to commission the probe for use.

### 7.1 Receipt of probe

Perform the steps for incoming product acceptance described in Incoming Acceptance → .

### 7.2 Probe calibration and verification

For Rxn-46 probe installations with Ambr® 15 or Ambr® 250, Endress+Hauser service personnel will perform the first analyzer calibration, probe calibration, and probe verification before turning the analyzer and probe over to Sartorius for connection to the Ambr® analysis module and software.

Raman Rxn analyzer operating instructions are available in the Downloads area of the Endress+Hauser website: <https://endress.com/downloads>.

Access calibration and verification instructions within the [Raman Rxn-46 calibration and verification kit](#).

## 8 Operation

### 8.1 Rxn-46 probe

The Endress+Hauser Rxn-46 probe is an adaptation of the standard Endress+Hauser Rxn-45 bioprocess probe that has been optimized to fit the BioPAT® Spectro platform by Sartorius.

The Rxn 46 probe is compatible with the Endress+Hauser Raman Rxn analyzers operating at 785 nm, listed below:

- **Ambr®**: Raman Rxn2 single channel analyzer
- **Biostat STR®**: Raman Rxn2 or Rxn4 single or four channel analyzers

See *Integration into Ambr® software* and *Compatibility with Biostat STR®* →  for more information.

### 8.2 Integration into Ambr® software

The Endress+Hauser Raman Rxn2 embedded single channel analyzer is compatible with Ambr® 15 and Ambr® 250 for Raman model building and Raman monitoring of high throughput cell culture process development. The two systems work together as follows:

- Software controls for the Raman Rxn2 single channel embedded analyzer are integrated into the Ambr® software.
- Ambr® set-ups make full-time use of one Rxn-46 probe to repeatedly collect spectra from each Ambr®15 or Ambr® 250 vessel.
- Ambr® software controls the Raman spectra data collection, and consolidates and stores all the data.
- Data from integrated at-line analyzers can be automatically aligned with the spectral data, or offline data can be added manually during the run.
- After the run, a consolidated and contextualized data file can be exported from the Ambr® software, ready for model building in SIMCA®.

### 8.3 Compatibility with Biostat STR®

Endress+Hauser Raman Rxn2 and Rxn4 analyzers (single or four channel) with 785 nm wavelength are available for use with Biostat STR®. These systems work together as follows:

- The Rxn-46 probe attaches to the BioPAT® Spectro single-use port. Ports come ready-to-use and fully qualified.
- Probe connection to the port is fast and simple.
- Raman collection requires no additional light blocking.
- Raman RunTime software embedded in the analyzer initiates data collection from Biostat STR® 50 L to 2000 L single-use bioreactors.

## 9 Diagnostics and troubleshooting

Refer to the table below when troubleshooting issues with the Rxn-46 probe. If the probe is damaged, turn off the laser before troubleshooting. Contact your service representative as needed for assistance.

Symptom		Possible Cause	Action
1	Substantial reduction in signal or signal-to-noise ratio	Probe slider not securely in 'Operate' position.	Move slider to 'Install' and then back to 'Operate.'
2	Complete loss of signal while laser is powered and laser interlock indicator is lit	Broken fiber without interlock wire breakage	Ensure all fiber connections are secure. Verify condition of fiber and contact your service representative for replacement.
		Cracked but intact fiber	Verify condition of fiber and contact your service representative for replacement.
3	Laser interlock indicator on probe is not lit	Damaged fiber assembly	Look for signs of breakage in fiber. Contact your service representative for replacement.
		Fiber cable EO connector not secured/latched	Ensure EO connector is properly connected and latched at the probe (if applicable) and at the analyzer.
		Remote interlock connector disconnected	Ensure the twist-lock remote interlock connector at the rear of analyzer (next to fiber EO connector) is connected.
4	Decreased laser power or collection efficiency	Contaminated fiber connection	Carefully clean the fiber ends at the probe. Refer to the applicable Raman Rxn analyzer operating instructions for cleaning instructions and steps for starting up a new probe.
5	Laser interlock on analyzer causes laser to shut down	Laser interlock activated	Check for fiber breakage on all connected fiber optic cable channels and ensure remote interlock connectors are in place on each channel.
6	Other unexplained negative performance of the probe	Probe slider not moving properly between Install and Operate positions	Contact your service representative to return the damaged product.
		Physical damage to probe	

[www.addresses.endress.com](http://www.addresses.endress.com)

---