

# Temperature measurement

## Thermometers and transmitters for the process industry

Temperature measurement



# Endress+Hauser – Your partner

## Table of contents

	<b>Industries</b>
4	Oil & Gas
6	Chemicals
8	Mining, Minerals & Metals
10	Food & Beverages
12	Life Sciences
14	Water & Wastewater
16	Power & Energy
18	<b>Thermometer design</b>
20	<b>Sensor technology</b>
	<b>Products</b>
22	Temperature transmitters
26	Highlight: iTEMP TMT31
28	Thermowells
29	Product overview thermometers
30	Cable probes
31	Compact thermometers
32	Industrial modular thermometers
35	Hygienic modular thermometers
36	High temperature thermometers
37	Surface thermometers
38	Highlight: iTHERM SurfaceLine TM611
40	Multipoint thermometers
41	Temperature Engineered Solutions - TES
42	Exclusive Endress+Hauser technology
	<b>Services and software</b>
44	Quality assurance
45	Calibration services
46	Netilion

Endress+Hauser is a global leader in measurement instrumentation, services and solutions for industrial process engineering

With dedicated sales centers and a strong network of partners, Endress+Hauser guarantees competent worldwide support. Our production centers in twelve countries meet your needs and requirements quickly and effectively. The Group is managed and coordinated by a holding company in Reinach, Switzerland. As a successful family-owned business, Endress+Hauser is set to remain independent and self-reliant.

Endress+Hauser provides sensors, instruments, systems and services for level, flow, pressure and temperature measurement as well as analytics and data acquisition. The company supports you with automation engineering, logistics and IT services and solutions. Our products set standards in quality and technology.

We work closely with the Chemical, Petrochemical, Food & Beverage, Oil & Gas, Water & Wastewater, Power & Energy, Life Science, Mining, Minerals and Metals, Renewable Energy, Pulp & Paper and Shipbuilding industries. Endress+Hauser helps customers to optimize their processes in terms of reliability, safety, economic efficiency and environmental impact.



Bluetooth® is a trademark of Bluetooth® SIG. Inc. Profibus is a registered trademark of the PROFIBUS user organization. HART is a registered trademark of the HART communication foundation. FOUNDATION Fieldbus is a registered trademark of the Fieldbus FOUNDATION. All other trademarks are the property of their respective owners. All other copyrights are the property of their respective owners.



To learn more about Endress+Hauser, visit: [www.endress.com](http://www.endress.com)

Information on the ISO certification: [Cybersecurity certification for Endress+Hauser](#)





## Temperature measurement by Endress+Hauser – Because we understand

Its expansive, globally available portfolio of standard thermometers, temperature transmitters and engineered solutions makes Endress+Hauser one of the leading international complete providers of temperature measuring technology for process automation. The large vertical range of production and the high degree of in-house development, ranging from primary sensors and electronics to customized special solutions, make a crucial difference here. As a reliable and close partner for our customers, we utilize our wealth of product and solution expertise to develop innovative products that produce excellent customer benefits. These products include the world's first self-calibrating thermometer iTHERM TrustSens and unique inserts such as the iTHERM QuickSens and iTHERM StrongSens, excellent temperature transmitters like the iTEMP TMT162 – with SIL 2 or SIL 3 and even multipoint solutions for 2D/3D measurements in digesters. As your expert partner in all issues related to temperature measuring technology, we make a crucial contribution to making your processes more reliable and efficient and increasing the quality of the end products.



### Competence center for temperature measurement, Temperature Engineered Solutions and system products

Endress+Hauser Temperature+System Products is one of the leading producers of temperature measurement, Temperature Engineered Solutions and system products worldwide.

The company employs more than 700 associates worldwide. 400 of which are working in our headquarters Nesselwang (Germany), where our products are developed and produced.

Associated Product Centers in Pessano (Italy), Greenwood (USA), Suzhou (China) and Chhatrapati Sambhajnagar (India) guarantee customer proximity with products and services.



# Oil & Gas



## Fuel for thought

We reduce complexities to help you perform, comply and thrive in the Oil & Gas sector

Maximizing plant availability, safety and the efficiency of operations are the key challenges for today's Oil & Gas industry. Complexity increases in the face of volatile market forces, strict international regulations and your ever-tightening resources. Close, accurate monitoring of key process parameters is critical. Our broad, reliable portfolio of instrumentation, deep industry experience, and our services and solutions make Endress+Hauser the ideal partner for optimal plant performance.

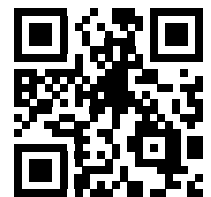

[Oil & Gas](#)



## Product highlights



### iTHERM ProfileSens

- World's most robust insert for multipoint measurements
- Robust design for harsh process environments

More information: [Page 20](#)



### iTHERM ModuLine

- Streamlined and innovative portfolio of modular thermometers
- With international approvals for hazardous areas, in compliance with international pressure regulations

More information: [Page 32](#)



### iTEMP TMT142B

- Smart 4-20 mA and HART transmitter
- With Bluetooth and integrated over-voltage protection

More information: [Page 24](#)



### iTHERM MultiSens Slim TMS21

- Linear or flexible assembly without containment chamber
- Accurate temperature profiling, very low invasiveness, high density of measurement points

More information: [Page 40](#)



### iTHERM SurfaceLine TM611

- Non invasive temperature measurement
- No risk of leakages
- Simple installation and maintenance

More information: [Page 38](#)



### Temperature Engineered Solutions

- Fully customized surface thermometers
- High-precision multipoint thermometers

More information: [Page 41](#)

## Advantages at a glance

- Mitigating risks by using state of the art technology – meeting highest demands with regard to Functional Safety (IEC 61508) and mechanical integrity (e.g. ASME BPV Codes, EN 13445, PED)
- Minimizing operational costs through efficient proof testing concepts, predictive maintenance and innovative data management
- Meeting internationally recognized standards and recommendations such as: API, OIML, ASME, NOR-SOK, NACE etc.
- Increasing plant availability with innovative technologies e.g. Dual Seal technology, iTHERM StrongSens sensor, iTHERM ProfileSens sensor



# Chemicals



## Competitive and safe

We help you boost your plant's safety and performance



[Chemicals](#)

Maximizing productivity and profitability whilst meeting toughening safety and sustainability standards is the greatest challenge facing the chemical industry today. Technological innovation brings opportunity, but reliability is vital. Plant modernization is expedient, yet project delivery complex. Our innovatory instrumentation with safety built-in, allied to expert safety and project consulting, enables Endress+Hauser to deliver solutions to safely and reliably attain peak plant performance.



Find a visual overview of the most relevant processes in the chemical industry and the suitable instruments in our portfolio brochure: [S001101](#)

## Product highlights



### iTHERM ModuLine

- Suitable solutions from basic applications up to safety critical processes
- Including unique innovations like Dual Seal, iTHERM StrongSens, NAMUR thermowell and iTHERM TwistWell

More information: [Page 32](#)



### iTHERM MultiSens Slim TMS21

- Right choice for chemical processes that require accurate temperature profiling
- Very low invasiveness, high density of measurement points and intrinsically safe versions

More information: [Page 40](#)



### iTHERM TrustSens TM371/TM372

- Intrinsically safe device with functions like self-calibration and self-diagnostics
- Heartbeat technology and Netilion allow continuous diagnostics, verification and data access from anywhere

More information: [Page 31](#)



### iTEMP TMT86

- Dual-channel Ethernet-APL head transmitter
- With FDI package for device integration, plug-on display support and integrated web server

More information: [Page 24](#)



### iTHERM SurfaceLine TM611

- Non invasive temperature measurement
- No risk of leakages
- Simple installation and maintenance

More information: [Page 38](#)



### iTEMP temperature transmitter

- Broad portfolio with head, field or DIN-rail and various field housing options.
- Explosion protection, SIL, 1 or 2-channel, HART, PROFIBUS PA, PROFINET over Ethernet-APL, FOUNDATION Fieldbus, Bluetooth® technology

More information: [Page 24](#)

## Advantages at a glance

- Meeting internationally recognized standards/ recommendations: NAMUR, ASME, NACE, IEC 17025, MID, OIML
- Internationally accepted hazardous area approvals: ATEX, IECEx, FM/CSA, NEPSI, TIIS, INMETRO, KOSHA, EAC etc.
- Use of state of the art technology – functional safety according to IEC 61508 (up to SIL 3)
- Uniform operating safety by design concepts for simple and safe operations
- Optimized material availability and minimized stocks through inventory management solutions
- Time savings for downtimes due to advanced diagnostic functions





# Mining, Minerals & Metals



## Extracting more from less

In a world of lower ore grades, skill gaps and excavation challenges we can help you hit your target

Never more so than today has the Mining, Minerals & Metals industry had to manage such tension between soaring demand, increased scarcity, lower ore grades, fluctuating prices, and toughening safety and sustainability criteria. Combining our innovative product portfolio with our deep application and industry knowledge enables Endress+Hauser customers to optimize processes, boost productivity and ensure safety and environmental compliance.

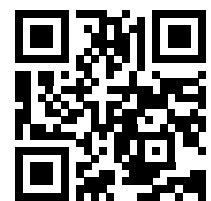

[Mining, Minerals  
& Metals](#)

## Product highlights



### iTHERM FlameLine

- Modular high-temperature thermometers made from exclusive materials
- Applicable for ceramic baking ovens, brickworks, steel treatment, cement production etc.

More information: [Page 36](#)



### iTHERM ModuLine TM131

- Intrinsically safe temperature sensor (RTD or TC)
- Configurable for a wide range of applications

More information: [Page 33](#)



### iTHERM CableLine TST310/TSC310

- Cost efficient temperature cable probe for direct installation
- Designed for use in many process and laboratory applications

More information: [Page 30](#)



### iTEMP TMT86

- Dual-channel Ethernet-APL head transmitter
- With FDI package for device integration, plug-on display support and integrated web server

More information: [Page 24](#)



### iTHERM SurfaceLine TM611

- Non-invasive temperature measurement
- No risk of leakages
- Simple installation and maintenance

More information: [Page 38](#)



### iTEMP temperature transmitter

- Broad portfolio with head, field or DIN-rail and various field housing options.
- Explosion protection, SIL, 1 or 2-channel, HART, PROFIBUS PA, PROFINET over Ethernet-APL, FOUNDATION Fieldbus, Bluetooth® technology

More information: [Page 24](#)

## Advantages at a glance

- Complete product basket for all applications, specifically in harsh environments
- Advanced diagnostic functionalities to make the process more safe and reliable
- Savings in raw material, water, energy and labor through accurate data of critical and quality relevant points in your process
- High-temperature sensors with extended lifetime can help reduce costs significantly
- Vibration resistant, fast response time sensors and special materials result in increased process efficiency and product quality



# Food & Beverages



## Trust in quality

We help you to improve quality while reducing operational costs

Constant demand for consistency in product quality and taste makes Food & Beverage a demanding industry. Complexity increases as ever more stringent hygiene regulations for food safety add cost pressures. Endress+Hauser's industry leading portfolio of reliable instrumentation, expert global consulting and accredited calibration services all combine to enable greater plant availability, resource conservation and high repeatability in processing with traceable compliance.

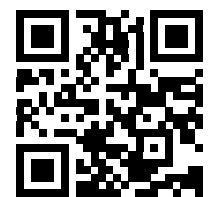

[Food & Beverages](#)



Find a visual overview of the most relevant processes in Food & Beverage production and the suitable instruments in our portfolio brochure: [S001090](#)



## Product highlights



### iTHERM TrustSens TM371/TM372

- World's first self-calibrating thermometer
- Optimized elbow thermowells for clean operations

More information: [Page 31](#)



### iTHERM ModuLine TM131

- From basic applications up to explosion-proof environments
- Including unique innovations like iTHERM QuickNeck and iTHERM QuickSens

More information: [Page 33](#)



### iTHERM ModuLine TM401/TM402

- Sanitary modular thermometer with basic technology
- Developed specifically for use in hygienic/aseptic applications

More information: [Page 35](#)



### iTEMP TMT31/TMT36

- 4-20 mA (TMT31) or IO-Link (TMT36) communication
- Simple products for basic processes
- Easy to configure and quick to install

More information: [Page 24](#)



### iTHERM CompactLine TM311

- Hygienic compact thermometers, with extremely quick response time
- Ideal for short immersion depths in areas with small nominal pipe diameters
- 4-20 mA, IO-link or switch output

More information: [Page 31](#)



### iTEMP TMT71/TMT72

- 4-20 mA and HART temperature transmitters
- World's first Bluetooth® technology transmitters for operation in Ex environment

More information: [Page 24](#)

## Advantages at a glance

- The world's first self-calibrating thermometer reduces process risks and costs
- Best-in-class hygienic design
- Innovative thermowells with optimum hygienic properties



# Life Sciences



## The pulse of Life Sciences

Trust a reliable partner who helps you achieve operational excellence

Today's thriving biopharmaceutical industry demands high productivity and efficiency balanced with meticulous alignment to GMP standards. From our innovatory ASME BPE compliant product portfolio enabling standardized production automation, reliable monitoring and predictive maintenance, to our expert consulting in process scale-up and operations optimization, Endress+Hauser offers the full solution. We speed time to market, sustain operational excellence, enhance productivity, and reduce risk.

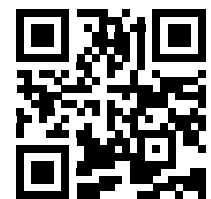

[Life Sciences](#)



Find a visual overview of the most relevant processes in Life Sciences and the suitable instruments in our portfolio brochure: [S001099](#)

## Product highlights



### iTHERM TrustSens TM371/TM372

- World's first self-calibrating thermometer
- Optimized elbow thermowells for clean operations

More information: [Page 31](#)



### iTHERM ModuLine TM411/TM412

- Modular thermometer with or without thermowell
- Including iTHERM QuickNeck/QuickSens
- Developed specifically for use in hygienic/aseptic applications

More information: [Page 35](#)



### iTHERM QuickSens

- RTD insert with shortest response times worldwide
- High-precision, fast response times even in combination with thermowells

More information: [Page 20](#)



### iTEMP TMT86

- Dual-channel Ethernet-APL head transmitter
- With FDI package for device integration, plug-on display support and integrated web server

More information: [Page 24](#)



### iTHERM CompactLine TM311

- Compact thermometer with extremely quick response time and 4-20 mA, IO-Link or switch output
- Ideal for short immersion depths in areas with small nominal pipe diameters

More information: [Page 31](#)



### iTEMP TMT31

- 4-20 mA basic head / DIN rail transmitter with RTD input and 4-20 mA output signal
- Easy to configure and quick to install thanks to push-in terminal

More information: [Page 24](#)

## Advantages at a glance

- The world's first self-calibrating thermometer reduces process risks and costs
- Quick and easy recalibration thanks to iTHERM QuickNeck technology
- Best-in-class hygienic design with full compliance to ASME BPE 2024
- Innovative thermowells with optimum hygienic properties





# Water & Wastewater



## Water is our life

Increase your efficiency and ensure compliance with an experienced and trusted partner

Today more than ever the Water & Wastewater industry must balance the opposing pressures of improving water safety and shrinking budgets. Whether treating for consumption or discharge, process complexity is rising. Endress+Hauser combines a wide portfolio of smart measuring instruments with industry-experienced consulting and expert services to flexibly and efficiently ensure water safety with verifiable regulatory compliance.

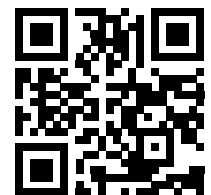

[Water & Wastewater](#)



Find a visual overview of the most relevant processes in the water/wastewater industry and the suitable instruments in our portfolio brochure: [S001094](#)

## Product highlights



### iTEMP TMT36

- IO-Link technology to digitize the last mile of your plant
- Suitable for all temperature assemblies

More information: [Page 24](#)



### iTEMP TMT31

- 4-20 mA basic head transmitter with RTD/TC input and 4-20 mA output signal
- Easy to configure and quick to install thanks to push-in terminal

More information: [Page 24](#)



### iTHERM CompactLine TM311

- Compact, accurate and fast RTD sensor
- With 4-20 mA, IO-Link (auto-detect) or switch output

More information: [Page 31](#)



### iTEMP TMT71/TMT72

- 4-20 mA and HART temperature transmitter
- World's first Bluetooth® technology transmitter for operation in Ex environment

More information: [Page 24](#)



### iTHERM ModuLine

- Streamlined and innovative portfolio of modular thermometers
- With international approvals for hazardous areas, in compliance with international pressure regulations
- Available as imperial versions (TM152/112)

More information: [Page 32](#)



### iTHERM CableLine TST310

- High flexibility through user-specific insertion lengths and variable process connections
- Fast response time

More information: [Page 30](#)

## Advantages at a glance

- Cost-effective product portfolio for any applications, e.g. for drinking water, wastewater
- Meeting internationally recognized standards/recommendations for drinking water applications
- Highest efficiency by easy commissioning, operation and maintenance of instruments
- Worldwide accepted Ex approvals
- Unique technologies like Dual Seal and iTHERM StrongSens



# Power & Energy



## Power up your plant

Power plants play a vital role, we help maximize uptime while delivering safety and productivity

Today's Power & Energy industry must strike a complex balance: meeting spiraling demand for affordable and reliable energy while increasing cleaner and renewable sources in the energy mix. As cost and regulatory pressures grow, modernization is essential for efficient, safe resource use. As renewables advance, so does the need for energy storage. With best-fit instrumentation, deep power application expertise, services and solutions, Endress+Hauser brings efficient, reliable productivity.

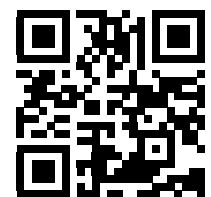

[Power & Energy](#)



## Product highlights



### iTHERM FlameLine

- Modular high-temperature thermometers in robust design
- Selection of durable thermowell materials

More information: [Page 36](#)



### iTEMP TMT71/TMT72

- 4-20 mA and HART temperature transmitters
- World's first Bluetooth® technology transmitters for operation in Ex environment

More information: [Page 24](#)



### iTHERM ModuLine

- Assorted RTD/TC thermometers
- Flexible configuration for e.g. straight-forward monitoring tasks or complex, safety-related measuring points
- Available as imperial versions (TM152/112)

More information: [Page 32](#)



### iTEMP TMT82

- Dual channel, SIL compliant, incl. HART
- Field mount housing with separate terminal compartment for comfortable wiring

More information: [Page 24](#)

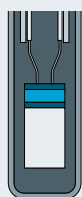

### iTHERM StrongSens

- Highly robust and vibration-resistant RTD insert
- Also suitable for applications in hazardous areas

More information: [Page 20](#)



### iTHERM Surface Line TM611

- Non invasive temperature measurement
- No risk of leakages
- Simple installation and maintenance

More information: [Page 38](#)

## Advantages at a glance

- Intelligent instruments with continuous self-monitoring
- Minimized downtime and highest safety through modern instrumentation
- Worldwide accepted Ex approvals and SIL certified transmitters and assemblies (IEC 61508 SIL 2/3)
- Unique technologies like Dual Seal and iTHERM StrongSens
- Optimizing high temperature applications



# Thermometer design

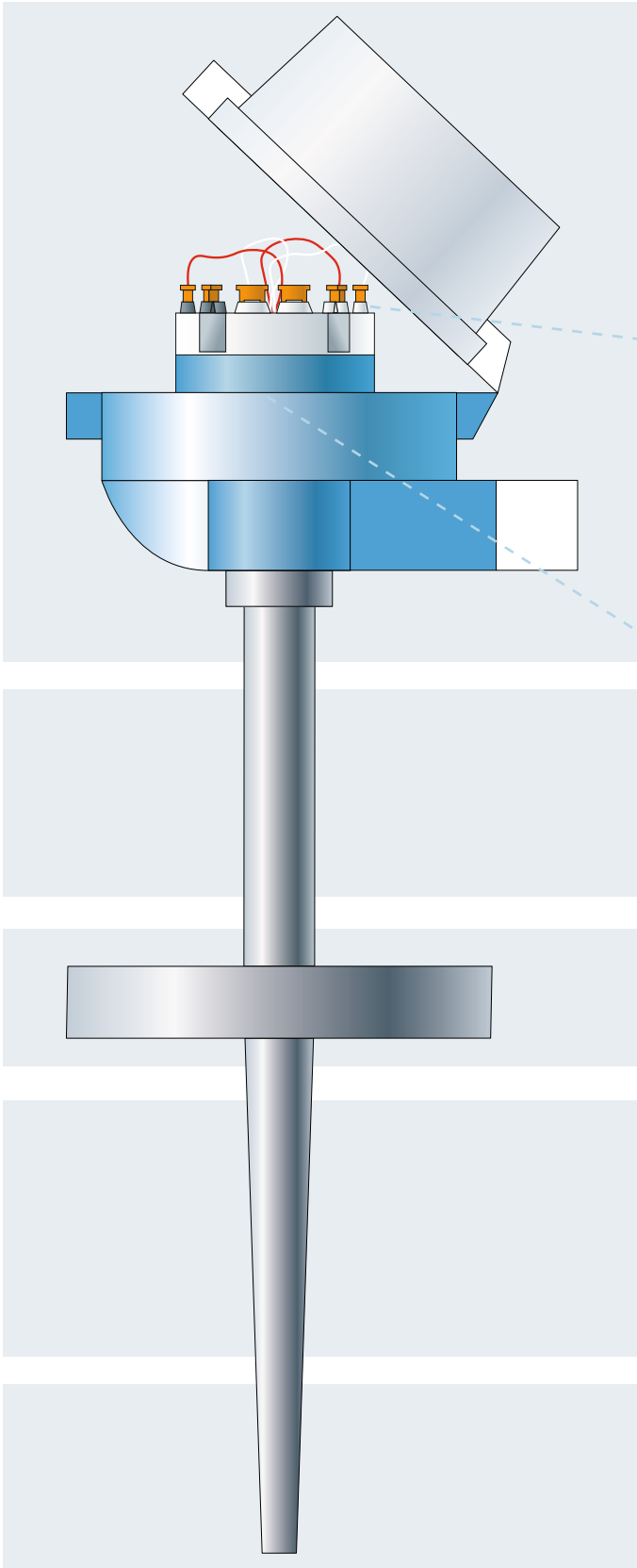

## Terminal head

... is fitted to the thermowell or the neck of the thermometer.

## Head transmitter

... transfers the sensor signal into a stable and standardized output signal.

## Extension neck

... is the connection between terminal head and process connection/thermowell.

## Process connection

... is the connection between the process and the thermometer.

## Thermowell

... is the process wetted component of the thermometer.

## Insert

... is located in the thermowell. The tip of the measurement insert contains the temperature sensor element itself.

**Benefits:**

- Protection and installation for terminal block or transmitter
- Cable entry and wiring
- Display (as option)

**Benefits:**

- Enhanced accuracy and stability
- Reduced wiring costs
- Lower maintenance time and expense
- Advanced diagnostics

[Learn more on pages 22-25](#)

**Benefits:**

- Protection of the head transmitter from overheating
- Guarantees access to the terminal head in the case of pipe insulation

**Benefits:**

- Increases the life cycle of the measurement insert through protection against process influence
- Possible measurement insert exchange under process conditions
- Mechanical stability against pressure and flow
- Ensures long-term stable temperature measurements

**Benefits:**

Enables electrical connection of the sensor element to the terminal block/transmitter

[Learn more on pages 20-21](#)



Visit our Youtube playlist on temperature know-how series to learn more about:

- Measurement inserts (RTD Resistance sensors/TC Thermocouples)
- Golden rules of temperature measurements
- Technical insights on thermometers

[Link to YouTube Playlist](#)



Endress+Hauser offers a complete assortment of thermometers and their components such as thermowells, terminal heads, temperature transmitters, process connections, neck/lagging, measurement inserts and further accessories for all types of process industries.

Using the configurator on **endress.com** helps you create a thermometer suitable for your process, deciding on the version of every single component. Of course it is possible to order these different components separately, e.g. as spare parts.

Find all products on [endress.com](https://endress.com):

[Products for temperature measurement](#)





# Sensor technology

All of our solutions at a glance

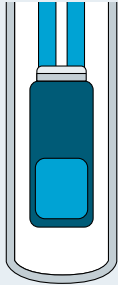

### Basic thinfilm Pt100 (RTD)

Thinfilm sensor consisting of ceramic substrate with vapor-deposited platinum  
Sensing element and wiring in stainless steel sheath

- ⊕ Measurement performance sufficient for most support processes
- ⊖ Limited measurement range

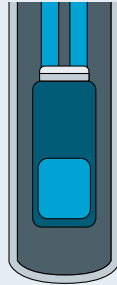
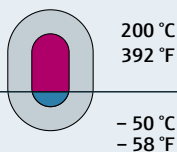

### Standard thinfilm Pt100 (RTD)

Small sensor consisting of ceramic substrate with vapor-deposited platinum  
Embedded in mineral isolated stainless steel sheath

- ⊕ Long-term stability
- ⊕ Vibration resistance
- ⊖ Limited measurement range

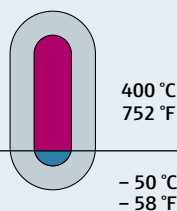

### Wirewound Pt100 (RTD)

Ultrapure platinum wire wound around a ceramic core  
Embedded in mineral isolated stainless steel sheath

- ⊕ Long-term stability
- ⊕ High measurement repeatability
- ⊖ Relative cost
- ⊖ Susceptible to mechanical stress

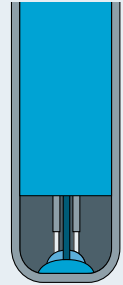
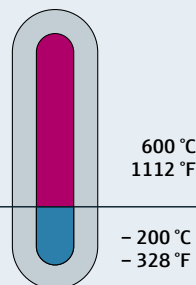

### iTHERM QuickSens Pt100 (RTD)

Thinfilm sensor with unmatched response time  
Sensor-on-tip technology for short immersion length

- ⊕ World's fastest response time
- ⊕ Maximum process safety
- ⊖ Limited measurement range

 Exclusive Endress+Hauser technology

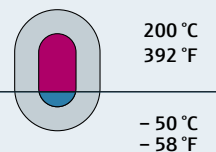

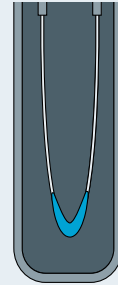
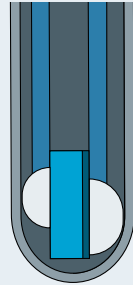
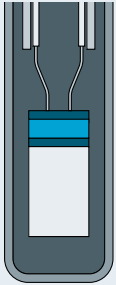

**iTHERM StrongSens Pt100 (RTD)**

**iTHERM TrustSens Pt100 (RTD)**

**Thermocouple (TC)**

**iTHERM ProfileSens Thermocouple (TC)**

Ceramic-encapsulated thinfilm with unmatched robustness  
 Vibration resistance up to 60g (2,116 oz) for lower life cycle cost

Self-calibrating sensor unit Pt100 sensor and integrated fixed point reference, making use of the Curie effect

Two dissimilar metals spot welded (hot junction)  
 Ideal for high temperatures

Up to six individual sensors MI cable mineral insulated (MgO powder)  
 Double metal sheathing technology

- ⊕ World's highest vibration resistance
- ⊕ Robust
- ⊕ Long lifetime and plant availability
- ⊖ Limited measurement range

- ⊕ Self-calibrating
- ⊕ High degree of automation
- ⊕ Risk reduction
- ⊖ Limited measurement range

- ⊕ Measurement range
- ⊕ Ideal for high temperatures
- ⊖ Long-term stability
- ⊖ Limited accuracy

- ⊕ Robust and reliable
- ⊕ For high temperatures, pressure, aggressive media
- ⊕ Increased plant safety
- ⊖ Limited accuracy (compared to RTD)

Exclusive Endress+Hauser technology

Exclusive Endress+Hauser technology

Exclusive Endress+Hauser technology

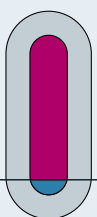

500 °C  
932 °F

- 50 °C  
- 58 °F

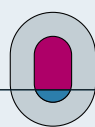

190 °C  
374 °F

- 40 °C  
- 40 °F

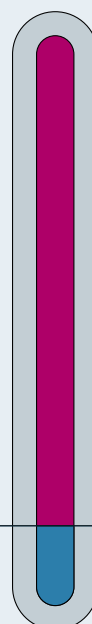

up to 1800 °C  
up to 3272 °F

- 270 °C  
- 454 °F

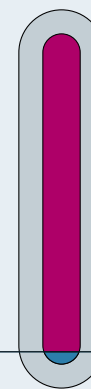

1100 °C  
2012 °F

- 40 °C  
- 40 °F

# Temperature transmitters

The task of a temperature transmitter is the transformation of the sensor signal into a stable and standardized signal. To interpret this signal correctly, an exact configuration with respect to sensor and process conditions is required. Different technologies can be used to adapt this configuration and display the process value and further information.



## Benefits at a glance

Increased accuracy, enhanced safety, optimized usability and a high degree of standardization and digitalization! What makes our temperature transmitters the perfect solution for your measuring point?

Watch our YouTube videos to learn more about our transmitters:



## “Perfect fit”

Our Endress+Hauser temperature transmitters are the perfect fit for all industries and a wide range of applications.

- Different housing types make the transmitters suitable for a wide range of systems and applications available
- Various digital and analog output signals ensure an optimal selection of the transmitter according to the existing or desired system environment
- Several features and approvals guarantee perfect alignment of the measuring point to the respective industry requirements

## Housing types



**DIN rail**  
Installation in control cabinets



**Head transmitter**  
Installation in thermometer terminal heads



**Field transmitter**  
Remote installation in process area



## Digital and analog output signals

The Endress+Hauser portfolio includes basic temperature transmitters that communicate with analog signals as well as advanced devices that use digital communication technologies. They ensure high accuracy as well as flexibility and provide additional information from the measuring point, like extended diagnostics.

### Digital

 **IO-Link**

**PROFI**  
**NET**

  
**FOUNDATION**

**HART**  
COMMUNICATION PROTOCOL

 **ethernet-apl**  
advanced physical layer

**PROFI**  
**BUS**

### Analog

4-20 mA

 **ethernet-apl**  
advanced physical layer

**NEW**

 **IO-Link**

#### The 2-wire data highway for endless possibilities

Ethernet-APL combines the benefits of simple and robust 2-wire technology with the benefits of Ethernet, enabling top-performance and seamless data access in the field of process plants. This technology is based on established industrial Ethernet protocols such as PROFINET.



2-wire cable  
with 10 Mbit/s  
full duplex  
communication



Explosion  
protection for  
all zones and  
divisions



Power supply  
via APL  
switches

#### Benefits

- High plant availability and increased production output with less plant shutdowns
- Increased efficiency in maintenance
- Plant downtimes can be minimized



#### Digitize the last mile of your plant

Smart Ethernet devices like valve islands, remote IOs, recorders, liquid analyzers or flow measurement devices are digitalized with Industrial Ethernet. Basic devices also become digitally accessible with IO-Link: This makes offline parametrization, data transparency and plug-and-produce device exchange available for all devices.

#### Benefits

##### Shorten commissioning time

- Use of unshielded standard cables and standard connection plugs
- Offline engineering

##### Speed up MRO





- Time-saving parameterization via the engineering system without the need for additional software
- Comprehensive access to device, diagnostic and process information as well as fast data upload and download for maintenance and service

##### Increase productivity







- Automatic device identification and multivariable devices



# Temperature transmitters

Communication standard	4-20 mA	IO-Link	4-20 mA	HART
Housing types and models				 TMT72 
	TMT31	TMT36	TMT71	TMT142B
Type of input	RTD or TC	RTD	Universal	
Sensor inputs(s)	1			
Additional information	Programmable or fixed configuration	Plug-in display	Plug-in display (head) Bluetooth® technology	Plug-in display (head) Bluetooth® technology Backlit display (TMT142B) Integrated over-voltage protection (TMT142B)
Approvals/certificates	Ex ec: ATEX, CSA C/US; DNV		Ex ia, Ex d: ATEX, IECEx, INMETRO, NEPSI, UK Ex; IS, XP: CSA C/US; DNV	Ex ia, Ex d: ATEX, IECEx, INMETRO, NEPSI, UK Ex; IS,XP: CSA C/US; DNV (TMT72)
Diagnostics	Sensor break, open-circuit or short-cut detection		Sensor break, open-circuit or short-cut detection Corrosion monitoring	
Segment	<b>F L E X</b>			<b>F L E X</b>

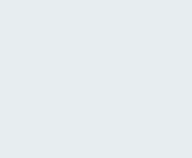

	FOUNDATION Fieldbus	PROFIBUS PA	PROFINET over Ethernet-APL
			
TMT82	TMT85	TMT84	
			
TMT162	TMT162	TMT162	TMT86
Universal			
2			
Plug-in display (head) Backlit display (TMT162) Dual compartment housing (TMT162) Integrated overvoltage protection (TMT162)			Plug-in display 2-wire Ethernet IEEE 802.3cg 10BASE-T1L
Ex ia, Ex d: ATEX, IECEx, INMETRO, NEPSI, UK Ex; IS, XP, NI: FM, CSA; SIL 2/SC 3; DNV, ABS, LR, BV (TMT82)	Ex ia, Ex d: ATEX, IECEx, INMETRO, NEPSI, UK Ex; IS, XP, NI: FM, CSA	Ex ia, Ex d: ATEX, IECEx, INMETRO, NEPSI, UK Ex; IS, XP, NI: FM, CSA	Ex ia, Ex d: ATEX, IECEx, NEPSI; IS, XP, NI: CSA C/US
Sensor break, open-circuit or short-cut detection Corrosion monitoring Sensor drift detection or sensor back up function			
<b>F L E X</b>			





# Highlight: iTEMP TMT31

Where simplicity meets reliability

Our iTEMP TMT31 temperature transmitter combines simplified selection, ordering, installation and operation with the highest reliability and long-term stability in one product.

With our updated iTEMP TMT31, we are simplifying our transmitter portfolio. The new F-segment transmitter replaces several previous products and combines their features into just one product structure. No matter which sensor input, which housing type and if pre-configuration is required - the starting point is always the iTEMP TMT31. This simplifies product selection and the ordering process while reducing the error rate during product configuration.

NEW

RTD or TC input

NEW

Fixed or programmable

NEW

Head or DIN rail

## Benefits



Save time and effort on commissioning, configuration and maintenance

- Push-in terminals for fast, tool-free wiring during installation or maintenance
- Simple parametrization via free software tools



Long-term stability, accurate and precise temperature measurements



Categorized and uniform diagnostic information according to NAMUR

Form B head or DIN rail temperature transmitter

- 4 to 20 mA output
- 1 x RTD or TC input
- Zone 2 

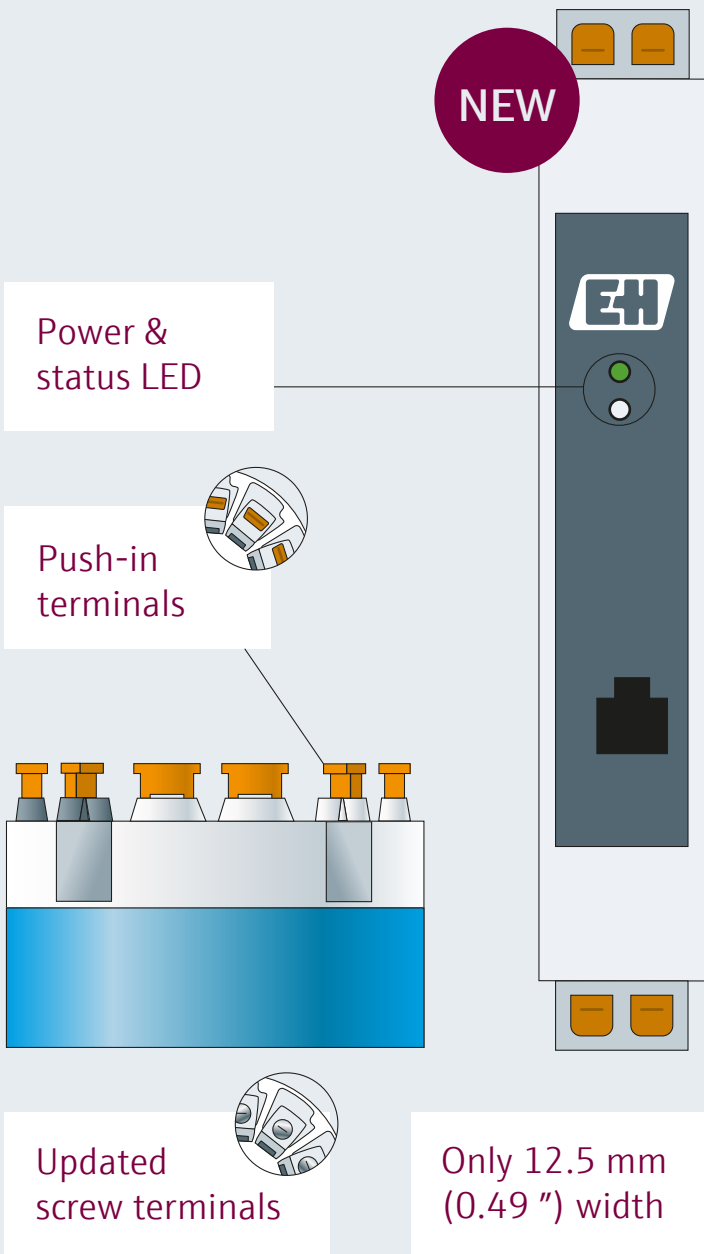

### Our F-segment transmitters

- Simple products for basic processes
- Up-to-date technology
- Best price-performance ratio
- Simple product selection, ordering, installation and operation
- Focus on current trends in the industry
- Simplicity combined with renowned Endress+Hauser quality and technical know-how





 TMT31



 TMT36

# Thermowells

Type	Barstock thermowell			Welded industrial thermowell	Welded hygienic thermowell	
Model	<b>TT151</b>	<b>TT152</b>	<b>TT511</b>	<b>TT131</b>	<b>TT411</b>	<b>TT412</b>
Design	Metric	Imperial	Metric			Imperial
						
Segment	<b>F L E X</b>					
Thermowell design	DIN, ASME	ASME	Van Stone	DIN	Hygienic	
Process connection	Flange, weld-in, threaded		Lap-joint flange	Flange, weld-in, threaded	Hygienic	
Material	316, 316L, 316Ti, 347, 310 Alloys 600, C276, 10CrMo9-10, 13CrMo4-5, 16Mo3 A105, C22.8 Duplex S32205, Titan Gr.2		1.4401, 1.4571	Stainless steel: 316, 316L, 316Ti, 321, Alloy446 nickel-based materials: AlloyC276, Alloy600, jackets in Tantalum and PTFE	316L	
Approvals/ certificates	CRN					
Innovations	iTHERM TwistWell		-	QuickLink iTHERM QuickNeck	Tee and elbow thermowells	
Suitable for	TM131, TM151	TM152	TM131, TM151	TM131	TM411	TM412





# Product overview thermometers

Our expansive portfolio offers globally available, standardized thermometers for industrial and hygienic applications across all industries. As a full-range supplier for temperature measurement, we unite all competencies under one roof – from sensors and electronics to complete assemblies and customized solutions.

With outstanding customer-centric innovations, we help to increase plant availability, efficiency and safety. Our internationally tested and certified products ensure seamless integration, ease of use and long-term reliable performance.



This brochure presents our current core portfolio, highlighting our future-proof products.

For a complete overview, including discontinued products and their successors or spare parts (e.g. terminal heads, inserts), please visit: [www.endress.com](http://www.endress.com)



## Cable probes

iTHERM CableLine  
Power & Energy, Oil & Gas  
[Page 30](#)



## Compact thermometers

iTHERM CompactLine  
Food & Beverages, Life Sciences  
[Page 31](#)



## Industrial modular thermometers

iTHERM ModuLine  
Chemical, Oil & Gas, Power & Energy  
[Page 32-34](#)



## Hygienic modular thermometers

iTHERM ModuLine  
Food & Beverages, Life Sciences  
[Page 35](#)



## High temperature thermometers

iTHERM FlameLine  
Mining, Minerals, Metals, Oil & Gas,  
Power & Energy  
[Page 36](#)



## Surface thermometers





iTHERM SurfaceLine  
Power & Energy, Chemical, Oil & Gas  
[Page 37](#)



## Multipoint thermometers







iTHERM MultiSens  
Oil & Gas, Chemical, Food & Beverages  
[Page 40](#)

# Cable probes

Model	TST310	TSC310	TH12	TH52	TH56
Design	Metric		Imperial		
					
Segment	<b>F L E X</b>				
Description	With permanently affixed connecting cable or plug connector (TH56)				
Approvals/ certificates	ATEX Ex ia, Ex nA; NEPSI Ex ia; IECEX Ex ia; UK Ex ia, Ex nA		-		
Temperature range	RTD: -200 to +600 °C (-328 to +1112 °F)	TC: -270 to +1100 °C (-346 to +2012 °F)	RTD: -200 to +200 °C (-328 to +392 °F)	TC: -270 to +1372 °C (-454 to +2500 °F)	



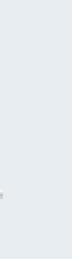

# Compact thermometers

Type	Thermometers					Temperature switches	
Model	TMR31	TMR35	TM311	TM371	TM372	TTR31	TTR35
Design	Metric		Metric/ imperial	Metric	Imperial	Metric	
							
Segment		FLEX		FLEX		FLEX	
Application	Industrial	Hygienic	Industrial/ hygienic	Hygienic		Industrial	Hygienic
Features	With thread or compression fitting	Hygienic process connec- tions	iTHERM TipSens  Hygienic tee and elbow thermowells	iTHERM TrustSens		With thread or compression fitting	Hygienic process connec- tions
Description	With integrated transmitter			Reduces risks and costs by a fully automated, traceable inline self-calibration		Temperature switch with 1/2 PNP switch outputs	
Commu- nication standards	4-20 mA		4-20 mA, IO-Link	4-20 mA, HART		4-20 mA	
Approvals/ certificates	UL		EHEDG; ASME; FDA; 3-A; CSA C/US; DNV	EHEDG; ASME; FDA; 3-A; CSA C/US; Ex; UK Ex ia; ATEX IECEx Ex ia		UL; CSA C/US	UL; CSA C/ US; 3-A; EHEDG
Temperature range	RTD: -50 to +200 °C (-58 to +392 °F)			RTD: -40 to +190 °C (-40 to +374 °F)		RTD: -50 to +150 °C (-58 to +302 °F)	







# Industrial modular thermometers

Thermowell	Direct contact – without thermowell		
Model	TM101	TM111	TM112
Design	Metric		Imperial
			
Segment	F L E X		F L E X
Communication standards	4-20 mA, HART, IO-Link	4-20 mA, HART, PROFINET over Ethernet-APL, FOUNDATION Fieldbus, IO-Link, PROFIBUS PA	
Features	Best price/performance ratio	iTHERM StrongSens iTHERM QuickSens	
Approvals/certificates	-	ATEX/IECEX Ex ia, Ex nA, Ex ec, Ex tc, Ex ta/tb, Ex db; CSA C/US IS, NI, XP, DIP; INMETRO Ex ia, Ex d; NEPSI Ex ia, Ex d, Ex tD; UK Ex ia, Ex nA	
Temperature range	TC: -40 to +650 °C (-40 to +1202 °F)  RTD: -50 to +200 °C (-58 to +392 °F)	TC: -40 to +1100 °C (-40 to +2012 °F)  RTD: -200 to +600 °C (-328 to +1112 °F)	



Welded thermowell		Barstock thermowell	
TM121	TM131	TM151	TM152
Metric		Imperial	
			
<b>F L E X</b>		<b>F L E X</b>	
4-20 mA, HART, IO-Link	4-20 mA, HART, PROFINET over Ethernet-APL, FOUNDATION Fieldbus, IO-Link, PROFIBUS PA		
Best price/performance ratio	iTHERM StrongSens iTHERM QuickSens iTHERM QuickNeck QuickLink Dual Seal Dual compartment housing	iTHERM StrongSens iTHERM QuickSens iTHERM QuickNeck iTHERM TwistWell QuickSleeve Dual Seal Dual compartment housing	
-	ATEX/IECEx Ex ia, Ex nA, Ex ec, Ex tc, Ex ta/tb, Ex db; CSA C/US IS, NI, XP, DIP; INMETRO Ex ia, Ex d; NEPSI Ex ia, Ex d, Ex tD; UK Ex ia, Ex nA; SIL 2/SC 3; DNV		
TC: -270 to +650 °C (-454 to +1202 °F)	TC: -270 to +1100 °C (-454 to +2012 °F)		
RTD: -50 to +200 °C (-58 to +392 °F)	RTD: -200 to +600 °C (-328 to +1112 °F)		



# Industrial modular thermometers

## RTD thermometer for outdoor and indoor ambient temperature measurement

Just like temperature, flow or pressure instruments, you can connect ambient temperature measurement to the control room via a standard communication protocol.

This cross-industry device is ideal for general applications:

- around piping and machinery
- factory and production halls
- control cabinet
- server rooms
- laboratories, greenhouses
- drying and cooling rooms





## Paired set of RTD thermometers for thermal energy measurements

To achieve the smallest possible deviation between two thermometers, paired RTD primary sensors with almost identical characteristics can be installed. These sensors are the right choice for energy consumption measurements.

Model	TST434B
	
Segment	FLEX
Communication standards	4-20 mA, HART, PROFIBUS PA, FOUNDATION Fieldbus, IO-Link, PROFINET over Ethernet-APL
Features	Robust terminal heads according to DIN EN 50446 or stable plastic housings, simple and fast wall mounting
Temperature range	RTD: -50 to +150 °C (-58 to +302 °F)

Model	TST90
Design	Metric
	
Segment	FLEX
Description	Design as per DIN 43772 form 2G
Features	Paired in the range: 0 to +120 °C (+32 to +248 °F); Deviation of the sensors: ± 0.05 K Paired in the range: -40 to 0 °C (-40 to +32 °F); Deviation of the sensors: ± 0.1 K
Temperature range	RTD: -50 to +400 °C (-58 to +752 °F)



# Hygienic modular thermometers

Thermowell	Direct contact - without thermowell		With or without thermowell	
Model	<b>TM401</b>	<b>TM402</b>	<b>TM411</b>	<b>TM412</b>
Design	Metric	Imperial	Metric	Imperial
				
Segment	<b>F L E X</b>		<b>F L E X</b>	
Communication standards	4-20 mA, HART , IO-Link		4-20 mA, HART, FOUNDATION Fieldbus, PROFIBUS PA, PROFINET over Ethernet-APL, IO-Link	
Highlights	-		iTHERM QuickNeck iTHERM QuickSens iTHERM StrongSens	
Approvals/Certificates	EHEDG; ASME; 3-A; FDA	EHEDG; ASME; 3-A; FDA; PMO	EHEDG; ASME; 3-A; FDA; ATEX Ex ia, Ex nA; CSA C/US IS, NI; FM IS, NI; JPN Ex ia; NEPSI Ex ia; UK Ex ia, Ex nA	EHEDG; ASME; 3-A; FDA; ATEX Ex nA; CSA C/US IS, NI; FM IS, NI; ATEX/IECEX Ex tb, Ex ia
Temperature range	RTD: -50 to +200 °C (-58 to +392 °F)		RTD: -200 to +600 °C (-328 to +1112 °F)	





# High temperature thermometers

Model	TAF11	TAF12S	TAF12D	TAF12T	TAF16
Design	Metric				
					
Segment	F L E X				
Thermowell	Single/dual thermowell	Single thermowell	Dual thermowell	Triple thermowell	Single/dual thermowell
Material thermowell	Ceramic C610, sinterized silicon carbide (SiC), special silicon nitride ceramic (SiN)	Ceramic C610, C799		Ceramic C530, C610, C799	AISI: 316L, 310, 304, 446, Alloy 600, Alloy 601; Alloy 800HT, Alloy C276, Kanthal AF and Kanthal Super, special nickel/cobalt alloy (NiCo), special silicon nitride ceramic (SiN) Optional ceramic inner sheath
Temperature range	TC: Up to +1820 °C (+3308 °F)				TC: Up to +1768 °C (+3214,4 °F)



# Surface thermometers

Model	TST602	TM611
Design	Metric	Metric
		
Segment	<b>F L E X</b>	<b>F L E X</b>
Description	For basic monitoring applications	Accurate and fast temperature measurement for process control and safety functions
Communication standards	-	4-20 mA, HART, FOUNDATION Fieldbus, PROFIBUS PA, IO-Link, PROFINET over Ethernet-APL
Type	Cable probe	Cable probe or industrial thermometer
Approvals/Certificates	-	ATEX/IECEx Ex ia, Ex nA Ex ec, Ex tc, Ex ta/tb, Ex db; CSA C/US IS, NI, XP, DIP
Measuring range	RTD: -20 to +200 °C (-4 to +392 °F)	RTD: -200 to + 400 °C (-328 to + 752 °F) TC: -40 to +400 °C (-40 to +752 °F)



# Highlight: iTHERM SurfaceLine TM611

Non-invasive thermometer



No process opening, **no risk of leakage**



**Simplicity:** installation, maintenance, product selection



**Increased safety:** for personnel, system, environment



Measuring accuracy & response time  
**comparable to invasive measurements**



**Significant cost savings:**

- Reduced development & project planning times
- Reduced expenses: installation, certification, inspections
- No expenses for: thermowells, nozzles, flanges, weld seam tests, pipe extensions

**For a wide range of demanding industrial applications**

High flow velocities / process pressures, highly viscous / corrosive media, abrasion, pigging, small pipe diameters

Retrofitting, temporary / additional measurements, greenfield projects, energy monitoring

**Measuring range**

-200 ... +400 °C  
-328 ... +752 °F



### iTEMP temperature transmitters

- All common communication protocols
- Bluetooth® connectivity

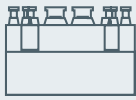

### Thermal coupling element

- Extra wide contact surface
- No air gap between coupling element and sensor
- Geometry adapted to the pipe diameter



### Heat transfer material

- Compensates for imperfections of the pipe

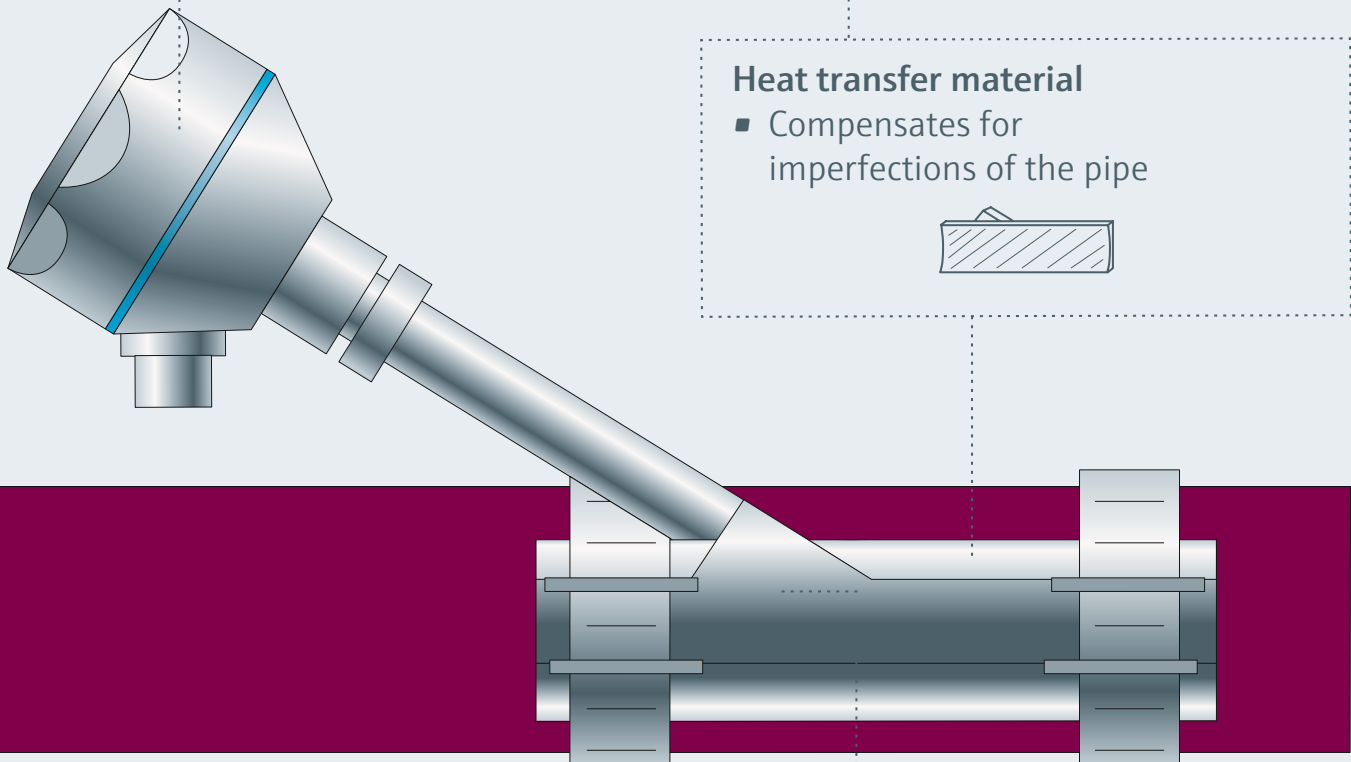

### Stainless steel screw clamps

- Easy, convenient, safe installation
- No drilling, welding, additional tools



### Measurement insert







- Precisely fitted into the thermal coupling element
- Standard RTD / TC sensor with low thermal mass





# Multipoint thermometers

Pre-engineered multipoint temperature assemblies

Model	Flex TMS01		Flex TMS02		Linear TMS11	Linear TMS12	Slim TMS21	Bundle TMS31	
Design	Metric/imperial		-		Metric/imperial				
									
Segment	<b>F L E X</b>								
Type	Direct contact	Individual thermo-wells	Direct contact	Individual thermo-wells	Multiple, primary thermowell		Annealed tube	Annealed tube with flexible part	Stainless steel flexible rope
Response time	■■■■■	■■■■■	■■■■■	■■■■■	■■■■■		■■■■■	■■■■■	■■■■■
Layout/bendability	■■■■■	■■■■■	■■■■■	■■■■■	-		■■■■■	■■■■■	■■■■■
Diagnostic capabilities	-		Advanced		Basic	Advanced	-		
Individually replaceable sensors	✓								
Max. number of points	48 (linear or 3D) 80 (Profile-Sens)	48 (linear or 3D)	48 (linear or 3D) 80 (Profile-Sens)	48 (linear or 3D)	16 (linear)	12 (linear)	59 (linear)		20 (linear)
Max. pressure in bar (psi)	100 (1 450)		200 (2 900)		240 (3 481)		90 (1 305)		40 (580.1)
Measuring technology	RTD/TC						TC		RTD/TC

## ✓ Benefits at a glance

- Measurement and recording of a temperature profile for control of the process in the reactor or storage conditions in tanks and silos
- Shortest response time enabled by state-of-the-art sensor technology
- Easily configurable and globally available
- Coverage of all key applications in the oil & gas, chemical, food & beverage, petrochemical industries
- Increased safety thanks to a diagnostic chamber able to contain the process in the event of leakages through the primary seals

# Temperature Engineered Solutions – TES

Fully customized temperature measurement solutions

## Customized engineered temperature solutions – excellence in instrumentation, services and project support

Our solutions including tests, accessories and services are planned and executed specifically with the aim of satisfying challenging customer requirements. Engineering, selected materials and highest production standards guarantee instrument longevity in all types of process media, pressure and temperature ranges.

### ✓ Expertise from project start to finish

- Active support during turn-around planning
- Design studies
- Installation and supervision
- Field tests, complete in-house validation test packages
- Immediate on-site or remote service and consultation
- Maintenance, training
- Comprehensive documentation package



## Customized SkinPoint thermometers – for surface temperature measurement

### ✓ Benefits at a glance

- Continuous heat exchange monitoring
- No affection of the stream's steadiness or invasion into the pipe
- Engineered for maximum reliability – wide range of high-grade materials
- Compensation for thermal distortion with optimized expansion coils
- Quick & easy commissioning
- Compatibility with existing process connections

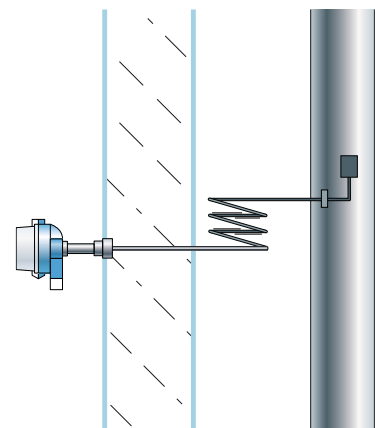

! For support during configuration or to order a customized Temperature Engineered Solution, please contact your Endress+Hauser sales representative.

# Exclusive Endress+Hauser technology

Trend-setting innovations, from individual components to products

## iTHERM QuickNeck

Divisible extension neck with tool-free quick release for easy & fast recalibration

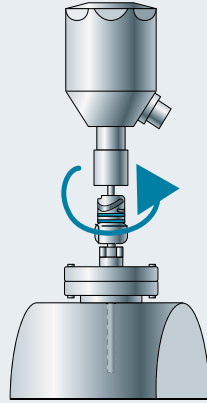

More than  
**50%**  
cost + time  
savings

- Removal of insert without any tools
- Terminal head can remain closed, connection cables remain connected
- No risk of water ingress, mechanical damage or wiring errors recalibration

## Dual Seal

Pressure-triggered safety valve for critical applications

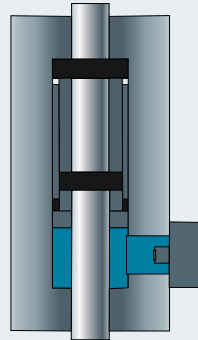

**100%**  
leakage  
detection

- Second process barrier for the case of thermowell failure/rupture
- Health monitoring & signal to PLC in case of activation
- Additional health information from measurement device
- Immediate sealing for containment of hazardous media

## QuickLink

Thermowell with patented design to control the process at peak efficiency and performance

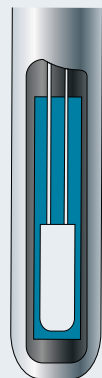

Up to  
**5x**  
faster response  
times

- Optimized thermal coupling between insert and thermowell
- Applicable with replaceable standard inserts  $\varnothing$  6 mm (0.25 inches)
- For temperatures up to +400 °C (+752 °F)

## iTHERM TwistWell

Barstock thermowell with helix design for high velocity applications

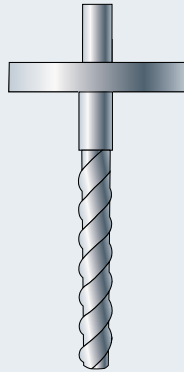

> 90%  
reduction  
of vortex  
induced  
vibrations

- Static loads can be calculated acc. ASME PTC 19.3 TW
- Easy installation for all nozzle sizes starting from 1"/DN25
- Effectiveness of the design verified by an independent 3rd party agency

## QuickSleeve

Insert for fast response times in combination with barstock thermowells

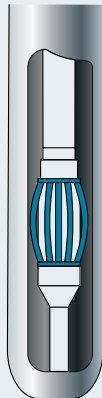

Up to  
2x  
faster  
response  
times

- Bridging the usual airgap between insert & barstock thermowells for optimized thermal coupling
- Suitable for bore  $\varnothing$  6,5 and 7 mm (0.26 inches)
- For temperatures up to +400 °C (+752 °F)

## iTHERM TrustSens TM371/TM372

Thermometer with innovative self-calibration technology for hygienic applications

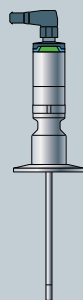

[Page 31](#)

## iTHERM SurfaceLine TM611

Non-invasive thermometer with highest accuracy for demanding applications

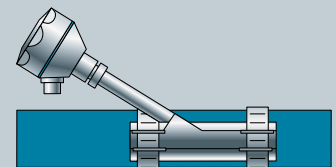

[Page 38-39](#)



# Quality assurance

## Extensive range of measurement and test equipment

- Microscopy, UT, endoscopy and X-ray are used for **optical testing of the quality of welded and soldered joints**.
- **Material and manufacturing quality** is verified by means of dye penetration testing, ultrasonic testing, helium leak testing, pressure endurance testing, insulation and vibration testing, along with a range of material testing techniques that are also non-destructive.
- **Determination of response times** of the inserts with and without a thermowell in flowing water in an appropriate test facility in accordance with VDI/VDE 3522 or IEC EN 60751.
- Using high-precision **x-ray equipment**, the tiniest details can be detected in thermometers without having to open or destroy them.

## Certificates

- **NACE (MR0175)**: Suitability test of materials for acid gas surroundings by approval test NACE standard MR0175 listed in the EN 10204 - 3.1.
- **Penetrant testing**: according to the EN ISO 3452 as well as the ASME V and ASME VIII guidelines.
- **X-ray test certificate**: for thermowell welding seams in accordance with EN ISO 17636 or ASME V – ASME VIII.
- **Thermowell calculation**: according to DIN 43772 or ASME PTC 19.3 using customer specific pressure, temperature and flow rate values.
- **Helium leak test**: tracer gas method according to EN ISO 20485 or ASTM E499/ASTM E498 - sealing tightness test.
- **Pressure test**: Thermowell internal and external pressure test according to PED (Pressure Equipment Directive) in Europe or CRN (Canadian Registration Number) in North- and Central America.
- **Testimonials in accordance with paragraph 3.1 EN 10204** regarding material compositions (if necessary with smelt composition), surface roughness and ferrite content.

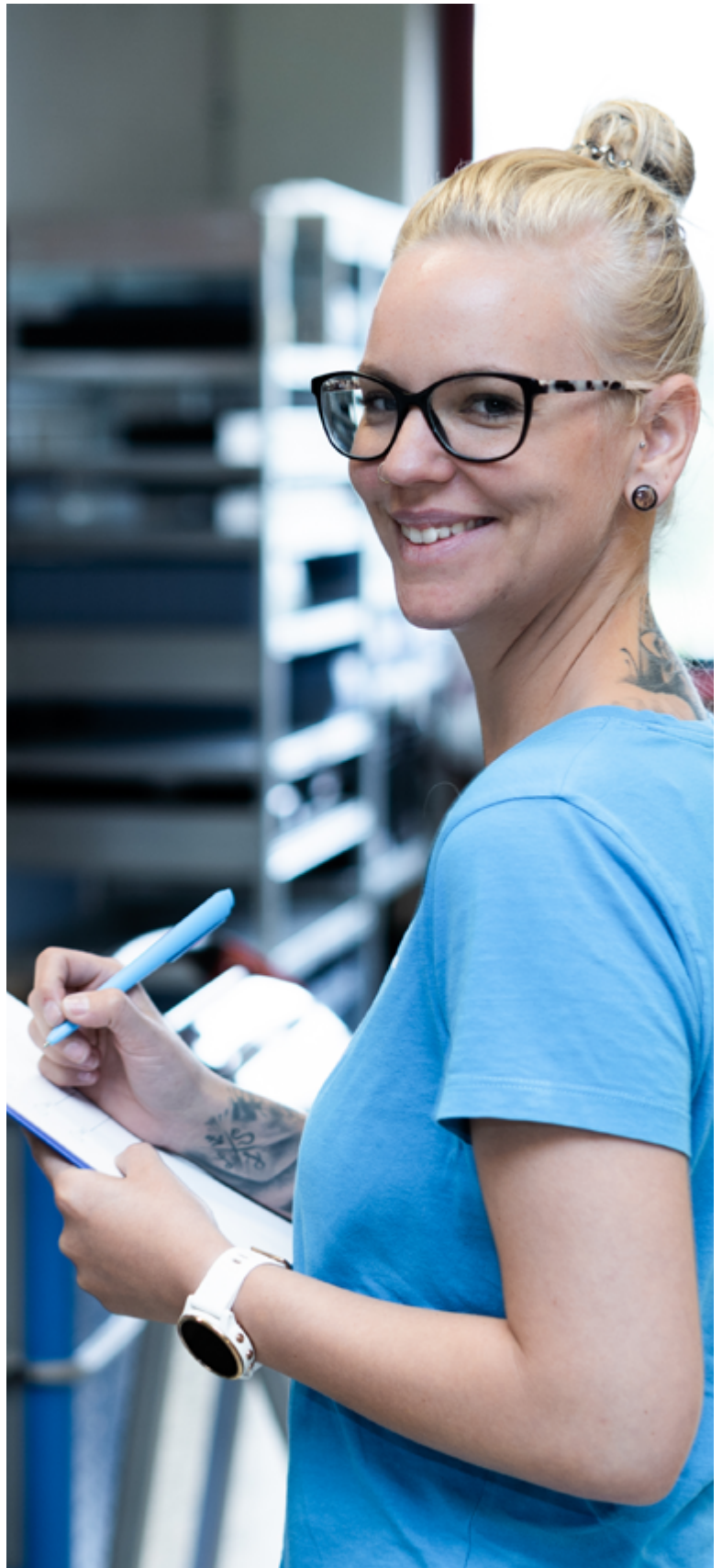

# Calibration services

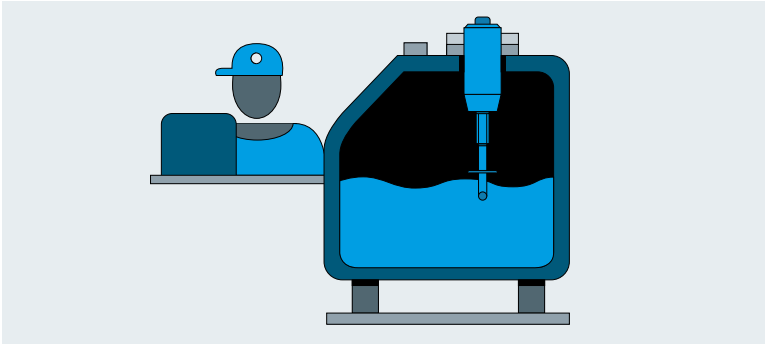

## Calibration competence at a glance

- Worldwide calibration facilities, some of them accredited to ISO/IEC 17025
- Calibration of thermometers to the lowest possible measurement uncertainty and traceable to national standards and the ITS90 international temperature scale



## Certificates

- **Detailed works calibration certificates** oriented to ISO 17025
- **Accredia-/DAkkS calibration certificates** with measurement results according to ISO 17025, calibrating uncertainties according to GUM or DIN V ENV 13005 and identification curve approximations like Callendar van Dusen coefficients



## Calibration methods

- **Fixed point calibration** at the water triple point cell (0.01 °C) and the ice point (0.0 °C/32 °F) with a measurement uncertainty of < 5 mK and at the nitrogen fixed point of 196 °C (384.8 °F).
- **Comparison calibration** of resistance thermometers and thermocouples with precision thermometers from -80 to +300 °C (-112 to +572 °F) in very homogenous and stable calibration baths (measurement uncertainty 20 to 100 mK) and up to 1500 °C (2732 °F) in calibration furnaces with a measurement uncertainty as defined and approved by the accreditation bodies.
- **High precision resistance measurements** (1 ppm accuracy) and thermo voltage measurements (sub- $\mu$ V accuracy).
- **Sensor-transmitter matching** for additional reduction of the thermometer measurement uncertainty.

## Netilion – the multi-brand ecosystem

Netilion is a cloud-based IIoT ecosystem, designed for industrial processes. It connects the physical and digital worlds to send valuable information from the field straight to your phone, tablet or other devices. Netilion empowers you to improve efficiency and drive innovation.



### Multi-brand ecosystem

You have equipment from various vendors in your installation. An IIoT solution should provide data from as many assets as possible, and Netilion can do that. This multi-brand ecosystem brings transparency into a plant regardless of device type or manufacturer.

### Security and privacy

Your facility's information is valuable and needs protection. Netilion allows users to access data digitally because it meets internationally recognized standards of cloud-platform security. It's a safe harbor for your data.

### Decentralized processes monitored efficiently

- Reduction of routine checkup tours through comprehensive visualization of essential process variables, e.g. flow quantities, limit values, levels, temperature, pressure or physicochemical quality parameters
- Low operating costs through fast reaction in case of failure

### Legal compliance thanks to automation

- Continuous measurement of quantitative and qualitative parameters
- Generation of legally compliant documentation thanks to integrated reporting systems

### Data access around the clock

- Complete data access independent of time and place
- Numerous options to analyze and visualize ratios, amounts, thresholds, time series and trends, as well as balances
- Everything at a glance thanks to the web-based visualization of networks with optimized depiction for highly diverse terminal devices



More about Netilion:  
[www.netilion.endress.com](http://www.netilion.endress.com)

**5. Data fusion and analysis**

Algorithms for leakage detection, verification, forecasts, etc.

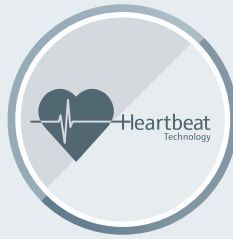

**4. Data management and visualization**

Monitoring of networks and decentralized infrastructures



**3. Data collection and transmission**

Flexible edge connectivity solutions



**2. Data collection and control**

Smart field devices and sensors (flow, analysis, pressure, level, temperature, etc.)

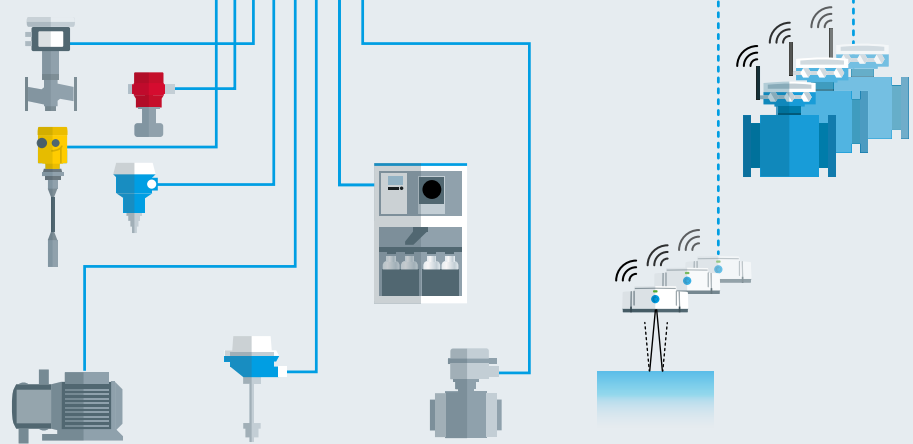

**1. Physical world**

Infrastructure (pipes, pumps, valves, etc.)

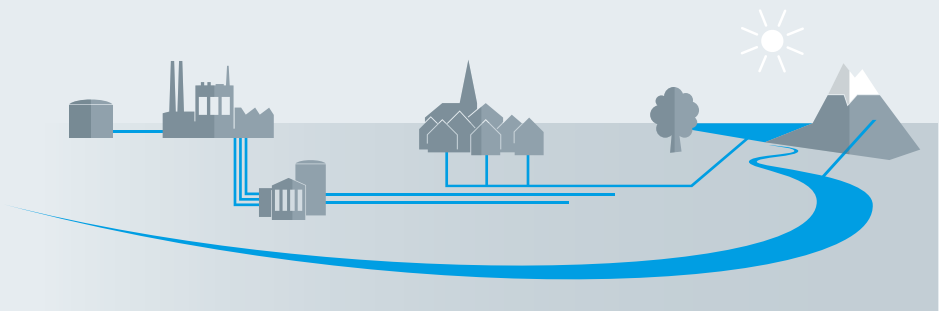



→ **Further information**

- Calibration of thermometers CP00004R
- Temperature Engineered Solutions CP00003
- System products and data managers FA00016K



Have you found “your” device?  
We would be pleased to send  
you further detailed technical  
information.

[www.addresses.endress.com](http://www.addresses.endress.com)

---